

UTENSILI E CORPI FRESA PER TORNITURA - FRESATURA - FORATURA

All'interno del catalogo troverete prodotti ISO e Taegutec, Iscar, Sumitomo, Korloy, ZCC, Seco, Sandvik, Walter, Vandurit, Safety, Lamina e Horn.

T System External Lathe Tool Holders
Т Тип Внешний токарный инструмент Держатели



02

P System External Lathe Tool Holders
П Тип Внешний токарный инструмент Держатели



06

C System External Lathe Tool Holders
С Тип Внешний токарный инструмент Держатели



08

M System External Lathe Tool Holders
М Тип Внешний токарный инструмент Держатели



09

S System External Lathe Tool Holders
S Тип Внешний токарный инструмент Держатели



10

S System External Lathe Tool Holders
S Тип Внешний токарный инструмент Держатели



16

T System Boring Bar
Т Тип борштангу



17

P System Boring Bar
П Тип борштангу



20

M System Boring Bar
М Тип борштангу



21

S System Boring Bars
S Тип борштангу



22

External Grooving Toolholders
Желобков Инструмент Держатели Внешний



27

Internal Grooving Toolholder
Держатели Внутренний желобков Инструмент



32

External and Internal Threading Toolholders
Внешние и инструменты внутренней резьбы Держатели



34

ENDMILLS
концевые фрезы



35

BALL NOSE ENDMILLS
Шаровые концевые фрезы носа



42

HIGH FEED END MILLS
High Feed End Mills



43

T System Milling
Т Тип Фрезерование



44

Disc Milling
Диск Фрезерование



45

S System Chamfering End Mills
S Тип инструменты фасок



46

S SYSTEM MODULAR ENDMILLS
S Тип инструменты Модулар



47

S System Helix end Mills
S System Helix end Mills



50

Adjustable Rough Boring Heads
Регулируемые Грубые расточные головки



51

фреза



52

сменные сверла



60

Via Stazione, 8a
30035 Mirano - VE
info@utilservicetools.it

T SYSTEM EXTERNAL LATHE TOOLS

PRODUCT ПРОДУКТ/продукт	CODE КОД/КОД	PRICE (EURO) ПРЕИС/цена
 <p>DNM.11/15 ISO</p>	TDJNR/L	
	1616 H11	40 €
	2020 K11	44 €
	2525 M11	47 €
	2020 K15	44 €
	2525 M15	47 €
	3232 P15	54 €
	4040 S15	81 €

PRODUCT ПРОДУКТ/продукт	CODE КОД/КОД	PRICE (EURO) ПРЕИС/цена
 <p>DNM.11/15 ISO</p>	TDNNN	
	1616 H11	40 €
	2020 K11	44 €
	2525 M11	47 €
	2020 K15	44 €
	2525 M15	47 €
	3232 P15	54 €
	4040 S15	81 €

PRODUCT ПРОДУКТ/продукт	CODE КОД/КОД	PRICE (EURO) ПРЕИС/цена
 <p>CNM.12/16/19 ISO</p>	TCLNR/L	
	2020 K12	44 €
	2525 M12	47 €
	3232 P12	54 €
	4040 S12	75 €
	2525 M16	52 €
	3232 P16	54 €
	4040 S16	84 €
	3232 P19	68 €
	4040 S19	84 €

PRODUCT ПРОДУКТ/продукт	CODE КОД/КОД	PRICE (EURO) ПРЕИС/цена
 <p>CNM.12/16/19 ISO</p>	TCMNN	
	1616 H12	42 €
	2020 K12	44 €
	2525 M12	47 €
	3232 P12	54 €
	2525 M16	52 €
	3232 P16	54 €
	4040 S16	84 €
	3232 P19	68 €
	4040 S19	84 €

T SYSTEM EXTERNAL LATHE TOOLS

PRODUCT ПРОДУКТ/продукт	CODE КОДЕ/КОД	PRICE (EURO) PREIS/цена
 <p>CNM.12/16/19 ISO</p>	TCZNN	
	2020 K12	44 €
	2525 M12	47 €
	3232 P12	54 €
	2525 M16	52 €
	3232 P16	54 €
	4040 S16	84 €
	3232 P19	68 €
4040 S19	84 €	

PRODUCT ПРОДУКТ/продукт	CODE КОДЕ/КОД	PRICE (EURO) PREIS/цена
 <p>WNM.0608 ISO</p>	TWLNRL	
	1616 H06	40 €
	2020 K06	44 €
	2525 M06	49 €
	2020 K08	44 €
	2525 M08	47 €
	3232 P08	54 €
	4040 S08	81 €

PRODUCT ПРОДУКТ/продукт	CODE КОДЕ/КОД	PRICE (EURO) PREIS/цена
 <p>SNM.12/15 ISO</p>	TSSNR/L	
	2020 K12	44 €
	2525 M12	47 €
	3232 P12	54 €
	2525 M15	47 €
	3232 P15	54 €
	4040 S15	81 €

PRODUCT ПРОДУКТ/продукт	CODE КОДЕ/КОД	PRICE (EURO) PREIS/цена
 <p>SNM.12/15 ISO</p>	TSDNN	
	2020 K12	44 €
	2525 M12	47 €
	3232 P12	54 €
	2525 M15	47 €
	3232 P15	54 €
	4040 S15	81 €



T SYSTEM EXTERNAL LATHE TOOLS

PRODUCT ПРОДУКТ/продукт	CODE КОД/КОД	PRICE (EURO) ПРЕИС/цена
 <p>TTJNR/L</p> <p>TTN.16/22 ISO</p>	2020 K16	44 €
	2525 M16	47 €
	3232 P16	54 €
	2525 M22	47 €
	3232 P22	54 €
	4040 S22	84 €

PRODUCT ПРОДУКТ/продукт	CODE КОД/КОД	PRICE (EURO) ПРЕИС/цена
 <p>TTENN</p> <p>TTN.16/22 ISO</p>	2020 K16	44 €
	2525 M16	47 €
	3232 P16	54 €
	2525 M22	47 €
	3232 P22	54 €
	4040 S22	84 €

PRODUCT ПРОДУКТ/продукт	CODE КОД/КОД	PRICE (EURO) ПРЕИС/цена
 <p>TVJNR/L</p> <p>VNM.16 ISO</p>	2020 K16	44 €
	2525 M16	47 €
	3232 P16	57 €
	4040 S16	84 €

PRODUCT ПРОДУКТ/продукт	CODE КОД/КОД	PRICE (EURO) ПРЕИС/цена
 <p>TVVNN</p> <p>VNM.16 ISO</p>	2020 K16	44 €
	2525 M16	47 €
	3232 P16	54 €
	4040 S16	84 €

T SYSTEM EXTERNAL LATHE TOOLS

PRODUCT PRODUKT/продукт	CODE CODE/КОД	PRICE (EURO) PREIS/цена
 <p>SNM.12/15 ISO</p>	TSKNR/L	
	2020 K12	44 €
	2525 M12	47 €
	2525 M15	48 €
	3232 P12	54 €
	3232 P15	56 €

PRODUCT PRODUKT/продукт	CODE CODE/КОД	PRICE (EURO) PREIS/цена
 <p>VNM.16 ISO</p>	TVHNR/L	
	2020 K16	44 €
	2525 M16	47 €
	3232 P16	54 €

PRODUCT PRODUKT/продукт	CODE CODE/КОД	PRICE (EURO) PREIS/цена
 <p>DNM.15 ISO</p>	TDHNR/L	
	2525 M15	47 €
	3232 P15	54 €



P System External Lathe Tool Holders



PRODUCT PRODUKT/продукт	CODE CODE/КОД	PRICE (EURO) PREIS/цена
 <p>DNM.15 ISO</p>	PDNR/L	
	2020 K15	44 €
	2525 M15	47 €
	3232 P15	54 €
	4040 S15	84 €

PRODUCT PRODUKT/продукт	CODE CODE/КОД	PRICE (EURO) PREIS/цена
 <p>DNM.15 ISO</p>	PDNNN	
	2020 K15	44 €
	2525 M15	47 €
	3232 P15	54 €

PRODUCT PRODUKT/продукт	CODE CODE/КОД	PRICE (EURO) PREIS/цена
 <p>WNM.08 ISO</p>	PWLNR/L	
	2020 K08	44 €
	2525 M08	47 €
	3232 P08	54 €
	4040 S08	84 €

PRODUCT PRODUKT/продукт	CODE CODE/КОД	PRICE (EURO) PREIS/цена
 <p>CNM.12/16/19 ISO</p>	PCLNR/L	
	2020 K12	44 €
	2525 M12	47 €
	3232 P12	54 €
	2525 M16	58 €
	3232 P16	64 €
	3232 P19	69 €
	4040 S19	86 €

PRODUCT PRODUKT/продукт	CODE CODE/КОД	PRICE (EURO) PREIS/цена
 <p>CNM.12/16/19 ISO</p>	PCMNN	
	2020 K12	44 €
	2525 M12	47 €
	3232 P12	54 €
	2525 M16	48 €
	3232 P16	64 €
3232 P19	69 €	

P System External Lathe Tool Holders

PRODUCT PRODUKT/продукт	CODE CODE/КОД	PRICE (EURO) PREIS/цена
 <p>SNM.12/15 ISO</p>	PSSNR/L	
	2020 K12	44 €
	2525 M12	47 €
	3232 P12	54 €
	3232 P15	64 €

PRODUCT PRODUKT/продукт	CODE CODE/КОД	PRICE (EURO) PREIS/цена
 <p>SNM.12/15 ISO</p>	PSDNN	
	2020 K12	44 €
	2525 M12	47 €
	3232 P12	54 €
	2525 M15	48 €
3232 P15	64 €	

PRODUCT PRODUKT/продукт	CODE CODE/КОД	PRICE (EURO) PREIS/цена
 <p>SNM.12/15 ISO</p>	PSKNR/L	
	2020 K12	44 €
	2525 M12	47 €
	3232 P12	54 €
	2525 M15	48 €
3232 P15	64 €	

PRODUCT PRODUKT/продукт	CODE CODE/КОД	PRICE (EURO) PREIS/цена
 <p>SNM.12 ISO</p>	PSBNR/L	
	2525 M12	47 €
	3232 P12	54 €

PRODUCT PRODUKT/продукт	CODE CODE/КОД	PRICE (EURO) PREIS/цена
 <p>CNM.12 ISO</p>	PCBNR/L	
	2525 M12	47 €
	3232 P12	54 €

M System External Lathe Tool Holders



PRODUCT PRODUKT/продукт	CODE CODE/КОД	PRICE (EURO) PREIS/цена
 <p>DNM.15 ISO</p>	CDJNR/L	
	2525 M15	52 €
	3232 P12	57 €

PRODUCT PRODUKT/продукт	CODE CODE/КОД	PRICE (EURO) PREIS/цена
 <p>SNM.12 ISO</p>	CSSNR/L	
	2525 M12	52 €
	3232 P12	57 €

PRODUCT PRODUKT/продукт	CODE CODE/КОД	PRICE (EURO) PREIS/цена
 <p>SNM.12 ISO</p>	CSDNN	
	2525 M12	52 €
	3232 P12	57 €

PRODUCT PRODUKT/продукт	CODE CODE/КОД	PRICE (EURO) PREIS/цена
 <p>TNM.16 ISO</p>	CTJNR/L	
	2525 M16	52 €
	3232 P16	57 €

PRODUCT PRODUKT/продукт	CODE CODE/КОД	PRICE (EURO) PREIS/цена
 <p>KNUX.16 ISO</p>	CKJNR/L	
	2020 K16	37 €
	2525 M16	40 €
	3232 P16	47 €
	4040 S16	60 €

M System External Lathe Tool Holders

PRODUCT PRODUKT/продукт	CODE CODE/КОД	PRICE (EURO) PREIS/цена
 <p>TNM.16/22 ISO</p>	MTJNR/L	
	2020 K16	44 €
	2525 M16	47 €
	3232 P16	54 €
	2525 M22	47 €
	3232 P22	54 €
	4040 S22	86 €

PRODUCT PRODUKT/продукт	CODE CODE/КОД	PRICE (EURO) PREIS/цена
 <p>TNM.16/22 ISO</p>	MTENN	
	2020 K16	44 €
	2525 M16	47 €
	3232 P16	54 €
	2525 M22	47 €
	3232 P22	54 €
	4040 S22	86 €

PRODUCT PRODUKT/продукт	CODE CODE/КОД	PRICE (EURO) PREIS/цена
 <p>WNM.06/08 ISO</p>	MWLNR/L	
	1616 H06*	40 €
	2020 K06*	42 €
	2525 M06*	47 €
	2020 K08	44 €
	2525 M08	47 €
	3232 P08	54 €
	4040 S08	86 €

PRODUCT PRODUKT/продукт	CODE CODE/КОД	PRICE (EURO) PREIS/цена
 <p>WNM.06/08 ISO</p>	MWDNN	
	1616 H06*	40 €
	2020 K06*	42 €
	2525 M06*	47 €
	2020 K08	44 €
	2525 M08	47 €
	3232 P08	54 €
	4040 S08	86 €

S System External Lathe Tool Holders

PRODUCT ПРОДУКТ/продукт	CODE CODE/КОД	PRICE (EURO) PREIS/цена
 <p>DCM.07/11 ISO</p>	SDJCR/L	
	0808 E07	23 €
	1010 E07	23 €
	1212 F07	27 €
	1616 H07	30 €
	1616 H11	32 €
	2020 K11	33 €
	2525 M11	35 €
	3232 P11	42 €

PRODUCT ПРОДУКТ/продукт	CODE CODE/КОД	PRICE (EURO) PREIS/цена
 <p>DCM.07/11 ISO</p>	SDNCN	
	0808 E07	23 €
	1010 E07	23 €
	1212 F07	27 €
	1616 H07	30 €
	1616 H11	32 €
	2020 K11	33 €
	2525 M11	35 €
	3232 P11	42 €

PRODUCT ПРОДУКТ/продукт	CODE CODE/КОД	PRICE (EURO) PREIS/цена
 <p>DCM.07/11 ISO</p>	SDHCR/L	
	0808 E07	23 €
	1010 E07	23 €
	1212 F07	27 €
	1616 H07	30 €
	1616 H11	32 €
	2020 K11	33 €
	2525 M11	35 €
	3232 P11	42 €

PRODUCT ПРОДУКТ/продукт	CODE CODE/КОД	PRICE (EURO) PREIS/цена
 <p>SCM.09/12 ISO</p>	SSSCR/L	
	1212 F09	27 €
	1616H09	32 €
	2020K09	33 €
	2525 M09	35 €
	1616 H12	32 €
	2020 K12	33 €
	2525 M12	35 €

S System External Lathe Tool Holders

PRODUCT ПРОДУКТ/продукт	CODE CODE/КОД	PRICE (EURO) PREIS/цена
 <p>SCM.09/12 ISO</p>	SSDCN	
	1212 F09	27 €
	1616 H09	30 €
	2020 K09	33 €
	2525 M09	35 €
	1616 H12	32 €
	2020 K12	33 €
	2525 M12	35 €

PRODUCT ПРОДУКТ/продукт	CODE CODE/КОД	PRICE (EURO) PREIS/цена
 <p>CCM.09/12 ISO</p>	SCLCR/L	
	0808 E06	23 €
	1010 E06	23 €
	1212 F09	27 €
	1616 H09	32 €
	2020 K09	33 €
	2525 M09	35 €
	2020 K12	33 €
	2525 M12	35 €

PRODUCT ПРОДУКТ/продукт	CODE CODE/КОД	PRICE (EURO) PREIS/цена
 <p>CCM.09/12 ISO</p>	SCMCN	
	0808 E06	23 €
	1010 E06	23 €
	1212 F09	27 €
	1616 H09	32 €
	2020 K09	33 €
	2525 M09	35 €
	2020 K12	33 €
	2525 M12	35 €

PRODUCT ПРОДУКТ/продукт	CODE CODE/КОД	PRICE (EURO) PREIS/цена
 <p>CCM.09/12 ISO</p>	SCACR/L	
	0808 E06	23 €
	1010 E06	23 €
	1212 F09	27 €
	1616 H09	32 €
	2020 K09	33 €
	2525 M09	35 €
	2020 K12	33 €
	2525 M12	35 €

S System External Lathe Tool Holders

PRODUCT PRODUKT/продукт	CODE CODE/КОД	PRICE (EURO) PREIS/цена
 <p>SVJBR/L</p> <p>VBM.11/16 ISO</p>	1212 F11	27 €
	1616 H11	30 €
	2020 K11	33 €
	2525 M11	34 €
	1616 H16	33 €
	2020 K16	33 €
	2525 M16	34 €
	3232 P16	42 €

PRODUCT PRODUKT/продукт	CODE CODE/КОД	PRICE (EURO) PREIS/цена
 <p>SVVBN</p> <p>VBM.11/16 ISO</p>	1616 H11	30 €
	2020 K11	33 €
	2525 M11	34 €
	1616 H16	33 €
	2020 K16	33 €
	2525 M16	34 €
	3232 P16	42 €

PRODUCT PRODUKT/продукт	CODE CODE/КОД	PRICE (EURO) PREIS/цена
 <p>SVHBR/L</p> <p>VBM.11/16 ISO</p>	1616 H11	30 €
	2020 K11	33 €
	2525 M11	34 €
	1616 H16	33 €
	2020 K16	33 €
	2525 M16	34 €
	3232 P16	42 €

PRODUCT PRODUKT/продукт	CODE CODE/КОД	PRICE (EURO) PREIS/цена
 <p>SVZBR/L</p> <p>VBM.11/16 ISO</p>	1616 H11	30 €
	2020 K11	33 €
	2525 M11	34 €
	1616 H16	33 €
	2020 K16	33 €
	2525 M16	34 €
	3232 P16	42 €

S System External Lathe Tool Holders

PRODUCT ПРОДУКТ/продукт	CODE КОДЕ/КОД	PRICE (EURO) PREIS/цена
 <p>TCM.09/11/16 ISO</p>	STJCR/L	
	0808 E09	23 €
	1010 E09	23 €
	1212 F11	27 €
	1616 H11	30 €
	1616 H16	31 €
	2020 K16	33 €
	2525 M16	34 €
	3232 P16	42 €

PRODUCT ПРОДУКТ/продукт	CODE КОДЕ/КОД	PRICE (EURO) PREIS/цена
 <p>TCM.09/11/16 ISO</p>	STGCR/L	
	0808 E09	23 €
	1010 E09	23 €
	1212 F11	27 €
	1616 H11	30 €
	1616 H16	31 €
	2020 K16	33 €
	2525 M16	34 €
	3232 P16	42 €

PRODUCT ПРОДУКТ/продукт	CODE КОДЕ/КОД	PRICE (EURO) PREIS/цена
 <p>TCM.09/11/16 ISO</p>	STFCR/L	
	0808 E09	23 €
	1010 E09	23 €
	1212 F11	27 €
	1616 H11	30 €
	1616 H16	31 €
	2020 K16	33 €
	2525 M16	34 €
	3232 P16	42 €

S System External Lathe Tool Holders

PRODUCT PRODUKT/продукт	CODE КОДЕ/КОД	PRICE (EURO) PREIS/цена
 <p style="text-align: center;">RCM.08/10/12/16/20 ISO</p>	SRDCN	
	1616 H06	31 €
	2020 K06	33 €
	2525 M06	35 €
	1616 H08	31 €
	2020 K08	33 €
	2525 M08	35 €
	3232 P08	42 €
	1616 H10	31 €
	2020 K10	33 €
	2525 M10	35 €
	3232 P10	42 €
	2020 K12	33 €
	2525 M12	35 €
	3232 P12	42 €
	2525 M16	35 €
	3232 P16	42 €
	2525 M20	35 €
	3232 P20	42 €
	4040 S20	67 €

PRODUCT PRODUKT/продукт	CODE КОДЕ/КОД	PRICE (EURO) PREIS/цена
 <p style="text-align: center;">RCM.08/10/12/16/20 ISO</p>	SRGCR/L	
	1616 H06	31 €
	2020 K06	33 €
	2525 M06	35 €
	1616 H08	31 €
	2020 K08	33 €
	2525 M08	35 €
	3232 P08	42 €
	1616 H10	31 €
	2020 K10	33 €
	2525 M10	35 €
	3232 P10	42 €
	2020 K12	33 €
	2525 M12	35 €
	3232 P12	42 €
	2525 M16	35 €
	3232 P16	42 €
	2525 M20	35 €
	3232 P20	42 €

S System External Lathe Tool Holders

PRODUCT ПРОДУКТ/продукт	CODE КОДЕ/КОД	PRICE (EURO) PREIS/цена
 <p>RCM.10/12/16 ISO</p>	SRHCR/L	
	2020 K10	62 €
	2525 M10	62 €
	2020 K12	62 €
	2525 M12	62 €
	2020 K16	62 €
	2525 M16	62 €

PRODUCT ПРОДУКТ/продукт	CODE КОДЕ/КОД	PRICE (EURO) PREIS/цена
 <p>VCM.11/16 ISO</p>	SVJCR/L	
	1616 H11	30 €
	2020 K11	33 €
	2020 K16	33 €
	2525 M16	35 €
	3232 P16	42 €

PRODUCT ПРОДУКТ/продукт	CODE КОДЕ/КОД	PRICE (EURO) PREIS/цена
 <p>VCM.11/16 ISO</p>	SVHCR/L	
	1616 H11	30 €
	2020 K11	33 €
	2020 K16	33 €
	2525 M16	35 €
	3232 P16	42 €



S System Swiss Type Tool Holders

PRODUCT PRODUKT/продукт	CODE CODE/КОД	PRICE (EURO) PREIS/цена
 <p style="text-align: center;">CCM.06/09 ISO</p>	SCLCR/L-K.0	
	1010 K06	30 €
	1212 G06	30 €
	1212 K06	35 €
	1616 F06	30 €
	1616 K06	35 €
	1212 G09	30 €
	1212 K09	35 €
	1616 F09	30 €
	1616 K09	35 €
	2020 K09	37 €

PRODUCT PRODUKT/продукт	CODE CODE/КОД	PRICE (EURO) PREIS/цена
 <p style="text-align: center;">DCM.07/11 ISO</p>	SDJCR/L-K.0	
	1010 K07	30 €
	1212 G07	30 €
	1212 K07	35 €
	1616 F07	30 €
	1616 K07	35 €
	2020 K07	37 €
	1212 G11	30 €
	1212 K11	35 €
	1616 F11	30 €
	1616 K11	35 €
2020 K11	37 €	

PRODUCT PRODUKT/продукт	CODE CODE/КОД	PRICE (EURO) PREIS/цена
 <p style="text-align: center;">VBM.11 ISO</p>	SVJBR/L-K.0	
	1010 K11	35 €
	1212 G11	30 €
	1212 K11	35 €
	1616 F11	30 €
	1616 K11	35 €
2020 K11	37 €	

T System Boring Bars

PRODUCT PRODUKT/продукт	CODE CODE/КОД	PRICE (EURO) PREIS/цена
 <p>WNLNR/L ISO</p>	TWLNRL	
	S25S TWLNRL-06	50 €
	S32T TWLNRL-06	66 €
	S25S TWLNRL-08	53 €
	S32T TWLNRL-08	67 €
	S40U TWLNRL-08	85 €
	S50V TWLNRL-08	104 €

PRODUCT PRODUKT/продукт	CODE CODE/КОД	PRICE (EURO) PREIS/цена
 <p>TDUNRL ISO</p>	TDUNRL	
	S25S TDUNRL-11	50 €
	S32T TDUNRL-11	66 €
	S25S TDUNRL-15	53 €
	S32T TDUNRL-15	67 €
	S40U TDUNRL-15	85 €
	S50V TDUNRL-15	104 €

PRODUCT PRODUKT/продукт	CODE CODE/КОД	PRICE (EURO) PREIS/цена
 <p>TDQNR/L ISO</p>	TDQNR/L	
	S25S TDQNR/L-11	50 €
	S32T TDQNR/L-11	66 €
	S25S TDQNR/L-15	53 €
	S32T TDQNR/L-15	67 €
	S40U TDQNR/L-15	85 €
	S50V TDQNR/L-15	104 €

PRODUCT PRODUKT/продукт	CODE CODE/КОД	PRICE (EURO) PREIS/цена
 <p>TD-NR/L ISO</p>	TD-NR/L	
	S25S TD-NR/L-11	50 €
	S32T TD-NR/L-15	66 €
	S40U TD-NR/L-15	85 €
	S50V TD-NR/L-15	104 €

T System Boring Bars

PRODUCT ПРОДУКТ/продукт	CODE КОДЕ/КОД	PRICE (EURO) PREIS/цена
 <p>CNM.12/16/19 ISO</p>	TCLNR/L	
	S25S TCLNR/L-12	52 €
	S32T TCLNR/L-12	65 €
	S40U TCLNR/L-12	85 €
	S50V TCLNR/L-12	104 €
	S32T TCLNR/L-16	70 €
	S40U TCLNR/L-16	95 €
S50V TCLNR/L-16	116 €	

PRODUCT ПРОДУКТ/продукт	CODE КОДЕ/КОД	PRICE (EURO) PREIS/цена
 <p>SNM.12 ISO</p>	TSKNR/L	
	S25S TSKNR/L-12	52 €
	S32T TSKNR/L-12	65 €
	S40U TSKNR/L-12	85 €
	S50V TSKNR/L-12	104 €

PRODUCT ПРОДУКТ/продукт	CODE КОДЕ/КОД	PRICE (EURO) PREIS/цена
 <p>TNM.16/22 ISO</p>	TTUNR/L	
	S25S TTUNR/L-16	53 €
	S32T TTUNR/L-16	67 €
	S32T TTUNR/L-22	67 €
	S40U TTUNR/L-22	85 €
	S50V TTUNR/L-22	104 €

PRODUCT ПРОДУКТ/продукт	CODE КОДЕ/КОД	PRICE (EURO) PREIS/цена
 <p>TNM.16 ISO</p>	TT-NR/L	
	S25S TT-NR/L-16	53 €
	S32T TT-NR/L-16	67 €

T System Boring Bars

PRODUCT ПРОДУКТ/продукт	CODE КОД/КОД	PRICE (EURO) PREIS/цена
 <p>VNM.16 ISO</p>	TVUNR/L	
	S25S TVUNR/L-16	53 €
	S32T TVUNR/L-16	67 €
	S40U TVUNR/L-16	85 €

PRODUCT ПРОДУКТ/продукт	CODE КОД/КОД	PRICE (EURO) PREIS/цена
 <p>KNUX.16 ISO</p>	CKUNR/L	
	S25S CKUNR/L-16	39 €
	S28S CKUNR/L-16	42 €
	S32T CKUNR/L-16	54 €
	S40U CKUNR/L-16	82 €
	S50V CKUNR/L-16	100 €

P System Boring Bars

PRODUCT PRODUKT/продукт	CODE CODE/КОД	PRICE (EURO) PREIS/цена
 DNM.11/15 ISO	PDUNR/L	
	S32T PDUNR/L-15	67 €
	S40U PDUNR/L-15	88 €

PRODUCT PRODUKT/продукт	CODE CODE/КОД	PRICE (EURO) PREIS/цена
 DNM.11/15 ISO	PDQNR/L	
	S32T PDQNR/L-15	67 €
	S40U PDQNR/L-15	88 €

PRODUCT PRODUKT/продукт	CODE CODE/КОД	PRICE (EURO) PREIS/цена
 CNM.12/16/19 ISO	PCLNR/L	
	S25S PCLNR/L-12	53 €
	S32T PCLNR/L-12	67 €
	S40U PCLNR/L-12	88 €
	S32T PCLNR/L-16	70 €
	S40U PCLNR/L-16	98 €

PRODUCT PRODUKT/продукт	CODE CODE/КОД	PRICE (EURO) PREIS/цена
 WNM.0608 ISO	PWLNR/L	
	S25S PWLNR/L-08	53 €
	S32T PWLNR/L-08	67 €
	S40U PWLNR/L-08	88 €

PRODUCT PRODUKT/продукт	CODE CODE/КОД	PRICE (EURO) PREIS/цена
 SNM.12/15 ISO	PSKNR/L	
	S25S PSKNR/L-12	53 €
	S32T PSKNR/L-12	67 €
	S40U PSKNR/L-12	88 €
	S32T PSKNR/L-15	70 €
	S40U PSKNR/L-15	98 €

M System Boring Bars

PRODUCT ПРОДУКТ/продукт	CODE КОД/КОД	PRICE (EURO) PREIS/цена
 <p>TNM.16/22 ISO</p>	MTUNR/L	
	S20R MTUNR/L-16	47 €
	S25S MTUNR/L-16	53 €
	S32T MTUNR/L-16	67 €
	S40U MTUNR/L-16	85 €
	S32T MTUNR/L-22	67 €
	S40U MTUNR/L-22	85 €
	S50V MTUNR/L-22	104 €

PRODUCT ПРОДУКТ/продукт	CODE КОД/КОД	PRICE (EURO) PREIS/цена
 <p>TNM.16/22 ISO</p>	MTQNR/L	
	S20R MTQNR/L-16	47 €
	S25S MTQNR/L-16	53 €
	S32T MTQNR/L-16	67 €
	S40U MTQNR/L-16	85 €
	S32T MTQNR/L-22	67 €
	S40U MTQNR/L-22	85 €
	S50V MTQNR/L-22	104 €

PRODUCT ПРОДУКТ/продукт	CODE КОД/КОД	PRICE (EURO) PREIS/цена
 <p>TNM.16/22 ISO</p>	MT-NR/L	
	S25S MT-NR-16	53 €
	S32T MT-NR-16	67 €
	S40U MT-NR-16	85 €
	S32T MT-NR-22	67 €
	S40U MT-NR-22	85 €
	S50V MT-NR-22	104 €

PRODUCT ПРОДУКТ/продукт	CODE КОД/КОД	PRICE (EURO) PREIS/цена
 <p>WNM.0608 ISO</p>	MWLNR/L	
	S16P MWLNR/L-06	42 €
	S20R MWLNR/L-06	47 €
	S25S MWLNR/L-06	53 €
	S25S MWLNR/L-08	53 €
	S32T MWLNR/L-08	67 €
	S40U MWLNR/L-08	85 €
	S50V MWLNR/L-08	104 €

S System Boring Bars



PRODUCT PRODUKT/продукт	CODE КОД/КОД	PRICE (EURO) ПРЕИС/цена
 <p style="text-align: center;">DCM.07/11 ISO</p>	SDUCR/L	
	S10K SDUCR/L-07	21 €
	S12K SDUCR/L-07	22 €
	S16P SDUCR/L-07	27 €
	S16P SDUCR/L-11	27 €
	S20R SDUCR/L-11	28 €
	S25S SDUCR/L-11	33 €
	S32T SDUCR/L-11	53 €
	S40U SDUCR/L-11	64 €
	S10K 16X10 SDUCR/L-07	30 €
	S12K 16X12 SDUCR/L-07	30 €

PRODUCT PRODUKT/продукт	CODE КОД/КОД	PRICE (EURO) ПРЕИС/цена
 <p style="text-align: center;">DCM.07/11 ISO</p>	SDQCR/L	
	S10K SDQCR/L-07	21 €
	S12K SDQCR/L-07	22 €
	S16P SDQCR/L-07	27 €
	S16P SDQCR/L-11	27 €
	S20R SDQCR/L-11	28 €
	S25S SDQCR/L-11	33 €
	S32T SDQCR/L-11	53 €
	S40U SDQCR/L-11	64 €
	S10K 16X10 SDQCR/L-07	30 €
	S12K 16X12 SDQCR/L-07	30 €

PRODUCT PRODUKT/продукт	CODE КОД/КОД	PRICE (EURO) ПРЕИС/цена
 <p style="text-align: center;">DCM.07/11 ISO</p>	SD-CR/L	
	S12K SD-CR/L-07	22 €
	S16P SD-CR/L-11	27 €
	S20R SD-CR/L-11	28 €
	S25S SD-CR/L-11	33 €
	S32T SD-CR/L-11	53 €
	S40U SD-CR/L-11	64 €
	S12K 16X12 SD-CR/L-07	30 €

PRODUCT PRODUKT/продукт	CODE КОД/КОД	PRICE (EURO) ПРЕИС/цена
 <p style="text-align: center;">DCM.07/11 ISO</p>	SDPCR/L	
	S10K SDPCR/L-07	21 €
	S12K SDPCR/L-07	22 €
	S16P SDPCR/L-11	27 €
	S20R SDPCR/L-11	28 €
	S25S SDPCR/L-11	33 €
	S32T SDPCR/L-11	53 €
	S40U SDPCR/L-11	64 €

S System Boring Bars

PRODUCT PRODUKT/продукт	CODE CODE/КОД	PRICE (EURO) PREIS/цена
 <p>DCM.07/11 ISO</p>	SDXCR/L	
	S12K SDXCR/L-07	22 €
	S16P SDXCR/L-11	27 €
	S20R SDXCR/L-11	28 €
	S25S SDXCR/L-11	33 €
	S32T SDXCR/L-11	53 €
	S40U SDXCR/L-11	64 €

PRODUCT PRODUKT/продукт	CODE CODE/КОД	PRICE (EURO) PREIS/цена
 <p>WCM.03 ISO</p>	SWLCR/L	
	S0608H SWLCR/L-03	21 €
	S0810K SWLCR/L-03	23 €

PRODUCT PRODUKT/продукт	CODE CODE/КОД	PRICE (EURO) PREIS/цена
 <p>CCM.09/12 ISO</p>	SCLCR/L	
	S0608H SCLCR/L-06	21 €
	S08H SCLCR/L-06	21 €
	S10K SCLCR/L-06	21 €
	S12K SCLCR/L-06	22 €
	S10X16P SCLCR/L-06	27 €
	S12X16P SCLCR/L-06	27 €
	S16P SCLCR/L-09	27 €
	S20R SCLCR/L-09	28 €
	S25S SCLCR/L-09	33 €
	S32T SCLCR/L-09	53 €
	S32T SCLCR/L-12	53 €
	S40U SCLCR/L-12	64 €

PRODUCT PRODUKT/продукт	CODE CODE/КОД	PRICE (EURO) PREIS/цена
 <p>CCM.09/12 ISO</p>	SCFCR/L	
	S08H SCFCR/L-06	21 €
	S10K SCFCR/L-06	21 €
	S12K SCFCR/L-06	22 €
	S16P SCFCR/L-09	27 €
	S20R SCFCR/L-09	28 €
	S25S SCFCR/L-09	33 €
	S25S SCFCR/L-12	33 €
	S32T SCFCR/L-12	53 €
	S40U SCFCR/L-12	64 €



S System Boring Bars



PRODUCT PRODUKT/продукт	CODE CODE/КОД	PRICE (EURO) PREIS/цена
 <p style="text-align: center;">SCM.09/12 ISO</p>	SSSCR/L	
	S16P SSSCR/L-09	27 €
	S20R SSSCR/L-09	28 €
	S25S SSSCR/L-09	33 €
	S32T SSSCR/L-12	53 €
	S40U SSSCR/L-12	64 €

PRODUCT PRODUKT/продукт	CODE CODE/КОД	PRICE (EURO) PREIS/цена
 <p style="text-align: center;">VBM.11/16 ISO</p>	SVUBR/L	
	S16P SVUBR/L-11	30 €
	S20R SVUBR/L-11	36 €
	S25S SVUBR/L-16	38 €
	S32T SVUBR/L-16	53 €
	S40U SVUBR/L-16	64 €

PRODUCT PRODUKT/продукт	CODE CODE/КОД	PRICE (EURO) PREIS/цена
 <p style="text-align: center;">VBM.11/16 ISO</p>	SVXBR/L	
	S16P SVXBR/L-11	30 €
	S20R SVXBR/L-11	36 €
	S25S SVXBR/L-16	38 €
	S32T SVXBR/L-16	53 €
	S40U SVXBR/L-16	64 €

PRODUCT PRODUKT/продукт	CODE CODE/КОД	PRICE (EURO) PREIS/цена
 <p style="text-align: center;">VBM.11/16 ISO</p>	SVQBR/L	
	S16P SVQBR/L-11	30 €
	S20R SVQBR/L-11	36 €
	S25S SVQBR/L-16	38 €
	S32T SVQBR/L-16	53 €
	S40U SVQBR/L-16	64 €

S System Boring Bars

PRODUCT PRODUKT/продукт	CODE CODE/КОД	PRICE (EURO) PREIS/цена
 <p>VBM.16 ISO</p>	SVJBR/L	
	S25S SVJBR/L-16	38 €
	S32T SVJBR/L-16	53 €
	S40U SVJBR/L-16	64 €

PRODUCT PRODUKT/продукт	CODE CODE/КОД	PRICE (EURO) PREIS/цена
 <p>VCM.11/16 ISO</p>	SVUCR/L	
	S16P SVUCR/L-11	30 €
	S20R SVUCR/L-11	36 €
	S25S SVUCR/L-16	41 €
	S32T SVUCR/L-16	53 €
	S40U SVUCR/L-16	67 €

PRODUCT PRODUKT/продукт	CODE CODE/КОД	PRICE (EURO) PREIS/цена
 <p>VCM.11/16 ISO</p>	SVQCR/L	
	S16P SVQCR/L-11	30 €
	S20R SVQCR/L-11	36 €
	S25S SVQCR/L-16	41 €
	S32T SVQCR/L-16	53 €
	S40U SVQCR/L-16	67 €



S System Boring Bars



PRODUCT PRODUKT/продукт	CODE CODE/КОД	PRICE (EURO) PREIS/цена
 TCM.09/11/16 ISO	STUCR/L	
	S10K STUCR/L-09	21 €
	S12K STUCR/L-09	22 €
	S10K STUCR/L-11	21 €
	S12K STUCR/L-11	22 €
	S16P STUCR/L-11	27 €
	S20R STUCR/L-11	27 €
	S16P STUCR/L-16	27 €
	S20R STUCR/L-16	27 €
	S25S STUCR/L-16	33 €
	S32T STUCR/L-16	53 €
	S40U STUCR/L-16	64 €

PRODUCT PRODUKT/продукт	CODE CODE/КОД	PRICE (EURO) PREIS/цена
 TCM.06/09/11/16 ISO	STFCR/L	
	S0610F STFCR/L-06	21 €
	S10K STFCR/L-09	21 €
	S12K STFCR/L-09	22 €
	S10K STFCR/L-11	21 €
	S12K STFCR/L-11	22 €
	S16P STFCR/L-11	27 €
	S20R STFCR/L-11	27 €
	S16P STFCR/L-16	27 €
	S20R STFCR/L-16	27 €
	S25S STFCR/L-16	33 €
	S32T STFCR/L-16	53 €
S40U STFCR/L-16	64 €	

PRODUCT PRODUKT/продукт	CODE CODE/КОД	PRICE (EURO) PREIS/цена
 TCM.09/11/16 ISO	ST-CR/L	
	S12K ST-CR/L-09	22 €
	S12K ST-CR/L-11	22 €
	S16P ST-CR/L-11	27 €
	S20R ST-CR/L-11	27 €
	S16P ST-CR/L-16	27 €
	S20R ST-CR/L-16	27 €
	S25S ST-CR/L-16	33 €
	S32T ST-CR/L-16	53 €
S40U ST-CR/L-16	64 €	

External Grooving Toolholders

PRODUCT ПРОДУКТ/продукт	CODE КОДЕ/КОД	PRICE (EURO) PREIS/цена
	BDKT R/L KORLOY-MGM	
	1212 BDKT R/L -K2C tmax:15	44 €
	1616 BDKT R/L -K2C tmax:18	44 €
	2020 BDKT R/L -K2C tmax:18	51 €
	2525 BDKT R/L -K2C tmax:18	53 €
	3232 BDKT R/L -K2C tmax:18	61 €
	1212 BDKT R/L -K3C tmax:18	44 €
	1616 BDKT R/L -K3C tmax:18	44 €
	2020 BDKT R/L -K3C tmax:20	51 €
	2525 BDKT R/L -K3C tmax:22	53 €
	2525 BDKT R/L -K3C tmax:25	61 €
	2525 BDKT R/L -K3C tmax:40	92 €
	3232 BDKT R/L -K3C tmax:22	61 €
	2020 BDKT R/L -K4C tmax:20	51 €
	2525 BDKT R/L -K4C tmax:22	53 €
	2525 BDKT R/L -K4C tmax:25	61 €
	2525 BDKT R/L -K4C tmax:40	92 €
	3232 BDKT R/L -K4C tmax:22	61 €
	2020 BDKT R/L -K5C tmax:20	51 €
	2525 BDKT R/L -K5C tmax:25	53 €
	3232 BDKT R/L -K5C tmax:25	61 €
	2525 BDKT R/L -K6C tmax:25	53 €
	3232 BDKT R/L -K6C tmax:25	61 €
	2525 BDKT R/L -K8C tmax:27	53 €
	3232 BDKT R/L -K8C tmax:27	61 €

PRODUCT ПРОДУКТ/продукт	CODE КОДЕ/КОД	PRICE (EURO) PREIS/цена
	BDKT R/L KORLOY - KG	
	1212 BDKT R/L -KG2C tmax:15	44 €
	1616 BDKT R/L -KG2C tmax:18	44 €
	2020 BDKT R/L -KG2C tmax:18	51 €
	2525 BDKT R/L -KG2C tmax:18	53 €
	2020 BDKT R/L -KG3C tmax:20	51 €
	2525 BDKT R/L -KG3C tmax:22	53 €
	2020 BDKT R/L -KG4C tmax:20	51 €
	2525 BDKT R/L -KG4C tmax:22	53 €
	2525 BDKT R/L -KG5C tmax:25	53 €
	2525 BDKT R/L -KG6C tmax:25	53 €



External Grooving Toolholders

PRODUCT ПРОДУКТ/продукт	CODE КОДЕ/КОД	PRICE (EURO) PREIS/ цена
	BDKT R/L ISCAR	
	1212 BDKT R/L -I2C t max:15	44 €
	1616 BDKT R/L -I2C t max:18	44 €
	2020 BDKT R/L -I2C t max:18	51 €
	2525 BDKT R/L -I2C t max:18	53 €
	1212 BDKT R/L -I3C t max:15	44 €
	1616 BDKT R/L -I3C t max:18	44 €
	2020 BDKT R/L -I3C t max:20	51 €
	2525 BDKT R/L -I3C t max:22	53 €
	3232 BDKT R/L -I3C t max:22	61 €
	2020 BDKT R/L -I4C t max:20	51 €
	2525 BDKT R/L -I4C t max:22	53 €
	3232 BDKT R/L -I4C t max:22	61 €
	3232 BDKT R/L -I5C t max:25	61 €

PRODUCT ПРОДУКТ/продукт	CODE КОДЕ/КОД	PRICE (EURO) PREIS/ цена
	BDKT R/L HORN S229	
	2020 BDKT R/L -H-S229-2C t max:18	51 €
	2525 BDKT R/L -H-S229-2C t max:18	53 €
	2020 BDKT R/L -H-S229-3C t max:20	51 €
	2525 BDKT R/L -H-S229-3C t max:22	53 €
	2020 BDKT R/L -H-S229-4C t max:20	51 €
	2525 BDKT R/L -H-S229-4C t max:22	53 €
	2020 BDKT R/L -H-S229-5C t max:20	51 €
	2525 BDKT R/L -H-S229-5C t max:25	53 €

PRODUCT ПРОДУКТ/продукт	CODE КОДЕ/КОД	PRICE (EURO) PREIS/ цена
	BDKT R/L-K.HORN S224	
	2020 BDKT R/L -HK-S224-2C t max:18	51 €
	2525 BDKT R/L -HK-S224-2C t max:18	53 €
	2020 BDKT R/L -HK-S224-3C t max:20	51 €
	2525 BDKT R/L -HK-S224-3C t max:22	53 €
	2020 BDKT R/L -HK-S224-4C t max:20	51 €
	2525 BDKT R/L -HK-S224-4C t max:22	53 €
	2020 BDKT R/L -H-S229-5C t max:20	51 €
2525 BDKT R/L -H-S229-5C t max:25	53 €	

External Grooving Toolholders

PRODUCT PRODUKT/продукт	CODE CODE/КОД	PRICE (EURO) PREIS/ цена
	BDKT R/L SANDVIK123	
	1616 BDKT R/L -SDV123-2C t max:18	44 €
	2020 BDKT R/L -SDV123-2C t max:18	51 €
	2525 BDKT R/L -SDV123-2C t max:18	53 €
	1616 BDKT R/L -SDV123-3C t max:18	44 €
	2020 BDKT R/L -SDV123-3C t max:20	51 €
	2525 BDKT R/L -SDV123-3C t max:22	53 €
	2020 BDKT R/L -SDV123-4C t max:20	51 €
	2525 BDKT R/L -SDV123-4C t max:22	53 €
	2020 BDKT R/L -SDV123-5C t max:22	51 €
	2525 BDKT R/L -SDV123-5C t max:25	53 €

PRODUCT PRODUKT/продукт	CODE CODE/КОД	PRICE (EURO) PREIS/ цена
	BDKT R/L TAEGUTEC	
	1212 BDKT R/L -T-2C t max:15	44 €
	1616 BDKT R/L -T-2C t max:18	44 €
	2020 BDKT R/L -T-2C t max:18	51 €
	2525 BDKT R/L -T-2C t max:18	53 €
	1212 BDKT R/L -T-3C t max:15	44 €
	1616 BDKT R/L -T-3C t max:18	44 €
	2020 BDKT R/L -T-3C t max:20	51 €
	2525 BDKT R/L -T-3C t max:22	53 €
	2020 BDKT R/L -T-4C t max:20	51 €
	2525 BDKT R/L -T-4C t max:22	53 €

PRODUCT PRODUKT/продукт	CODE CODE/КОД	PRICE (EURO) PREIS/ цена
	BDKT R/L ZCC2	
	1616 BDKT R/L -ZCC2-2C t max:18	44 €
	2020 BDKT R/L -ZCC2-2C t max:18	51 €
	2525 BDKT R/L -ZCC2-2C t max:18	53 €
	1616 BDKT R/L -ZCC2-3C t max:18	44 €
	2020 BDKT R/L -ZCC2-3C t max:20	51 €
	2525 BDKT R/L -ZCC2-3C t max:22	53 €
	2020 BDKT R/L -ZCC2-4C t max:20	51 €
	2525 BDKT R/L -ZCC2-4C t max:22	53 €
	2020 BDKT R/L -ZCC2-5C t max:22	51 €
	2525 BDKT R/L -ZCC2-5C t max:25	53 €





External Grooving Toolholders

PRODUCT PRODUKT/продукт	CODE CODE/КОД	PRICE (EURO) PREIS/ цена
	BDKT R/L-LAMINA (GCTX)	
	1616 BDKT R/L - GC-LM-2C t max:18	44 €
	2020 BDKT R/L - GC-LM-2C t max:18	51 €
	2525 BDKT R/L - GC-LM-2C t max:18	53 €
	1616 BDKT R/L - GC-LM-3C t max:18	44 €
	2020 BDKT R/L - GC-LM-3C t max:20	51 €
	2525 BDKT R/L - GC-LM-3C t max:22	53 €

PRODUCT PRODUKT/продукт	CODE CODE/КОД	PRICE (EURO) PREIS/ цена
	BDKT R/L SUMITOMO (GCM)	
	1212 BDKT R/L - SM-GCM-2C t max:15	44 €
	1616 BDKT R/L - SM-GCM-2C t max:18	44 €
	2020 BDKT R/L - SM-GCM-2C t max:18	51 €
	2525 BDKT R/L - SM-GCM-2C t max:18	53 €
	1212 BDKT R/L - SM-GCM-3C t max:15	44 €
	1616 BDKT R/L - SM-GCM-3C t max:15	44 €
	2020 BDKT R/L - SM-GCM-3C t max:20	51 €
2525 BDKT R/L - SM-GCM-3C t max:22	53 €	

PRODUCT PRODUKT/продукт	CODE CODE/КОД	PRICE (EURO) PREIS/ цена
	ISCAR ALIN BOŞALTMA TAKIMLARI	
	2525 BDKT-A-I4C (Ø24X36) t max:22	75 €
	2525 BDKT-A-I4C (Ø36x48) t max:22	75 €
	2525 BDKT-A-I4C (Ø48x70) t max:22	75 €
	2525 BDKT-A-I4C (Ø70x110) t max:22	75 €
	2525 BDKT-A-I4C (Ø100x150) t max:22	75 €
	2525 BDKT-A-I4C (Ø150x200) t max:22	75 €

External Grooving Toolholders

PRODUCT ПРОДУКТ/продукт	CODE КОД/КОД	PRICE (EURO) PREIS/ цена
	KORLOY ALIN BOŞALTMA TAKIMLARI	
	2525 BDKTA-K3C (Ø24X36) t max:17	75 €
	2525 BDKTA-K3C (Ø36x48) t max:17	75 €
	2525 BDKTA-K3C (Ø48x70) t max:17	75 €
	2525 BDKTA-K3C (Ø70x110) t max:17	75 €
	2525 BDKTA-K3C (Ø100x150) t max:17	75 €
	2525 BDKTA-K3C (Ø150x200) t max:17	75 €
	2525 BDKTA-K4C (Ø24X36) t max:22	75 €
	2525 BDKTA-K4C (Ø36x48) t max:22	75 €
	2525 BDKTA-K4C (Ø48x70) t max:22	75 €
	2525 BDKTA-K4C (Ø70x110) t max:22	75 €
	2525 BDKTA-K4C (Ø100x150) t max:22	75 €
	2525 BDKTA-K4C (Ø150x200) t max:22	75 €
	2525 BDKTA-K5C (Ø24X36) t max:25	75 €
	2525 BDKTA-K5C (Ø36x48) t max:25	75 €
	2525 BDKTA-K5C (Ø48x70) t max:25	75 €
	2525 BDKTA-K5C (Ø70x110) t max:25	75 €
	2525 BDKTA-K5C (Ø100x150) t max:25	75 €
	2525 BDKTA-K5C (Ø150x200) t max:25	75 €
	BIKT 08-11-14	
	BIKT 08 A12 L100 I20	55 €
	BIKT 11 A16 L120 I25	55 €
	BIKT 14 A16 L120 I30	55 €



Internal Grooving Toolholders

PRODUCT PRODUKT/продукт	CODE CODE/КОД	PRICE (EURO) PREIS/цена
	BIKT R/L KORLOY-MGM	
	BIKT R/L 16-K2C t max:4	43 €
	BIKT R/L 20-K2C t max:4	46 €
	BIKT R/L 25-K2C t max:4	49 €
	BIKT R/L 20-K3C t max:6	46 €
	BIKT R/L 25-K3C t max:6	49 €
	BIKT R/L 32-K3C t max:8	55 €
	BIKT R/L 40-K3C t max:8	73 €
	BIKT R/L 20-K4C t max:6	46 €
	BIKT R/L 25-K4C t max:6	49 €
	BIKT R/L 32-K4C t max:6	55 €
	BIKT R/L 40-K4C t max:6	73 €
	BIKT R/L 25-K5C t max:6	49 €
	BIKT R/L 32-K5C t max:7	55 €
	BIKT R/L 40-K5C t max:7	73 €
	BIKT R/L 50-K4C t max:15	184 €
	BIKT R/L 50-K5C t max:15	184 €
BIKT R/L 50-K6C t max:15	184 €	
BIKT R/L 50-K8C t max:15	184 €	

PRODUCT PRODUKT/продукт	CODE CODE/КОД	PRICE (EURO) PREIS/цена
	BIKT R/L KORLOY-KG	
	BIKT R/L 25-KG-2C t max:7	49 €
	BIKT R/L 25-KG-3C t max:7	49 €
	BIKT R/L 25-KG-4C t max:8	49 €
	BIKT R/L 32-KG-3C t max:8	55 €
BIKT R/L 32-KG-4C t max:8	55 €	

PRODUCT PRODUKT/продукт	CODE CODE/КОД	PRICE (EURO) PREIS/цена
	BIKT R/L HORN-229	
	BIKT R/L 25-H3C (S229) t max:7	49 €
	BIKT R/L 32-H3C (S229) t max:7	55 €
	BIKT R/L 40-H3C (S229) t max:7	73 €
	BIKT R/L 25-H4C (S229) t max:7	49 €
	BIKT R/L 32-H4C (S229) t max:7	55 €
	BIKT R/L 40-H4C (S229) t max:7	73 €
	BIKT R/L 25-H5C (S229) t max:7	49 €
	BIKT R/L 32-H5C (S229) t max:7	55 €
BIKT R/L 40-H5C (S229) t max:7	73 €	

Internal Grooving Toolholders

PRODUCT ПРОДУКТ/продукт	CODE CODE/КОД	PRICE (EURO) PREIS/цена
	BIKT R/L K.HORN-224	
	BIKT R/L 20-HK2C (S224) t max:6	46 €
	BIKT R/L 25-HK2C (S224) t max:6	49 €
	BIKT R/L 20-HK3C (S224) t max:6	46 €
	BIKT R/L 25-HK3C (S224) t max:6	49 €
	BIKT R/L 32-HK3C (S224) t max:6	55 €
	BIKT R/L 20-HK4C (S224) t max:6	46 €
	BIKT R/L 25-HK4C (S224) t max:6	49 €
	BIKT R/L 32-HK4C (S224) t max:6	55 €

PRODUCT ПРОДУКТ/продукт	CODE CODE/КОД	PRICE (EURO) PREIS/цена
	BIKT R/L ZCC-2	
	BIKT R/L 20-ZCC2-2C t max:5	46 €
	BIKT R/L 20-ZCC2-3C t max:5	46 €
	BIKT R/L 25-ZCC2-3C t max:5	49 €
	BIKT R/L 32-ZCC2-3C t max:6	55 €
	BIKT R/L 25-ZCC2-4C t max:6	49 €
	BIKT R/L 32-ZCC2-4C t max:7	55 €
	BIKT R/L 32-ZCC2-5C t max:8	55 €
	BIKT R/L 40-ZCC2-4C t max:8	73 €
	BIKT R/L 40-ZCC2-5C t max:8	73 €

PRODUCT ПРОДУКТ/продукт	CODE CODE/КОД	PRICE (EURO) PREIS/цена
	BIKT R/L GRIP/DGN	
	BIKT R/L 16-IG-3C t max:6 / GRIP	43 €
	BIKT R/L 20-IG-3C t max:6 / GRIP	46 €
	BIKT R/L 25-ID-3C t max:8 / DGN	49 €
	BIKT R/L 32-ID-3C t max:8 / DGN	55 €
	BIKT R/L 25-IG-4C t max:9 / GRIP	49 €
	BIKT R/L 32-IG-4C t max:11 / GRIP	55 €

External and Internal Threading Toolholders

PRODUCT PRODUKT/продукт	CODE CODE/КОД	PRICE (EURO) PREIS/цена
 <p>ER/L16/22 ISO</p>	SER/L DİŞ TAKIMLARI	
	SER/L 0808 E11	30 €
	SER/L 1010 E11	30 €
	SER/L 1212 F11	30 €
	SER/L 1616 H11	30 €
	SER/L 1616 H16	30 €
	SER/L 2020 K16	34 €
	SER/L 2525 M16	36 €
	SER/L 3232 P16	43 €
	SER/L 2525 M22	40 €
	SER/L 3232 P22	46 €
	SER/L 4040 S22	79 €

PRODUCT PRODUKT/продукт	CODE CODE/КОД	PRICE (EURO) PREIS/цена
 <p>IR/L16/22 ISO</p>	SIR/L İÇ DİŞ KATERİ	
	SIR/L S16X07 M08	24 €
	SIR/L S10 H11	24 €
	SIR/L S12 K11	24 €
	SIR/L S16X10 M11	30 €
	SIR/L S16x13 M11	30 €
	SIR/L S16x13 M16	30 €
	SIR/L S16 M16	30 €
	SIR/L S20x16 P16	30 €
	SIR/L S20 P16	30 €
	SIR/L S25 R16	34 €
	SIR/L S32 S16	49 €
	SIR/L S40 T16	58 €
	SIR/L S20 P22	30 €
	SIR/L S25 R22	34 €
	SIR/L S32 S22	52 €
	SIR/L S40 T22	65 €

S System end mills

PRODUCTN ПРОДУКТ/продукт	CODE CODE/КОД	PRICE (EURO) PREIS/цена
 <p>AP.. 1003.. ISO</p> <p>APKT-10 -ST90°</p> <p>H: WITH COOLANT HOLE</p>	APKT-10 -ST90°	
	ST90°AP10-D12-W12-L120-Z01	31 €
	ST90°AP10-D12-W16-L120-Z01	31 €
	ST90°AP10-D14-W16-L120-Z01	36 €
	ST90°AP10-D16-W16-L120-Z02	41 €
	ST90°AP10-D16-W16-L120-Z02-H	43 €
	ST90°AP10-D18-W16-L120-Z02	41 €
	ST90°AP10-D20-W20-L120-Z03	45 €
	ST90°AP10-D20-W20-L120-Z03-H	50 €
	ST90°AP10-D22-W20-L120-Z03	45 €
	ST90°AP10-D23-W20-L120-Z03	46 €
	ST90°AP10-D24-W20-L120-Z03	46 €
	ST90°AP10-D25-W25-L120-Z03	50 €
	ST90°AP10-D25-W25-L120-Z03-H	55 €
	ST90°AP10-D26-W25-L120-Z03-H	52 €
	ST90°AP10-D30-W25-L120-Z04	55 €
	ST90° AP10 D32 W25 L120 Z04	55 €
	ST90°AP10-D32-W32-L120-Z04	51 €
	ST90°AP10-D32-W32-L120-Z04-H	58 €
	ST90°AP10-D35-W32-L120-Z05	58 €
	ST90°AP10-D40-W32-L120-Z05	65 €
	ST90°AP10-D16-W16-L150-Z02	55 €
	ST90°AP10-D18-W16-L150-Z02	55 €
	ST90°AP10-D20-W20-L150-Z03	57 €
	ST90°AP10-D22-W20-L150-Z03	57 €
	ST90°AP10-D24-W20-L150-Z03	61 €
	ST90°AP10-D25-W25-L150-Z03	61 €
	ST90°AP10-D26-W25-L150-Z03	65 €
	ST90°AP10-D30-W25-L150-Z04	65 €
	ST90°AP10-D32-W25-L150-Z04	65 €
	ST90°AP10-D32-W32-L150-Z04	65 €
	ST90°AP10-D40-W32-L150-Z05	68 €
	ST90°AP10-D16-C16-L200-Z02	58 €
	ST90°AP10-D18-C16-L200-Z02	58 €
	ST90°AP10-D20-C20-L200-Z03	68 €
	ST90°AP10-D22-C20-L200-Z03	71 €
	ST90° AP10 D24 C20 L200 Z03	74 €
	ST90°AP10-D25-C25-L200-Z03	74 €
	ST90°AP10-D26-C25-L200-Z03	74 €
	ST90°AP10-D25-C25-L250-Z03	85 €
ST90° AP10 D32 C32 L300 Z04	116 €	



S System end mills



PRODUCT ПРОДУКТ/продукт	CODE КОД/КОД	PRICE (EURO) PREIS/цена
 <p>AP. 11T3.. KORLOY-ZCC</p>	ST90° AP11..	
	ST90 AP11-D16-W16-L120-Z02	41 €
	ST90 AP11-D20-W20-L120-Z03	43 €
	ST90 AP11-D25-W25-L120-Z03	49 €
	ST90 AP11-D26-W25-L120-Z03	49 €
	ST90 AP11-D32-W32-L120-Z04	55 €
	ST90 AP11-D16-W16-L150-Z02	55 €
	ST90 AP11-D20-W20-L150-Z03	56 €
	ST90 AP11-D25-W25-L150-Z03	65 €
	ST90 AP11-D26-W25-L150-Z03	65 €
	ST90 AP11-D32-W32-L150-Z04	65 €
	ST90 AP11-D16-C16-L200-Z02	61 €
	ST90 AP11-D20-C20-L200-Z03	68 €
	ST90 AP11-D25-C25-L200-Z03	73 €
	ST90 AP11-D26-C26-L200-Z03	73 €
	ST90 AP11-D32-C32-L200-Z04	75 €

PRODUCT ПРОДУКТ/продукт	CODE КОД/КОД	PRICE (EURO) PREIS/цена
 <p>AP. 1204.. TGTC</p>	ST90° AP12..	
	ST90 AP12-D20-W20-L150-Z02	58 €
	ST90 AP12-D21-W20-L150-Z02	58 €
	ST90 AP12-D25-W25-L150-Z03	61 €
	ST90 AP12-D32-W32-L150-Z03	65 €
	ST90 AP12-D21-C20-L200-Z02	70 €
	ST90 AP12-D26-C25-L200-Z03	73 €

S System end mills

PRODUCT PRODUKT/продукт	CODE CODE/КОД	PRICE (EURO) PREIS/цена
AP.. 1604.. ISO	ST90° AP16..	
	ST90 AP16-D25-W25-L120-Z02	45 €
AP.. 1705.. TGTC	ST90 AP16-D26-W25-L120-Z02	45 €
	ST90 AP16-D28-W25-L120-Z02	47 €
	ST90 AP16-D30-W25-L120-Z03	47 €
	ST90 AP16-D32-W25-L120-Z03	49 €
	ST90 AP16-D32-W32-L120-Z03	50 €
	ST90 AP16-D34-W32-L120-Z03	52 €
	ST90 AP16-D35-W32-L120-Z03	53 €
	ST90 AP16-D36-W32-L120-Z03	53 €
	ST90 AP16-D38-W32-L120-Z04	53 €
	ST90 AP16-D40-W32-L120-Z04	53 €
	ST90 AP16-D25-W25-L150-Z02	60 €
	ST90 AP16-D26-W25-L150-Z02	60 €
	ST90 AP16-D28-W25-L150-Z03	61 €
	ST90 AP16-D30-W25-L150-Z03	63 €
	ST90 AP16-D32-W32-L150-Z03	63 €
	ST90 AP16-D32-W25-L150-Z03	61 €
	ST90 AP16-D34-W32-L150-Z03	63 €
	ST90 AP16-D35-W32-L150-Z03	66 €
	ST90 AP16-D40-W25-L150-Z04	68 €
	ST90 AP16-D40-W32-L150-Z04	69 €
	ST90 AP16-D25-C25-L200-Z02	69 €
	ST90 AP16-D26-C25-L200-Z02	69 €
	ST90 AP16-D28-C25-L200-Z03	72 €
	ST90 AP16-D30-C25-L200-Z03	75 €
	ST90 AP16-D32-C32-L200-Z03	75 €
	ST90 AP16-D34-C32-L200-Z03	76 €
	ST90 AP16-D35-C32-L200-Z03	78 €
	ST90 AP16-D40-C32-L200-Z04	84 €
	ST90° AP16 D25 W25 L250 Z02	86 €
	ST90° AP16 D32 W32 L250 Z03	86 €
	ST90° AP16 D32 W32 L300 Z03	92 €
	ST90° AP17..	
	ST90 AP17-D25-W25-L120-Z02	45 €
	ST90 AP17-D32-W32-L150-Z03	63 €
	ST90 AP17-D26-C25-L200-Z02	69 €
	ST90 AP17-D26-C25-L250-Z02	72 €
	ST90 AP17-D30-C25-L300-Z02	87 €



S System end mills

PRODUCT ПРОДУКТ/продукт	CODE КОДЕ/КОД	PRICE (EURO) PREIS/цена
 <p>LNMX10 KORLOY / KLP</p>	ST90° LN10..	
	ST90° LN10 D16 W16 L110 Z01	43 €
	ST90° LN10 D18 W16 L120 Z02	49 €
	ST90° LN10 D20 W20 L150 Z02	61 €
	ST90° LN10 D25 W25 L150 Z03	74 €
	ST90° LN10 D32 W32 L150 Z04	80 €
	ST90° LN10 D40 W32 L150 Z05	86 €

PRODUCT ПРОДУКТ/продукт	CODE КОДЕ/КОД	PRICE (EURO) PREIS/цена
 <p>LNMX15 KORLOY / KLP</p>	ST90° LN15..	
	ST90° LN15 D32 W32 L150 Z02	80 €
	ST90° LN15 D32 C32 L250 Z02	92 €
	ST90° LN15 D32 C32 L300 Z02	98 €
	ST90° LN15 D35 W32 L150 Z03	98 €
	ST90° LN15 D35 C32 L250 Z03	101 €
	ST90° LN15 D35 C32 L300 Z03	104 €
	ST90° LN15 D40 W32 L150 Z04	104 €
	ST90° LN15 D40 C32 L250 Z04	110 €
	ST90° LN15 D40 C32 L300 Z04	123 €

S System end mills

PRODUCT PRODUKT/продукт	CODE CODE/КОД	PRICE (EURO) PREIS/цена
 <p>R390.11 R390.17 SANDVIK</p>	ST90° R390.11-17..	
	ST90° R390.11-D16-W16-L100-Z02-H	49 €
	ST90° R390.11-D20-W20-L100-Z03-H	52 €
	ST90° R390.11-D25-W25-L100-Z03-H	57 €
	ST90° R390.11-D16-W16-L150-Z02	56 €
	ST90° R390.11-D16-W16-L150-Z02-H	64 €
	ST90° R390.11-D20-W20-L150-Z03	60 €
	ST90° R390.11-D20-W20-L150-Z03-H	65 €
	ST90° R390.11-D25-W25-L150-Z03	64 €
	ST90° R390.11-D25-W25-L150-Z03-H	74 €
	ST90° R390.17-D25-W25-L150-Z02	64 €
	ST90° R390.17-D25-W25-L150-Z02-H	74 €
	ST90° R390.17-D30-W25-L150-Z02	65 €
	ST90° R390.17-D30-W25-L150-Z02-H	74 €

PRODUCT PRODUKT/продукт	CODE CODE/КОД	PRICE (EURO) PREIS/цена
 <p>AD.1505 ISCAR</p>	ST90° AD15..	
	ST90°-AD15-D25-W25-L120-Z02	52 €
	ST90°-AD15-D25-W25-L150-Z02	64 €
	ST90° AD15 D30 W25 L150 Z03	62 €
	ST90°-AD15-D32-W32-L120-Z03	56 €
	ST90°-AD15-D32-W32-L150-Z03	64 €

S System end mills

PRODUCT ПРОДУКТ/продукт	CODE КОД/КОД	PRICE (EURO) PREIS/цена
 <p>AX.T12 AX.T17 SUMITOMO</p>	ST90°AX.T12- 17..	
	ST90° AX17 -D25-C25-L150-Z02	60 €
	ST90° AX17 -D32-W32-L120-Z03	64 €
	ST90° AX17 -D32 W32-L120 Z03-H	71 €
	ST90° AX17 -D32-C32-L150-Z03	62 €
	ST90° AX17 -D32-C32-L200-Z03	75 €
	ST90° AX17 -D40-W32-L150-Z04	68 €
	ST90° AX17 -D40-C32-L200-Z04	84 €
	ST90° AX17 -D32-C32-L250-Z03	89 €
	ST90° AX12-D16-C14-L120-Z02	37 €
	ST90° AX12-D16-C16-L150-Z02	41 €
	ST90° AX12-D16-W16-L200-Z02	43 €
	ST90° AX12-D20-C20-L120-Z03	43 €
	ST90° AX12-D20-C20-L150-Z03	46 €
	ST90° AX12-D25-C25-L120-Z04-H	47 €
	ST90° AX12-D25-C25-L150-Z03	62 €
	ST90° AX12-D25-C25-L200-Z03	74 €

PRODUCT ПРОДУКТ/продукт	CODE КОД/КОД	PRICE (EURO) PREIS/цена
 <p>QPMT 10-12 SUMITOMO</p>	ST QP10-12	
	ST QP10T3 D20 C20 L150 Z02	58 €
	ST QP10T3 D25 C25 L150 Z02	60 €
	ST QP10T3 D25 C25 L200 Z02	71 €
	ST QP10T3 D32 C32 L150 Z03	64 €
	ST QP10T3 D32 C32 L200 Z03	74 €
	ST QP1204 D25 C25 L150 Z02	60 €

S System end mills

PRODUCT ПРОДУКТ/продукт	CODE CODE/КОД	PRICE (EURO) PREIS/цена
 <p>RT 07-10-16 SAFETY</p> <p>SMOXY CUTTING TOOLS WWW.SMOXY.COM.LT ST90° RT10 D22 W20 L150 Z03</p>	ST90° RT07-10-13-16	
	ST90°RT07-D10-W10-L120-Z02	52 €
	ST90°RT07-D12-C12-L120-Z02	52 €
	ST90°RT07-D12-W12-L120-Z02	52 €
	ST90°RT07-D14-W12-L120-Z02	53 €
	ST90°RT10-D16-W16-L120-Z02	53 €
	ST90°RT10-D16-W16-L150-Z02	61 €
	ST90°RT10-D16-C16-L200-Z02	71 €
	ST90°RT10-D17-W16-L150-Z02	64 €
	ST90°RT10-D18-W16-L120-Z02	53 €
	ST90°RT10-D20-W20-L120-Z03	57 €
	ST90°RT10-D20-W20-L150-Z03	64 €
	ST90°RT10-D20-C20-L200-Z03	68 €
	ST90°RT10-D22-W20-L120-Z03	68 €
	ST90°RT10-D22-C20-L150-Z03	68 €
	ST90°RT10-D22-C20-L200-Z03	77 €
	ST90°RT10-D25-W25-L120-Z04	63 €
	ST90°RT10-D25-W25-L150-Z04	74 €
	ST90°RT10-D25-C25-L200-Z04	95 €
	ST90°RT10-D32-W32-L120-Z05	71 €
	ST90°RT10-D32-W32-L150-Z05	83 €
	ST90°RT10-D32-C32-L200-Z05	101 €
	ST90°RT16-D25-W25-L120-Z02	63 €
	ST90°RT16-D25-W25-L150-Z02	74 €
	ST90°RT16-D25-C25-L200-Z02	83 €
	ST90°RT16-D32-W32-L120-Z03	71 €
	ST90°RT16-D32-W32-L150-Z03	83 €
	ST90°RT16-D32-C32-L200-Z03	101 €
	ST90°RT16-D32-C32-L250-Z03	95 €
	ST90°RT16-D40-W32-L120-Z04	89 €
	ST90°RT16-D40-W32-L150-Z04	101 €
	ST90°RT16-D40-C32-L200-Z04	107 €

S System end mills

PRODUCT PRODUKT/продукт	CODE CODE/КОД	PRICE (EURO) PREIS/цена
 <p>RD08-10-12 ISO</p>	ST RD 08-10-12	
	STR-RD08-D16-W16-L120-Z02	41 €
	STR-RD08-D16-W16-L160-Z02	55 €
	STR-RD08-D20-W20-L120-Z02	46 €
	STR-RD08-D20-W20-L160-Z02	60 €
	STR-RD08-D20-C20-L200-Z02	71 €
	STR-RD08-D25-W25-L120-Z03	46 €
	STR-RD08-D25-W25-L160-Z03	60 €
	STR-RD08-D25-W25-L200-Z03	71 €
	STR-RD08-D32-W32-L120-Z04	52 €
	STR-RD08-D32-W32-L160-Z04	64 €
	STR-RD08-D32-C32-L200-Z02	74 €
	STR-RD10-D20-W20-L120-Z02	46 €
	STR-RD10-D20-W20-L160-Z02	60 €
	STR-RD10-D20-C20-L200-Z02	71 €
	STR-RD10-D25-W25-L120-Z02	49 €
	STR-RD10-D25-W25-L160-Z02	60 €
	STR-RD10-D25-C25-L200-Z02	71 €
	STR-RD10-D32-W32-L120-Z03	52 €
	STR-RD10-D32-W32-L160-Z03	64 €
	STR-RD10-D32-C32-L200-Z03	74 €
	STR-RD10-D40-W32-L120-Z04	61 €
	STR-RD10-D40-W32-L160-Z04	77 €
	STR-RD10-D40-C32-L200-Z04	86 €
	STR-RD12-D25-W25-L120-Z02	49 €
	STR-RD12-D25-W25-L160-Z02	60 €
	STR-RD12-D25-C25-L200-Z02	71 €
	STR-RD12-D32-W32-L120-Z03	52 €
	STR-RD12-D32-W32-L160-Z03	64 €
	STR-RD12-D32-C32-L200-Z03	74 €
	STR-RD12-D40-W32-L120-Z04	61 €
	STR-RD12-D40-W32-L160-Z04	75 €
	STR-RD12-D40-C32-L200-Z04	86 €

PRODUCT PRODUKT/продукт	CODE CODE/КОД	PRICE (EURO) PREIS/цена
 <p>WALTER</p>	BSRT P32..	
	SRT-P3208-D08-L130-d10	55 €
	SRT-P3210-D10-L130-d12	55 €
	SRT-P3212-D12-L150-d12	60 €
	SRT-P3216-D16-L175-d16	61 €
	SRT-P3220-D20-L200-d20	71 €
	SRT-P3225-D25-L200-d25	74 €
	SRT-P3232-D32-L200-d32	80 €

High Feed End Mills

PRODUCT ПРОДУКТ/продукт	CODE КОДЕ/КОД	PRICE (EURO) PREIS/цена
 <p>WNMX 09T3 KORLOY</p>	HST WN09..	
	HST WN09T3 D25 W25 L150 Z02-H	61 €
	HST WN09T3 D25 C25 L200 Z02	74 €
	HST WN09T3 D25 C25 L300 Z02	92 €
	HST WN09T3 D26 W25 L150 Z02-H	61 €
	HST WN09T3 D26 C25 L200 Z02	74 €
	HST WN09T3 D26 C25 L300 Z02	92 €
	HST WN09T3 D32 W25 L150 Z03-H	74 €
	HST WN09T3 D32 C25 L200 Z03	86 €
	HST WN09T3 D32 C32 L300 Z03	98 €
	HST WN09T3 D33 W32 L150 Z03-H	74 €
	HST WN09T3 D33 C32 L200 Z03	86 €
	HST WN09T3 D33 C32 L300 Z03	98 €
	HST WN09T3 D33 C32 L300 Z03	98 €
	HST WN09T3 D35 W32 L150 Z04-H	80 €
	HST WN09T3 D35 C32 L200 Z04	92 €
	HST WN09T3 D35 C32 L300 Z04	104 €
	HST WN09T3 D40 W32 L150 Z04-H	80 €
	HST WN09T3 D40 W32 L200 Z04-H	92 €
HST WN09T3 D40 C32 L300 Z04	110 €	

PRODUCT ПРОДУКТ/продукт	CODE КОДЕ/КОД	PRICE (EURO) PREIS/цена
 <p>SD..09T3 ZCC</p>	HST SD09..	
	HST SD09T3 D25 W25 L150 Z02-H	61 €
	HST SD09T3 D32 W25 L150 Z03-H	74 €
	HST SD09T3 D35 W32 L150 Z03-H	80 €

T System Milling

PRODUCT PRODUKT/продукт	CODE CODE/КОД	PRICE (EURO) PREIS/цена
 <p>CCM.06/09/12 ISO</p>	TF90° T FREZELER	
	TF90 CC06 D17x8 L100 Z02	60 €
	TF90 CC06 D20x9 L100 Z02	60 €
	TF90 CC06 D23x10 L120 Z04	64 €
	TF90 CC06 D25x10 L120 Z04	64 €
	TF90 CC06 D26x11 L120 Z04	64 €
	TF90 CC06 D30x12 L120 Z04	83 €
	TF90 CC06 D32x12 L120 Z04	83 €
	TF90 CC06 D35x12 L120 Z04	86 €
	TF90 CC06 D40x12 L120 Z06	89 €
	TF90 CC06 D42x12 L120 Z06	92 €
	TF90 CC06 D45x8 L120 Z06	101 €
	TF90 CC06 D45x10 L120 Z06	101 €
	TF90 CC06 D50X8 L120 Z06	114 €
	TF90 CC06 D50X10 L120 Z06	114 €
	TF90 CC06 D55x8 L120 Z08	129 €
	TF90 CC06 D55x10 L120 Z06	129 €
	TF90 CC06 D60x8 L120 Z08	147 €
	TF90 CC06 D60x10 L120 Z08	147 €
	TF90 CC09 D35x14 L120 Z04	86 €
TF90 CC09 D42x14 L120 Z04	92 €	
TF90 CC09 D45x14 L120 Z04	101 €	
TF90 CC12 D47x20 L120 Z08	107 €	

PRODUCT PRODUKT/продукт	CODE CODE/КОД	PRICE (EURO) PREIS/цена
 <p>SPMG.09/11 TAEGUTEK</p>	TF90° T FREZELER	
	TF90° SPMG 0904-D37x16-W32-L120-Z04	86 €
	TF90° SPMG 0904-D42x17-W32-L120-Z04	92 €
	TF90° SPMG 1104-D47x20-W32-L120-Z04	110 €

T System Milling

PRODUCT ПРОДУКТ/продукт	CODE КОДЕ/КОД	PRICE (EURO) PREIS/цена
 <p>RDM.10/12/16 ISO</p>	TF FREZELER	
	TF RD0702-D17-W16-L120-Z02	61 €
	TF RD0702-D25-W16-L120-Z03	64 €
	TF RD0702-D35-W25-L120-Z05	86 €
	TF RD1003-D21-W25-L120-Z02	63 €
	TF RD12T3-D25-W25-L120-Z02	64 €
	TF RD1603-D34-W32-L120-Z02	86 €

DISK FREZELER

Disc Milling

PRODUCT ПРОДУКТ/продукт	CODE КОДЕ/КОД	PRICE (EURO) PREIS/цена
 <p>CCM.06/09/12 ISO</p>	DISK FREZELER	
	BSDF CC06 D60x8 d27 Z08	107 €
	BSDF CC06 D80x8 d27 Z10	138 €
	BSDF CC06 D100x8 d32 Z12	150 €
	BSDF CC06 D125x8 d40 Z14	200 €
	BSDF CC06 D60x10 d27 Z08	107 €
	BSDF CC06 D80x10 d27 Z10	138 €
	BSDF CC06 D100x10 d32 Z12	150 €
	BSDF CC06 D125x10 d40 Z14	200 €
	BSDF CC06 D160x10 d40 Z16	225 €
	BSDF CC09 D80X12 d27 Z08	138 €
	BSDF CC09 D100X12 d32 Z10	150 €
	BSDF CC09 D125X12 d40 Z12	200 €
	BSDF CC09 D160X12 d40 Z14	225 €
	BSDF CC09 D80x14 d27 Z08	138 €
	BSDF CC09 D100x14 d32 Z10	150 €
	BSDF CC09 D125x14 d40 Z12	200 €
	BSDF CC09 D160x14 d40 Z14	225 €



Disc Milling

PRODUCT PRODUKT/продукт	CODE CODE/КОД	PRICE (EURO) PREIS/цена
KORLOY-MGM 	DAİRE KANAL TAKIMLARI	
	DKT-K3C D50 W20 L120 Z2	223 €
	DKT-K4C D50 W20 L120 Z2	223 €
	DKT-K5C D50 W20 L120 Z2	223 €
	DKT-K3C D63 W25 L120 Z2	260 €
	DKT-K4C D63 W25 L120 Z2	260 €
	DKT-K5C D63 W25 L120 Z2	260 €
	DKT-K3C D80 W32 L120 Z2	290 €
	DKT-K4C D80 W32 L120 Z2	290 €
	DKT-K5C D80 W32 L120 Z2	290 €

S SİSTEM PAH FREZELER

S System Chamfering End Mills

PRODUCT PRODUKT/продукт	CODE CODE/КОД	PRICE (EURO) PREIS/цена
TCM.11/16 ISO 	HAVŞA FREZELER	
	HF45° TC11 D4-15 L100 Z01	31 €
	HF45° TC16 D10-31 L100 Z02	37 €
	HF45° TC16 D14-35 L100 Z02	39 €
	HF45° TC16 D22-43 L100 Z03	43 €
	HF45° TC16 D32-53 L100 Z04	49 €
	HF30° TC16 D30-45 L100 Z02	43 €
	HF30° TC16 D20-35 L100 Z02	43 €
	HF30° TC16 D6-20 L100 Z01	33 €
	HF25° TC16 D17-30 L100 Z01	33 €
	HF22,5° TC16 D17-28 L100 Z01	33 €
	HF20° TC16 D17-26 L100 Z01	33 €
	HF20° TC16 D12-20 L100 Z01	33 €
	HF17,5° TC16 D17-24 L100 Z01	33 €
	HF15° TC16 D17-22 L100 Z01	33 €
	HF10° TC16 D18-21 L100 Z01	33 €

PRODUCT PRODUKT/продукт	CODE CODE/КОД	PRICE (EURO) PREIS/цена
SPMG.09/11 TAEGUTEK 	HAVŞA FREZELER	
	HF45° SP09 D11x25-W20-L150-Z01	39 €
	HF45° SP11 D24x38-W25-L150-Z02	46 €
	HF45° SP11 D31x45-W32-L150-Z03	49 €

S System Modular End Mills

PRODUCT PRODUKT/продукт	CODE CODE/КОД	PRICE (EURO) PREIS/цена
 <p>RD08-10-12 ISO</p>	MODÜLER FREZELER RDMT	
	MT RD08 D16 M08 L23 Z02-H	55 €
	MT RD08 D20 M10 L30 Z03-H	49 €
	MT RD08 D25 M12 L35 Z04-H	66 €
	MT-RD10-D20-M10-L30-Z02-H	61 €
	MT-RD10-D25-M12-L35-Z03-H	66 €
	MT-RD10-D30-M16-L43-Z03-H	70 €
	MT-RD10-D32-M16-L43-Z04-H	74 €
	MT-RD10-D35-M16-L43-Z04-H	74 €
	MT-RD10-D40-M16-L43-Z04-H	77 €
	MT-RD10-D42-M16-L43-Z05-H	80 €
	MT-RD12-D24-M12-L35-Z02-H	67 €
	MT-RD12-D25-M12-L35-Z02-H	67 €
	MT-RD12-D32-M16-L43-Z03-H	74 €
	MT-RD12-D35-M16-L43-Z03-H	74 €
	MT-RD12-D40-M16-L43-Z04-H	77 €
	MT-RD12-D42-M16-L43-Z04-H	80 €

PRODUCT PRODUKT/продукт	CODE CODE/КОД	PRICE (EURO) PREIS/цена
 <p>AP10 ISO</p>	MODÜLER FREZELER APKT	
	MT90-AP10-D16-M08-L30-Z02-H	61 €
	MT90-AP10-D20-M10-L30-Z03-H	64 €
	MT90-AP10-D25-M12-L35-Z03-H	67 €
	MT90-AP10-D32-M16-L35-Z04-H	74 €
	MT90-AP10-D40-M16-L43-Z05-H	77 €
	MT90-AP10-D42-M16-L43-Z05-H	80 €

PRODUCT PRODUKT/продукт	CODE CODE/КОД	PRICE (EURO) PREIS/цена
 <p>AP10 ISO</p>	MODÜLER FREZELER AP16	
	MT90° AP16 D25 M12 L35 Z02 H	67 €
	MT90° AP16 D32 M16 L43 Z03 H	74 €
	MT90° AP16 D40 M16 L43 Z04 H	77 €
	MT90° AP16 D42 M16 L43 Z04 H	80 €



S System Modular End Mills





PRODUCT PRODUKT/продукт	CODE CODE/КОД	PRICE (EURO) PREIS/цена
 <p>R390.11 SANDVIK</p>	MODULER FEREZELER R390.11	
	MT90° R390.11 D16 M08 L30 Z02 H	61 €
	MT90° R390.11 D20 M10 L30 Z03 H	64 €
	MT90° R390.11 D25 M12 L35 Z03 H	67 €
	MT90° R390.11 D32 M16 L43 Z04 H	74 €

PRODUCT PRODUKT/продукт	CODE CODE/КОД	PRICE (EURO) PREIS/цена
 <p>AX.T12 SUMITOMO</p>	MODULER FREZELER AX12	
	MT90° AX12 D16 M08 L30 Z02 H	61 €
	MT90° AX12 D20 M10 L30 Z03 H	64 €
	MT90° AX12 D25 M12 L35 Z03 H	67 €

PRODUCT PRODUKT/продукт	CODE CODE/КОД	PRICE (EURO) PREIS/цена
 <p>RT10.. SAFETY</p>	MODULER FEREZELER RT10..	
	MT90° RT10 D25 M12 L30 Z04-H	67 €
	MT90° RT10 D32 M16 L43 Z05-H	74 €
	MT90° RT10 D42 M16 L43 Z06-H	80 €

S System Modular End Mills

PRODUCT ПРОДУКТ/продукт	CODE CODE/КОД	PRICE (EURO) PREIS/цена
 <p>QPMT10.. SUMITOMO</p>	MODULER FREZELER QP10..	
	MT QP10T3 D20 M10 L30 Z02-H	64 €
	MT QP10T3 D25 M12 L35 Z03-H	67 €
	MT QP10T3 D32 M16 L43 Z03-H	74 €
	MT QP10T3 D40 M16 L43 Z04-H	77 €

PRODUCT ПРОДУКТ/продукт	CODE CODE/КОД	PRICE (EURO) PREIS/цена
 <p>WALTER</p>	MODULER FERZELER P32..	
	MT P3216 D16 M08 L25	61 €
	MT P3220 D20 M10 L30	64 €
	MT P3225 D25 M12 L35	67 €
	MT P3232 D32 M16 L43	74 €



High Feed Modular End Mills Helix mills



PRODUCT PRODUKT/продукт	CODE CODE/КОД	PRICE (EURO) PREIS/цена
 WN09T3 KORLOY	WN09T3 MODULER HIZ TAKIMI	
	MHT WN09T3 D32 M16 L40 Z03-H	74 €
	MHT WN09T3 D40 M16 L40 Z04-H	80 €

PRODUCT PRODUKT/продукт	CODE CODE/КОД	PRICE (EURO) PREIS/цена
 SD..09T3 ZCC	SD09T3 MODULER HIZ TAKIMI	
	MHT SD09T3 D25 M12 L30 Z02-H	65 €
	MHT SD09T3 D32 M16 L43 Z03-H	74 €
	MHT SD09T3 D35 M16 L43 Z03-H	77 €
	MHT SD09T3 D40 M16 L43 Z04-H	80 €

PRODUCT PRODUKT/продукт	CODE CODE/КОД	PRICE (EURO) PREIS/цена
 TK90° HELİSEL FREZELER	TK90° HELİSEL FREZELER	
	HT90-AP10-D20-L87-A20-Z06-H	178 €
	HT90-AP10-D25-L105-A25-Z08-H	115 €
	HT90-AP10-D32-L115-A32-Z15-H	275 €
	HT90-AP10-D40-L130-A32-Z18-H	306 €

S System Dove Mills

PRODUCT PRODUKT/продукт	CODE CODE/КОД	PRICE (EURO) PREIS/цена
 DCM.11 ISO	KIRLANGIÇ TAKIMLAR	
	BKRF60-DC11-D31.96-L120-Z02	116 €
	BKRF60-DC11-D40.05-L120-Z02	135 €
	BKRF60-DC11-D50-L120-Z04	153 €
	BKRF55-DC11-D60-L120-Z04	180 €
	BKRF60-DC11-D80-L120-Z04	202 €

Adjustable Rough Boring Heads

PRODUCT ПРОДУКТ/продукт	CODE CODE/КОД	PRICE (EURO) PREIS/цена
 <p>CCM.06/09/12 150</p>	Adjustable Rough Boring Heads	
	SBT-CC06 D20-24 W16 L100	147 €
	SBT-CC06 D20-24 W16 L150	156 €
	SBT-CC06 D20-24 W16 L200	193 €
	SBT-CC06 D24-29 W20 L100	153 €
	SBT-CC06 D24-29 W20 L150	156 €
	SBT-CC06 D24-29 W20 L230	193 €
	SBT-CC09 D29-39 W20 L105	153 €
	SBT-CC09 D29-39 W20 L155	168 €
	SBT-CC09 D29-39 W25 L230	202 €
	SBT-CC09 D39-49 W25 L120	156 €
	SBT-CC09 D39-49 W25 L170	110 €
	SBT-CC09 D39-49 W25 L250	208 €
	SBT-CC09 D49-60 W32 L126	160 €
	SBT-CC09 D49-60 W32 L176	180 €
	SBT-CC09 D49-60 W32 L260	115 €
	SBT-CC12 D59-79 W32 L145	178 €
	SBT-CC12 D59-79 W32 L195	180 €
	SBT-CC12 D59-79 W32 L280	227 €
	SBT-CC12 D69-89 W32 L145	180 €
	SBT-CC12 D69-89 W32 L195	196 €
	SBT-CC12 D69-89 W40 L290	242 €
	SBT-CC12 D89-130 W32 L175	196 €
	SBT-CC12 D89-130 W32 L225	208 €

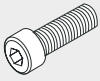
CODE CODE/КОД	PRICE (EURO) PREIS/цена	Kartuş Vidası Cartridge Screw	PRICE (EURO) PREIS/цена
BARA KARTUŞLARI			
D20-24 KARTUŞ	43 €	BKTV M4X15	3 €
D24-29 KARTUŞ	43 €	BKTV M5X25	3 €
D29-39 KARTUŞ	46 €	BKTV M6X30	3 €
D39-49 KARTUŞ	49 €		3 €
D49-60 KARTUŞ	49 €		3 €
D59-79 KARTUŞ	52 €	BKTV M8X30	3 €
D69-89 KARTUŞ	58 €		3 €
D89-130 KARTUŞ	64 €		3 €



Face Milling Cutter

PRODUCT PRODUKT/продукт	CODE CODE/КОД	PRICE (EURO) PREIS/цена
 <p>ISO</p>	TK90° APKT-10	
	TK90-AP10-D40-A16-Z05-H	54 €
	TK90-AP10-D50-A22-Z06-H	67 €
	TK90-AP10-D63-A22-Z07-H	80 €
	TK90-AP10-D80-A27-Z08-H	92 €
	TK90-AP10-D100-A32-Z09-H	110 €
	TK90-AP10-D125-B40-Z11	141 €

PRODUCT PRODUKT/продукт	CODE CODE/КОД	PRICE (EURO) PREIS/цена
 <p>ISO</p>	TK90° APKT-16	
	TK90-AP16-D40-A16-Z04-H	54 €
	TK90-AP16-D50-A22-Z05-H	67 €
	TK90-AP16-D63-A22-Z06-H	80 €
	TK90-AP16-D80-A27-Z07-H	92 €
	TK90-AP16-D100-A32-Z08-H	110 €
	TK90-AP16-D125-B40-Z09	141 €
	TK90-AP16-D160-C40-Z10	184 €
TK90-AP16-D200-C60-Z12	294 €	

PRODUCT PRODUKT/продукт	CODE CODE/КОД	PRICE (EURO) PREIS/цена
 <p>ISCAR</p>	TK90° ADKT-15	
	TK90-AD1505-D40-A16-Z04-H	54 €
	TK90-AD1505-D50-A22-Z05-H	67 €
	TK90-AD1505-D63-A22-Z06-H	80 €
	TK90-AD1505-D80-A27-Z07-H	92 €
	TK90-AD1505-D100-A32-Z08-H	110 €
	TK90-AD1505-D125-B40-Z09	141 €

PRODUCT PRODUKT/продукт	CODE CODE/КОД	PRICE (EURO) PREIS/цена
 <p>SANDVIK</p>	TK90° R390.11T3-R390.17T4	
	TK90-R390.11-D40-A16-Z05-H	54 €
	TK90-R390.11-D50-A22-Z06-H	67 €
	TK90-R390.11-D63-A22-Z07-H	80 €
	TK90-R390.17-D40-A16-Z04-H	54 €
	TK90-R390.17-D50-A22-Z05-H	67 €
	TK90-R390.17-D63-A22-Z06-H	80 €
	TK90-R390.17-D80-A27-Z07-H	92 €
	TK90-R390.17-D100-A32-Z08-H	110 €
TK90-R390.17-D125-D40-Z09	141 €	

Face Milling Cutter

PRODUCT ПРОДУКТ/продукт	CODE CODE/КОД	PRICE (EURO) PREIS/цена
 <p>ISO</p>	TK45° SN-1206	
	TK45-SN1206-D50-A22-Z05-H	77 €
	TK45-SN1206-D63-A22-Z07-H	95 €
	TK45-SN1206-D80-A27-Z08-H	107 €
	TK45-SN1206-D100-A32-Z10-H	120 €
	TK45-SN1206-D125-B40-Z11	184 €
	TK45-SN1206-D160-C40-Z12	215 €
	TK45-SN1206-D200-C60-Z14	300 €

PRODUCT ПРОДУКТ/продукт	CODE CODE/КОД	PRICE (EURO) PREIS/цена
 <p>SANDVIK / ZCC</p>	TK90° R290.12 - SE12T3	
	TK90-R290.12-D50-A22-Z04-H	61 €
	TK90-R290.12-D63-A22-Z05-H	80 €
	TK90-R290.12-D80-A27-Z07-H	92 €
	TK90-R290.12-D100-A32-Z09-H	110 €
	TK90-R290.12-D125-B40-Z11	141 €

PRODUCT ПРОДУКТ/продукт	CODE CODE/КОД	PRICE (EURO) PREIS/цена
 <p>ZCC</p>	TK45° SE-12T3	
	TK45-SE12T3-D50-A22-Z04-H	61 €
	TK45-SE12T3-D63-A22-Z05-H	80 €
	TK45-SE12T3-D80-A27-Z06-H	92 €
	TK45-SE12T3-D100-A32-Z07-H	110 €
	TK45-SE12T3-D125-B40-Z08	138 €
	TK45-SE12T3-D160-C40-Z10	215 €

PRODUCT ПРОДУКТ/продукт	CODE CODE/КОД	PRICE (EURO) PREIS/цена
 <p>SECO</p>	TK90° XO-1204	
	TK90-XO12-D40-A16-Z05	54 €
	TK90-XO12-D50-A22-Z06	64 €
	TK90-XO12-D63-A22-Z08	80 €
	TK90-XO12-D80-A27-Z09	92 €

Face Milling Cutter

PRODUCT PRODUKT/продукт	CODE CODE/КОД	PRICE (EURO) PREIS/цена
 <p>ISO</p>	TK75° APKT-10-16	
	TK75-AP10-D63-A22-Z05	80 €
	TK75-AP10-D80-A27-Z06	92 €
	TK75-AP10-D100-A32-Z07	110 €
	TK75-AP16-D63-A22-Z04	80 €
	TK75-AP16-D80-A27-Z06	92 €
	TK75-AP16-D100-A32-Z07	110 €
	TK75-AP16-D125-B40-Z08	141 €

PRODUCT PRODUKT/продукт	CODE CODE/КОД	PRICE (EURO) PREIS/цена
 <p>TAEGUTEC</p>	TK90° AP17..	
	TK90° AP17 D50 A22 Z05-H	67 €
	TK90° AP17 D63 A22 Z06-H	80 €
	TK90° AP17 D80 A27 Z07-H	92 €
	TK90° AP17 D100 A32 Z09-H	110 €

PRODUCT PRODUKT/продукт	CODE CODE/КОД	PRICE (EURO) PREIS/цена
 <p>WALTER</p>	TK43° OD0504	
	TK43-OD0504-D40-A16-Z04-H	61 €
	TK43-OD0504-D50-A22-Z05-H	77 €
	TK43-OD0504-D63-A22-Z06-H	92 €
	TK43-OD0504-D80-A27-Z07-H	107 €
	TK43-OD0504-D100-A32-Z08-H	129 €

PRODUCT PRODUKT/продукт	CODE CODE/КОД	PRICE (EURO) PREIS/цена
 <p>ISO</p>	TK45° ON0806	
	TK45-ON05-D50-A22-Z05-H	77 €
	TK45-ON05-D63-A22-Z06-H	92 €
	TK45-ON05-D80-A22-Z07-H	104 €
	TK45-ON05-D100-A32-Z08-H	126 €
	TK45-ON08-D63-A22-Z05-H	95 €
	TK45-ON08-D80-A27-Z06-H	101 €
	TK45-ON08-D100-A32-Z07-H	113 €
	TK45-ON08-D125-B40-Z08	178 €
	TK45-ON08-D160-C40-Z10	202 €
TK45-ON08-D200-C60-Z12	306 €	

Face Milling Cutter

PRODUCT PRODUKT/продукт	CODE CODE/КОД	PRICE (EURO) PREIS/цена
 <p>WALTER</p>	TK90° LN.X 1307	
	TK90-LN13-D50-A22-Z05	67 €
	TK90-LN13-D63-A22-Z06	77 €
	TK90-LN13-D80-A27-Z07	92 €
	TK90-LN13-D100-A32-Z08	123 €
	TK90-LN13-D125-C40-Z10	156 €

PRODUCT PRODUKT/продукт	CODE CODE/КОД	PRICE (EURO) PREIS/цена
 <p>ISO</p>	OF07T3 TARAMA KAFASI	
	TK43° OF07T3 D50 A22 Z05-H	104 €
	TK43° OF07T3 D63 A22 Z06-H	123 €
	TK43° OF07T3 D80 A27 Z07-H	135 €
	TK43° OF07T3 D100 A32 Z08-H	184 €
	TK43° OF07T3 D125 B40 Z09-H	245 €

PRODUCT PRODUKT/продукт	CODE CODE/КОД	PRICE (EURO) PREIS/цена
 <p>ISO</p>	TK88° SN1206	
	TK88-SN12-D63-A22-Z06-H	67 €
	TK88-SN12-D80-A27-Z07-H	85 €
	TK88-SN12-D100-A32-Z09-H	110 €
	TK88-SN12-D125-B40-Z10	141 €
	TK88-SN12-D160-C40-Z11	184 €
	TK88° SN12 D200 C60 Z14	306 €

PRODUCT PRODUKT/продукт	CODE CODE/КОД	PRICE (EURO) PREIS/цена
 <p>TAEGUTEC</p>	TK90° AN.X1607	
	TK90°-AN16-D50-A22-Z04-H	67 €
	TK90°-AN16-D63-A22-Z06-H	77 €
	TK90°-AN16-D80-A27-Z07-H	92 €
	TK90°-AN16-D100-A32-Z08-H	110 €

Face Milling Cutter

PRODUCT PRODUKT/продукт	CODE CODE/КОД	PRICE (EURO) PREIS/цена
 VANDURIT	TK90° XNEX 0806	
	TK90-XN08-D50-A22-Z04	89 €
	TK90-XN08-D63-A22-Z05	104 €
	TK90-XN08-D80-A27-Z07	122 €

PRODUCT PRODUKT/продукт	CODE CODE/КОД	PRICE (EURO) PREIS/цена
 KYOCERA JD	TK90° WN0806	
	TK90-WN08-D50-A22-Z04	89 €
	TK90-WN08-D63-A22-Z05	104 €
	TK90-WN08-D80-A27-Z07	122 €

PRODUCT PRODUKT/продукт	CODE CODE/КОД	PRICE (EURO) PREIS/цена
 KORLOY	LNMX10 TARAMA KAFASI	
	TK90° LN10 D40 A16 Z05-H	61 €
	TK90° LN10 D50 A22 Z06-H	68 €
	TK90° LN10 D63 A22 Z07-H	77 €

PRODUCT PRODUKT/продукт	CODE CODE/КОД	PRICE (EURO) PREIS/цена
 KORLOY	LNMX15 TARAMA KAFASI	
	TK90° LN15 D50 A22 Z05-H	68 €
	TK90° LN15 D63 A22 Z06-H	80 €
	TK90° LN15 D80 A27 Z07-H	95 €
	TK90° LN15 D100 A32 Z09-H	116 €

PRODUCT PRODUKT/продукт	CODE CODE/КОД	PRICE (EURO) PREIS/цена
 SUMITOMO	AX12-17 TARAMA KAFASI	
	TK90° AX12 D40 A16 Z05-H	54 €
	TK90° AX12 D50 A22 Z06-H	68 €
	TK90° AX12 D63 A22 Z07-H	80 €
	TK90° AX12 D80 A27 Z09-H	92 €
	TK90° AX17 D40 A16 Z04-H	54 €
	TK90° AX17 D50 A22 Z05-H	68 €
	TK90° AX17 D63 A22 Z06-H	80 €
	TK90° AX17 D80 A27 Z07-H	92 €
	TK90° AX17 D100 A32 Z08-H	110 €

Face Milling Cutter

PRODUCT PRODUKT/продукт	CODE CODE/КОД	PRICE (EURO) PREIS/цена	
 <p>SUMITOMO</p>	<p>QPMT10-12 TARAMA KAFASI</p>		
	TK QP10T3 D40 A16 Z04-H	80,00 €	
	TK QP10T3 D50 A22 Z05-H	61 €	
	TK QP10T3 D63 A22 Z06-H	80 €	
	TK QP10T3 D80 A27 Z07-H	153,00 €	
	TK QP1204 D63 A22 Z06-H	80 €	
	TK QP1204 D80 A27 Z07-H	153,00 €	
	TK QP1204 D100 A32 Z09-H	190,00 €	
	 <p>SAFETY</p>	<p>TK90° RT10-16</p>	
		TK90-RT10-D40-A16-Z06	54 €
TK90-RT10-D50-A22-Z07		68 €	
TK90-RT10-D63-A22-Z09		81 €	
TK90-RT16-D50-A22-Z05		68 €	
TK90-RT16-D63-A22-Z06		81 €	
TK90-RT16-D80-A27-Z07		95 €	
TK90-RT16-D100-A32-Z08		115 €	
TK90-RT16-D125-B40-Z09		141 €	
 <p>ISO</p>	<p>RDMT 1003</p>		
	TK-RD1003-D40-A16-Z04	49 €	
	TK-RD1003-D50-A22-Z05	61 €	
	TK-RD1003-D63-A22-Z06	80 €	
	TK-RD1003-D80-A27-Z07	95 €	
	TK-RD1003-D100-A32-Z08	116 €	
	TK-RD1003-D125-B40-Z09	135 €	
	TK-RD12T3-D40-A16-Z04	49 €	
	TK-RD12T3-D50-A22-Z05	61 €	
	TK-RD12T3-D63-A22-Z06	80 €	
	TK-RD12T3-D80-A27-Z07	95 €	
	TK-RD12T3-D100-A32-Z08	116 €	
	TK-RD12T3-D125-B40-Z09	135 €	
	 <p>ISO</p>	<p>TPKN 1603-2205</p>	
		TK90-TP16-D50-A22-Z04	61 €
TK90-TP16-D63-A22-Z05		74 €	
TK90-TP16-D80-A27-Z06		89 €	
TK90-TP16-D100-A32-Z07		101 €	
TK90-TP16-D125-B40-Z08		128 €	
TK90-TP16-D160-C40-Z09		165 €	
TK90-TP22-D63-A22-Z04		77 €	
TK90-TP22-D80-A27-Z05		92 €	
TK90-TP22-D100-A32-Z06		104 €	
TK90-TP22-D125-B40-Z07		128 €	
TK90-TP22-D160-C40-Z08		165 €	
TK90-TP22-D200-C60-Z11		306 €	

High Feed Face Milling Cutter

PRODUCT PRODUKT/продукт	CODE CODE/КОД	PRICE (EURO) PREIS/цена
 <p>KORLOY</p>	HTK-WNMX09 HIGH FEED	
	HTK WN09 D40 A16 Z04-H	74 €
	HTK WN09 D50 A22 Z05-H	89 €
	HTK WN09 D63 A22 Z06-H	104 €

PRODUCT PRODUKT/продукт	CODE CODE/КОД	PRICE (EURO) PREIS/цена
 <p>TAEGUTEC</p>	HTK-BLMP09 HIGH FEED	
	HTK BL09 D40 A16 Z05-H	74 €
	HTK BL09 D50 A22 Z06-H	89 €
	HTK BL09 D63 A22 Z07-H	104 €

PRODUCT PRODUKT/продукт	CODE CODE/КОД	PRICE (EURO) PREIS/цена
 <p>LAMINA</p>	HTK-SD..09T3 HIGH FEED	
	HTK SD09 D40 A16 Z04-H	74 €
	HTK SD09 D50 A22 Z05-H	89 €
	HTK SD09 D63 A22 Z06-H	104 €

PRODUCT PRODUKT/продукт	CODE CODE/КОД	PRICE (EURO) PREIS/цена
 <p>ZCC</p>	HTK-SD12 HIGH FEED	
	HTK SD1204 D50 A22 Z05-H	89 €
	HTK SD1204 D63 A22 Z06-H	104 €

Modular Tool Holders

PRODUCT ПРОДУКТ/продукт	CODE CODE/КОД	PRICE (EURO) PREIS/цена
	MODULER TAKIM TUTUCULARI	
	SMVT D18 C20 M10 L120-H	74 €
	SMVT D18 C20 M10 L170-H	92 €
	SMVT D24 C25 M16 L160-H	98 €
	SMVT D24 C25 M16 L200-H	122 €
	SMVT D24 C25 M16 L250-H	153 €
	SMVT D31 C32 M16 L160-H	104 €
	SMVT D31 C32 M16 L200-H	141 €
	SMVT D31 C32 M16 L250-H	170 €

U-Drills



PRODUCT PRODUKT/продукт	CODE CODE/КОД	PRICE (EURO) PREIS/цена
ISO	WCMX D2 U-DRILL	
	SDUM 16xD2 WCM.030208	95 €
	SDUM 16,5xD2 WCM.030208	95 €
	SDUM 17xD2 WCM.030208	95 €
	SDUM 17,5xD2 WCM.030208	95 €
	SDUM 18 xD2 WCM.030208	95 €
	SDUM 18,5xD2 WCM.030208	95 €
	SDUM 19 xD2 WCM.030208	107 €
	SDUM 19,5xD2 WCM.030208	107 €
	SDUM 20 xD2 WCM.040208	107 €
	SDUM 20,5 xD2 WCM.040208	107 €
	SDUM 21 xD2 WCM.040208	107 €
	SDUM 21,5 xD2 WCM.040208	107 €
	SDUM 22 xD2 WCM.040208	107 €
	SDUM 22,5 xD2 WCM.040208	107 €
	SDUM 23 xD2 WCM.040208	110 €
	SDUM 23,5 xD2 WCM.040208	110 €
	SDUM 24 xD2 WCM.050308	110 €
	SDUM 24,5 xD2 WCM.050308	110 €
	SDUM 25 xD2 WCM.050308	110 €
	SDUM 25,5 xD2 WCM.050308	110 €
	SDUM 26 xD2 WCM.050308	110 €
	SDUM 26,5 xD2 WCM.050308	110 €
	SDUM 27 xD2 WCM.050308	110 €
	SDUM 27,5 xD2 WCM.050308	110 €
	SDUM 28 xD2 WCM.050308	110 €
	SDUM 28,5 xD2 WCM.050308	116 €
SDUM 29 xD2 WCM.050308	116 €	
SDUM 29,5 xD2 WCM.050308	116 €	

U-Drills

PRODUCT ПРОДУКТ/продукт	CODE КОДЕ/КОД	PRICE (EURO) PREIS/цена
 <p>ISO</p>	WCMX D2 U-DRILL	
	SDUM 30 xD2 WCM.06T308	120 €
	SDUM 31 xD2 WCM.06T308	120 €
	SDUM 32 xD2 WCM.06T308	120 €
	SDUM 33 xD2 WCM.06T308	120 €
	SDUM 34 xD2 WCM.06T308	120 €
	SDUM 35 xD2 WCM.06T308	120 €
	SDUM 36 xD2 WCM.06T308	120 €
	SDUM 37 xD2 WCM.06T308	120 €
	SDUM 38 xD2 WCM.06T308	129 €
	SDUM 39 xD2 WCM.06T308	129 €
	SDUM 40 xD2 WCM.06T308	129 €
	SDUM 41 xD2 WCM.06T308	129 €
	SDUM 42 xD2 WCM.06T308	129 €
	SDUM 43 xD2 WCM.06T308	129 €
	SDUM 44 xD2 WCM.06T308	129 €
	SDUM 45 xD2 WCM.080412	134 €
	SDUM 46 xD2 WCM.080412	141 €
	SDUM 47 xD2 WCM.080412	141 €
	SDUM 48 xD2 WCM.080412	144 €
	SDUM 49 xD2 WCM.080412	145 €
	SDUM 50 xD2 WCM.080412	156 €
	SDUM 51 xD2 WCM.080412	165 €
	SDUM 52 xD2 WCM.080412	171 €
	SDUM 53 xD2 WCM.080412	178 €
	SDUM 54 xD2 WCM.080412	184 €
	SDUM 55 xD2 WCM.080412	190 €
	SDUM 56 xD2 WCM.080412	200 €
	SDUM 57 xD2 WCM.080412	205 €
	SDUM 58 xD2 WCM.080412	214 €
	SDUM 59 xD2 WCM.080412	220 €
	SDUM 60 xD2 WCM.080412	226 €



U-Drills



PRODUCT ПРОДУКТ/продукт	CODE КОД/КОД	PRICE (EURO) PREIS/цена
ISO	WCMX D3 U-DRILL	
	SDUM 16 xD3 WCM.030208	104 €
	SDUM 16,5 xD3 WCM.030208	104 €
	SDUM 17 xD3 WCM.030208	104 €
	SDUM 17,5 xD3 WCM.030208	104 €
	SDUM 18 xD3 WCM.030208	104 €
	SDUM 18,5 xD3 WCM.030208	104 €
	SDUM 19 xD3 WCM.030208	104 €
	SDUM 19,5 xD3 WCM.030208	104 €
	SDUM 20 xD3 WCM.040208	107 €
	SDUM 20,5 xD3 WCM.040208	107 €
	SDUM 21 xD3 WCM.040208	107 €
	SDUM 21,5 xD3 WCM.040208	107 €
	SDUM 22 xD3 WCM.040208	107 €
	SDUM 22,5 xD3 WCM.040208	107 €
	SDUM 23 xD3 WCM.040208	107 €
	SDUM 23,5 xD3 WCM.040208	107 €
	SDUM 24 xD3 WCM.050308	110 €
	SDUM 24,5 xD3 WCM.050308	110 €
	SDUM 25 xD3 WCM.050308	110 €
	SDUM 25,5 xD3 WCM.050308	110 €
	SDUM 26 xD3 WCM.050308	110 €
	SDUM 26,5 xD3 WCM.050308	110 €
	SDUM 27 xD3 WCM.050308	110 €
SDUM 27,5 xD3 WCM.050308	110 €	
SDUM 28 xD3 WCM.050308	110 €	
SDUM 28,5 xD3 WCM.050308	110 €	
SDUM 29 xD3 WCM.050308	110 €	
SDUM 29,5 xD3 WCM.050308	110 €	

U-Drills

PRODUCT PRODUKT/продукт	CODE CODE/КОД	PRICE (EURO) PREIS/цена
 <p>ISO</p>	WCMX D3 U-DRILL	
	SDUM 30 xD3 WCM.06T308	119 €
	SDUM 31 xD3 WCM.06T308	119 €
	SDUM 32 xD3 WCM.06T308	119 €
	SDUM 33 xD3 WCM.06T308	119 €
	SDUM 34 xD3 WCM.06T308	119 €
	SDUM 35 xD3 WCM.06T308	119 €
	SDUM 36 xD3 WCM.06T308	119 €
	SDUM 37 xD3 WCM.06T308	119 €
	SDUM 38 xD3 WCM.06T308	119 €
	SDUM 39 xD3 WCM.06T308	119 €
	SDUM 40 xD3 WCM.06T308	129 €
	SDUM 41 xD3 WCM.06T308	129 €
	SDUM 42 xD3 WCM.06T308	129 €
	SDUM 43 xD3 WCM.06T308	129 €
	SDUM 44 xD3 WCM.06T308	129 €
	SDUM 45 xD3 WCM.080412	129 €
	SDUM 46 xD3 WCM.080412	138 €
	SDUM 47 xD3 WCM.080412	144 €
	SDUM 48 xD3 WCM.080412	150 €
	SDUM 49 xD3 WCM.080412	156 €
	SDUM 50 xD3 WCM.080412	165 €
	SDUM 51 xD3 WCM.080412	172 €
	SDUM 52 xD3 WCM.080412	181 €
	SDUM 53 xD3 WCM.080412	190 €
	SDUM 54 xD3 WCM.080412	195 €
	SDUM 55 xD3 WCM.080412	205 €
	SDUM 56 xD3 WCM.080412	210 €
	SDUM 57 xD3 WCM.080412	218 €
	SDUM 58 xD3 WCM.080412	227 €
	SDUM 59 xD3 WCM.080412	233 €
	SDUM 60 xD3 WCM.080412	240 €



U-Drills



PRODUCT PRODUKT/продукт	CODE CODE/КОД	PRICE (EURO) PREIS/цена
ISO	WCMX D4 U-DRILL	
	SDUM 16xD4 WCM.030208	140 €
	SDUM 16,5xD4 WCM.030208	140 €
	SDUM 17xD4 WCM.030208	140 €
	SDUM 17,5xD4 WCM.030208	140 €
	SDUM 18xD4 WCM.030208	140 €
	SDUM 18,5xD4 WCM.030208	140 €
	SDUM 19xD4 WCM.030208	140 €
	SDUM 19,5xD4 WCM.030208	140 €
	SDUM 20xD4 WCM.040208	144 €
	SDUM 20,5xD4 WCM.040208	144 €
	SDUM 21xD4 WCM.040208	144 €
	SDUM 21,5xD4 WCM.040208	144 €
	SDUM 22xD4 WCM.040208	144 €
	SDUM 22,5xD4 WCM.040208	144 €
	SDUM 23xD4 WCM.040208	144 €
	SDUM 23,5xD4 WCM.040208	144 €
	SDUM 24xD4 WCM.050308	153 €
	SDUM 24,5xD4 WCM.050308	153 €
	SDUM 25xD4 WCM.050308	153 €
	SDUM 25,5xD4 WCM.050308	153 €
	SDUM 26xD4 WCM.050308	153 €
	SDUM 26,5xD4 WCM.050308	153 €
	SDUM 27xD4 WCM.050308	153 €
	SDUM 27,5xD4 WCM.050308	153 €
	SDUM 28xD4 WCM.050308	153 €
	SDUM 28,5xD4 WCM.050308	153 €
	SDUM 29xD4 WCM.050308	153 €
	SDUM 29,5xD4 WCM.050308	153 €
	SDUM 30xD4 WCM.06T308	162 €
	SDUM 31xD4 WCM.06T308	162 €
	SDUM 32xD4 WCM.06T308	162 €
	SDUM 33xD4 WCM.06T308	162 €
	SDUM 33,5xD4 WCM.06T308	162 €
	SDUM 34xD4 WCM.06T308	162 €
	SDUM 35xD4 WCM.06T308	162 €
	SDUM 36xD4 WCM.06T308	162 €
	SDUM 37xD4 WCM.06T308	162 €
	SDUM 38xD4 WCM.06T308	162 €
	SDUM 38.5xD4 WCM.06T308	162 €
	SDUM 39xD4 WCM.06T308	162 €
	SDUM 40xD4 WCM.06T308	190 €
	SDUM 41xD4 WCM.06T308	190 €
	SDUM 42xD4 WCM.06T308	190 €
	SDUM 43xD4 WCM.06T308	190 €
	SDUM 44xD4 WCM.06T308	190 €
	SDUM 45xD4 WCM.0080412	200 €
	SDUM 46xD4 WCM.0080412	208 €
	SDUM 47xD4 WCM.0080412	218 €
	SDUM 48xD4 WCM.0080412	227 €
SDUM 49xD4 WCM.0080412	240 €	
SDUM 50xD4 WCM.0080412	250 €	

U-Drills

PRODUCT ПРОДУКТ/продукт	CODE КОДЕ/КОД	PRICE (EURO) PREIS/цена
 <p>ISO</p>	WCMX D5 U-DRILL	
	SDUM 16xD5 WCM.030208	178 €
	SDUM 17xD5 WCM.030208	178 €
	SDUM 18xD5 WCM.030208	178 €
	SDUM 19xD5 WCM.030208	178 €
	SDUM 20xD5 WCM.040208	187 €
	SDUM 21xD5 WCM.040208	187 €
	SDUM 22xD5 WCM.040208	187 €
	SDUM 23xD5 WCM.040208	200 €
	SDUM 24xD5 WCM.050308	200 €
	SDUM 25xD5 WCM.050308	200 €
	SDUM 26xD5 WCM.050308	200 €
	SDUM 27xD5 WCM.050308	200 €
	SDUM 28xD5 WCM.050308	211 €
	SDUM 29xD5 WCM.050308	211 €
	SDUM 30xD5 WCM.06T308	211 €
	SDUM 31xD5 WCM.06T308	227 €
	SDUM 32xD5 WCM.06T308	227 €
	SDUM 33xD5 WCM.06T308	227 €
	SDUM 34xD5 WCM.06T308	227 €
	SDUM 35xD5 WCM.06T308	245 €
	SDUM 36xD5 WCM.06T308	245 €
	SDUM 37xD5 WCM.06T308	245 €
	SDUM 38xD5 WCM.06T308	276 €
SDUM 39xD5 WCM.06T308	276 €	
SDUM 40xD5 WCM.06T308	276 €	

PRODUCT ПРОДУКТ/продукт	CODE КОДЕ/КОД	PRICE (EURO) PREIS/цена
 <p>KORLOY/JD</p>	SPMT D2 U-DRILL	
	SDUM 13 xD2 SPMT.050203	98 €
	SDUM 13,5 xD2 SPMT.050203	98 €
	SDUM 14 xD2 SPMT.050203	98 €
	SDUM 14,5 xD2 SPMT.050203	98 €
	SDUM 15 xD2 SPMT.050203	98 €
	SDUM 15,5 xD2 SPMT.050203	98 €
	SDUM 16 xD2 SPMT.060204	98 €
	SDUM 16,5 xD2 SPMT.060204	98 €
	SDUM 17 xD2 SPMT.060204	98 €
	SDUM 17,5 xD2 SPMT.060204	98 €
	SDUM 18 xD2 SPMT.060204	98 €
	SDUM 18,5 xD2 SPMT.060204	98 €
	SDUM 19 xD2 SPMT.060204	98 €
	SDUM 19,5 xD2 SPMT.060204	98 €
	SDUM 20 xD2 SPMT.060204	104 €
	SDUM 20,5 xD2 SPMT.060204	104 €
	SDUM 21 xD2 SPMT.060204	104 €
	SDUM 21,5 xD2 SPMT.060204	104 €
	SDUM 22 xD2 SPMT.070204	107 €
	SDUM 22,5 xD2 SPMT.070204	107 €
	SDUM 23 xD2 SPMT.070204	107 €
	SDUM 23,5 xD2 SPMT.070204	107 €
	SDUM 24 xD2 SPMT.070204	107 €
SDUM 24,5 xD2 SPMT.070204	107 €	
SDUM 25 xD2 SPMT.070204	107 €	



U-Drills



PRODUCT ПРОДУКТ/продукт	CODE КОДЕ/КОД	PRICE (EURO) PREIS/цена
	SPMT D3-U-DRILL	
	SDUM 13 xD3 SPMT 050203	107 €
	SDUM 13,5 xD3 SPMT 050203	107 €
	SDUM 14 xD3 SPMT 050203	107 €
	SDUM 14,5 xD3 SPMT 050203	107 €
	SDUM 15 xD3 SPMT 050203	107 €
	SDUM 15,5 xD3 SPMT 050203	107 €
	SDUM 16 xD3 SPMT 060204	107 €
	SDUM 16,5 xD3 SPMT 060204	107 €
	SDUM 17 xD3 SPMT 060204	107 €
	SDUM 17,5 xD3 SPMT 060204	107 €
	SDUM 18 xD3 SPMT 060204	107 €
	SDUM 18,5 xD3 SPMT 060204	107 €
	SDUM 19 xD3 SPMT 060204	107 €
	SDUM 19,5 xD3 SPMT 060204	107 €
	SDUM 20 xD3 SPMT 060204	110 €
	SDUM 20,5 xD3 SPMT 060204	110 €
	SDUM 21 xD3 SPMT 060204	110 €
	SDUM 21,5 xD3 SPMT 060204	110 €
	SDUM 22 xD3 SPMT 070204	110 €
	SDUM 22,5 xD3 SPMT 070204	110 €
	SDUM 23 xD3 SPMT 070204	110 €
	SDUM 23,5 xD3 SPMT 070204	110 €
	SDUM 24 xD3 SPMT 070204	110 €
	SDUM 24,5 xD3 SPMT 070204	110 €
SDUM 25 xD3 SPMT 070204	116 €	
KORLOY/JD	SPMT D4-U-DRILL	
	SDUM 13 xD4 SPMT 050203	135 €
	SDUM 14 xD4 SPMT 050203	135 €
	SDUM 15 xD4 SPMT 050203	135 €
	SDUM 16 xD4 SPMT 060204	138 €
	SDUM 17 xD4 SPMT 060204	138 €
	SDUM 18 xD4 SPMT 060204	138 €
	SDUM 19 xD4 SPMT 060204	138 €
	SDUM 20 xD4 SPMT 060204	144 €
	SDUM 21 xD4 SPMT 060204	144 €
KORLOY/JD	SDUM 22 xD4 SPMT 070204	144 €
	SDUM 23 xD4 SPMT 070204	144 €
	SDUM 24 xD4 SPMT 070204	144 €
	SDUM 25 xD4 SPMT 070204	156 €

U-Drills

PRODUCT ПРОДУКТ/продукт	CODE КОДЕ/КОД	PRICE (EURO) PREIS/цена
 <p style="text-align: right;">TAEGUTEC</p>	SPMG D2 U-DRILL	
	SDUM 12,5 xD2 SPMG 050204	107 €
	SDUM 13 xD2 SPMG 050204	107 €
	SDUM 13,5 xD2 SPMG 050204	107 €
	SDUM 14 xD2 SPMG 050204	107 €
	SDUM 14,5 xD2 SPMG 050204	107 €
	SDUM 15 xD2 SPMG 050204	107 €
	SDUM 15,5 xD2 SPMG 060204	107 €
	SDUM 16 xD2 SPMG 060204	107 €
	SDUM 16,5 xD2 SPMG 060204	107 €
	SDUM 17 xD2 SPMG 060204	107 €
	SDUM 17,5 xD2 SPMG 060204	107 €
	SDUM 18 xD2 SPMG 060204	107 €
	SDUM 18,5 xD2 SPMG 060204	107 €
	SDUM 19 xD2 SPMG 060204	107 €
	SDUM 19,5 xD2 SPMG 060204	107 €
	SDUM 20 xD2 SPMG 060204	107 €
	SDUM 20,5 xD2 SPMG 060204	107 €
	SDUM 21 xD2 SPMG 060204	107 €
	SDUM 21,5 xD2 SPMG 060204	107 €
	SDUM 22 xD2 SPMG 07T308	107 €
	SDUM 22,5 xD2 SPMG 07T308	107 €
	SDUM 23 xD2 SPMG 07T308	107 €
	SDUM 23,5 xD2 SPMG 07T308	107 €
	SDUM 24 xD2 SPMG 07T308	107 €
	SDUM 24,5 xD2 SPMG 07T308	107 €
SDUM 25 xD2 SPMG 07T308	107 €	
SDUM 25,5 xD2 SPMG 07T308	114 €	
SDUM 26 xD2 SPMG 07T308	114 €	



U-Drills



PRODUCT ПРОДУКТ/продукт	CODE КОД/КОД	PRICE (EURO) PREIS/цена
	SPMG D2 U-DRILL	
	SDUM 26,5 xD2 SPMG 07T308	114 €
	SDUM 27 xD2 SPMG 07T308	114 €
	SDUM 27,5 xD2 SPMG 07T308	114 €
	SDUM 28 xD2 SPMG 090408	114 €
	SDUM 28,5 xD2 SPMG 090408	114 €
	SDUM 29 xD2 SPMG 090408	114 €
	SDUM 29,5 xD2 SPMG 090408	114 €
	SDUM 30 xD2 SPMG 090408	123 €
	SDUM 31 xD2 SPMG 090408	123 €
	SDUM 32 xD2 SPMG 090408	123 €
	SDUM 33 xD2 SPMG 090408	123 €
	SDUM 34 xD2 SPMG 110408	123 €
	SDUM 35 xD2 SPMG 110408	123 €
	SDUM 36 xD2 SPMG 110408	123 €
	SDUM 37 xD2 SPMG 110408	123 €
	SDUM 38 xD2 SPMG 110408	123 €
	SDUM 39 xD2 SPMG 110408	123 €
	SDUM 40 xD2 SPMG 110408	123 €
	SDUM 41 xD2 SPMG 110408	128 €
	SDUM 42 xD2 SPMG 140512	128 €
	SDUM 43 xD2 SPMG 140512	128 €
	SDUM 44 xD2 SPMG 140512	128 €
	SDUM 45 xD2 SPMG 140512	135 €
	SDUM 46 xD2 SPMG 140512	141 €
	SDUM 47 xD2 SPMG 140512	144 €
	SDUM 48 xD2 SPMG 140512	150 €
	SDUM 49 xD2 SPMG 140512	156 €
TAEGUTEC	SDUM 50 xD2 SPMG 140512	165 €

U-Drills

PRODUCT ПРОДУКТ/продукт	CODE КОДЕ/КОД	PRICE (EURO) PREIS/цена
 <p>SPMG D3 U-DRILL</p> <p>TAEGUTEC</p>	SDUM 12,5 xD3 SPMG 050204	114 €
	SDUM 13 xD3 SPMG 050204	114 €
	SDUM 13,5 xD3 SPMG 050204	114 €
	SDUM 14 xD3 SPMG 050204	114 €
	SDUM 14,5 xD3 SPMG 050204	114 €
	SDUM 15 xD3 SPMG 050204	114 €
	SDUM 15,5 xD3 SPMG 060204	114 €
	SDUM 16 xD3 SPMG 060204	114 €
	SDUM 16,5 xD3 SPMG 060204	114 €
	SDUM 17 xD3 SPMG 060204	114 €
	SDUM 17,5 xD3 SPMG 060204	114 €
	SDUM 18 xD3 SPMG 060204	114 €
	SDUM 18,5 xD3 SPMG 060204	114 €
	SDUM 19 xD3 SPMG 060204	114 €
	SDUM 19,5 xD3 SPMG 060204	114 €
	SDUM 20 xD3 SPMG 060204	178 €
	SDUM 20,5 xD3 SPMG 060204	178 €
	SDUM 21 xD3 SPMG 060204	178 €
	SDUM 21,5 xD3 SPMG 060204	178 €
	SDUM 22 xD3 SPMG 07T308	178 €
	SDUM 22,5 xD3 SPMG 07T308	178 €
	SDUM 23 xD3 SPMG 07T308	178 €
	SDUM 23,5 xD3 SPMG 07T308	178 €
	SDUM 24 xD3 SPMG 07T308	178 €
	SDUM 24,5 xD3 SPMG 07T308	178 €
	SDUM 25 xD3 SPMG 07T308	123 €
SDUM 25,5 xD3 SPMG 07T308	123 €	
SDUM 26 xD3 SPMG 07T308	123 €	



U-Drills



PRODUCT ПРОДУКТ/продукт	CODE КОДЕ/КОД	PRICE (EURO) PREIS/цена
SPMG D3 U-DRILL		
	SDUM 26,5 xD3 SPMG 07T308	121 €
	SDUM 27 xD3 SPMG 07T308	121 €
	SDUM 27,5 xD3 SPMG 07T308	121 €
	SDUM 28 xD3 SPMG 090408	121 €
	SDUM 28,5 xD3 SPMG 090408	121 €
	SDUM 29 xD3 SPMG 090408	121 €
	SDUM 29,5 xD3 SPMG 090408	121 €
	SDUM 30 xD3 SPMG 090408	125 €
	SDUM 31 xD3 SPMG 090408	125 €
	SDUM 32 xD3 SPMG 090408	125 €
	SDUM 33 xD3 SPMG 090408	125 €
	SDUM 34 xD3 SPMG 110408	125 €
	SDUM 35 xD3 SPMG 110408	125 €
	SDUM 36 xD3 SPMG 110408	125 €
	SDUM 37 xD3 SPMG 110408	125 €
	SDUM 38 xD3 SPMG 110408	125 €
	SDUM 39 xD3 SPMG 110408	125 €
	SDUM 40 xD3 SPMG 110408	125 €
	SDUM 41 xD3 SPMG 110408	138 €
	SDUM 42 xD3 SPMG 140512	138 €
	SDUM 43 xD3 SPMG 140512	138 €
	SDUM 44 xD3 SPMG 140512	138 €
	SDUM 45 xD3 SPMG 140512	138 €
	SDUM 46 xD3 SPMG 140512	145 €
	SDUM 47 xD3 SPMG 140512	150 €
	SDUM 48 xD3 SPMG 140512	156 €
	SDUM 49 xD3 SPMG 140512	163 €
	SDUM 50 xD3 SPMG 140512	169 €
	SDUM 51 xD3 SPMG 140512	178 €
	SDUM 52 xD3 SPMG 140512	184 €
	SDUM 53 xD3 SPMG 140512	190 €
	SDUM 54 xD3 SPMG 140512	205 €
	SDUM 55 xD3 SPMG 140512	205 €
	SDUM 56 xD3 SPMG 140512	205 €
	SDUM 57 xD3 SPMG 140512	220 €
	SDUM 58 xD3 SPMG 140512	220 €
	SDUM 59 xD3 SPMG 140512	220 €
	SDUM 60 xD3 SPMG 140512	220 €

TAEGUTEC

U-Drills

PRODUCT ПРОДУКТ/продукт	CODE КОДЕ/КОД	PRICE (EURO) PREIS/цена
	SPMG D4 U-DRILL	
	SDUM 13xD4 SPMG 050204	141 €
	SDUM 13.5xD4 SPMG 050204	141 €
	SDUM 14xD4 SPMG 050204	141 €
	SDUM 14.5xD4 SPMG 050204	141 €
	SDUM 15xD4 SPMG 050204	141 €
	SDUM 15.5xD4 SPMG 060204	141 €
	SDUM 16xD4 SPMG 060204	145 €
	SDUM 16.5xD4 SPMG 060204	145 €
	SDUM 17xD4 SPMG 060204	145 €
	SDUM 17.5xD4 SPMG 060204	145 €
	SDUM 18xD4 SPMG 060204	145 €
	SDUM 18.5xD4 SPMG 060204	145 €
	SDUM 19xD4 SPMG 060204	145 €
	SDUM 19.5xD4 SPMG 060204	145 €
	SDUM 20xD4 SPMG 060204	145 €
	SDUM 20.5xD4 SPMG 060204	145 €
	SDUM 21xD4 SPMG 060204	150 €
	SDUM 21.5xD4 SPMG 060204	150 €
	SDUM 22xD4 SPMG 07T308	150 €
	SDUM 22.5xD4 SPMG 07T308	150 €
	SDUM 23xD4 SPMG 07T308	150 €
	SDUM 23.5xD4 SPMG 07T308	150 €
	SDUM 24xD4 SPMG 07T308	150 €
	SDUM 24.5xD4 SPMG 07T308	150 €
	SDUM 25xD4 SPMG 07T308	150 €
	SDUM 25.5xD4 SPMG 07T308	150 €
	SDUM 26xD4 SPMG 07T308	166 €
	SDUM 26.5xD4 SPMG 07T308	166 €
	SDUM 27xD4 SPMG 07T308	166 €
	SDUM 27.5xD4 SPMG 07T308	166 €
	SDUM 28xD4 SPMG 090408	166 €
	SDUM 28.5xD4 SPMG 090408	166 €
	SDUM 29xD4 SPMG 090408	166 €
	SDUM 29.5xD4 SPMG 090408	166 €
	SDUM 30xD4 SPMG 090408	166 €
	SDUM 31xD4 SPMG 090408	178 €
	SDUM 32xD4 SPMG 090408	178 €
	SDUM 33xD4 SPMG 090408	178 €
	SDUM 33.5xD4 SPMG 090408	178 €
	SDUM 34xD4 SPMG 110408	178 €
	SDUM 35xD4 SPMG 110408	178 €
	SDUM 36xD4 SPMG 110408	178 €
	SDUM 37xD4 SPMG 110408	190 €
SDUM 38xD4 SPMG 110408	190 €	
SDUM 39xD4 SPMG 110408	190 €	
SDUM 40xD4 SPMG 110408	190 €	
SDUM 41xD4 SPMG 110408	196 €	
SDUM 42xD4 SPMG 140512	196 €	
SDUM 43xD4 SPMG 140512	196 €	
SDUM 44xD4 SPMG 140512	196 €	

TAEGUTEC



U-Drills



PRODUCT ПРОДУКТ/продукт	CODE КОД/КОД	PRICE (EURO) ПРЕИС/цена
SPMG D5 U-DRILL		
	SDUM 13xD5 SPMG 050204	150 €
	SDUM 14xD5 SPMG 050204	150 €
	SDUM 15xD5 SPMG 050204	150 €
	SDUM 16xD5 SPMG 060204	178 €
	SDUM 17xD5 SPMG 060204	178 €
	SDUM 18xD5 SPMG 060204	178 €
	SDUM 19xD5 SPMG 060204	178 €
	SDUM 20xD5 SPMG 060204	187 €
	SDUM 21xD5 SPMG 060204	187 €
	SDUM 22xD5 SPMG 07T308	187 €
	SDUM 23xD5 SPMG 07T308	200 €
	SDUM 24xD5 SPMG 07T308	200 €
	SDUM 25xD5 SPMG 07T308	200 €
	SDUM 26xD5 SPMG 07T308	200 €
	SDUM 27xD5 SPMG 07T308	200 €
	SDUM 28xD5 SPMG 090408	211 €
	SDUM 29xD5 SPMG 090408	211 €
	SDUM 30xD5 SPMG 090408	211 €
	SDUM 31xD5 SPMG.090408	227 €
	SDUM 32xD5 SPMG.090408	227 €
SDUM 33xD5 SPMG.090408	227 €	
SDUM 34xD5 SPMG.110408	227 €	
SDUM 35xD5 SPMG.110408	245 €	
SDUM 36xD5 SPMG.110408	245 €	
SDUM 37xD5 SPMG.110408	245 €	
SDUM 38xD5 SPMG.110408	276 €	
SDUM 39xD5 SPMG.110408	276 €	
SDUM 40xD5 SPMG.110408	276 €	

TAEGUTEC

Center Tools















PRODUCT ПРОДУКТ/продукт	CODE КОДЕ/КОД	PRICE (EURO) PREIS/цена
	CNC PUNTA	
	20x20 2.5x6 CNC PUNTA	40 €
	25x25 2.5x6 CNC PUNTA	49 €
	20x20 3.15x8 CNC PUNTA	40 €
	25x25 3.15x8 CNC PUNTA	49 €
	20x20 4x10 CNC PUNTA	40 €
	25x25 4x10 CNC PUNTA	49 €

PRODUCT ПРОДУКТ/продукт	CODE КОДЕ/КОД	PRICE (EURO) PREIS/цена
	CNC TIRTIR	
	25x25 CNC TIRTIR KATERİ	49 €
	20x20 CNC TIRTIR KATERİ	43 €

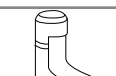
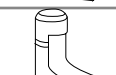

YEDEK PARÇALAR

Spare Parts

	PRODUCT CODE PRODUKT CODE продукт КОДС	BASKI PABUÇLARI / CLAMP PARTS	PRICE (EURO) PREIS/цена
	TSK-1	DNMG 15, CNMG 12,WNMG 08, SNMG 12 PABUÇ / CLAMP	4,5 €
	TSK-2	DNMG 11 PABUÇ / CLAMP	4 €
	TSK-3	CNMG 16, SNMG 15 PABUÇ / CLAMP	5,50 €
	TSK-4	CNMG 19 PABUÇ / CLAMP	6,50 €
	TSK-5	VNMG 16 PABUÇ / CLAMP	4,5 €
	MSK-1	TNMG 16,22 PABUÇ / CLAMP	4,5 €
	MSK-2	TNMG 16 (S20R MTUN.. PABUÇ / CLAMP	4 €
	MSK-3	WNMG 08 PABUÇ / CLAMP	4,5 €
	MSK-4	WNMG 06 PABUÇ / CLAMO	4 €
	CSK	KNUX 16 S25 CKUN.. PABUÇ / CLAMP	4,5 €
	CSK/R	KNUX 16-R PABUÇ / CLAMP	4,5 €
	CSK/L	KNUX 16-L PABUÇ / CLAMP	4,5 €
	CSK1	DNMG15, CNMG12, TNMG16	4,5 €
	SPL-1	DNMG 15, CNMG 12,WNMG 08, SNMG 12 LEVYE / LEVER	4,5 €
	SPL-2	CNMG 16, SNMG 15 LEVYE / LEVER	4,5 €
	SPL-3	CNMG 19 LEVYE / LEVYE	4,5 €

YEDEK PARÇALAR

Spare Parts

	PRODUCT CODE PRODUKT CODE продукт КОДЏ	BASKI PABUÇ VİDALARI / CLAMP SCREW	
	TSBV M5X23,5	DNMG-11,WNMG-06,TNMG 16 BASKI VİDALI/CLAP SCREW	1,50 €
	TSBV M5X25	DNMG 11,WNMG 06,TNMG 16 BASKI VİDALI/CLAP SCREW	1,50 €
	TSBV M6X30	DNMG 15,WNMG 08,TNMG 16-22,CNMG 12, VNMG 16 PABUÇ VİDALI / CLAMP SCREW	1,50 €
	TSBV M6X30X7	CNMG 16 BASKI VİDALI/CLAMP SCREW	1,50 €
	TSBV M8X30	CNMG 19 BASKI VİDALI/CLAMP SCREW	3,00 €
	CSBV M6X30	KNUX-R/L 16 BASKI VİDALI / CLAMP SCREW	0,50 €
	SLV1 M8X20	DNMG 15, CNMG 12, SNMG 12, WNMG 08 LEVYE VİDALI/ LEVER SCREW	5 €
	SLV1 M8X22	CNMG 16, SNMG 15 LEVYE VİDALI/LEVER SCREW	5 €
	SLV1 M10X20	CNMG 19 LEVYE VİDALI/LEVER SCREW	5 €
	BKTV M4X10	16 LİK İÇ VE DIŞ KANAL TAKIM VİDALI/ FOR 16 INTERNAL AND EXTERNAL GROOVING SCREW	0,50 €
	BKTV M5X12	20 LİK İÇ VE DIŞ KANAL TAKIM VİDALI/ FOR 20 INTERNAL AND EXTERNAL GROOVING SCREW	0,50 €
	BKTV M6X25	25 LİK İÇ VE DIŞ KANAL TAKIM VİDALI/ FOR 25 INTERNAL AND EXTERNAL GROOVING SCREW	0,50 €
	BKTV M8X30	32 LİK İÇ VE DIŞ KANAL TAKIM VİDALI/ FOR 32 INTERNAL AND EXTERNAL GROOVING SCREW	1,50 €
	TPBV 6X10	TPKN 16 BASKI VİDALI / TPKN 16 CLAMP SCREW	3 €
	TPBV 8X10	TPKN 22 BASKI VİDALI / TPKN 22 CLAMP SCREW	3 €
	TKBP-1	OFER 07 BASKI PABUCU / OFER 07 CLAMP	5 €

YEDEK PARÇALAR















Spare Parts

	PRODUCT CODE PRODUKT CODE продукт КОДС	KÜRE PARMAK FREZE VİDALARI / BALL NOSE END MILLS SCREW	
	TC170 3X7	BSRT P3208 VİDASI / BSRT P3208 SCREW	6,50 €
	TC172 4X0,5X9	BSRT P3210 VİDASI / BSRT P3210 SCREW	6,50 €
	TC174 5X0,5X9	BSRT P3212 VİDASI / BSRT P3212 SCREW	6,50 €
	TC176 5X0,5X12	BSRT P3216 VİDASI / BSRT P3216 SCREW	6,50 €
	TC178 5X0,5X12	BSRT P3220 VİDASI / BSRT P3220 SCREW	6,50 €
	TC181 6X0,75X20	BSRT P3225 VİDASI / BSRT P3225 SCREW	6,50 €
	TC184 8X,75X24	BSRT P3232 VİDASI / BSRT P3232 SCREW	6,50 €

	PRODUCT CODE PRODUKT CODE продукт КОДС	Details	
	SNSV	PUNTA TAKIMI VİDASI / CENTER TOOLS SCREW	1,50 €
	BMP 1	TNMG 16 PİM/PIN	1,50 €
	BMP 2	TNMG 22 PİM/PIN	1,50 €
	BMP 3	WNMG 08 PİM/PIN	1,50 €
	SLAY1	DNMG 15, CNMG 12, SNMG 12, WNMG 08 ALTLIK YAYI/SHIM SPRING	0,50 €
	SLAY2	CNMG 16, SNMG 15 ALTLIK YAYI, SHIM SPRING	0,50 €
	SLAY3	CNMG 16 ALTLIK YAYI/SHIM SPRING	0,50 €

YEDEK PARÇALAR

Spare Parts

	PRODUCT CODE PRODUKT CODE	ALTLIKLAR / SHIMS	
	BAX DN11	DNMG 11 ALTLIK/SHIM	4,50 €
	BAX DN15	DNMG 15 ALTLIK/SHIM	4,50 €
	BAX CN12	CNMG 12 ALTLIK/SHIM	4,50 €
	BAX CN16	CNMG 16 ALTLIK/SHIM	6,50 €
	BAX CN19	CNMG 19 ALTLIK/SHIM	10 €
	BAX WN08	WNMG 08 ALTLIK/SHIM	5,50 €
	BAX SN12	SNMG 12 ALTLIK/SHIM	4,50 €
	BAX SN15	SNMG 15 ALTLIK/SHIM	5 €
	BAX TN16	TNMG 16 ALTLIK/SHIM	5,50 €
	BAX TN22	TNMG 22 ALTLIK/SHIM	11,50 €
	BAX VN16	VNMG 16 ALTLIK/SHIM	5,50 €
	BAX DC11	DCMT 11 ALTLIK/SHIM	4,50 €
	BAX SC09	SCMT 09 ALTLIK/SHIM	4,50 €
	BAX SC12	SCMT 12 ALTLIK/SHIM	4,50 €
	BAX CC09	CCMT 09 ALTLIK/SHIM	4,50 €
	BAX CC12	CCMT 12 ALTLIK/SHIM	4,50 €
	BAX VB16	VBMT 16 ALTLIK/SHIM	5,50 €
	BAX TC16	TCMT 16 ALTLIK/SHIM	5,50 €
	BAX VC16	VCMT 16 ALTLIK/SHIM	5,50 €
	BAX KN16-R/L	KNUX 16-R/L ALTLIK/SHIM	4,50 €







YEDEK PARÇALAR













Spare Parts

	PRODUCT CODE PRODUKT CODE продукт КОДС	S SİSTEM VİDALAR / S SYSTEM SCREWS	
	SSV M2X4		0,50 €
	SSV M2,2X6		0,50 €
	SSV M2.5X7		0,50 €
	SSV M3X9		0,50 €
	SSV M3.5X9		0,50 €
	SSV M3.5X11		0,50 €
	SSV M3.5X14		0,50 €
	SSV M4X9		1,50 €
	SSV M4X11		0,50 €
	SSV M4X15		1,50 €
	SSV M5X12		1,50 €
	SSV M2X4 (ORJINAL)		1,50 €
	SSV M2,2X6 (ORJINAL)		1,50 €
	SSV M2.5X7 (ORJINAL)		1,50 €
	SSV M3X9 (ORJINAL)		1,50 €
	SSV M3.5X9 (ORJINAL)		1,50 €
	SSV M3.5X11 (ORJINAL)		1,50 €

YEDEK PARÇALAR

Spare Parts

	PRODUCT CODE PRODUKT CODE продукт КОДС	ALTLIK VİDALARI / SHIM SCREWS	
	TSAV-M4X10	DNMG 15, CNMG 12, SNMG 12, VNMG 16, WNMG 08 ALTLIK VİDASI / SHIM SCREW	0,50 €
	TSAV-M6X10X9	CNMG16, SNMG 15, ALTLIK VİDASI / SHIM SCREW	0,50 €
	TSAV-M6X11X9	CNMG 19	0,50 €
	SBV-M5X05 A3.15X11	DCMT 11, VBMT 16, SCMT 09, CCMT 09, TCMT 16, ER/L 16	2,00 €
	SBV-M6X0,75 A4,5X11	SCMT 12, CCMT 12, ER/L 22	3,00 €
	CSP 6.5x12	PUL/STAMP	0,50 €
	CSS1	SEKMAN / RING	1,50 €

	PRODUCT CODE PRODUKT CODE продукт КОДС	TORK VE ALYAN ANAHTARLAR / TORX AND ALLEN KEYS	
	T06	TORK ANAHTAR / TORX KEYS	0,50 €
	T07	TORK ANAHTAR / TORX KEYS	0,50 €
	T08	TORK ANAHTAR / TORX KEYS	0,50 €
	T15	TORK ANAHTAR / TORX KEYS	1,50 €
	T20	TORK ANAHTAR / TORX KEYS	1,50 €
	AA1,5	ALYAN ANAHTAR / ALLEN KEYS	0,50 €
	AA2	ALYAN ANAHTAR / ALLEN KEYS	0,50 €
	AA2,5	ALYAN ANAHTAR / ALLEN KEYS	1,25 €
	AA3	ALYAN ANAHTAR / ALLEN KEYS	0,50 €
	AA4	ALYAN ANAHTAR / ALLEN KEYS	1,00 €
	AA5	ALYAN ANAHTAR / ALLEN KEYS	1,50 €
	AA6	ALYAN ANAHTAR / ALLEN KEYS	1,50 €