

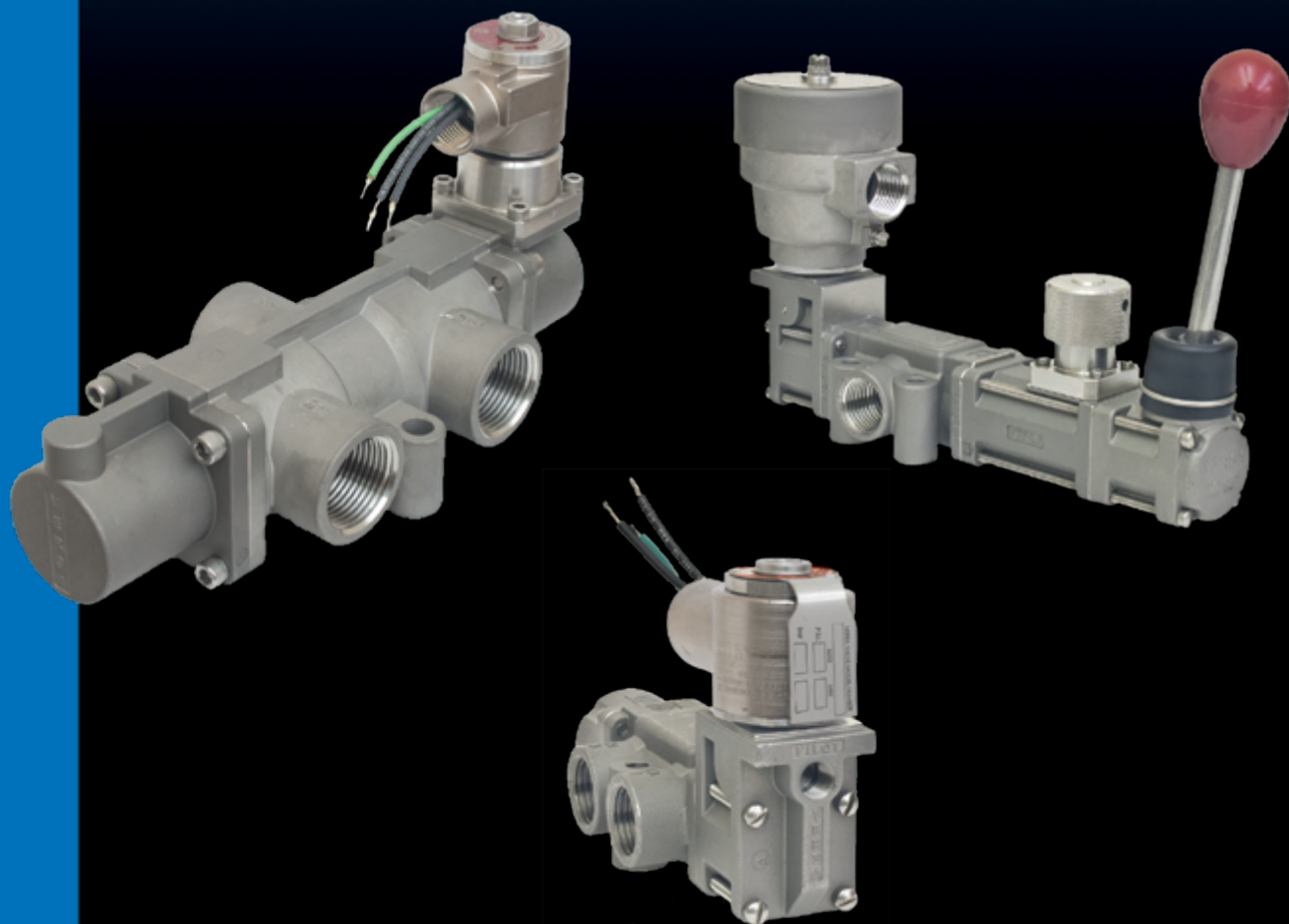

V-316 SERIES



VALVES/ACTUATORS

	Section	Page
Three-Way Valves	general V 3-WAY	14 - 15
.....	dimensions V 3-WAY	16 - 19
Four-Way Valves	general V 4-WAY	20 - 21
.....	dimensions V 4-WAY	22 - 25
Actuating Devices		10 - 13
Latching-Manual Reset Valves		30 - 31
Lockout Valves/Indicating Palm Button		33
Special Purpose Dual Solenoid Valves		28 - 29
VMAP		34

SPECIFICATIONS

Basic Features		3
Construction		6
Electrical		7 - 9
Electrical Combination Suffix Details (Cross Reference)		35
Filtration		6
Flow (Cv/Kv)		7
Port Sizes		6
Pressure Ranges		6
Product Numbering System		4 - 5
Seals		6
Temperature		6
Stainless Steel Tags		13

PARTS

Combination Actuators		26 - 27
-----------------------------	--	---------

WARNINGS & WARRANTY	Back Cover
--------------------------------------	------------

Versa exercises diligence to assure that information contained in this catalog is correct, but does not accept responsibility for any errors or omissions. Versa also reserves the right to change or delete data or products at any time without prior notification. To be sure the data you require is correct, consult factory.

GENERAL CHARACTERISTICS OF SERIES “V-316” VALVES

The V-316 Valve Series provides a full range of control valves suited to the most demanding of applications. Ruggedly constructed, both internally and externally, of stainless steel, these valves are able to withstand the physical abuse of corrosive environments and controlled media.

A modular design concept utilizing three basic sub-assemblies: a Body Assembly and two Actuator Assemblies (active or passive), simplifies circuit planning while affording almost unlimited combination possibilities.

Port sizes 1/4”, 3/8”, and 1/2” NPT are 2 and 3-position, three-way (3/2, 3/3), and four-way (5/2 and 5/3) styles. 3/4” and 1” NPT are available as 2-position, three-way (3/2) and four-way (5/2).

Actuation types include manual (hand lever, palm button, latching detent & manual reset), pilot (pressure pilot, diaphragm pilot, “air-latch” pilot), and solenoid-pilot (including several approved hazardous service types).

CONSTRUCTION

High Performance Solenoid

Near frictionless direct acting poppet design yields positive shifting and the lowest solenoid power/wattage ratings. Epoxy encapsulated coils with high heat class ratings are standard for moisture resistance, heat dissipation and elevated temperature applications.

Solenoid-Pilot Design

Direct acting valve integrated on pilot valve
The V-316 Series solenoid valve utilizes a high performance solenoid-pilot design. This design utilizes available media pressure/force to shift valve assuring positive shifting. This design also produces the lowest wattage ratings in the industry.



Large Diameter Pilot

The Pilot design is maximized to offer positive shifting throughout range while residual volume is reduced for less air per shift. A U-cup is utilized for bubble tight sealing while reducing shift friction to a minimum.

Elastomer Packed Spool

“Low friction” type seals are utilized to offer bubble tight sealing throughout valve operation range.

Balanced Spool

The forces required to actuate the plunger are unaffected by pressure being controlled assuring positive shifting throughout the entire pressure range.

Investment Cast Stainless Steel

316 stainless steel components are utilized for superior corrosion protection in the harshest environments. Investment cast components offer a first class finish, while providing weight savings and maximized flow paths for superior flow.

Full Flow - Over Ported

Internal high flow area through valve is maximized so user is assured the fitting will reduce flow not the Versa valve.

Spring Return Device

Versa’s V-316 Series spring return valves offer the strongest spring return ratings on the market assuring a positive shift when valve is commanded to shift.

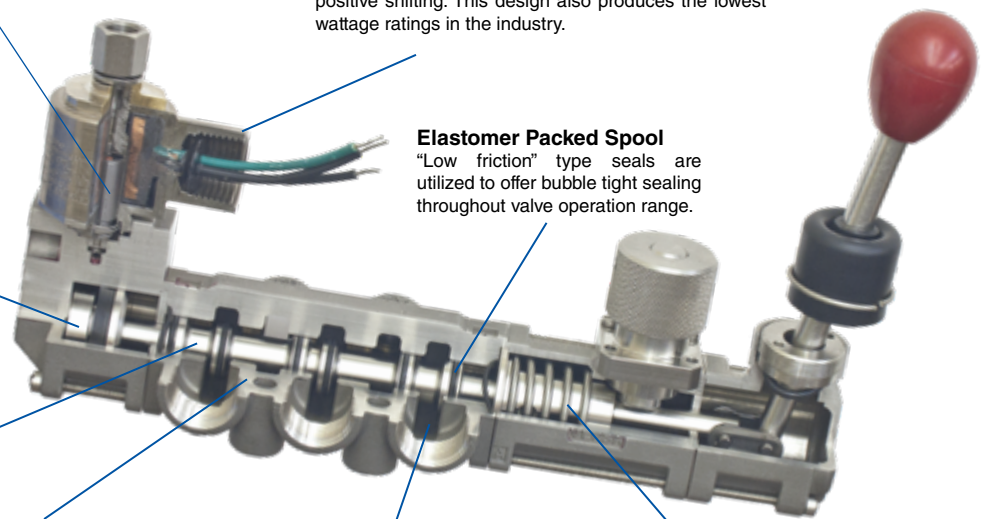

EVERY VALVE FUNCTIONALLY TESTED THROUGHOUT COMPLETE PRESSURE RANGE BEFORE SHIPPING

COMPATIBILITY & APPLICATION RANGE: Series V-316 valves are designed for the control of pneumatic pressures from partial vacuum to 200 psi (14 bar). Because Versa uses various styles and compounds of elastomers, it is possible to meet varying conditions of media and temperature.

Limitations generally apply to specific types of actuation, such as solenoid or pilot. The minimum and maximum pressures in these cases are dependent upon valve size, method of return actuation, valve series, and range of pressure being controlled. For specific information, refer to specification pages 6 thru 9.

HOW TO SELECT A VERSA VALVE



Every letter and digit in the product number has significant meaning. The product number shown below (VSG-4522-316-L14-A120) indicates the following:

V	S	G	-	4	5	2	2	-	316	-	L14	-	A120
PNEUMATIC SERVICE	SPRING RETURN	SOLENOID PILOT-ACTUATED		FOUR-WAY	1/2" NPT	SIDE PORTED (INPILOT)	TWO POSITION		316 STAINLESS STEEL		SOLENOID OPERATOR EQUIPPED WITH DUST EXCLUDER NUT		120V60 COIL

BASIC PRODUCT NUMBER

V	S	G	-	4	5
		ON LEFT END OF VALVE LOOKING AT INLET	ON RIGHT END OF VALVE LOOKING AT INLET		
V-316 Series Valve Pneumatic service to 200 psi (14 bar)	<ul style="list-style-type: none"> A Special actuator of any type. Letter indicates position of actuator relative to right and left end of body. Suffix detail is required to designate specific actuator B Spring Centering (for 3 position manually operated valves) C Cam Actuator G Solenoid-Pilot/2 position I Palm Button J Pilot-Spring Centering (for 3 position pilot operated valves) L Hand Lever (centerline lever) N Non-return Device (for manually operated valves — allows valve to be positioned anywhere without detents) P Pressure Pilot/2 position R Reverse Spring Return (for manually operated valves). Spring pulls valve spool S Spring Return. Spring pushes valve spool U Three-Detent (for manually operated valves) W Diaphragm-Pilot (low pressure-pilot) X Solenoid-Pilot Spring Centering (for 3 position solenoid operated valves) Z 2-Position Detent (for 2-position manually operated valves) 	<ul style="list-style-type: none"> 2 Two-Way* 3 Three-Way 4 Four-Way 7 Two-Outlet (Directional Three-Way-Diverter) 8 Two-Inlet (Directional Three-Way-Selector) <p>* Two-Way is accomplished by plugging the exhaust port of a three-way valve</p>	<ul style="list-style-type: none"> 3 ¼" NPT 4 ⅜" NPT 5 ½" NPT *6 ¾" NPT *7 1" NPT <p>*3/4" 1" valve Actuators Available (C, G, L, N, P, S, & X)</p>		

SUFFIX DETAILS

Suffix details indicate modifications or variations to the basic valve. When specifying simply add those suffix details required in alphabetical and/or numerical order.

Listed below are the suffix detail modifications found in this catalog and the page on which they are noted.

2		2 - 316 -		L14		- COIL CODE
BODY DETAILS	SPOOL DETAILS (Flow patterns)			SUFFIX DETAILS		
<p>0 SIDEPORTED-EXPILOT Body with integral, pipe threaded ports. This type of body is directly connected to pressure lines and is used for mechanical, manual and EXPilot* type solenoid or pilot actuated valves.</p> <p>2 SIDEPORTED - INPILOT Body same as "0" above, except it has an auxiliary internal passage to supply INPilot** type solenoid and pilot actuators.</p> <p>*Separate pressure line connection needed to supply solenoid-pilot.</p> <p>**Internal auxiliary porting supplies pressurized medium being controlled to pilot, solenoid- pilot..</p>	<p>THREE-WAY VALVES Two Position</p> <p>1 Normally Closed (actuating device must be on right end of valve)</p> <p>2 Normally Open (actuating device must be on left end of valve)</p> <p>THREE-WAY VALVES Three Position</p> <p>3 All ports blocked in center position</p> <p>FOUR-WAY VALVES Two Position</p> <p>2 Standard flow pattern: inlet alternately open to one cylinder port; opposite cylinder port alternately open to exhaust.</p> <p>FOUR-WAY Three Position (Offset flows as standard flow patterns, above)</p> <p>Center Position</p> <p>3 All ports blocked</p> <p>4 Cylinder ports open to exhaust</p> <p>DIVERTER & SELECTOR VALVES</p> <p>2 2-position</p> <p>3 All ports blocked in center position</p>	<p>"316" indicates that the basic construction material for valve parts is AISI 316 Stainless Steel (conforms to NACE Standard MR-01-75)</p>		<p>Actuator Orientation: -218A thru -218C, Hand Lever, page 10 -227A thru -227C, Pilot actuator, page 12</p> <p>Combination Actuators: Button actuated, page 26 Hand actuated, page 26 Latching resets, page 30 Pilot actuated, page 27 Solenoid-pilot actuated, page 27</p> <p>Solenoid Options: For General Purpose (Page 7-9): -HC, -HCC, DIN connector, -HT, Class H coil -PC, -PS, Potted coil</p> <p>For Hazardous Service (Page 7-9): -XX, Hazardous locations, UL & CSA -XN, (d)Flameproof, ATEX -LB, Low Power, 1.8 Watt -LA, Low Power, 0.85 Watt -HT, Class H coil, -PC, Potted coil, -ST, Stainless steel housing, -XISX6 (ib)Intrinsic Safe, ATEX FM & CSA -HC, -HCC, Connector for IS</p> <p>Popular Option Combo's for Hazardous Service: -XXN, Hazardous, weather protected, UL/CSA (-LB, -PC, -XX) -XXJ, Hazardous, enhanced weather protected, UL/CSA (-LB, -PC, -ST, -XX) -XNN, Hazardous, weather protected, ATEX (-LB, -PC, -XN) -XNJ, Hazardous, enhanced weather protected, ATEX (-LB, -PC, -ST, -XN)</p> <p>For Hazardous Service WITH INTEGRAL Junction Box (Page 7-9): -XDBS, -XD BT, (d)Flameproof, ATEX, IEC, CSA, INMETRO -XIFA, -XIFE, -XIFF, (ib)Intrinsic Safe, ATEX -XMAA, -XMAE, -XMAF, (m)Encapsulation, (e)Increased Safety, ATEX -XMFA, -XMFE, -XMFF, (m)Encapsulation, (e)Increased Safety, ATEX</p> <p>Manual Override (page 13): -ME, Unguarded</p> <p>Seals: -44, Low temp Buna page 6 -155, Fluorocarbon FKM, page 6</p> <p>Special service/lubrication: -DG, Dust Proof -D14, Dust excluder, page 13 -L14, Silencer/dustproof coil cover nut, page 13 -55A, FDA approved silicone grease -55M, Silicone grease -200E, Plus pressure rating to 200 psi (14 bar), page 6 -PPR, Plus pressure rating to 300 psi (20.7 bar), page 6 -H, Threaded solenoid exhaust, page 13 -NGS, Natural Gas Service -NGST, Natural Gas Service – Low Temperature</p> <p>Tagging: -NV28A, Stainless steel ID tag; see Product Bulletin 181 page 13</p>	<p>Solenoid actuated valves require a Coil Code that indicates the specific coil current/frequency and voltage.</p> <p>The Coil Code consists of a letter to indicate the current frequency:</p> <p>Rating Code: A= 60Hz frequency D= Direct Current (DC) E= 50Hz frequency</p> <p>Three numbers follow the Rating Code to indicate voltage:</p> <p>Examples: Voltage Code 24V60 = A024 120V60 = A120 24VDC = D024</p> <p>See Page 7 for specific coil and codes.</p>	

PORT SIZE - FLOW

Port Size	Flow Diameter inch mm	Flow Factor Cv
1/4 NPT	0.375 9.5	1.8
3/8 NPT	0.625 16.0	2
1/2 NPT	0.625 16.0	5.5
3/4 NPT	1.062 27.0	9.6
1 NPT	1.062 27.0	11.1

GASES	LIQUIDS
$SCFM = 22.5 C_v \sqrt{\frac{\Delta P \text{ (Outlet psi abs)}}{(460^\circ + F^\circ) (SG)}}$	$GPM = C_v \sqrt{\frac{\Delta P \text{ psi}}{(SG)}}$

Assumptions:	
Flow = Air	Inlet pressure = 100 psi (7 bar)
$\Delta P = 40$ psi (3 bar)	Outlet abs = 74.7 psi (5 bar)
Temp = 68°F (20°C)	SG = 1.0

MATERIALS

Valve body and internal parts:	316L stainless steel
Actuator caps:	316L stainless steel
Valve body/actuator seals:	FKM – fluorocarbon (diaphragm, Buna)
Optional:	Low Temperature Nitrile (-44) Ethylene Propylene (-EP)
Screws:	316 stainless steel
Solenoid internal parts:	300 & 400 grade stainless steel
Solenoid Coil housing:	Dependent on coil selected, see page 8 - 9

MEDIA

Air / inert gas, including natural gas. Consult factory for hydraulic service.

The standard V-316 Series product is rated for air and gas service including natural gas. While the standard valve is rated for natural gas, Versa recommends suffix detail –NGS for enhanced valve performance (-NGST for low temperature applications).

Versa Products Company's valves and accessories are intended for use in clean dry air or inert gas systems. Versa requires filters of 40 microns or better. Versa defines "dry" as a system where dew point is 20°F below the minimum temperature to which any part of the system is exposed.

Versa's products are rated for lubricated or non lubricated service. On lubricated service, care should be taken to follow the lubricator manufactures' recommendations as to use and maintenance. As Versa's products are elastomer sealed devices, seal compatibility with media, lubricator fluid and environmental conditions should be confirmed,

PRESSURE RANGES

TYPE OF ACTUATION	TYPE OF RETURN	OPERATING PRESSURE RANGE THROUGH VALVE (CONTROLLED PRESSURE)		MINIMUM PILOT PRESSURE* (When Applicable)		
		1/4 - 1/2	3/4 - 1	1/4 - 1/2	3/4 - 1	
Manual	Spring, Spring Centering, Detent	VAC. - 200 psi (VAC. - 14 bar)	—	—	—	
PILOT	Pressure Pilot	Spring Return, 2 Position	VAC. - 200 psi (VAC. - 14 bar)	VAC. - 200 psi (VAC. - 14 bar)	40 psi (2.8 bar) 50 psi (3.5 bar)	
		Spring Centering, 3 Position	VAC. - 200 psi (VAC. - 14 bar)	—	40 psi (2.8 bar) —	
		2 Position, Dual Pilot	VAC. - 200 psi (VAC. - 14 bar)	VAC. - 200 psi (VAC. - 14 bar)	20 psi (1.4 bar) 20 psi (1.4 bar) i	
	Diaphragm	Spring Return, 2 Position Spring Centering 3 Position	VAC. - 200 psi (VAC. - 14 bar)	—	10 - 50 psi MAX (0.7 - 3.4 bar MAX)	—
		Spring Return, 2 Position Spring Centering 3 Position	-31 VAC. - 200 psi (VAC. - 14 bar)	—	10 - 200 psi MAX (0.7 - 14 bar MAX)	—
		2 Position, Dual Diaphragm	VAC. - 200 psi (VAC. - 14 bar)	—	5 - 50 psi MAX (0.34 - 3.4 bar MAX)	—
	2 Position, Dual Diaphragm	-31 VAC. - 200 psi (VAC. - 14 bar)	—	5 - 200 psi MAX (0.34 - 14 bar MAX)	—	
SOLENOID PILOT	INPilot	Spring Return, 2 Position	40 - 175 psi* (2.8 - 12 bar)†	40 - 175 psi* (2.8 - 12 bar)	40 - 175 psi MAX* (2.8 - 12 bar MAX) 50 - 175 psi MAX (3.5 - 12 bar MAX)	
		Spring Centering, 3 Position	40 - 175 psi* (2.8 - 12 bar)	—	40 - 175 psi MAX* (2.8 - 12 bar MAX)	—
		2 Position, Dual Solenoid	20 - 175 psi* (1.38 - 12 bar)	20 - 175 psi MAX* (1.4 - 12 bar MAX)†	20 - 175 psi MAX* (1.4 - 12 bar MAX)	20 - 175 psi MAX (1.4 - 12 bar MAX)
	EXPilot	Spring Return, 2 Position	VAC. - 200 psi (VAC. - 14 bar)	VAC - 200 psi MAX (VAC - 14 bar MAX)	40 - 200 psi MAX (2.8 - 14 bar MAX)	50 - 200 psi MAX (3.5 - 14 bar MAX)
		Spring Centering, 3 Position	VAC. - 200 psi (VAC. - 14 bar)	VAC - 200 psi MAX (VAC - 14 bar MAX)	20 - 200 psi MAX (1.4 - 14 bar MAX)	20 - 200 psi MAX (1.4 - 14 bar MAX)
		2 Position, Dual Solenoid	VAC. - 200 psi (VAC. - 14 bar)	VAC - 200 psi MAX (VAC - 14 bar MAX)	20 - 200 psi MAX (1.4 - 14 bar MAX)	20 - 200 psi MAX (1.4 - 14 bar MAX)

Notes: — When application involves temperatures below freezing or when shifting intervals are relatively long, it is recommended that suffix -S be specified for valves with spring actuation. Minimum pilot pressure must be increased by 40%.

*All standard solenoid valves with a maximum operating pressure or pilot pressure listed at 175 psi (12 bar). Valves may be plus pressure rated to 200 psi (14 bar). by adding suffix -200 to model number or a maximum of 300 psi (20.7 bar) by adding suffix -PPR to the model number.

TEMPERATURES - SEALS

Temperature Range (Medium/Ambient Temperature)	Type of Service					
	Intermittent Duty Service		Continuous Duty Service			
	AC or DC		AC		DC	
	Coil	Solenoid Plunger	Coil	Solenoid Plunger	Coil	Solenoid Plunger
150°F to 200°F (65°C) (95°C)	Suffix -HT	Suffix -3 (may be inclusive in other suffix options as it is in -HT)	Suffix -HT	Suffix -3 (may be inclusive in other suffix options as it is in -HT)	Suffix -HT	Suffix -3 (may be inclusive in other suffix options as it is in -HT)
120°F to 150°F (50°C) (65°C)	Standard	Suffix -3 (may be inclusive in other suffix options)	Standard	Suffix -3 (may be inclusive in other suffix options)	Suffix -HT	Suffix -3 (may be inclusive in other suffix options as it is in -HT)
-10°F to 120°F (-23°C) (50°C)	Standard	Standard	Standard	Suffix -3 (may be inclusive in other suffix options)	Standard	Suffix -3 (may be inclusive in other suffix options)

The table above lists suggested suffix options for various temperature ranges and/or types of service. For temperatures or conditions not listed, consult factory.

SOLENOID/PILOT — COIL SPECIFICATIONS*

Solenoid Suffix (see page 8)	AC					DC			
	Voltage	Voltage Code	Inrush	Holding	Ohm	Voltage	Voltage Code	Inrush/Holding	Ohm
-HC & -HCC	24/60	A024	0.633	0.491	26.2	6	D006	1.760	3.4
	120/60	A120	0.127	0.098	647	12	D012	0.863	13.9
	240/60	A240	0.063	0.049	2790	24	D024	0.440	54.6
	110/50	E110	0.127	0.098	647	48	D048	0.216	222
	220/50	E220	0.063	0.049	2790	125	D125	0.055	1606
Standard, -PC, -243, -XX & -XN	24/60	A024	0.633	0.604	19	6	D006	1.300	4.6
	120/60	A120	0.127	0.121	475	12	D012	0.632	19
	240/60	A240	0.063	0.060	2000	24	D024	0.320	75
	110/50	E110	0.132	0.081	475	48	D048	0.154	311
	220/50	E220	0.066	0.041	2030	125	D125	0.062	2030
-XX & -XN with -LB	24/60	A024	0.290	0.150	43.2	6	D006	0.320	18.8
	120/60	A120	0.060	0.030	1085	12	D012	0.160	74.6
	240/60	A240	0.030	0.020	5521	24	D024	0.077	312
	110/50	E110	0.130	0.080	1085	48	D048	0.036	1337
	220/50	E220	14.500	0.070	5521	125	D125	0.015	8460
-XV, -XT -XDBT_ & -XDBS_ (1.8 Watts)	24/60	A024			20	6	D006	0.300	20
	120/60	A120	0.062	0.029	687	12	D012	0.150	80
	240/60	A240			2714	24	D024	0.075	320
	110/50	E110			687	48	D048	0.038	1280
	220/50	E220	0.032	0.016	2714	120	D120	0.016	8000



* Coils for voltages other than those listed above may be available.
Class H (Suffix -HT) coils are available for ordinary and hazardous service.
Contact factory for availability and delivery information.

Note: Coil Cover — Standard provides 1/2" NPT female conduit connection. Use Suffix -HC or -HCC for DIN style coil connector.
Coil Lead length — Standard coil lead lengths are at least 24" (60cm). Consult factory for availability of longer lead lengths.

SOLENOID PILOT – ELECTRICAL CERTIFICATIONS

Solenoid/Pilot actuated Series V-316 valves are available with a variety of different solenoids for both nonhazardous and hazardous locations. Basic details of actuators are listed below. For additional data consult factory.

NON HAZARDOUS LOCATIONS OPERATORS

	Suffix Identification	Protection Classification	Area Classification and (Gas Grouping)	Certification-(Conformance)	Ingress Protection
	None or -HT, PC	General Purpose	Indoor & Outdoor	CSA	NEMA 1,2, 3 & 4
	-HC -HCC (Shown)	General Purpose	Indoor & Outdoor	CSA	NEMA 4; IP65

HAZARDOUS LOCATION SOLENOIDS

	Agency Approvals		North America 		World*   		
	Suffix*	Protection Classification	Zones	Divisions	Area Classification and (Gas Grouping)	Agency	Ingress Protection
	-XX	Hazardous Locations	—	CL I, DIV 1, Grp (C & D) CL II, DIV 1, Grp (E, F & G) Temp T3C CL I, DIV 2 Grp (A B C) CL II, DIV 2 Grp (E, F & G) Temp T3C	—	UL CSA	NEMA 7 & 9
	-XN	(d) Flameproof	—	—	Ex d IIB+H2 T3...T6 Gb II 2 G Ex d IIB+H2 T3...T6 Gb	IECEX ATEX	IP66/67
	-XV	Hazardous Locations	—	—	—	CSA _{US}	NEMA 4, 4X, 6P, IP66
	-XT	(d) Flameproof	—	CL I, DIV 1, Grp (B, C, D) CL II, DIV 1, Grp (E, F, G) CL III CL I, DIV 2, Grp (A, B, C, D) CL II, DIV 1, Grp (E, F, G) CL III	—	—	—
	-XDBT	(d) Flameproof (e) Increased Safety	CL, I, Zn 1 A/Ex de IIC T* CL, II Zn, 21 AEx tD A21, DIP A21	—	Ex II 2 G D A/Ex d e IIC T3...T6 Gb Ex tb IIIC T3...T6 Db	ATEX - IECEX INMETRO	IP66/67/68
	-XDBS						
	-XMAA -XMAF	(mb) Encapsulation	—	—	Ex e mb IIC T5, T6 Gb Ex tb IIIC T85°C, T100°C Db II 2 G Ex e mb IIC T5...T6 Gb II 2 D Ex tb IIIC T85°C...T100°C Db	IECEX TR CU ATEX	IP67
	-XMFA -XMFF	(e) Increased Safety					
		(tD) Tight Dust					
	-XIFA -XIFF	(ia) Intrinsic Safe	—	—	Ex (ia) IIC T4...T6 Gb Ex (ia) IIIC T130°C...T80°C Db II 2 G Ex ia IIC T4...T6 II 2 D Ex iaD 21 T130°C, T80°C	IECEX TR CU ATEX	IP67
	-HC -XISX6 (Shown) -HCC -XISX6	Intrinsic Safe	—	—	II 2 G Ex ia IIC T4...T6 Gb II 2 G Ex ia IIB T4...T6 Gb CL I, DIV 1, Grp (A, B, C & D) CL II, DIV 1, Grp (E, F, & G) CL III	ATEX IECEX TR CU CSA FM	IP65

*Recommended solenoid options. See page 35

COIL CODES: Identify the solenoid frequency and voltage consisting of a "Rating Code" and "Voltage" as shown at right. Coil codes complete the part number for a solenoid operated valve.

Rating Code
 A = 60Hz frequency
 D = Direct Current (DC)
 E = 50Hz frequency

Voltage
 Indicated by three digits:
 e.g. 24 volts = 024
 120 volts = 120

A120 = AC, 120Volts/60hz

	Voltage (Power)	Electrical Characteristics	Miscellaneous
	All usual 50 Hz & 60 Hz AC (7.3W) All usual DC (9.5W)	Class F epoxy molded coil (155°C). Continuous duty, 2 leads 24" (60 cm).	Steel cover with 1/2 NPT conduit entry.
	24V60, 120V60, 240V60 (8.5W) 24V50, 110V50, 220V50 (8.5W) 12VDC, 24VDC, 48VDC (10.5W)	Class F epoxy molded coil (155°C), with 3 spade terminals and mini DIN socket with PG9 cable gland. Continuous duty.	Mini DIN socket with PG9 cable gland (-HC) or 1/2" conduit connection (-HCC).

	Voltage (Power)	Electrical Characteristics	Miscellaneous																																																														
	50 Hz & 60 Hz AC (6W), DC (7.2W) & (1.8W) AC: 12V60 (A012), 24V60 (A024), 48V60 (A048), 120V60 (A120), 240V60 (A120) DC: 6VDC (D006), 12VDC (D012), 24VDC (D024), 48VDC (D048)	Class F epoxy molded coil (155°C). continuous duty. 3 leads 24" (60 cm).	Plated steel coil housing with 1/2 NPT conduit entry. For additional (-XX) solenoid options see page 5 Plated steel coil housing with M20 x 1.5 conduit entry. Ground terminal on cover. For additional (-XN) solenoid options see page 5																																																														
	AC: 120V60HZ (A120), 240V60HZ (A240) 110V50HZ (E110), 220V50HZ (E230) DC: 12VDC (D012), 24VDC (D024) 48VDC (D048), 120VDC (D120) 1.8 watt standard. For 0.85 watt consult factory.	Epoxy molded coils rated for continuous duty, Class H – 180°C.	<table border="1"> <thead> <tr> <th rowspan="2">Stainless steel coil housing</th> <th colspan="2">Suffix Detail Option Packabe</th> </tr> <tr> <th>XV</th> <th>XT</th> </tr> </thead> <tbody> <tr> <td></td> <td colspan="2">1.8 watt</td> </tr> <tr> <td>Standard (vent to atmosphere)</td> <td>-XV1</td> <td>-XT1</td> </tr> <tr> <td>1/8" Adapter (-H2E)</td> <td>-XV2</td> <td>-XT2</td> </tr> <tr> <td>1/4" Adapter (-HE)</td> <td>-XV3</td> <td>-XT3</td> </tr> <tr> <td>Dust Nut (-L14)</td> <td>-XV4</td> <td>-XT4</td> </tr> <tr> <td>Water proof nut (-D14)</td> <td>-XV9*</td> <td>-XT9*</td> </tr> </tbody> </table> <table border="1"> <thead> <tr> <th rowspan="2">Stainless steel coil housing with internal Junction Box. Internal and external ground screw.</th> <th colspan="4">Suffix Detail Ordering Code</th> </tr> <tr> <th colspan="2">M 20 Connection</th> <th colspan="2">½" Connection</th> </tr> <tr> <td></td> <th>No Diode</th> <th>Diode</th> <th>No Diode</th> <th>Diode</th> </tr> </thead> <tbody> <tr> <td>Standard (vent to atmosphere)</td> <td>XDBS1</td> <td>XDBS5</td> <td>XDBT1</td> <td>XDBT5</td> </tr> <tr> <td>1/8" Adapter (-H2E)</td> <td>XDBS2</td> <td>XDBS6</td> <td>XDBT2</td> <td>XDBT6</td> </tr> <tr> <td>1/4" Adapter (-HE)</td> <td>XDBS3</td> <td>XDBS7</td> <td>XDBT3</td> <td>XDBT7</td> </tr> <tr> <td>Dust Nut (-L14)</td> <td>XDBS4</td> <td>XDBS8</td> <td>XDBT4</td> <td>XDBT8</td> </tr> <tr> <td>Dust Excluder (-D14)</td> <td>XDBS9*</td> <td>XDBS10</td> <td>XDBT9*</td> <td>XDBT10</td> </tr> </tbody> </table>	Stainless steel coil housing	Suffix Detail Option Packabe		XV	XT		1.8 watt		Standard (vent to atmosphere)	-XV1	-XT1	1/8" Adapter (-H2E)	-XV2	-XT2	1/4" Adapter (-HE)	-XV3	-XT3	Dust Nut (-L14)	-XV4	-XT4	Water proof nut (-D14)	-XV9*	-XT9*	Stainless steel coil housing with internal Junction Box. Internal and external ground screw.	Suffix Detail Ordering Code				M 20 Connection		½" Connection			No Diode	Diode	No Diode	Diode	Standard (vent to atmosphere)	XDBS1	XDBS5	XDBT1	XDBT5	1/8" Adapter (-H2E)	XDBS2	XDBS6	XDBT2	XDBT6	1/4" Adapter (-HE)	XDBS3	XDBS7	XDBT3	XDBT7	Dust Nut (-L14)	XDBS4	XDBS8	XDBT4	XDBT8	Dust Excluder (-D14)	XDBS9*	XDBS10	XDBT9*	XDBT10
Stainless steel coil housing	Suffix Detail Option Packabe																																																																
	XV	XT																																																															
	1.8 watt																																																																
Standard (vent to atmosphere)	-XV1	-XT1																																																															
1/8" Adapter (-H2E)	-XV2	-XT2																																																															
1/4" Adapter (-HE)	-XV3	-XT3																																																															
Dust Nut (-L14)	-XV4	-XT4																																																															
Water proof nut (-D14)	-XV9*	-XT9*																																																															
Stainless steel coil housing with internal Junction Box. Internal and external ground screw.	Suffix Detail Ordering Code																																																																
	M 20 Connection		½" Connection																																																														
	No Diode	Diode	No Diode	Diode																																																													
Standard (vent to atmosphere)	XDBS1	XDBS5	XDBT1	XDBT5																																																													
1/8" Adapter (-H2E)	XDBS2	XDBS6	XDBT2	XDBT6																																																													
1/4" Adapter (-HE)	XDBS3	XDBS7	XDBT3	XDBT7																																																													
Dust Nut (-L14)	XDBS4	XDBS8	XDBT4	XDBT8																																																													
Dust Excluder (-D14)	XDBS9*	XDBS10	XDBT9*	XDBT10																																																													
24VDC (4W) (Consult factory for other voltage options)	Continuous duty coil & rectifier, including surge suppression, potted within housing.	Thick wall epoxy coil housing with integral junction box. Internal ground terminal. M20 x 1.5 conduit entry: (-XMAA), (-XMFA), 1/2 NPT conduit entry with adapter: (-XMAF), (-XMFF)																																																															
24VDC 10W inrush, 2.6W holding) (Consult factory for other voltages)	Continuous duty coil & power controller potted within housing.																																																																
24VDC (0.8W) (Consult factory for other voltages)	Continuous duty coil and power controller potted within housing.	Requires the use of an approved safety barrier or isolator. Thick wall epoxy coil housing and integral junction box. Internal ground terminal. M20 x 1.5 conduit entry: (-XIFA) 1/2 NPT conduit entry with adapter: (-XIFF)																																																															
24VDC (1.6 watt max.) System voltage prior to barrier	Class F epoxy molded coil (155°C). Continuous duty.	Requires the use of an approved barrier or isolator. Maximum operating system voltage before barrier 28VDC. Maximum pilot pressure 115 psi (8 bar). 3 spade terminals, ISO DIN 43650, Form "A" PG9 cable gland (-HC) 1/2 NPT conduit entry: (-HCC)																																																															

*Recommended solenoid options. See page 35

The basic purpose of the actuating device is to provide a means of shifting the valve spool in order to control the media flowing through the valve. Because the valve's spool design is balanced, the force required to shift the spool, is separate and unaffected by the pressure being controlled.

The actuators are designed for application within 2 ranges of valve sizes: one range of actuators for all valve styles, types, and sizes 1/4" through 1/2"; another range of actuators for the 1" size valves.

Illustrated with brief descriptions are the basic types of actuators in most frequent use. The "letters" referred to by the actuator types coincide with the prefix letters used in the product numbering system. Many variations and modifications of these basic actuators are also available. A few are described on Page 5 under Suffix Details. Others, such as combination actuators, can be found on Pages 26 and 27.

MANUAL

A push or pull motion may be used to operate the hand device in order to shift the valve spool. If used with a detent device ("U" or "Z") or a no-spring device ("N") the handle must be actuated and returned manually. With a spring centering device ("B") the handle will normally be in the center position when not actuated, or will return to the center position after being actuated. To actuate with a spring centering device, the handle must be pulled to one offset position and pushed to the other. The precise differences of each of the three hand actuating devices are described below.



HAND LEVER

TYPE "L" HAND LEVER (Centerline Mounted)

The handle of this device is in the vertical plane through the center line of the valve body. On models up to 1/2" pipe size, a rubber boot provides protection from dirt and dust. The entire device may be rotated into positions at increments of 90° from vertical. To indicate, use Suffix -218A, -218B, or -218C as shown below for offset mounted hand lever.

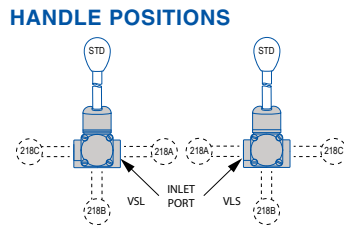

HANDLE POSITIONS

OPTIONS

Hand valves are supplied according to standard position. Three other positions are available (Suffix -218A Thru 218C). To order simply include the Suffix number shown. Example: VSL-4302-316-218A.

TYPE "I" PALM BUTTON (Panel Mounting Is Standard)

The body of the Palm Button actuator is supplied with a thread and nut that allows the actuator, when required, to be fastened to a panel with the valve behind the panel. The button will then project through and be visible from the front panel. Pushing or pulling the button activates the valve.

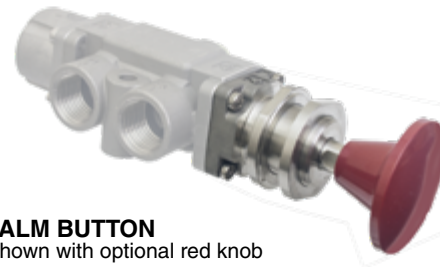

PALM BUTTON
Shown with optional red knob



SPRING RETURN

SPRING RETURN

A device for returning the valve spool to its original position in 2-position valves.

TYPE "S"

Can be used on any type valve. Pushes valve spool.

TYPE "R"

For use with Lever or Palm Button operated valves. Pulls valve spool.

NO-SPRING RETURN

TYPE "N"

For use on Palm or Lever Operated valves only. Used when automatic return of valve spool is not desired. Spool will stay in last position placed until operated to another position

SPRING CENTERING DEVICE

A device for returning the valve spool to center position in manual valves only. Spring centering devices for Pilot or Solenoid/Pilot Operated valves are an integral part of the specific actuator.

TYPE "B"

Spring centers from both offset positions.



SPRING CENTERING

DETENT

A device that establishes a definite “feel” indicating when valve is in a specific position. Also prevents spool from shifting should excessive vibration be present. Generally used with Hand Operated valves, but can also be supplied, in some cases, for Pilot and Solenoid/Pilot Operated valves as a Combination Actuator.

TYPE “U”

3-Position detent for 3-Position valves. Provides detent in each offset position and center position as well.

TYPE “Z”

2-Position detent for 2-Position valves. Provides detent in both offset positions.

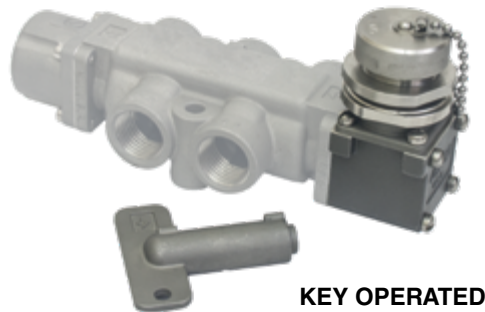

KEY OPERATED

KEY Operated TYPE “314”

KEY OPERATED VALVE

KEY REMOVABLE IN ONE POSITION

314E: key can only be removed in the “normal Position.” The valve must have a return spring, detent or pilot on end opposite key. Captive dust cap and two keys supplied. Panel mounting provision is standard.

KEY OPERATED VALVE

KEY REMOVABLE IN TWO POSITIONS

314D: key is removable after key has been rotated to the clockwise or counter-clockwise position. The valve must have a two detent on end opposite key. Captive dust cap and two keys supplied. Panel mounting provision is standard.

Rotary Switch

TYPE “357”

Rotary switch (fixed key) actuated valve (detented)



Rotary Switch

MECHANICAL

Cam valves are supplied with roller axis perpendicular to the mounting surface. Should you require the axis parallel to the mounting surface (shown at right) simply include suffix number shown. Example: VSC-3301-316

TYPE “C” CAM ACTUATOR

Utilizes case hardened roller. Recommended maximum pressure angle 15°

**STANDARD
ROLLER AXIS
PARALLEL**

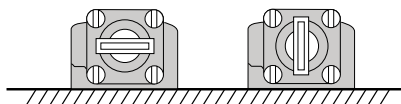

**OPTIONAL
(SUFFIX -226)
ROLLER AXIS
PERPENDICULAR**



MECHANICAL

TYPE “33E”

-33E Suffix Detail is a plain end cap assembly, with an opening for the valve plunger to extend through the cap to the outside of the valve. While not an actuator it can be used in tandem arrangement to shift an additional valve or for special applications to actuate a device, such as a switch or as an indicator of plunger position.



PILOT

The pilot actuator is a small cylinder and piston that is an integral part of the valve and which, when pressurized or unpressurized, actuates the valve.

TYPE “P” PRESSURE PILOT (for 2-Position valves)

TYPE “J” PRESSURE PILOT (for 3-Position valves)

This pilot requires pressure to actuate the valve, and release of the pressure to return the valve. Usually it is controlled by a small Three-Way valve. The pilot port on the ¼” through ½” valves may be rotated to any position in 90° increments from vertical. (See option arrangements below). When used in pairs for 2-position valves, it is not necessary to maintain pressure on the actuated pilot in order for the valve to remain in actuated position. Valve will remain in last position until signalled by the opposite pilot to return. When used with spring centering feature (“J”), valve will remain in center position until actuated by either pilot. To remain in actuated position, pilot must remain pressurized until it is required for valve to return to center position.



PILOT -P

PILOT POSITION OPTIONS

STANDARD POSITION OF PILOT INLET

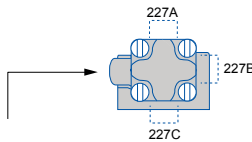

Pilot actuated valves (¼” thru ½”) are supplied with the pilot port facing the same direction as the inlet port of the valve proper. Three other positions are available (Suffix -227A thru -227C).

To order simply include the suffix number shown. Example: VSP-4302-316-227A.



PILOT -J



DIAPHRAGM PILOT -W

TYPE “W” DIAPHRAGM PILOT (for 2-Position valves)

A large pilot area allows the diaphragm pilot to function on very low signal pressures. Usually controlled by a Three-Way valve, the diaphragm pilot requires pressure to actuate. When used in pairs for 2-position valves, it is not necessary to maintain pressure on actuated pilot in order for valve to remain in actuated position. Valve will remain in last position until signalled by opposite pilot to return.

SOLENOID/PILOT

A low power solenoid controls a built-in pilot which provides the positive force for shifting the valve spool. When used with a spring return (“S”) the valve will be actuated when the solenoid is energized and will return when the solenoid is de-energized. When used in pairs for 2-position valves, the solenoid need only be energized momentarily in order to shift the valve. The valve will then remain in the shifted position until signalled to return by the opposite solenoid. In spring centering models (“X”) the valve will remain in the center position until one of the solenoids is energized. It is necessary to maintain energy on the solenoid as long as it is desired for the valve to remain in the shifted position. When de-energized, the valve will return to the center position.

STANDARD COILS are epoxy molded in a steel inclosure with ½” conduit hub. For AC and DC voltages available, see Pages 7 - 9.

Two Piloting devices are available depending upon the service to which they will be applied:



GENERAL PURPOSE SOLENOID

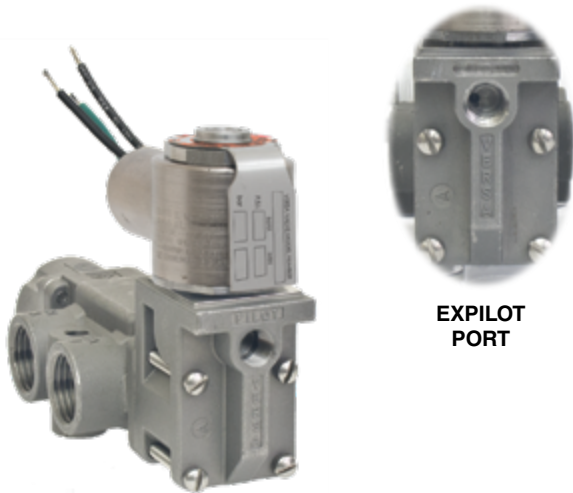

HAZARDOUS LOCATION SOLENOID

EXPILOT PORT

INPilot– utilizes the pressure from the inlet of the valve, through internal passages, to the solenoid-pilot. In this type valve, only one pressure connection, the inlet, is necessary.

EXPilot– requires a separate auxiliary pressure line to the solenoid-pilot. Should be used when valve is controlling vacuum, when pressure will be below the minimum recommended for INPilot operation or when viscosity of controlled medium is such that it will impede the speed of actuation. In any case, the pressure source may be either air or liquid and is independent of the medium which is being controlled by the valve.

TYPE “G” UPRIGHT SOLENOID/PILOT (for 2-Position valves)

TYPE “X” UPRIGHT SOLENOID/PILOT (for 3-Position valves)

Coils of actuator are placed on top of solenoid cap so as to be perpendicular to the longitudinal axis of the valve. Shortens overall length of valve. Used as standard for valves equipped with hazardous location solenoids (suffix “-XX”) or plug-in solenoids, (suffix “-P”).

SOME AVAILABLE OPTIONS

- Manual Override: (Suffix -ME)
- Threaded Solenoid Exhaust Adapter: (Suffix -H -H2)
- Dust excluders for solenoid exhaust:
 - Dust Proof: (Suffix -L14)
 - Water Tight: (Suffix -D14)



OVERVERRIDE
-ME



Hydraulic Adapter
-H2 ¼”
-H ¼”

Solenoid Vent Options



-L14
Dust Proof



-D14
Water Tight

STAINLESS STEEL TAG

ORDERING INFORMATION

Order any B-316, C-316, T, V or V-316 valve. As a separate line item (listed directly under valve part number to be tagged) list the tag part number P- 2002-16-NV28A. In remarks field specify the tag marking instructions. If sequential numbering is required provide the start and end numbers required in the sequence for the appropriate number of valves.

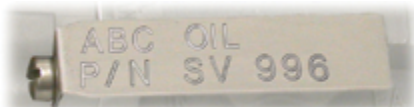

Engraving Options

Versa's engraved tags are available in two configurations.

Configuration one: is a simple text field consisting of two lines of text, 20 characters maximum per line. The text can be specified as alpha, numeric or both.

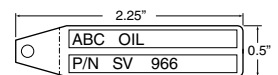

Configuration two: is a text field with sequential numbering added. This option includes two lines of text. Line one is text. Line two allows for sequentially numbering the tag, 20 characters maximum per line.

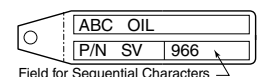

3

WAY VALVES 3/2 and 3/3



Three-Way Valves may be either normally open or normally closed to the inlet in the un-actuated position. Three-Way Valves are usually used to control single acting cylinders or the pilots of other valves or devices. Two additional types of Three-Way Valves are available.

Diverter: a common inlet that directs flow to either one of two outlets.

Selector: two separate inlets that are alternately connected to a common outlet.

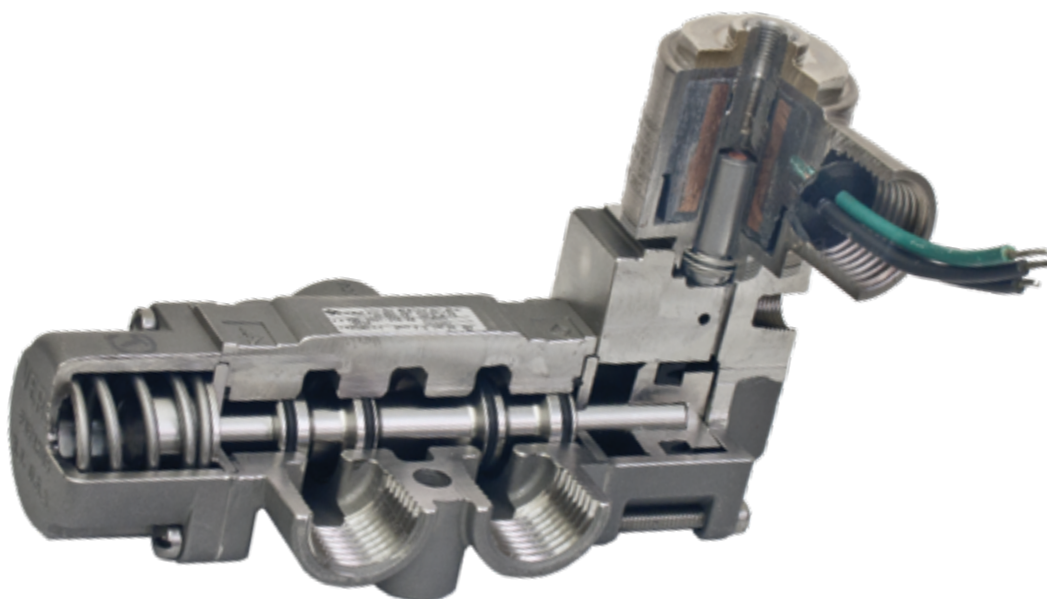

Shown: VSG-3501-316-PC-XX-D024

NOMINAL PRESSURE RANGE

Series "V-316": partial vacuum to 200 psi
(14 bar) pneumatic

(Consult pressure rating chart on Page 6
for specific pressure rating of each valve.)

ACTUATION

MANUAL, MECHANICAL, PILOT
or SOLENOID-PILOT

PORT SIZES: 1/4", 3/8", 1/2" and 1" NPT

Refer to pages 6 through 9 for information concerning:

- | | |
|--------------|-----------------|
| Construction | Pressure Ranges |
| Seals | Electrical |
| Port Sizes | Temperature |
| Flow | Filtration |

STANDARD FLOW PATTERNS

Valves must be connected in accordance with the port markings so that the flow is from the inlet port to the outlet port or from outlet port to exhaust. The flow within the valve should never be reversed. Note: When used in a vacuum system, the vacuum pump is connected to the exhaust port

THREE WAY

2 POSITION 3/2

1. VALVE NORMALLY CLOSED (actuator mounted on right end of valve)

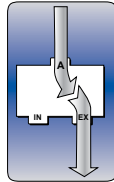

UN-ACTUATED

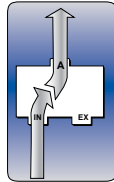

ACTUATED

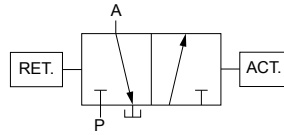

2. VALVE NORMALLY OPEN (actuator mounted on left end of valve)

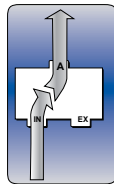

UN-ACTUATED

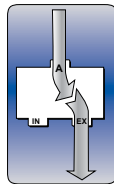

ACTUATED

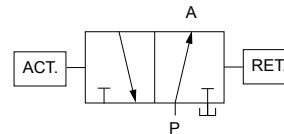

TWO OUTLET (Diverter) 2 POSITION 3/2

To indicate substitute number "7" for first digit of product number.

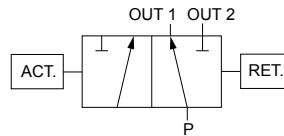
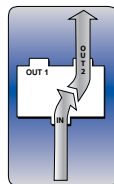
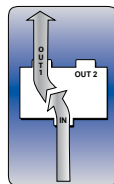

TWO INLET (Selector) 2 POSITION 3/2

To indicate substitute number "8" for first digit of product number.

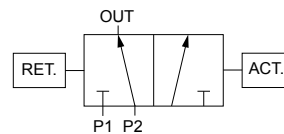
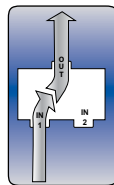
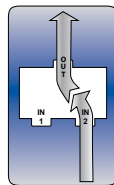

For 3 Position 3/3 (all ports blocked in the center position) substitute number "3" for fourth digit of product number. E.g., VSG-3503-316-D024.

3

WAY DIMENSIONS



Port hole locations and mounting hole size and locations shown in the individual Body Detail below apply to all Three-Way valves, regardless of type of actuation. The overall dimensions are shown for each type of valve.

BODY DETAIL

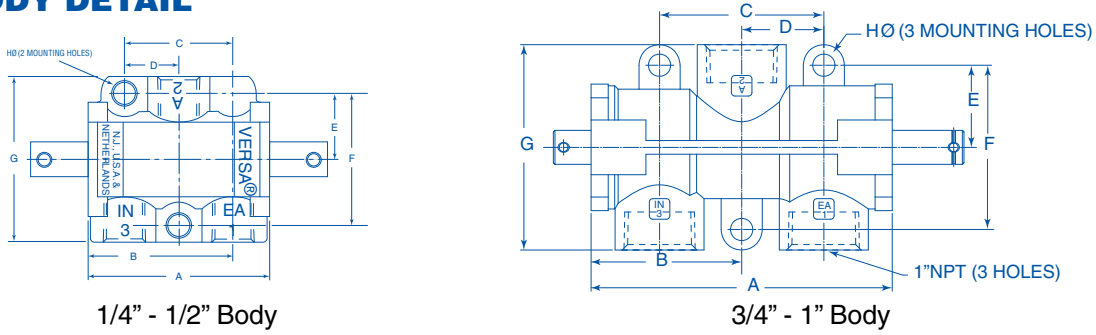

SIZE	A		B		C		D		E		F		G		HØ	
	in	mm	in	mm	in	mm	in	mm	in	mm	in	mm	in	mm	in	mm
1/4" - 3/8"	2.19	56	1.75	45	1.31	33	0.66	17	.80	20	1.59	40	2	51	0.27	6.7
1/2"	2.84	95	2.08	52.8	1.31	33	0.66	17	.80	20	1.59	40	2.5	63.5	0.27	6.7
3/4" - 1"	5.5	140	3.25	82.6	3.0	76	1.5	38.1	1.5	40	3.0	6.2	3.375	85.7	0.406	1.2

HAND ACTUATED VALVES

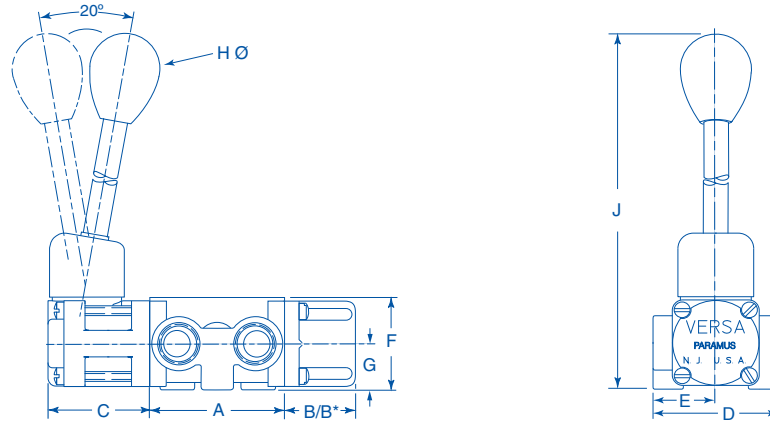

SIZE	A		B		B*		C		D		E		F		G		HØ		J	
	in	mm	in	mm	in	mm	in	mm	in	mm	in	mm	in	mm	in	mm	in	mm	in	mm
1/4" - 3/8"	2.19	55.6	1.15	29.2	1.78	45.2	1.65	41.9	2	51	1	25	1.56	39.6	0.75	21	0.56	14.3	6.3	160.3
1/2"	2.84	72	1.15	29.2	1.78	45.2	1.65	41.9	2.5	63.5	1.25	31.8	1.56	39.6	0.75	22	0.56	14.3	6.3	160.3
3/4" - 1"	5.5	140	2.01	0.51	—	—	1.65	41.9	3.75	95.2	1.88	47.8	2.5	63.5	1.19	30.2	0.56	14.3	8.72	221.5

BUTTON ACTUATED VALVES

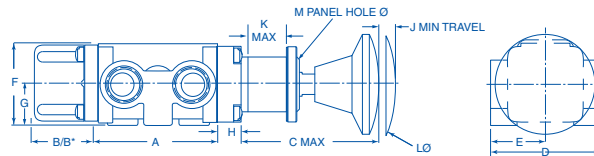

SIZE	A		B		B*		C Max		D		E		F		G		H		J Min		K		LØ		MØ	
	in	mm	in	mm	in	mm	in	mm	in	mm	in	mm	in	mm	in	mm	in	mm	in	mm	in	mm	in	mm	in	mm
1/4" - 3/8"	2.19	55.6	1.15	29.2	1.78	45.2	3.31	84	2	51	1	25	1.56	39.6	0.75	21	0.44	11.2	0.34	8.6	0.90	22.9	1.81	46	1	25.4
1/2"	2.84	72	1.15	29.2	1.78	45.2	3.31	84	2.5	63.5	1.25	31.8	1.56	39.6	0.75	22	0.44	11.2	0.34	8.6	0.90	22.9	1.81	46	1	25.4

*Dimensions for Spring-Centering Valves. For port and mounting hole locations for all valves shown above, refer to drawings top page 16.

3

WAY DIMENSIONS



PILOT ACTUATED VALVES (and Spring Centering)

SINGLE PILOT

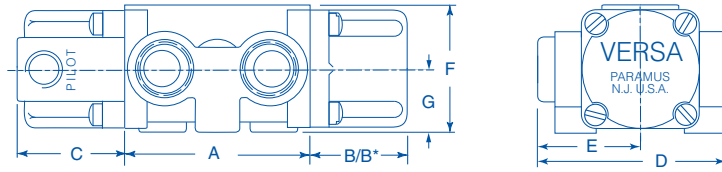

DOUBLE PILOT

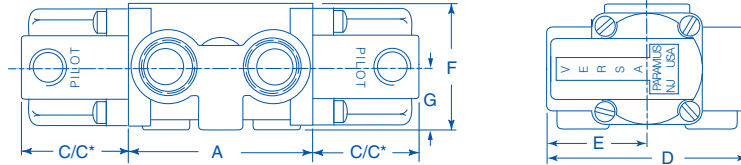

SIZE	A		B		B*		C		C*		D		E		F		G	
	in	mm	in	mm	in	mm	in	mm	in	mm	in	mm	in	mm	in	mm	in	mm
1/4" - 3/8"	2.19	55.6	1.15	29.2	1.78	45.1	0.94	23.8	2.17	55.1	2.19	55.6	1.19	30.2	1.56	39.6	0.75	19.1
1/2"	2.84	72	1.15	29.2	1.78	45.1	0.94	23.8	1.86	47.0	2.5	63.5	1.25	31.8	1.56	39.6	0.75	19.1
3/4" - 1"	5.5	140	2.01	51.0	—	—	2	51	—	—	3.75	95.2	1.88	47.8	2.5	63.5	1.19	30.2

*Dimensions for Spring-Centering Valves.

DIAPHRAGM ACTUATED VALVES

SINGLE PILOT

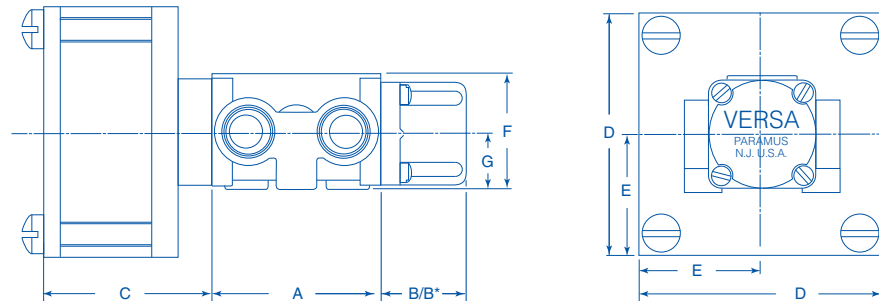

SIZE	A		B		B*		C		D		E		F	
	in	mm	in	mm	in	mm	in	mm	in	mm	in	mm	in	mm
1/4" - 3/8"	2.19	55.6	1.15	29.2	1.78	45.2	2.0	51	3.25	82.6	1.63	41.3	1.5	38
1/2"	2.84	72	1.15	29.2	1.78	45.2	2.0	51	3.25	82.6	1.63	41.3	1.69	43

*Dimensions for Spring-Centering Valves.
For port and mounting hole locations for all valves shown above, refer to drawings top page 16.

3

WAY DIMENSIONS



SOLENOID ACTUATED VALVES (Non Hazardous Service)

SINGLE SOLENOID

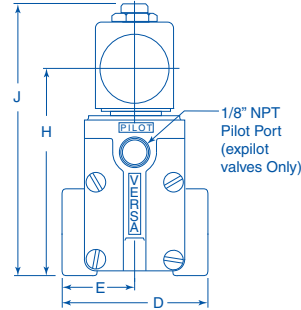
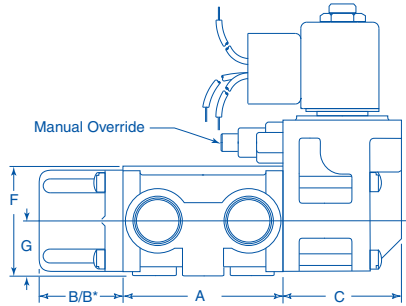

DOUBLE SOLENOID

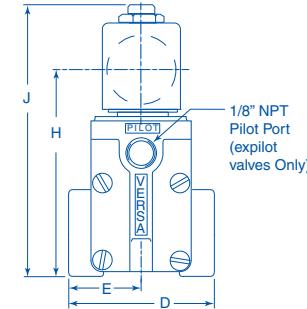
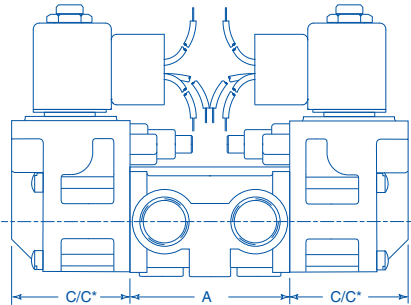

SIZE	A		B		B*		C		C*		D		E		F		G		H		J	
	in	mm	in	mm	in	mm	in	mm	in	mm	in	mm	in	mm	in	mm	in	mm	in	mm	in	mm
1/4" - 3/8"	2.19	55.6	1.15	29.2	1.76	45.1	1.62	41.3	2.54	64.6	2	51	1.0	25.4	1.56	39.6	2.98	75.7	2.86	72.5	3.75	95.3
1/2"	2.84	72.1	1.15	29.2	1.76	45.1	1.62	41.3	2.54	64.6	2.5	63.5	1.25	31.8	1.56	39.6	2.98	75.7	2.86	72.5	3.75	95.3
3/4" - 1"	5.5	139.7	2.01	151	—	—	2.01	151	—	—	3.75	95.3	1.88	47.6	5.17	131.3	4.29	109	5.17	144	4.83	122.7

*Dimensions for Spring-Centering Valves.

SOLENOID ACTUATED VALVES (Hazardous Service -XV, -XT, -XX & -XN)

SINGLE SOLENOID

See page 7-9

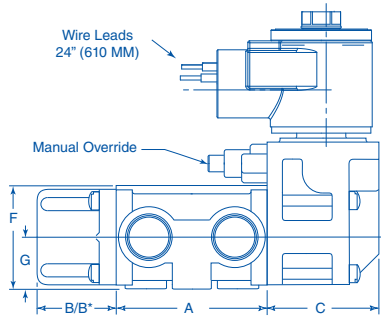

-XV
Type Coil
Shown

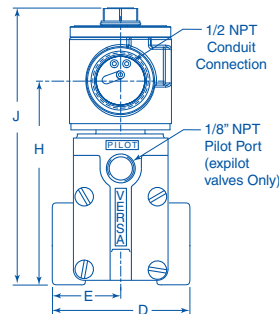

DOUBLE SOLENOID

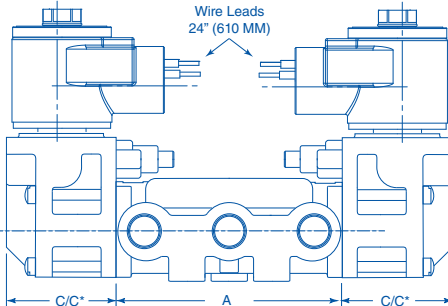

-XV
Type Coil
Shown

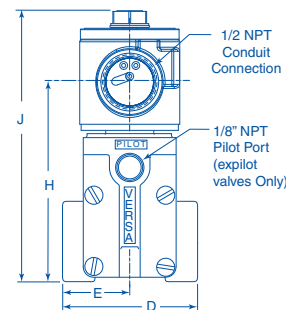

SIZE	A		B		B*		C		C*		D		E		F		G		H		J					
	in	mm	in	mm	in	mm	in	mm	in	mm	in	mm	in	mm	in	mm	in	mm	XV-XT	XX-XN	XV-XT	XX-XN				
1/4" - 3/8"	2.19	55.6	1.15	29.2	1.76	45.1	1.62	41.3	2.54	64.6	2	51	1.0	25.4	3.89	97.4	0.75	19.1	2.96	75.2	2.98	75.7	4.03	102.5	3.90	99.2
1/2"	2.84	72.1	1.15	29.2	1.76	45.1	1.62	41.3	2.54	64.6	2.5	63.5	1.25	31.8	3.89	97.4	0.75	19.1	2.96	75.2	2.98	75.7	4.03	102.5	3.90	99.2
3/4" - 1"	5.5	139.7	2.01	151	—	—	2.01	151	—	—	3.75	95.3	1.88	47.6	6.5	171	1.31	34	4.29	109	4.90	124.3	3.92	99.5	5.97	151.6

*Dimensions for Spring-Centering Valves. For port and mounting hole locations for all valves shown above, refer to drawings top page 16.

3

WAY DIMENSIONS



SOLENOID ACTUATED VALVES (Hazardous Service -XDB_)

SINGLE SOLENOID

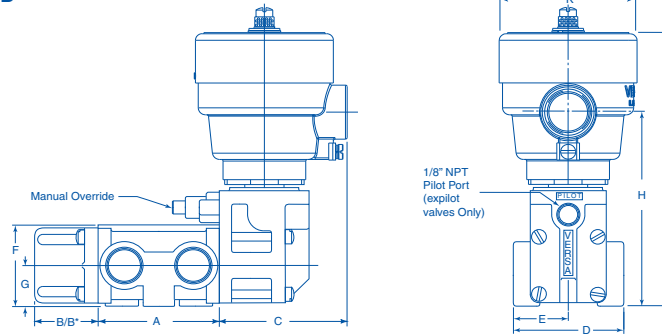

DOUBLE SOLENOID

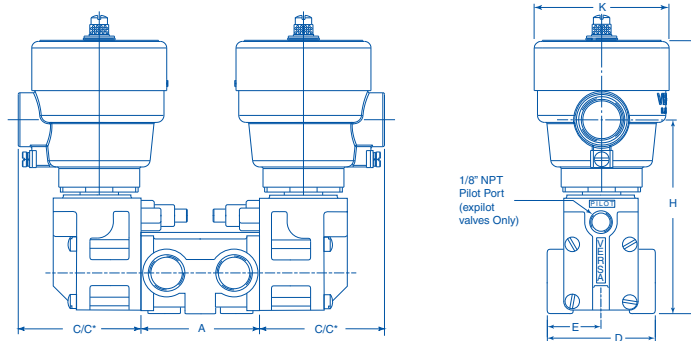

SIZE	A		B		B*		C		C*		D		E		F		G		H		J		K	
	in	mm	in	mm	in	mm	in	mm	in	mm	in	mm	in	mm	in	mm	in	mm	in	mm	in	mm	in	mm
1/4" - 3/8"	2.19	55.6	1.15	29.2	1.76	45.1	1.62	41.1	1.76	45.1	0.69	17.5	2	51	1.56	39.6	0.75	19.1	2.83	72	5.16	131.2	2.5	63.5
1/2"	2.84	72.1	1.15	29.2	1.76	45.1	1.62	41.1	1.76	45.1	0.69	17.5	2.5	63.5	1.56	39.6	0.75	19.1	2.83	72	5.16	131.2	2.5	63.5
3/4" - 1"	5.5	139.7	2.01	51	—	—	2.6	66	—	—	2.59	65.8	3.75	95.3	1.88	47.6	1.19	30.2	4.9	124.3	6.84	164	2.5	63.5

*Dimensions for Spring-Centering Valves.

SOLENOID ACTUATED VALVES (Hazardous Service Valves -XMA_)

SINGLE SOLENOID

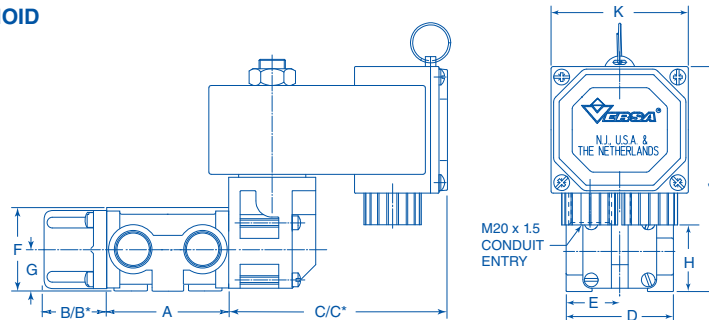

DOUBLE SOLENOID

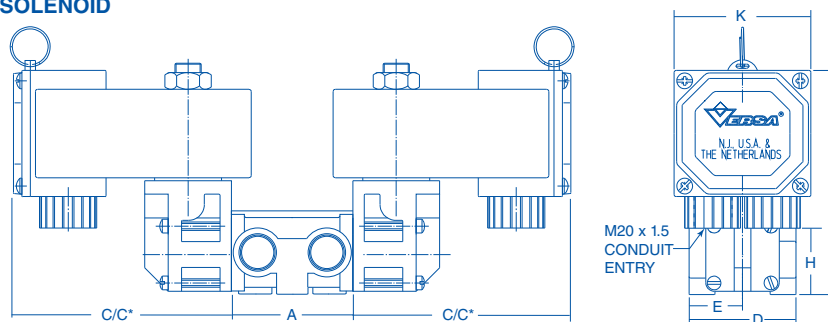

SIZE	A		B		B*		C		C*		D		E		F		G		H		J		K	
	in	mm	in	mm	in	mm	in	mm	in	mm	in	mm	in	mm	in	mm	in	mm	in	mm	in	mm	in	mm
1/4" - 3/8"	2.19	55.6	1.15	29.2	1.76	45.1	4.08	103.6	4.1	104.1	2	51	1.38	35	1.56	39.6	0.75	19.1	1.26	32	4.0	101	2.6	65
1/2"	2.84	72.1	1.15	29.2	1.76	45.1	4.08	103.6	4.1	104.1	2.5	63.5	1.25	31.8	1.56	39.6	0.75	19.1	1.26	32	4.0	101	2.6	65
3/4" - 1"	5.5	139.7	2.01	51	—	—	4.36	110.7	—	—	3.75	95.3	1.88	47.6	2.5	30.2	1.19	30.2	3.21	81.6	6.3	160	2.6	65

*Dimensions for Spring-Centering Valves. For port and mounting hole locations for all valves shown above, refer to drawings top page 16.

4

WAY VALVES 5/2 and 5/3



Four-Way Valves are generally used to control double acting cylinders. They function to alternately direct pressure to one of two outlets at the same time exhausting pressure from the opposite outlet.

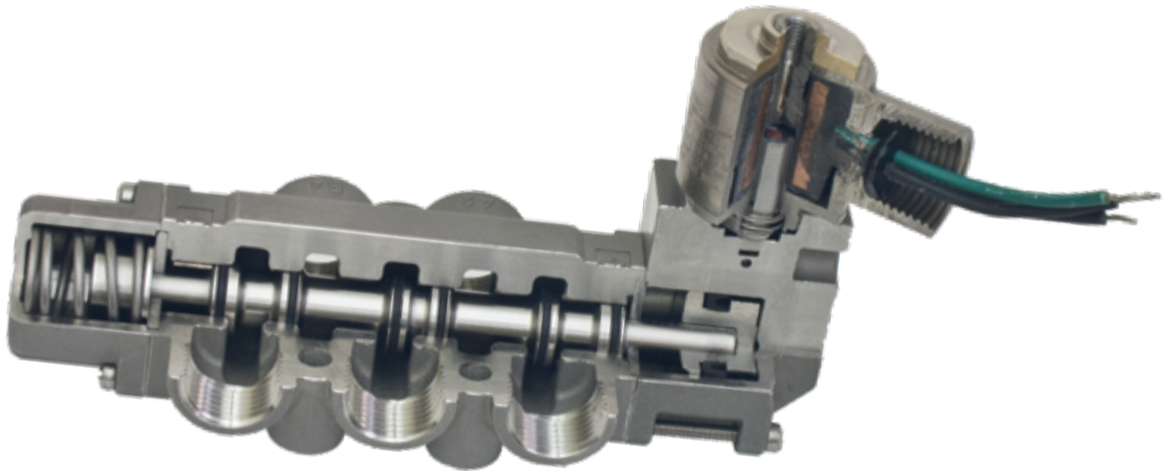

Shown: VSG-4522-316-PC-XX-D024

NOMINAL PRESSURE RANGE

Series V-316: partial vacuum to 200 psi (14 bar) pneumatic. For hydraulic consult factory

(Consult pressure rating chart on Page 6 for specific pressure rating of each valve.)

ACTUATION

MANUAL, MECHANICAL, PILOT
or SOLENOID-PILOT

Refer to pages 6 through 9 for information concerning:

- Construction
- Seals
- Port Sizes
- Flow
- Pressure Ranges
- Electrical
- Temperature
- Filtration

STANDARD FLOW PATTERNS

ONE INLET, TWO OUTLETS, TWO EXHAUSTS

Valves must be connected in accordance with the port markings so that the flow is from the inlet port to the outlet port or from outlet port to exhaust. The flow within the valve should never be reversed. Note: When used in a vacuum system, the vacuum pump is connected to the outlet port

2 POSITION 5/2

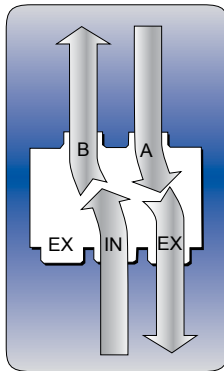

Inlet open to cylinder port B, cylinder port A, open to exhaust.

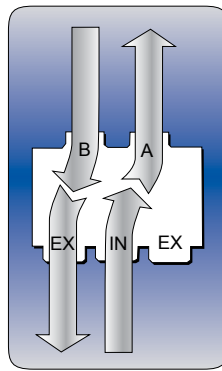

Inlet open to cylinder port A, cylinder port B open to exhaust.

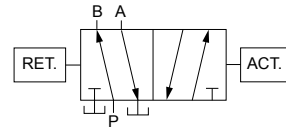

3 POSITION 5/3

Diagrams below show center position only. Offset positions are same as shown above for 2-position types. To indicate particular center pattern required, substitute number shown within corresponding diagram for fourth digit of product number.

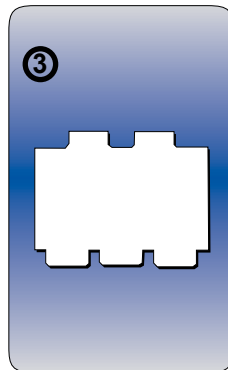

All ports blocked

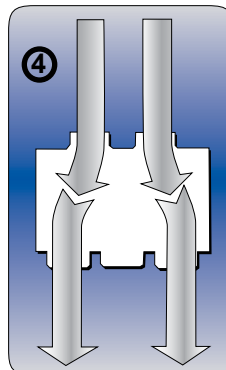

Cylinder ports open to exhaust.

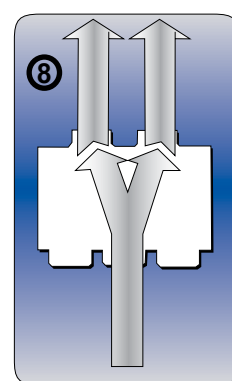

Inlet open to both cylinder ports.

4

WAY-MOUNTING DIMENSIONS



Port hole locations and mounting hole size and locations shown in the individual Body Detail below apply to all Four-Way valves, regardless of type of actuation. The overall dimensions shown for each type of valve actuation apply whether for side ported or sub-plate mounting type.

BODY DETAIL

1/4" - 1/2" Body

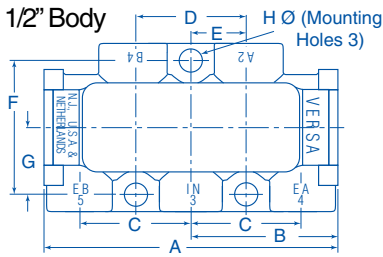

3/4" - 1" Body

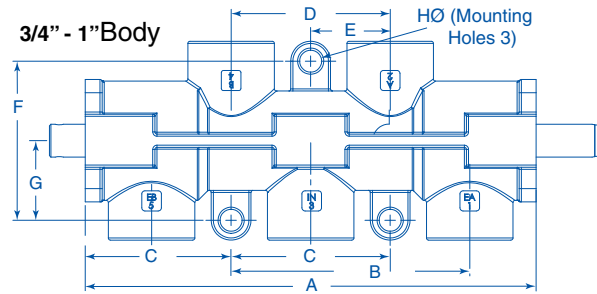

SIZE	A		B		C		D		E		F		G		H Ø	
	in	mm	in	mm	in	mm	in	mm	in	mm	in	mm	in	mm	in	mm
1/4" - 3/8"	3.5	89	1.75	44.5	1.31	33.3	1.32	33.5	0.66	16.7	1.56	39.6	0.80	20.2	0.27	6.7
1/2"	4.0	101.6	2.0	51	1.31	33.3	1.32	33.5	0.66	16.7	1.56	39.6	0.80	20.2	0.27	6.7
3/4" - 1"	8.5	215.9	4.25	108	3	76.2	3	76.2	1.5	38.1	3	76.2	1.5	38.1	0.4	1.2

LEVER ACTUATED VALVES

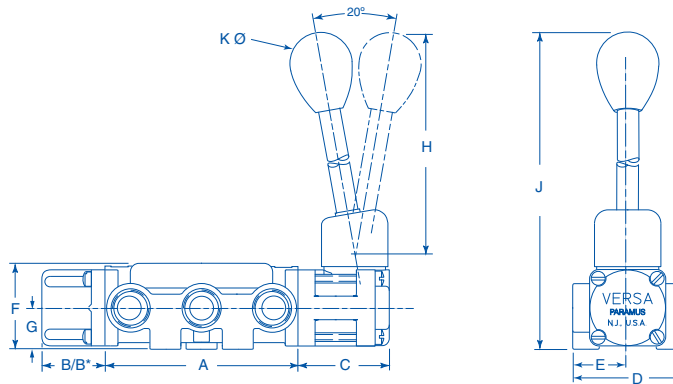

SIZE	A		B		B*		C		D		E		F		G		H		J		K Ø	
	in	mm	in	mm	in	mm	in	mm	in	mm	in	mm	in	mm	in	mm	in	mm	in	mm	in	mm
1/4" - 3/8"	3.5	89	1.15	29.2	1.78	45.2	1.65	41.9	2	51	1	25	1.56	39.6	0.75	19	4	101.6	6.3	160.5	0.56	14.2
1/2"	4	101.6	1.15	29.2	1.78	45.2	1.65	41.9	2.5	63.5	1.25	31.8	1.56	39.6	0.75	19	4	101.6	6.3	160.5	0.56	14.2
3/4" - 1"	8.63	219.1	2.01	51	—	—	2.01	51	3.75	95.3	1.88	47.6	2.5	63.5	1.19	30.2	4	101.6	8.72	221.5	0.56	14.2

*Dimensions for Spring-Centering Valves.

BUTTON ACTUATED VALVES

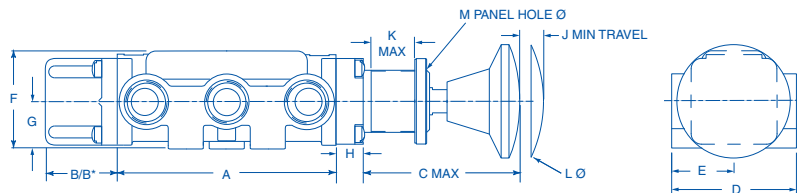

SIZE	A		B		B*		C Max		D		E		F		G		H		J Min		K		L Ø		M Ø		
	in	mm	in	mm	in	mm	in	mm	in	mm	in	mm	in	mm	in	mm	in	mm	in	mm	in	mm	in	mm	in	mm	
1/4" - 3/8"	3.5	88.9	1.15	29.2	1.78	45.2	2.3	31	84	2	51	1	25	1.56	39.6	0.75	21	0.44	11.2	0.34	8.6	0.90	22.9	1.81	46	1	25.4
1/2"	4.0	101.6	1.15	29.2	1.78	45.2	2.3	31	84	2.5	63.5	1.25	31.8	1.56	39.6	0.75	22	0.44	11.2	0.34	8.6	0.90	22.9	1.81	46	1	25.4

*Dimensions for Spring-Centering Valves. For port and mounting hole locations for all valves shown above, refer to drawings top page 22.

4

WAY-MOUNTING DIMENSIONS



SOLENOID ACTUATED VALVES (Non Hazardous Service)

SINGLE SOLENOID

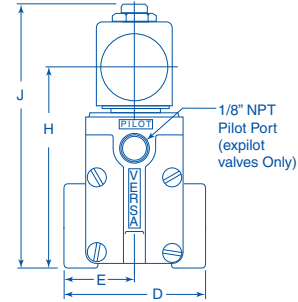
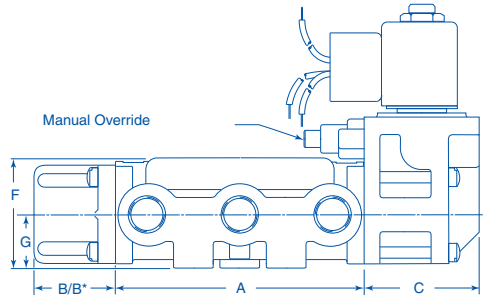

DOUBLE SOLENOID

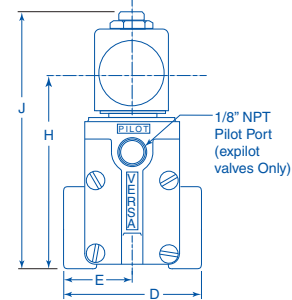
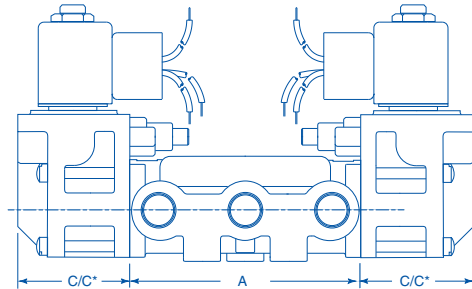

SIZE	A		B		B*		C		C*		D		E		F		G		H		J	
	in	mm	in	mm	in	mm	in	mm	in	mm	in	mm	in	mm	in	mm	in	mm	in	mm	in	mm
1/4" - 3/8"	3.50	88.9	1.15	29.2	1.84	47	1.62	41.3	2.54	64.6	2	51	1.0	25.4	1.56	39.6	0.75	19	2.86	72.6	3.75	95.2
1/2"	4.0	101.6	1.15	29.2	1.84	47	1.62	41.3	2.54	64.6	2.5	63.5	1.25	31.8	1.56	39.6	0.75	19	2.86	72.6	3.75	95.2
3/4" - 1"	8.63	219	2.01	51	—	—	2.01	51	—	—	1.88	47.8	2.5	63.5	1.19	30.2	1.19	30.2	4.83	122.7	5.67	144.1

*Dimensions for Spring-Centering Valves.

SOLENOID ACTUATED VALVES (Hazardous Service -XV, -XT, -XX & -XN)

SINGLE SOLENOID

See page 7-9

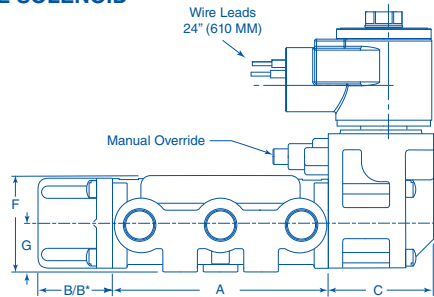

-XV
Type Coil
Shown

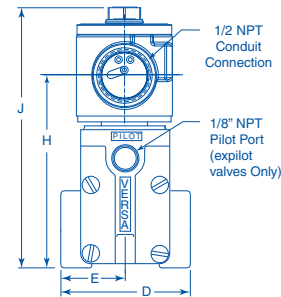

DOUBLE SOLENOID

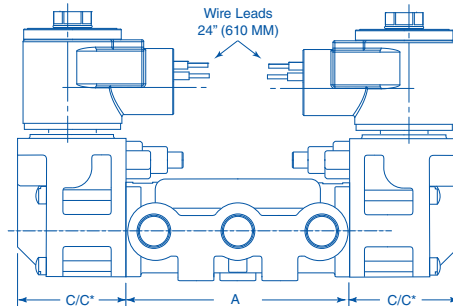

-XV
Type Coil
Shown

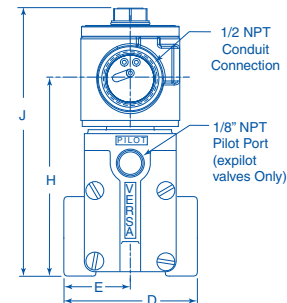

SIZE	A		B		B*		C		C*		D		E		F		G		H		J					
	in	mm	in	mm	in	mm	in	mm	in	mm	in	mm	in	mm	in	mm	in	mm	XV-XT	XX-XN	XV-XT	XX-XN				
1/4" - 3/8"	3.50	88.9	1.15	29.2	1.84	47	1.62	41.3	2.54	64.6	2	51	1.0	25.4	1.56	39.6	0.75	19	2.96	75.2	2.98	75.7	4.03	102.5	3.90	99.2
1/2"	4.0	101.6	1.15	29.2	1.84	47	1.62	41.3	2.54	64.6	2.5	63.5	1.25	31.8	1.56	39.6	0.75	19	2.96	75.2	2.98	75.7	4.03	102.5	3.90	99.2
3/4" - 1"	8.63	219	2.01	51	—	—	2.01	51	—	—	3.75	95.3	1.88	47.8	2.5	63.5	1.19	30.2	4.90	124.3	3.92	99.5	5.97	151.6	4.84	123

*Dimensions for Spring-Centering Valves. For port and mounting hole locations for all valves shown above, refer to drawings top page 22.

4

WAY-MOUNTING DIMENSIONS



PILOT ACTUATED VALVES

SINGLE PILOT

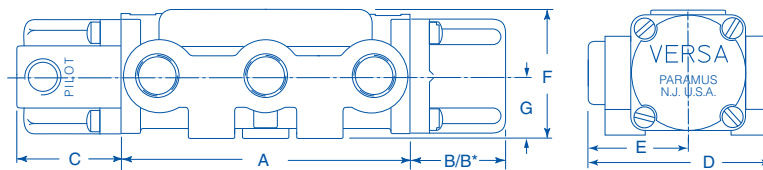

DOUBLE PILOT

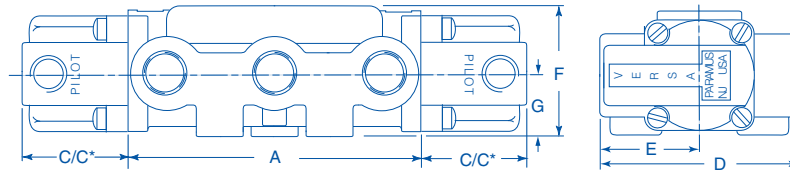

SIZE	A		B		B*		C		C*		D	E		F		G		
	in	mm	in	mm	in	mm	in	mm	in	mm		in	mm	in	mm	in	mm	
1/4" - 3/8"	3.5	88.9	1.15	29.2	1.78	45.1	1.25	31.8	2.17	55	2.19	55.6	1.19	30.2	1.56	39.6	0.75	19.1
1/2"	4.0	101.6	1.15	29.2	1.78	45.1	1.25	31.8	2.17	55	2.5	47.1	1.25	31.8	1.56	39.6	0.75	19.1
3/4" - 1"	8.63	219.1	2.01	51	0.51	12.8	2.01	51	0.51	12.8	1.88	47.8	2.5	63.5	1.19	30.2	1.19	30.2

*Dimensions for Spring-Centering Valves.

DIAPHRAGM ACTUATED VALVES

SINGLE DIAPHRAGM

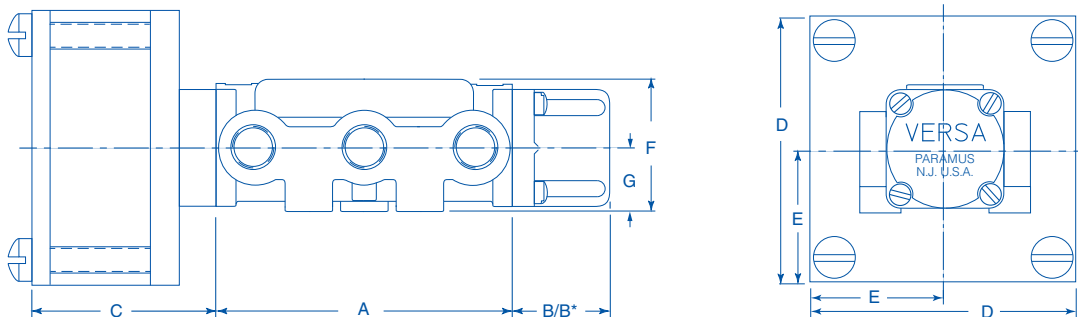

SIZE	A		B		B*		C		D		E		F		G	
	in	mm	in	mm	in	mm	in	mm	in	mm	in	mm	in	mm	in	mm
1/4" - 3/8"	3.5	88.9	1.15	29.2	1.75	45.1	2.0	51	3.25	82.6	1.63	41.3	1.56	39.6	0.75	19.1
1/2"	4.0	101.6	1.15	29.2	1.75	45.1	2.0	51	3.25	82.6	1.63	41.3	1.56	39.6	0.75	19.1

*Dimensions for Spring-Centering Valves.

For port and mounting hole locations for all valves shown above, refer to drawings top page 22.

4

WAY-MOUNTING DIMENSIONS



SOLENOID ACTUATED VALVES (Hazardous Service -XDB_)

DOUBLE SOLENOID

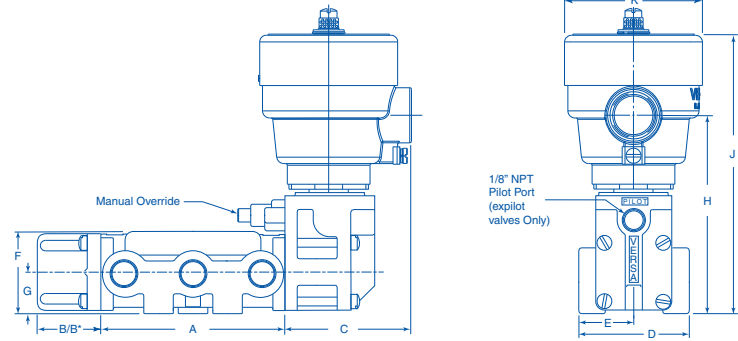

SINGLE SOLENOID

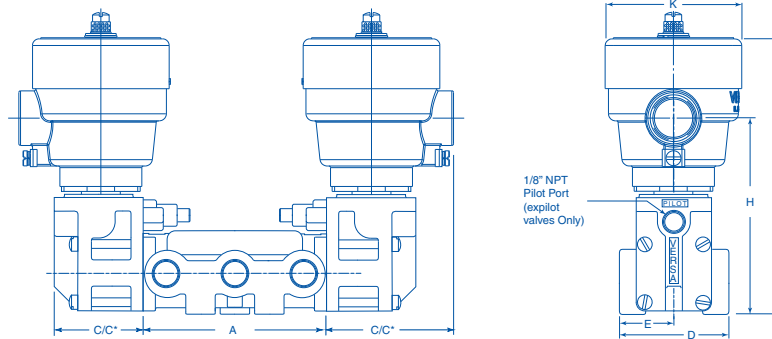

SIZE	A		B		B*		C		C*		D		E		F		G		H		J		K Ø	
	in	mm	in	mm	in	mm	in	mm	in	mm	in	mm	in	mm	in	mm	in	mm	in	mm	in	mm	in	mm
1/4" - 3/8"	3.50	88.9	1.15	29.2	1.84	47	2.31	58.7	2.94	74.7	2	51	1.0	25.4	1.56	39.6	.75	19.1	2.83	72	5.16	131.2	2.5	63.5
1/2"	4.0	101.6	1.15	29.2	1.84	47	2.31	58.7	2.94	74.7	2.5	63.5	1.25	31.8	1.56	39.6	.75	19.1	2.83	72	5.16	131.2	2.5	63.5
3/4" - 1"	8.63	219.1	2.01	51	—	—	13.8	350.5	—	—	3.75	95.3	1.88	47.8	2.5	63.5	1.19	30.2	4.9	124.3	6.5	165	2.5	63.5

*Dimensions for Spring-Centering Valves.

SOLENOID ACTUATED VALVES (Hazardous Service Valves -XMA_)

SINGLE SOLENOID

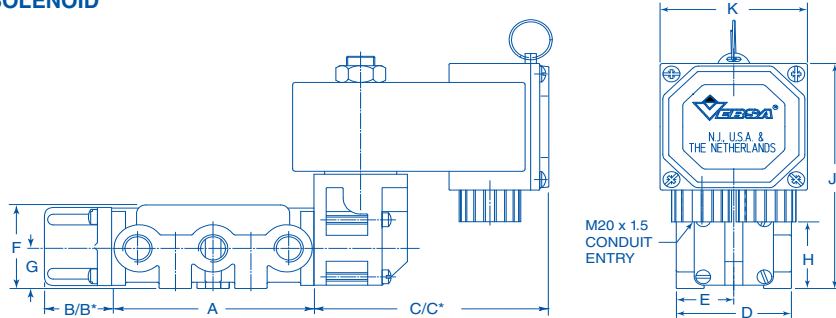

DOUBLE SOLENOID

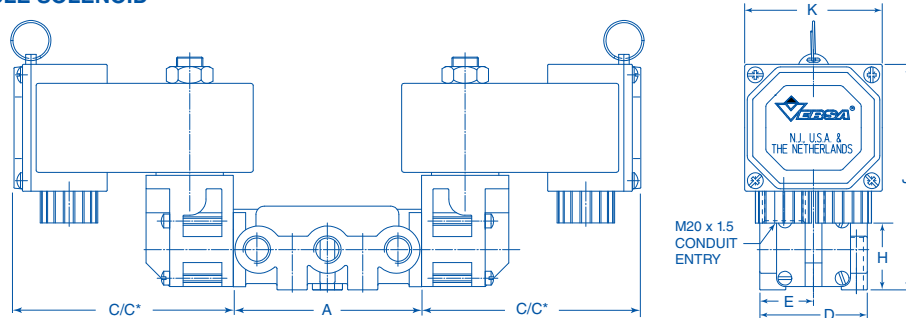

SIZE	A		B		B*		C		C*		D		E		F		G		H		J		K	
	in	mm	in	mm	in	mm	in	mm	in	mm	in	mm	in	mm	in	mm	in	mm	in	mm	in	mm	in	mm
1/4" - 3/8"	3.50	88.9	1.15	29.2	1.84	47	1.62	41.3	4.1	104.1	2	51	1	25	1.56	39.6	0.75	19.1	1.0	25.4	4.0	101	2.6	65
1/2"	4.0	101.6	1.15	29.2	1.84	47	1.62	41.3	4.1	104.1	2.5	63.5	1.25	31.8	1.56	39.6	0.75	19.1	1.0	25.4	4.0	101	2.6	65
3/4" - 1"	8.63	219.1	2.01	51	—	—	4.36	110.7	—	—	2.31	58.7	1.88	47.8	2.5	63.5	1.19	30.2	2.7	68.6	5.7	144.8	2.6	65

*Dimensions for Spring-Centering Valves. For port and mounting hole locations for all valves shown above, refer to drawings top page 22.

Combination Actuators



Combination Actuators are a combination of two actuating devices into one unit that can be applied to either end of a valve body assembly. This allows for a third actuating device to be applied to the opposite end of the valve body assembly.

Use of Combination Actuators allows for control of various interlock circuits, and in many cases reduces the total number of valves and overall circuitry required

for control of intricate systems.

Cross section drawings and descriptions are presented here for understanding of actuator function. They are indicated in the product number by use of the prefix "A" and the appropriate suffix that represents the specific Combination Actuator involved.

Manual

**Hand Lever-Spring Center
(D — One Direction)
Cap Assembly
CA-4302-69L-316-135LE
For 1/4" Thru 1/2" Valves**

This Cap Assembly is denoted in the prefix letters of the valve product no. by the letter "A" and suffix detail "-135LE"

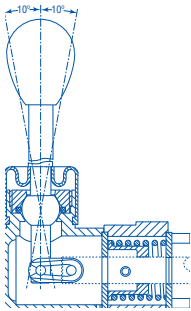

**Button-Two Detent
Cap Assembly
CA-4302-86-316-115E
For 1/4" Thru 1/2" Valves**

This Cap Assembly is denoted in the prefix letters of the valve product no. by the letter "A" and suffix detail "-115E."

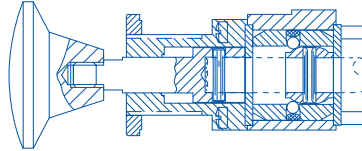

**Button-Spring Return (R)
Cap Assembly
CA-4302-86-316-136E
For 1/4" Thru 1/2" Valves**

This Cap Assembly is denoted in the prefix letters of the valve product no. by the letter "A" and suffix detail "-136E."

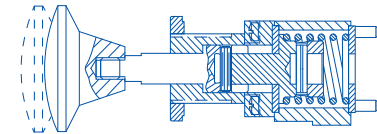

**Button-Spring Return (S)
Cap Assembly
CA-4302-86-316-136PE
For 1/4" Thru 1/2" Valves**

This Cap Assembly is denoted in the prefix letters of the valve product no. by the letter "A" and suffix detail "-136PE."

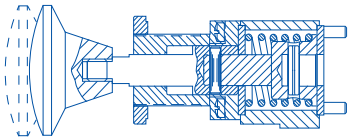

**Button-Reverse Spring
Return with Manual
Latch
CA-4302-86-316-136DRE
For 1/4" Thru 1/2" Valves**

This Cap Assembly is denoted in the prefix letters of the valve product no. by the letter "A" and suffix detail "-136DRE."

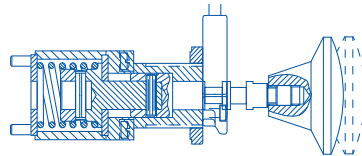

**Button-Spring Return
with Manual Latch
CA-4302-86-316-181DRE
For 1/4" Thru 1/2" Valves**

This Cap Assembly is denoted in the prefix letters of the valve product no. by the letter "A" and suffix detail "-181DRE."

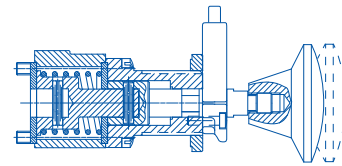

Pilot

**Pilot-Two Detent Cap
Assembly
CA-4302-64-316-150E
For 1/4" Thru 1/2" Valves**

This Cap Assembly is denoted in the prefix letters of the valve product no. by the letter "A" and suffix detail "-150E."

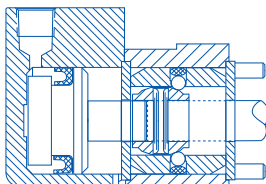

**Pilot, Push/Pull,
Spring Center
CA-4302-83-316-4003PE
For 1/4" Thru 1/2" Valves**

This Cap Assembly is denoted in the prefix letters of the valve product no. by the letter "A" and suffix detail "-4003PE."

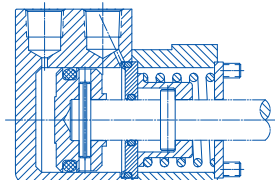

**Pilot, Push/Pull,
CA-4302-64-316-PPP
For 1/4" Thru 1/2" Valves**

This Cap Assembly is denoted in the prefix letters of the valve product no. by the letter "A" and suffix detail "PPP"

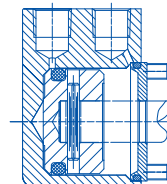

Pilot

Pilot, Pull CA-4302-64-316-PTP For 1/4" Thru 1/2" Valves

This Cap Assembly is denoted in the prefix letters of the valve product no. by the letter "A" and suffix detail "-PTP."

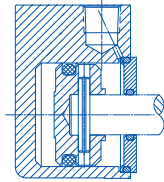

Pilot-Spring Return (S) CA-4302-64-316-159E For 1/4" Thru 1/2" Valves

This Cap Assembly is denoted in the prefix letters of the valve product no. by the letter "A" and suffix detail "-159E."

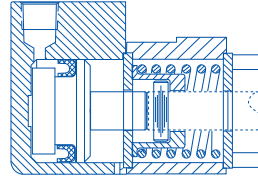

Pilot Pull Type "AIR LATCH" hold function only CA-4302-64-316-301E For 1/4" Thru 1/2" Valves

This Cap Assembly is denoted in the prefix letters of the valve product no. by the letter "A" and suffix detail "-301E"

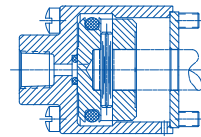

Pilot Pull Type "AIR LATCH" hold function only CA-4302-64-316-301RE For 1/4" Thru 1/2" Valves

This Cap Assembly is denoted in the prefix letters of the valve product no. by the letter "A" and suffix detail "-301RE"

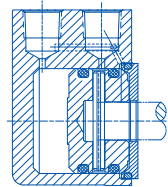

Solenoid/Pilot

Solenoid/Pilot-2 Detent Cap Assembly CA-4302-84-316-173E (EXPilot) CA-4322-84-316-173E (INPilot) For 1/4" Thru 1/2" Valves

This Cap Assembly is denoted in the prefix letters of the valve product no. by the letter "A" and suffix detail "-173E."

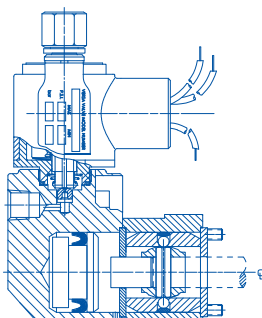

Solenoid/Pilot- Reverse Spring Return (R) Cap Assembly CA-4302-84-316-138E (EXPilot) CA-4322-84-316-138E (INPilot) For 1/4" Thru 1/2" Valves

This Cap Assembly is denoted in the prefix letters of the valve product no. by the letter "A" and suffix detail "-138E."

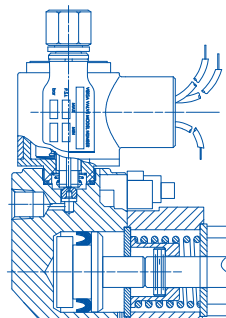

Solenoid/Pilot- Dual Piston Assembly CA-4302-84-316-DP (EXPilot) CA-4322-84-316-DP (INPilot) For 1/4" Thru 1/2" Valves

This Cap Assembly is denoted in the prefix letters of the valve product no. by the letter "A" and suffix detail "-DP"

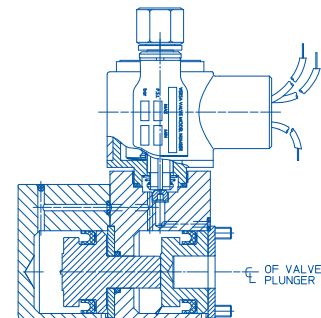

Push Pull Solenoid Suffix -PPG

General Description

A dual solenoid valve with a hand lever. The design concept is to provide the functionality of a dual coil, 2-position valve with the addition of manual control or any other actuator. The valve operates as standard 2-position requiring only momentary electrical contact to shift valve. Various manual actuators are available. The lever shown is an "L" type which can be manually set in either offset position when the solenoid valve is de-energized.

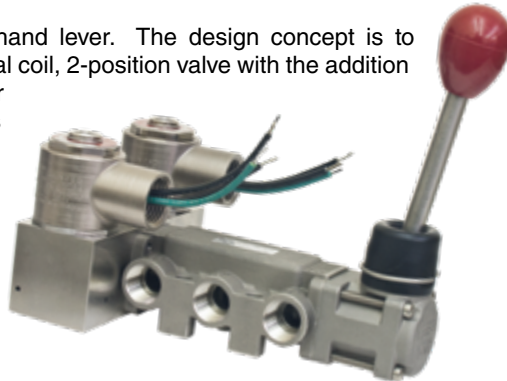

-PPG Flow Schematic

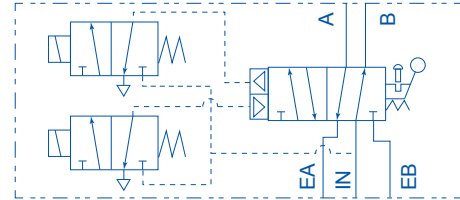

Redundant Solenoid 2oo2, Suffix -RS

General Description

When parallel electronic control circuits are utilized in a system, if a complete control circuit fails or requires maintenance, the parallel circuit will keep the system running. In a parallel circuit Versa's Redundant Valve functions the same as a solenoid operated-spring return valve, except that it has two solenoids (one for each of the parallel circuits) rather than one solenoid. Either or both of these solenoids will shift and maintain the controlled device in the shifted position. Both solenoids must be de-energized to return the controlled device to the un-shifted position. The use of one Redundant Valve can replace multiple valves and components to accomplish the same function. This function can be considered as a (2oo2).

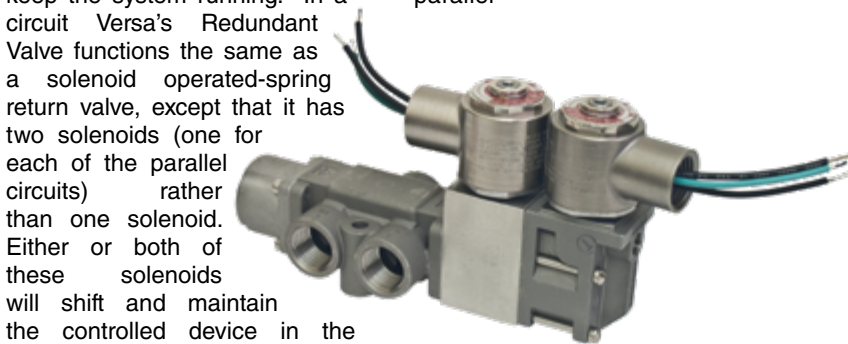

-RS Flow Schematic

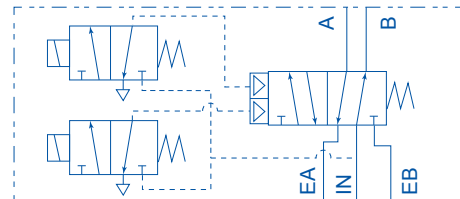

Shut Off Valve 1oo2, Suffix -SOV

General Description

While the Shut off Valve looks similar to the Redundant Solenoid Valve (shown above) the internal pilot circuit is different. The -SOV option provides a series pilot control circuit that requires both coils, a primary and a secondary, to be energized in order for the valve to shift. Conversely if the electrical signal to either coil is removed the valve will return to the de-energized position. This function can be considered as a (1oo2), where various control devices (e.g., temperature, pressure switches) could be wired in series with each coil. The actuation of any one of these devices, attached to either coil, would interrupt the signal to the coil and cause the valve to shift to the de-energized position.

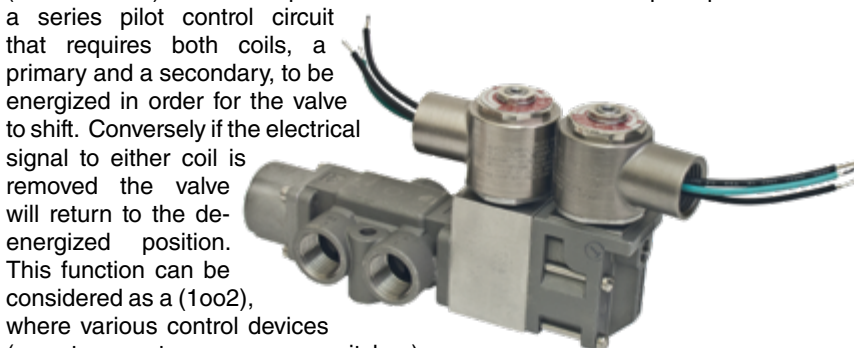

-SOV Flow Schematic

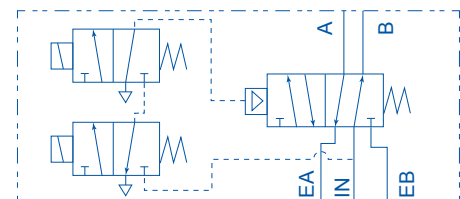

How to specify SPECIAL PURPOSE DUAL SOLENOID VALVES

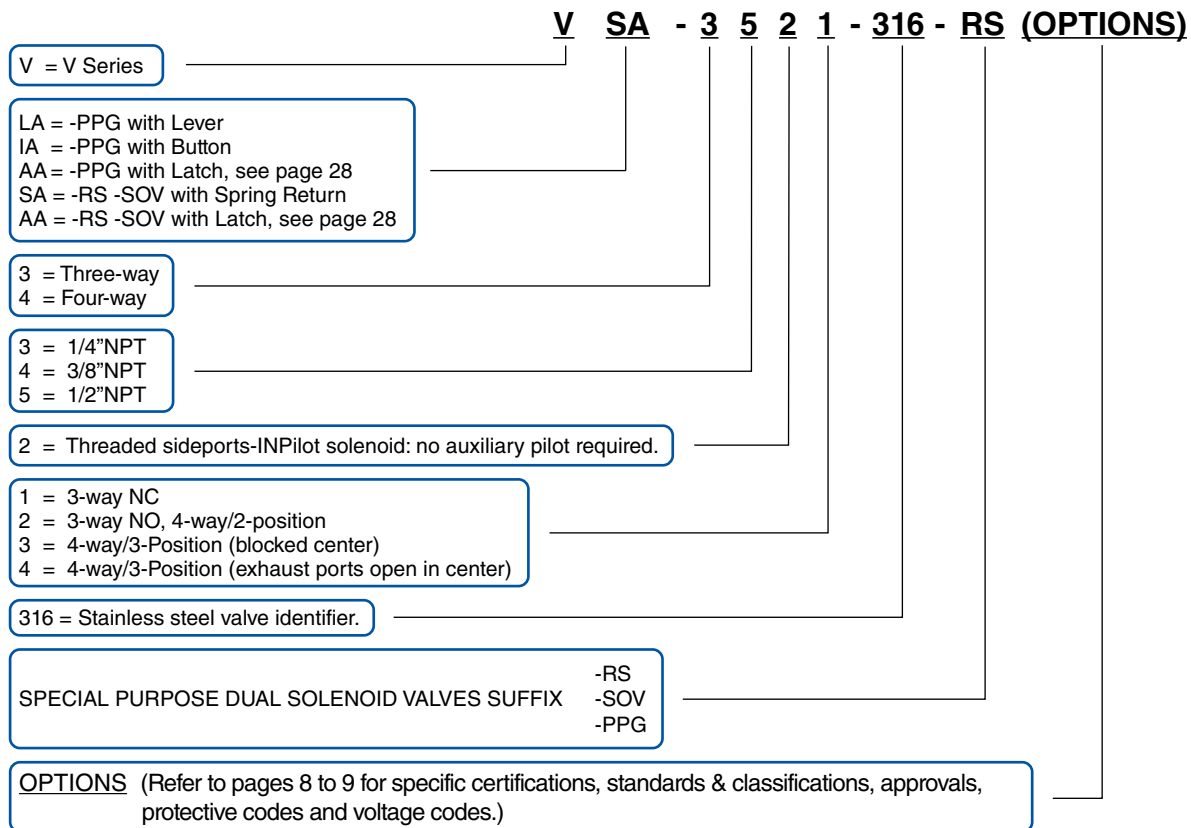

Installation, Filtration And Lubrication Valves have no limitations on mounting orientation. 40 to 50 micron filtration and general purpose lubricating oil ISO, ASTM viscosity grade 32 recommended.

Dimensions

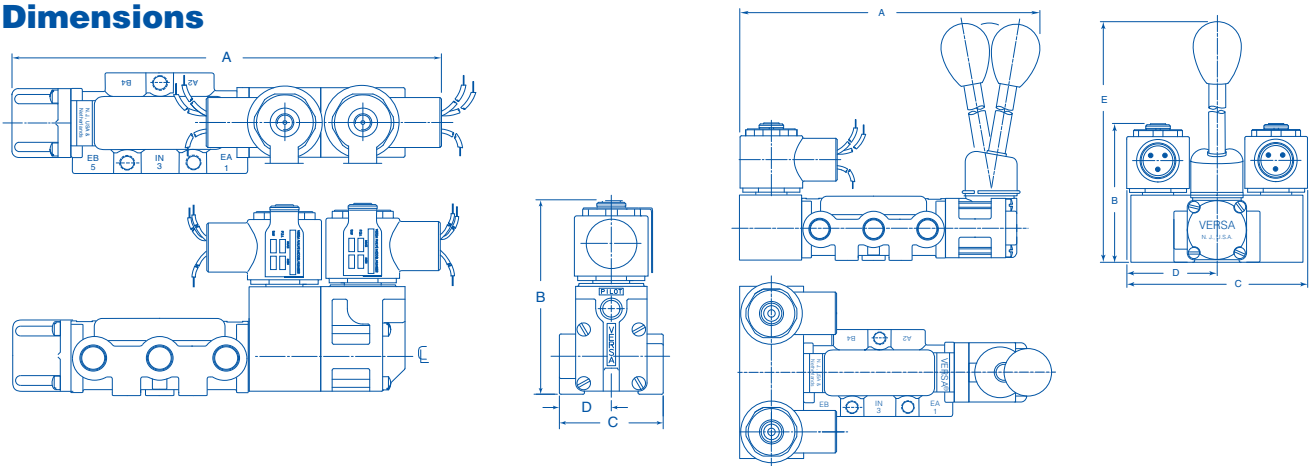

		SIZE		A	B [†]	C [†]	D
R S o r Y	3 W A Y	1/4 & 3/8	in	7.04	3.52	2.0	1
			mm	179	89	51	25.4
	1/2	in	7.69	3.52	2.5	1.25	
		mm	195	89	63.5	31.8	
S O V	4 W A Y	1/4 & 3/8	in	8.35	3.52	2.0	1
			mm	212	89	51	25.4
	1/2	in	8.85	3.52	2.5	1.25	
		mm	224.8	89	63.5	31.8	

		SIZE	A	B [†]	C [†]	D	E
P P G	3 W A Y	1/4 & 3/8	5.8	3.21	4.2	4.2	6.32
			147.3	81	106.6	106.7	160
	1/2	6.26	3.21	4.2	4.2	6.32	
		159	81	106.6	106.7	160	
	4 W A Y	1/4 & 3/8	7.28	3.21	4.2	4.2	6.32
			185	81	106.6	106.7	160
1/2	7.78	3.21	4.2	4.2	6.32		
198	81	106.6	106.7	160			

[†] Dimensions listed are for -XX type hazardous service solenoids. For dimensions with other hazardous service solenoids that can be applied, consult factory. Dimensions for standard non-hazardous service solenoids will be slightly less than those listed.

Latching valves are particularly suited to applications where it is desirable or mandatory to manually reset or restart a system. A typical application could involve the emergency shutdown of automatically monitored process operations. Loss or interruption of the control signal to the valve actuator causes the valve to shift, latch and shut-down a process step. When the signal is restored the valve remains in the latched position until the operator manually unlatches it and allows the process step to resume. Positive latching in such an application is vitally important since many process operations are sequential and one step must not be started until the one ahead of it has started.

This example is only one of many which can be accommodated through the use of Versa's Latching Valves. A wide range of functional types, port sizes, actuators, and latching arrangements provides the engineer with a complete choice of valves to meet the requirement of the application.

The Latching Device actuator consists of an integral spring for returning the valve plunger, and an inline hand operator where needed to manually shift the valve. The specific Latching Device may be attached to any Series V-316 valve body size or style. Typically the actuator on the opposite end of the valve body would be an automatic type such as a solenoid, a remote pressure pilot, or a low pressure diaphragm actuator.

Latching/Manual Reset Three-Way Valve, Solenoid Actuated. (VAG-3521-316-181D-XDBT1-D024 shown)

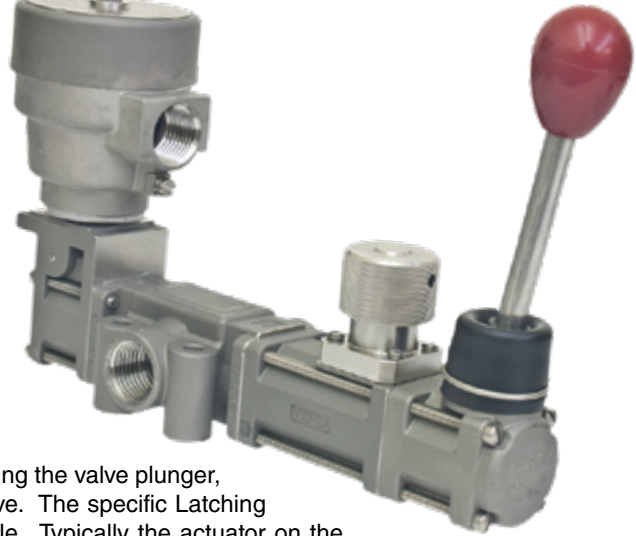

LATCHES IN ACTUATED POSITION

Suffix Detail-181BE

Latches automatically when plunger shifts on signal. Unlatching allows plunger to be returned by hand.

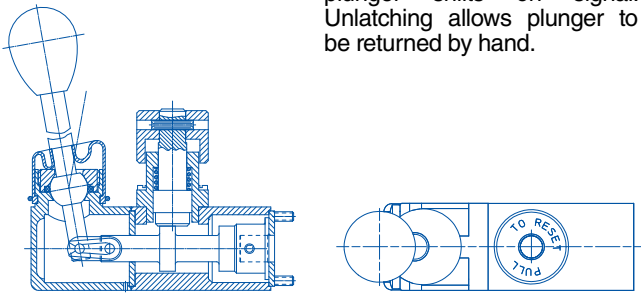

LATCHES IN UNACTUATED POSITION

Suffix Detail -181D

Unlatching allows valve spool to be shifted manually or on signal. Spring returns valve spool automatically when signal is removed, and valve latches. (If hand lever is not required, see suffix -3358E below.)

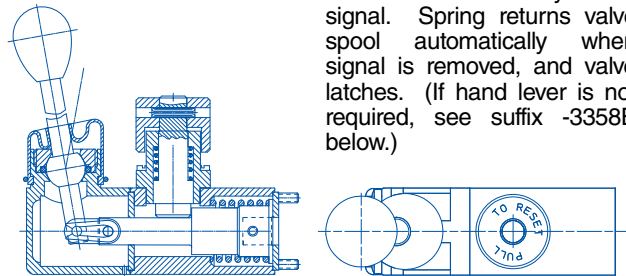

Suffix Detail -3358E

Unlatching allows plunger to shift on signal. Spring returns plunger automatically and valve latches. (If hand lever is required for manual actuation see suffix -181D above.) (not available 3/4", 1")

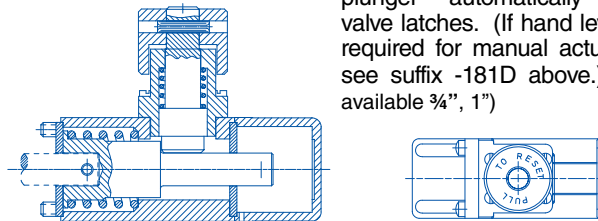

Suffix Detail -181CE

Latches automatically when valve spool has been shifted on signal or manually against the spring. Unlatching allows the spring to return the valve spool automatically. (If hand lever is not required, see suffix -3358AE bottom right.) (not available 3/4", 1")

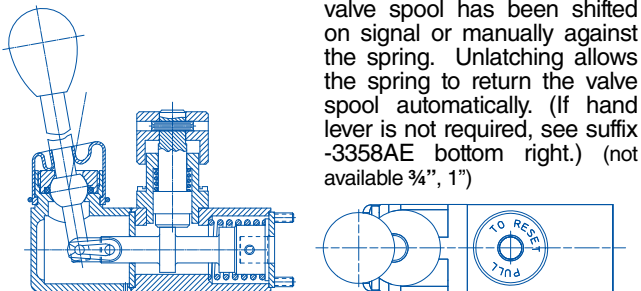

Suffix Detail-3358AE

Latches automatically when valve spool shifts on signal. Unlatching allows the spring to return valve spool automatically. (If hand lever is required for manual actuation see suffix -181CE above.) (not available 3/4", 1")

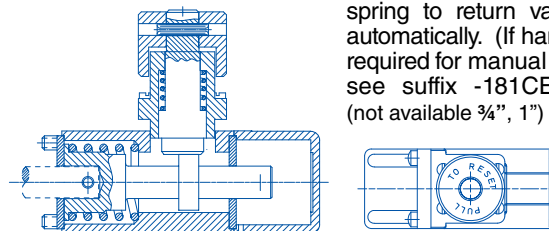

V AG - 3 5 2 1 - 316 - 181B - (OPTIONS)

V = Pneumatic service: vacuum to 200 psi (14 bar)

AG = Solenoid/pilot operated (NEMA 1,2,3)
(2NC, 3NC, 4-way, 5-way, Selector, Diverter)
AP = Remote pressure pilot operated
(2NC, 3NC, 4-way, 5-way, Selector, Diverter)
AW= Diaphragm (low pressure) pilot operated
(2NC, 3NC, 4-way, 5-way, Selector, Diverter) (not available 3/4", 1")
GA = Solenoid/pilot operated (NEMA 1,2,3)
(2NO, 3NO, Selector, Diverter)
PA = Remote pressure pilot operated
(2NO, 3NO, Selector, Diverter)
WA = Diaphragm (low pressure) pilot operated
(2NO, 3NO, Selector, Diverter) (not available 3/4", 1")

2 = Two-way
3 = Three-way
4 = Four-way
5 = Five-way
7 = Diverter (one inlet-two outlets)
8 = Selector (two inlets-one outlet)

3 = 1/4" NPT
4 = 3/8" NPT
5 = 1/2" NPT
6 = 3/4" NPT
7 = 1" NPT

0 = Threaded side ports - For all type actuators:
For controlling vacuum to 200 psi (14 bar) air and where controlled medium or source is different than pilot medium or source. Solenoid/pilot or remote pressure pilot requires aux pilot pressure 40-175 psi (2.8-12 bar) air. Diaphragm pilot requires aux pilot pressure 5-50 psi (0.34-3.4 bar) air.
2 = Threaded side ports - INPilot solenoid only:
For controlling pressures 40-175 psi (2.8-12 bar) air. No auxiliary pilot required.

1= 2NC, 3NC
2= 2NO, 3NO, 4-way two position, 5-way two position, Selector, Diverter
3= Three-position, 3, 4, 5-way, Selector, Diverter,-all ports closed in center position.
4= Three-position, 3, 4-way, — exhaust ports open in center position.

316 = Stainless steel valve identifier.

Available 1/4" - 1" NPT	
-181BE	
-181D	Locking/reset device
Available 1/4" - 1/2" NPT	(refer to page 30 for
-181CE	specific device required)
-3358AE	
-3358E	

OPTIONS

-XX = Solenoid operator for hazardous service (NEMA 7 & 9);
Class I, Division 2 (A & B); Class I, Division 1 (C & D);
Class II, Division 1 (E, F & G).
-LB = Low watt (1.8W) solenoid operator for hazardous service (NEMA 7 & 9)
Max operating pressure 120 PSI (8.3 bar)

ByPass Valve

General Description

Versa's ByPass valve provides an option for testing solenoid valve control circuits in applications where closing down or "shutting in" the system is not an option. The ByPass valve allows the testing and replacement of a component within the circuit without shutting down the main system. Versa's solution is simple to apply, operate and is accomplished in one valve. The basic valve is a 3-position manual valve. Operation is as follows:



Position 1. This position is the normal position or the regular operation mode.

Position 2. This position places the control circuit in the test mode. In this position the ByPass valve allows pressure to the circuit for testing while maintaining pressure on the actuator. With pressure to solenoid inlet and solenoid circuit outlet blocked/isolated this position allows complete testing of solenoid circuit without shutting down the system.

Position 3. This position places the control system in a replace mode. Should it be determined that a component in the control circuit needs to be repaired and or replaced this position allows total isolation from pressure while still holding system pressure to actuator.

Based on Versa proven V-316 series high flow valve. Actuation is available as a rotary switch or key operated. Optional position indication available.

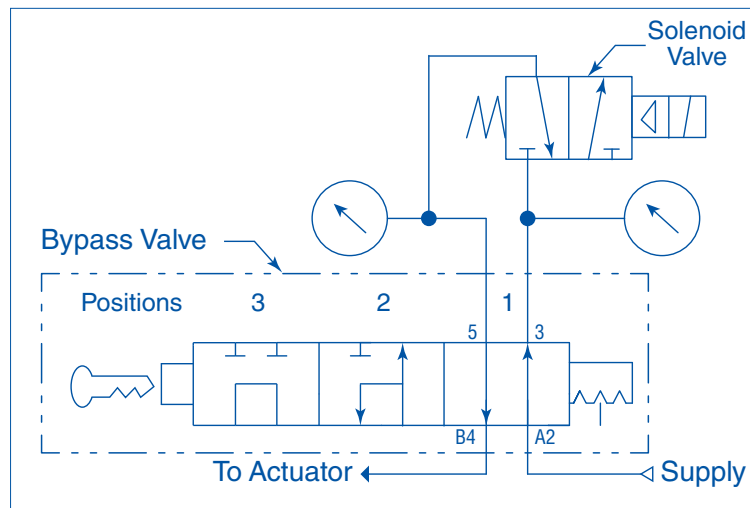

Dimension Drawing

VAU-450X-316-314E***-9E-2039 is shown with key actuation and optional position indicator.

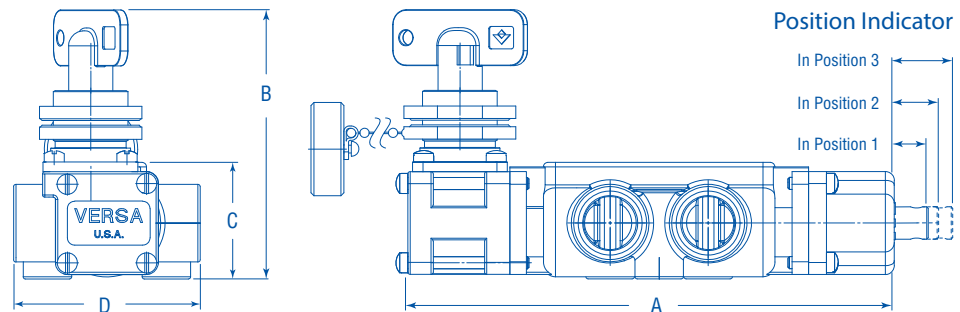

Port SIZE*	A		B		C		D		Position 1		Position 2		Position 3	
	in	mm	in	mm	in	mm	in	mm	in	mm	in	mm	in	mm
1/2	6.52	166	3.61	92	1.56	39.7	2.5	63.5	0.45	11.5	0.63	16	0.80	20.5

*For 1/4" port size see C-316 Series Bulletin. Not available in 1".
For port and mounting hole locations refer to drawings top page 22

Palm Button Actuated, 3-Way or 4-Way Valves

LOCKOUT

The Versa Lockout valve is available in two configurations, locked in one position only or locked in either closed or open position

The LOVBE is an OSHA approved 3-Way, Lockout valve that is Normally Closed in the locked position, blocking the inlet and bleeding all air in the system to atmosphere.

The LOVEE is available as a 3-Way or 4-Way valve that can be locked in either open or closed position.

INDICATOR

Versa's new -403RG option for the V-316 Series valves offers pressure indication on a manually operated, 3-way valve.

The valve's visual indication will reveal whether a circuit is pressurized or vented.

The Pressure Indicator (Suffix -403RG) signals, through the use of colored indicators, the presences of pressure at valve A port. Red indicates that there is no pressure on the A port, while green indicates that the A port is pressurized and the valve is in the actuated position.

Other colors available.



VZI-3301-316-LOVBE shown

- Options
 Suffix -LOVBE Lock out in one position
 Suffix -LOVEE Lock out in both positions
 Suffix -125R Red Button
 Suffix -125G Green button



VIZ-3301-316-403RG Shown

- Options
 Suffix -403RG Red when 'A' port is vented, green when pressurized
 Suffix -403YG Yellow when 'A' port is vented, green when pressurized
 Suffix -403BG Black when 'A' port is vented, green when pressurized
 Suffix -LOVBE Lock out in one position
 Suffix -LOVEE Lock out in both positions

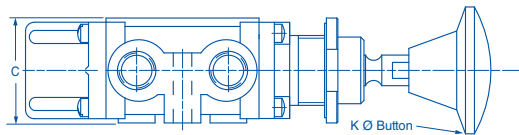
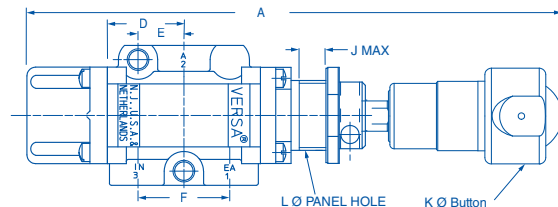
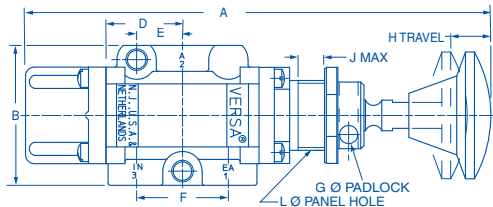

DIMENSIONS		PORT SIZE*	A		B		C		D		E		F		G Ø		H		J		K Ø		L Ø	
			in	mm	in	mm	in	mm	in	mm	in	mm	in	mm	in	mm	in	mm	in	mm	in	mm	in	mm
Lockout	3 WAY	1/4" - 3/8"	6.3	101.6	2.0	51	1.5	38.1	1.09	29.2	0.66	16.7	0.62	15.8	0.26	6.5	0.34	8.6	0.5	12.7	1.81	46	1.0	25.4
		1/2"	6.9	175	2.5	63.5	1.56	39.6	1.42	36	0.66	16.7	1.32	33.5	0.26	6.5	0.34	8.6	0.5	12.7	1.81	46	1.0	25.4
	4 WAY	1/4" - 3/8"	7.28	193.5	2.0	51	1.56	39.6	1.75	44.5	0.66	16.7	1.26	32.5	0.26	6.5	0.34	8.6	0.5	12.7	1.81	46	1.0	25.4
		1/2"	8.12	206	2.5	63.5	1.56	39.6	2.0	51	0.66	16.7	1.31	33.3	0.26	6.5	0.34	8.6	0.5	12.7	1.81	46	1.0	25.4
Indicator	3 WAY	1/4" - 3/8"	7.96	202.2	2.0	51	1.5	38.1	1.09	29.2	0.66	16.7	0.62	15.8	0.26	6.5	0.34	8.6	0.5	12.7	1.38	35	1.0	25.4
		1/2"	8.3	209.5	2.5	63.5	1.56	39.6	1.42	36	0.66	16.7	1.32	33.5	0.26	6.5	0.34	8.6	0.5	12.7	1.38	35	1.0	25.4
	4 WAY	1/4" - 3/8"	8.91	226.3	2.0	51	1.56	39.6	1.75	44.5	0.66	16.7	1.26	32.5	0.26	6.5	0.34	8.6	0.5	12.7	1.38	35	1.0	25.4
		1/2"	9.41	259	2.5	63.5	1.56	39.6	2.0	51	0.66	16.7	1.31	33.3	0.26	6.5	0.34	8.6	0.5	12.7	1.38	35	1.0	25.4

*Not available in 1"

General Description

The Versa Modular Air Package is a compact air management system, based on V-316 Series components, that will provide a full range of pneumatic accessories and functions to meet the needs of most control systems in the actuator control industry. Major components are shutoff and check valves, filter/regulators, speed controls and directional control valves.

Design Benefits

Versa's VMAP simplifies the design process by combining all the components of a common circuit into one integrated assembly. Whether a standard shutoff circuit or an intricate control system, VMAP has the features to meet the requirements of any control project. VMAP will reduce engineering, components, vendors, costs, weight and save time.

TROUBLE FREE. Designed with integral assembly flanges combined with all O ring interface sealing and standard fasteners. Long leak free service life is accomplished. No custom or flat gaskets to leak or brackets to fail.

EFFICIENCY. VMAP's modular design effectively groups common automation and controls components together in user approved groupings to combine features and reduce size and weight.

TECHNOLOGY. Utilizing the latest in computer aided design and finite element software flow is maximized yielding the highest flow in the smallest of packages.

PROVEN. VMAP is based on Versa's field proven V-316 Series product. Having over 30 years of acceptance in providing bubble tight sealing through Versa's packed plunger technology.

CUSTOM CIRCUITRY is achieved through modular design by simply combining various components to create the desired circuit

FLEXIBILITY. Many standard and custom circuits are easily created using the VMAP modular concept.

RELIABILITY. The reliability of the Versa V-316 Series combined with industry approved materials yields a proven product. SIL (Safety Integrity Levels) exceeding most application requirements.

INNOVATIVE. Through the use of investment casting technology main components are integrated saving space while reducing potential leakage points.

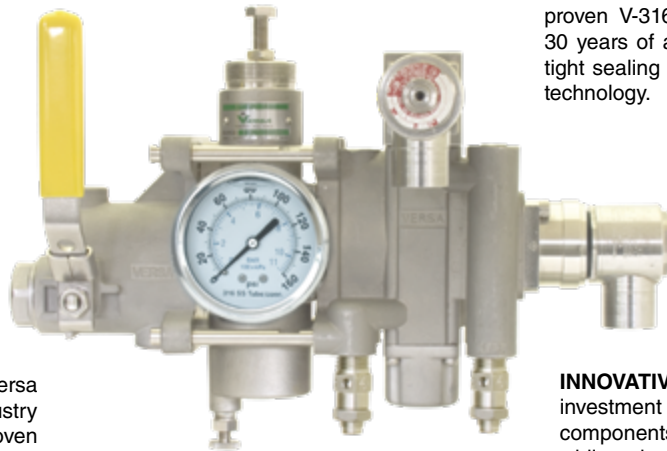

ENGINEERING BENEFITS

- Standard or custom circuits available utilizing VMAP's modular components.
- Convenience of one purchase order and one vendor.
- No need for developing Bill of Materials for fittings, tubing and bracketing.
- No need for designing a complete layout of many different system components.
- No need for designing brackets for many individual components.

FIELD BENEFITS

- Ease of repair: By removing a few screws the various modules can be disassembled and inspected, no tubing or fittings to remove.
- Field configurability of function after installation: Add more valves as the requirements of the process change.
- 10 year warranty

INSTALLATION BENEFITS

- Reducing fittings, tubing and related labor costs
- Reduction in size and weight
- One component to mount

Current Technology



See VMAP Bulletin online at Versa Website

NEW



VMAP and Panel shown at scale

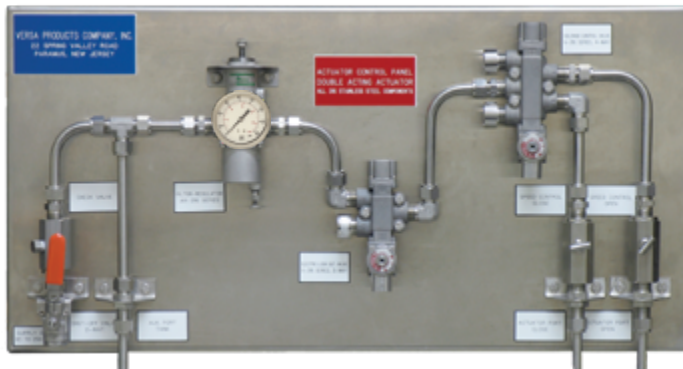

MISCELLANEOUS INFORMATION

Hazardous Location Combination Suffix Details

Cross Reference Chart

Suffix Reference	
Suffix	Description
-CD	72" wire leads
-D14	Solenoid vent, water proof nut
-H2E	1/8" npt Solenoid vent
-HE	1/4" npt Solenoid vent
-HT	Class H coil
-L14	Solenoid vent dust nut
-LA	0.85 watt Solenoid
-LB	1.8 watt Solenoid
-LV	0.85 watt (World Solenoid)
-LX	1.8 watt (World Solenoid)
-LZ	0.5 watt (World Solenoid)
-PC	Potted coil, NEMA 4
-PS	Potted coil, male conduit;
-ST	Stainless Solenoid housing
-XDBS	World Solenoid**
-XDBT	World Solenoid**
-VJBT	Add on Junction Box
-XN	ATEX Solenoid
-XT	World Solenoid**
-XV	World Solenoid, North America
-XX	North American Solenoid
-303D	Integral diode

North American (-XX) (Cont.)	
Combination Suffix	Included Suffix
-XXK	-XX, -HT, -LB, -PC, -ST
-XXK4	-XX, -D14, -HT, -LB, -PC, -ST
-XXL	-XX, -PC
-XXL4	-XX, -D14, -PC
-XXM	-XX, -HT, -PC
-XXM4	-XX, -D14, -HT, -PC
-XXN	-XX, -LB, -PC
-XXN4	-XX, -D14, -LB, -PC
-XXP	-XX, -HT, -LB, -PC
-XXP4	-XX, -D14, -HT, -LB, -PC
-XXQ	-XX, -HT, -LB
-XXQ4	-XX, -D14, -HT, -LB
-XXR	-XX, -LB
-XXR4	-XX, -D14, -LB
-XXS	-XX, -LA, -ST
-XXS4	-XX, -D14, -LA, -ST
-XXU	-XX, -HT, -LB, -ST
-XXU4	-XX, -D14, -HT, -LB, -ST
-XXV	-XX, -LA
-XXV4	-XX, -D14, -LA
-XXW	-XX, -CD, -HT, -H2, -PC, -ST
-XXW4	-XX, -D14, -CD, -HT, -PC, -ST

ATEX (-XN) (Cont.)	
Combination Suffix	Included Suffix
-XNQ	-XN, -HT, -LB
-XNR	-XN, -LB
-XNS	-XN, -LA, -ST
-XNU	-XN, -HT, -LB, -ST
-XNV	-XN, -LA
-XNX	-XN, -LB, -PS
-XNWS	-XN, -VJBT, -LB, -PS

World Solenoid (-XDB, -XT, -XV)		
Combination Suffix		Included Suffix
1.8 Watt	0.85 Watt	
-XDBS1	-XDBS1C	-XDBS, -HT, -LX
-XDBS2	-XDBS2C	-XDBS, -HT, -LX, -H2E
-XDBS3	-XDBS3C	-XDBS, -HT, -LX, -HE
-XDBS4	-XDBS4C	-XDBS, -HT, -LX, -L14
-XDBS5	-XDBS5C	-XDBS, -HT, -LX, -303D
-XDBS6	-XDBS6C	-XDBS, -HT, -LX, -H2E, -303D
-XDBS7	-XDBS7C	-XDBS, -HT, -LX, -HE, -303D
-XDBS8	-XDBS8C	-XDBS, -HT, -LX, -L14, -303D
-XDBS9	-XDBS9C	-XDBS, -HT, -LX, -D14
-XDBS10	-XDBS10C	-XDBS, -HT, -LX, -D14, -303D
-XDBT1	-XDBT1C	-XDBT, -HT, -LX
-XDBT2	-XDBT2C	-XDBT, -HT, -LX, -H2E
-XDBT3	-XDBT3C	-XDBT, -HT, -LX, -HE
-XDBT4	-XDBT4C	-XDBT, -HT, -LX, -L14
-XDBT5	-XDBT5C	-XDBT, -HT, -LX, -303D
-XDBT6	-XDBT6C	-XDBT, -HT, -LX, -H2E, -303D
-XDBT7	-XDBT7C	-XDBT, -HT, -LX, -HE, -303D
-XDBT8	-XDBT8C	-XDBT, -HT, -LX, -L14, -303D
-XDBT9	-XDBT9C	-XDBT, -HT, -LX, -D14
-XDBT10	-XDBT10C	-XDBT, -HT, -LX, -D14, -303D
-XV1	-XV1C	-XV, -HT, -LX
-XV2	-XV2C	-XV, -HT, -LX, -H2E
-XV3	-XV3C	-XV, -HT, -LX, -HE
-XV4	-XV4C	-XV, -HT, -LX, -L14
-XV9	-XV9C	-XV, -HT, -LX, -D14
-XT1	-XT1C	-XT, -HT, -LX
-XT2	-XT2C	-XT, -HT, -LX, -H2E
-XT3	-XT3C	-XT, -HT, -LX, -HE
-XT4	-XT4C	-XT, -HT, -LX, -L14
-XT9	-XT9C	-XT, -HT, -LX, -D14

North American (-XX)	
Combination Suffix	Included Suffix
-XXA	-XX, -HT
-XXA4	-XX, -D14, -HT
-XXB	-XX, -PS
-XXB4	-XX, -D14, -PS
-XXC	-XX, -HT, -PS
-XXC4	-XX, -D14, -HT, -PS
-XXD	-XX, -ST
-XXD4	-XX, -D14, -ST
-XXE	-XX, -PC, -ST
-XXE4	-XX, -D14, -PC, -ST
-XXF	-XX, -HT, -ST
-XXF4	-XX, -D14, -HT, -ST
-XXG	-XX, -LB, -ST
-XXG4	-XX, -D14, -LB, -ST
-XXH	-XX, -HT, -PC, -ST
-XXH4	-XX, -D14, -HT, -PC, -ST
-XXJ	-XX, -LB, -PC, -ST
-XXJ4	-XX, -D14, -LB, -PC, -ST

ATEX (-XN)	
Combination Suffix	Included Suffix
-XNA	-XN, -HT
-XND	-XN, -ST
-XNE	-XN, -PC, -ST
-XNE4	-XN, -D14, -PC, -ST
-XNF	-XN, -HT, -ST
-XNG	-XN, -LB, -ST
-XNH	-XN, -HT, -PC, -ST
-XNJ	-XN, -LB, -PC, -ST
-XNJ4	-XN, -D14, -LB, -PC, -ST
-XNK	-XN, -HT, -LB, -PC, -ST
-XNL	-XN, -PC
-XNL4	-XN, -D14, -PC
-XNM	-XN, -HT, -PC
-XNN	-XN, -LB, -PC
-XNN4	-XN, -D14, -LB, -PC
-XNP	-XN, -HT, -LB, -PC

Recommended Hazardous Location Solenoid Option Packages

(For complete specifications please see above and page 8)

Enclosure/Wire	Certification/Power			
	North American - CSA		ATEX - IECEx - INMETRO	
	Standard Power	Low Watt*	Standard Power	Low Watt*
Steel, Electroless Nickel Plated, 24 Inch Leads	-XXL4	-XXN4	-XNL4	-XNN4
Stainless Steel, High Performance 430 type, 24 Inch leads	-XXE4	-XV9	-XNE4	-XT9**
Stainless Steel, 316L type, Junction Box with Terminal Strip	—	-XDBT9**	—	-XDBS9**

*1.8 watt solenoid. Also available 0.85 watt, see cross reference chart above, 1.8 & 0.85 not available on E. For 0.50 watt, consult factory.

**All the -XDBS, -XDBT & -XT solenoids are "World Solenoids" certified for North America, ATEX, IECEx and INMETRO. For additional certifications consult factory. -XV solenoids certified for North America. See page 8 for additional options.



Versa has been supplying the fluid power industry with pneumatic and hydraulic components for over 50 years. We have built a reputation for quality that is unsurpassed in the market for high performance solenoids, pneumatic relays, resets and pilot valves.

WARNINGS REGARDING THE DESIGN APPLICATION, INSTALLATION AND SERVICE OF VERSA PRODUCTS

The warnings below must be read and reviewed before designing a system utilizing, installing, servicing, or removing a Versa product. Improper use, installation or servicing of a Versa product could create a hazard to personnel and property.

DESIGN APPLICATION WARNINGS

Versa products are intended for use where compressed air or industrial hydraulic fluids are present. For use with media other than specified or for non-industrial applications or other applications not within published specifications, consult Versa.

Versa products are not inherently dangerous. They are only a component of a larger system. The system in which a Versa product is used must include adequate safeguards to prevent injury or damage in the event of system or product failure, whether this failure be of switches, regulators, cylinders, valves or any other system component. System designers must provide adequate warnings for each system in which a Versa product is utilized. These warnings, including those set forth herein, should be provided by the designer to those who will come in contact with the system.

Where questions exist regarding the applicability of a Versa product to a given use, inquiries should be addressed directly to the manufacturer. Confirmation should be obtained directly from the manufacturer regarding any questioned application prior to proceeding.

INSTALLATION, OPERATION AND SERVICE WARNINGS

Do not install or service any Versa product on a system or machine without first depressurizing the system and turning off any air, fluid, or electricity to the system or machine. All applicable electrical, mechanical, and safety codes, as well as applicable governmental regulations and laws must be complied with when installing or servicing a Versa product.

Versa products should only be installed or serviced by qualified, knowledgeable personnel who understand how these specific products are to be installed and operated. The individual must be familiar with the particular specifications, including specifications for temperature, pressure, lubrication, environment and filtration for the Versa product which is being installed or serviced. Specifications may be obtained upon request directly from Versa. If damages should occur to a Versa product, do not Operate the system containing the Versa product. Consult Versa for technical information.

LIMITED WARRANTY DISCLAIMER AND LIMITATION OF REMEDIES

Versa's Series products are warranted to be free from defective material and workmanship for a period of ten years from the date of manufacture, provided said products are used in accordance with Versa specifications. Versa's liability pursuant to that warranty is limited to the replacement of the Versa product proved to be defective provided the allegedly defective product is returned to Versa or its authorized distributor. Versa provides no other warranties, expressed or implied, except as stated above. There are no implied warranties of merchantability or fitness for a particular purpose. Versa's liability for breach of warranty as herein stated is the only and exclusive remedy and in no event shall Versa be responsible or liable for incidental or consequential damages.

Versa Products Company, Inc.
22 Spring Valley Road
Paramus, New Jersey 07652
USA
Phone: (201) 843-2400
Fax: (201) 843-2931

Versa BV
Prins Willem Alexanderlaan 1427
7321 GB Apeldoorn
The Netherlands
Phone: +31-55-368-1900
Fax: +31-55-368-1909



www.versa-valves.com
email: sales@versa-valves.com