

VELUX®

Foster + Partners

Rooflights

**The VELUX Modular Skylight system
for commercial building**

Version 4.0

velux.co.uk/modularskylights



Front cover: Longlights in University of Southern Denmark, Odense, Denmark

Above: Atrium Longlight in DSV Headquarter, Hedeusene, Denmark

Advanced, innovative and proven

When you develop something that could potentially change the way rooflights are designed, specified, installed and operated for a very long time, you are bound to use expensive words like the three keywords above. However, as we begin to describe how special our rooflights are, it seems obvious that these three are well covered and signed for. When VELUX Modular Skylights were introduced in 2011, it was the first prefabricated rooflight concept to

incorporate high energy performance, thermal stability and great strength in a slim and fully integrated design. To our delight, our modular skylights have since then established themselves as the most innovative rooflight system on the market. And it is now the proven choice in commercial buildings throughout Europe.



“ This is our contribution in terms of pushing the prefabrication of sophisticated building elements forward.

Paul Kalkhoven
Senior partner at Fosters + Partners

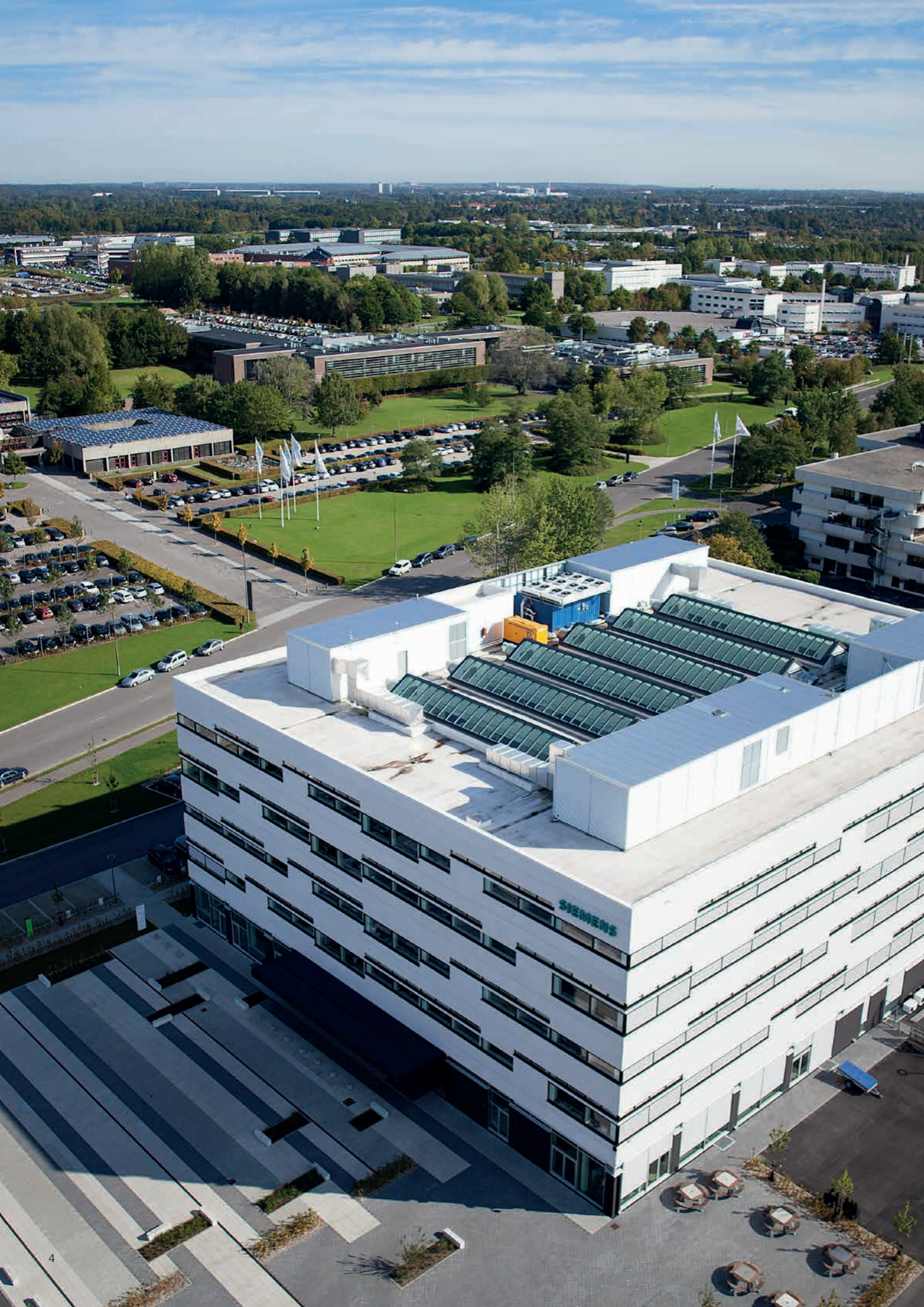

Index

Design	6
Rooflight solutions	6
What you draw is what you get	8
Integrated actuator	9
Advanced daylight and heat control	10
VELUX INTEGRA® or open system	11
Size grid	12
Material surface Exterior/Interior	14
References:	16
Longlight 5 – 25°	16
Wall-mounted Longlight 5 – 40°	18
Northlight 40 – 90°	19
Ridgelight 25 – 40°	20
Ridgelight 5° with beam	24
Atrium Longlight/Ridgelight	26
Performance	28
Watertightness	28
Airtightness	29
Strength	30
Energy	31
Glazing and U-values	32
Tests and classifications	34
Modularity	36
The skylight module	36
One module for all solutions	37
Installation	38
Photovoltaic panels	40
External awning blinds	41
Support	42
Technical drawings, 2D	42
CAD/BIM objects, 3D	43
Sub-construction	44
VELUX Daylight Visualizer	45
Design phase	46
Installation phase	46
Daily operation	47
Guarantee	47
Contact	47

Ridgelights in Siemens Head Office,
Ballerup, Denmark

Design

Rooflight solutions

The modular skylight system allows you to create eight different configurations for a variety of room and building types, ranging from narrow corridors and small courts to large studios and areas

intended for circulation. Each solution is delivered with a prefabricated flashing that ensures perfect system fit and a 100% water-tight solution.

Longlight 5 - 25°

Page 16

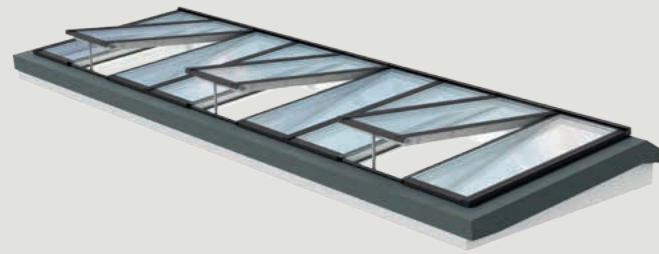

Wall-mounted Longlight 5 - 40°

Page 18



Ridgelight 25 - 40°

Page 20

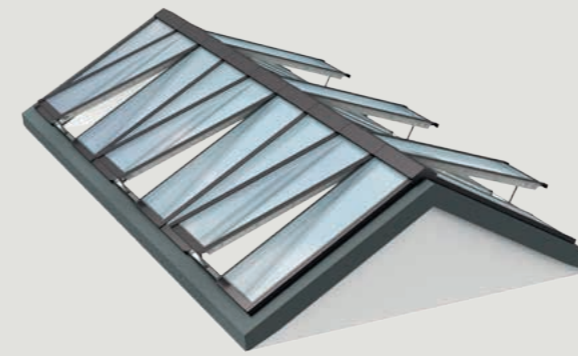

Ridgelight at 5° with Beam

Page 24

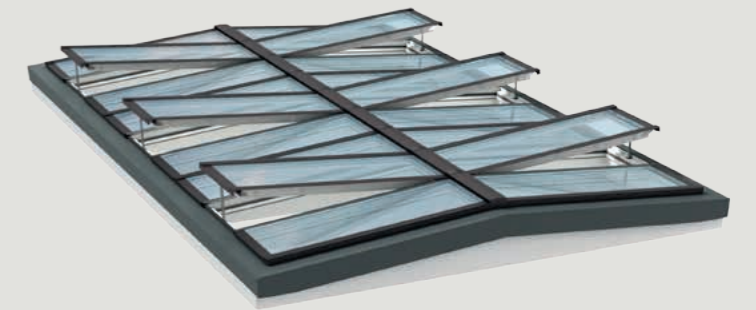

Northlight 40 - 90°

Page 19



Atrium Longlight 5 - 25°

Page 26

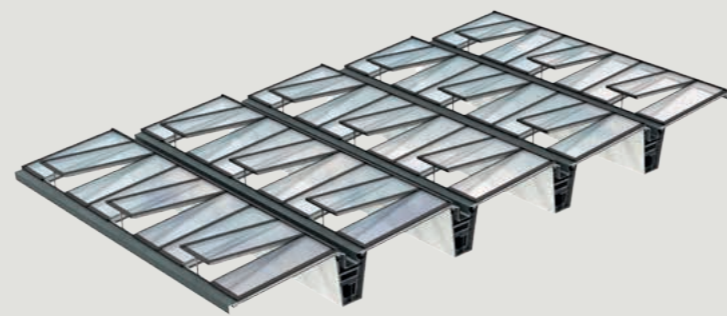

Atrium Ridgelight 25 - 40°

Page 26

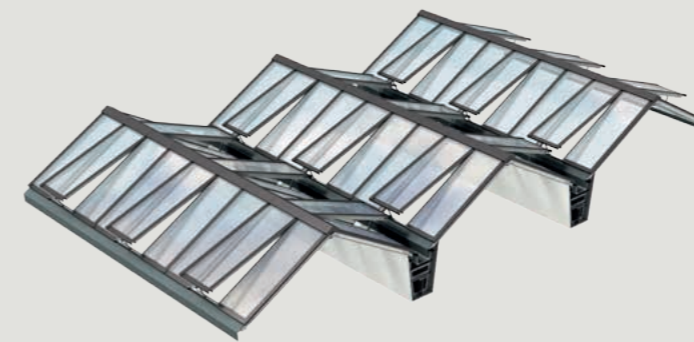

Atrium Ridgelight at 5° with Beam

Page 26

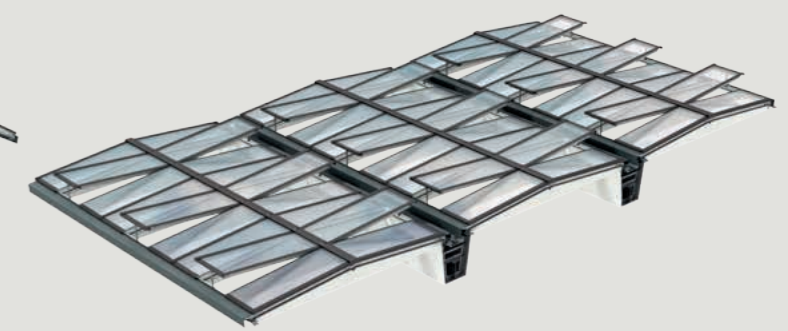

Design

A one-step approach to daylight, ventilation and indoor comfort



Longlight in ASSA ABLOY office, Apeldoorn, the Netherlands

What you draw is what you get

The simplicity of the modular skylights design and the fully integrated actuator make it impossible to distinguish between fixed and venting modules. The visual

uniformity means that even a simple sketch is likely to create a lifelike image of the final product.

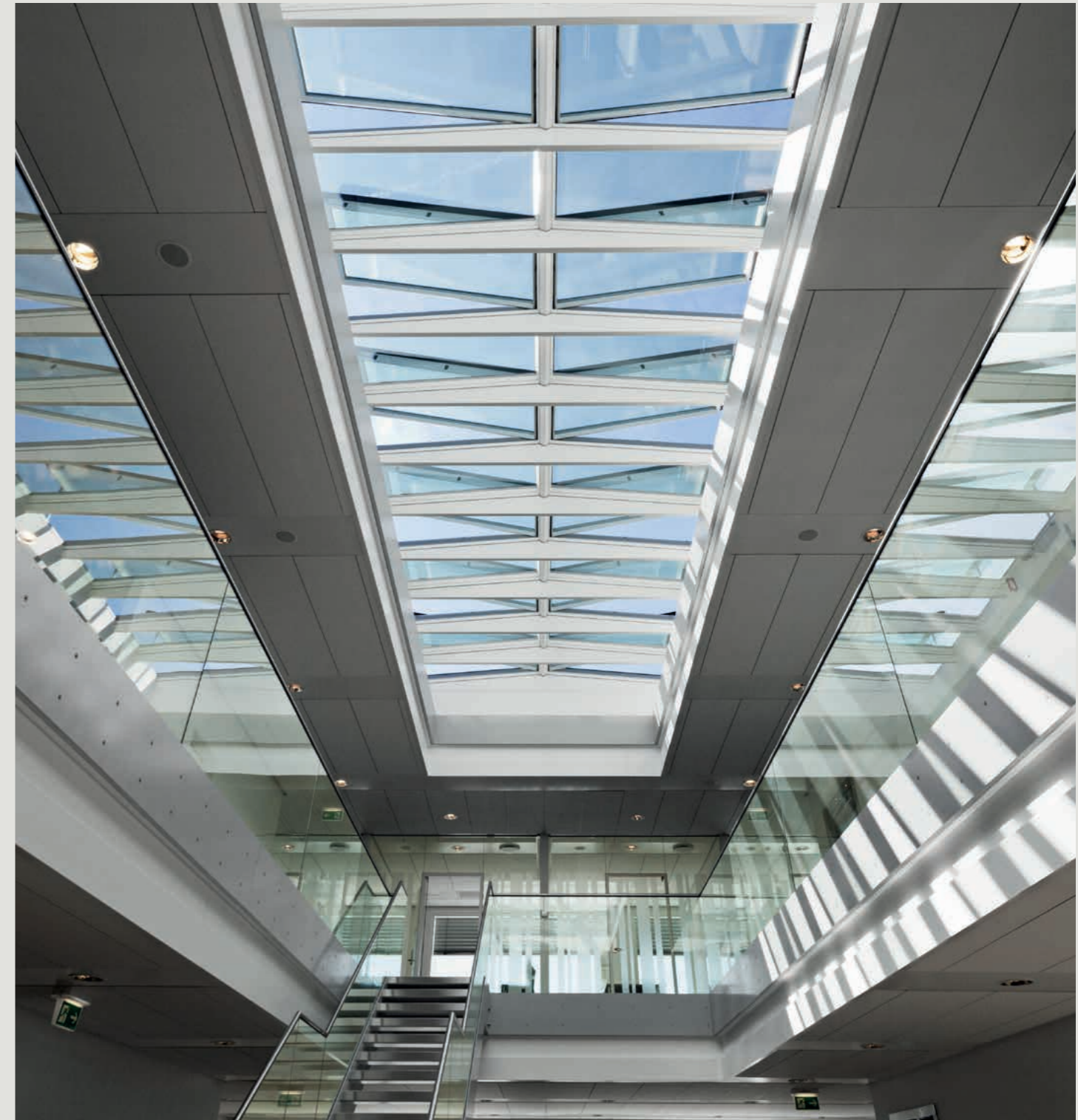

Ridglight with beams in ATP, Vordingborg, Denmark

Integrated actuator offer seamless ventilation

Venting modules are fitted with a fully integrated chain actuator that allows the room to be ventilated automatically. The actuator is connected to an intelli-

gent control system that closes the module automatically in case of rain or strong winds. There are no visual difference between fixed and vented modules.



Roller blinds on south facing modules in Siemens Head Office, Ballerup, Denmark

Advanced daylight and heat control with integrated roller blinds

Specially designed roller blinds (optional) protects against solar glare and heating. The fully integrated blinds employ thin wires to hover beneath the pane,

creating the sensation of a free-floating window shade. Blinds are automatic and can be programmed to respond to luminosity and temperature.

VELUX INTEGRA® or open system



Choose between several intelligent control options

VELUX INTEGRA® uses the INTEGRA control pad to operate venting modules and blinds. The control pad's intuitive touchscreen interface helps the user to control every aspect of the solution, i.e. direct stepless positioning of module and blind, programmable features and selection of pre-set programs.

Alternatively the modular skylight system can be controlled with an open system solution, connected to ± 24 V DC. Options include io-homecontrol® compatible systems and common building automation fieldbus systems.



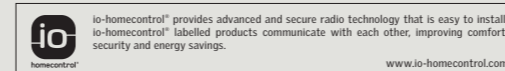

Read more about choice of control system in our Technical Handbook or see how the systems are connected in our Electrical Handbook. Both can be downloaded at: velux.co.uk/modularskylights



Design

Size grid

 Standard size.

 Special sizes, functional limitations may apply.

Fixed modules

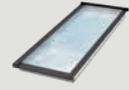

mm	675	750	800	900	1000
800					
1000					
1200					
1400					
1600					
1800					
2000					
2200					
2400					
2600	**	**		*	*
2800	**	**		*	*
3000	**	**			*

Comfort ventilation

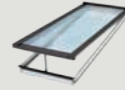

mm	675	750	800	900	1000
800					
1000					
1200					
1400					
1600					
1800					
2000					
2200					
2400					

Smoke ventilation

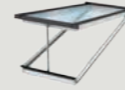

mm	675	750	800	900	1000
800					
1000					
1200					
1400					
1600					
1800					
2000					
2200					
2400					

Please refer to our Technical Handbook for size specific load capabilities.

If roller blinds are requested for smoke venting modules, please refer to local fire authorities for permission.



Due to building legislation, solutions containing venting modules must NOT be installed below 2.5 meter above floor level.

* Modules for longlight and northlight, with extra strong glazing unit.

** No roller blinds available.

How to measure the modules

Width and height of the modules are determined by the exterior W and H dimensions of the frame – not the measurements of the cladding, flashing or brackets.



Roller blinds

The integrated roller blinds fits perfectly into the window opening, creating a seamless connection between sash and cloth. Roller blinds should be included in the module order, in which case they are built to fit.



Sunscreening

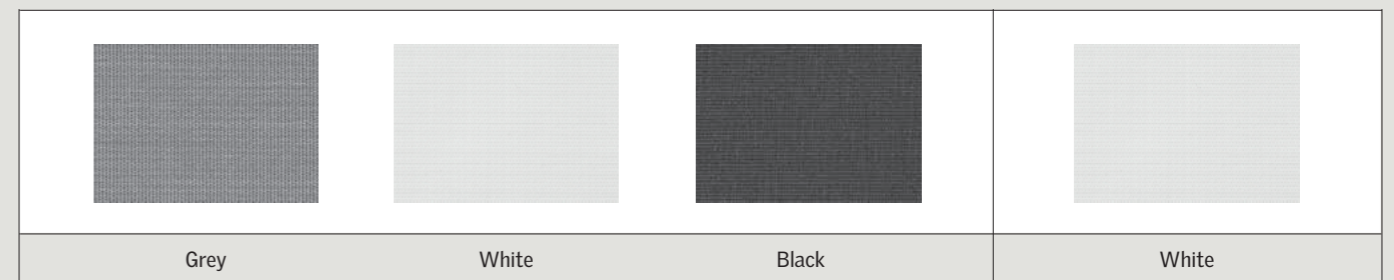

Fire resistant

Design

Exterior components

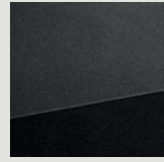

Cladding
Material: Aluminium (1 mm)
Surface: Scratch resistant powder lacquer
Colour: "Noir 2100 Sable YW"
Akzo Nobel

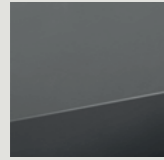

Flashing
Material: Aluminium (0.8-1.2 mm)
Surface: PVdt lacquer
Colour: NCS standard colour: S 7500-N (RAL 7043)



Assembly of middle and top section cladding. Longlight 5-25°.



Assembly of side and top section cladding. Flashing to the right. Longlight 5-25°.



Cladding and flashing assembly at the front of the rooflight.

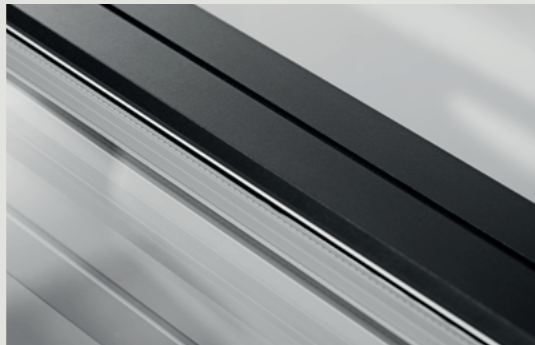

Middle section cladding connects two modules.

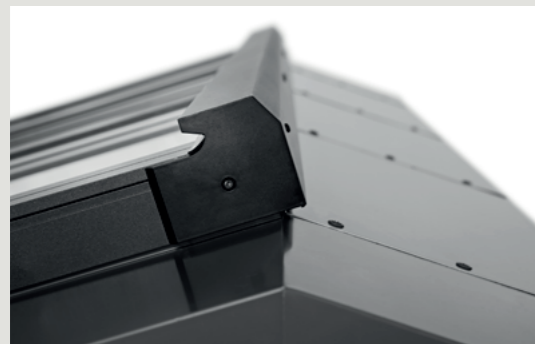

Side view of top covering. Longlight 5-25°.

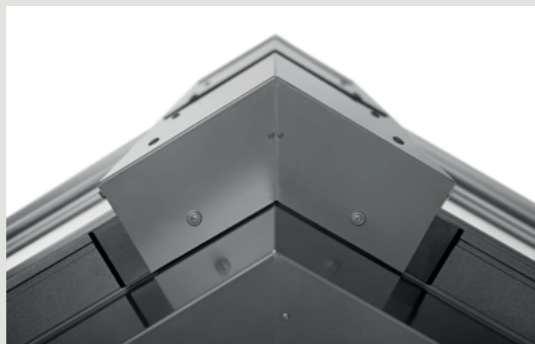

Side view of top covering. Ridgelight 25-40°.

Interior components and features

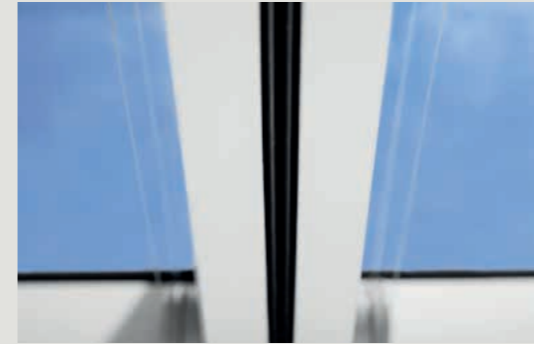

A black gasket ensures seamless and tight connection between two modules.



Connection between sash, glazing and outside cladding.



Roller blinds are kept taut and smooth by a strong, thin wire suspension.



Roller blind bottom wheel ensures position of the wire.



The chain in the hidden actuator raises the venting module to provide ventilation for comfort or smoke exhaustion.



The motor for roller blind operation is hidden inside the rod.

Design

References: Longlight 5 - 25°

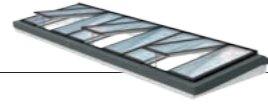

ASSA ABLOY office, Apeldoorn, the Netherlands. 12 modules.



Multi Sports Centre, Copenhagen, Denmark. 60 modules.



SALUS Haus, Bruckmühl, Germany. 64 modules.



SALUS Haus, exterior.

Design

References: Longlight 5 – 25°

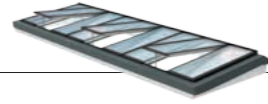

Self Regional Healthcare, Greenwood, USA.



Schulzentrum Carl von Ossietzky, Bremerhaven, Germany. 8 modules.

References: Wall-mounted Longlight 5 – 40°

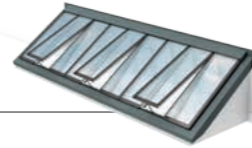

Church, Erkelenz, Germany. 30 modules.



Herlufsholm Boarding School, Næstved, Denmark. 17 modules.

References: Northlight 40 – 90°

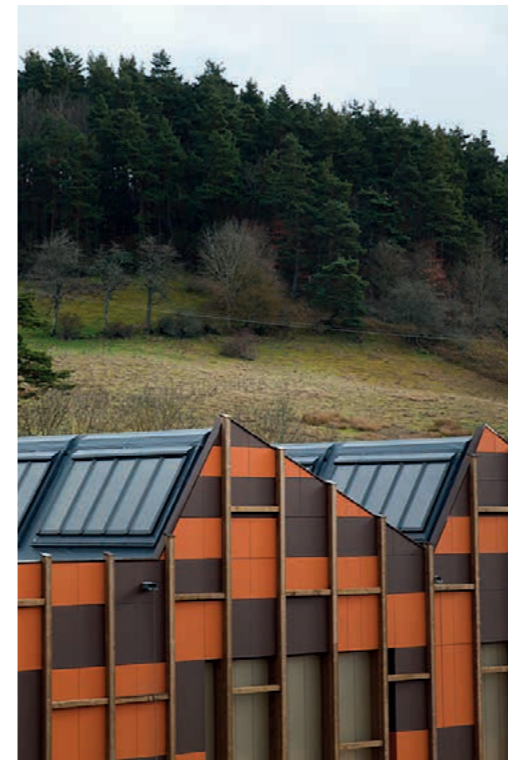

Ice rink, Lantriac, France. 60 modules.



Ice rink, interior.



Sågbäck Gymnasiet, Stockholm, Sweden. 104 modules.

Design

References: Ridgelight 25 - 40°

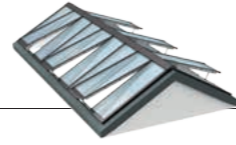

Siemens Head Office, Ballerup, Denmark. 228 modules.



De Assenburg Shopping Mall, Bommel, the Netherlands. 90 modules.



Office building, Gallargues, France. 26 modules.

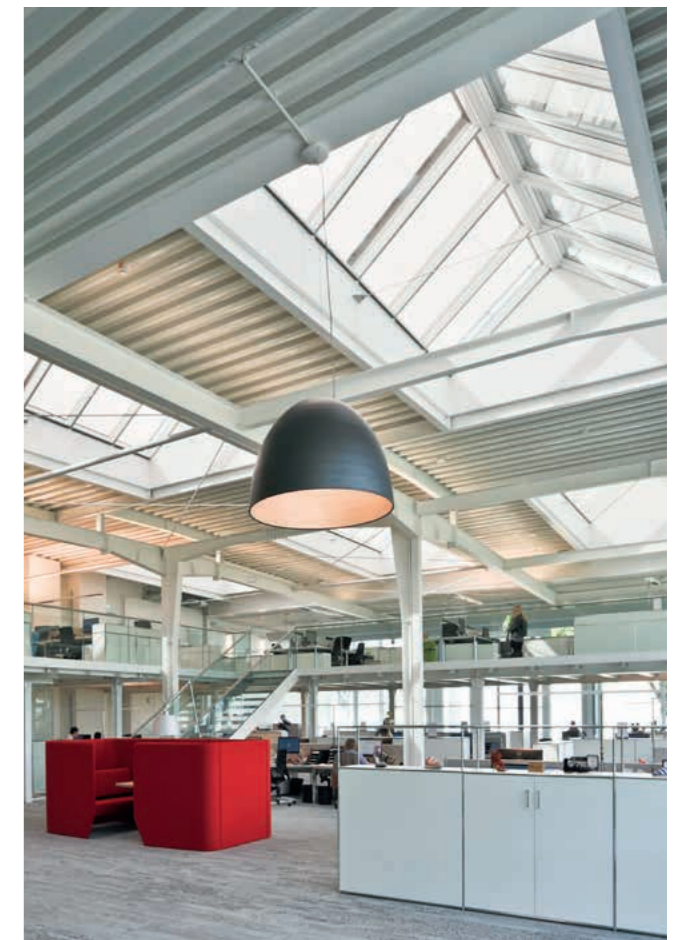

Wortmann Schuh-Holding KG, Detmold, Germany. 216 modules.

Design

References: Ridgelight 25 - 40°

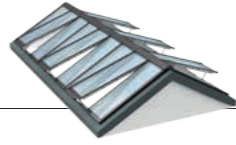

Gastronomie, Trier, Germany. 44 modules.



The Houtloods (transformation of old railway warehouse), Tilburg, the Netherlands. 124 modules.



The Houtloods, interior.

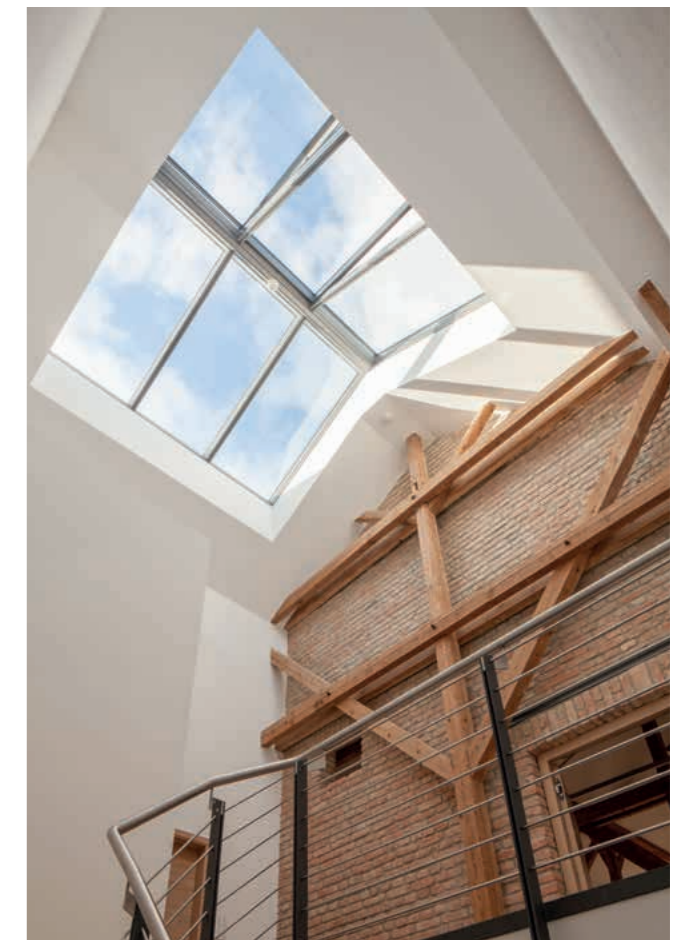

Raiffeisen bank, Mengkofen, Germany. 6 modules.

Design

References: Ridgelight 5° with beam

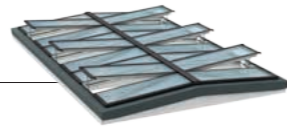

ATP, Vordingborg, Denmark. 26 modules.



Roskilde Cathedral School, Roskilde, Denmark, 14 modules (classroom).



Roskilde Cathedral School, Roskilde, Denmark, 36 modules (assembly hall).

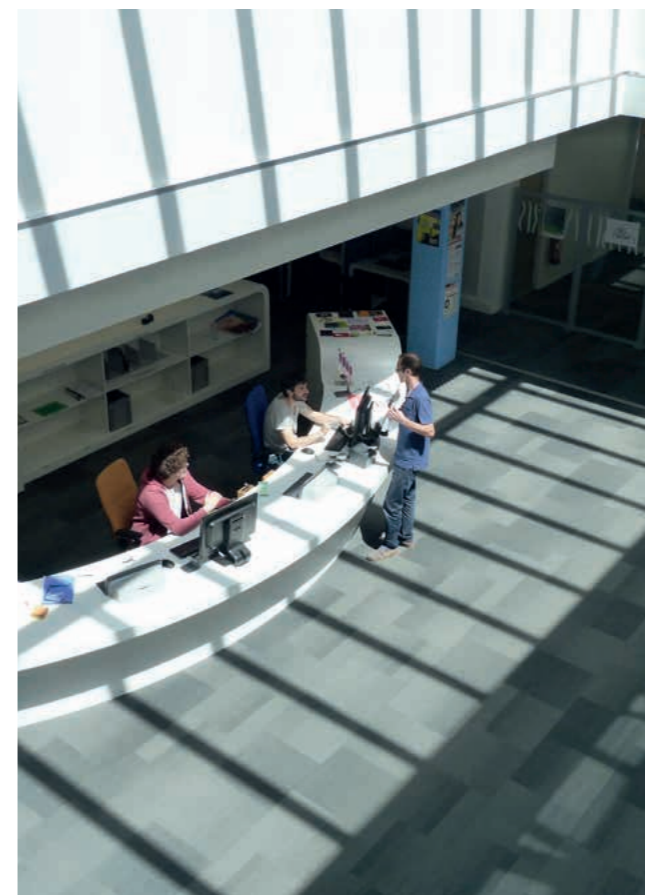

Mirail University, Toulouse, France. 68 modules.

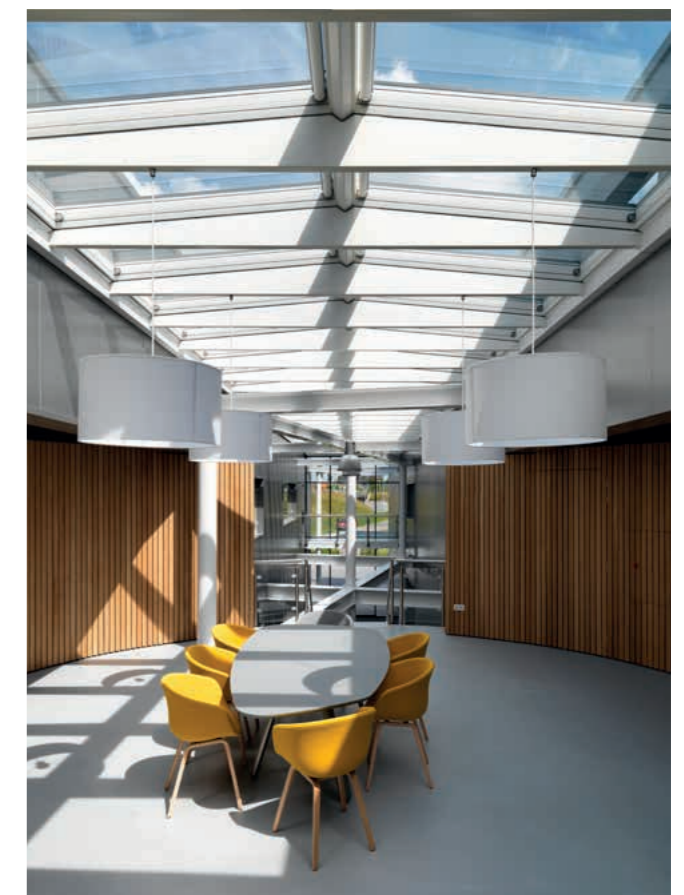

Rokatec Office, De Meern, the Netherlands. 54 modules

Design

References: Atrium Longlight and Atrium Ridgelight

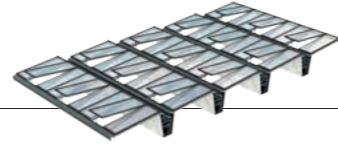

DSV Headquarter, Hedehusene, Denmark. 420 modules.



Green Solution House, Bornholm, Denmark. 196 modules.

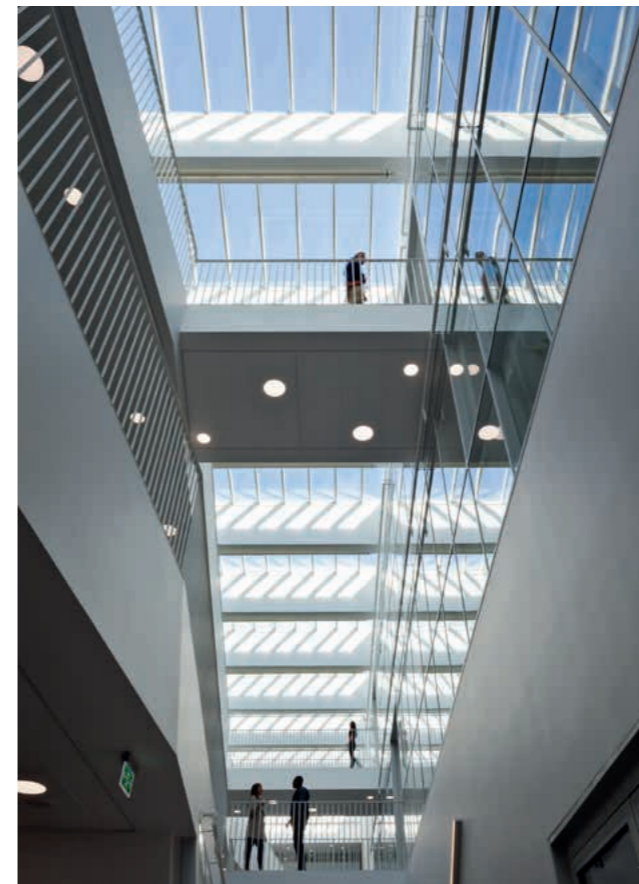

University of Southern Denmark, Odense, Denmark. 367 modules



500 Seneca St, Buffalo, USA. 128 modules.

Performance

Watertightness

The module is fitted with a step pane to ensure water is lead safely off the unit and onto the roof surface. Likewise, interior condensation

tion is drained from the construction via a channel system that distribute surplus water to the roof.

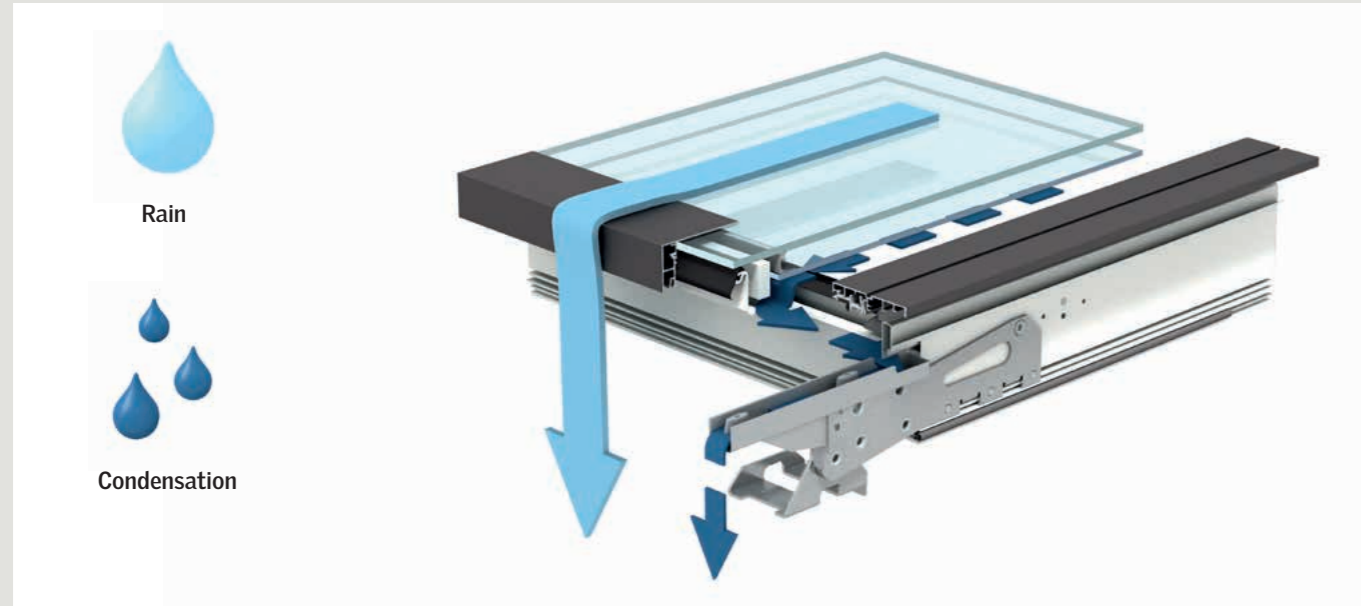

Linear expansion coefficient – (10⁻⁶ m/m K)

Low score means high thermal stability

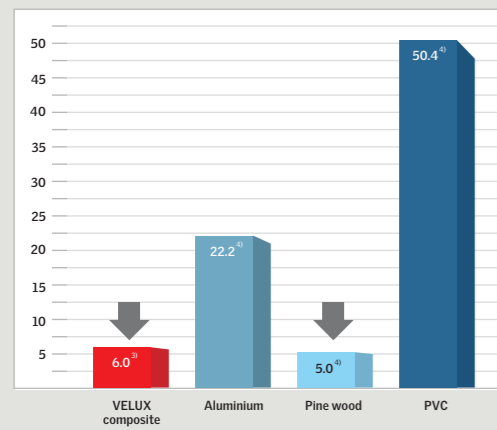

Traditional skylight materials fluctuate in form due to thermal changes, causing damage to gaskets and an increased risk of water ingress. Since the modular skylights composite contain 80% fibreglass, the profile properties are quite equal to those of the glazing unit. The similarity minimizes the risk of opposing movements in the construction, ensuring tightness of joints and a longer life expectancy of the application.

Full installation test



Installation and module watertightness is tested in a wind tunnel with wind speeds up to 37 m/s (hurricane force). The test uses a full installation with modules and flashing.

Airtightness

Modules are connected with a two-level gasket system that protects against air ingress due to excessive wind loads. The cladding, which is attached on top of the connected modules, contains several

pressure compensation channels that reduce the load on gaskets and joints. The modules have obtained the highest classification for air permeability.

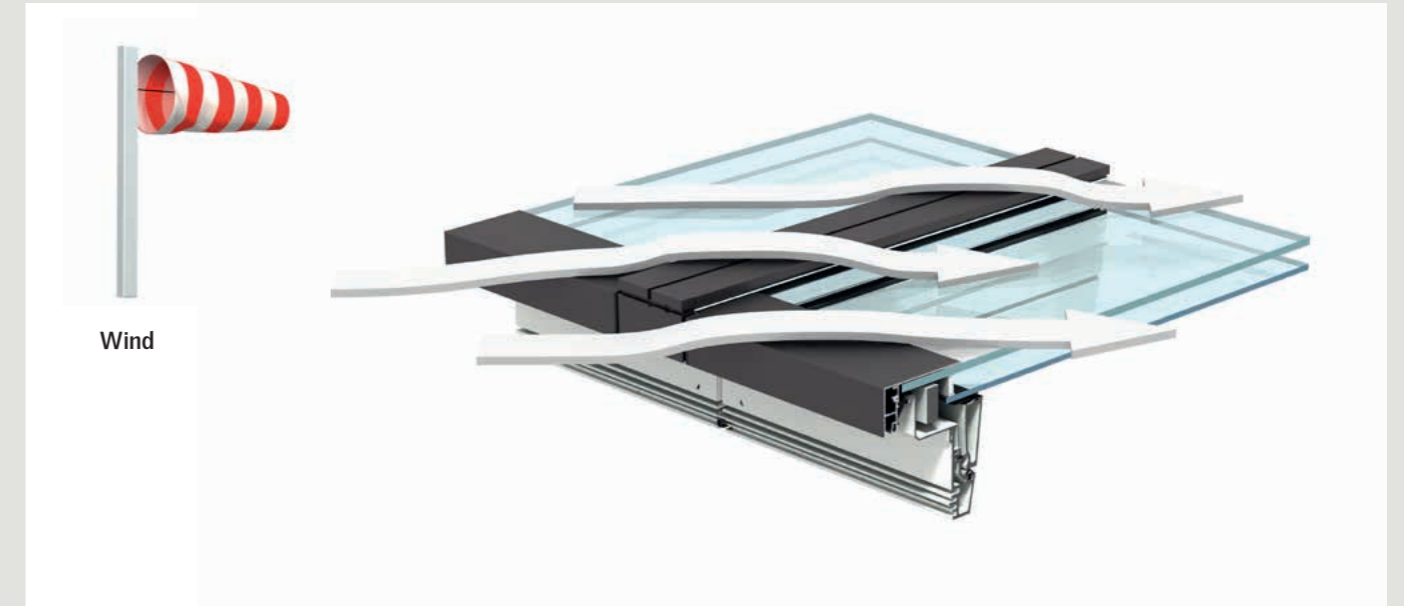

Air permeability

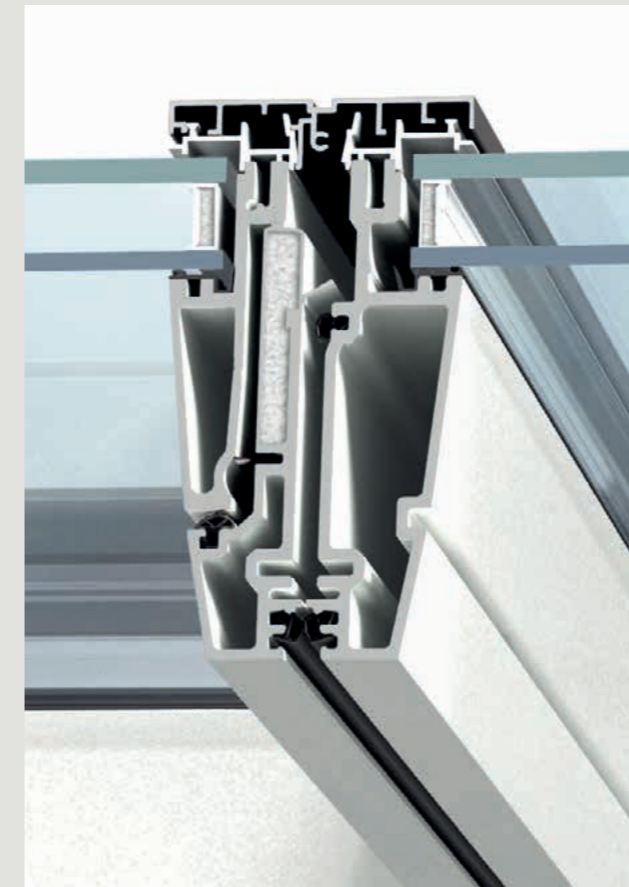

A two-level system with gaskets in the top and bottom ensure a very tight and durable connection between the two module profiles.

Performance

Strength

The modular profiles are made of an extremely tough composite material. The strength stems from a highly specialized pultrusion process, which creates a rare combination of high flexural strength

and unparalleled resistance to breakage. The unique mix makes the composite a safe and durable element as well as a strong measure against aesthetically unappealing deformation.



Flexural strength – (N/mm²)

High score means high strength (resistance to breakage)

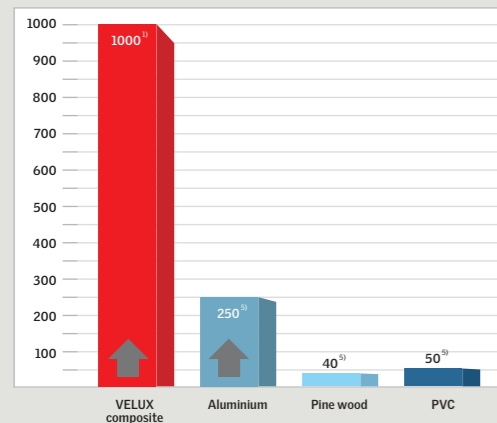

Compared to traditional skylight materials, the exceptional strength of the pultruded composite material allows longer and slimmer frame and sash profiles to be produced. As a result, large skylights with slim profiles become an option, which can lead to better aesthetic solutions.

Modular skylights composite



B

A To start the pultrusion process, strands of fibreglass are pulled from a fibre creel. The strands are pulled through a matrix that bundle the fibreglass to match the final geometric design.

B Following the matrix, strands enter a heated mould where fibreglass is mixed with polyurethane under high pressure. The resulting profile consists of 80% fibreglass and 20% polyurethane. Throughout the process profiles are regularly tested for dimensional inaccuracies.

Flexural Modulus (E-Modulus) – (GPa)

High score means little deflection

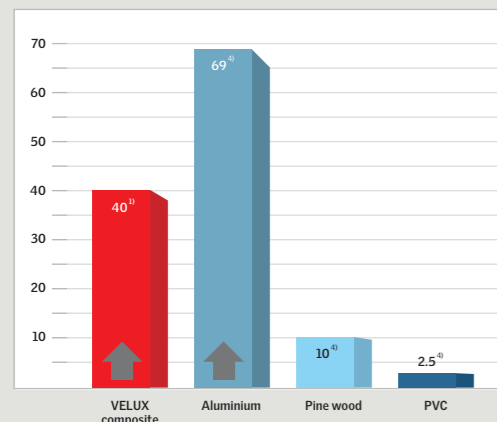

The high rigidity of the pultruded composite material makes the frame and sash extremely stiff. The rigid properties ensure reliable performance with very little deflection of the profiles and more durable aesthetics.

Energy

Very low thermal conductivity and an array of low-energy glazing options make the total modular solution exceptionally energy efficient. The system offers 2 or 3-layer glazing in combination with

three different coatings. The different combinations allow you to specify the product precisely according to your demands, whether you prefer heat control or protection against cold weather.

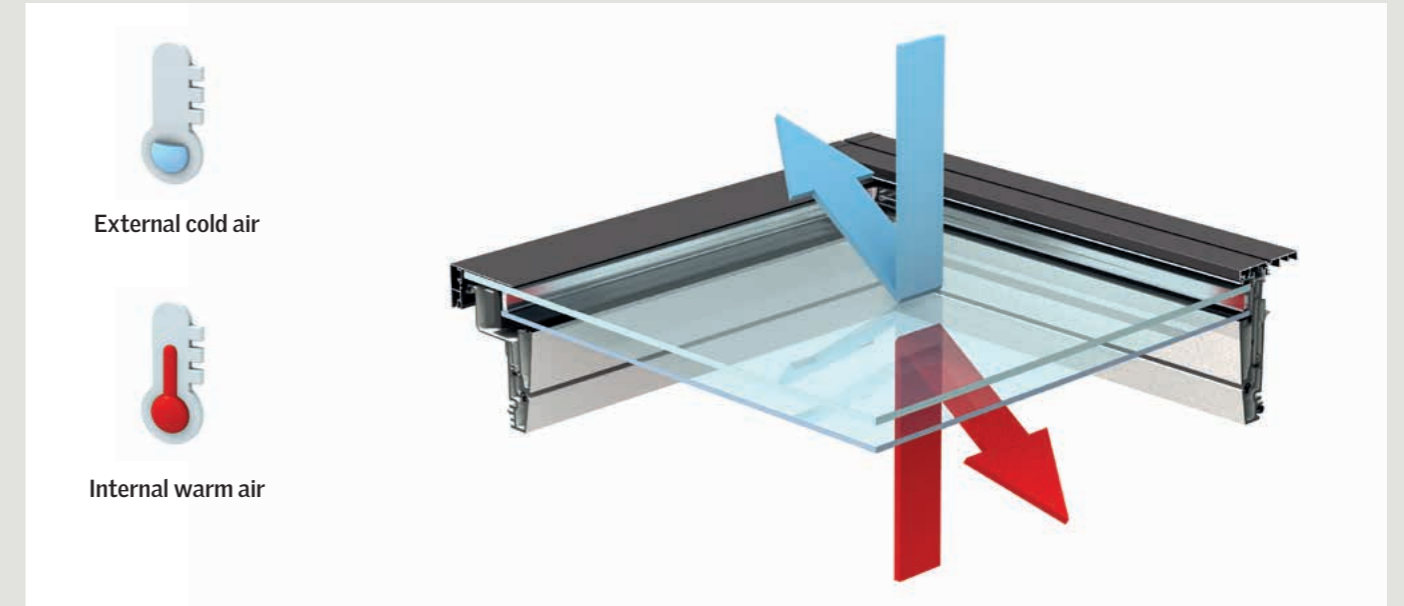

Thermal conductivity – (W/mk)

Low score means high insulation performance

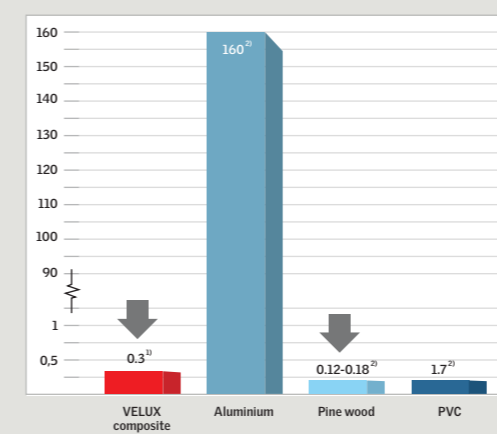

The special composite possesses extremely low-conductive properties that surpasses traditional profile materials – a measure for high insulation performance.

Thermal insulation

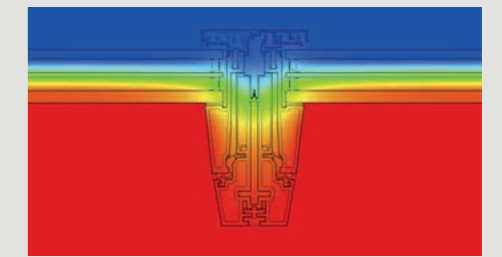

Thermal tests reveal the profiles ability to prevent cold bridging.



Low-energy glazing in combination with low-conductive profiles creates a convincing shield against all kinds of cold weather.

Performance

Glazing and U-values

Modular skylights are fitted with a 2-layer standard low-energy glazing unit. Alternatively a 3-layer glazing unit is available for projects that require extra low U-value. Both glazing units are

available with different coatings for different levels of energy and solar protection, and with foil laminated inner glazing for added safety.



Double-glazing unit
 $U_w = 1.4 \text{ W/(m}^2\text{K)}$
 Variant: 10, 11, 12



Triple-glazing unit
 $U_w = 1.0 \text{ W/(m}^2\text{K)}$
 Variant: 16, 17, 18

Colour rendering of glazing units

Glazing with low emissivity coating (LowE)

T-value = 77%
 g-value = 58%
 $R_a = 94.47$

Glazing with light sun protection coating (Sun1)

T-value = 49%
 g-value = 27%
 $R_a = 90.39$

Glazing with advanced sun protection coating (Sun2)

T-value = 19%
 g-value = 16%
 $R_a = 86.30$

Variant: 10

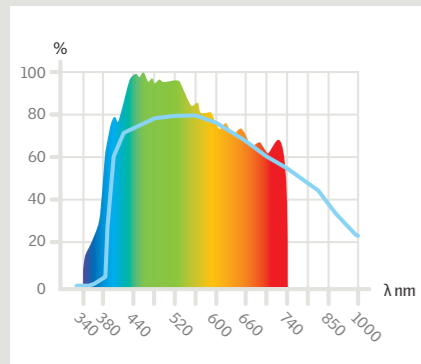

Variant: 11

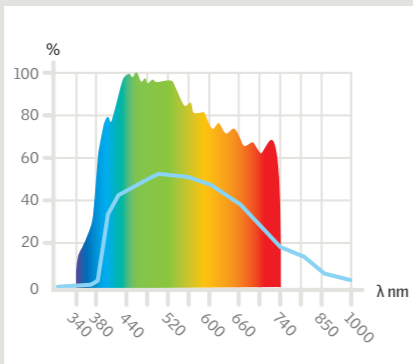

Variant: 12

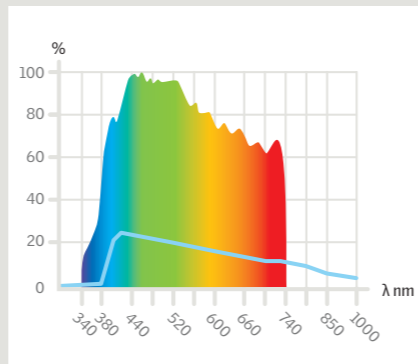
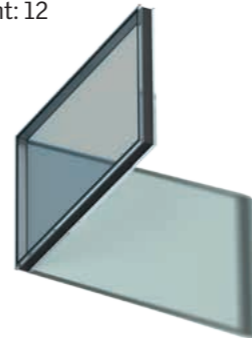

Spectral values (wave length in nm)
 Visible daylight tau

Colour simulation

Depending on the choice of coating, the penetrating light will be affected together with the natural colouring of the interior. Photos

below compare the effect of the three available coatings in terms of colour rendering and luminosity to unfiltered daylight (no glazing).

Neutral daylight

No glazing



Low emissivity coating

Variant: 10



Light sun protection coating

Variant: 11

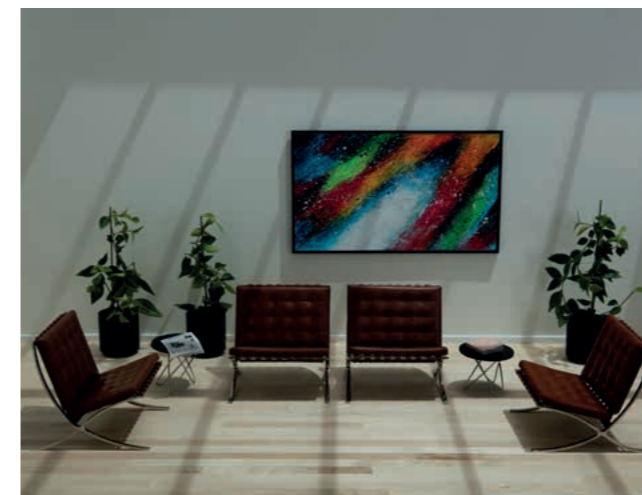

Advanced sun protection coating

Variant: 12

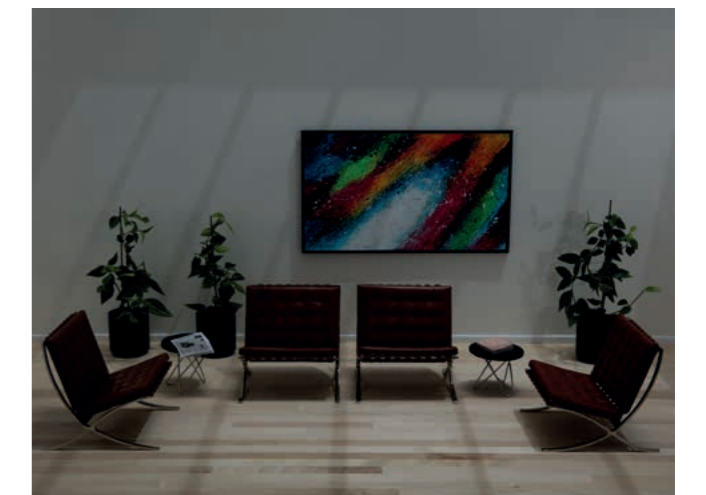

Chairs in photos: Miniature Vitra Design Museum.

Read more about glazing units in our Technical Handbook
 Can be downloaded at: velux.co.uk/modularskylights

Performance

Tested and classified

Due to the concept of prefabrication, we are able to test our products extensively against all thinkable hazards and stressful events. Tests are performed in controlled environments and even if only one component is investigated, results refer to all within our skylight

concept. All products are manufactured, assembled and delivered from the same heavily controlled production line, leading to components with completely identical properties.



Watertightness

Classification: EN 12208:2000

VELUX modular skylights: E900

No water penetration up to 900 Pa.
900 Pa equals 134 Km/h (37.2 m/s).
(Hurricane = 32 m/s).



Resistance to Wind Load

Classification: EN 12210:2001

VELUX modular skylights: Class C5

Frontal deflection measured at 2000 Pa is less than $L/300$.
(L = span length).



Air Permeability

Classification: EN 12207:2000

VELUX modular skylights: Class 4

Highest air permeability classification
Draught measured to less than $2.6 \text{ m}^3/\text{hm}$ through joints at peak pressure.



Electromagnetic compatibility (EMC)

All electrical components are rigorously tested and comply with relevant EMC standards.



External Fire Performance

Classification: EN 13501-5 + A1:2009

VELUX modular skylights

$B_{\text{ROOF}}(t_1)$: No penetration or burning droplets.

$B_{\text{ROOF}}(t_4)$: No penetration of roof system within one hour.



Reaction to Fire

Classification: EN 13501-1:2007 + A1:2009

VELUX modular skylights: Clas B

Slow development of fire and moderate heat release.



Resistance to Fire

Classification: EN 13501-2:2007+A1:2009

Fixed fire resistant module (HFS): REI30

Venting fire resistant module (HVS): EI30



Strength

Ultimate strength under control

Flexural strength of the VELUX composite: 1000 N/mm^2



Safety at work

Fall-through protection

- DGUV Certificate (DE)
- NARM ACR fragile roofing assembly Class A
- CWCT TN 66/67 Class 2

Walking on VELUX Modular skylights is not allowed however, by holding above certificates VELUX Modular Skylights offer enhanced protection against fall through during installation and maintenance.

Modularity

The skylight module

CE marked modular skylights can be used in any building where the national, local and individual building requirements allow the use of skylight modules. Given the aesthetics and advanced performance of the products, our skylights are commonly used in heated build-

ings and primarily in projects that support light commercial interests, e.g. hospitals, schools, shopping centres, offices, museums etc. However, all buildings that have a suitable structure, and which are large enough to host an installation, will support modular skylights.

Functions

Modular skylights are available as fixed and venting modules. Due to a hidden chain actuator, fixed and venting skylight modules appear to be visually identical in closed position.

Venting modules are top-hung and can be used for both comfort and smoke ventilation. All sizes are approved for smoke ventilation according to NSHEV – EN 12101-2:2003.



Fixed skylight module

HFC



Motorized comfort venting skylight module

HVC

Opens up to 410 mm



Motorized smoke venting skylight module

HVC

Opens up to 700 mm in less than 60 sec.

One module for all solutions

All modular skylight solutions are based on the same single skylight module and the same basic installation process. In other words, you are not required to specify different modules to different solutions.

The modular concept is in every sense a "one module fits all", meaning you can apply the same module specifications, regardless of whether you prefer longlight, ridgetlight, northlight or other.

This unique modular feature makes the design process much more straightforward, leaving more time to develop aesthetics, ventilation properties, heat and daylight control etc.

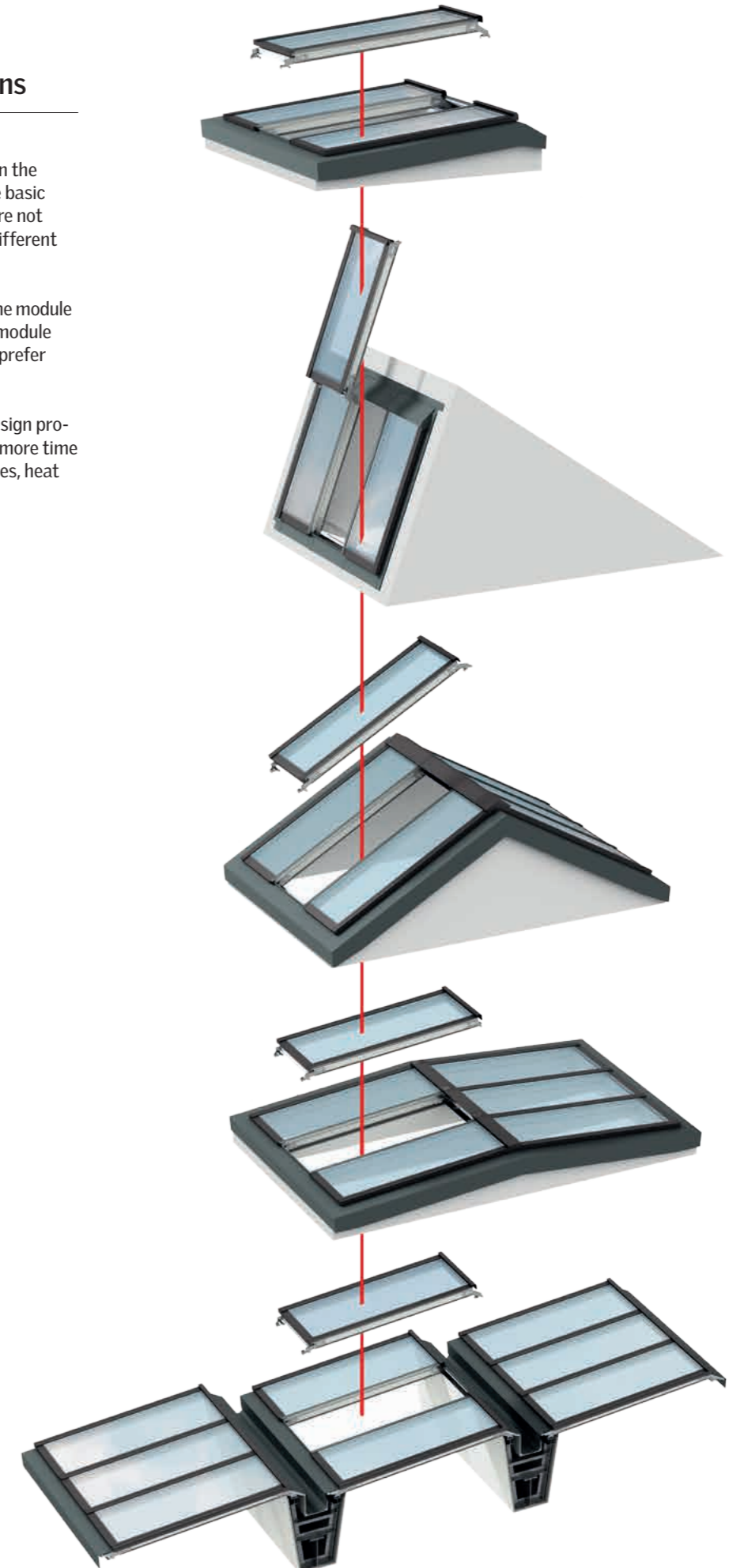

Modularity

Designed for trouble-free installation

All components are designed in exact accordance to the overall system. In our controlled production facilities we monitor all aspects to ensure a perfect fit and assembly.

A unique bracket system with a simple clamp design guarantees a predictable installation process, which makes it possible to fit an entire module within minutes.

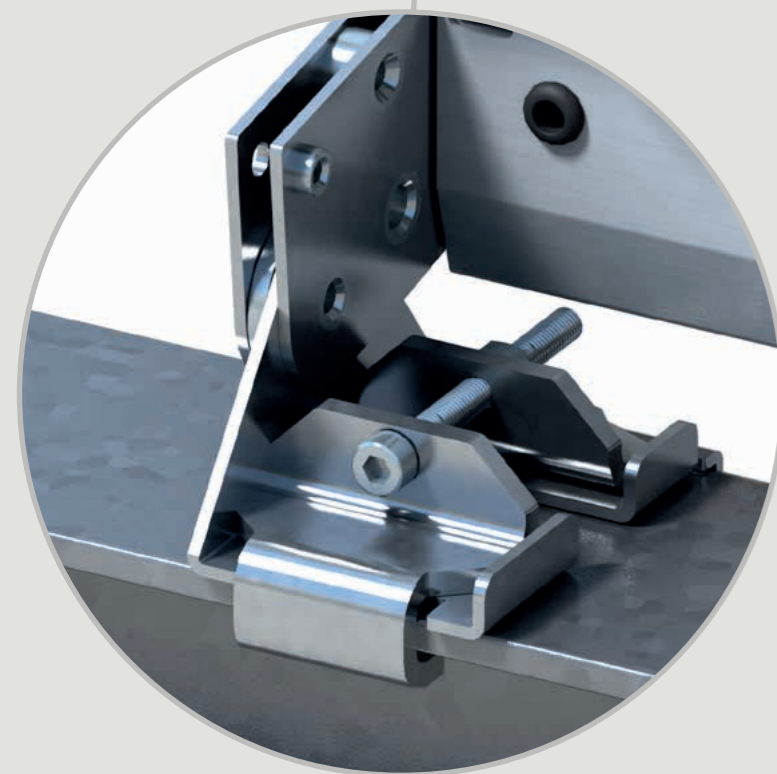
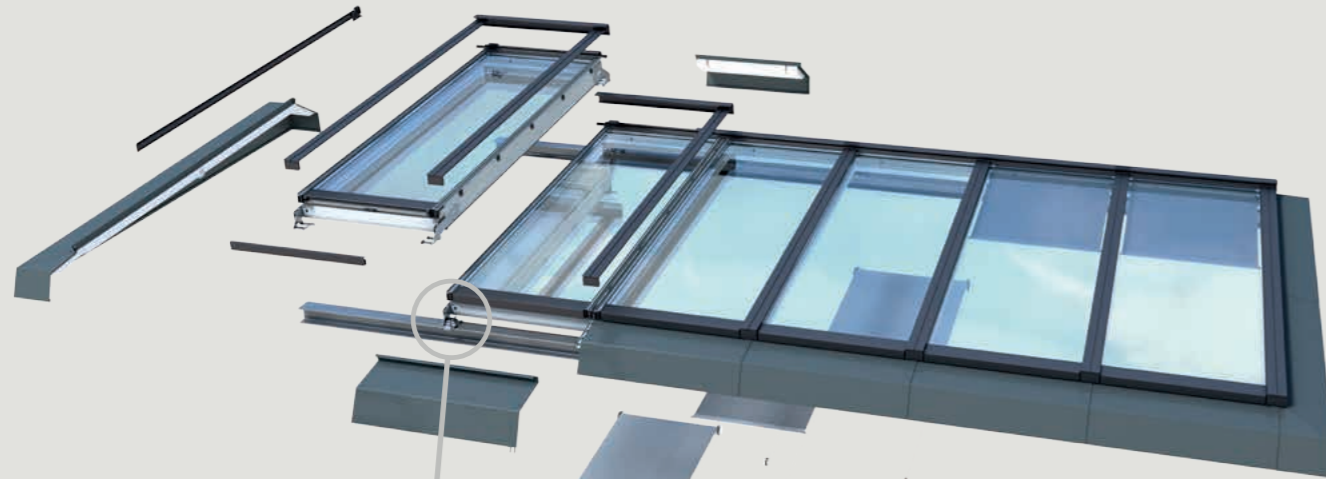

The fastest installation system



Up to 3 times faster installation*
*Than other rooflights. Proven by installers on construction sites

Shielding a building means protecting it against the dangers of weather as well as allowing work to commence inside the building. This makes speed a pivotal demand. Modular skylights are conceived to support the fastest imaginable installation process, starting from delivery on the construction site to fastening the final screw.

On arrival all items are marked with numbers and letters that clearly show the order in which the various components should be installed. Modules are hoisted directly from the pallets onto the prepared sub-construction and fastened within minutes. Final flashing and cladding is applied with prefabricated components, build to fit.



“ It probably takes about 2-3 times longer with a traditional installation.

John Wolff
 Wolff Tømmerfirmaet A/S
 (Installer on Siemens Headquarter Denmark and DSV Headquarter Denmark)



Brackets and clamps

The galvanized steel bracket system for fastening the module consists of two identical brackets and clamps in top and bottom.

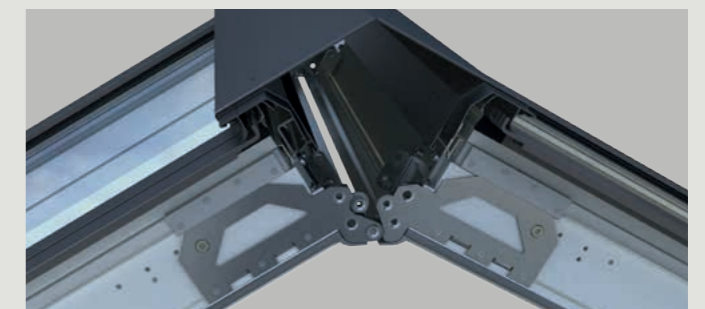

Top bracket for ridgeline

The top bracket for ridgeline 25-40° secures the opposing modules in the ridge to create a self-supporting construction.

Modularity

Photovoltaic panels



Green Solution House, Bornholm, Denmark.



Modular skylights are available with two different types of integrated monocrystalline photovoltaics:

- 1) The first type consists of a semi-transparent pane with one half covered in evenly distributed black squared photovoltaics, size approx. 15 x 15 cm. The semi-transparent module converts solar radiation to electricity with up to 8% efficiency.
- 2) The second type is opaque and fully covered with photovoltaics without any transparency. The opaque module converts solar radiation to electricity with up to 13% efficiency.

Integrated photovoltaics are available in standard module widths from 800-1000 mm and heights from 1200-2400 mm (fixed and venting).

In order to achieve maximum output from photovoltaic modules, we recommend a solution, which is tilted towards equator and located in a shadow-free environment. As a rule of thumb the installation should be pitched at an angle that equals the latitude minus 10 %.

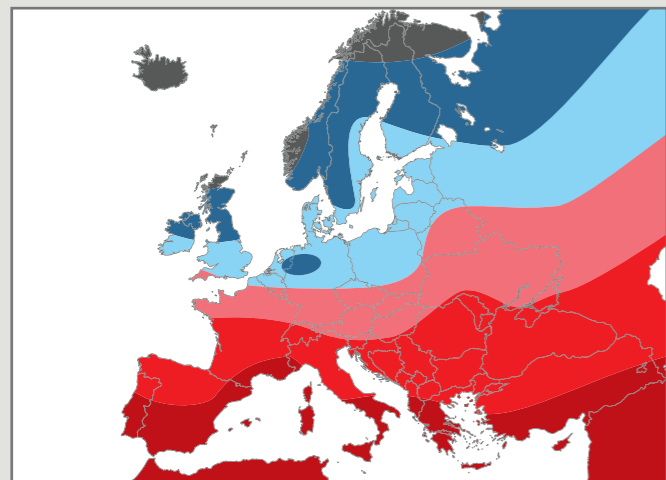

Map legend:

Global irradiation on optimally tilted south-oriented photovoltaic modules (kWh/m² per year)

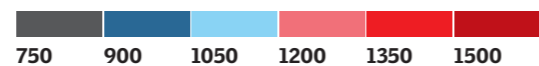
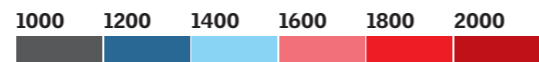

Solar electricity generated by 1000 Wp PV-system with optimally tilted modules and performance ratio 0,75 (kWh/1000 Wp PV per year)

External awning blinds



Wortmann Schuh-Holding KG, Detmold, Germany.

Maintain a pleasant thermal indoor environment

The Topfix® VMS external awning blind by Renson protects the interior from excessive solar heating. The product is optimized for VELUX Modular Skylights and is applicable to both fixed and venting modules. Topfix® VMS operates on mounting feet that

fits perfectly onto the external surface of the modular profiles. The blinds features a VELUX compatible operation system and can endure wind loads up to 120 km/h.



Support

Technical drawings, 2D

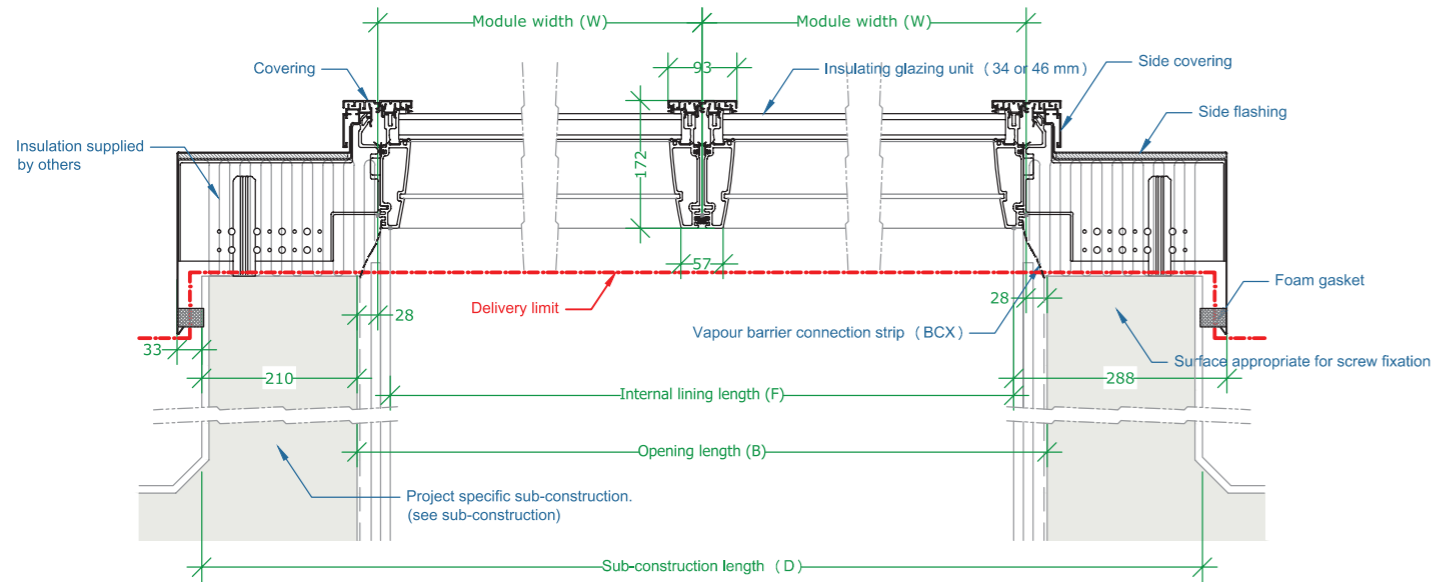

CAD/BIM objects, 3D

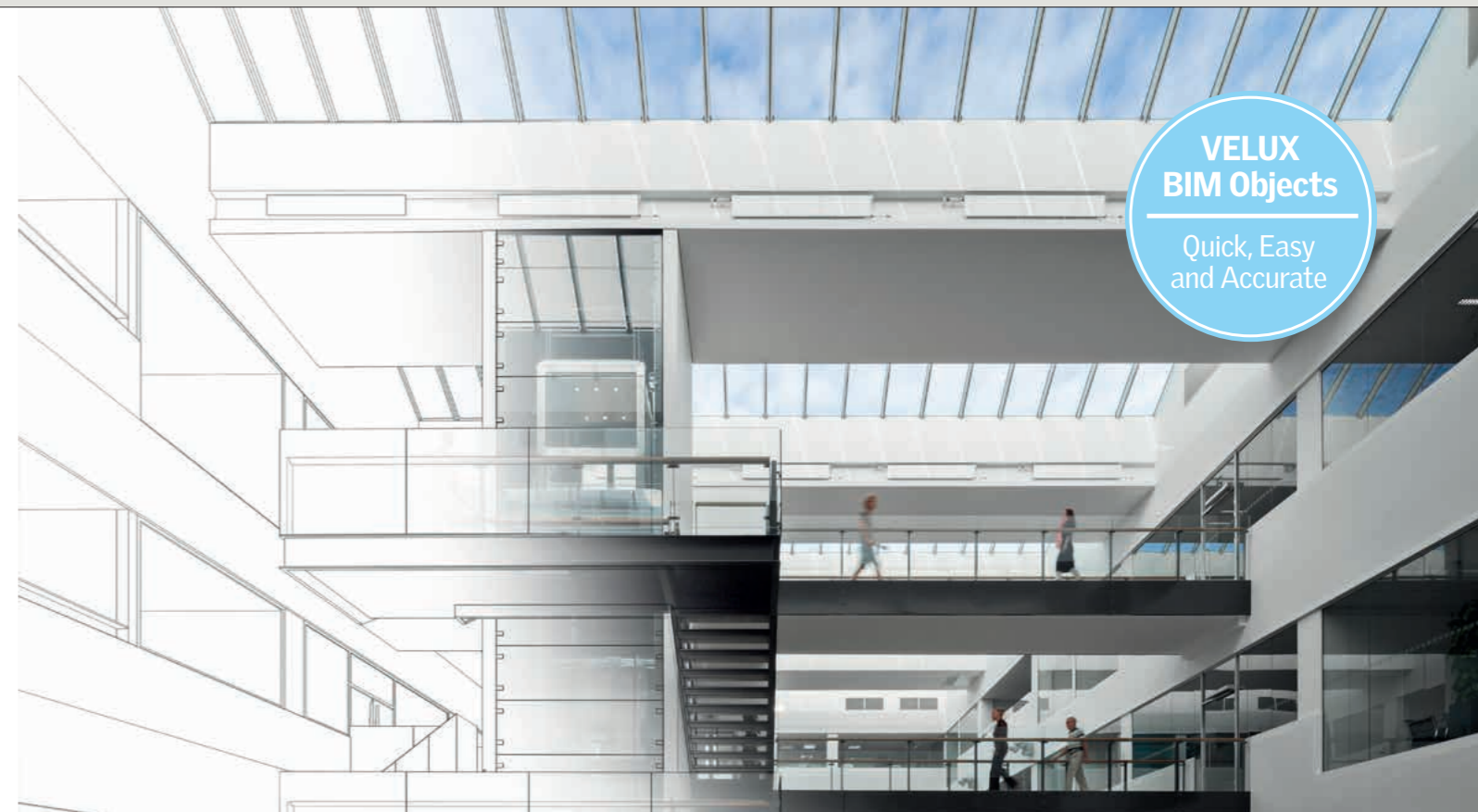

Download detailed 2D illustrations and technical drawings

Precise and detailed AutoCAD material can be downloaded for immediate use directly from our website. The drawings contain all relevant descriptions and measurements.



Download a complete folder with all material on modular skylights. Drawings can also be found in our Technical Handbook. Folder and handbook are available for download on our product website listed below.

See more technical drawings in our Technical Handbook. Download it at: velux.co.uk/modularskylights

[Go to download section at www.velux.co.uk/modularskylights](http://www.velux.co.uk/modularskylights) >

Use drag and drop objects

VELUX CAD/BIM objects are available to be used with the most popular modelling programs. Furthermore, all 3D objects are compatible with Autodesk AutoCAD,

Trimble SketchUp and 3D Studio/3DS. The object families are built in accordance with buildingSMART, including: COBIE, CCS and Omni class.

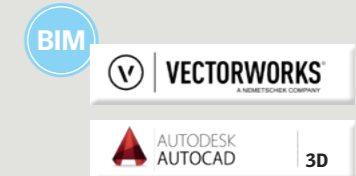
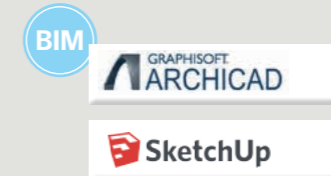

Objects can be downloaded from international BIM libraries and from the VELUX website.



[Go to download section at www.velux.co.uk/modularskylights](http://www.velux.co.uk/modularskylights) >

Support

Sub-construction



To support a trouble-free installation process the sub-construction needs to accommodate the very specific installation system. Modular skylights require an accurate fixed dimensioned substructure. Likewise the strength of the sub-construction needs to be calculated from project to project, based on the building design and application size.

Thus the sub-construction is not part of the prefabricated modular system.

Download our guide for sub-construction at:

www.velux.co.uk/modularskylights

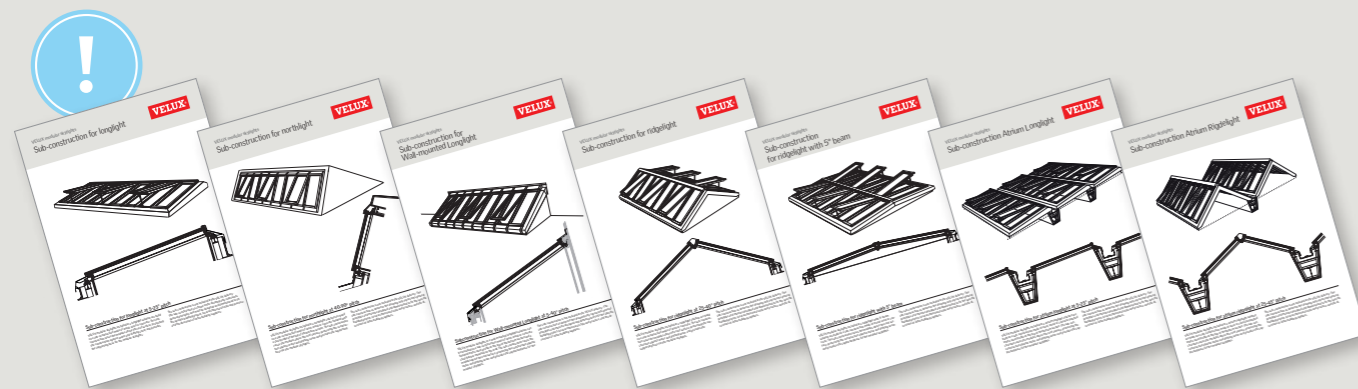
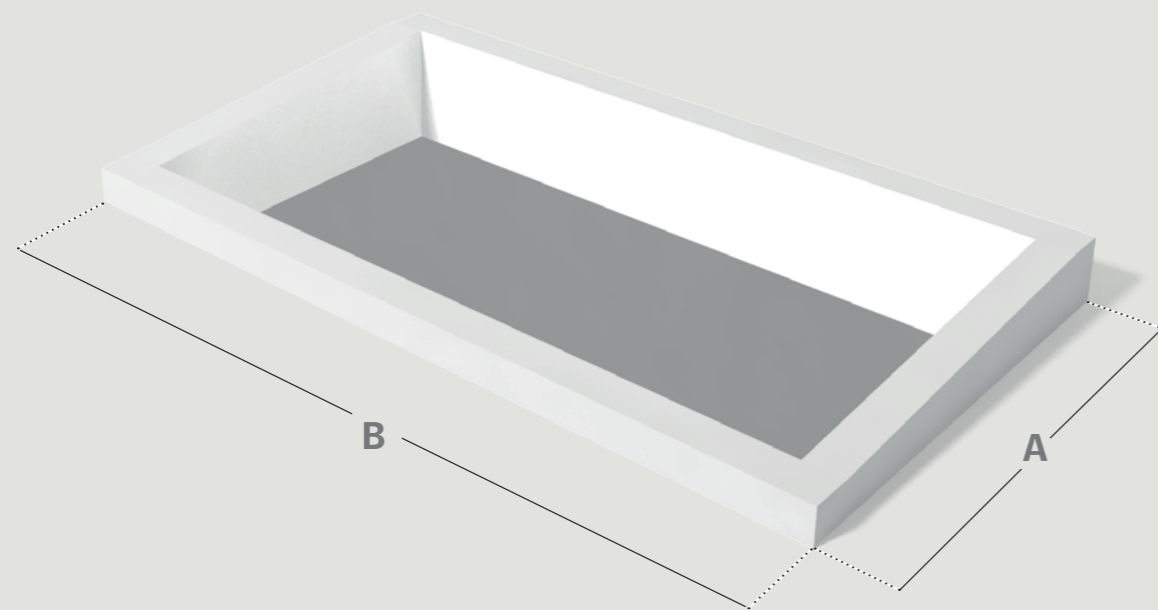

Read all about sub-constructions in the guides at: velux.co.uk/modularskylights

VELUX Daylight Visualizer

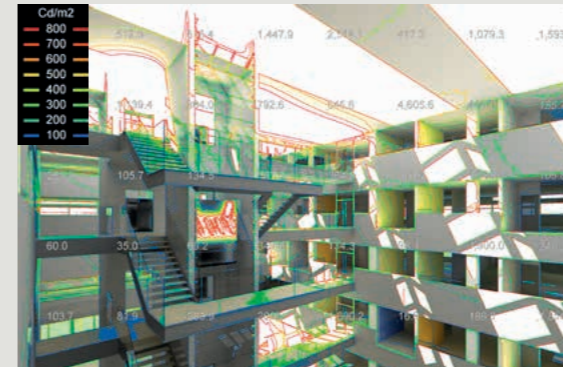

A professional tool for projects in every scale

VELUX Daylight Visualizer is a professional simulation tool that offers precise and visually convincing daylight analysis of any given rooflight installation. The tool permits you to accurately simulate and quantify daylight levels in the interiors, develop before and after scenarios and create extensive data reports for project reviewing. All projects can be imported or exported at will for further processing.

Comprehensive daylight planning is prerequisite to achieving optimal daylight conditions in commercial building. Proper daylight management will always be an asset, e.g. by replacing artificial lighting to save electricity or providing free solar heating to save on conventional energy consumption.

VELUX Daylight Visualizer can be downloaded for free from our website.



Download at www.velux.co.uk/modularskylights

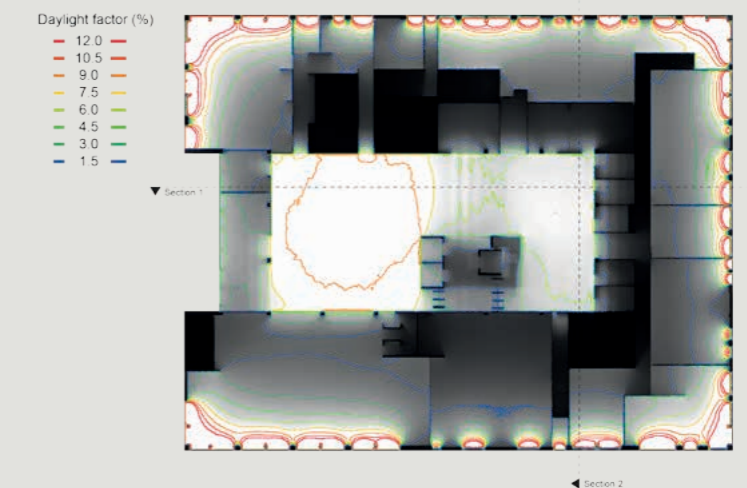
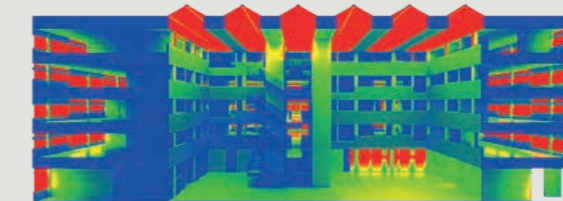

Support

Design phase



Consultancy

To help you get started, we offer expert guidance from even before your project gets approved.

Technical documentation

All technical documentations are available for download on our websites.

Specification

Our experienced building consultants stand ready to help you specify your projects.

Installation phase



On-site support

Once your project is underway we will help you track your progress and offer on-site consultancy on project critical issues.

Instruction

To insure high safety and efficiency on the construction site, we offer various forms of training for all installers that are involved. The training can take place directly on the construction site, where your project is being performed.



Daily operation



After sale

A number of tools and accessories are available to help optimize the solution, if or when the requirements evolve.

User guidance

To maximise the performance output it is sometimes necessary to educate the users about the properties of the solution and train elected employees on how to operate the skylights.

Product service

Should the system for some reason require professional service, our team of VELUX service technicians will do all they can to solve the problem to everyone's satisfaction.



Guarantee



Our modular skylights and flashings are supported by a 10-year guarantee. Blinds, actuators and other electrical components that are a part of the modular system comes with a 3-year guarantee. All warranty is

subject to correct installation and usage.

Warranty conditions can be found on: www.modularskylights.velux.com

Contact



Our aim is to provide all the tools and answers that will make your project as simple and trouble-free as possible. Thus we offer a wide range of expert support and consultancy even from before the project

starts to well after its completion. To get in touch, please contact us here:

Address: **Woodside Way, Glenrothes, Fife, KY7 4ND**
Tel: **01592 778 916**
Email: **vms@velux.co.uk**

VELUX Company Ltd
Woodside Way
Glenrothes
Fife
KY7 4ND
Tel: 01592 778 916
Email: vms@velux.co.uk

Bringing light to life™

VELUX®