

VACUUM SYSTEMS

From large to small systems, complete packages and hybrid systems. Precision made, performance tested and guaranteed.



EJECTORS

Principles and benefits

Ejectors consist of six basic parts:

1. Motive Fluid Chest
2. Converging/Diverging Nozzle
3. Mixing Chamber
4. Converging Inlet Diffuser
5. Diverging Outlet Diffuser
6. Diffuser Throat

The operating principle of the ejector is that the pressure energy in the motive fluid (1) is converted to velocity energy by an adiabatic expansion in the Converging/Diverging Nozzle (2). The Nozzle exit velocity is normally in the supersonic range of 3000 to 4000 feet/second when using steam as the motive fluid. (Velocities may vary depending on molecular weight, temperature, and pressure of the motive fluid.)

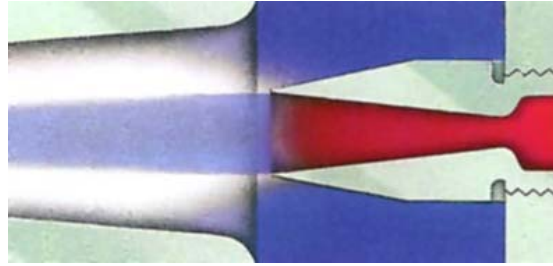

This high-velocity (cone shaped) jet enters the Mixing Chamber (3) and entrains the suction fluid being pumped.

The mixture attains a velocity of approximately 2000 to 3000 feet per second.

The mixed motive fluid and suction fluid then enter the Converging Inlet Diffuser (4) where a portion of the velocity energy is converted to pressure energy. The mixture is then compressed in the Diverging Outlet (5) section of the Diffuser to attain the final discharge pressure, normally 5 to 15 times the suction pressure. There is a corresponding rise in mixture temperature as this compression occurs.

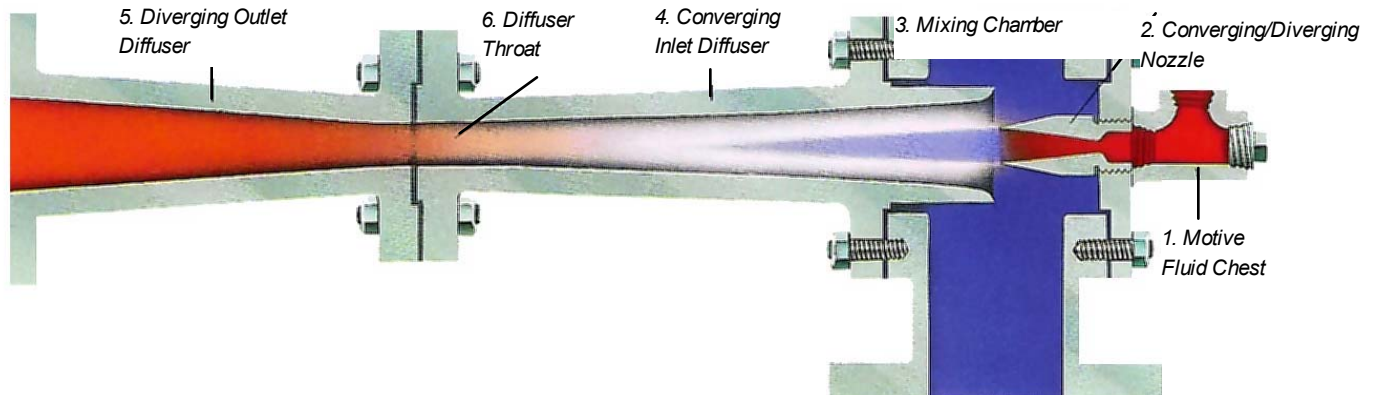

EJECTOR BENEFITS

Ejectors can be operated with many different motive fluids: steam, air, organic vapor and other gases.

- Can handle corrosive and slugging liquids, solid and abrasive suction fluids without damage.
- Simple, rugged, reliable and trouble-free. No moving parts, no lubrication, no vibration, no bearing or seal problems. (Available with flanged or weld end connections.)
- Explosion-proof construction. Ejectors can

be installed indoors or outdoors with versatile mounting design.

- Low initial cost, low maintenance cost, long life.
- Can handle high volumes of suction fluid at low absolute pressures. Graham has built single-stage ejectors to handle 575,000 CFM at 100 TORR, and six-stage ejectors to handle 130,000 CFM at 0.010 TORR (10 microns ABS).
- Graham ejectors are precision-machined and performance-tested.

LIQUID RING VACUUM PUMP

Principles and benefits

Next to ejectors, Liquid Ring Vacuum Pumps are the most used vacuum-producing devices in industry. Graham manufactures a complete line of these pumps in our own factory.

The operating principle of the liquid ring vacuum pump is that the only moving part is an eccentrically mounted impeller within a ring of liquid. Pump action is created by increasing and decreasing spaces between the impeller blades and liquid ring. Process gases enter and leave these spaces (impeller buckets) through adjacent ports in sideplates next to the impeller.

These single- or two-stage pumps can

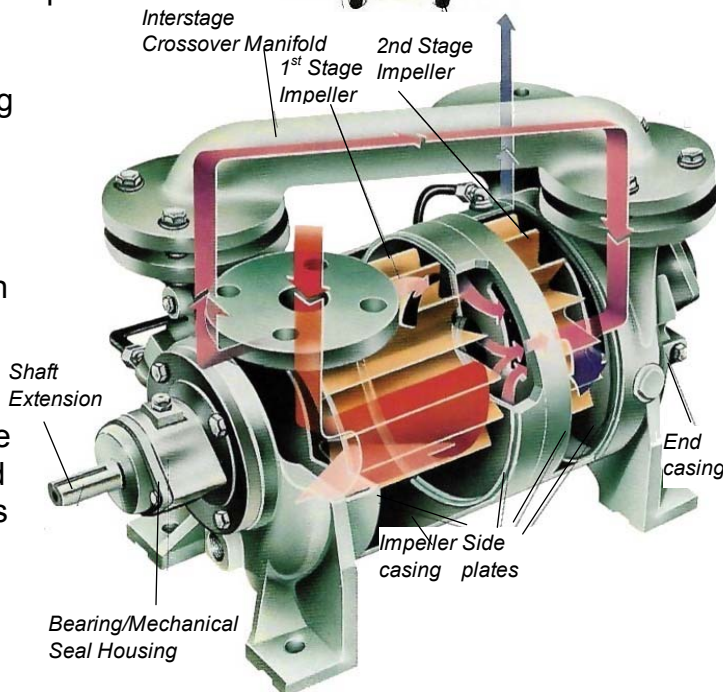
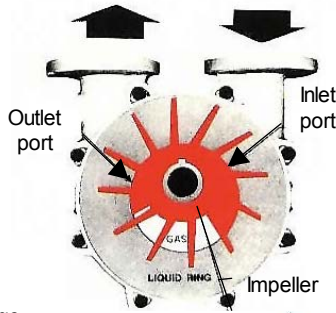

achieve pressure ranges from atmospheric to 25 TORR. Graham units offer design simplicity, high efficiency, low maintenance, and the capability to handle wet corrosive process streams. A complete line of spare parts is always available at our Batavia, NY plant.

Applications:

Liquid ring vacuum pumps are used in the Refining Industry-for crude oil vacuum distillation, lube oil dryers, and for asphalt production; and in the Power Industry to evacuate steam surface condensers. Other industries (food, chemicals, pharmaceuticals, hospitals, pulp &

paper, etc.) use liquid ring vacuum pumps extensively.

LIQUID RING VACUUM PUMP BENEFITS

- Reliable, simple design involves only one rotating part, which is not subject to wear.
- Can handle condensable vapors or even slugs of liquid entrained in the gas stream without damage to the pump or affecting performance.
- Produces a steady non-pulsating gas flow when it is used as either a vacuum pump or compressor.
- Resistant to contaminants entering with the gas stream; these will be diluted and washed through the pump by the seal liquid.
- Wide choice of materials are readily available for handling most gases and seal liquids.
- Can handle volumes from 3 to 4000 ACFM over a vacuum range from atmospheric to 25 TORR. Also totally compatible with steam ejectors for higher vacuums and flow rates.
- Graham pumps are precision made and performance guaranteed.

VACUUM SYSTEMS

Types and pressure ranges

Ejector systems:

Ejector systems are made up of a number of ejector stages in series with condensers (direct contact or surface type) between stages to condense the load and motive fluids where temperature and pressure permit. Since Ejectors are a fixed-capacity device, various parallel-series arrangements are used to accomplish process load control and pressure control.

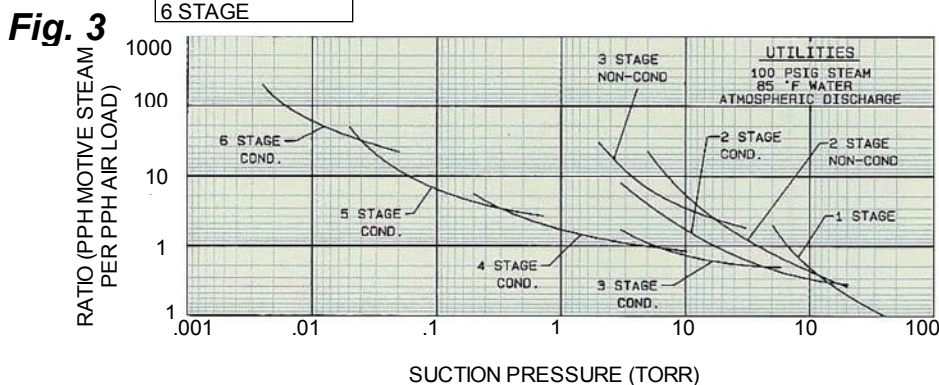
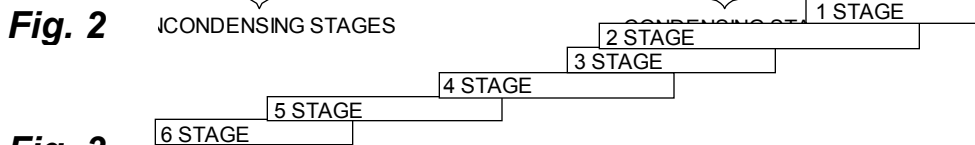
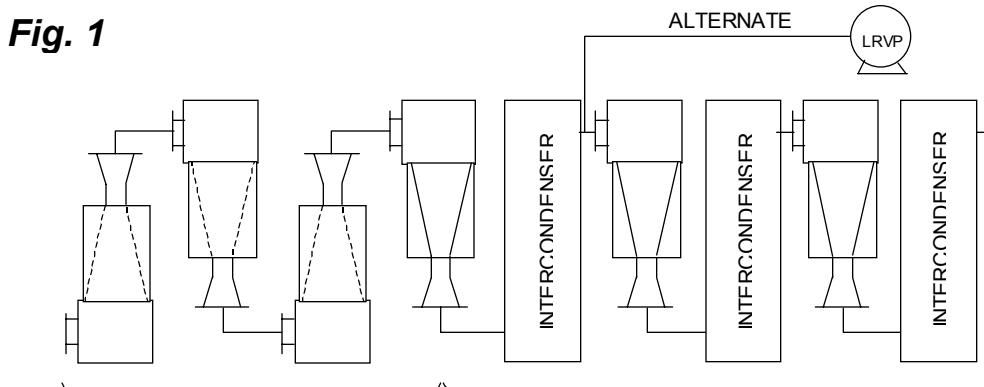

Fig. 1 shows a schematic arrangement for a six-stage ejector system compressing non-condensibles to a positive pressure. It also indicates a Graham Liquid Ring Vacuum Pump that can be used to replace the final two Ejector stages. Choice of equipment is generally determined by cost factors. Approximate pressures at the suction and discharge of each stage are shown on the Figure 2 schematic.

Fig. 2 can be used to estimate the number of stages required for a given application. For example, if the desired pressure is 1 TORR, the chart shows this in the middle of the four-stage range. At 0.5 TORR, a four- or five-stage unit is indicated. Selection is usually

determined by comparing initial costs and utilities cost.

Fig. 3 shows the approximate steam consumption per pound of air load for various systems as a function of dry air handling capacity.



Bronze Ejectors and Liquid Ring Pump with air ejector for salt water deaerating service.



Combination steam Ejectors and Liquid Ring Vacuum Pump package for low oxygen deaerating condenser.



Five stage Ejector with jacketed diffusers for polyester plant.

Types of systems:

Single-stage steam Ejectors: These are the most simple systems, producing vacuum from just a few inches of water draft to approximately 50 TORR. They are used with or without precondensers. Thermocompressors (recompression boosters) are single-stage Ejectors designed to boost low-pressure steam to a high pressure and temperature. Most thermocompressors are used to increase the efficiency of heaters, dryers or evaporators.

Multiple-stage non-condensing Ejectors: These are used when the prime requirements are to achieve low absolute pressures (10-50 TORR) with minimum initial cost or in limited space. They require no condensers or condenser water.

Multiple-stage condensing Ejectors: These systems usually have two or three ejector stages separated by intercondensers to condense the condensible portion of the vapor mixture entering the intercondenser and reduce the load on the following stage. These systems are designed for low absolute pressures (5 to 100 TORR) and minimum operating costs.

Multiple-stage non-condensing Ejectors followed by multiple-stage condensing Ejectors: This configuration is used with interstage condensing to achieve extremely low vacuums (.001 to 5 TORR) with economy. As many as six ejector stages in series are used to achieve pressures at the magnitude of .001 TORR. Six-stage ejectors are primarily used in vacuum metallurgy and space simulation.

Combination Steam Ejector and Liquid Ring Vacuum Pump systems: Combination systems are often used to reduce energy costs. Pressure ranges from atmosphere to 50 TORR can be handled by Liquid Ring Pumps alone. Lower absolute pressures (1 to 50 TORR) require a combination with a steam jet ejector. When compared to an all-steam ejector system, the Liquid Ring Pump involves higher initial and maintenance costs, but lower operating costs.

Other factors to consider include: operating simplicity, ability to handle corrosive vapors, available space, and the cost and availability of spare parts. In many existing multi-stage vacuum systems it is advantageous to replace the final two Ejector stages with a Liquid Ring Vacuum Pump to reduce operating costs.

CONDENSERS

In most vacuum systems, condensers are used as precondensers, intercondensers and aftercondensers depending on the application. They all condense the motive steam and any condensable vapor from the preceding stages, leaving only the saturated noncondensable gases to be handled by the next stage. The condensate is drained either by a barometric leg or a condensate pump.

Most of these Condensers are either the direct-contact spray type or shell and tube (surface) type. Occasionally, other types are used for special applications, such as air cooled, evaporative, or spiral tube condensers.

Shell and tube (surface) Condensers: These Condensers do not mix vapors and cooling water, so there is no contamination of the cooling water. A shell and tube heat exchanger-specially adapted for condensing on either the shell or tube side-is often used for pre, inter, or aftercondensing.

If the condensing vapors are extremely fouling, tube-side condensation is preferred for easy mechanical cleaning. If fouling is minor, shell-side condensing is better because of higher condensing efficiency.

Shell and tube condensers can be either fixed tubesheet or removable tube bundle design. The latter simplifies cleaning both sides. Units are available in any combination of materials to suit process applications.

Direct-contact Condensers: This type of Condenser mixes the condensing vapors and water intimately, thus causing condensation. Due to pollution caused by direct mixing, these Condensers are now used only for applications in which vapors are clean and where initial cost is a primary factor.



Shell and tube condensers in oil refinery vacuum service.

Spiral Tube Heliflow Condensers: The Graham Heliflow Spiral Tube Condenser is often used to save space and maintain high condensing efficiency. They are easily adapted to tower top mounting.

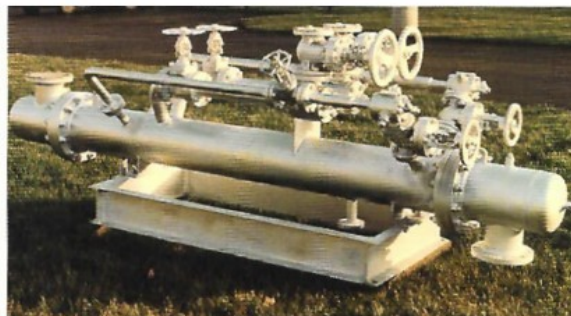

Twin element two-stage ejector with shell and tube combined inter and aftercondensers



Vent condenser.



Two-stage ejector system with Heliflow inter and aftercondenser



Direct contact horizontal condenser for 12.5 MW plant in Nevada

PACKAGES AND MODULES

Graham engineering specializes in designing complex packages and modules complete with pricing, pneumatic or electric controls, and supporting framework. These can be far more economical than field-constructed systems. A complete line of spare parts is kept available at our Batavia, NY plant.



Six section modular combination ejector system-liquid ring vacuum pumps in refinery service.

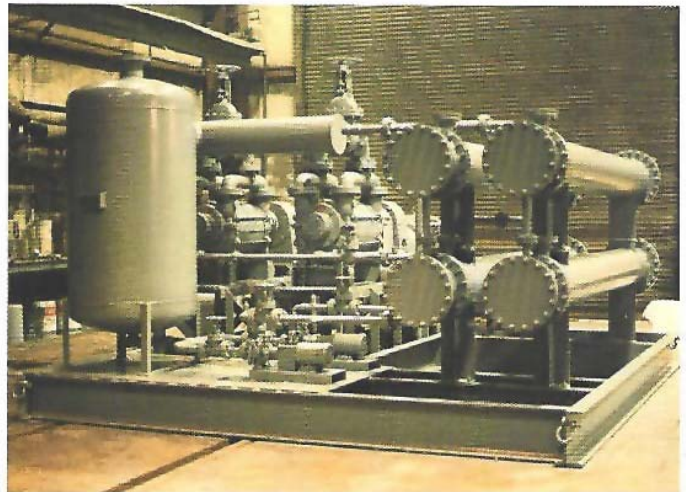

Liquid ring pump package for a pulp and paper mill.

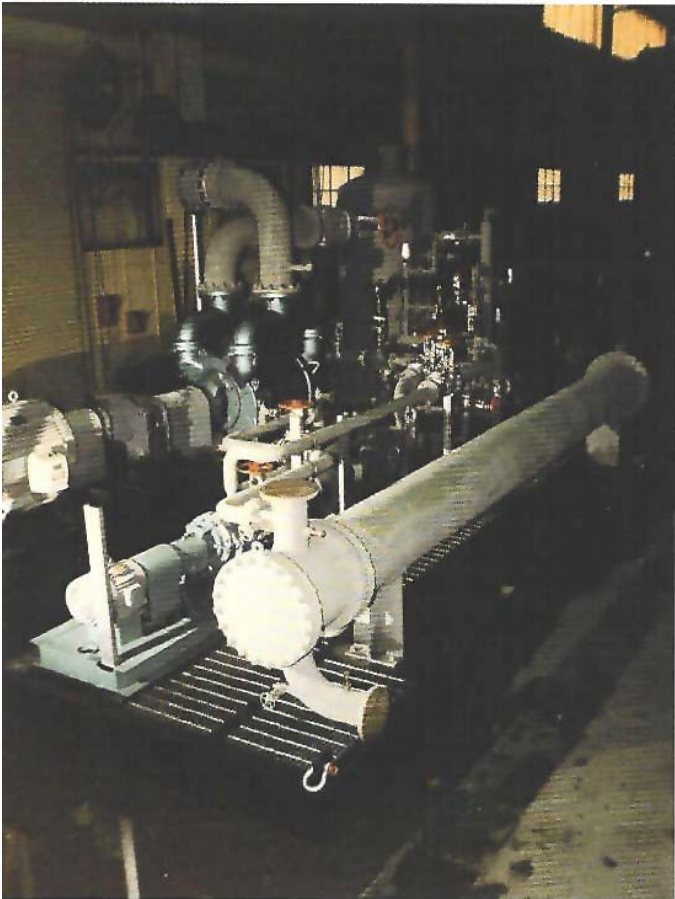

Liquid ring pump package for refinery service.



Liquid ring compressors for crude oil vacuum distillation tower.

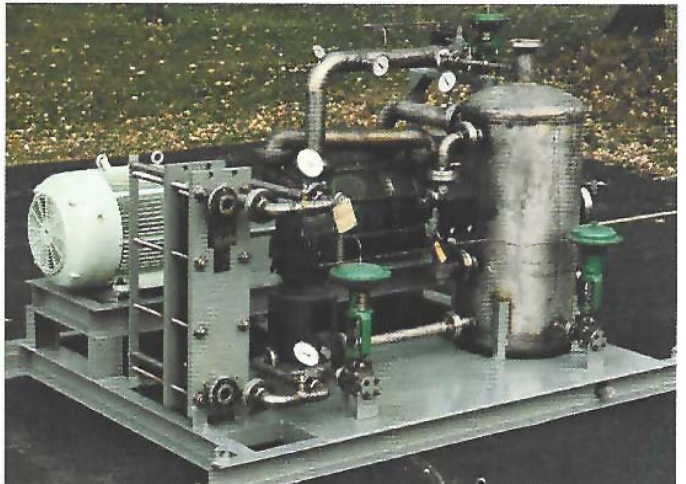

Liquid ring pump with recirculation package for chemical plant service.

INDUSTRIAL APPLICATIONS

REFINING

Crude oil vacuum distillation:

Three-stage Ejectors
Precondenser with two-stage Ejectors
Precondenser with Liquid Ring Vacuum Pump

Lube oil dryers:

Single-stage Ejectors
Two-stage Ejectors
Liquid Ring Vacuum Pumps



Three-stage Ejector system in refinery service.



Ejectors in vacuum distillation service.



Triple element booster Ejectors in refinery service.

PROCESS

units used for urea, synthetic fibers, pharmaceuticals, tobacco drying, crystallizers, evaporators, and desalinization.



Combination system for polyester plant.



Ejector and Condensers in a urea plant.



Combination system with graphite intercondenser for a pharmaceutical plant.

POWER

Steam surface condensers:
Twin-element two-stage Ejectors
Liquid Ring Vacuum Pumps
Combination Steam Ejector/
Liquid Ring Vacuum Pump



Large Condenser exhaust system.

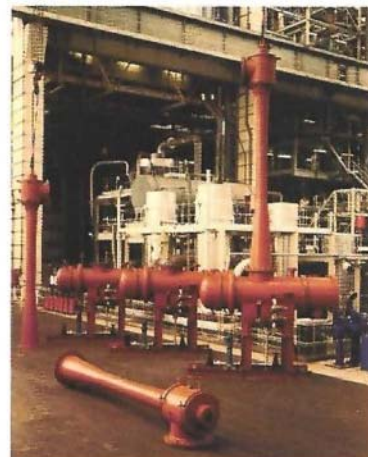

Booster Ejectors and Condensers for enhanced venting of surface condenser.



A 166,000 sq.ft. steam surface Condenser.

GEOTHERMAL STEAM CONDENSERS AND GAS REMOVAL SYSTEMS

Graham has many years of experience designing systems with high non-condensable gas loadings. Since geothermal steam is highly corrosive and contains large amounts of noncondensable gases (1-10%), the design and fabrication of Geothermal Steam Condensers is radically different than conventional power plant condensers. Special consideration must be given to:

- Reduced overall heat transfer rates (U value) and weighted LMTD due to noncondensable gases.
- Flow path for venting large volumes of noncondensable gases.
- Pressure drop of noncondensable gases.
- Subcooling of noncondensable gases.
- Preventing subcooling of the condensate.
- Special materials to prevent corrosion.

The associated vacuum system can be multi-stage Steam Ejectors or a combination of a Steam Ejector and Liquid Ring Vacuum Pump. Since these systems are very large, Graham engineers will carefully evaluate the design and selection of components for each application, to provide the most efficient system.



A 54,000 sq. ft. steam surface condenser for 32 MW geothermal power plant in California.



Direct contact geothermal condenser for 9 MW plant.

FOOD

For flash cooling, evaporators, degassing, and deodorizing.

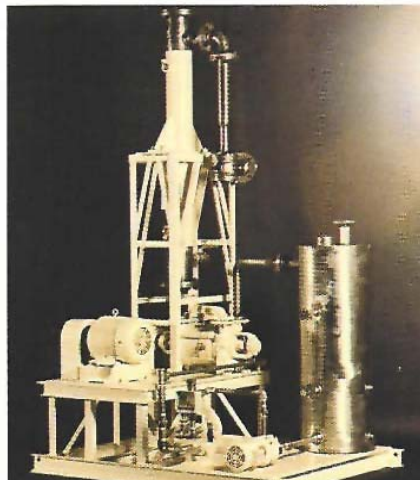

Combination ejector and liquid ring pump for a juice evaporator.

METAL REFINING

For vacuum melting and vacuum degassing.

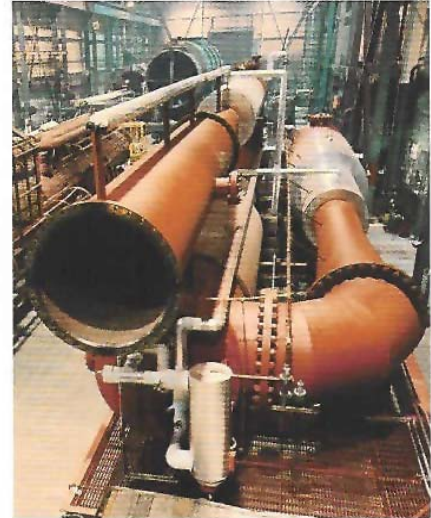

Six stage ejector package before shipment to a steel company.

MARINE

Ejectors for main and auxiliary Condensers and distilling equipment.



Condensers and air ejectors.

PULP AND PAPER

Liquid Ring Vacuum Pumps:
Steam Vacuum Refrigeration to chill water for chlorine dioxide bleach plants.



3,400 ton steam vacuum refrigeration unit.

OPERATIONS AND CAPABILITIES

Computerized capabilities include an HTRI rating, TEMA and ASME mechanical design, CAD/CAM systems, and numerical control programming.

Advanced production capabilities include high production numerical control machine tools, special welding and plasma burning

equipment, and heavy lift cranes (120 tons). Graham is well-equipped to design, produce and test vacuum systems totally in-house. As a result, we are better able to maintain high quality standards and strict production control. Our customers are saved the time, inconvenience and costs of dealing with numerous sub-vendors.



Computer plotter.



Computer-controlled 37 multi-spindle drill for tube sheets and support plates.



Testing first four stages of six stage ejector.



Computer facilities.

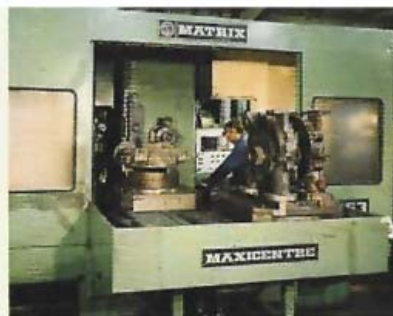

NC machining of vacuum pumps.

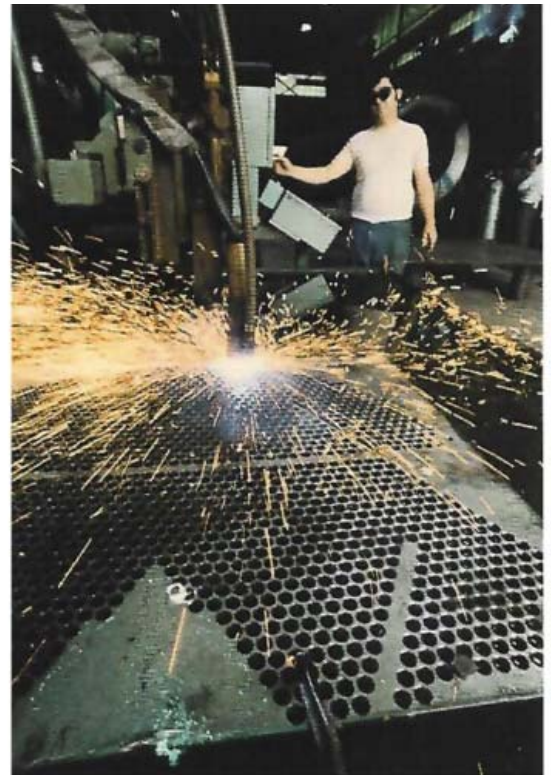

NC plasma arc burning of tube sheets and supports.

VACUUM TECHNOLOGY LEADERSHIP

Graham is firmly committed to maintaining its worldwide leadership in vacuum technology, and conducts continuing research and development to further that position. We work closely with our sales engineers and representatives throughout the world to keep abreast of current customer needs.

We design and fabricate vacuum systems to all of the world's recognized codes: ASME, TEMA, TUV, ANCC, STOOMWEZEN, ABS, BSS and ASME Nuclear Section III, Class 3. This includes meeting all specifications of the oil, chemical, power and other industries we serve.



Two automated condenser exhauster packages with combination of ejectors and liquid ring vacuum pumps.

Most of our vacuum systems are performance tested in our facilities before shipment to assure reliability. Our experienced service engineers are available for systems start-up assistance, and to solve customer vacuum system operating problems.

Graham has been designing, building and servicing vacuum systems for more than 60 years, and this extensive experience can help you meet your needs in the most effective, reliable and economical ways.



Carbamate recycle ejector for urea plant.

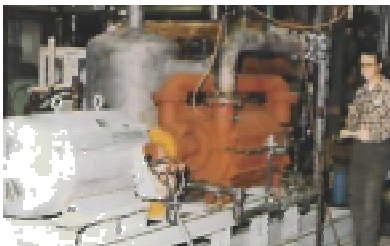

Test stand for liquid ring vacuum pumps.



A 90,260 sq. ft. steam condenser for geothermal power plant in California.



Process vacuum condensers



Vacuum refrigeration systems



Heliflow® heat exchangers

Building engineered solutions



Vacuum pump packaged systems



Vacuum ejectors systems



MicroMix® II instantaneous steam water heaters

for the process, power, pharmaceutical and



Liquid ring vacuum pumps



Plate heat exchangers



Steam surface condensers

commercial industries, worldwide.



Dry vacuum pumps



Graham VacWorks II™ Design Program. A CD-ROM loaded with comprehensive vacuum system design software and technical support information. Providing many engineered solutions for your vacuum system needs.



ONE SOURCE –
DESIGNED, BUILT AND TESTED.

Graham Corporation
20 Florence Ave., Batavia, NY 14020 USA
Phone: 585-343-2216
FAX: 585-343-1097
Web site: <http://www.graham-mfg.com>
Email: equipment@graham-mfg.com