



Vent-Free Gas Wall Heater Blue Flame

Model # 1096513.9

2096513.9

3096513.9

WARNING: This appliance is equipped for (Natural and Propane) gas. Field conversion is not permitted other than between natural or propane gases.

HEATER IS PRESET FOR PROPANE AT FACTORY SEE INSTALLATION INSTRUCTIONS FOR NATURAL GAS HOOK UP

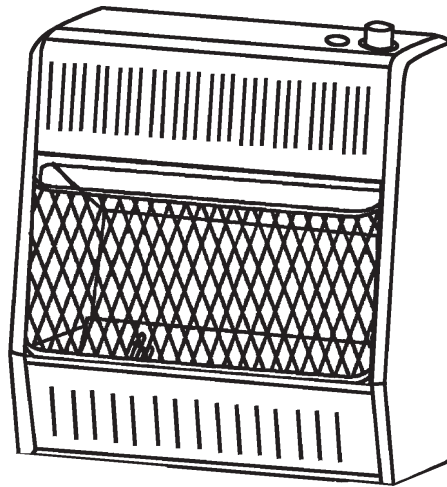

CAUTION - FOR YOUR SAFETY



WARNING: IF THE INFORMATION IN THIS MANUAL IS NOT FOLLOWED EXACTLY, A FIRE OR EXPLOSION MAY RESULT CAUSING PROPERTY DAMAGE, PERSONAL INJURY, OR LOSS OF LIFE.

– Do not store or use gasoline or other flammable vapors and liquids in vicinity of this or any other appliance.

WHAT TO DO IF YOU SMELL GAS

- Do not try to light any appliance.
- Do not touch any electrical switch; do not use any phone in your building.
- Immediately call your gas supplier from a neighbor's phone. Follow the gas supplier's instructions.
- If you cannot reach your gas supplier, call the fire department.

– Installation and service must be performed by a qualified installer, service agency or the gas supplier.

This is an unvented gas-fired heater. It uses air (oxygen) from the room in which it is installed. Provisions for adequate combustion and ventilation air must be provided. Refer to Air For Combustion and Ventilation section on page 9 of this manual.

INSTALLER: Leave this manual with the appliance. **CONSUMER:** Retain this manual for future reference.

This appliance may be installed in an aftermarket, permanently located, manufactured (mobile) home, where not prohibited by local codes. This appliance is only for use with propane or natural gas. This appliance is equipped with a simple means to switch between propane and natural gas. Field conversion by any other means including the use of a kit is not permitted.



Questions about installation, operation, or troubleshooting? Before returning to your dealer, call WILLIAMS FURNACE at 909-825-0993.

TABLE OF CONTENTS

Important Safety Information	3
Product Features	5
Preparing for Installation	6
Air for Combustion & Ventilation	7
Installation	10
Operation	16
Care and <i>Maintenance</i>	19
Troubleshooting	20
Replacement Parts	23



WARNING: READ THE INSTALLATION & OPERATION INSTRUCTIONS BEFORE USING THIS APPLIANCE.

IMPORTANT: Read this owner's manual carefully and completely before trying to assemble, operate, or service this heater. Improper use of this heater can cause serious injury or death from burns, fire, explosion, and carbon monoxide poisoning.

PRODUCT SPECIFICATIONS

MODEL	1096513.9	2096513.9	3096513.9
BTU (available)	10,000	20,000	30,000
Gas Type	Using Natural Gas	Using Natural Gas	Using Natural Gas
Pressure Regulator Setting	4 in. W.C.	4 in. W.C.	4 in. W.C.
Inlet Gas Pressure* (inches of water) * For purposes of input adjustment.			
Maximum	10.5 in.	10.5 in.	10.5 in.
Minimum *	5 in.	5 in.	5 in.
Gas Type	Using Propane Gas	Using Propane Gas	Using Propane Gas
Pressure Regulator Setting	9 in. W.C.	9 in. W.C.	9 in. W.C.
Inlet Gas Pressure* (inches of water) * For purposes of input adjustment.			
Maximum	14 in.	14 in.	14 in.
Minimum *	11 in.	11 in.	11 in.
Ignition	Electric Piezo	Electric Piezo	Electric Piezo
Dimensions, Inches (HxWxD)			
Heater	19 1/8 × 14 1/8 × 6 3/8	23 1/2 × 19 1/4 × 8	23 1/2 × 26 5/8 × 8
Carton	22 × 16 3/4 × 8 1/8	25 3/4 × 21 3/4 × 9 1/4	25 3/4 × 28 1/2 × 9 1/4
Weight (Pounds)			
Heater	14.6	22.2	28.1
Shipping	17.6	26.2	33.1

IMPORTANT SAFETY INFORMATION

IMPORTANT: Read this owner's manual carefully and completely before trying to assemble, operate, or service this heater. Improper use of this heater can cause serious injury or death from burns, fire, explosion, electrical shock, and carbon monoxide poisoning.

Only a qualified installer, service agent, or local gas supplier may install and service this product.

⚠ WARNING: Do not store or use gasoline or other flammable vapors and liquids in the vicinity of this or any other appliance.

⚠ WARNING: This appliance can be used with propane or natural gas. It is shipped from the factory adjusted for use with propane.

CARBON MONOXIDE POISONING: Early signs of the carbon monoxide poisoning resemble the flu with headache, dizziness and/or nausea. If you have these signs, the heater may not be working properly. Get fresh air at once! Have heater serviced. Some people - pregnant women, persons with heart or lung disease, anemia, those under the influence of alcohol, those at high altitude - are more affected by carbon monoxide than others.

NATURAL AND PROPANE/LP GAS: Natural and Propane/LP gas are odorless. An odor-producing agent is added to the gas. The odor helps you detect a gas leak. However, the odor added to the gas can fade. Gas may be present even though no odor exists.

⚠ WARNING: Any change to this heater or its controls can be dangerous.

⚠ WARNING: Do not use any accessories not approved for use with this heater.

⚠ WARNING: Carefully supervise young children when they are in the room with the heater.

⚠ WARNING: Make sure grill guard is in place before running heater.

⚠ WARNING: Keep the appliance area clear and free from combustible materials, gasoline, and other flammable vapors and liquids.

⚠ WARNING: Due to high temperatures, the appliance should be located out of traffic and away from furniture and draperies.

⚠ WARNING: Heater becomes very hot when running. Keep children and adults away from hot surfaces to avoid burns or clothing ignition. Heater will remain hot for a time after shutoff. Allow surfaces to cool before touching.

⚠ WARNING: Do not place clothing or other flammable material on or near the appliance. Never place any objects in or on the heater.

1. Do not place Propane/LP supply tank(s) inside any structure. Propane/LP supply tank(s) must be placed outdoors.
2. This heater shall not be installed in a bedroom or bathroom.
3. This heater needs fresh air ventilation to run properly. This heater has an Oxygen Depletion Sensing (ODS) safety shutoff system. The ODS shuts down the heater if not enough fresh air is available. See *Air for Combustion and Ventilation*, pages 7 through 9. If heater keeps shutting off, see *Troubleshooting*, pages 21 through 23.
4. Keep all air openings in front and bottom of heater clear and free of debris. This will ensure enough air for proper combustion.

5. If heater shuts off, do not relight until you have provided fresh, outside air. If heater keeps shutting off, have it serviced.
6. Do not run heater:
 - Where flammable liquids or vapors are used or stored.
 - Under dusty conditions.
7. Before using furniture polish, wax, carpet cleaner, or similar products, turn heater off. If heated, the vapors from these products may create a white powder residue within burner box or on adjacent walls or furniture.
8. Always run heater with control knob at PILOT/IGN, LOW or HIGH (5-1) locked positions. Never set control knob between locked positions. Poor combustion and higher levels of carbon monoxide may result.
9. Do not use heater if any part has been under water. Immediately call a qualified service technician to inspect the room heater and to replace any part of the control system and any gas control which has been under water.
10. Turn off and unplug heater and let cool before servicing. Only a qualified service person should service and repair heater.
11. Operating heater above elevations of 4,500 feet could cause pilot outage.
12. To prevent performance problems, do not use propane/LP fuel tank of less than 100 lbs. capacity.

QUALIFIED INSTALLING AGENCY

Only a qualified agency should install and replace gas piping, gas utilization equipment or accessories, and repair and equipment servicing. The term "qualified agency" means any individual, firm, corporation, or company that either in person or through a representative is engaged in and is responsible for:

- a) Installing, testing, or replacing gas piping or
- b) Connecting, installing, testing, repairing, or servicing equipment; that is experienced in such work; that is familiar with all precautions required; and that has complied with all the requirements of the authority having jurisdiction.

PRODUCT FEATURES

SAFETY PILOT

This heater has a pilot with an Oxygen Depletion Sensing (ODS) safety shutoff system. The ODS/pilot shuts off the heater if there is not enough fresh air.

PIEZO IGNITION SYSTEM

This heater is equipped with an electronic piezo control system. This system requires AAA batteries (provided).

TWO GAS OPTIONS CAPABLE

Your heater is equipped to operate on either Propane or Natural gas. The heater is shipped from the factory ready for connecting to Propane. The heater can easily be changed to Natural gas by having your qualified installer follow the instructions on page 13 and the markings on the heater.

THERMOSTATIC CONTROL ON THERMOSTAT MODEL

These heaters have a control valve with a thermostat sensing bulb. This results in the greatest heater comfort and may result in lower gas bills.

State of Massachusetts: The installation must be made by a licensed plumber or gas fitter in the Commonwealth of Massachusetts. Sellers of unvented propane or natural gas-fired supplemental room heaters shall provide to each purchaser a copy of 527 CMR 30 upon sale of the unit.

In the State of Massachusetts, unvented propane or natural gas-fired space heaters shall be prohibited in bedrooms and bathrooms.

In the State of Massachusetts the gas cock must be a T-handle type. The State of Massachusetts requires that a flexible appliance connector cannot exceed three feet in length.

LOCAL CODES

Install and use heater with care. Follow all local codes. In the absence of local codes, use the latest edition of The *National Fuel Gas Code, ANSI Z223.1/ NFPA 54*.

*Available from:

American National Standards Institute, Inc.
1430 Broadway
New York, NY 10018

National Fire Protection Association, Inc.
1 Batterymarch Park
Quincy, MA 02269-9101

PREPARING FOR INSTALLATION

Before beginning assembly or operation of the product, make sure all parts are present. Compare parts with package contents list and diagram above. If any part is missing or damaged, do not attempt to assemble, install or operate the product. Contact customer service for replacement parts.

Before installing heater, make sure you have the items listed below:

- piping (check local codes)
- sealant (resistant to natural gas and propane/LP gas)
- equipment shutoff valve*
- test gauge connection*
- sediment trap
- tee joint
- pipe wrench
- flexible gas hose (check local codes)

* A CSA design-certified equipment shutoff valve with 1/8-inch NPT tap is an acceptable alternative to test gauge connection. Purchase the optional CSA design-certified equipment shutoff valve from your dealer.

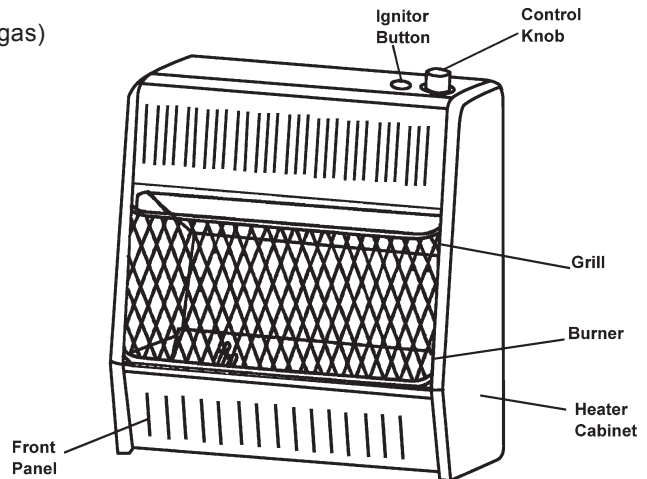

Figure 1

UNPACKING

1. Remove heater from carton.
2. Remove all protective packaging applied to heater for shipping
3. Check heater for any shipping damage. If heater is damaged, promptly inform dealer where you bought heater.

WATER VAPOR: A BY-PRODUCT OF UNVENTED ROOM HEATERS

Water vapor is a by-product of gas combustion. An unvented room heater produces approximately one (1) ounce (30 mL) of water for every 1,000 BTUs (.3 KWs) of gas input per hour. Unvented room heaters are recommended as supplemental heat (a room) rather than a primary heat source (an entire house). In most supplemental heat applications, the water vapor does not create a problem. In most applications, the water vapor enhances the low humidity atmosphere experienced during cold weather.

The following steps will help ensure that water vapor does not become a problem.

1. Be sure the heater is sized properly for the application, including ample combustion air and circulation air.
2. If high humidity is experienced, a dehumidifier may be used to help lower the water vapor content of the air.
3. Do not use an unvented room heater as the primary heat source.

AIR FOR COMBUSTION AND VENTILATION

⚠ WARNING: If the area in which the heater may be operated does not meet the required volume for indoor combustion air, combustion and ventilation air shall be provided by one of the methods described in the National Fuel Gas Code, ANSI Z223.1/NFPA 54, the International Fuel Gas Code, or applicable local codes.

Providing Adequate Ventilation

All spaces in homes fall into one of the three following ventilation classifications:

1. Unusually Tight Construction
2. Unconfined Space
3. Confined Space

The information on pages 7 through 9 will help you classify your space and provide adequate ventilation.

Confined and Unconfined Space

A confined space is a space whose volume is less than 50 cu. ft. per 1,000 BTU/hr (4.8 m³ per kw) of the aggregate input rating of all appliances installed in that space and an unconfined space as a space whose volume is not less than 50 cubic feet per 1,000 BTU/hr (4.8 m³ per kw) of the aggregate input rating of all appliances installed in that space. Rooms connecting directly with the space in which the appliances are installed*, through openings not furnished with doors, are considered a part of the unconfined space.

This heater shall not be installed in a confined space or unusually tight construction unless provisions are provided for adequate combustion and ventilation air.

* Adjoining rooms are connecting only if there are doorless passageways or ventilation grills between them.

Unusually Tight Construction

The air that leaks around doors and windows may provide enough fresh air for combustion and ventilation. However, in buildings of unusually tight construction, you must provide additional fresh air.

Unusually tight construction is defined as construction where:

- a) Walls and ceilings exposed to the outside atmosphere have a continuous water vapor retarder with a rating of one perm (6×10^{-11} kg per pa-sec-m²) or less with openings gasketed or sealed and
- b) Weather stripping has been added on openable windows and on doors and
- c) Caulking or sealants are applied to areas such as joints around window and door frames, between sole plates and floors, between wall ceiling joints, between wall panels, at penetrations for plumbing, electrical, and gas lines, and at other openings.

If your home meets all of the three criteria above, you must provide additional fresh air. See "Ventilation Air From Outdoors" (page 9). If your home does not meet all of the three criteria above, proceed to "Determining Fresh-Air Flow For Heater Location".

DETERMINING FRESH-AIR FLOW FOR HEATER LOCATION

Determining if You Have a Confined or Unconfined Space

Use this worksheet to determine if you have a confined or unconfined space.

Space: Includes the room in which you will install heater plus any adjoining rooms with doorless passageways or ventilation grills between the rooms.

- Determine the volume of the space Length × Width × Height = _____ cu. ft. (volume of space)

Example: Space size 20 ft. (length) × 16 ft. (width) × 8 ft. (ceiling height) = 2560 cu. ft. (volume of space)

If additional ventilation to adjoining room is supplied with grills or openings, add the volume of these rooms to the total volume of the space.

- Divide the space volume by 50 cubic feet to determine the maximum BTU/hr the space can support.

_____ (volume of space) ÷ 50 cu. ft. = (Maximum BTU/hr the space can support)

- Add the BTU/hr of all fuel burning appliances in the space.

Vent-free heater	_____ BTU/hr	
Gas water heater*	_____ BTU/hr	
Gas furnace	_____ BTU/hr	
Vented gas heater	_____ BTU/hr	Example:
Gas heater logs	_____ BTU/hr	Gas water heater 30,000 BTU/hr
Other gas appliances* +	_____ BTU/hr	Vent-free heater + 26,000 BTU/hr
Total	= _____ BTU/hr	Total = 56,000 BTU/hr

*Do not include direct-vent gas appliances. Direct-vent draws combustion air from the outdoors and vents to the outdoors.

- Compare the maximum BTU/hr the space can support with the actual amount of

BTU/hr used

_____ BTU/hr (maximum the space can support)

_____ BTU/hr (actual amount of BTU/hr used)

Example : 51,200 BTU/hr (maximum the space can support)

56,000 BTU/hr (actual amount of BTU/hr used)

The space in the above example is a confined space because the actual BTU/hr used is more than the maximum BTU/hr the space can support.

You must provide additional fresh air. Your options are as follows:

- Rework worksheet, adding the space of an adjoining room. If the extra space provides an unconfined space, remove door to adjoining room or add ventilation grills between rooms. See “Ventilation Air From Inside Building” (page 9).
- Vent room directly to the outdoors. See “Ventilation Air From Outdoors” (page 9).
- Install a lower BTU/hr heater if lower BTU/hr size makes room unconfined. If the actual BTU/hr used is less than the maximum BTU/hr the space can support, the space is an unconfined space. You will need no additional fresh air ventilation.

⚠ WARNING: If the area in which the heater may be operated does not meet the required volume for indoor combustion air, combustion and ventilation air shall be provided by one of the methods described in the NATIONAL FUEL GAS CODE, ANSI Z223.1/ NFPA 54, the INTERNATIONAL FUEL GAS CODE, or applicable local codes.

Ventilation Air From Inside Building

This fresh air would come from an adjoining unconfined space. When ventilating to an adjoining unconfined space, you must provide two permanent openings: one within 12 inches of the ceiling and one within 12 inches of the floor on the wall connecting the two spaces (see options 1 and 2, Figure 2). You can also remove the door into adjoining room (see option 3, Figure 2). Follow the *National Fuel Gas Code, ANSI Z223.1/ NFPA 54, Air for Combustion and Ventilation* for required size of ventilation grills or ducts.

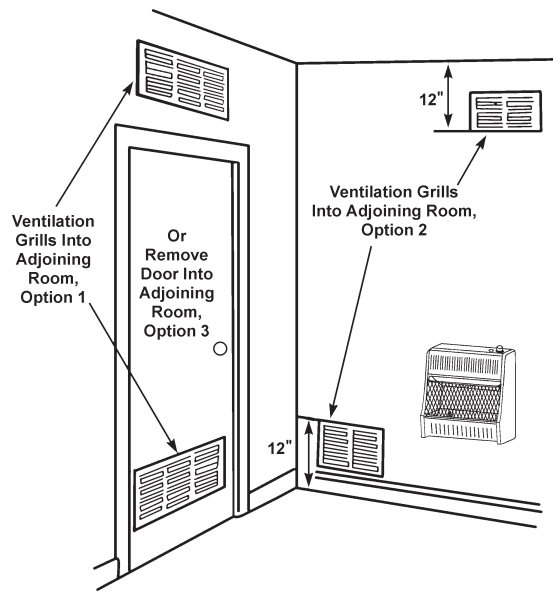

Figure 2 - Ventilation Air from Inside Building

NOTE: Base not included. Not for use in bedrooms or bathrooms.

Ventilation Air From Outdoors

Provide extra fresh air by using ventilation grills or ducts. You must provide two permanent openings: one within 12 inches of the ceiling and one within 12 inches of the floor. Connect these items directly to the outdoors or spaces open to the outdoors. These spaces include attics and crawl spaces. Follow the *National Fuel Gas Code, ANSI Z223.1/ NFPA 54, Air for Combustion and Ventilation* for required size of ventilation grills or ducts.

⚠ IMPORTANT: Do not provide openings for inlet or outlet air into attic if attic has a thermostat-controlled power vent. Heated air entering the attic will activate the power vent. Rework worksheet, adding the space of the adjoining unconfined space. The combined spaces must have enough fresh air to supply all appliances in both spaces.

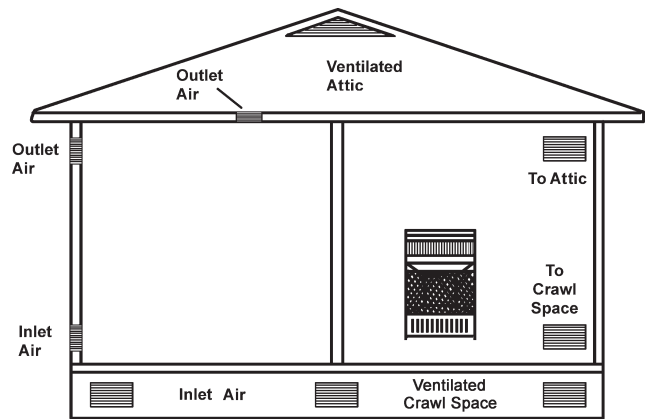

Figure 3 - Ventilation Air from Outdoors

INSTALLATION

NOTICE: This heater is intended for use as supplemental heat. Use this heater along with your primary heating system. Do not install this heater as your primary heat source. If you have a central heating system, you may run system's circulating blower while using heater. This will help circulate the heat throughout the house. In the event of a power outage, you can use this heater as your primary heat source.

CAUTION: If you install the heater in a home garage:

- Heater pilot and burner must be at least 18 inches above the floor.
- Place heater where moving vehicle will not hit it.

WARNING: A qualified service person must install heater. Follow all local codes.

WARNING: Never install the heater

- in a bedroom or bathroom
- in a recreational vehicle
- where curtains, furniture, clothing, or other flammable objects are less than 36 inches from the front, top, or sides of the heater
- in high traffic areas
- in windy or drafty areas

CAUTION: This heater creates warm air currents. These currents move heat to wall surfaces next to heater. Installing heater next to vinyl or cloth wall coverings or operating heater where impurities (such as tobacco smoke, aromatic candles, cleaning fluids, oil or kerosene lamps, etc.) in the air exist, may cause walls to discolor.

IMPORTANT: Vent-free heaters add moisture to the air. Although this is beneficial, installing heater in rooms without enough ventilation air may cause mildew to form too much moisture. See Air for Combustion and Ventilation, pages 7 through 9.

Check Gas Type

Be sure your gas supply is right for your heater. Otherwise, call dealer where you bought the heater for proper type heater.

Clearances To Combustibles

Carefully follow the instructions below. This heater is a freestanding unit designed to be mounted on a wall or set directly on the floor.

WARNING: Maintain the minimum clearances shown in Figure 4. If you can, provide greater clearances from floor, ceiling, and joining wall.

LOCATING HEATER

This heater is designed to be mounted on a wall. For convenience and efficiency, install heater:

- 1) where there is easy access for operation, inspection, and service.
- 2) In the coldest part of room.

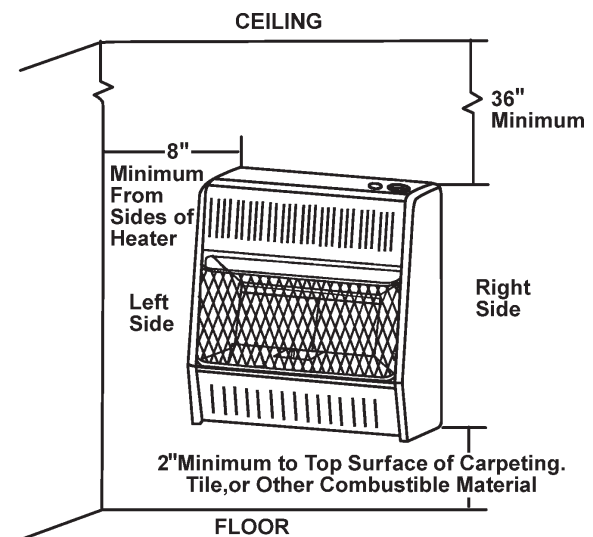

Figure 4 - Mounting clearances as viewed from front of heater (inches)

FASTENING HEATER TO WALL

Mounting Bracket

The mounting bracket is located on back panel of heater (see Figure 5). It has been taped there for shipping. Remove mounting bracket from back panel.

Removing Front Panel of Heater

1. Remove two screws near bottom corners of lower front panel.
2. Pull bottom of lower front panel forward, then down (see Figure 6).

Methods For Attaching Mounting Bracket To Wall

Use only the last hole on each end of mounting bracket to attach bracket to wall. Attach mounting bracket to a wall only in one of two ways:

1. *Attaching to wall stud:* This method provides the strongest hold. Insert mounting screws through mounting bracket and into wall studs.
2. *Attaching to wall anchor:* This method allows you to attach mounting bracket to hollow walls (wall areas between studs) or to solid walls (concrete or masonry).
3. Decide which method better suits your needs. Either method will provide a secure hold for the mounting bracket.

Marking Screw Locations

1. Tape mounting bracket to wall where heater will be located. Make sure mounting bracket is level.



WARNING: Maintain minimum clearances shown in Figure 4. If you can, provide greater clearances from floor and joining wall.

2. Mark screw locations on wall (see Figure 7).

Note: Mark only last hole on each end of mounting bracket. Insert mounting screws through these holes only.

3. Remove tape and mounting bracket from wall.

Attaching Mounting Bracket To Wall

Note: Wall anchors, mounting screws, and spacers are in hardware package. The hardware package is provided with heater.

Attaching to Wall Stud Method

For attaching mounting bracket to wall studs:

1. Drill holes at marked locations using 9/64-inch drill bit.
2. Place mounting bracket onto wall. Line up last hole on each end of bracket with holes drilled in wall.
3. Insert mounting screws through bracket and into wall studs.
4. Tighten screws until mounting bracket is firmly fastened to wall studs.

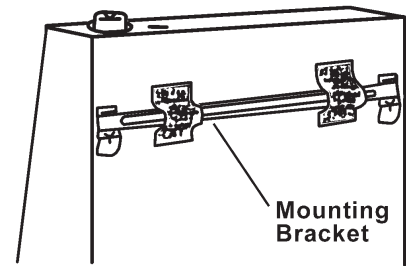

Figure 5 - Mounting Bracket Location

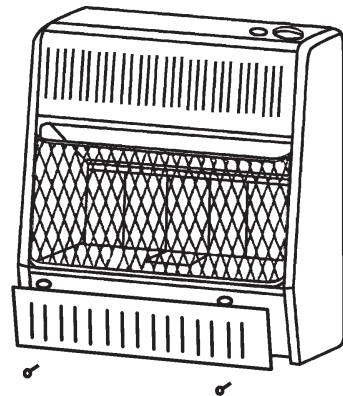
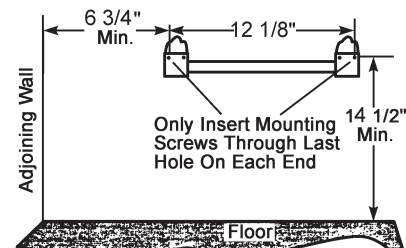
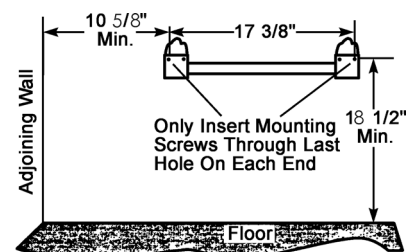

Figure 6 - Removing Front Panel Of Heater



Model: 1096513.9



Model: 2096513.9 and 3096513.9

Figure 7 - Mounting Bracket Clearances (inches)

Attaching to Wall Anchor Method

For attaching mounting bracket to hollow walls (wall areas between studs) or solid walls (concrete or masonry):

1. Drill holes at marked locations using 5/16-inch drill bit. For solid walls (concrete or masonry), drill at least 1 inch deep.
2. Fold wall anchor as shown in Figure 8.
3. Insert wall anchor (wings first) into hole. Tap anchor flush to wall.
4. For thin walls (1/2 inch or less), insert red key into wall anchor. Push red key to “pop” open anchor wings (see Figure 9).

⚠ IMPORTANT: Do not hammer anchor key! For thick walls (over 1/2 inch thick) or solid walls, do not pop open wings.

5. Place mounting bracket onto wall. Line up last hole on each end of bracket with wall anchors.
6. Insert mounting screws through bracket and into wall anchors.
7. Tighten screws until mounting bracket is firmly fastened to wall.

Placing Heater On Mounting Bracket

1. Locate two horizontal slots on back panel of heater (see Figure 10).
2. Place heater onto mounting bracket. Slide horizontal slots onto stand-out tabs on mounting bracket.

Installing Bottom Mounting Bracket

1. Install bottom bracket to heater bottom with two screws. It may be more convenient to remove heater from wall bracket to attach.
2. Place heater on wall mounting bracket.
3. Mark screw locations on wall.
4. Remove heater from mounting bracket.
5. If installing bottom mounting screws into hollow or solid wall, install wall anchors. Follow steps 1 through 4 under “Attaching To Wall Anchor Method”. If installing bottom mounting screw into wall stud, drill holes at marked locations using 9/64-inch drill bit.
6. Replace heater onto mounting bracket.
7. Tighten both screws until heater is firmly secured to wall. Do not over-tighten.

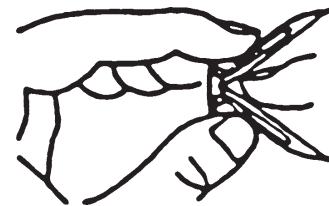

Figure 8 - Folding Anchor

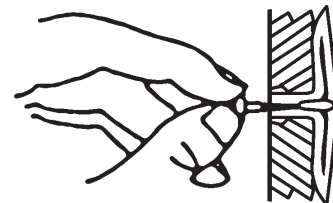

Figure 9 - Popping Open Anchor Wing For Thin Walls

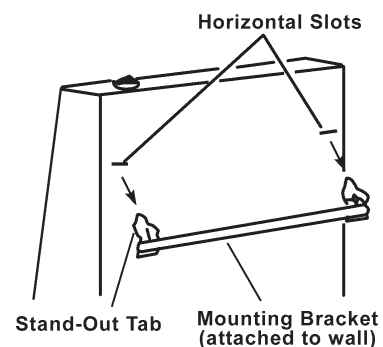

Figure 10 - Mounting Heater Onto Mounting Bracket

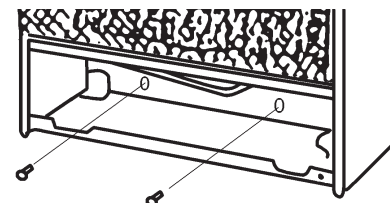

Figure 11 - Installing Bottom Mounting Bracket

CONNECTING TO GAS SUPPLY

- ⚠ WARNING:** A qualified service technician must connect heater to gas supply. Follow all local codes.
- ⚠ WARNING:** This appliance requires a 3/8-inch NPT (National Pipe Thread) inlet connection to the pressure regulator.
- ⚠ WARNING:** Never connect heater to private (non-utility) gas wells. This gas is commonly known as wellhead gas.
- ⚠ WARNING:** Do not over-tighten gas connections.
- ⚠ CAUTION:** Use only new, black iron or steel pipe. Internally tinned copper tubing may be used in certain areas. Check your local codes. Use pipe of 1/2-in. diameter or greater to allow proper gas volume to heater. If pipe is too small, undue loss of pressure will occur.
- ⚠ CAUTION:** Use pipe joint sealant that is resistant to gas (Propane or Natural Gas).

Typical Inlet Pipe Diameters Use 3/8-inch black iron pipe or greater. Installation must include an equipment shutoff valve, union, and plugged 1/8-inch NPT tap. Locate NPT tap within reach for test gauge hook up. NPT tap must be upstream from heater (see Figure 12).

- ⚠ IMPORTANT:** Install an equipment shutoff valve in an accessible location. The equipment shutoff valve is for turning on or shutting off the gas to the appliance.

NATURAL GAS MODELS:

- ⚠ CAUTION:** Check your gas line pressure before connecting heater to gas line. Gas line pressure must be no greater than 10.5 inches of water. If gas line pressure is higher, heater regulator damage could occur.

PROPANE MODELS:

- ⚠ CAUTION:** Never connect heater directly to the gas supply. This heater requires an external regulator (not supplied). Install the external regulator between the heater and gas supply.
- ⚠ CAUTION:** Avoid damage to regulator. Hold gas regulator with wrench when connecting into gas piping and/or fittings.

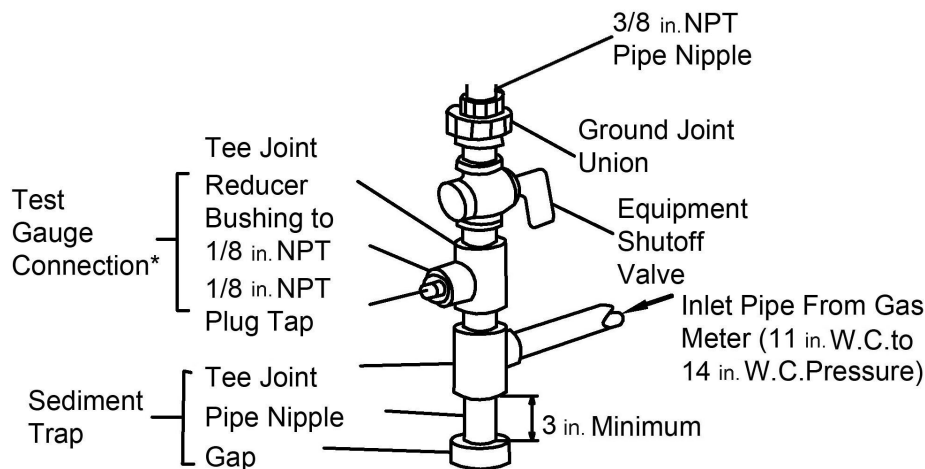

Figure 12 - Gas Connection (inches)

* Purchase the optional CSA design-certified equipment shutoff valve from your dealer.

Apply pipe joint sealant lightly to male threads. This will prevent excess sealant from going into pipe. Excess sealant in pipe could result in clogged heater valves. The installer must supply an external regulator. The external regulator will reduce incoming gas pressure. You must reduce incoming gas pressure to between 11 and 14 inches of water. If you do not reduce incoming gas pressure, heater regulator damage could occur. Install external regulator with the vent pointing down as shown in Figure 13. Pointing the vent down protects it from freezing rain or sleet.

Install sediment trap in supply line as shown in Figure 12. Place sediment trap where it is within reach for cleaning. Place sediment trap where trapped matter is not likely to freeze. A sediment trap traps moisture and contaminants. This keeps them from going into heater controls. If sediment trap is not installed or is installed wrong, heater may not run properly.

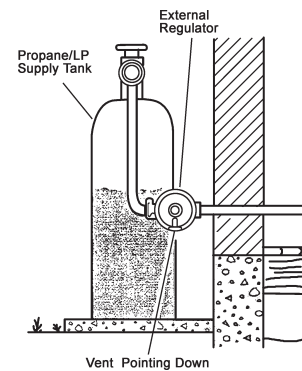

Figure 13 - External Regulator with Vent Pointing Down

INSTALLATION

Continued

CAUTION: Two gas line installations at the same time are prohibited. The access plate to the simple switching means shall not be opened while the heater is in operation.

This appliance can be used with propane or natural gas. It is shipped from the factory adjusted for use with propane. Only a qualified installer or service technician can perform gas selection and connecting to gas supply.

CAUTION: To avoid gas leakage at the inlet of regulator, a qualified installer or service technician must use steel or metal hex plug with sealant.

WARNING: Do not attempt to access or change the setting of the fuel selection means

Access to and adjustment of the fuel selection means must only be performed by a qualified service person when connecting this appliance to a specified fuel supply at the time of installation.

Change of the selector setting to other than the fuel type specified at the time of installation could damage this appliance and render it inoperable.

The installer shall replace the access cover before completing the installation and operating this appliance.

For changing from propane to natural gas supply:

1. Remove top screw from cover plate, See Figure 14, and rotate to expose fuel selection device.
2. For NATURAL GAS, press knob using a flat screwdriver with a blade with thickness of a quarter and turn knob clockwise  until the knob locks into the NG position (see Figure 15). Fuel selection device must be locked in the NG position. Do not operate heater between locked positions!
3. Rotate and close cover over fuel selection device and reinstall screw.
4. Remove steel or metal hex plug (with wrench provided) from natural gas inlet of regulator and install into LP inlet of regulator; use thread sealant to ensure that there are no leaks.

For changing from natural gas supply to propane supply:

1. Remove top screw from cover plate, See Figure 14, and rotate to expose fuel selection device.
2. For propane gas, press in knob using a flat screwdriver with a blade the thickness of a quarter and turn knob counterclockwise  until the knob locks into the LP position, see Figure 16. Fuel selection device must be locked in the LP position. Do not operate heater between locked positions.
3. Rotate and close cover over fuel selection device and reinstall screw.
4. Remove steel or metal hex plug from liquid propane inlet of regulator and install into NG inlet of regulator; use thread sealant to assure there are no leaks.

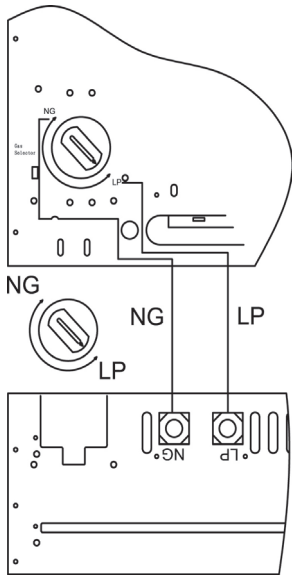

Figure 14

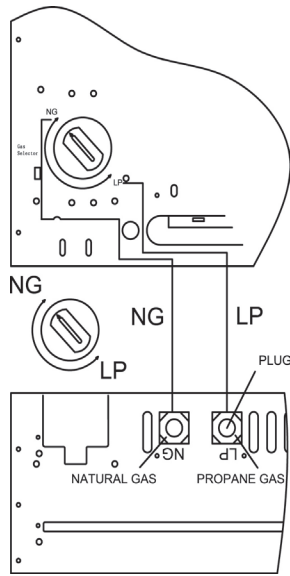

Figure 15

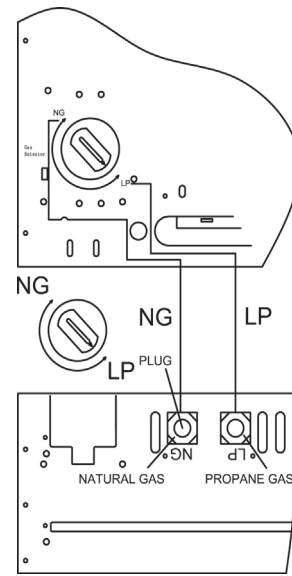

Figure 16

CHECKING GAS CONNECTIONS

WARNING: Test all gas piping and connections for leaks after installing or servicing. Correct all leaks at once.

WARNING: Never use an open flame to check for a leak. Apply a mixture of liquid soap and water to all joints. If bubbles form, there is a leak. Correct all leaks at once.

PRESSURE TESTING GAS SUPPLY PIPING SYSTEM

Test Pressures In Excess Of 1/2 PSIG (3.5kPa)

1. Disconnect heater with its appliance main gas valve (control valve) and equipment shutoff valve from gas supply piping system. Pressures in excess of 1/2 PSIG will damage heater regulator.
2. Cap off open end of gas pipe where equipment shutoff valve was connected.
3. Pressurize supply piping system by either using compressed air or opening gas supply valve.
4. Check all joints of gas supply piping system. Apply mixture of liquid soap and water to gas joints. If bubbles form, there may be a leak.
5. Correct all leaks at once.
6. Reconnect heater and equipment shutoff valve to gas supply. Check reconnected fittings for leaks.

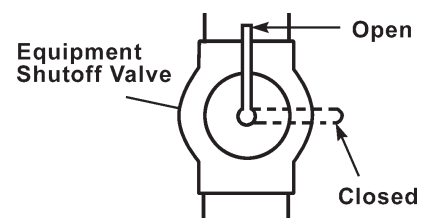

Figure 17 - Equipment Shutoff Valve

Test Pressures Equal To or Less Than 1/2 PSIG (3.5 kPa)

1. Close equipment shutoff valve (see Figure 17).
2. Pressurize supply piping system by either using compressed air or opening natural supply tank valve.
3. Check all joints from gas meter to equipment shutoff valve (see Figure 18).
Apply mixture of liquid soap and water to gas joints. If bubbles form, there is a leak.
4. Correct all leaks at once.

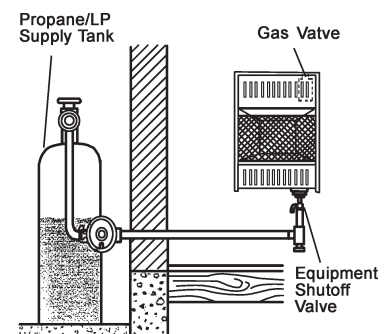

Figure 18 - Fuel Supply

Pressure Testing Heater Gas Connections

1. Open equipment shutoff valve (see Figure 17).
2. Open gas supply tank valve.
3. Make sure control knob of heater is in the OFF position.
4. Remove front panel.
5. Check all joints from equipment shutoff valve to control valve (see Figure 17). Apply mixture of liquid soap and water to gas joints. If bubbles form, there may be a leak.
6. Correct all leaks at once.
7. Light heater (see *Lighting Instructions on page 19*). Check all other internal joints for leaks.
8. Turn off heater (see "To Turn Off Gas Appliance" on page 18).
9. Replace lower front panel.

OPERATION

FOR YOUR SAFETY READ BEFORE LIGHTING



WARNING: If you do not follow these instructions exactly, a fire or explosion may result causing property damage, personal injury or loss of life.

- A. When lighting the pilot, follow these instructions exactly.
- B. BEFORE LIGHTING, smell all around the appliance area for gas. Be sure to smell next to the floor because some gas is heavier than air and will settle on the floor.
- C. Use only your hand to push in or turn the gas control knob. Never use tools. If the knob will not push in or turn by hand, don't try to repair it, call a qualified service technician or gas supplier. Forced or attempted repair may result in a fire or explosion.
- D. Do not use this appliance if any part has been under water. Immediately call a qualified service technician to inspect the appliance and to replace any part of the control system and any gas control which has been under water.

WHAT TO DO IF YOU SMELL GAS

- Do not try to light any appliance.
- Do not touch any electric switch, do not use any phone in your building.
- Immediately call your gas supplier from a neighbor's phone. Follow the gas supplier's instructions.
- If you cannot reach your gas supplier, call the fire department.

LIGHTING INSTRUCTIONS

1. STOP! Read the safety information on the side of the heater.
2. Make sure equipment shutoff valve is fully open.
3. Turn control knob clockwise ↻ to the OFF position.
4. Wait five (5) minutes to clear out any gas. Then smell for gas, including near the floor. If you smell gas, STOP! Do not try to light any appliance. Do not touch electrical switch or use any phone in the building. Immediately contact gas supplier from a neighbor's phone. Follow gas supplier's instructions. If you can't reach the gas supplier, call the fire dept. If you don't smell gas, go to the next step.
5. Turn control knob counterclockwise ↺ to the PILOT position. Press in control knob for five (5) seconds (see Figure 19).

Note: The first time that the heater is operated after connecting the gas supply, the control knob should be depressed for about thirty (30) seconds. This will allow air to bleed from the gas system. If pilot does not stay lit, refer to *Troubleshooting*, pages 23 through 24. Also contact a qualified service technician or gas supplier for repairs. Until repairs are made, light pilot with match.

- If control knob does not pop up when released, contact a qualified service technician or gas supplier for repairs.
6. With control knob pressed in, push down and release ignitor button. This will light pilot. The pilot is attached to the front of burner. The pilot can be seen through the grill. If needed, keep pressing ignitor button until pilot lights.
Note: If pilot does not stay lit, refer to *Troubleshooting*, pages 23 through 24. Also contact a qualified service technician or gas supplier for repairs. Until repairs are made, light pilot with match. To light pilot with match, see "Manual Lighting Procedure".
 7. Keep control knob pressed in for 30 seconds after lighting pilot. After 30 seconds, release control knob. If control knob does not pop up when released, contact a qualified service technician or gas supplier for repairs.
Note: If pilot goes out, repeat steps 3 through 7. This heater has a safety interlock system. Wait one (1) minute before lighting pilot again.
 8. Turn control knob counterclockwise ↺ to desired heating level. The main burner should light. Set control knob to any heat level between 1 and 5.

CAUTION: Do not try to adjust heating levels by using the equipment shutoff valve.

THERMOSTAT CONTROL OPERATION

The thermostatic control used on this model differs from standard thermostats.

Standard thermostats simply turn the burner on and off. The thermostat used on this heater senses the room temperature. At times the room may exceed the set temperature. If so, the burner will shut off. The burner will cycle back on when room temperature drops below the set temperature.

The control knob can be set to any comfort level between 1 and 5.

TO TURN OFF GAS TO APPLIANCE

Shutting Off Heater

Turn control knob clockwise ↻ to the OFF position.

Shutting Off Burner Only (pilot stays lit)

Turn control knob clockwise ↻ to the PILOT position.

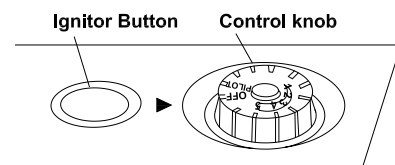

Figure 19 - Control Knob in the OFF Position

INSPECTING BURNER

Check pilot flame pattern and burner flame pattern often.

PILOT FLAME PATTERN

Figure 20 shows a correct pilot flame pattern. Figure 21 shows a incorrect pilot flame pattern. The incorrect pilot flame is not touching the thermocouple. This will cause the thermocouple to cool, which shuts the heater off. If pilot flame pattern is incorrect:

- turn heater off (see “To Turn Off Gas to Appliance” on page 17)
- see *Troubleshooting* pages 20 through 22.

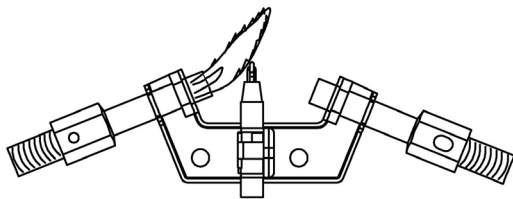

Figure 20 - Correct Pilot Flame Pattern

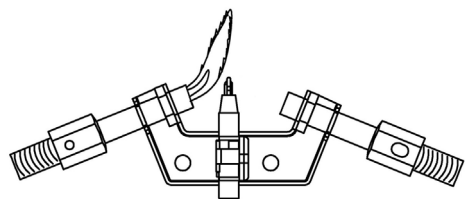

Figure 21 - Incorrect Pilot Flame Pattern

⚠ WARNING: If yellow tipping occurs, your heater could produce increased levels of carbon monoxide. If burner flame pattern shows yellow tipping, follow instructions at bottom of this page.

Notice: Do not mistake orange flames with yellow tipping. Dirt or other fine particles enter the heater and burn causing brief patches of orange flame.

BURNER FLAME PATTERN

Figure 22 shows a correct burner flame pattern. Figure 23 shows an incorrect burner flame pattern. If burner flame pattern is incorrect then:

- turn heater off (see “To Turn Off Gas to Appliance” on page 17).
- see *Troubleshooting*, pages 20 through 22.

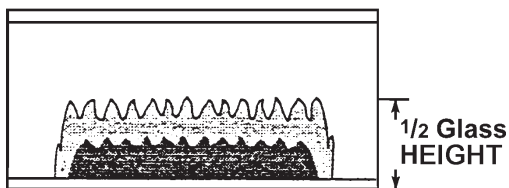

Figure 22 - Correct Burner Flame Pattern

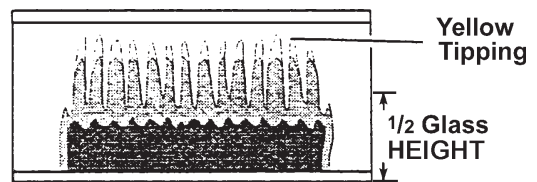

Figure 23 - Incorrect Burner Flame Pattern

CARE AND MAINTENANCE

⚠ WARNING: Turn off heater and let cool before servicing or cleaning.

⚠ CAUTION: You must keep control areas, burner, and circulating air passageways of heater clean. Inspect these areas of heater before each use. Have heater inspected yearly by a qualified service technician. Heater may need more frequent cleaning due to excessive lint from carpeting, bedding material, pet hair, etc.

ODS/PILOT AND BURNER

- Use a vacuum cleaner, pressurized air, or a small, soft bristled brush to clean.

CLEANING BURNER PILOT AIR INLET HOLE

We recommend that you clean the unit every 2,500 hours of operation or every three months. We also recommend that you keep the burner tube and pilot assembly clean and free of dust and dirt. To clean these parts we recommend using compressed air no greater than 30 PSI. Your local computer store, hardware store, or home center may carry compressed air in a can. You can use a vacuum cleaner in the blow position. If using compressed air in a can, please follow the directions on the can. If you don't follow directions on the can, you could damage the pilot assembly.

1. Shut off the unit, including the pilot. Allow the unit to cool for at least thirty minutes.
2. Inspect burner and pilot for dust and dirt.
3. Blow air through the ports/slots and holes in the burner. Also clean the pilot assembly. A yellow tip on the pilot flame indicates dust and dirt in the pilot assembly. There is a small pilot air inlet hole about two inches from where the pilot flame comes out of the pilot assembly (see Figure 24). With the unit off, lightly blow air through the air inlet hole. You may blow through a drinking straw if compressed air is not available.

CABINET

Air Passageways

- Use a vacuum cleaner or pressurized air to clean.

Exterior

- Use a soft cloth dampened with a mild soap and water mixture.
- Wipe the cabinet to remove dust.

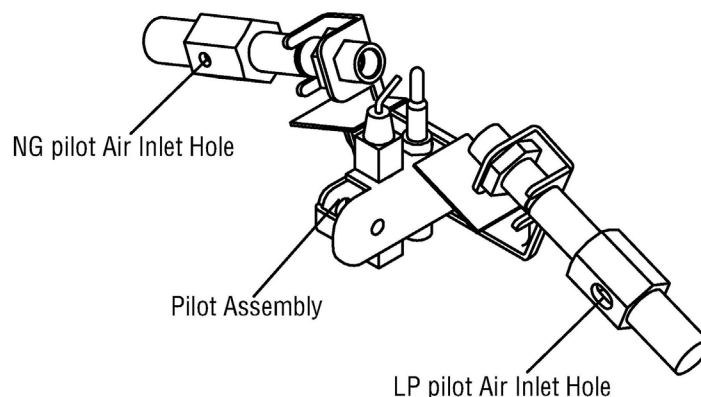

Figure 24 - Pilot Inlet Air Hole

TROUBLESHOOTING



WARNING: If you smell gas:

- Shut off gas supply.
- Do not try to light any appliance.
- Do not touch any electrical switch; do not use any phone in your building.
- Immediately call your gas supplier from a neighbor's phone. Follow the gas supplier's instructions.
- If you cannot reach your gas supplier, call the fire department.



IMPORTANT: Operating heater where impurities in air exist may create odors. Cleaning supplies, paint, paint remover, cigarette smoke, cements and glues, new carpet or textiles, etc., create fumes. These fumes may mix with combustion air and create odors.



WARNING: Only a qualified service technician should service and repair heater.



CAUTION: Never use a wire, needle, or similar object to clean ODS/pilot. This can damage ODS/ pilot unit.

Note: All troubleshooting items are listed in order of operation.

Problem	Possible Cause	Corrective Action
When ignitor button is pressed in, there is no spark at ODS/pilot	<ol style="list-style-type: none"> 1. Ignitor electrode is positioned wrong. Ignitor electrode is broken. 2. Ignitor electrode is not connected to ignitor cable. 3. Ignitor cable is pinched or wet. 4. Broken ignitor cable. 5. Bad piezo ignitor. 	<ol style="list-style-type: none"> 1. Replace electrode. 2. Replace ignitor cable 3. Free ignitor cable if pinched by any metal or tubing. Keep ignitor cable dry. 4. Replace ignitor cable. 5. Replace piezo ignitor.
When ignitor button is pressed in there is a spark at ODS/pilot but no ignition.	<ol style="list-style-type: none"> 1. Gas supply is turned off or equipment shutoff valve is closed. 2. Control knob not fully pressed in while pressing ignitor button. 3. Air in gas lines when installed. 4. ODS / pilot is clogged. 5. Gas regulator setting is not correct. 6. Control knob not in PILOT position. 7. Depleted gas supply (propane). 	<ol style="list-style-type: none"> 1. Turn on gas supply or open equipment shutoff valve. 2. Fully press in control knob while pressing ignitor button. 3. Continue holding down control knob. Repeat igniting operation until air is removed. 4. Clean ODS/pilot (see <i>Care and Maintenance</i>, page 19) or replace ODS/pilot assembly. 5. Replace gas regulator. 6. Turn control knob to PILOT position. 7. Contact local propane/LP gas company.

Problem	Possible Cause	Corrective Action
ODS/pilot lights but flame goes out when control knob is released.	<ol style="list-style-type: none"> 1. Control knob is not fully pressed in. 2. Control knob is not pressed in long enough. 3. Equipment shutoff valve is not fully open. 4. Thermocouple connection is loose. 5. Thermocouple damaged. 6. Control valve damaged. 	<ol style="list-style-type: none"> 1. Press in control knob fully. 2. After ODS/pilot lights, keep control knob pressed in 30 seconds. 3. Fully open equipment shutoff valve. 4. Hand tighten until snug, and then tighten ¼ turn more. 5. Replace thermocouple. 6. Contact customer service.
Burner(s) does not light after ODS/pilot is lit.	<ol style="list-style-type: none"> 1. Burner orifice is clogged. 2. Burner orifice diameter is too small. 3. Inlet gas pressure is too low. 	<ol style="list-style-type: none"> 1. Clean burner orifice (see <i>Care and Maintenance</i>, page 19). 2. Contact customer service. 3. Contact your gas supplier.
Delayed ignition of burner(s).	<ol style="list-style-type: none"> 1. Manifold pressure is too low. 2. Burner orifice is clogged. 	<ol style="list-style-type: none"> 1. Contact your gas supplier. 2. Clean burner (see <i>Care and Maintenance</i>, page 19).
Burner backfiring during combustion.	<ol style="list-style-type: none"> 1. Burner orifice is clogged or damaged. 2. Burner is damaged. 3. Gas regulator is damaged. 	<ol style="list-style-type: none"> 1. Clean burner orifice (see <i>Care and Maintenance</i>, page 19). 2. Contact dealer or customer service. 3. Replace gas regulator.
High yellow flame during burner combustion.	<ol style="list-style-type: none"> 1. Not enough air. 2. Gas regulator is defective. 3. Inlet gas pressure is too low. 	<ol style="list-style-type: none"> 1. Check burner for dirt and debris. If found, clean burner (see <i>Care and Maintenance</i>, page 19). 2. Replace gas regulator. 3. Contact your gas supplier.
Gas odor during combustion.	<ol style="list-style-type: none"> 1. Foreign matter between control valve and burner. 2. Gas leak. (See Warning Statement at top of page 20). 	<ol style="list-style-type: none"> 1. Take apart gas tubing and remove foreign matter. 2. Locate and correct all leaks (see "Checking Gas Connections," page 13).

Problem	Possible Cause	Corrective Action
Slight smoke or odor during initial operation	1. Residues from manufacturing process.	1. Problem will stop after a few hours of operation.
Heater produces a whistling noise when burner is lit.	1. Turning control knob to high (5) position when burner is cold. 2. Air in gas line. 3. Air passageways on heater are blocked. 4. Dirty or partially clogged burner orifice.	1. Turn control knob to low (1) position and let warm up for a minute. 2. Operate burner until air is removed from line. Have gas line checked by local gas company. 3. Observe minimum installation clearances (Fig. 4, page 10) 4. Clean burner (see <i>Care and Maintenance</i> , page 19).
Heater produces a clicking/ticking noise just after burner is lit or shut off.	1. Metal is expanding while heating or contracting while cooling.	1. This is common with most heaters. If noise is excessive, contact qualified service technician.
White powder residue forming within burner box or on adjacent walls or furniture.	1. When heated, the vapors from furniture polish, wax, carpet cleaners, etc., turn into white powder residue.	1. Turn heater off when using furniture polish, wax, carpet cleaner or similar products.
Heater produces unwanted odors.	1. Heater is burning vapors from paint, hair spray, glues, etc. See IMPORTANT statement, page 20. 2. Gas leak. See Warning Statement at the top of page 20. 3. Low fuel supply.	1. Ventilate room. Stop using odor causing products while heater is running. 2. Locate and correct all leaks (see "Checking Gas Connections," page 13). 3. Refill supply tank (Propane /LP models).
Heater shuts off in use (ODS operates).	1. Not enough fresh air is available. 2. Low line pressure. 3. ODS/pilot is partially clogged.	1. Open window and/or door for ventilation. 2. Contact local gas supplier. 3. Clean ODS/pilot (see <i>Care and Maintenance</i> , page 19).
Gas odor exists even when control knob is in OFF position.	1. Gas leak. See Warning Statement at top of page 20. 2. Control valve is defective.	1. Locate and correct all leaks (see "Checking Gas Connections", page 13). 2. Contact customer service.
Moisture/condensation noticed on windows.	1. Not enough combustion/ventilation air.	1. Refer to "Air for Combustion and Ventilation" requirements, page 7.

REPLACEMENT PARTS

NOTE: Use only original replacement parts. This will protect your warranty coverage for parts replaced under warranty.

PARTS UNDER WARRANTY

Contact authorized dealers of this product. If they can't supply original replacement parts, call Customer Service at 909-825-0993 for referral information.

When calling Customer Service or your dealer, have ready:

- Your name
- Your address
- Model and serial number of your heater
- How heater was malfunctioning
- Type of gas used (Propane/LP or Natural gas/NG)
- Purchase date
- Usually, we will ask you to return the defective part to the factory

PARTS NOT UNDER WARRANTY

Contact authorized dealers of this product. If they can't supply original replacement part(s) call Customer Service at 909-825-0993 for referral information.

When calling Customer Service have ready:

- Model number of your heater
- The replacement part number

ACCESSORIES

Purchase these heater accessories from your local dealer. If they can not supply these accessories, contact Williams Furnace for information.

EQUIPMENT SHUTOFF VALVE

For all models. Equipment shutoff valve with 1/8 in. NPT tap. (see figure 1)

Optional FAN Kit - 2295

The optional fan kit has 3 settings ON/OFF/Auto. (see figure 2).

FLOOR MOUNTING STAND

For locating heater on the floor, away from a wall. Complete installation instructions provided with floor mounting stand. (see figure 3)

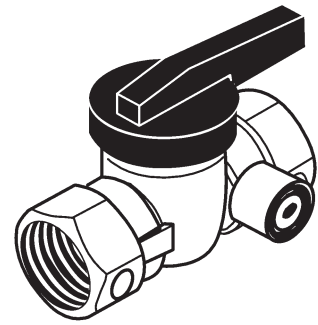

figure 1

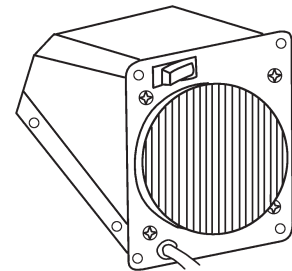

figure 2

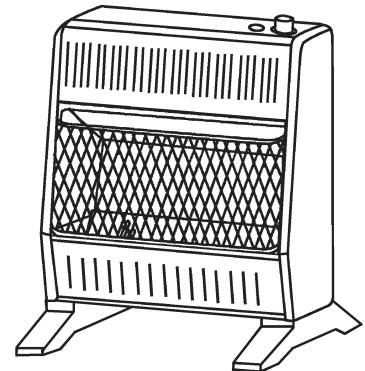

figure 3

PARTS LIST (1096513.9)

This list contains replaceable parts for your heater. When ordering replacement parts, follow the instructions listed under *Replacement Parts* on page 24 of this manual.

PART	PART #	DESCRIPTION	QTY
1	MB10053D	Cabinet Assembly	1
2	MB11005	Reflector Unite	1
3	ML087-03	Upper Glass Retainer	1
4	ML086-03	Glass	1
5	ML088-03	Lower Glass Retainer	1
6	ML084-03	Middle Panel	1
7	MB09003	Lower Front Panel Assembly	1
8	MB29003	Grill Guard	1
9	ML103-03D	Left Regulator Mounting	1
10	RV83FI-4/9	Pressure Regulator Assembly	1
10--1	PF120820	Plug	2
11	MB40003D	Main Inlet Tube Assembly	1
12	MB40013D	Burner Inlet Tube Assembly	1
13	DPL027-01	PIPE OUTLET NUT	1
14	MB40023D	To ODS Line Assembly	1
15-1	MB40023DN	To ODS Line Assembly	1
15-2	MB40023DL	To ODS Line Assembly	1
16	NDD0308-800-1	ODS	1
17	NBD-10	Burner Assembly	1
18	LHY-MD100TBA-B	Fuel Selection Device Assembly	1
19	ML029-01	Fuel Selection Device Fixed Nut	1
20	MDL304B	Fuel Selection Device Knob	1
21	ML104-03D	Bracket	1
22	ML083-03	Ignitor Assembly	1
23	SIT545-130-B	Thermostat Valve Assembly	1
24	ML111-02A	Bracket	1
25	MB060-02	Mounting Bracket	1
26	FB28D157-B	ODS Deflector	1
	MB28001D	Hardware Bag Assembly	1
	ML070-03D	CSA Label	1
	ML065-01	Thermostate Sensing Bulb Clip	1
	ML072-01	Inside Warning Label	1

ILLUSTRATED PARTS

1096513.9

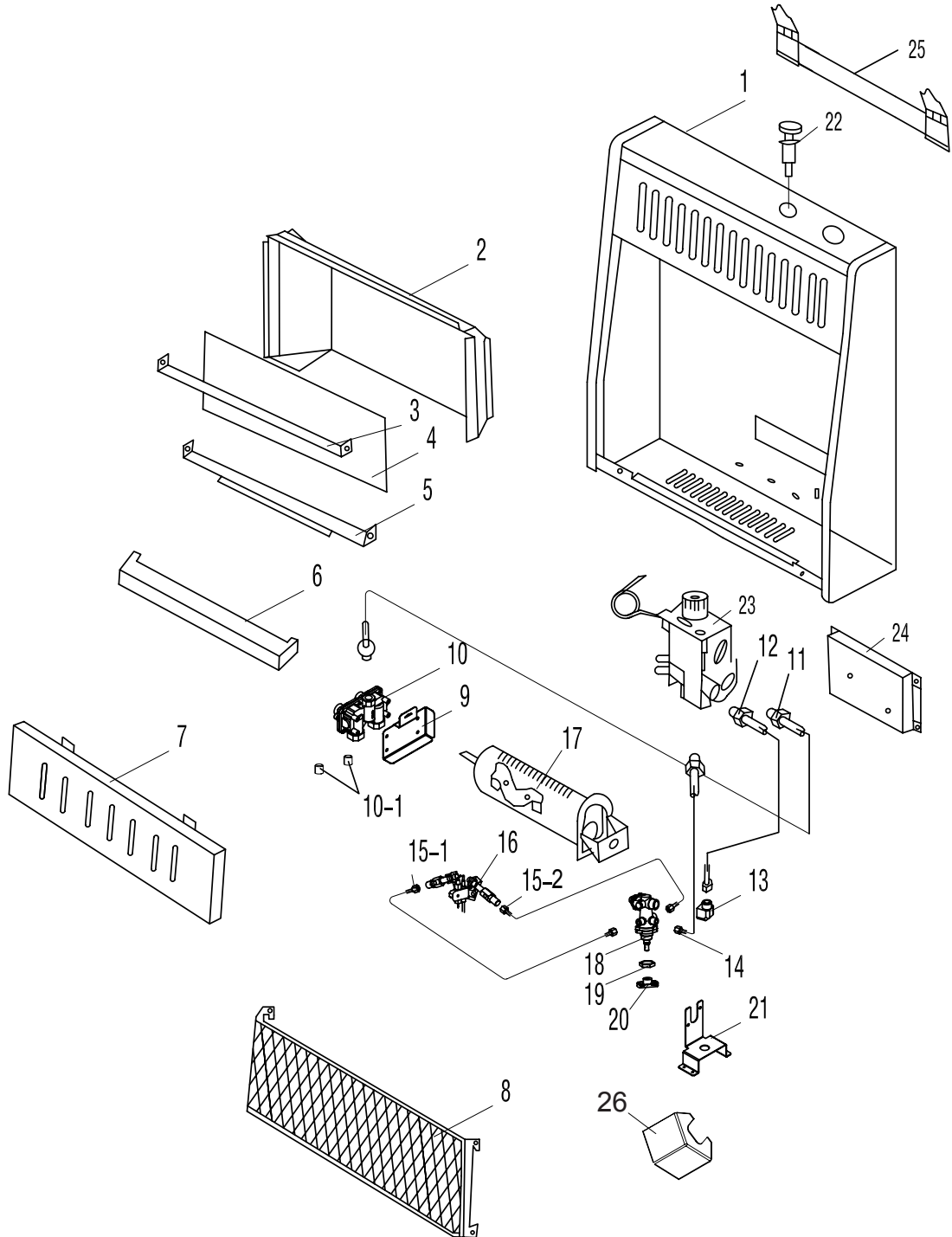

PARTS LIST (2096513.9 & 3096513.9)

This list contains replaceable parts for your heater. When ordering replacement parts, follow the instructions listed under *Replacement Parts* on page 24 of this manual.

PART	2096513.9 PART #	3096513.9 PART #	DESCRIPTION	QTY
1	MB10052D	MB10054D	Cabinet Assembly	1
2	MB11004	MB11052	Reflector Unite	1
3	ML087-02	ML087-01	Upper Glass Retainer	1
4	ML086-02	ML086-01	Glass	1
5	ML088-02	ML088-01	Lower Glass Retainer	1
6	ML157-02	ML157-01	Middle Panel	1
7	MB09002	MB09051	Lower Front Panel Assembly	1
8	MB29002	MB29001	Grill Guard	1
9	MML231-01	MML231-01	Strengthen Plate	1
10	RV83FI-4/9	RV83FI-4/9	Pressure Regulator Assembly	1
10--1	PF120820	PF120820	Plug	2
11	MB40002D	MB40004D	Main Inlet Tube Assembly	1
12	MB40012D	MB40014D	Burner Inlet Tube Assembly	1
13	MB40022D	MB40024D	To ODS Line Assembly	1
14--1	MB40022DN	MB40024DN	To ODS Line Assembly	1
14--2	MB40022DL	MB40024DL	To ODS Line Assembly	1
15	NDD0308-800-1	NDD0308-800-1	ODS	1
16	NBD-20	NBD-30B	Burner Assembly	1
17	LHY-MD200TBA-B	LHY-MD300TBA-B	Fuel Selection Device Assembly	1
18	ML029-01	ML029-01	Fuel Selection Device Fixed Nut	1
19	MDL304B	MDL304B	Fuel Selection Device Knob	1
20	ML104-01D	ML104-01D	Bracket	1
21	ML103-01	ML103-01	Left Regulator Mounting	1
22	ML083-03	ML083-03	Ignitor Assembly	1
23	SIT545-200-B	SIT545-250-B	Thermostat Valve Assembly	1
24	ML111-01A	ML111-01A	Bracket	1
25	MB060-01	MB060-01	Mounting Bracket	1
26	ML105-03D	ML105-03D	ODS Deflector	1
	MB28001D	MB28001D	Hardware Bag Assembly	1
	ML070-02D	ML070-04D	CSA Label	1
	ML072-01	ML072-01	Inside Warning Label	1
	ML065-01	ML065-01	Thermostat Sensing Bulb Clip	1

ILLUSTRATED PARTS

2096513.9 & 3096513.9

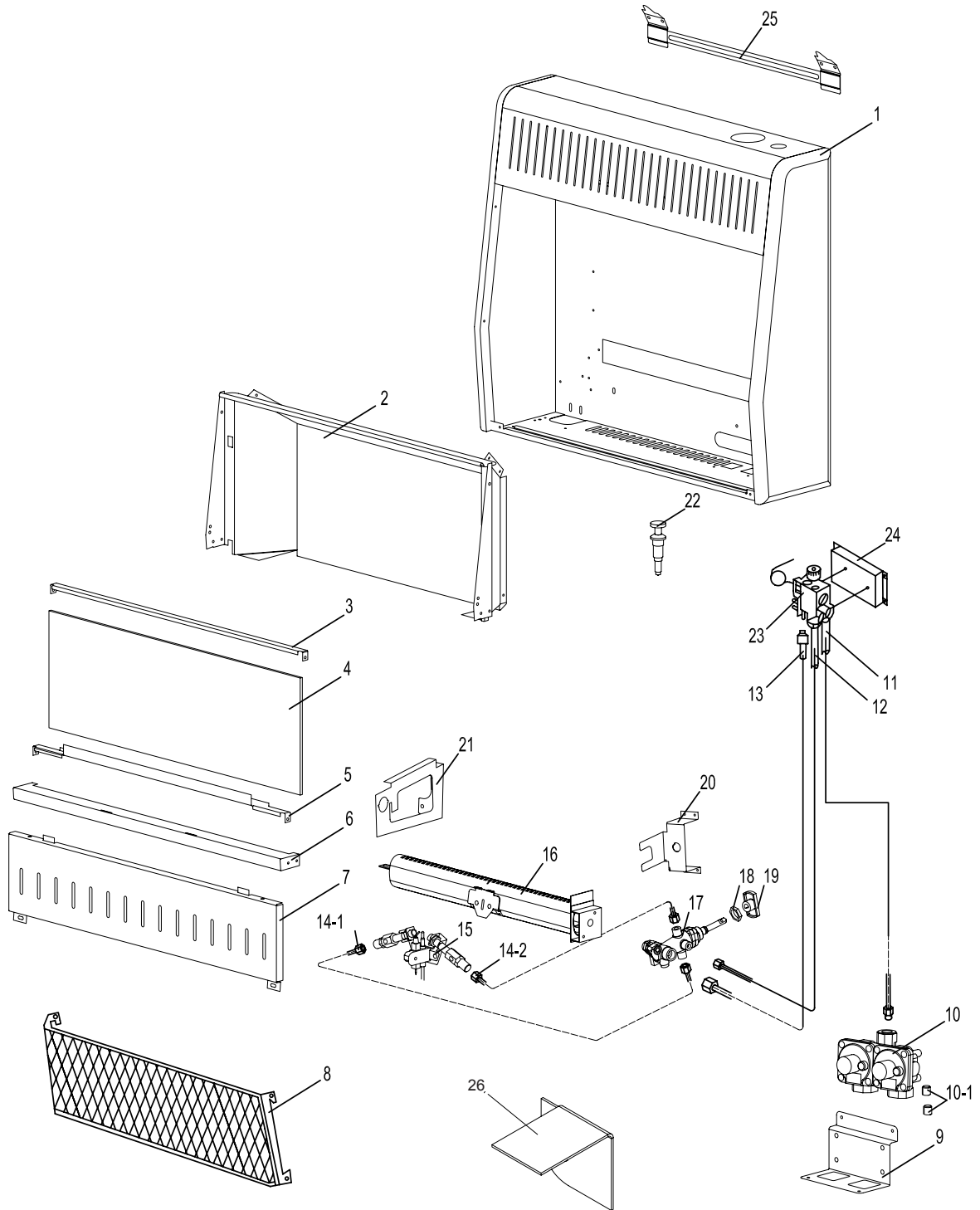

WARRANTY INFORMATION

Keep This Warranty

IMPORTANT: We urge you to fill your warranty registration card within TEN(10) days of date of installation, complete with the entire serial number which can be found on the rating plate. Retain this portion of the card for your record. Always specify model and serial numbers when communicating with customer service.

We reserve the right to amend these specifications at any time without notice. The only warranty applicable is our standard written warranty. We make no other warranty, expressed or implied.

LIMITED WARRANTY:

Williams Furnace Co. warrants this product to be free from defects in materials and components for ONE (1) year from the date of first purchase, provided that the product has been properly installed, operated and maintained in accordance with all applicable instructions, to make a claim under this warranty, the Bill of Sale or cancelled check must be presented.

RESPONSIBILITY OF OWNER

This warranty is extended only to the original retail purchaser. This warranty covers the cost of part(s) required to restore this heater to proper operating condition. Warranty part(s) MUST be obtained through authorized dealers of this product and/or Williams Furnace Co. who will provide original factory replacement parts. Failure to use original factory replacement parts voids this warranty. The heater MUST be installed by a qualified installer in accordance with all local codes and instructions furnished with the unit.

WHAT IS NOT COVERED

This warranty does not apply to parts that are not in original condition because of normal wear and tear or parts that fail or become damaged as a result of misuse, accidents, lack of proper maintenance or defects caused by improper installation. Travel, diagnostic cost, labor, transportation and any and all such other costs related to repairing a defective heater will be the responsibility of the owner.

TO THE FULL EXTENT ALLOWED BY THE LAW OF THE JURISDICTION THAT GOVERNS THE SALE OF THE PRODUCT, THIS EXPRESS WARRANTY EXCLUDES ANY AND ALL OTHER EXPRESSED WARRANTIES AND LIMITS THE DURATION OF ANY AND ALL IMPLIED WARRANTIES. INCLUDING WARRANTIES OF MERCHANTABILITY AND FITNESS FOR A PARTICULAR PURPOSE TO ONE (1) YEAR ON ALL COMPONENTS FROM THE DATE OF FIRST PURCHASE. Williams Furnace Co.'s LIABILITY IS HEREBY LIMITED TO THE PURCHASE PRICE OF THE PRODUCT AND Williams Furnace Co. SHALL NOT BE LIABLE FOR ANY OTHER DAMAGES WHATSOEVER INCLUDING INDIRECT. INCIDENTAL OR CONSEQUENTIAL DAMAGES.

Some states do not allow a limitation on how long an implied warranty lasts or an exclusion or limitation of accidental or consequential damages, the above limitation on implied warranties, or exclusion or limitation on damages may not apply to you.

This warranty gives you specific legal right, and you may also have other rights that vary from state to state.

This product may be covered by one or more of the following patents: (United States) 7013886, 7434447, 7607426, 7654820, 7677236, 7730765, 7967006, 7967007, 8152515, 8235708, (Europe) 07009672, 07024044, 08004868 or other U.S. and foreign patents pending.