

ARCHOS 5



ARCHOS 7

ENGLISH USER MANUAL Version 2.0

Please visit www.archos.com/manuals to download the latest version of this manual.

Dear Customer,

Thank you for choosing this ARCHOS product. We hope that you will enjoy using it and that it will give you satisfaction for many years to come.

Please do register your product (directly on your ARCHOS via the WiFi) to ensure that you get access to our technical support as well as FREE and PURCHASABLE offers from our website and from the ARCHOS Media Club. You can also register on our website (www.archos.com/register).

Wishing you the best multimedia experience,

The ARCHOS Team.

All the information contained in this manual was correct at the time of publication. However, as we are often updating and improving our products, your device's software may have a slightly different appearance or modified functionality than presented in this manual.

TABLE OF CONTENTS

INTRODUCTION.....	4
ARCHOS DESCRIPTION	4
FIRST TIME USAGE	5
TURNING THE ARCHOS ON/OFF.....	5
THE INSTALLATION WIZARD	5
USING THE ARCHOS INTERFACE	6
PRODUCT CARE	7
1. PLAYING VIDEO	8
1.1 BROWSING THROUGH YOUR VIDEOS.....	8
1.2 VIDEO PLAYBACK	9
1.3 VIDEO PLAYER SETTINGS	11
1.4 PUTTING VIDEOS ONTO YOUR ARCHOS.....	12
1.5 PLAYING YOUR PC'S SHARED VIDEOS (UPNP)	13
1.6 WATCHING WEB TV	13
2. PLAYING MUSIC.....	15
2.1 BROWSING THROUGH YOUR MUSIC FILES	15
2.2 MUSIC PLAYBACK	17
2.3 MUSIC PLAYER SETTINGS.....	18
2.4 PLAYLISTS.....	20
2.5 PUTTING MUSIC ONTO YOUR ARCHOS	22
2.6 PLAYING YOUR PC'S SHARED MUSIC (UPNP)	23
2.7 LISTENING TO WEB RADIOS	24
3. VIEWING PHOTOS	25
3.1 BROWSING THROUGH YOUR PHOTOS	25
3.2 PHOTO VIEWER	26
3.3 PHOTO VIEWER SETTINGS.....	28
3.4 PLAYING A SLIDESHOW.....	28
3.5 PUTTING PHOTOS ONTO YOUR ARCHOS	29
3.6 PLAYING YOUR PC'S SHARED PHOTOS (UPNP).....	29
4. USING THE FILE BROWSER.....	30
4.1 NAVIGATION.....	30
4.2 USING THE VIRTUAL KEYBOARD	32
4.3 BROWSING OTHER COMPUTERS ON THE NETWORK.....	32
5. CONNECTING TO THE WIFI.....	34
5.1 WIFI CONNECTION PROCEDURE	34
5.2 WIFI NETWORK CONFIGURATION.....	35
6. THE INTERNET FEATURES.....	38
6.1 BROWSING THE WEB.....	38
6.2 PLAYING YOUR PC'S SHARED MEDIA FILES (UPNP).....	40

TABLE OF CONTENTS CONTINUED ON NEXT PAGE...

6.3 THE ARCHOS MEDIA CLUB	42
6.4 MAIL	43
6.5 CONTACTS	45
7. TRANSFERRING FILES	46
7.1 CONNECTING THE ARCHOS TO A COMPUTER	46
7.2 PUTTING FILES ONTO THE ARCHOS.	47
7.3 DISCONNECTING	47
8. MAIN SETTINGS	49
8.1 "SOUND" SETTINGS	49
8.2 "SCREEN" SETTINGS.	50
8.3 "TV OUT" SETTINGS	51
8.4 "APPEARANCE" SETTINGS	52
8.5 "LANGUAGE AND REGION" SETTINGS.	53
8.6 "TV CONTROL" SETTINGS	53
8.7 "CLOCK" SETTINGS.	53
8.8 "ALARM CLOCK" SETTINGS	55
8.9 "POWER" SETTINGS	55
8.10 "STORAGE" SETTINGS.	57
8.11 "PARENTAL CONTROL" SETTINGS	58
8.12 "SECURITY" SETTINGS	59
8.13 "CUSTOMER ASSISTANCE" SETTINGS	59
8.14 "FIRMWARE AND PLUG-INS" SETTINGS	59
8.15 UPDATING THE FIRMWARE	60
8.16 "SYSTEM INFO" SETTINGS	61
9. OTHER FUNCTIONS	62
9.1 "PLAY" MENU: OTHER FUNCTIONS	62
9.2 TV FUNCTIONS.	62
9.3 TOOLS	63
10. ARCHOS PLUG-INS AND ADD-ONS	66
10.1 ARCHOS PLUG-INS.	66
10.2 ARCHOS ADD-ONS.	66
TROUBLESHOOTING	68
RESETTING YOUR ARCHOS	68
SYSTEM RECOVERY	68
TOUCHSCREEN PROBLEMS	69
REPAIR AND FORMATTING TOOLS.	69
REPLACING THE BATTERY	70
TECHNICAL SPECIFICATIONS	71
TECHNICAL SUPPORT INFORMATION	75

INTRODUCTION



- The information presented in this manual might vary according to which ARCHOS model you have.
- Every time you see one of these icons, it means that the following section will concern this and only this model.

5

7

ARCHOS DESCRIPTION

MAIN BUTTONS

-  Press and hold to turn your ARCHOS on/off.*
- The green LED indicator lights up when the device is on.

** When you keep the Power button held down, two messages will appear, one after the other. If you release the button during the first message, your device will keep using a small amount of battery power to allow a quick start up.*

If you do not plan on using the ARCHOS for an extended period of time, keep the button held down until you see a second message appear. The device will shut down completely, and there will be absolutely no battery usage.

VOL Volume button: to increase/decrease volume.

LED INDICATORS

- CHG** Battery charge indicator
- light on: the battery is charging
 - blinking: the battery is fully charged

CONNECTORS

On the side of the device:

-  Power connector: charge the battery of your ARCHOS device (see *Charging the Battery*).
- Headphone Jack: to connect headphones.

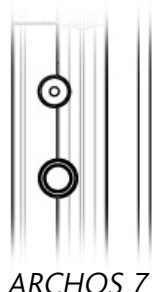

ARCHOS 7

Underneath the device: These connectors allow you to:

- Connect your ARCHOS to a computer (see *Connecting the ARCHOS to a Computer*)
-  Charge the battery of your ARCHOS (see *Charging the Battery*)
- Connect an optional add-on. See *ARCHOS add-ons*.



BUILT-IN LOUDSPEAKER

The ARCHOS is equipped with a single speaker (ARCHOS 5) or two speakers (ARCHOS 7).

LEG STAND

- Your ARCHOS is equipped with a leg stand, located on the back of the device.
- Carefully pull it out, and it will allow your ARCHOS to stand by itself on a flat, stable surface.

FIRST TIME USAGE

CHARGING THE BATTERY

Before using your ARCHOS for the first time, completely charge its battery:

5 • Connect the USB cable to the ARCHOS and to a running computer.

7 • Simply plug the ARCHOS Charger/Adapter into the power connector.

- The ARCHOS will turn on and start charging:
 - The **CHG** LED indicator is on while the battery is charging. It will blink when the battery is fully charged.
 - A lightning bolt symbol will flash over the battery icon in the upper right corner of the screen while the battery is charging.

7 Note that the ARCHOS has a removable battery. To learn how to replace it, see: *Troubleshooting*.

TURNING THE ARCHOS ON/OFF

- Press and hold the  button to turn your ARCHOS on/off. See *ARCHOS Description*.
- The green LED indicator lights up when the device is on.

THE INSTALLATION WIZARD

- The first time you turn on the ARCHOS, the installation wizard will help you configure the main functions of your ARCHOS: the language, the WiFi connection, the clock, etc.
- At the end of the wizard, you will be requested to register your product (a WiFi connection is required) so that you have access to our technical support as well as FREE and PURCHASABLE offers from our website and from the ARCHOS Media Club. Being registered will allow you, for example, to get the free 'Web Browser' and 'Web TV & Radio' plug-ins.

USING THE ARCHOS INTERFACE

INTERFACE DESCRIPTION

Status Bar

- In the top right corner of the screen, the status bar indicates the volume, the battery level, the current time of day and the WiFi connection status.

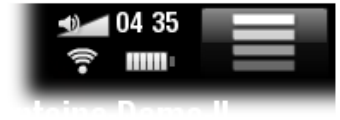

Contextual Menu

- In the upper right corner of the screen, tap on the Menu icon to display available menu items. The available options will vary, depending on where you are in the interface.
- On the Home screen, the Menu icon allows you to:
 - manage the Home screen shortcuts.
 - lock your device's touchscreen. This can be useful if your ARCHOS is in your pocket, for example, and you do not want to touch the screen by accident. To unlock the device, press the button. A confirmation screen will pop up.



Home Screen

- This is the main screen of your ARCHOS, showing its main functions.
- Choose one of the main categories, on the left side of the screen (ex: "**Play**"), then select a sub-category (ex: "**Video**").
- The right side of the Home Screen can contain up to four media items. These are considered as shortcuts.

USING THE TOUCHSCREEN



Your ARCHOS is equipped with a touchscreen. Below is a description of the main tactile screen areas and a few tips on how to use the touchscreen.

Main Touchscreen Actions

- In the different applications, you can go back one level in the interface by tapping on the Back icon (in the top right corner of the screen).
- Wherever you are in the interface, you can go back directly to the Home screen by tapping on the Home icon (in the top left corner of the screen).
- While playing a video or song, you can pause/resume it by tapping on the Pause / Play icon.

Other Touchscreen Actions



- When watching a video or listening to music, you can tap on the progression bar to go directly to a different location in the video or song. You can also use your finger to drag the cursor in the progression bar to another location in the video or song.
 - In the screens where it appears, the volume bar can be dragged in the same way.
 - In the different browsers (File, Music, Video, Photo, etc.), you can drag the scroll bar up and down to scroll the file list up and down. You can also scroll faster by tapping above or below the cursor in the scroll bar.
-
- In the Web browser or the PDF viewer, you can scroll up and down by tapping on the page and dragging it up or down (be careful however not to tap on a link!).

PRODUCT CARE

Your ARCHOS is an electronic product that needs to be treated with care:



- Do not subject it to shock or vibration.
- Do not subject it to heat, keep it ventilated (especially when connected to a computer).
- Keep it away from water and excessively humid areas.
- Keep it away from high electromagnetic fields.
- Do not open it up. There are no user-serviceable parts inside. Opening will void your warranty.

1. PLAYING VIDEO



In the Home screen, tap on “**Play**”, then choose the “**Video**” icon to enter the Video mode.

1.1 BROWSING THROUGH YOUR VIDEOS

- The “**Video**” browser allows you to navigate through the **Video** folder of the ARCHOS hard drive.
- You can go back one level in the interface by tapping on the Back icon . Wherever you are in the interface, you can go back directly to the Home screen by tapping on the Home icon .

THE VIDEO BROWSER

- The first screen of the Video mode shows you all the videos and subfolders located in the **Video** folder.
- The “**Resume**” line allows you to resume the last-played video file, if it was interrupted before the end. If the “**Resume**” line does not appear, it means that no video file playback can be resumed.
- To play a video, highlight it, then open it. If a video is in a subfolder of the **Video** folder, open the subfolder, and you will see it.

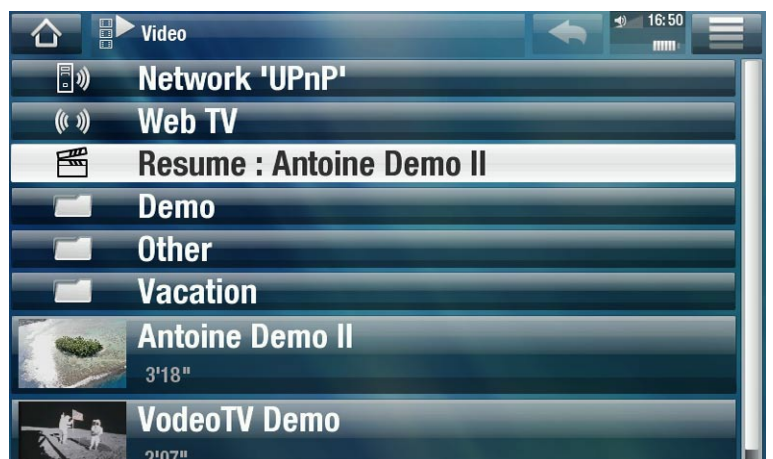

In the “Video” browser, each video file appears with a thumbnail, displayed on the left of the file’s name.



VIDEO BROWSER MENU ITEMS

“Info”

- displays a message box with information about the highlighted video file.

“File Management”

- **“Rename”**: allows you to change the name of the highlighted video file using the virtual keyboard. See: *Using the Virtual Keyboard*.
- **“Delete”**: allows you to delete the highlighted video file. A confirmation screen will pop up.
- **“Permissions”**: allows you to define the file/folder as adult content, so that other users can't see it. To use this, your **“Parental Mode”** needs to be set to **“Adult (unrestricted access)”**. See *Parental Control Settings*.

“Create Home Shortcut”

- Creates a shortcut to this video on the Home screen.

“Bookmark”

- **“Resume”**: will resume playing the highlighted video from the bookmark.
- **“Clear”**: will remove the bookmark from the highlighted video file.

“Bookmark” only appears in the menu when a bookmarked video file is highlighted. See Video Playback Menu Items to set a bookmark on a given video.

“Search”

- Allows you to search for a particular video by entering a few letters or a word. See: *Using the Virtual Keyboard*.

“Settings”

- you can choose to display the Video Player settings screen (see: *Video Player Settings*) or the **“Sound”** settings screen (see: *“Sound” Settings*).

1.2 VIDEO PLAYBACK

To play a video, highlight the file and open it.





VIDEO PLAYBACK SCREEN

1. Menu icon
2. Back icon
3. Video file name
4. Home icon
5. Play / Pause icon
6. Video progression bar
7. Volume level





VIDEO PLAYBACK TOUCHSCREEN CONTROLS

- To pause/resume the video, tap on the Pause  / Play  icon (see n° 5 in the previous screen).
- To display the menu overlay, tap once anywhere on the screen. To make it disappear, tap again.
- You can tap on the progression bar to go directly to a different location in the video. You can also use your finger to drag the cursor in the progression bar to another location in the video (see n° 6).
- The volume bar can be dragged in the same way (see n° 7).
- To display the available menu items, tap on the menu icon  (see n° 1).
- To stop the video and go back to the “Video” browser, tap on the Back icon  (see n° 2). To exit the Video mode and go back directly to the Home screen, tap on the Home icon  (see n° 4).



VIDEO PLAYBACK MENU ITEMS

“Info”

- displays a message box with information about the current video file.

“Soundtrack” and/or “Subtitles”

- allows you to select a different audio track*.
- allows you to choose subtitles**.

* Only if the video file contains several audio tracks.

** Only if the subtitles are in a separate file. The supported file types are: .srt, .ssa, .sub (text based) and .smi.

“Format”

- allows you to change the way the image is displayed.
- “**Auto**”: adjusts the video size to best adapt to the built-in screen (or TV, with the optional DVR Station, Mini Dock or Battery Dock: see ARCHOS add-ons).
- “**Full Screen**”: enlarges the picture to fill the screen. In order to fit the ARCHOS screen, your device might need to cut small parts of the image, most likely at the top and bottom.
- “**Maximized**”: enlarges the picture to fill the screen, assuming the image has an aspect ratio of 2.35 with black bands at the top and bottom.
- “**Original**”: displays the entire picture in its original format.

“Speed”

- will play the current video in slow motion or high speed.
- while paused in slow motion, you can advance frame by frame, using the right arrow.

“Set”

- **“Bookmark”**: sets a bookmark at the current spot in the video. Only one bookmark per file is allowed. You can bookmark up to 32 files. Bookmarked videos will appear in the **“Video”** browser, with a bookmark symbol  and a progression bar.
- to resume playing a video from a bookmark, go to the **“Video”** browser and highlight the bookmarked video file. Select the **“Bookmark”** menu item, then choose **“Resume”** (**“Clear”** will remove the bookmark from the video).
- **“Thumbnail”**: saves the current image as a new thumbnail image in the **“Video”** browser.
- **“Wallpaper”**: the current image will be defined as your device’s background image.

“Settings”

- you can choose to display the Video Player settings screen (see: *Video Player Settings*) or the **“Sound”** settings screen (see: *“Sound” Settings*).

1.3 VIDEO PLAYER SETTINGS

- In the Video mode, you can access the Video Player settings screen by using the **“Settings”** menu item.
- Use the left/right arrows to select a different setting for a parameter.

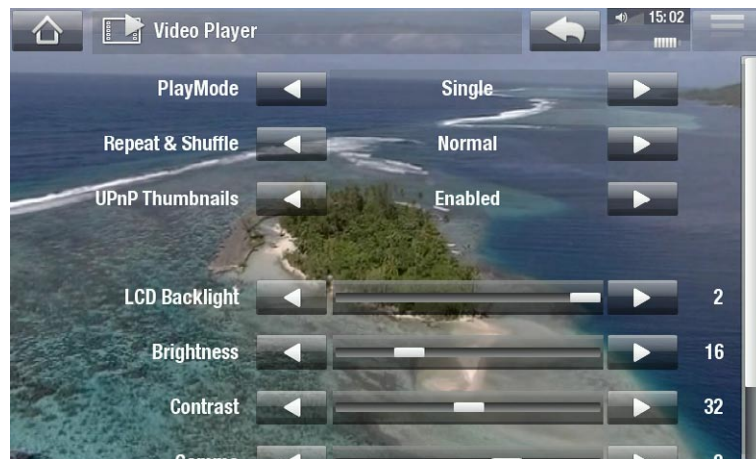

“PlayMode”, “Repeat & Shuffle”

- the following table explains how the video player will work according to the settings you chose in **“PlayMode”** AND **“Repeat & Shuffle”**.

“PlayMode”	“Repeat & Shuffle”	What the video player does...
“Single”	“Normal”	- plays the current video file and then stops.
	“Repeat”	- plays the current video file repeatedly.
“Folder”	“Normal”	- plays all the video files of the current folder one after the other, and then stops.
	“Repeat”	- plays all the video files of the current folder one after the other. This will be repeated indefinitely.
	“Shuffle”	- plays all the videos of the current folder randomly.

“UPnP Thumbnails”

- Here you can enable/disable the video thumbnails while browsing through your PC’s shared videos. See: *Playing your PC’s Shared Media Files (UPnP)*. If you choose “**Disabled**”, you will be able to browse through your PC’s shared videos faster.

“LCD Backlight”

5 “Brightness”, “Contrast” and “Gamma”

- adjusts the level of backlight/contrast/brightness/gamma of the built-in screen.
- you can also reset the LCD parameters to the default values (“**Reset**” button).

1.4 PUTTING VIDEOS ONTO YOUR ARCHOS

The ARCHOS Media Club gives you the choice to purchase or rent videos directly from your ARCHOS, without using a computer. See: The ARCHOS Media Club.

There are two main methods to transfer the videos stored on your computer onto the ARCHOS:

1. Windows Media® Player: copy your videos using Windows Media® Player 10 or higher*:



Use Windows Media® Player 10 or higher* (**Sync** tab) to synchronize your computer’s video files to the ARCHOS. See *Putting Files onto the ARCHOS* for more details.

** For best performance, we recommend that users update to Windows Media® Player 11 or higher.*

2. Windows® Explorer: Copy and paste your video files from your computer into the **Video** folder of your ARCHOS.

To learn how to connect/disconnect the ARCHOS from your computer, see the *Transferring Files* section.

CREATING COMPATIBLE VIDEO FILES WITH YOUR COMPUTER

If some of your videos don't play on your ARCHOS, you may need to convert them to a compatible format:

- The easiest way to do this is by using Windows Media® Player 10 or higher to transfer videos to your ARCHOS. Windows Media® Player will automatically convert most formats to the WMV format that your device can play. *See your Windows Media® Player help instructions for more information.*
- If you don't want to use Windows Media® Player, a search on the Internet should allow you to find suitable utility programs to do this job.
- If you would like to simply copy and paste unprotected DVD video files from your PC onto your ARCHOS without converting them to WMV format, you can purchase the Cinema plug-in from the ARCHOS website (www.archos.com) or from the Media Club. The same is also true for video podcasts in the H.264 format. In this case, purchase the Video Podcast plug-in.

1.5 PLAYING YOUR PC'S SHARED VIDEOS (UPNP)



- When connected to your home WiFi network, your ARCHOS gives you the possibility to watch, directly on your device, shared videos stored in your PC's Windows Media® Library.
- For this to work, you will need a WiFi connection and Windows Media® Player 11 or higher* installed on your PC.
- The ARCHOS uses the UPnP (Universal Plug-and-play) standard to stream shared videos from your PC's Windows Media® Library.
- See: *Playing your PC's Shared Media Files (UPnP)*.

** There are other products (software) on the market that also can share media files using the UPnP standard.*

1.6 WATCHING WEB TV

In order to be able to watch numerous Internet TV channels, directly on your ARCHOS, you will need to register your device.

1. From the Home Screen, tap on **"Play"**, then choose **"Video"**.
2. Select **"Web TV"**. If your device is not connected to the Internet, it will try to make a connection.
3. The **"Web TV"** interface is organized by category, such as **"Location"**, **"Genre"**, **"Most Popular Stations"** etc. Browse the categories to find the channel you want to watch.

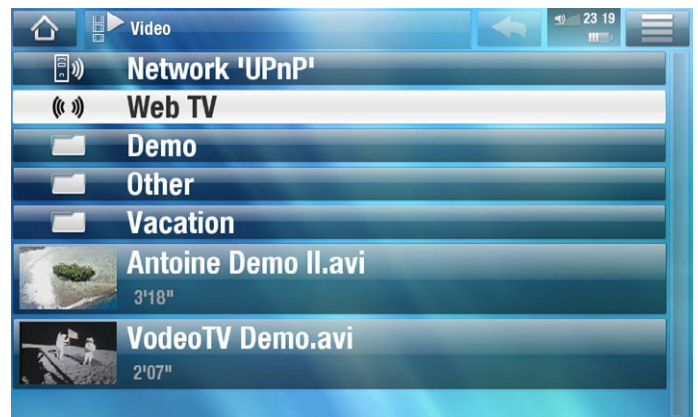

To find more information about how to connect to the Internet, see: Connecting to the WiFi

4. The TV channel you select will open in the video player. Selecting the menu icon  will display several options:
 - **"Info"**: to view the information concerning the TV channel.
 - **"Format"**: allows you to change the way the image is displayed
 - **"Add to favorites"** / **"Remove favorite"**: adds the current Web TV station as a favorite (or removes it from the favorites).
 - **"Sound"**: displays the **"Sound"** settings screen (see: *"Sound" Settings*).





2. PLAYING MUSIC



In the Home screen, tap on “**Play**”, then choose the “**Music**” icon to enter the “**Music**” player.

2.1 BROWSING THROUGH YOUR MUSIC FILES

- There are two types of views for you to browse through your songs: the Music Library and the Music Browser.
- In both views, you can go back one level in the interface by tapping on the Back icon . Wherever you are in the interface, you can go back directly to the Home screen by tapping on the Home icon .

When you leave the music playback screen while the song is still playing, it will keep playing in the background. This allows you to browse your hard drive, view your photos or surf the Web while listening to music. To stop the song, tap on pause in the music playback screen and then tap on Home.

THE MUSIC LIBRARY

- The Music Library (default view) shows your music sorted by categories (Cover, Artist, Album, Genre, etc.) if your music files contain these song information tags.
- When new music is copied to the ARCHOS, the Music Library will be updated automatically.
- If some of your music files do not contain information tags, they will be classified as (**Unknown**) in the Music Library.
- The “**Resume**” line allows you to resume the last-played music file, if it was interrupted before the end. If the “**Resume**” line does not appear, it means that no music file playback can be resumed.

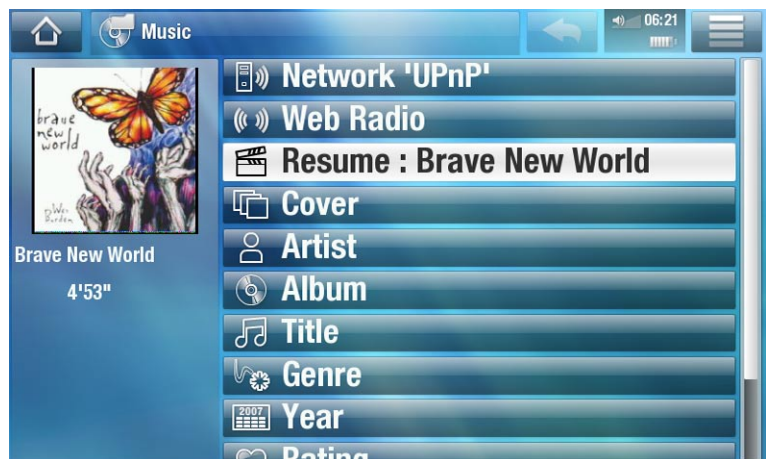

THE MUSIC BROWSER

- The music browser allows you to navigate through the **Music** folder of your device's hard drive.
- To use it, select "**Hard Drive**" in the initial Music Library view.



MUSIC LIBRARY AND MUSIC BROWSER MENU ITEMS*

* *The available menu items will vary depending on the mode you chose (Music Library or Music Browser).*

"Info"

- displays a message box with information about the highlighted music file.

"Show playlist"

- opens a playlist edition window on the right (see: *Playlists*).

"Bookmark"

- "**Resume**": will resume playing the highlighted song from the bookmark.
- "**Clear**": will remove the bookmark from the highlighted music file.

"Bookmark" only appears in the menu when a bookmarked music file is highlighted.

"File Management"

- "**Rename**": allows you to change the name of the highlighted music file using the virtual keyboard. See: *Using the Virtual Keyboard*.
- "**Delete**": allows you to delete the highlighted music file. A confirmation screen will pop up.
- "**Permissions**": allows you to define the file/folder as adult content, so that other users can't see it. To use this, your "**Parental Mode**" needs to be set to "**Adult (unrestricted access)**". See *Parental Control Settings*.

"Create Home Shortcut"

- Creates a Home screen shortcut to the highlighted song, artist, album, folder, etc.

“Search”

- Allows you to search for a specific song by entering a few letters or a word. See: *Using the Virtual Keyboard*.

“Settings”

- you can choose to display the Music Player settings screen (see: *Music Player Settings*) or the “**Sound**” settings screen (see: “*Sound*” Settings).

2.2 MUSIC PLAYBACK

- Use the scroll bar to browse through the list of audio tracks.
- To play a song, highlight the corresponding file and open it.



MUSIC PLAYBACK SCREEN

1. Menu icon
2. Back icon
3. Home icon
4. Play / Pause icon
5. Previous track
6. Next track
7. Progression bar
8. Volume level



MUSIC PLAYBACK TOUCHSCREEN CONTROLS

- To pause/resume the song, tap on the Pause / Play icon (see n° 4 in the previous screen).
- To play the previous/next song, tap on / (n° 5 or 6).
- To browse through your songs while listening to music, simply tap on the Back icon . This will take you to the Music Library or browser screen that you launched the current song from (see n° 2).
- You can tap on the progression bar to go directly to a different location in the song. You can also drag the cursor in the progression bar to another location in the song (see n° 7).

- The volume bar can be dragged in the same way (see n° 8).
- To display the available menu items, tap on the menu icon  (see n° 1).
- To go back directly to the Home screen, tap on the Home icon  (see n° 3).

When you leave the music playback screen while the song is still playing, it will keep playing in the background. This allows you to browse your hard drive, view your photos or surf the Web while listening to music. To stop the song, tap on pause in the music playback screen and then tap on Home.



MUSIC PLAYBACK MENU ITEMS

“Info”

- displays a message box with information about the current music file.

“Set bookmark”

- sets a bookmark at the current spot in the song. Only one bookmark per file is allowed. You can bookmark up to 32 files.
- to resume playing a song from a bookmark, go to the Music Library or the Music Browser, highlight the bookmarked music file. Select the “**Bookmark**” menu item, then choose “**Resume**” (“**Clear**” will remove the bookmark from the song).

“Set rating”

- allows you to give a rating to the current song (1-5) or to remove the rating (none).

“Lock device”

- locks your device’s touchscreen. This can be useful if your ARCHOS is in your pocket, for example, and you do not want to touch the screen by accident. To unlock the device, press the  button. A confirmation screen will pop up.

“Settings”

- you can choose to display the Music Player settings screen (see next section) or the “**Sound**” settings screen (see: “*Sound*” Settings).

2.3 MUSIC PLAYER SETTINGS

- In the Music mode, you can access the Music Player settings screen by using the “**Settings**” menu item.
- Use the left/right arrows to select a different setting for a parameter.

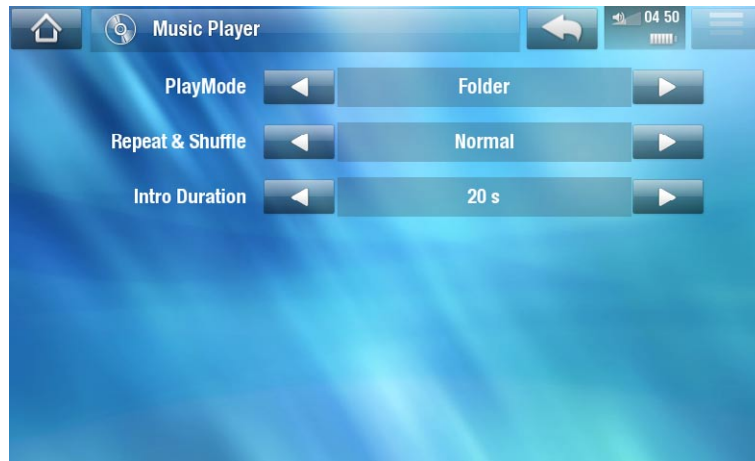

“PlayMode”, “Repeat & Shuffle”

- the following table explains how the audio player will work according to the settings you chose in **“PlayMode”** AND **“Repeat & Shuffle”**.
- An icon shows the current modes in the Music playback screen.

“PlayMode”	“Repeat & Shuffle”	What the video player does...
“Single”	“Normal”	- plays the current song and then stops.
	“Repeat”	- plays the current song repeatedly.
“Folder”	“Normal”	- plays all the songs of the current folder one after the other, and then stops.
	“Repeat”	- plays all the songs of the current folder one after the other. This will be repeated indefinitely.
	“Shuffle”	- plays the songs of the current folder randomly.
“All”	“Normal”	- plays all the songs of your ARCHOS one after the other, and then stops.
	“Repeat”	- plays all the songs of your ARCHOS one after the other. This will be repeated indefinitely.
	“Shuffle”	- plays all the songs of your ARCHOS randomly.

- | | |
|----------------|---|
| “Queue” | <ul style="list-style-type: none"> - allows you to select a track to be played after the current one is finished. - while a track is playing, switch to the browser window, select a track to highlight it, then open it. This is your queued track, which will be played after the current track. - you can only queue one track at a time. |
| “Intro” | <ul style="list-style-type: none"> - plays the first few seconds of each track. You can define the length to play in “Intro duration”. |

“Intro duration”

- defines for how long each track will be played when **“PlayMode”** is set to **“Intro”**.

2.4 PLAYLISTS

- A playlist is a list of audio tracks that the music player will automatically play one after the other.
- On your ARCHOS, you can play, create and edit as many playlists as you want.

Note: when you delete a playlist, you are only deleting the list and not the music itself.

PLAYING A PLAYLIST

- In the Music Library, highlight the **“Playlist”** line and open it.
- Highlight a playlist and open it. A panel showing the contents of the playlist will open on the right.
- Open the first item in the playlist to start playing from the first track.



PLAYLIST MENU ITEMS

These menu items appear when a music file is highlighted on the left panel:

“Add to playlist”

- **“Selected file”**: will add the highlighted track at the end of the current playlist.
- **“All files”**: will add all the tracks (from the left panel) at the end of the current playlist.

“Insert in playlist”

- **“Selected file”**: will insert the highlighted track before the selected item in the current playlist.
- **“All files”**: will add all the tracks (from the left panel) before the selected item the current playlist.

These menu items appear when the focus is on the right panel (playlist editor):

“Track”

- **“Remove track”**: deletes the highlighted track from the playlist.
- **“Move”**: allows you to change the position of the highlighted track within the playlist. Highlight the track you want to move, select the **“Track”** menu item, then choose **“Move”**. Now highlight the position to which you want to move the track and validate.

“Playlist”

- **“Clear”**: clears the current playlist.
- **“Shuffle”**: randomly shuffles the order of the songs in the current playlist.

“Save playlist”

- **“Save”**: saves the current playlist to the **Playlists** folder.
- **“Save As”**: same as **“Save”**, but it also allows you to give a personalized name to the playlist. See: *Using the Virtual Keyboard*.

“Hide playlist”

- closes the playlist editor.

“Settings”

- you can choose to display the Music Player settings screen (see *Music Player Settings*) or the **“Sound”** settings screen (see: *“Sound” Settings*).

CREATING A NEW PLAYLIST

1. While you are in the Music browser, select the **“Show playlist”** menu item. A playlist panel will open on the right. By default, the new playlist contains the same songs as the last opened playlist. These can be cleared with the menu item **“Playlist”** > **“Clear”**. You can now start modifying the playlist.
2. In the left panel, locate the songs you would like to add to your playlist. Highlight a song and open it to add it to the playlist. Repeat this operation with all the tracks you want.

To add all the songs of a folder to a playlist: open the folder in the left panel and highlight the first song. Then use the “Add to playlist” or “Insert in playlist” menu item and choose “All files”.

3. When you are satisfied with your new playlist, select the “**Save playlist**” menu item, and then choose “**Save as**”.
4. Enter the name of your new playlist with the virtual keyboard (see: *Using the Virtual Keyboard*) and select “**OK**”.

Use the tabs to jump back and forth between the left and right panels.

EDITING A PLAYLIST

To edit an existing playlist:

1. In the Music Library, highlight the “**Playlist**” line and open it.
2. Highlight the playlist you want to modify and open it. A panel showing the contents of the playlist will open on the right.
3. You can now add, shuffle, move or remove tracks within the playlist, using the appropriate menu items. The available menu items will vary according to which panel you selected (see: *Playlist Menu Items*).
4. After you have made the changes you want, select the “**Save playlist**” menu item and choose “**Save**” to save the playlist. If you wish to give it a different name, choose “**Save As**”.

2.5 PUTTING MUSIC ONTO YOUR ARCHOS

There are two main methods to transfer the music stored on your computer onto the ARCHOS:

1. Windows Media® Player: copy your music using Windows Media® Player 10 or higher*:



Use Windows Media® Player 10 or higher* (**Sync** tab) to synchronize your computer’s music files to the ARCHOS. See *Putting Files onto the ARCHOS* for more details.

** For best performance, we recommend that users update to Windows Media® Player 11 or higher.*

2. Windows® Explorer: Copy and paste your music files from your computer into the **Music** folder of your ARCHOS.

To learn how to connect/disconnect the ARCHOS from your computer, see the *Transferring Files* section.

TRANSFERRING YOUR CD COLLECTION TO YOUR ARCHOS

You can easily create music files with your computer by using Windows Media® Player 10 or higher to convert your CDs to a playable format for your ARCHOS:

1. Place a music CD in your computer, and Windows® will ask you what action you would like to perform.
2. Choose **Rip music from CD**, and Windows Media® Player will start ripping the CD. The songs will be automatically extracted from the CD and encoded into the MP3 or WMA format, according to what you chose in Windows Media® Player's ripping options. The default format is WMA.
3. Once this is done, the album will become part of your Music Library.
4. See *Transferring Files* to learn how to transfer the ripped music files onto the ARCHOS.

See your Windows Media® Player help instructions for more information.

- *Check the laws and regulations in your country or jurisdiction to know if private copying of your CDs for your own use is authorized.*
- *Some music CDs have a special copy protection system that will not allow Windows Media® Player to make music files from them.*

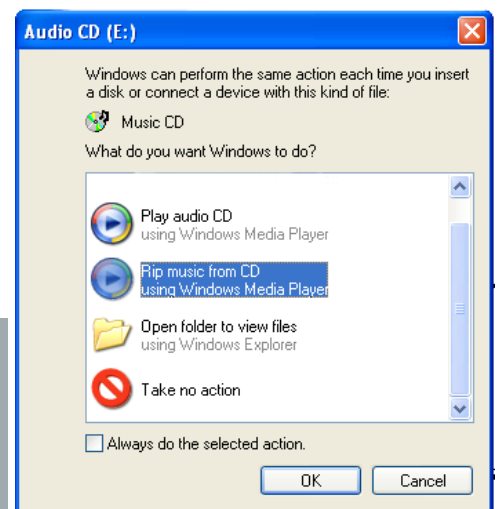

2.6 PLAYING YOUR PC'S SHARED MUSIC (UPNP)



- When connected to your home WiFi network, your ARCHOS gives you the possibility to play, directly on your device, shared music stored in your PC's Windows Media® Library.
- For this to work, you will need a WiFi connection and Windows Media® Player 11 or higher* installed on your PC.
- The ARCHOS uses the UPnP (Universal Plug-and-play) standard to stream shared music from your PC's Windows Media® Library.
- See: *Playing your PC's Shared Media Files (UPnP)*.

* *There are other products (software) on the market that also can share media files using the UPnP standard.*

2.7 LISTENING TO WEB RADIOS

In order to be able to listen to thousands of different Web radio stations and various podcasts worldwide, your device will need to be registered.

1. From the Home Screen, tap on **“Play”**, then choose **“Music”**.
2. Select **“Web Radio”**. If your device is not connected to the Internet, it will try to make a connection.
3. The **“Web Radio”** interface is organized by category, such as **“Location”**, **“Genre”**, **“Most Popular Stations”** etc. Browse the categories to find the radio station/podcast you want to listen to.



To find more information about how to connect to the Internet, see: Connecting to the WiFi.



4. The radio station/podcast you select will open in the music player. Selecting the menu icon  will display several options:
 - **“Info”**: to view the information concerning the radio station/podcast.
 - **“Add to favorites”** / **“remove favorite”**: adds the current Web radio station as a favorite (or removes it from the favorites).
 - **“Sound”**: displays the **“Sound”** settings screen (see: *“Sound” Settings*).

3. VIEWING PHOTOS



In the Home screen, tap on **“Play”**, then choose the **“Photo”** icon to enter the **“Photo”** mode.

3.1 BROWSING THROUGH YOUR PHOTOS

- The **“Photo”** browser allows you to navigate through the **Pictures** folder of the ARCHOS hard drive.
- You can go back one level in the interface by tapping on the Back icon . Wherever you are in the interface, you can go back directly to the Home screen by tapping on the Home icon .

THE PHOTO BROWSER

- The first screen of the Photo mode shows all the photos and subfolders located in the **Pictures** folder.
- To view a photo, highlight its thumbnail, then open it. If a photo is in a subfolder of the **Pictures** folder, open the subfolder, and you will see your photo.
- The Photo Browser also allows you to view your pictures, sorted by date.
- The **“Resume”** line allows you to resume the last-viewed photo.

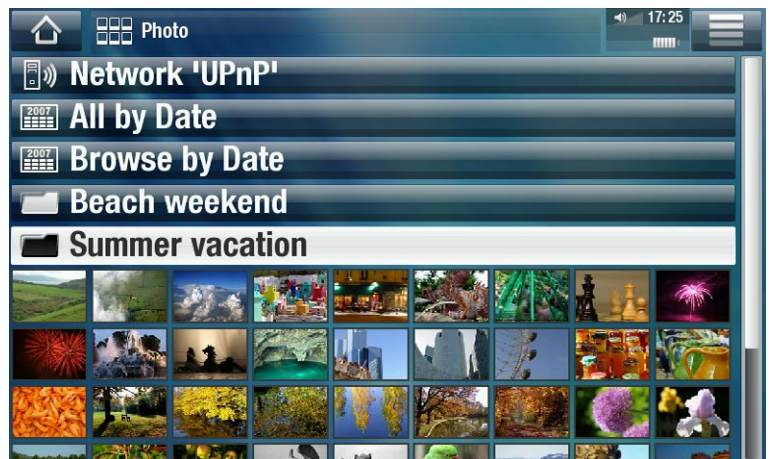

In the “Photo” browser each photo is displayed with a thumbnail.



PHOTO BROWSER MENU ITEMS*

“Info”

- displays a message box with information about the highlighted picture.

“File Management”

- **“Delete”**: allows you to delete the highlighted photo. A confirmation screen will pop up.

- **“Permissions”**: allows you to define the file/folder as adult content, so that other users can't see it. To use this, your **“Parental Mode”** needs to be set to **“Adult (unrestricted access)”**. See *Parental Control Settings*.

“Start slideshow”

- starts a slideshow from the highlighted image.

“Create Home Shortcut”

- creates a shortcut to this picture on the Home screen.

“Settings”

- will display the Photo viewer settings screen (see *Photo Viewer Settings*).

* *The available menu items will vary depending on where you are in the “Photo” Browser.*

3.2 PHOTO VIEWER

To view a picture, highlight the corresponding thumbnail and open it. The menu overlay will disappear automatically after a few seconds.

PHOTO VIEWER SCREEN

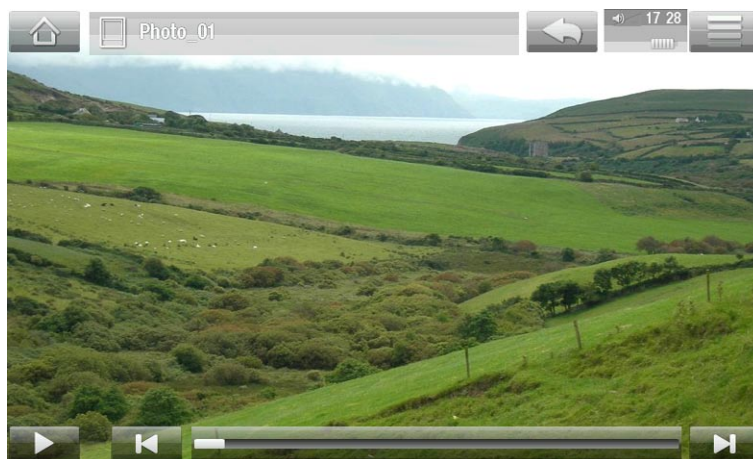



PHOTO VIEWER TOUCHSCREEN CONTROLS

- To start/pause a slideshow, tap on the Play  / Pause  icon.
- To display the menu overlay again, tap once anywhere on the screen. To make it disappear again, tap again.
- To display the next picture, drag your finger from left to right. Drag from right to left to go back one picture.



- To rotate the picture 90° counterclockwise, drag your finger from bottom to top. To rotate the picture 90° clockwise, drag from top to bottom.
- To magnify the current picture, hold down anywhere on the screen until you are satisfied with the zoom level. You can then drag your finger to move the picture. To display the image in its original format, tap twice (rapidly) anywhere on the screen.
- You can use the progression bar to go directly to another photo of the current folder.
- To display the available menu items, tap on the menu icon .
- To close the photo and go back to the “**Photo**” browser, tap on the Back icon . To exit the Photo mode and go back directly to the Home screen, tap on the Home icon .



PHOTO VIEWER MENU ITEMS

“Info”

- displays a message box with information about the current picture.

“Rotate”

- choose “**Left**” to rotate the picture 90° counterclockwise.
- choose “**Right**” to rotate the picture 90° clockwise.

“Start slideshow”

- starts a slideshow from the current image.
- the “**Pause slideshow**” menu item will appear, allowing you to pause the slideshow.

“Set as wallpaper”

- defines the current picture as your ARCHOS background image.

“Settings”

- will display the Photo viewer settings screen (see next section).

“Zoom”

- use the slider to magnify/demagnify the current picture.

3.3 PHOTO VIEWER SETTINGS

- In the Photo mode, you can access the Photo viewer settings screen via the “**Settings**” menu item.
- Use the left/right arrows to select a different setting for a parameter.



“Picture Pause”

- defines the time that each picture will be displayed during a slideshow.

“Transition”

- defines the transition effect to be used between two pictures. There are several cool effects that you can choose from.



“Sequence”

- allows you to enable/disable the shuffle mode. If this parameter is set to “**Shuffle**”, your pictures will be displayed randomly. To disable the shuffle mode, select “**Normal**”.

“Format”

- allows you to change the way the picture is displayed.
- “**Original**”: displays the entire picture in its original format.
- “**Full Screen**”: enlarges the picture to fill the screen. In order to fit the ARCHOS screen, your device might need to cut small parts of the image, most likely at the top and bottom.

3.4 PLAYING A SLIDESHOW

- To view a slideshow, highlight a picture file in the “**Photo**” browser or while viewing a photo, and choose the “**Start slideshow**” menu item, or tap on the Play  icon.
- While a slideshow is playing, you can pause it at any time by selecting the “**Pause slideshow**” menu item or by tapping on the Pause  icon.
- You can define the time that each picture is displayed and the transition effects in the “**Photo**” settings (see: *Photo Viewer Settings*).

3.5 PUTTING PHOTOS ONTO YOUR ARCHOS

There are two main methods to transfer the pictures stored on your computer onto the ARCHOS:

1. Windows Media® Player: copy your pictures using Windows Media® Player 10 or higher*:



Use Windows Media® Player 10 or higher* (**Sync** tab) to synchronize your computer's pictures to the ARCHOS. See *Putting Files onto the ARCHOS* for more details.

** For best performance, we recommend that users update to Windows Media® Player 11 or higher.*

2. Windows® Explorer: Copy and paste your pictures from your computer into the **Pictures** folder of your ARCHOS.

To learn how to connect/disconnect the ARCHOS from your computer, see the *Transferring Files* section.

3.6 PLAYING YOUR PC'S SHARED PHOTOS (UPNP)



- When connected to your home WiFi network, your ARCHOS gives you the possibility to view, directly on your device, shared photos stored in your PC's Windows Media® Library.
- For this to work, you will need a WiFi connection and Windows Media® Player 11 or higher* installed on your PC.
- The ARCHOS uses the UPnP (Universal Plug-and-play) standard to stream shared photos from your PC's Windows Media® Library.
- See: *Playing your PC's Shared Media Files (UPnP)*.

** There are other products (software) on the market that also can share media files using the UPnP standard.*

4. USING THE FILE BROWSER



The ARCHOS File Browser gives you the possibility to navigate the file system of your ARCHOS hard drive. In the Home screen, tap on **“Tools”**, then choose the **“Files”** icon to enter the File Browser.

You will see two panels:

- The one on the left is the panel that you usually use to navigate through your device’s hard drive.
- The panel on the right is the one you will use when you want to copy or move files and folders (see: *Copying and Moving Files and Folders*).



About your ARCHOS hard drive:

DO NOT delete or rename the original folders: “Music”, “Pictures”, “Video”, “Playlists”, etc. In the Home screen, the icons under the “Play” item (“Video”, “Music”, “Photo”...) lead directly to these folders and they will no longer work if the folders are deleted or renamed.

4.1 NAVIGATION



TOUCHSCREEN CONTROLS

- You can drag the scroll bar up and down to scroll the file list up and down. You can also scroll faster by tapping above or below the cursor in the scroll bar.
- To open a file or folder, tap on it to highlight it, then tap on it again.
- To jump between the left and right panels, tap directly on the panel that you want to highlight.
- To display the available menu items, tap on the menu icon
- You can go back one level in the interface by tapping on the Back icon . Wherever you are in the interface, you can go back directly to the Home screen by tapping on the Home icon .



FILE BROWSER MENU ITEMS

Note that some of the above menu items may not appear if they are not available for the highlighted file or folder.

“Info”

- displays a message box with information about the highlighted file.

“Create folder”

- creates a folder at the current location.
- you will have to enter the folder’s name with the virtual keyboard (see: *Using the Virtual Keyboard*).

“File Management”

- **“Rename”**: allows you to change the name of the highlighted file or folder using the virtual keyboard. See: *Using the Virtual Keyboard*.
- **“Delete”**: allows you to delete the highlighted file or folder (and all its contents). A confirmation screen will pop up.
- **“Permissions”**: allows you to define the file/folder as adult content, so that other users can’t see it. To use this, your **“Parental Mode”** needs to be set to **“Adult (unrestricted access)”**. See *Parental Control Settings*.

“Copy”

- **“Copy”**: allows you to copy the highlighted file or folder to the location defined in the other browser panel.
- **“Copy all files”**: allows you to copy all the files of the current folder to the location defined in the other browser panel.
- **“Move”**: allows you to move the highlighted file or folder to the location defined in the other browser panel.

COPYING AND MOVING FILES AND FOLDERS

- In the left panel, highlight the file/folder that you want to copy or move.
- In the right panel, navigate to the location where you wish to copy the file/folder to.
- Go back to the left panel, select the **“Copy”** menu item and then choose **“Copy”**, **“Copy all files”** or **“Move”**, depending on the action that you want to carry out.

4.2 USING THE VIRTUAL KEYBOARD

The virtual keyboard is an interface that allows you to type in text, for instance to rename a file or folder, or when you want to give a title to a playlist that you have just created.



- *the virtual keyboard might vary according to where you are in the interface.*
- *if a key is transparent, it means that it is disabled.*

1. Home icon
2. Back icon
3. current name of the file/folder
4. delete character before cursor
5. Tab key
6. Shift key
7. green Alt key: enable/disable the keys' green secondary functions.
8. blue Alt key: enable/disable the keys' blue secondary functions.
9. move cursor one character to the left
10. move cursor one character to the right
11. save the name



KEYBOARD TOUCHSCREEN CONTROLS

- To enter a character, tap on the corresponding key.
- To exit the keyboard without saving, tap on the Back icon  (see n° 2).
- When you are satisfied with the name, tap on the **Ok** key (see n° 11) to save it and exit the keyboard. A confirmation screen will pop up.

4.3 BROWSING OTHER COMPUTERS ON THE NETWORK

- When you are connected to a Windows® network, you can browse* the shared folders of other computers in the network, using the ARCHOS File Browser.
- From the Home screen, select tap on "**Tools**", then select "**Files**". In the left panel of the browser, select the first line in the list ("**Network**"). Your device will connect to your WiFi access point and then search for other computers in the Windows® network. You can then choose a computer and start browsing its shared folders.

** If the computer with the shared folders normally has a Windows® username and password, you will be asked to enter these before you can access the folder contents.*



Using the ARCHOS double browser, you will be able to play media files or transfer any file from a networked computer onto your device. You can also transfer files from your device onto a computer's write-enabled shared folder (see *Copying and Moving Files and Folders*).

If the WiFi is not enabled or if you are not connected to a network, the device will scan for available networks and connect to a known network or display the list of available networks so that you can connect to one of them.

5. CONNECTING TO THE WIFI

- The first time you start the ARCHOS, the installation wizard will help you configure your WiFi connection. Every time you launch an Internet application, the ARCHOS will try to connect automatically to a WiFi network.
- For the procedure to work, you must be in a WiFi zone that will allow you to connect to it.

5.1 WIFI CONNECTION PROCEDURE

HOW TO IMPROVE WIFI RECEPTION

In order to improve your device's WiFi reception, avoid placing your fingers in front of the WiFi antenna area (zone in red on the following images):



ARCHOS 5



ARCHOS 7

ENABLING WIFI

When you launch an Internet application such as “**Internet**” > “**Web**”, the ARCHOS will scan for available WiFi networks. If it finds a pre-configured one, it will connect to it.



- The first time you use your device, you may get a message “**No configured network found**”. Select “**View available networks**”, and the list of available networks will be displayed.
- If you get the message “**Could not connect to any WiFi network!**”, select “**View available networks**”, and the list of available networks will be displayed.



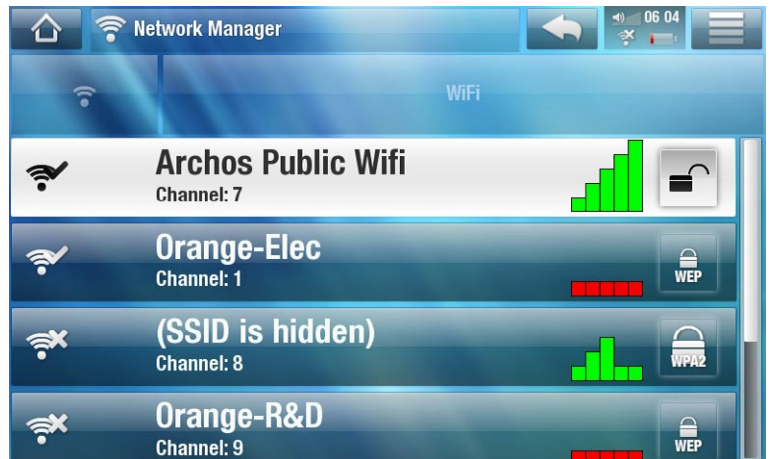

You can also use the “Internet”>“Connection” menu if you want to display available networks and configure them manually.

THE LIST OF AVAILABLE NETWORKS

- The list of available networks shows all the wireless networks in range of your device.
- The list is constantly refreshed automatically.
- In the list of available networks, for each network you will see the following information:



1. Configuration status:  configured network  unconfigured network
2. The name of the network (SSID), if it is broadcasted (*if the SSID is not broadcasted, you will be prompted to enter it in the next configuration screen*).
3. The strength of the signal.
4. The type of encryption key that is required:

 Open network (no key)	 WEP key	 WPA key	 WPA2 key	 WPS
---	---	---	--	---
5. The channel used by the network.
 - Select the network that you want to connect to (your home wireless network or a free hotspot).
 - You will be taken to the configuration screen for this network, where you will have to enter some information to set up your access to this network.

5.2 WIFI NETWORK CONFIGURATION

In order to connect to a wireless network, the ARCHOS will need some specific information about the network. Your device will automatically pick up certain pieces of information that it needs from the WiFi hot spot. You can enter the rest of the information manually in the network's configuration screen, as shown in the following sections.

Note that your device will remember the network connection information that you enter, in order to re-use it and connect automatically to the network when it is in range.

OPEN NETWORKS

- Open networks do not require an authentication key.
- If the network has automatic configuration turned on (DHCP), simply tap on the “**Connect**” button, and your ARCHOS will connect to this network, provided the signal is strong enough.
- If the network needs to be configured manually, use the left/right arrows to select the “**Manual**” setting on the “**Configuration**” parameter.
- Other parameters will appear: the required information can be obtained from the person who manages the network.

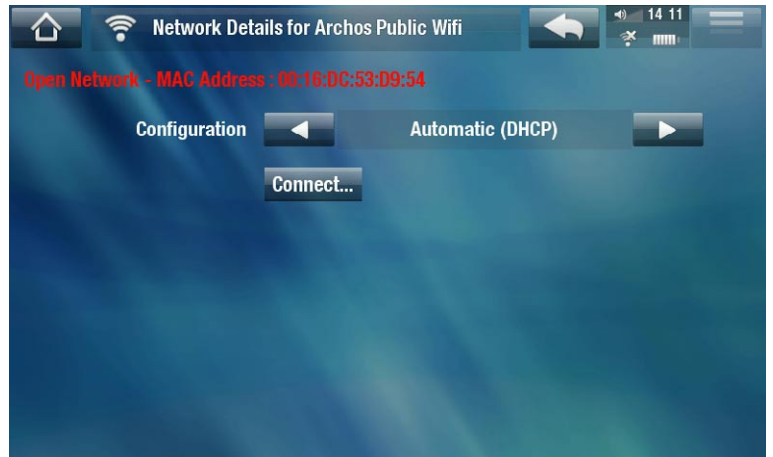

When you have finished entering all the information, tap on the “**Connect**” button, and your ARCHOS will connect to this network, provided the signal is strong enough.

PROTECTED NETWORKS (WEP, WPA OR WPA2 KEY)

- Protected networks require an encryption key to connect.
- The type of key (WEP, WPA or WPA2) will be detected automatically by your device.
- The rest of the required information can be obtained from the person who manages the network.

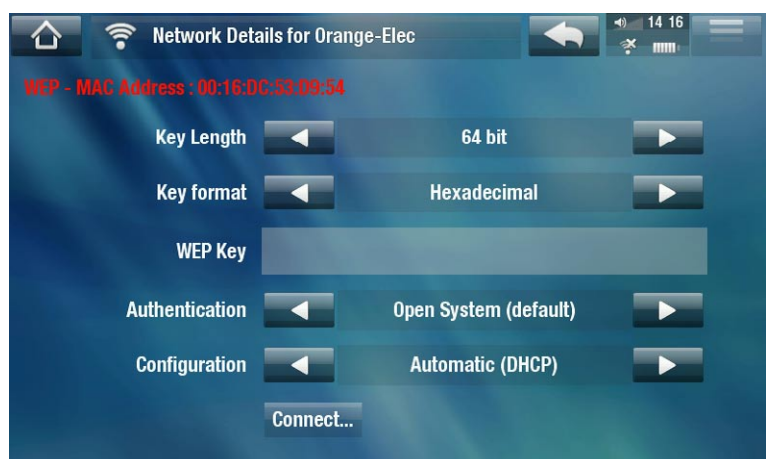

You will have to specify the following settings:

“Key length” (for WEP networks only)

- the authentication key can be 10 characters long (64bit) or 26 characters long (128bit).

“Key format” (for WEP networks only)

- in some cases you may need to change the key format in order to enter a passphrase/ password (if your key only includes the numbers 0-9 and A-F, then it is probably a hexadecimal key). See *the documentation that came with your WiFi router or modem*.

“Key” (WEP or WPA)

- type in the authentication key.
- you will be taken to a virtual keyboard (see: *Using the Virtual Keyboard*).
- type in the key and tap on **“OK”** when you have finished.

“Authentication” (for WEP networks only)

- the network’s authentication method can be based on an **“Open System (default)”** or a **“Shared Key”**.

“Configuration”

- it can be **“Automatic (DHCP)”** or **“Manual”**.
- if it is **“Automatic (DHCP)”**, then you do not have to enter any more information. Simply use the **“Connect”** button, and your ARCHOS will connect to this network, provided the signal is strong enough.
- if you must configure the network manually, select the **“Manual”** setting. Other parameters will appear: the required information can be obtained from the person who manages the network.

When you have finished entering all the information, use the **“Connect”** button, and your ARCHOS will connect to this network, provided the signal is strong enough.

Filtered networks: If your network manager allows only specific devices to connect to the network (known as MAC address filtering), you can supply the network manager with the MAC address of your ARCHOS. To find out what your MAC address is, tap on the “Tools” menu from the Home screen, then select “Settings”, and choose “System Info”. See: “System Info” Settings.

WPS (WIFI PROTECTED SETUP) NETWORKS

WPS is a standard, used by certain types of WiFi modems, that provides you with a secure and easy way to connect devices to your WiFi network.

WPS networks that require a PIN code entry are not supported.

1. On the ARCHOS, in the list of the available networks, select the WPS network you want to connect to (WPS networks are represented by this icon: ).
2. A message will pop up, asking you to press a button on the modem. Press the corresponding “WPS pairing” button on your WiFi modem (if needed, check the documentation of your modem).
3. Press the **“OK”** button on the ARCHOS, and it will start communicating with your WiFi modem in order to make a connection.

6. THE INTERNET FEATURES

The first time you start the ARCHOS, the installation wizard will help you configure your WiFi connection. Every time you launch an Internet application, the ARCHOS will try to connect automatically to a WiFi network.

6.1 BROWSING THE WEB



With the Web Browser plug-in, specially designed for your ARCHOS, you will have the possibility to browse websites*, watch videos from shared video web sites (such as Dailymotion™), download content, etc. To receive this plug-in, your device will need to be registered.

**supports Flash™ content and Javascript. The Java virtual machine is not supported.*

LAUNCHING THE WEB BROWSER

From the Home screen, tap on “**Internet**”, then select “**Web**”.

- If you are already connected to a network, the Web browser will simply open and you can start browsing the Web.
- If you are not connected to the Internet, the ARCHOS will try to connect automatically to a WiFi network.
- Please note: not all wireless networks offer access to the Internet. Some WiFi networks only link several computers together, without any Internet connection.





If the time and date are not correctly set, you might not be able to access certain web pages (See: “Clock” settings). If you choose to set the clock automatically when the ARCHOS connects to a WiFi network, you will need to select your Country and City/Zone (see: “Language and Region” Settings).

USING THE WEB BROWSER

- You can use the Web browser to browse websites, watch videos from shared video web sites (such as Dailymotion™) or download content.
- The Web browser features ‘tabbed browsing’. You can have several pages opened at the same time. They will appear in the tabs area, in the upper left corner of the screen. When several pages are open, simply select a tab to access the page that you want. See next section.



WEB BROWSER TOUCHSCREEN CONTROLS

- You can use your finger to scroll the current web page horizontally or vertically. To open a link, simply tap on it.
- To switch between the available tabs, tap directly on the corresponding tab, in the upper left corner of the screen.
- To go back to the previous page that you browsed, tap on the Back icon .
- To display the available menu items, tap on the Menu icon .
- When several tabs are displayed, tap on  to close the current one
- To go back directly to the Home screen, tap on the Home icon .



WEB BROWSER MENU ITEMS

“Reload” / “Stop”

- will stop loading the web page, if it is currently loading.
- will refresh the current web page, if it has stopped loading.

“Navigation”

- **“Forward”**: will go to the next page that you browsed.
- **“Back”**: will go back to the previous page that you browsed.

“Zoom”

- changes the way the web page is displayed. Select a zoom mode.

“Go to”

- **“Enter URL...”**: allows you to enter the address of a Web site you’d like to visit. Enter the address with the virtual keyboard (see: *Using the Virtual Keyboard*). Select **“OK”** to open the website in the current window, or select **“Open in new tab”** to open it in a new window.

- “**Search...**”: allows you to enter a search term into one of the configured search engines. Enter the key words using the virtual keyboard (see: *Using the Virtual Keyboard*). Select “**OK**” to open the results in the current window, or select “**Open in new tab**” to open them in a new window.

“Favorites”

- will open the “**Favorites**” manager. Here you can add favorites, rename or delete them. Select a favorite and use the “**Open in new tab**” menu item to open the corresponding web page in a new window.

“Settings”

- will open the “**Web Browser**” settings screen. Here you can decide whether to accept/ignore popup windows, enable/disable Flash™ content, delete your Internet history and cookies, etc.

Please note that some Web features requiring special plug-in software or Active X controls may not work in this special version of the Web Browser.



6.2 PLAYING YOUR PC'S SHARED MEDIA FILES (UPNP)

- When connected to your home WiFi network, your ARCHOS gives you the possibility to watch, directly on your device, shared media files (videos, music or photos) stored in your PC's Windows Media® Library.
- For this to work, you will need a WiFi connection and Windows Media® Player 11 or higher installed on your PC*.
- This is especially useful when you have a large library of music and video and you cannot fit it all onto the internal hard drive of the ARCHOS.
- The ARCHOS uses the UPnP (Universal Plug-and-play) standard to stream shared media files from your PC's Windows Media® Library.



Streaming one of your PC's shared videos and displaying it on your TV

** If you cannot install Windows Media® Player 11 or higher, it is possible to access and stream your PC's files from the ARCHOS File Browser. See Browsing Other Computers on the Network.*

SETTING WINDOWS MEDIA® PLAYER'S SHARING OPTIONS

1. Connect the ARCHOS to your WiFi network (see *Connecting to the WiFi*).
2. Connect your PC to the same WiFi network and start Windows Media® Player, version 11 or higher.
3. Click on the **Library** tab, and select **Media sharing...**
4. Check the box **Share my media to**, and click on **OK**. The ARCHOS icon should appear in the window, with a warning symbol next to it*.

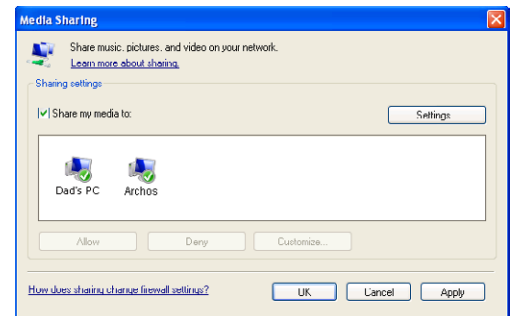
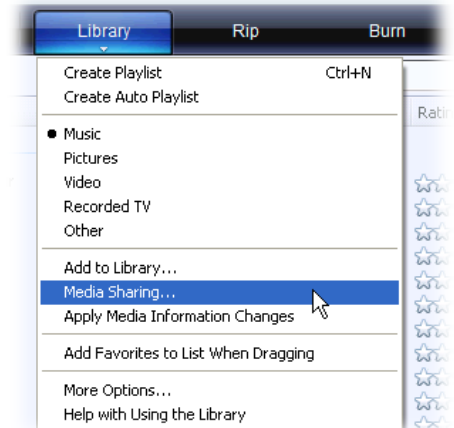

** ATTENTION: the first time you set your sharing options, it might take a couple of minutes for your PC to display the ARCHOS icon.*

5. Select the ARCHOS icon and click on the **Allow** button.
6. To modify your sharing settings, click on **Settings**. You can, for example, enter a name for your shared media files. You will then see this name on your ARCHOS. Click on **OK** to save the modifications.
7. Click on **OK** to close the **Media Sharing** window.
8. You can now close Windows Media® Player, and start viewing your PC's shared media files directly on your ARCHOS (see next section).

PLAYING YOUR SHARED MEDIA FILES ON THE ARCHOS

Your PC needs to be connected to the same WiFi network as the one the ARCHOS will connect to. You also need to have configured Windows Media® Player's sharing options (see the previous section).

1. On your ARCHOS, enter the Video, Music or Photo mode.
2. You will notice that the first item in the list is the shared media files: "**Network 'UPnP'**". Open this item to start scanning for devices and computers sharing their media files on the WiFi network.

3. If you entered a name for your shared media files in Windows Media® Player, it should appear. Open it, and you will see all your shared videos, songs or photos.

- If you are in the Video mode, you will then have access to all the videos stored in your PC's Windows Media® Library.
- In the same way, the Music and Photo modes will allow you to access all the music/photos stored in your PC's Windows Media® Library.



Note: You may have some video files of very high quality and these require that the WiFi connection transfers data at a high speed. If your ARCHOS is far away from your WiFi box, it may happen that the connection speed is reduced thus not allowing some video files to stream from your PC to the ARCHOS and the television.

6.3 THE ARCHOS MEDIA CLUB



- The ARCHOS Media Club gives you access to media content directly on your ARCHOS. This portal gives you access to video or music content that is either free, for rent, or for purchase. No need for your computer, the media streams directly off the Internet into your ARCHOS.
 - Or, if your ARCHOS is connected to the optional DVR Station, you will be able to select your internet media content directly from your television.
1. In order to activate the ARCHOS Media Club, you will need to register your product on-line directly on your ARCHOS via the WiFi. You can also register on the ARCHOS web site (www.archos.com/register).
 2. Make sure you have configured your ARCHOS to connect to a WiFi network (see: *Connecting to the WiFi*).
 3. On the Home screen, select the ARCHOS "**Media Club**" and choose a category.
 4. The ARCHOS connects to the WiFi, and you can start browsing the content.



Depending on your connection speed, you will have the possibility to start playing the video/song you purchased or rented while it's being downloaded. The videos/songs you get from The ARCHOS Media Club are saved in the "Video"/"Music" folders.

6.4 MAIL

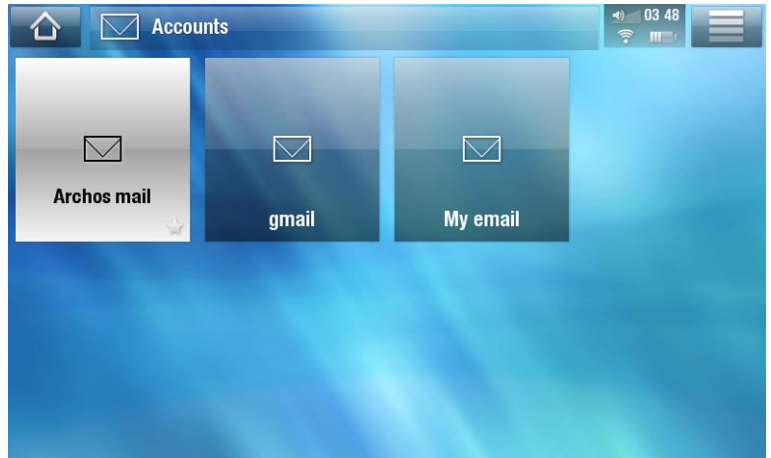
- This built-in e-mail application, similar to ones used on a regular computer, allows for e-mail accounts of the type POP, POPS, IMAP and IMAPS.
- From the Home Screen, select “**Internet**”, then “**Mail**”. The first screen shows your different e-mail accounts. The menu icon  allows you to:
 - create a new account
 - modify the settings of an existing account
 - set an account off-line/on-line
 - set an account as a favorite
 - delete an account



TOUCHSCREEN CONTROLS

- You can use your finger to scroll the screen up and down.
- To go back to the previous page, tap on the Back icon .
- To display the available menu items, tap on the Menu icon .
- To go back directly to the Home screen, tap on the Home icon .
- To fill in a field, tap in the field, then use the virtual keyboard to type the required information

CREATING AN ACCOUNT

In the list of accounts, tap on the menu icon  and select “**New account**”. Set the following parameters:

- “**Account**”: define the name that will appear in the list of accounts.
- “**In server**” (the server that receives your mail) / “**Out server**” (the server that sends out your mail): you can find these parameters in your e-mail account information (for example, in Outlook: “**Tools**” > “**Accounts Settings**”).

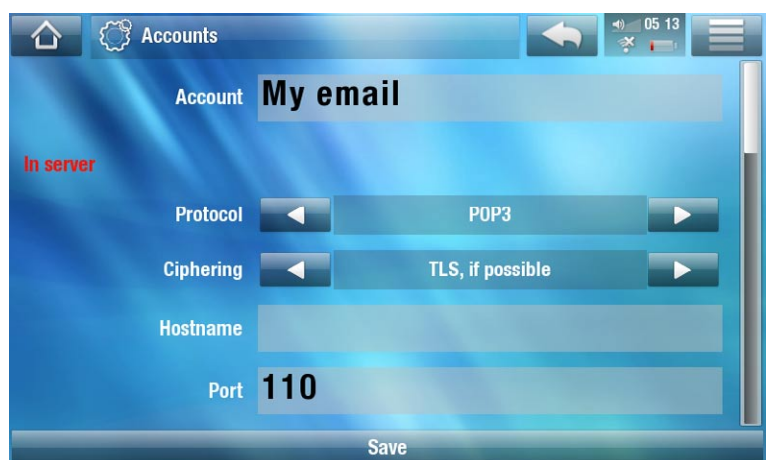



If you select “Gmail” or “Yahoo” as the protocol, then you will only need to enter your login and password.

- **"Other properties"**: here you can define your **"Nickname"** (the name that the recipient will see), a preferred **"Address"** which the recipients will always reply to, and an electronic text **"Signature"** that will be automatically inserted at the bottom of your e-mails.
- **"General e-mail settings"**: here you can define how often you want to check your new incoming messages. You can also select a ring tone by tapping on the **"Notification"** button (you will then have to find and open your music/ audio file in the ARCHOS list of folders).



Tap on **"Save"** to create the account.

READING YOUR E-MAILS

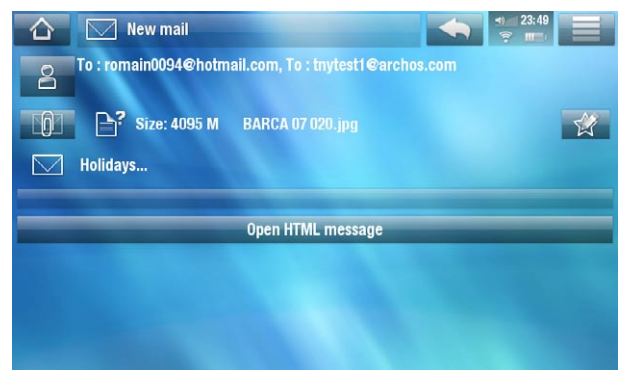
- In the list of accounts, tap on the account you want to use. You will then see all of your e-mail account folders.
- The menu icon  will allow you to send a new e-mail, sort your e-mails, search for a specific e-mail using the virtual keyboard, etc.
- While reading an e-mail, you can use the different icons to add information to a new or an existing contact () , save an attachment () , open an HTML message using the Web browser, etc.



WRITING AN E-MAIL

- In your list of e-mails or while viewing an e-mail, tap on the menu icon , select **"Send"**, then choose a sending method (**"New mail"**, **"Reply"**, **"Reply to all"**, **"Forward"**).
- To insert a carbon copy (**"Cc"**) or a blind carbon copy (**"Bcc"**), tap on the **"To"** button.
- Use the different icons to search for an address from your list of contacts using the virtual keyboard () , attach a file to your message, remove/add an address/ attachment (+/- buttons).
- Tap on **"Send"** when you have finished typing your message.

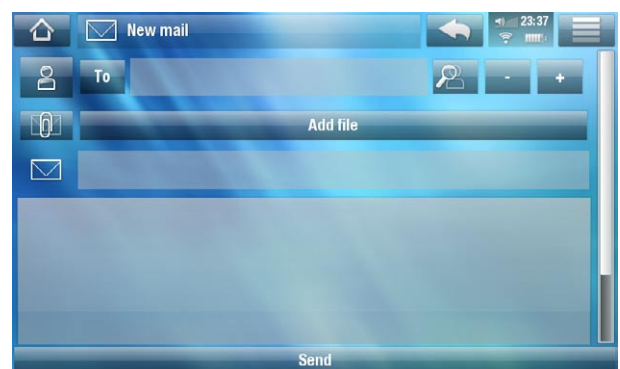

6.5 CONTACTS

This menu will allow you to manage your contacts. You can:

- Add information about a given contact
- Import and export your contact list to/from your computer
- Send a message to a particular contact

From the Home Screen, select "**Internet**", then "**Contacts**". The first screen will display your list of contacts. The menu icon  allows you to:

- create, modify and delete a contact
- send an e-mail to a contact
- search for a specific contact using the virtual keyboard
- sort your contacts
- export/import your vCard* contacts to/from your computer

**.vcf format supported*

7. TRANSFERRING FILES

7.1 CONNECTING THE ARCHOS TO A COMPUTER

1. Plug the ARCHOS USB cable into the ARCHOS.
2. Plug the USB end of the cable into your computer.

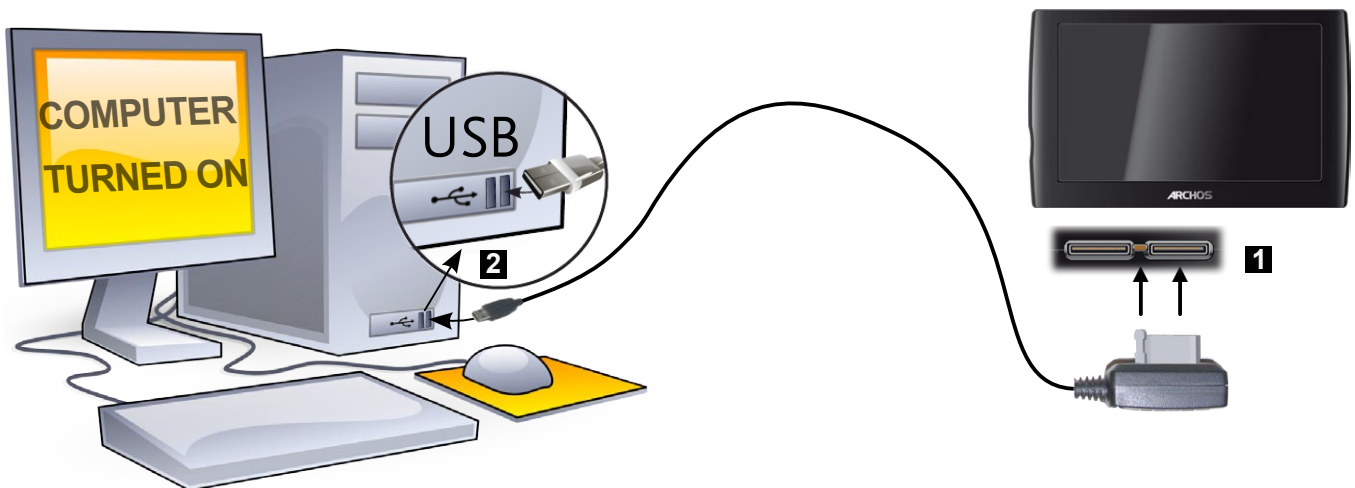

3. The ARCHOS will ask you if you want to charge it or connect it. Choose to connect it.
4. The ARCHOS icon will appear on your computer. The ARCHOS starts charging and you can start transferring files to it.

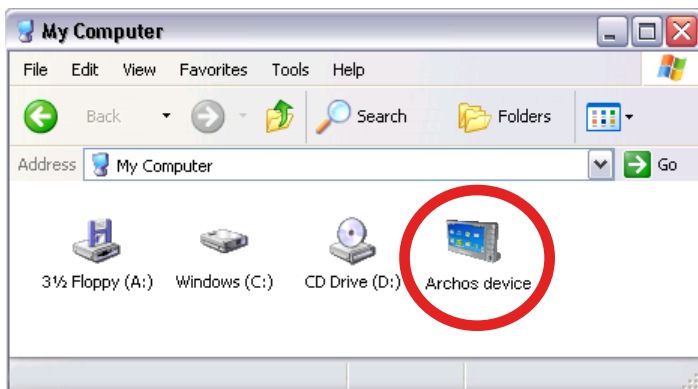

If you do not have Windows Media® Player 10 or higher installed on your computer, the ARCHOS will ask you if you want to charge its battery or connect it as a mass storage device (Hard Drive). Choose to connect it.

7.2 PUTTING FILES ONTO THE ARCHOS

There are two main methods to transfer your files onto the ARCHOS:

1. Copy your media files (videos, music, photos) with Windows Media® Player 10 or higher*:

** For best performance, we recommend that users update to Windows Media® Player 11 or higher.*

The Synchronize button in Windows Media® Player is a one way 'sync' button. It will add video, music and photo files to your ARCHOS. It will give you the possibility to have the same digital media on your ARCHOS as you have in your Windows Media® Player media library.



1. Connect your ARCHOS to the computer. See *Connecting the ARCHOS to a Computer*.
2. On your computer, start Windows Media® Player.
3. Select the **Sync** tab.
4. Choose the media files you want to transfer.
5. Click on the **Start Sync** button.
6. The selected videos, songs or photos will be copied directly into the corresponding **Video**, **Music** or **Pictures** folder of the ARCHOS.

See your Windows Media® Player help instructions for more information.

2. The second method is to use Windows® Explorer to copy and paste your files from your computer to the **Video**, **Music** or **Pictures** folder of your ARCHOS.

You cannot copy files larger than 2 GB to the ARCHOS due to the FAT32 file system constraints. For advanced users: in "PC Hard Drive" connection modes (mode 2 and 3), the maximum size is 2 GB for .AVI files and 4 GB for any other type of file. See: Storage Settings.

7.3 DISCONNECTING

When you disconnect the ARCHOS from a computer, your device automatically updates the ARCLibrary (not in USB mode 2 "PC Hard Drive"), so that the media files you just copied appear in the Music and Photo Libraries.

Windows® XP or higher & WMP10 or higher

- Verify that no data are being transferred between your ARCHOS and your computer.
- Now unplug the USB cable from your ARCHOS and/or computer.

Windows® 2000 or Me

DO NOT SIMPLY PULL OUT THE CABLE AT ANY TIME! You must remove/unmount the ARCHOS from the computer before disconnecting the USB cable to avoid loss of data or freezing.

- Once all your transfers are finished, click on the 'safely remove' icon in the system tray, next to the clock.

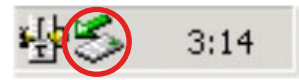

- Click on the 'safely remove' message.



- A message will pop up, telling you that it is now safe to disconnect the device*. You can now safely unplug the USB cable from your ARCHOS and/or computer.



** If you get a message saying that the device cannot be removed, close any computer program that may still be using data on your device, such as media players or Windows® Explorer.*

Mac® OS X

DO NOT SIMPLY PULL OUT THE CABLE AT ANY TIME!

You must remove/unmount the ARCHOS from the computer before disconnecting the USB cable to avoid loss of data or freezing.

- On your desktop, drag the ARCHOS icon towards the trashcan, which will turn into a big eject symbol.
- Drop the icon onto this eject symbol: the ARCHOS hard drive will disappear from the desktop.
- You can now safely unplug the USB cable from your ARCHOS and/or computer.

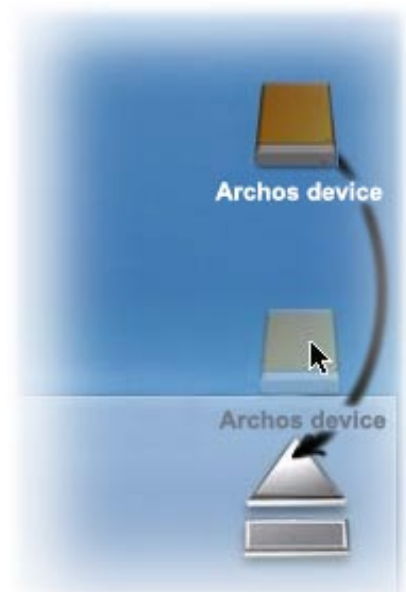

Linux

DO NOT SIMPLY PULL OUT THE CABLE AT ANY TIME!

You must remove/unmount the ARCHOS from the computer before disconnecting the USB cable to avoid loss of data or freezing.

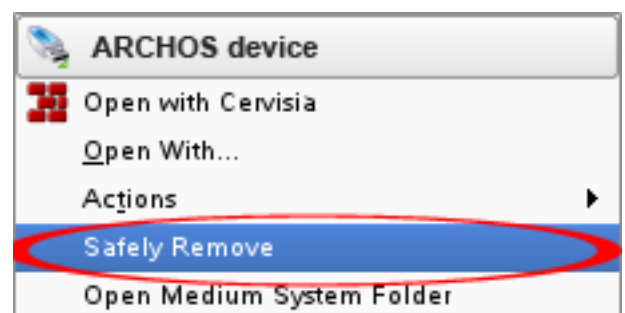

- On your computer, right-click on the ARCHOS icon and select Safely Remove.
- Wait until the ARCHOS icon disappears, and safely unplug the USB cable from your ARCHOS and/or computer.

8. MAIN SETTINGS





In the Home screen, tap on “**Tools**”, select “**Settings**” then choose a setting to open its corresponding screen.



USING THE TOUCHSCREEN

Once you are in a settings screen:

- tap on a parameter to highlight it.
- tap on the left/right arrows to select a different setting.
- when it is possible, you can use your finger to scroll the screen up and down to reveal settings that you don't initially see.
- when you have finished adjusting your settings, tap on the Back icon  to go back to the list of settings, or tap on the Home icon  to go directly to the Home screen. Your settings are saved instantly.

8.1 “SOUND” SETTINGS

This screen allows you to adjust the sound settings of your ARCHOS to your personal taste.



“Touch-Screen Click”

- “**ON**” / “**OFF**”: enables/disables the touchscreen click sound.

“Built-in Speaker”

- “**ON**” / “**OFF**”: the built-in speaker remains on or off regardless if headphones are attached.
- “**Automatic**”: the built-in speaker automatically turns off when you plug in headphones or connect your ARCHOS to the optional DVR Station.

“Audio Output”

- defines whether the audio signal is sent out via the **“Analog Line-Out”**, **“HDMI”*** or **“SPDIF”*** interface.

** When connected to a DVR Station.*

“Preset”

- allows you to quickly select a sound profile.

“Set Equalizer”

- allows you to use a custom sound profile. Select this option to enter the equalizer screen (see next section).

“Balance” (not available in HDMI output mode)

- allows you to balance the sound between the left and right stereo channels.

“Reset”

- resets the sound parameters to the default values.

“EQUALIZER” SCREEN

- Your ARCHOS features a 5-band equalizer.
- Select a band (Bass, Mid. bass, Mid. range, Mid. treble or Treble), then use the up/down arrows to change the gain level for these frequency ranges.

It is advised that you change these settings while listening to music, in order to be able to appreciate the sound changes.

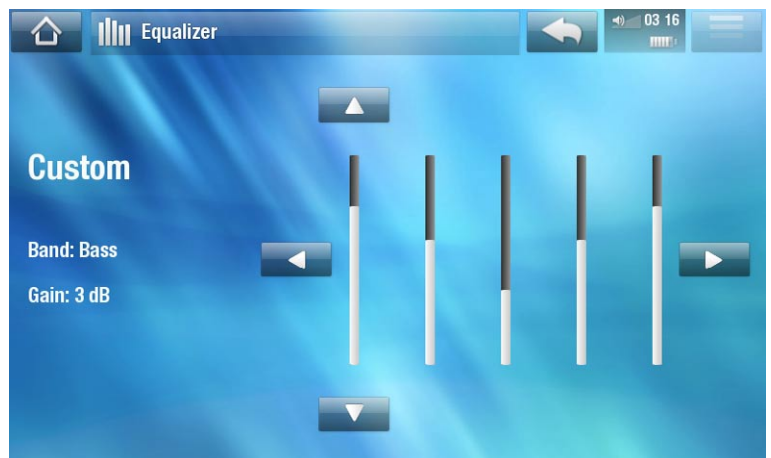

8.2 “SCREEN” SETTINGS



“LCD Backlight”

- adjusts the level of backlight of the built-in screen.

5 “Brightness”/“Contrast”/“Gamma”

- use these sliders to adjust the display parameters of the built-in screen (contrast, brightness and gamma).
- you can also reset the display parameters to their default values (“**Reset**” button).

“Touch-Screen Calibration”

- If the touchscreen is not responding properly, use this button and follow the instructions on the screen.

If this does not work or if you cannot access the touchscreen settings, you can force the touchscreen calibration (see: System Recovery).

8.3 “TV OUT” SETTINGS

These settings only appear when the ARCHOS is connected to the DVR Station, Mini Dock or Battery Dock.



“TV Connection”

- when your ARCHOS is connected to the optional DVR Station (available at www.archos.com or from the Media Club), select the type of video output (“**Composite**”, “**S-Video**”, “**RGB**”, “**Component**” or “**HDMI**”), based on how you have connected the DVR Station to your TV.

“Resolution” *

- select the resolution that best adapts to your TV: “**VGA 4/3 (640x480 60Hz)**”, “**480p 16/9 (720x480 60Hz)**”, “**576p 16/9 (720x576 50Hz)**” or “**720p 16/9 (1280x720 50Hz)**”.

** This parameter only appears if you choose the “HDMI” TV connection mode.*

“TV Standard” **

- choose between the “**NTSC (USA)**” and “**PAL (Europe)**” systems (select the one that is compatible with your country’s television system).

“TV Format” **

- “**4:3**” or “**16:9**” - the format used by your television set to display images.
- the option “**Wide screen**” becomes available when you set the “**TV standard**” parameter to “**PAL (Europe)**”.

**** These parameters do not appear if you choose the “HDMI” TV connection mode.**

“Audio Output”

- defines whether the audio signal is sent out via the “**Analog Line-Out**”, “**HDMI**” or “**SPDIF**” interface depending on how you have connected the ARCHOS to your TV.

8.4 “APPEARANCE” SETTINGS



“Picture name”

- allows you to choose a wallpaper for your ARCHOS. The wallpaper can be either an image or a video. Select “**None**” if you do not want any background image or video.
- you can choose between all default backgrounds or the images that you have previously set as wallpapers.
- you can also set a picture as wallpaper from the Photo and Video modes.

“Wallpaper color”

- defines the color for your wallpaper, if you have disabled the use of a background image or video.

“Cancel”

- use this button to discard any changes you may have made since entering this screen.

8.5 "LANGUAGE AND REGION" SETTINGS



"Language"

- choose a language.
- visit www.archos.com to check the availability of other languages. New languages are included in the firmware as they become available. See *Updating the Firmware*.

"Select location"

- if your clock is set to "**Automatic**" (see "*Clock*" Settings), select your "**Country**", and "**City/Zone**".

"WiFi Region"

- this is configured automatically according to how you set your location.

8.6 "TV CONTROL" SETTINGS

- This is where you can set the DVR Station's Infrared (IR) emitter to communicate with your tuner. This will allow you to schedule recordings easily via the ARCHOS TV Program Guide (EPG).
- See the manual of the optional DVR Station.

8.7 "CLOCK" SETTINGS

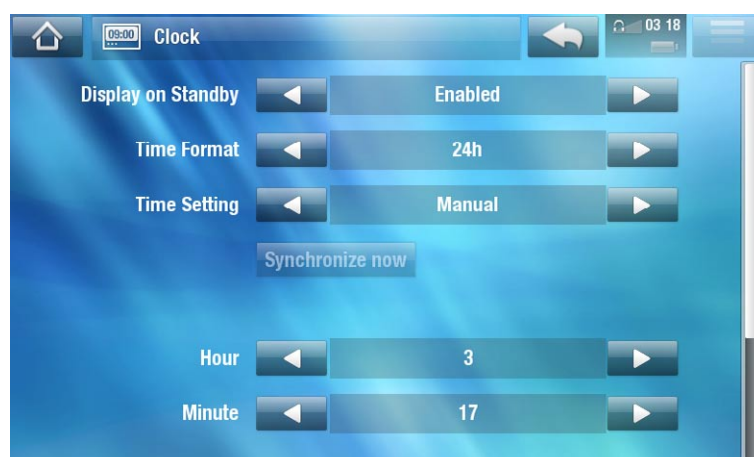

If you use the optional DVR Station to schedule video recordings on your TV system, make sure that the time and date are set correctly!

“Display on Standby”

- **“Enabled”**: when your device is externally powered and the screen backlight shuts off, then tapping the touchscreen or pressing a button will display the current time as well as the time set for the alarm clock (bottom right). After a few seconds, the backlight will shut off again.
- While the time is being displayed, tapping the touchscreen or pressing a button again will bring you to the ARCHOS Home Screen.

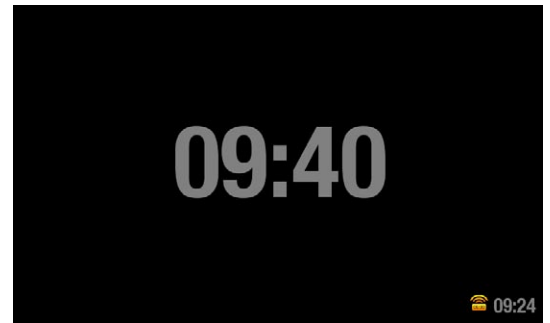

“Time Format”

- choose between 12h or 24h mode.

“Time setting”

- **“Automatic”**: select this parameter if you want to set the clock automatically when your ARCHOS is connected to a WiFi network. You will need to select your location in the **“Language and Region”** settings screen (see: *“Language and Region” Settings*).
- **“Manual”**: select this parameter to set the current date & time manually. The following parameters will appear: **“Hour”**, **“Minute”**, **“Year”**, **“Month”** and **“Day”**.

“Synchronize now”

- if the **“Time setting”** parameter is set to **“Automatic”**, use this button to set the clock automatically via the WiFi.
- for this to work, the ARCHOS needs to be connected to a WiFi network.

ATTENTION: If the time & date are not correctly set, you might not be able to access certain web pages.

“Hour”, “Minute”, “Year”, “Month”, “Day”

- these parameters allow you to set the current time and date manually.

8.8 "ALARM CLOCK" SETTINGS



- Set "**Alarm Clock**" to "**Enabled**" (if you want to turn off the alarm clock, select "**Disabled**")
- The following parameters will appear:
 - "**Hour**", "**Minute**": set the time you want the alarm clock to go off.
 - "**Recurrent Alarm**": set this to "on" if you want the alarm to go off everyday at the same time.
 - "**Alarm File**": the name of the file to be played when the alarm goes off.
 - "**Change Alarm File**": select this to define a new alarm file. You can choose a video, a song, a Web radio or a Web TV station.
- When you close the window, you will see a symbol appear in the top status bar, on the left of the volume icon, indicating that the alarm clock is enabled.

8.9 "POWER" SETTINGS

- These settings will help you save battery power, thus allowing a longer battery autonomy.
- You can adjust settings for both battery operation and power supply operation (when the ARCHOS is connected to a powered add-on).



Your ARCHOS will consume more power as these parameters are set to higher values. In battery operation, it is advised to set these parameters to lower values in order to save power.

“Device Complete Power Off”

- If you do not plan on using the ARCHOS for an extended period of time, use this button to completely turn off your device, so that there is absolutely no battery usage.
- You can also turn off your device completely by holding the Power button until the second “shutdown” message appears*. See *ARCHOS Description*.

** Remember that when you release the Power button during the first “shutdown” message, your device will keep using a small amount of battery power to allow a quick start up.*

“BATTERY OPERATION”

“Power Off”

- the amount of time of user inactivity before the device shuts off.
- the device will not shut down during a slideshow, audio/video playback, audio/video recording, or USB connection.

“Backlight Off”

- the amount of time of user inactivity before the LCD display turns off.
- the display will not turn off while a video or slideshow is playing, or when you are browsing the web.

“Web Browser”

- **“Normal Power Off”**: while browsing the web, the ARCHOS will shut down according to the setting selected for the **“Power Off”** parameter.
- **“Prevents Power Off”**: while browsing the web, the ARCHOS will not shut off automatically from user inactivity.

“POWER SUPPLY OPERATION”

“Standby”

- the amount of time of user inactivity before the ARCHOS goes into Standby mode.
- the system will not go into Standby mode during a slideshow, audio/video playback, audio/video recording, or USB connection.

“Backlight Off”

- the amount of time of user inactivity before the LCD display turns off.
- the display will not turn off while a video or slideshow is playing.

“Web Browser”

- **“Normal Standby”**: while browsing the web, the ARCHOS will go into Standby mode according to the setting selected for the **“Standby”** parameter.

- **“Prevents Standby”**: while browsing the web, the system will never go into Standby mode.

8.10 “STORAGE” SETTINGS



“Free Storage Space”

- displays the amount of free space on the hard drive.

Note: reported number of gigabytes is binary-based counting (1KB=1024 bytes). Thus each reported Gb represents approximately 1.07 gigabytes (decimal). Formatting also takes up space.

“USB preference” (for advanced users)

- Your preferred connection mode will be used every time you connect the ARCHOS to a computer. The connection mode determines how your device interacts with your computer:
- Mode 1: **“Windows Media Device”**: Recommended for users of Windows Media® Player (WMP) version 10 or higher. When set to this mode, the ARCHOS uses the Media Transfer Protocol (MTP). It allows you to charge your ARCHOS and transfer files onto it at the same time. Your ARCHOS will be locked only when it is opened in Windows® Explorer. You will be able to synchronize your media library automatically every time you connect your ARCHOS to your computer. When your file transfer is finished, simply unplug the cable from the ARCHOS, and your device will update the ARCLibrary (Music/Photo libraries).
- Mode 2: **“PC Hard Drive”**: Recommended for users of Windows® XP with Windows Media® Player 9, Windows® 2000, Me, Mac® OS X or Linux. The ARCHOS will ask you if you want to charge it or connect it as a mass storage device (Hard Drive). Choose to connect it as a mass storage device (external hard drive). When connected to your computer, your ARCHOS will be locked. Disconnection: when the file transfer is over, safely unmount the ARCHOS (See: *Disconnecting*) and your device will do a quick ARCLibrary update (Music/Photo libraries). May not index all files.
- Mode 3: **“PC Hard Drive (auto-ARCLib)”**: Same as mode 2, but with a full ARCLibrary update (Music/Photo libraries) at disconnection.

“Update ARCLibrary”

- Available only when “**USB Preference**” is set to “**PC Hard Drive**” (mode 2).
- This USB mode only does a quick ARCLibrary update (Music/Photo libraries). Use the “**Update ARCLibrary**” button if you want to do a full ARCLibrary update.

8.11 “PARENTAL CONTROL” SETTINGS

The parental code system allows you to create a passcode and hide any file or folder from view. This is useful, for example, if you have adult content which you prefer not to be accessible by others. By default, your device is set to “**Adult (unrestricted access)**” and the default parental code is “0000”.

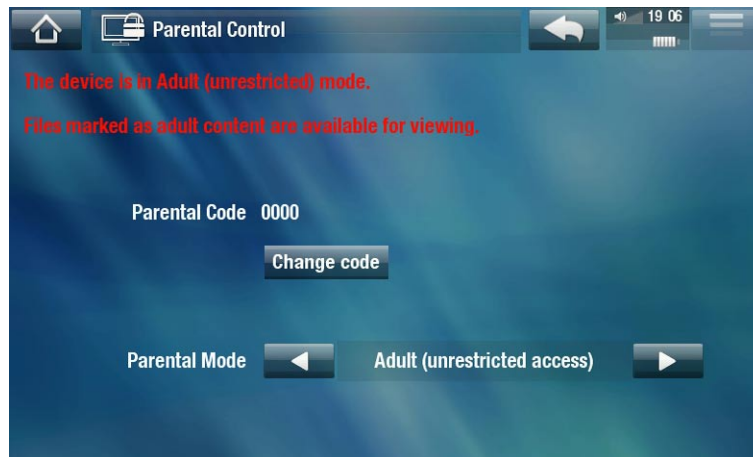

“Parental Code”

- displays your current parental code.

“Change code”

- to change your parental code, the device must be set to “**Adult (unrestricted access)**”.
- tap on this button to define your 4 digit password code, using the virtual keyboard. See: *Using the Virtual Keyboard*.

If you have changed your code and forgot it, please contact our technical support team (www.archos.com/support).

“Parental Mode”

- You have the choice between 2 modes:
 - “**Adult (unrestricted access)**”*: all files are visible.
 - “**Child (restricted access)**”: files marked as adult content will not be visible. Every time you connect the device to a computer, it will ask for the parental code.
- You also have the possibility to select “**Request (Ask me at startup)**”: every time the device turns on, you will be asked to enter the parental code. If you enter it, the device will be set to “**Adult**” mode, and if you don’t, the ARCHOS will be in “**Child**” mode.

** If you go from “Child” to “Adult” mode, you will be required to enter your parental code.*

8.12 "SECURITY" SETTINGS

Here you can define a security code that will be asked every time the device is turned on. You can enable/disable the code and change it.

8.13 "CUSTOMER ASSISTANCE" SETTINGS

Here you access the online registration, view the PDF user manual or access the "**Repair and Formatting Tools**":

"Repair and Formatting Tools"

- use this button to access the "**Repair and Formatting Tools**" settings screen. This screen allows you to do the following actions:
- "**Clear temporary system files and cache**" (does not erase any data)
- "**Reset Settings**" (resets all user settings)
- "**Format Hard Drive**" (erase all data, media files, and licenses)
- "**Full Reinitialization**" (erase all data, media files, licenses and settings)

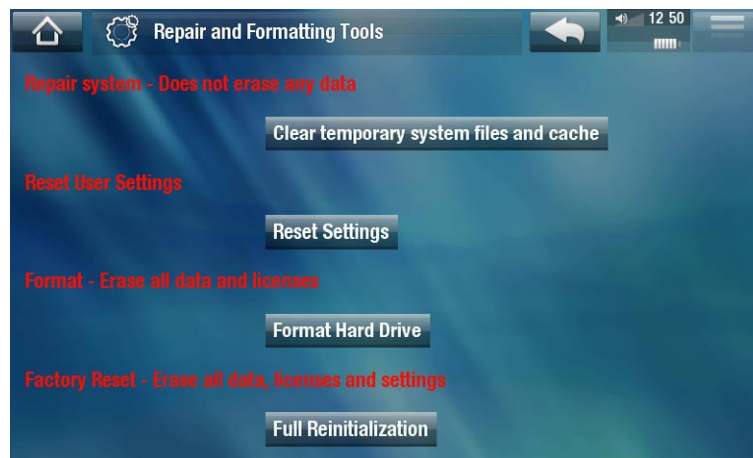

In the event that your ARCHOS freezes or does not respond anymore, try to reset it (see: Troubleshooting).

If this does not work or if you cannot access the Repair and Formatting Tools, you can try a system recovery (see: Troubleshooting).

8.14 "FIRMWARE AND PLUG-INS" SETTINGS

"Firmware Ver."

- displays the current version of the firmware and Digital Rights Management (DRM) system.

“Plug-ins”

- displays the current plug-ins installed on your device.

“Product Key”

- each ARCHOS has a unique number.
- you will need this number to register your product online if you are using a computer (www.archos.com/register).

“Firmware Update”

- use this button to update the firmware manually (see: *Updating the Firmware*)

“Online Firmware Update”

- use this button to search for an online update via a WiFi network. If there is one available, it will be installed automatically. See *Updating the Firmware* to learn more.

8.15 UPDATING THE FIRMWARE

The firmware is the operating system (OS) of your ARCHOS. It is periodically updated to bring new features, improvements and bug fixes. There are two main ways to update your product's firmware:

- Directly on your ARCHOS if your device can connect to a WiFi network.
- With a computer connected to the internet

UPDATE DIRECTLY ON THE ARCHOS (WIFI CONNECTION NEEDED)

This is the easiest way to update the firmware. For this to work, you only need a connection to a WiFi network. See *Connecting to the WiFi*.

1. From to the Home screen, tap on **“Tools”**, select **“Settings”** and choose **“Firmware and Plug-ins”**.
2. Tap on the **“Online Firmware Update”** button.
3. The ARCHOS will connect to the WiFi and search on-line for a new firmware. If there is one available, it will start downloading, and it will be installed automatically.

UPDATE USING A COMPUTER (INTERNET CONNECTION NEEDED)

You can also update the firmware using a computer connected to the internet:

1. On your PC, go to www.archos.com/firmware.
2. Search for the latest firmware available for your ARCHOS.
3. Compare the latest on-line version with the one installed on your ARCHOS: your ARCHOS firmware version number appears in the **“Firmware and Plug-ins”** settings screen (see: *“Firmware and Plug-ins” Settings*).

4. If the on-line version is more recent than yours, follow the instructions to download it and copy it to your ARCHOS. Then go to **"Tools"** > **"Settings"** > **"Firmware and Plug-ins"** and tap on **"Firmware Update"**.

Your Internet browser may warn you that the contents of the firmware file could harm your computer. ARCHOS has taken precautions to insure that this file will not harm your computer.

8.16 "SYSTEM INFO" SETTINGS

"Product Key"

- each ARCHOS has a unique number.
- If you register your product on-line using a computer (www.archos.com/register), this number will be needed.



"MAC address"

- each ARCHOS has a unique MAC address.
- some WiFi networks filter MAC addresses. You might need to communicate this address to the person who manages the network.

9. OTHER FUNCTIONS



9.1 "PLAY" MENU: OTHER FUNCTIONS

PLAYING GAMES

In the Home screen, tap on "**Play**" and choose "**Games**". Go to www.archos.com or in the Media Club to purchase games and learn how to install and use them.

FLASH APPS

- Select this icon to display the Flash™ applications (files of type .swf) stored in the **Flash** folder of your ARCHOS.
- Tap on a Flash™ application to launch it.



9.2 TV FUNCTIONS

In the Home screen, tap on "**TV**" and choose a category. To benefit from these functions, you have a choice of add-on that can be purchased at the ARCHOS web site or from the Media Club.

TV PROGRAM GUIDE

Using the optional DVR Station, you can easily schedule TV recordings from the grid of programs (includes program summary info) using the TV program Guide.

TV SCHEDULER

Allows you to manually schedule a TV recording using the optional DVR Station or TV Snap-on.

RECORDINGS

Display the list of TV programs you have recorded with your DVR Station, DVR Snap-on, or TV Snap-on.

DIGITAL TV

Select this icon to watch digital TV (DVB-T) when you have connected the optional TV Snap-on to your ARCHOS.



9.3 TOOLS

In the Home screen, tap on “**Tools**” and choose one of the following categories:

SETTINGS

This menu allows you to configure your device’s settings. See *Main Settings*.

WIDGETS

- Widgets are little applications (calculator, weather forecast, currency converter, note writer, etc) that add your favorite features to your ARCHOS. It gives you a fun, quick and easy access to hundreds of tools... right on the device. The free Web Browser plug-in comes with several widgets. To receive this plug-in, your device will need to be registered.
- Go on www.archos.com to learn how to get widgets for your ARCHOS and how to install and use them.

FILES

Select this icon to navigate the file system of your ARCHOS hard drive. See *Using the File Browser*.

PDF DOCUMENTS

- Select this icon to display the PDF documents stored in the **PDF** folder of your ARCHOS.
- Tap on a PDF file to open it with the PDF reader.
- Your ARCHOS features a PDF reader with hyperlink support.

ATTENTION: The ARCHOS PDF reader may not implement all PDF features. For example, you will not be able to open password protected PDF files.

PDF Touchscreen Controls

- To follow a link (red/blue outline), simply tap on it.
- To display the menu overlay while viewing a PDF document, tap in the top right corner of the screen.
- To scroll the page up and down, tap on the page and drag it up or down.
- Once arriving at the bottom of a PDF page, pull the page up to reveal the next page. Proceed similarly to go to the previous page.
- To go back to the Home screen, tap the Home icon .

Following Hyperlinks

- Some PDF documents have hyperlinks (for instance, a table of contents, links to an external website, etc.).
- Links are surrounded by a blue outline. A highlighted link (active link) is surrounded by a red outline.
- If you want to go back to the previous page (where you 'clicked' the link), select the "**Link back**" menu item.

Note that hyperlinks referring to an external document or to a URL may not work.

PDF Reader Menu Items

"Hide text overlay"

- will hide all overlaid graphics (status bar, menu items, etc.) to only show the PDF document.

"Zoom"

- allows you to adjust the zoom level.

"Previous page"

- goes to the previous page in the document.

"Next Page"

- goes to the next page in the document.

"Link back"

- will take you back to the page that you came from.
- only appears when you have previously followed a link.

"Go to page..."

- allows you to select a specific page.
- use the left/right buttons to select a page number.
- Select "**Ok**" to go to this page.

FILE SHARING

Your ARCHOS allows you to share files with other computers or ARCHOS devices on a WiFi network.

Important: please check the applicable laws in your country or jurisdiction to know what media files you are allowed to share or copy.

- First, you need to connect to a WiFi network. See *Connecting to the WiFi*. The device you want to share files with needs to be connected to the same WiFi network.
- To enable the file server directly, tap on “**Tools**” from the Home Screen, choose “**File Sharing**”, and tap on the “**Enable File Server**” button. While the file server is turned on, other functions of your device are disabled



- Your ARCHOS hard drive will then be accessible from your computer’s network neighborhood.
- If you want to set up your ARCHOS device to appear with a particular name in a particular workgroup on the network, you can change the following parameters (in the “**File Sharing**” screen):

Workgroup

- enter the name of the workgroup, using the virtual keyboard.
- see: *Using the Virtual Keyboard*.

Computer name

- enter the name for the ARCHOS device in the network, using the virtual keyboard (see *Using the Virtual Keyboard*).
- normally, you do not need to change this parameter unless more than one ARCHOS device of the same model name is in the workgroup.

Write access

- “**On**” will allow other computers to write to your ARCHOS hard drive.
- “**Off**” will prevent other computers from writing to your device.

Password

- only appears if the “**Write access**” parameter is set to “**On**”.
- Type in the password for other computers to be able to write to your hard drive (see *Using the Virtual Keyboard*).

Enable file server

- tap on this button to turn on the file server.

HELP

- Select this icon to display a list of useful PDF documents such as this full PDF manual, or other useful guides.
- The documents will be in the language that you selected in the “**Language and Region**” settings.
- Tap on a document to open it with the PDF reader. See *PDF Documents*.

10. ARCHOS PLUG-INS AND ADD-ONS



You can purchase the following add-ons or plug-ins to extend the functionality of your ARCHOS. They can be purchased from the ARCHOS web site (www.archos.com) or from the Media Club.

10.1 ARCHOS PLUG-INS

Go to www.archos.com or in the Media Club to check what plug-ins are available for your ARCHOS device and to learn how to install and use them.

10.2 ARCHOS ADD-ONS



When you connect one of the following add-ons, the “**Add-ons**” icon, on the Home screen, changes so that you can access the particular functions of the add-on. Read the manual of your add-on to learn how to use its functions.

DVR STATION



When connected to your ARCHOS and to your home entertainment system, the DVR Station will allow you to:

- schedule TV recordings easily via the ARCHOS TV Program Guide (EPG) (available for most countries)
- record video directly to your ARCHOS, from your cable box, satellite receiver, digital tuner, or most any standard video source
- connect to your ARCHOS a compatible USB device (Mass Storage or PTP): external hard drive, digital camera, etc.
- play video back to your TV
- charge your ARCHOS

DVR SNAP-ON

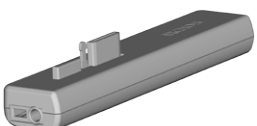

When connected to your ARCHOS, the DVR Snap-on will allow you to:

- record audio/video, directly on your ARCHOS, from most any standard audio/video source.

MINI DOCK



When connected to your ARCHOS, the Mini Dock will allow you to:

- display the image of the ARCHOS on your TV (S-Video and composite outputs).
- connect to your ARCHOS a compatible USB device (Mass Storage or PTP): external hard drive, digital camera, etc.
- charge your ARCHOS.

BATTERY DOCK



The battery dock is like the Mini Dock but also includes a battery to give your ARCHOS extra play time.

HELMET CAMCORDER



Mini video camera with headmount, remote control and microphone.

TV SNAP-ON



Digital TV receiver which allows you to watch and record digital TV (DVB-T) directly on your ARCHOS.

GPS CAR HOLDER



Transform your ARCHOS into a full-fledged car GPS (Nav Sat) navigation system. *For ARCHOS 5 only.*

FM REMOTE



FM remote control which allows you to listen to the radio directly on your ARCHOS. It also allows you to record from its built-in microphone.

TROUBLESHOOTING

RESETTING YOUR ARCHOS

- In the event that your ARCHOS freezes or does not respond anymore, try to reset it: press the  button for 15 seconds (the ARCHOS will shut down completely) and turn it on as usual.
- If this does not work, you can also press the "master reset" button located underneath the device as shown below. You can use the end of a paper clip to press the button in the hole.



ARCHOS 5 Slim



ARCHOS 5 Regular



ARCHOS 7

Note: Resetting your ARCHOS will not erase any data from your device. However some settings will be reset to their factory defaults.

SYSTEM RECOVERY

- If your ARCHOS does not respond correctly, or does not show certain songs or videos that you have copied to it, try using the "**Repair and Formatting Tools**" (see: *Customer Assistance Settings*).
 - If using the "**Repair and Formatting Tools**" did not solve your problem, you can try a system recovery. It allows you to repair the hard drive, format it, etc.
1. Press and hold the  button to turn on your device.
 2. When the screen turns on, immediately press and hold the Volume + button until the Recovery mode starts (white screen).

Since the system recovery mode is activated, the touchscreen is currently disabled. To move from an option to another, use the volume buttons. To validate an option, press the ON/OFF button.

The system recovery mode gives you several options:

"No"

- cancels the system recovery.

“Repair Disk”

- attempts to repair the file structure on the hard drive.
- does not erase any data.

“Format Disk”

- formats the hard drive.
- all data (music, photos, videos, etc.), licenses and settings are erased.

“Force Touchscreen Calibration”

- use this option if the touchscreen does not respond correctly and if you cannot access the touchscreen settings (see: *Screen Settings*).
- follow the instructions on the screen.

TOUCHSCREEN PROBLEMS

- If the touchscreen is not responding properly try to go to the **“Screen”** settings screen.
- Then use the **“Touch-Screen Calibration”** button, and follow the instructions on the screen.



If this does not work or if you cannot access the touchscreen settings, you can force the touchscreen calibration (see: System Recovery).

REPAIR AND FORMATTING TOOLS

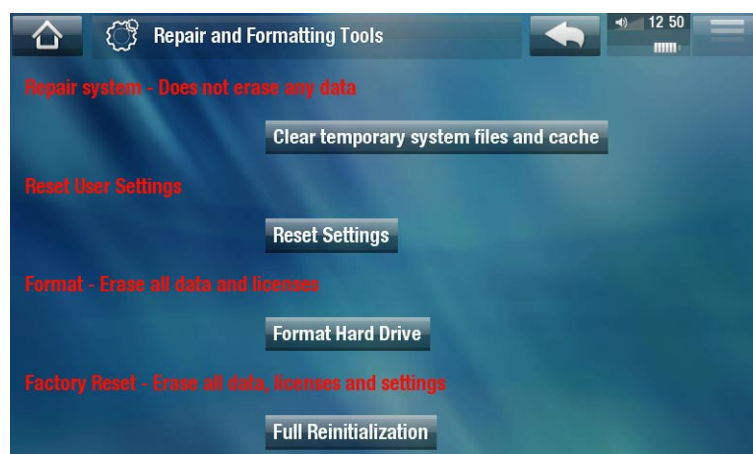

- to access the **“Repair and Formatting Tools”** settings screen: from the Home screen, tap on **“Tools”**, select **“Settings”** and choose **“Customer Assistance”**. Then use the **“Repair and Formatting Tools”** button. This screen allows you to do the following actions:
- **“Clear temporary system files and cache”** (does not erase any data)
- **“Reset Settings”** (resets all user settings)
- **“Format Hard Drive”** (erase all data, media files, and licenses)
- **“Full Reinitialization”** (erase all data, media files, licenses and settings)

In the event that your ARCHOS freezes or does not respond anymore, try to reset it (see: Resetting your ARCHOS).

If this does not work or if you cannot access the Repair and Formatting Tools, you can try a system recovery (see: System Recovery).

7 REPLACING THE BATTERY

The ARCHOS has a removable battery. You can purchase extra batteries from www.archos.com.

Caution: if the battery is incorrectly replaced or short-circuited, this could result in damage to the product and/or serious injuries to the user. Replace only with an original ARCHOS battery.

To replace the battery, follow these steps:

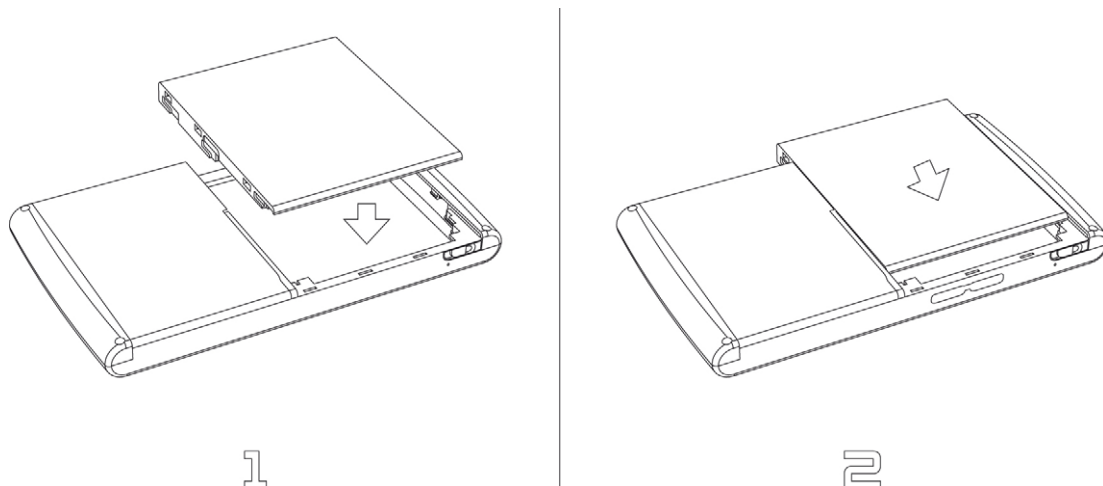

TECHNICAL SPECIFICATIONS

CAPACITY

- See *packaging*.

DISPLAY

- 7** - High resolution touch screen, 800x480 pixels, 7" TFT LCD, 16 million colors.
- 5** - High resolution touch screen, 800x480 pixels, 4.8" TFT LCD, 16 million colors.

VIDEO PLAYBACK**

- MPEG-4⁽²⁾ (ASP@L5 AVI, up to DVD resolution).
- WMV (MP@ML, up to DVD resolution) including WMV protected files.
- M-JPEG (Motion JPEG Video) in QVGA resolution.
- With optional plug-in (downloadable from your tablet or on www.archos.com):
 - HiDef: MPEG-4 (ASP 720p) & WMV HD (MP 720p).
 - Video podcast: H.264 up to DVD resolution with AAC.
 - Cinema: MPEG-2 MP@ML up to 10 Mbps (up to DVD resolution) and AC3 stereo sound (5.1).

AUDIO PLAYBACK**

- Stereo MP3 decoding @ 30-320 Kbits/s CBR & VBR, WMA, Protected WMA, WMA pro 5.1, WAV (PCM/ADPCM).
- With optional software plug-ins (downloadable from your tablet or on www.archos.com):
 - AAC⁽³⁾ + stereo audio files.
 - AC3 stereo audio and 5.1 sound files (via SPDIF output of DVR Station).

PHOTO VIEWER***

- JPEG, PNG, BMP & GIF.

PDF VIEWER

- Reads PDF documents. May not implement all PDF features.

VIDEO RECORDING⁽⁴⁾

- Via the optional DVR Station/ DVR Snap-on: Records NTSC/PAL/SECAM in MPEG-4 AVI format with ADPCM stereo sound, VGA resolution (640 x 480) @ 30 or 25 f/s.

AUDIO RECORDING

- Via the optional DVR Station/ DVR Snap-on: Stereo line-in, WAV (IMA ADPCM or PCM) format.
- Voice recording via the optional FM remote and its built-in microphone in WAV format (IMA ADPCM).

EMAIL CLIENT

- Compatible with email accounts supporting POP3 or IMAP services
- Import/export of vCard contacts

INTERFACES

- USB 2.0 High-Speed Device (compatible USB 1.1): Mass Storage Class (MSC) and Media Transport Protocol (MTP).
- USB 2.0 Host: Mass Storage Class (MSC) and Picture Transfer Protocol (PTP) with optional Mini Dock, Battery Dock and DVR Station.

CONNECTIONS

ARCHOS 5:

- WiFi (802.11 b/g) connection. Free Web Browser (Opera® Web browser with Adobe Flash® 9 video support) upon registration
- 3.5 mm stereo mini jack for headphones
- Add-on connectors to connect to the DVR Station and other ARCHOS add-ons

ARCHOS 7:

- WiFi (802.11 b/g) connection. Free Web Browser (Opera® Web browser with Adobe Flash® 9 video support) upon registration
- 3.5 mm stereo mini jack for headphones and audio output
- DC-in for power adapter
- Add-on connectors to connect DVR Station and other ARCHOS add-ons

MISCELLANEOUS

- A single built-in speaker (ARCHOS 5) or two built-in speakers (ARCHOS 7)
- Built-in leg stand

POWER SOURCE

ARCHOS 5:

- Internal: Lithium Polymer battery
- Device charges via computer USB port
- External: Power adapter/charger (via optional add-on)

ARCHOS 7:

- Internal: Removable lithium Polymer battery
- Power adapter /charger ARCHOS

SCALABILITY

- Device automatically downloads latest firmware updates when the WiFi connection is activated
- Updates can also be downloaded directly on www.archos.com

PACKAGE INCLUDES

ARCHOS 5:

- ARCHOS 5, headphones, ARCHOS USB cable, DVR Station adapter, screen cleaning cloth, Quick Start Guide (QSG), legal and safety notice.

ARCHOS 7:

- ARCHOS 7, headphones, ARCHOS USB cable, DVR Station adapter, power adapter/charger, screen cleaning cloth, Quick Start Guide (QSG), legal and safety notice.

COMPUTER SYSTEM REQUIREMENTS

- Microsoft® Windows® Vista, XP, ME, 2000 or higher
- MAC OS X and Linux (with Mass Storage Device Support). Check your operating system compatibility.
- USB 2.0 interface.

*** Certain bitrates, resolutions, and/or file variations may not be compatible.*

**** Certain resolutions and file sizes may not be compatible.*

(2) MPEG-4 ASP@L5 AVI (MPEG-4: ISO standard by Moving Picture Experts Group; AVI: audio/video file container by Microsoft) without GMC and Quarter Pixel.

(3) Does not read AAC protected files.

(4) External video output disabled for protected contents.

LCD PIXEL POLICY

The LCD screen on your ARCHOS unit has been manufactured to rigorous standards to provide a high quality viewing experience. Nevertheless, your LCD screen may have slight imperfections. This is not particular to the ARCHOS screen, but to all devices which have LCD screens regardless of the original manufacturer of the LCD. Each product vendor guarantees that his screen will contain no more than a certain number of defective pixels. Each screen pixel contains three dot elements (Red, Blue, and Green). One or all of the dots in a given pixel may be stuck on or stuck off. A single dot stuck off is the least noticeable. All three dots of a pixel stuck on is the most noticeable.

ARCHOS guarantees that this device's screen will have no more than 3 defective pixels (regardless if these pixels have one or more defective dots). This means that during the period of guarantee for your country or jurisdiction, if the screen on your product has four or more defective pixels, ARCHOS will repair or replace your product at its cost. Thus, three or less defective pixels is not grounds for replacement or repair of the product.

TECHNICAL SUPPORT INFORMATION

Need Help? You can find the information you need:

- On our Website: see the frequently asked questions section on www.archos.com/faq
- By asking our technical support team: visit www.archos.com/support for e-mail support.
- U.S. & Canada: Call 877-300-8879 (toll free).

All brands and product names are registered trademarks and the property of their respective owners. Windows Media® and Windows® are trademarks or registered trademarks of Microsoft Corporation in the United States and/or other countries. Specifications are subject to change without notice. Errors or omissions excepted. Images and illustrations may not always match contents. All the information contained in this manual was correct at the time of publication.

COPYRIGHT ARCHOS © 2008. All rights reserved.