

# VIBRATING WIRE STRAIN GAUGES

I  
N  
S  
T  
R  
U  
C  
T  
I  
O  
N  
  
M  
A  
N  
U  
A  
L



## **CONTENTS**

### **1.0 INTRODUCTION**

- 1.1 General Description
- 1.2 Theory of operation

### **2.0 CONFORMITY**

### **3.0 DELIVERY**

- 3.1 Packaging
- 3.2 Handling
- 3.3 Inspection
- 3.4 Storage

### **4.0 INSTALLATION**

- 4.1 Preparation for Installation
- 4.2 Embedment Strain Gauges
- 4.3 Surface Mounted Strain Gauges
- 4.4 Sister Bar Strain Gauges

### **5.0 DATA HANDLING**

- 5.1 Monitoring the Strain Gauge Readings
- 5.2 Data reduction

### **6.0 MAINTENANCE**

### **7.0 TROUBLESHOOTING**

### **8.0 SPECIFICATION**

### **9.0 SPARE PARTS**

### **10.0 RETURN OF GOODS**

### **11.0 LIMITED WARRANTY**

### **12.0 DATASHEETS**

## 1.0 INTRODUCTION

This manual is intended for all users of Vibrating Wire Strain Gauges manufactured by Geosense and provides information on their installation, operation and maintenance.



**It is VITAL that personnel responsible for the installation and use of these Strain Gauges, READS and UNDERSTANDS this manual, prior to working with the equipment.**



### 1.1 General Description

**Geosense VW Strain Gauges** are environmentally sealed sensors that are used to register micro changes in length. Since strain is described as a change in length per unit length, these sensors detect small changes in their length and, by simple calculation, their output can then be converted to strain.

Strain Gauges can be installed or included in many types of monitoring regime and can be linked to various types of readout equipment.

The primary uses for Strain Gauges are the measurement of Load and Bending in steel, concrete and composite structural members, with applications such as, but not limited to :-

- Piled foundations ( concrete and / or steel )
- Retaining Walls
- Floor Slabs
- Columns and Beams
- Mass concrete dams
- Falsework / Formwork
- Strutting and Temporary Works
- Bridgeworks

Particular features of the Geosense Vibrating Wire Strain Gauges are:-

- Reliable long term performance.
- Rugged, suitable for demanding environments.
- High accuracy.
- Insensitive to long cable lengths.

The Strain gauges are based upon the 'industry standard' Vibrating Wire technology. When electronically excited, the sensors produces an output signal in the form of an alternating current. The frequency of the alternating current can then be readily converted to a change in strain.

Frequency signals are particularly suitable for the demanding environment of civil engineering applications, since the signals are capable of long transmission distances

*(Continued on page 4)*

without degradation. They are also somewhat tolerant of damp wiring conditions and resistant to interference from external electrical noise.

Geosense VW Strain Gauges are supplied in various configurations to suit varying installation environments and techniques.

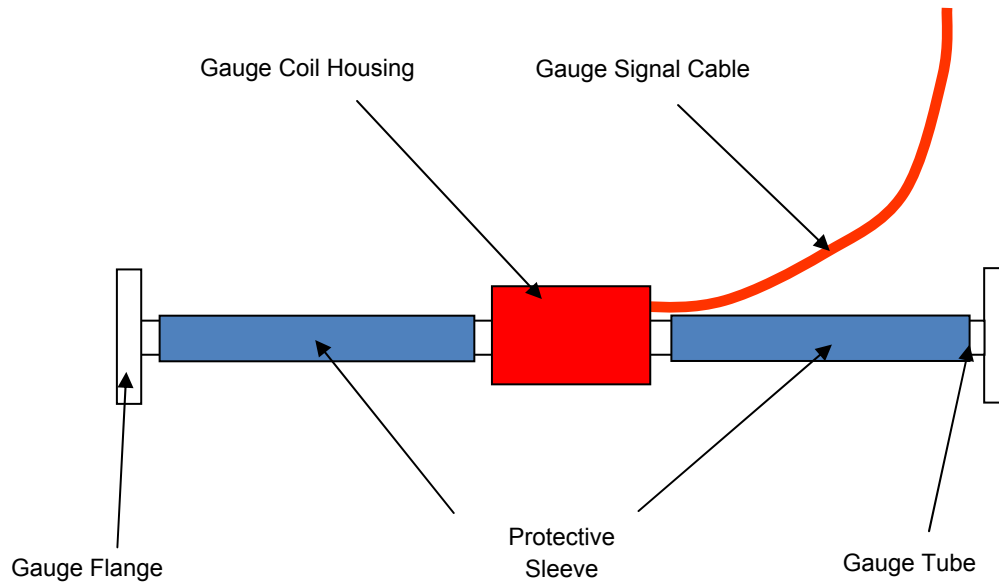

Figure 1. Geosense Embedment Strain Gauge

## 1.2 Theory of Operation

Strain Gauges consist of a tensioned steel wire anchored at both ends into flanges. The wire is enclosed in a stainless steel tube. The internal parts of all Geosense strain gauges are essentially identical, only the body geometry and the inclusion of additional springs change within the units with longer gauge lengths. The configuration of the sensing elements may also vary slightly from model to model. An example of the embedment strain gauge configuration is provided in Figure 1.

Electromagnetic coils are located within the body close to the axis of the wire. When a brief voltage excitation, or swept frequency excitation is applied to the coils, a magnetic field is induced causing the wire to oscillate at its' resonant frequency. The wire continues to oscillate for a short period through the 'field' of the permanent magnet, thus generating an alternating current (sinusoidal) output. The frequency of this current output is detected and processed by a vibrating wire readout unit, or by a data logger equipped with a vibrating wire interface, where it can be converted into 'Engineering' units of Strain.

Forces within the structural element onto, or in, which the gauge is fixed, cause the length of the gauge to change. This causes a change in the tension of the wire within the gauge. It is the tension in the wire that produces the value that can be converted to strain.

A change in length of the wire changes the tension of the wire which results in a change in resonant frequency of oscillation of the wire. The change in the square of

*(Continued on page 5)*

frequency of oscillation is directly proportional to the change in strain in the structural element.

For further information see Section 5 - Data Handling.

## 2.0 CONFORMITY

### Geosense Ltd

Nova House  
Rougham Industrial Estate  
Rougham, Bury St Edmunds  
Suffolk , IP30 9ND  
United Kingdom



Tel: +44 (0)1359 270457 Fax: +44 (0)1359 272860  
Email: info@geosense.co.uk, Web: www.geosense.co.uk

## Declaration of Conformity

We Geosense Ltd at above address declare under our sole responsibility that the product detailed below to which this declaration relates complies with protection requirements of the following harmonized EU Directives,

Low Voltage Directive 73/23/EEC (as amended by 93/68/EEC)  
The Electromagnetic Compatibility Directive 2004/108/EC  
The Construction Products Directive 89/106/EEC

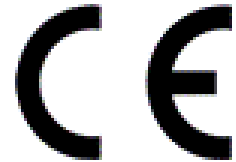

<i>Equipment description</i>	<b>Vibrating Wire Strain gauges</b>
<i>Make/Brand</i>	<b>Geosense</b>
<i>Model Numbers</i>	VWS-2000, VWS-2010, VWS-2020, VWS-2025, VWS-2026 VWS-2100, VWS-2120, VWS-2125

This equipment has been designed and manufactured with reference to EN 61326-1 and EN 61010.

All mechanical drawings used in the production of this equipment are based upon BS 8888 and all electrical/electronic drawings are based upon BS 3939.

***A technical file for this equipment is retained at the above address.***

Martin Clegg  
**Director**

A handwritten signature in black ink that reads "Martin Clegg".

### 3.0 DELIVERY

This section should be read by all users of Vibrating Wire Strain Gauges manufactured by Geosense.

### 3.1 Packaging

VW Strain Gauges are packed for transportation to site. Packaging is suitably robust to allow normal handling by transportation companies. However, inappropriate handling techniques may cause damage to the packaging and the enclosed equipment. The packaging should be carefully inspected upon delivery and any damage **MUST** be reported to both the transportation company and Geosense.

### 3.2 Handling

Whilst they are a robust devices, VW Strain Gauges are precision measuring devices. They and their associated equipment should always be handled with care during transportation, storage and installation.

Once the shipment has been checked ( see below ), it is recommended that Strain Gauges remain in their original packaging for storage or transportation.

Cable should be handled with care. Do not allow it to be damaged by sharp edges, rocks for example, and do not exert force on the cable as this may damage the internal conductors and render the instrument useless.

### 3.3 Inspection

It is vital to check all the equipment in the shipment as soon as possible after taking delivery and well before installation is to be carried out. Check that all the components that are detailed on the documents are included in the shipment. Check that the equipment has not been physically damaged.

Geosense Vibrating Wire Strain Gauges are supplied with generic calibration factors (sometimes called 'Gauge Factor' ), and Batch factors that are calculated for each batch of strain gauges. Each delivery will include details of the calibration factors that apply to the gauges supplied.

The integrity of Embedment type Strain Gauges can be checked easily by connecting the exposed ends of their connecting wires to a suitable Vibrating Wire Readout.

Prior to carrying out this 'Function' CHECK, ensure that the strain gauges have been stored in a reasonably stable temperature for at least 2 hours.

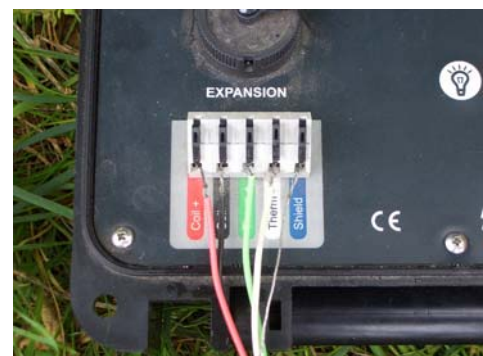

(Continued on page 8)

(Continued from page 7)

The displayed values of the gauge reading and temperature, should be reasonably stable ( +/- 3 full digits ) for this check.

Where possible, select the audio function on the readout and listen to the 'ring' of the gauge. The 'ring' should be clear and undistorted.

For Surface Mounted Strain Gauges it is necessary to slightly tension the inner wire manually so that a reading can be generated. Take care and DO NOT TWIST the ends of the surface mounted gauges as this will twist the inner wire, thereby reducing the linearity of the output and rendering the calibration useless.

If components are missing or damaged, contact the delivery company, the supplier and / or Geosense.



Typical readout panel and connections

### 3.4 Storage

All equipment should be stored in an environment that is protected from direct sunlight.

Though robust, the gauge tubes are very sensitive to even slight bending so great care must be taken to store them carefully.

It recommended that cables be stored in a dry environment to prevent moisture migrating along the cable in the unlikely event of prolonged submersion of exposed conductors.

Storage areas should be free from rodents as they have been known to damage connecting cables.

No other special requirements are needed for medium or long-term storage although temperature limits should be considered when storing or transporting associated components, such as readout equipment.



## 4.0 INSTALLATION

The following sections describe some typical installation procedures for Geosense strain gauges.

This section of the manual is intended for all users of Vibrating Wire Strain Gauges manufactured by Geosense and is intended to provide guidance with respect to their installation.

It must be remembered that no two installations will be the same and it is inevitable that some 'fine tuning' of the following procedures will be required to suit specific site conditions.



**It is VITAL that personnel responsible for the installation and use of the Strain Gauges READS and UNDERSTANDS the manual, prior to working with the equipment.**



\*\*\*\*\*

**As stated before, it is vital to check all the equipment in the shipment soon after taking delivery and well before installation is to be carried out. Check that all components that are detailed on the shipping documents are included.**

### 4.1 Preparation for Installation

Each gauge should be assigned a unique identifying code or mark ( in addition to the fitted serial number marks ) for any position in a particular pile ( remembering to ensure that the gauges fitted with the longest cables are identified for most distant installation ). Ensure there will be enough cable to route it to the intended readout / monitoring location.

The elevation / location of the Strain Gauge installations should be identified by the Engineer responsible for the interpretation of the data, or as detailed on contract drawing or in the specification. The instrument locations must be marked using paint or other suitable material. It is important to consider the protection of each gauge when selecting a suitable location. It must be remembered that gauges must be protected from damage as they are sensitive measuring instruments. In some locations it will be necessary to install protective covers.

The function of embedment gauges should be checked prior to installation as described in section 3.3. Check each gauge using a readout with the audio function switched on. A clear 'ring' should be produced from the gauge. ( for a surface mounted gauge this would only be true when the wire is manually tensioned ).

Illustrations provided within this manual use two different models of portable readout ( one no longer available ). In general, any Vibrating Wire readout device could be used to excite and interrogate the Vibrating Wire Strain Gauges manufactured by Geosense.

## 4.2 Embedment Strain Gauges - VWS 2100 Series

The following sections describe typical installation procedures for applications of Geosense Vibrating Wire Embedment Strain gauges. They are provided as examples of typical installations and are intended as guides to enable users to prepare installation procedures suited to their particular application.

Generally, embedment strain gauges are supported in their intended locations within a concrete element by attaching them to mounting bars fixed onto either the reinforcement cage or the formwork. Their function is to provide a stable support for the gauges whilst the concrete is placed and to isolate the gauges from any main reinforcing bars. Strain gauge mounting bars need to be 10 or 12 mm in diameter and long enough to allow for fixing to the main bars ( see photographs later in this section ). Care should be taken to reduce steel ‘congestion’ that may cause voids in the concrete close to the gauges.

The Strain Gauge tubes are supplied fitted with polyolefin sleeves. This is to provide a degree of protection to the gauge tube at the fixing point.

Wrap the supporting bar with PVC or paper tape at the point where the gauge will come into contact with it. 6 or 8 turns will normally be sufficient. This will provide slight isolation from the bars but will also provide a degree of grip between the gauge tube and the mounting bar.



Fig 2. 150mm Embedment Strain Gauge

### 4.2.1 Embedment Strain Gauges in Bored Cast In-Situ Piles

Embedment gauges in piles are usually installed at a number of levels over the pile length, depending upon the Engineers’ requirements, and in arrays of 3 or, preferably, 4 gauges per level. Although not essential, it is good practice to install the gauges in the same orientation at each level. This will help with interpretation of any bending that may occur.

Select the gauges with appropriate lengths of cable so that there is no need to join the cables in the pile. Where joints can’t be avoided, they must be formed using an epoxy or similar waterproof sealing material, particularly where long term monitoring is required. Connection of the conductors should be made using either a mechanical coupler ( crimp or screw ) or a soldered joint.



Mark both ends of the cable with a suitable unique colour code or numbering system. The marks must be robust as the cables may be exposed to abrasion and concrete during their installation. Each gauge in a single pile must have a unique identification mark. The location of the marks will be recorded for future reference.

Identify a Primary Main Bar and mark it with tape or paint at intervals along its entire length. This will help align and position the gauges over the length of the pile and between successive cage sections. ( in the photograph, the bar ringed in red is marked as the primary bar and the green rings highlight the colour code marks for each gauge position )

Determine the correct elevation for the strain gauge arrays and mark the position on the main bars. Take care when marking the positions where cages are to be installed in multiple sections, allow for lapping of the main bars.

Place the gage mounting bars onto the main bars to assess the best position for their installation. Note the tape on the mounting bars where the gauge will be fixed.

The gauge will be mounted BETWEEN the main bars so that it is best protected from damage from inside and outside the cage.

Offer up the gauge under the mounting bars to check that the gauge flanges will not conflict with any of the steel bars.





When the position of the mounting bars has been finalised, fix them firmly into position on the main bars using steel tying wire.



Support the gauge in the position tested previously and fix it to the support bars using good quality NYLON cable ties. Fix only one at each end ( as shown ) and finalise the position of the gauge so that it is parallel to the main bars.



Fit two more cable ties to fix the gauge in position. form a cross over the gauge



Cut the tails off the cable ties.



Route the cable along the side of the main bar, inside the external helical 'shear' bars but outside the inner fabrication support bars. The aim is provide a cable route with the 'lowest possible risk' of damage.



Fix the cable to the main bars. First form a small loop in the cable, near to the gauge ( see photograph ) and fix it the bar, taking care that the loop does not turn into or out of the cage.



Then tension and tie the cable from the gauge position to the end of the cage, fixing at approximately 1m intervals.

Connect the readout to the free end of the gauge wire and check that the gauge is producing a clear ring and a stable reading ( see section 3.3 for information and the readout instructions ).





When all the gauges and cables have been installed and the function of the gauges has been checked, the cables should be bundled together and protected from both concrete and damage.

Care must be taken when lifting the cage, so as to avoid damaging the cables.



As the cage is lowered into the pile shaft, spacers are fitted to the bars to maintain the cage in the centre. These spacers are positioned above and below the instrumented levels to prevent the gauges or their mounting bars fouling on the pile casing or shaft wall. The spacers should be offset around the cage so that in the event that one breaks off it will not damage the gauges.



When the cage is fully installed and prior to concreting, another full set of gauge readings can be recorded to verify the installed gauge integrity. This may not be possible if the cables are bundled and protected ( as in this picture )



Steps must be taken to ensure that the workers who are carrying out the concreting operations know that the cage has instruments inside it. They should be supervised so as to reduce the risk of tremie pipes, etc, damaging the gauges or their cables.



A centralising system / device should be used to minimise the risk of damage to the gauges if the Tremie pipe moves during placing the concrete. Efforts must be taken to minimise the movement of the Tremie during this operation.



Where a pile loading test is to be carried out, it is recommended that the pile cap be cast as in integral part of the pile. Gauge cables must be passed through the walls of the pile cap formwork prior to finalising the upper surface of the cap ( as shown here ). This will help to minimise the risk of damage to the cables. The cables should be protected after the pile cap has been completed.



When placing of the concrete has been completed, another full set of gauge readings should be recorded to confirm the gauge integrities.

A further set of readings should be recorded after the concrete has cured. If the cables are subsequently damaged, these readings may help to identity and match broken cables.





## 4.2.2 Embedment Strain Gauges in Wall and Slabs

Embedment gauges in wall panels and floor slabs are usually installed in pairs. One gauge would be installed close to one face and the other gauge close to the other face. This enables the detection of bending of the elements together with any axial strain changes.

As with the gauges in the pile cage ( described in Section 4.2.1 ) the embedment strain gauges should be fixed to support bars mounted between the main bars.

Below are some photographs and details of a typical diaphragm wall installation.

Once the installation positions have been identified within the completed cage, prepare the support bars to bridge the gaps between the main bars.



Using steel wire, fix one support bar into the cage at the required location. Prior to fixing the other support bar, offer it and the gauge into position to check that the configuration is as shown in this photograph. The flange must not come into contact with any steel bars and should be free to allow the flow of concrete around it. Since the gauge will always be installed between the main bars it is suggested that the support bars be fixed on to the inside of the main bars ( as shown here ).

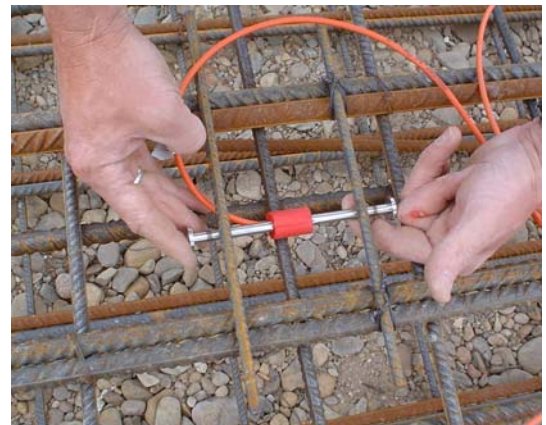

Wrap tape around the gauge tube to provide a cushion between the bar and the gauge tube. Some tape can also be added to the support bars.



Using Nylon cable ties, fix the strain gauges onto the support bars, crossing the ties to provide a firm support. Do not over tighten the ties.

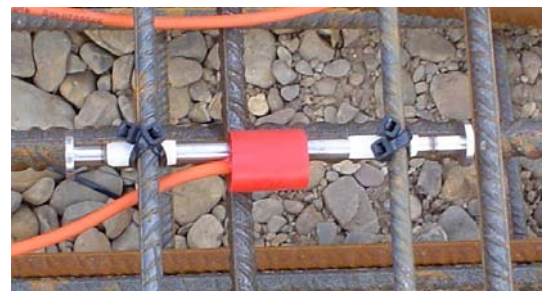



Repeat the installation of the gauge in the other side of the cage.

Some instrumentation layouts ( particularly within walls ) call for a third gauge to be installed mid way through its section. This could only be applied when there is no risk that the middle gauge would be damaged by tremie pipes or vibrating compaction equipment.

If this was required, a pair of support bars would be fixed inside the cage, running from one side to the other. The gauges would then be mounted onto these bars at the required points across the wall or floor section.

Cables are routed up inside the cages, in positions that reduce the risk of accidental damage to them.

If diaphragm wall cages are to be installed in two sections, gauge cables in the lower cage would be looped at the top of the cage ( as shown here ) and then during the installation they would be routed up inside and fixed to the upper cage.

Particular care must be taken with the cables. They are the most vulnerable element of the installation.

Once the gauges are in place and the cables secured, check the function of the gauges using a portable readout device. Note the gauge serial number, ( cable colour code if applied ) and reading, for future reference.



If gauges have to be fixed close to construction joints, they are best installed once the joint has been completed.

Loose cables must be gathered to a safe and convenient location as the cage is lowered.

Spacer blocks are added to the outside of cages to support and / or centralise them. Where blocks are added they must be on either side of the gauges so that, in the event that a spacer is dislodged, it does not damage the gauge as it falls.

Once again, when the installation is complete, check the function of the gauges. A further set of readings should be recorded when the concrete has cured. If the cables are subsequently damaged, these readings may help to identify and match broken cables.



#### 4.2.2 Embedment Strain Gauges in Beams & Columns

Embedment gauges are commonly installed within beams and columns to monitor their performance during testing, work loading and over the long term. As with the configuration of all gauge arrays it is important to engage with the design Engineer to ensure that the instruments will be best placed to detect the changes that the Engineer requires to be quantified.

In general, strain gauges are installed in pairs. By doing so, both compression or tension and bending can be quantified. For beams or columns, however, it is preferable to install gauges in groups of four.

If loading is the primary concern, strain gauged sections should be selected at points where bending is at its minimum. Gauges should be installed in matching pairs from the centre of the section (in other words equally distant and opposite over centre of the cross-section). Examples of such installations are provided in the sketches below.

Figure a shows a typical arrangement of embedment strain gauges for measuring the load and bending in a concrete beam. Two gauges installed in the compression zone and two in the tension zone. ( The red dots indicating the gauges positions ).

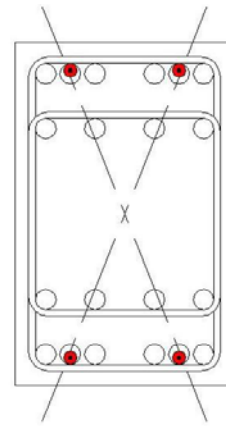

Fig. a

Figure b shows a typical arrangement for embedment strain gauges within a column

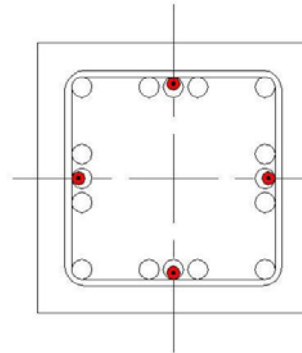

Fig. b

Figure c shows a horizontal section through a concrete wall in which strain gauges are positioned to measure bending of the wall.

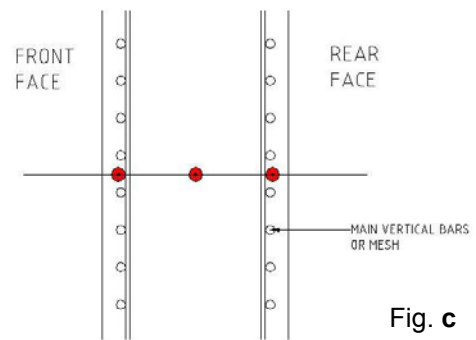

Fig. c

Concrete elements that include strain gauges can be either pre-cast or cast in-situ.

### 4.2.3 Other Embedment Strain Gauges

Embedment gauges can also be supplied in 300mm long and 75mm long formats. Essentially, the installation procedures will be similar but adjustment will have to be made for scale and the methods of fixing.

Typically the 75mm long gauge is used in confined installations or where grout will be the surrounding medium.

The longer 300mm gauge is even more robust than the 150mm version and is often used in mass concrete installations. These units can also be used in pre-fabricated arrays for roller compacted concrete ( RCC ) and mass concrete structures.



Fig 4. 75mm Embedment Strain Gauge



Fig 5. 250 mm Embedment Strain Gauge



### 4.3 Surface Mounted Strain Gauges - VWS-2000 Series

The following sections describe typical installation procedures for applications of Geosense Vibrating Wire Surface Mounted Strain Gauges.

The installation of Surface Mounted gauges is often a little more complex than for the Embedment gauges but their future monitoring life can be more easily controlled. Protection of the gauges is obviously much more critical with surface mounted gauges, than embedded gauges.

Geosense Surface Mounted Strain Gauges are available with either a 75mm or 150mm gauge length.

As no two installations are the same, the installation details provided below are indicative and intended as a basis for preparing a method statement for a particular installation.

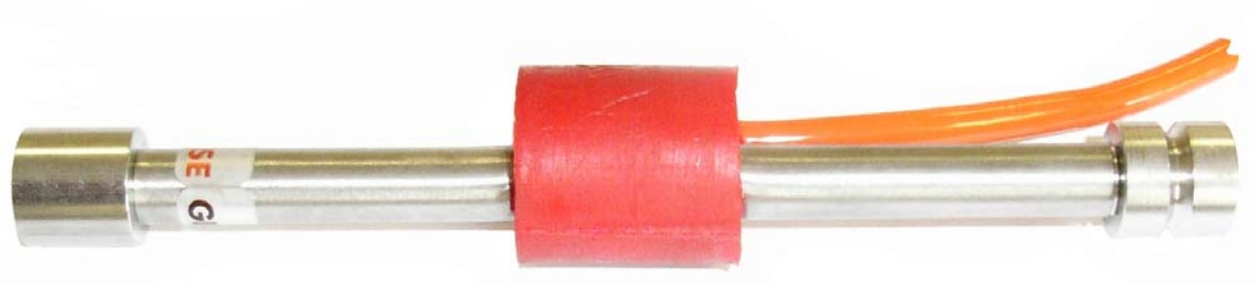
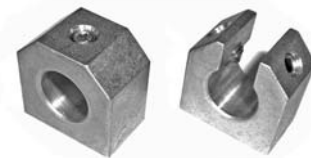

Fig 3. 150mm Surface Mounted Strain Gauge

#### 4.3.1 150mm Surface Mounted Strain Gauges VWS 2000 Series

The 150mm Surface Mounted Strain Gauge is supplied with mounting blocks that are suited to the intended installation type.

**Weldable** end blocks are used where the surface onto which the gauge is to be fixed is steel and suitable for welding.



Weldable end blocks

**Screw and/or Bonding** end blocks are used where the gauge is to be fixed to concrete, brick or masonry surface with minimum penetration or where the blocks are to be bonded to a surface. ( often it is not possible to drill into sensitive surfaces )



Screw and / or Bonding end blocks

**Resin Anchor** end blocks are used for concrete, brick, masonry or rock where larger holes are permitted or where deep anchorage is necessary.



Resin Anchor end blocks

Components required for fitting a Vibrating Wire Surface Mounted Strain Gauge. A pair of End Blocks (weldable in this case) , Setting Bar, Setting Plate and Strain Gauge.

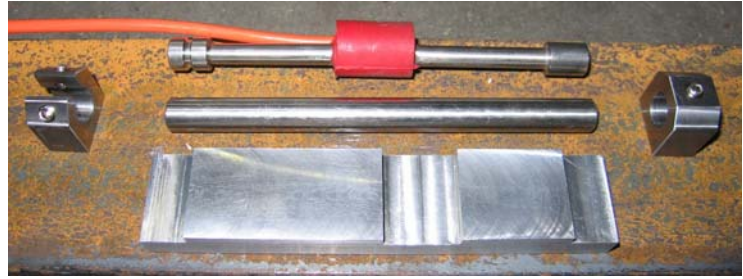

All installations will require a 4mm Allen Key ( hexagonal wrench ) and a Vibrating Wire readout.

Other tools required will vary with type of end blocks selected.

Protective equipment may also be required and must be provided for site operatives

For the Bonded end blocks and the Anchor end blocks the choice of Bonding agent is critical. The material MUST NOT CREEP once it has cured. Any slight creep will result in changes in the gauge readings that will negate the value of the data.

Chemical Metal by 'Plastic Padding' is know for its resistance to creep and has been used for many years.

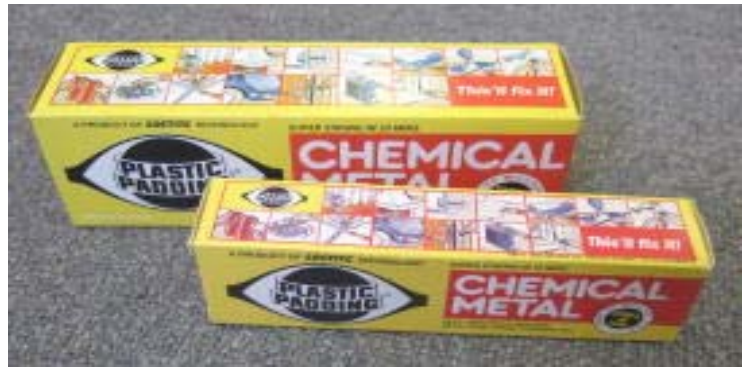

#### 4.3.1.1 150mm Surface Mounted Strain Gauges on Steel

Where a project requires the installation of strain gauges onto structural or temporary steelwork, selection of the location is critical and is dependent upon the purpose of the instruments.

Where gauges are intended to detect changes of load in a member they must be positioned to best detect the changes in strain and must accommodate any bending that may be occurring. Load is calculated using the cross-sectional area, the 'Youngs Modulus' of the steel strain changes. Pairs of gauges are usually installed as far as possible from the axis of the steel member and opposite across the axis so as to accurately detect the load, together with any differential loading ( bending ).

If, for example, the load in the steel column in Figure B was perfectly axial, only one gauge would be required to measure changes in the load. However, as there is always a risk even slight eccentric loading it is necessary to use a minimum of 2 gauges on the flanges ( Fig B / 1 & 2 ). This arrangement will measure strain changes in the flanges and could detect any differential loading ( bending ) on the A axis. The average of the readings would provide a reasonable basis for a load calculation. An additional pair of gauges ( Fig B / 3 & 4 ) could be added to the web to provide a further average and check the web loading. In this configuration there is no accommodation of bending on the B axis which may lead to inaccurate load calculations.

In Figure C, the four gauges positions would allow the accurate measurement of axial loading and differential loading ( bending ). Gauges 5 & 6 are best placed for convenient installation **and** load detection but may be vulnerable to damage. Gauges 7 & 8 are in the best position for a compromise between data quality and gauge security.

The best overall arrangement in areas where the gauges **will not** be at risk of damage is for an installation to consist of 4 gauges installed as gauges 5 & 6 are installed, for each measuring point. This would combine convenient installation with accurate measurement of load and bending. It may not be possible in all applications.

The best overall arrangement in areas where the gauges **may be** at risk of damage is for an installation to consist of 4 gauges installed as gauges 7 & 8 are installed, for each measuring point. This would enable accurate measurement of load and bending. This too may not be possible in all applications.

In many cases the final gauge layout will be compromise but it must be remembered that gauges must be installed in pairs in a line over the 'centre of section' and equally distant from the 'centre of section'

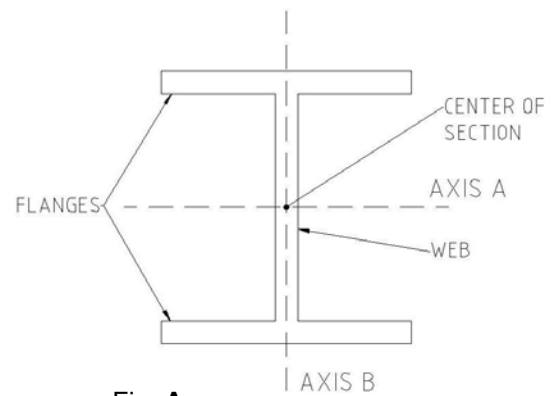

Fig. A

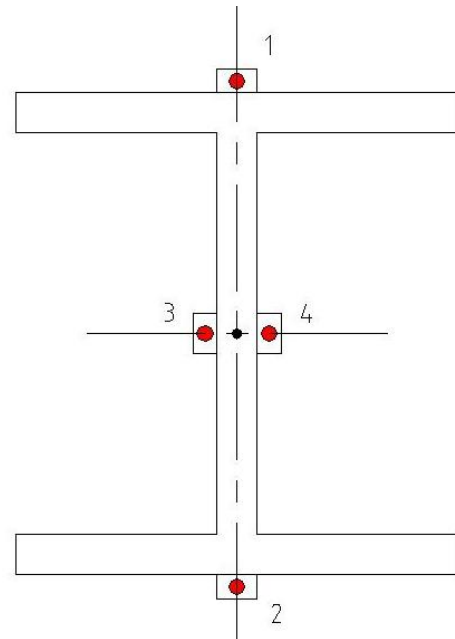

Fig. B

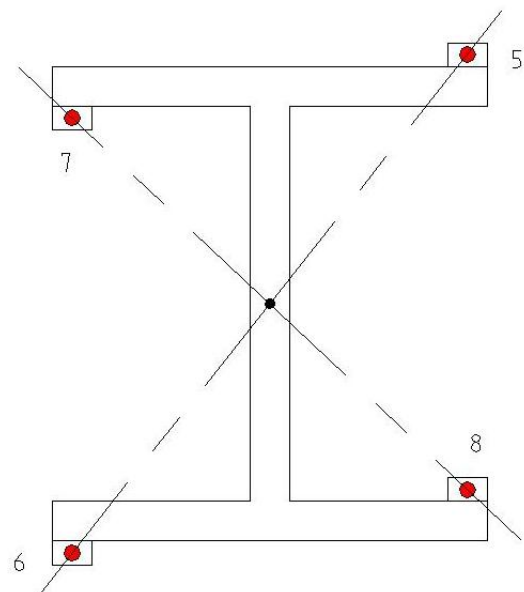

Fig. C

Protection of gauges is also very important. In most applications, surface gauges need protection from physical damage and in some application they need to be protected from the effects of temperature changes.

Physical protection is best achieved using a steel cover or box over the gauge. These would normally be bolted, screwed or otherwise secured onto the element to protect the gauge but without influencing the performance of the gauge.

Changes in air temperature around the gauge will significantly affect the output from the gauge. The steel member and the gauges will have similar responses to temperature changes as they will have similar coefficients of thermal expansion. However, since the gauge is of a much smaller mass, it will respond much more quickly, thereby setting up differential strains between the steel member and the gauge. Efforts must be made to minimise the differential effects.

One way to minimise the effects is to provide each gauge with a thermal cover. Usually a thermal cover would comprise a stiff foam box that would be bonded to the over the gauge ( not to the gauge ). A steel box could also be fitted with internal foam insulation to help reduce the effects.

It must be emphasised that the steel element to which the gauge is fixed will also be affected by thermal changes.

The three figures on the right show common arrangements of strain gauges in or on circular structural elements.

Figure 1 shows an arrangement where two gauges are used to measure bending of a circular pipe or pile in one axis. The two gauges are fixed on the axis of the element passing through its centre. The axis must correspond to the direction of maximum bending.

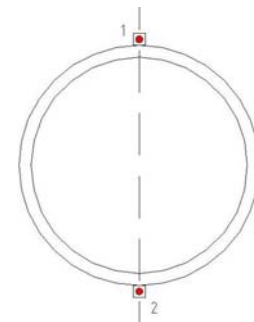

Fig. 1

Figure 2 shows a section with three gauges spaced equally around the circumference of a circular structural element. This arrangement would enable the calculation of both load and bending on both axes. It will also enable the calculation of the direction of maximum bending or eccentric loading. If one of the gauges were to fail for any reason, the calculation of load would be impossible.

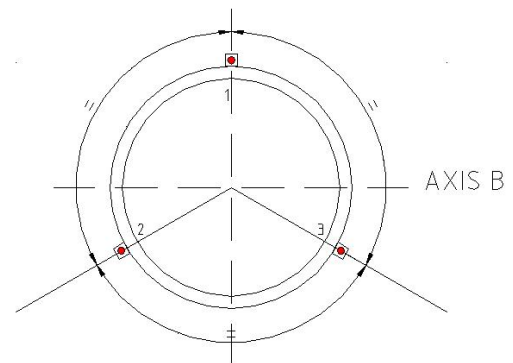

Fig. 2

Figure 3 shows an arrangement with two gauges installed on each major axis. This is the preferred arrangement since it would enable the calculation of bending and total load even if one of the strain gauges had failed. It will also provide a better level of data security with respect to the performance of the concrete or steel element around its circumference.

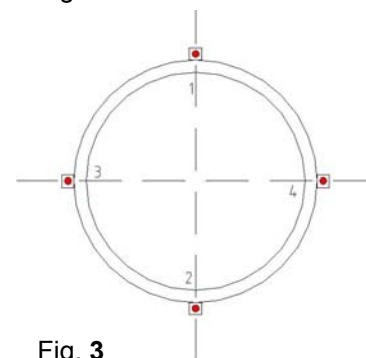

Fig. 3



### Fixing of 150mm Surface Mounted Strain Gauges on a Steel Tube.

Fix one mounting block to the end of the stainless steel setting bar so that the bar is flush with the edge of the block, gently tighten the locating grub screw to just hold the block in place.



Use the spacer plate to set the other end block at the other end of the bar. Prior to tightening the second block onto the bar, place the assembly onto a flat surface to ensure that the end blocks sit flat against the surface. Gently tighten both the grub screws to hold the block in place on the bar.



Select and mark a suitably flat position for the gauge on the steel element.





Weld one of the blocks into place, holding the bar to maintain the blocks in position.

It is not necessary to apply too much weld as the load transmitted by the gauge is minimal. These blocks are only intended to support and connect the gauge to the steel member.



Initially weld a corner of the end block onto the steel element.



Weld all four corners of the blocks to finalise the fixing.



Loosen the grub screws once the welding has been completed. Take care when removing the bar as it will be HOT.



To fit the gauge to the blocks, first slot the shaft of the gauge into the slotted block.

Then insert the end of the gauge without the groove into the full block.

At the same time, align the other end of the gauge so that it passes into the other end block.

Using an Allen key, first tighten both grub screws in the split end block so that they seat down into the groove in the collar on the gauge tube.

Connect the red and black wires in the gauge cable to the readout and set it to read the gauge. See Section 3.3.

( Select range C or D and set to 'B' units on the VW 2106 readout unit )

For information about the use of the Vibrating Wire readout, please refer to the readout users manual

Using the thumb and two fingers, apply pressure between the full end block and the coil housing on the gauge tube so as to tension the wire. While doing so, have the Allen key ready and observe the readings on the display.





To set the gauge to its mid point ( the most common requirement ), the display should show a reading of close to 1300 units ( 150mm gauge only - see section 8 for additional values ).

When the display shows an acceptable value close to the required point in the gauge range, tighten the remaining grub screw. Ensure that all the grub screws are tight and if the readout has an 'Audio' facility, check that the gauge has a good clear 'ring'.

It is not vital that the reading is set to exactly 1300. A value between 1200 and 1400 will usually suffice since the gauge has a considerable operating range ( 850 - 1750 units or 3200 micro strain ) and some 'over-range' capacity.

The inclusion of cable fixings ( large nuts can be used ) will help maintain the position of the cables and reduce the risk of cable damage.

Looping the cable near the gauge may reduce the risk of damage if, for any reason, the cable is snagged during the installation or monitoring its life.

Cables should be routed so that they are either fully protected or so that they are un-likely to be damaged by future activities.



Where a protective cover is to be installed, fixing lugs should be welded onto the element to secure the cover.

These should be fixed only at one end so as not to interfere with the performance of the gauge.



The steel cover would then be bolted onto the lugs to protect the strain gauge.

Where thermal influence is expected, the cover can be filled with an expanding foam to slow or minimise the effects.



### 4.3.2 50mm Surface Mounted, Spot Welded, Strain Gauges - VWS 2020 Series

The following sections describe typical installation procedures for applications of the 50mm long Geosense Vibrating Wire Surface Mounted Strain gauges.

The installation of the 50mm Surface Mounted gauges require a little more preparation of the surfaces than for the 150mm gauges. Protection of the gauges is obviously much more critical with these finer gauges, than for the larger surface gauges.

As no two installations are the same, the installation details provided below are indicative and intended as a basis for a preparing a method statement for a particular installation.

Fig 6. 50mm Surface Mounted Strain Gauge  
- co-axial coil type



Fig 7. 50mm Surface Mounted Strain Gauge  
- with separate coil housing / cover



Figures 6 and 7 show the 50mm long Vibrating Wire surface mounted strain gauges produced by Geosense. The co-axial type ( Fig 6 ) has its excitation coil and cable filled to the gauge tube, as with the larger gauges. This gauge would normally be covered with a simple steel cover as protection ( see below ). The other type ( Fig. 7 ) is supplied with a removable cover / coil housing which can be either permanently installed over the gauge to protect it or can be de-mounted for use only when reading the gauge.

Detailed below is a the step by step sequence for a typical installation of a 50mm co-axial strain gauge on a steel member.

The installed parts for a co-axial installation comprise :

- Co-axial strain gauge
- Stainless steel protective cover
- Thin stainless banding



Installation tools include:  
 Angle grinder for cleaning the surface of the steel  
 Low power spot welding machine  
 Gauge tensioning device ( see right )





Using an angle grinder with a fine grain disc, clean off the surface of the steel element that is to be instrumented. This need only be in the intended location of the strain gauges.

Carefully remove the gauge from its packaging and place it in its intended location. Check that its end flanges sit flat on the steel surface.



### Take Care



Do not twist the ends of the gauge as this will damage it by twisting the inner tensioned wire.

When the surface is smooth carefully align the gauge and hold it in place with a finger. Using a suitable spot welding machine ( please refer to Geosense when selecting a suitable welder ), carefully weld one end flange onto the steel. Start at the end of the flange ( as seen here ) and then spot weld around the flange, welding one side then the other, back and forth until it is securely fixed to the steel.

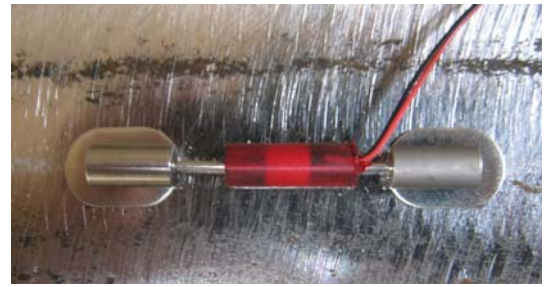

When welding is complete the flange should look like this.



Carefully place the tensioning tool **over** the gauge, making sure that the tool engages with the end blocks, as shown here.

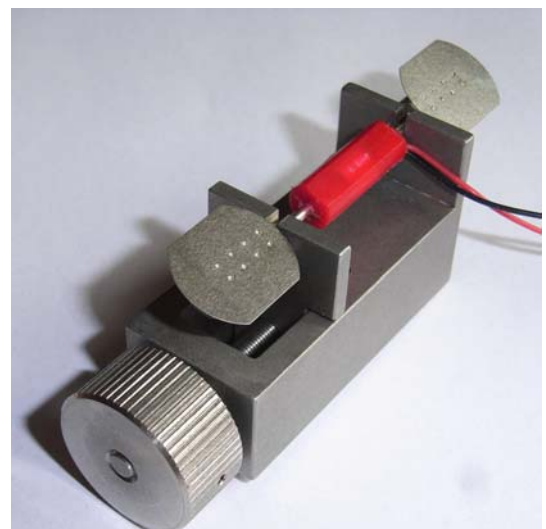
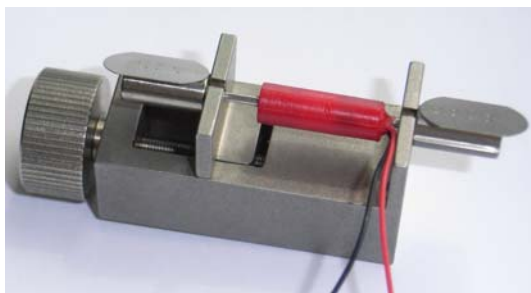

Connect a suitable vibrating wire readout to the strain gauge cables.

( See the readout manuals for adjustments and how to read a suitable range. )

Using a thumb to hold the tensioning tool and gauge in place and in line, turn the knurled adjuster to register a reading on the display that equates to the required position in the gauges operating range.

The normal fixing point is the mid-point in a gauges range. For a 50mm surface gauge, the mid-point is 6500 'Linear Digits', ( or 'B' units ) ( depending upon the readout used )

For further advice with gauge setting and units conversion, please see sections 5 and 8 or contact Geosense.



When the gauge is set to the required tension, disconnect the readout. Hold the gauge in position with a thumb and weld the remaining flange to the steel in a similar manner to the first flange.



Check the readings again to confirm the gauge is functioning.



If the reading is not close to the required value in the gauge range, it should not be a problem since the gauges have a large operating range and some capacity for over range.

Where required, connect extension cable to the gauge wires and seal the joints with a suitable sealant.



If necessary, place the cover over the gauge ensuring that it does not interfere with the operation of the gauge.

Using the stainless steel strapping, form brackets to hold the cover in place. If necessary. The strapping can be welded to the cover to hold it in place. The ends of the cover can be filled with a silicon mastic if necessary.





#### 4.4 Sister Bar Gauges into a Reinforcement cage - VWS-4000 Series

As its name implies, the 'Sister' Bar Strain Gauge is intended for inclusion in concrete 'alongside' other reinforcement bars.

Sister Bar Strain Gauges are available in various diameters and lengths but the installation principles are generally the same.

Sister Bars are normally fixed into a reinforcement cage so that they are parallel to the main reinforcement bars. However, they can be aligned in any direction, provided that precautions are taken not to damage the Sister Bars during any moving of the cage or when placing the concrete. Sister Bars will measure the strain in the concrete ONLY in the direction along the axis of the Sister Bar



**Do not fix Sister Bars directly onto parallel reinforcement bars as this will bend the bar, thereby inducing bending stresses into it.**



Where there is no existing support for a Sister Bar within a reinforcement cage, it will be necessary to introduce additional bars onto which the instrument can be mounted. Generally, these support bars need to be 12 to 16mm in diameter, fixed into the reinforcement at 90 degrees to the intended orientation of the Sister Bar. It is necessary to firmly fix the additional support bars so that the orientation of the Sister Bar is maintained. The Sister Bar must be fixed at 4 or more points along its length, as shown below.

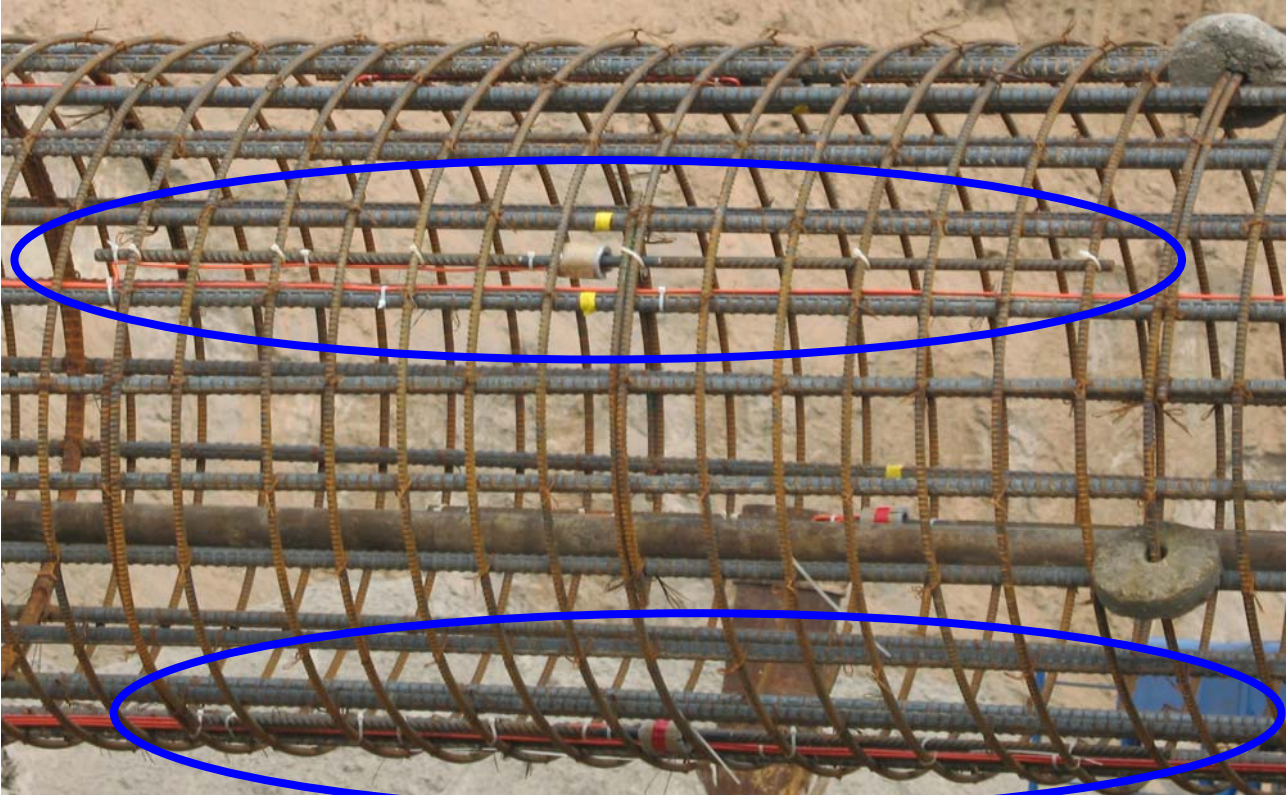

A pile cage with an array of 4 Sister

Bars

Bars installed between the Main

In this installation, Nylon cable ties have been used to fix the Sister Bars to the



Sister Bars, ready for installation.....

For this installation, the installing Engineer has chosen to 'pre-attach' the cables to the bars. This is not essential.

It is advisable to form a small loop of cable close to the gauge, to help reduce the risk of damage to the gauges if the cable should be come snagged or pulled.

In some installations the installing engineer chooses to isolate the 'Strain Gauge Element' from the concrete using a foam tube, as can be seen in this photograph. This is not essential and will not affect the overall performance of the gauge.

Sister Bar Strain Gauges mounted between the main bars in a pile cage and the cables routed on the side of the main bars, to provide protection.

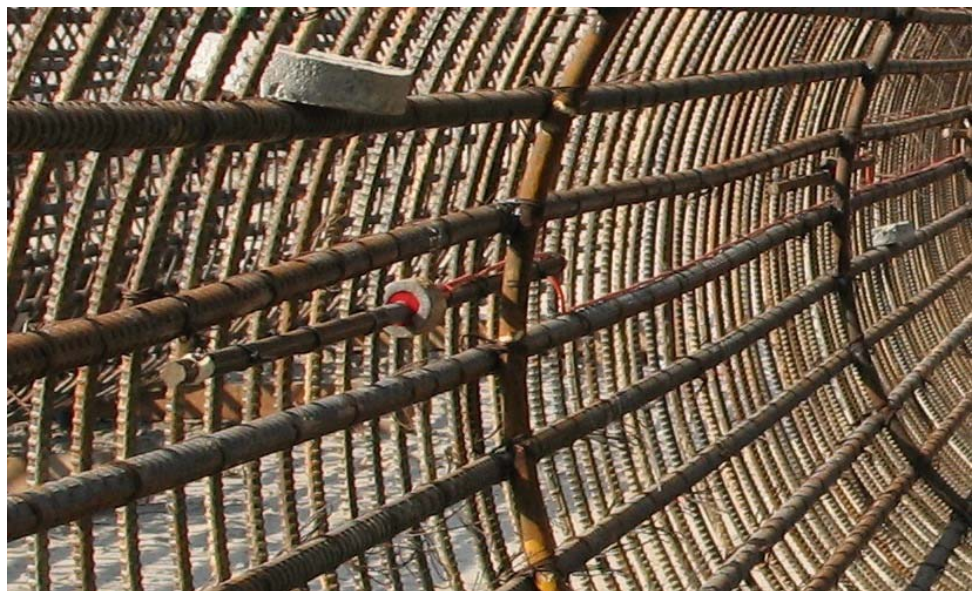

Routing of the instrument cables must be carried out so that they are not at risk of damage during the preparatory works or during concreting. For pile cage installations, the routing considerations are the same as those for the embedded strain gauges ( Section 4.2.1 ).

In other installations, the cable protection principles are similar.



**Sister Bars are NOT intended to be used as Re-Bar Stain Meters. They are NOT intended to be load carrying and are NOT intended to REPLACE the designed reinforcement**



## 5.0 DATA HANDLING



The function of the instrument is to provide useful and reliable data. Accurate recording and handling of the data is essential if it is to be of any value.



### 5.1 Monitoring the Strain Gauge Readings

Geosense VW Strain Gauges can contain Temperature sensors. Where a Strain Gauge is installed in a zone where its temperature is likely to fluctuate significantly, records of both strain and temperature data should be used to assess any effects temperature on the data.

#### 5.1.1 Portable Readouts

Geosense offer a range of readout and data logging options. Specific operation manuals are supplied with each readout device.

Below is a brief, step-by-step procedure for use with the **RST VW2106** portable readout.

1. Connect signal cable from the sensor to the readout following the wiring colour code. Conductor colours may vary depending upon the extension cable used.

RED	=	VW +
BLACK	=	VW -
GREEN	=	Temp
WHITE	=	Temp



2. Switch on the unit and, where necessary, select range B
3. The recorder displays the current VW reading ( in Hz2/1000 ) and a temperature reading in degrees Centigrade.

Whilst it is not critical that the polarity be observed for most VW instruments, a stronger signal may be obtained if the correct polarity is adopted. Since the temperature sensor is a Thermistor, its connection polarity is not important.

#### 5.1.2 Data Loggers

A number of data loggers are available to automatically excite, interrogate and record the reading from Vibrating Wire instruments. These include devices manufactured by Geosense / RST in both single and multi-channel configurations, together with equipment manufactured by independent suppliers.

Geosense configure and supply equipment manufactured by both Campbell Scientific Ltd. and DataTaker Ltd. These are the most commonly adopted third party

*(Continued on page 36)*



(Continued from page 35)

manufacturers of data loggers that can be readily used with Vibrating Wire Strain Gauges. Specific configuration and programming advice can be obtained from Geosense and / or the logger manufacturers' documentation.

## 5.2 Data Reduction

### Overview

The tension of a sensor wire can be measured by detecting the frequency (note) at which it naturally vibrates. The following is a description of the units commonly used by the instrumentation industry.

**Frequency Units ( Hz ).** If the wire is 'excited' electronically the frequency at which it vibrates can be measured. The units used to express frequency are Hertz (Hz) or Kilo-Hertz (kHz).

The disadvantage of these units is that there is no 'linear' conversion from 'change in Hertz' to 'change in wire tension'.

**Linear Digits ( B ).** In order to overcome the problem of a linear conversion described above, the frequency value can be squared, thereby rendering it linear, but quite large. To reduce its size, it is often divided by 1000 (or multiplied by  $10^{-3}$ ). The expression  $\text{Hz}^2/1000$  (or  $\text{Hz}^2 \times 10^{-3}$ ) is the most commonly adopted as a 'linear' digital output.

**Period Units ( P ).** Some readout devices utilise the 'counter' function available in many common integrated circuits.

Period Units represent the time taken for the wire to vibrate over one full oscillation, expressed in seconds. Due to the very small size of the number generated most equipment manufacturers display the unit multiplied by either 1000 (  $10^3$  ) or 10000000 (  $10^7$  ).

The relationship between Period units and Frequency units is expressed as

$$P = \frac{1}{\text{Frequency}}$$

Period units are convenient to measure but do not have a linear relationship to the 'change in wire tension'.

**Calibration Factor.** Each instrument is supplied with a Calibration Factor ( or sometimes called 'Gauge Factor' ), to enable conversion from the raw data ( in the units described above ) into engineering units such as Micro-strain.

The value of the calibration factor will vary depending upon the engineering units into which the raw data is to be converted.

Some instruments have "Generic" calibration factors and others are calibrated to

(Continued on page 37)

(Continued from page 36)

generate an individual calibration factor.

Readings from VW Strain Gauges are typically in a form that is a function of frequency ( as above ) rather than in units of strain.

To convert the readings to units of strain, calibration factor(s) must be applied to the recorded values. For Vibrating Wire Strain Gauges the calibration factors are unique to each model. A certificate of conformance, detailing the applicable calibration factor will be supplied with all Geosense Vibrating Wire Strain Gauges. In addition, a Batch factor may be included on the certificate. This factor accommodates any slight variations in the model specific calibration factor and must also be applied in the calculation.

If a readout display is in 'Period' units ( e.g. 0.03612 or 3612 depending upon the readout used ) a calculation must first be performed to convert the reading from 'Period' units to 'Linear Digits' (  $\text{Hz}^2/1000$  ) units.

Two examples of this can be seen below. The first (1) where readout includes a decimal point and displays the Period in **Seconds**<sup>-2</sup> and the second (2) where the readout displays the Period in **Seconds**<sup>-7</sup>

$$\begin{aligned} (1) \quad \text{Linear Hz}^2/1000 &= ( 1 / 0.03612 \times 10^{-2} )^2 / 1000 \\ &= 7664.8 \end{aligned}$$

$$\begin{aligned} (2) \quad \text{Linear Hz}^2/1000 &= ( 1 / 3612 \times 10^{-7} )^2 / 1000 \\ &= 7664.8 \end{aligned}$$

If the readout displays 'Frequency' values, ( e.g. 2768.5 Hz ) only a simple calculation is required to convert the reading to Linear Digits.

$$\begin{aligned} \text{Linear Digits ( Hz}^2/1000 ) &= ( 2768.5 )^2 / 1000 \\ &= 7664.6 \end{aligned}$$

Certain data loggers store their Vibrating Wire data in Linear Digits but divided by a further 1000. Obviously these data would have to be multiplied by another 1000 to maintain the standard data format for the conversion to engineering units.

There are many ways to achieve the conversion from recorded data to useful engineering values. The following is included as a guide only and as a basis for alternative approaches.

### Linear Calculation

This is the most reliable and straight forward calculation to convert 'raw' data to engineering units. It can be easily carried out using a simple calculator. It assumes that the reading is in ( or has been converted to ) Linear Digits (  $\text{Hz}^2/1000$  ). For most applications this equation is perfectly adequate and is carried out as follows:-

(Continued on page 38)

### Converting from a frequency reading in Hz to microstrain

Use the following equation to convert a reading in Hz to microstrain ( $\mu\epsilon$ ):

$$\mu\epsilon = ( F^2 / 1000 ) \times \text{Gauge-Factor} \times \text{Batch-Factor}$$

Where:

$\mu\epsilon$  = microstrain

F is a reading in Hz.

Gauge-Factor

Batch-Factor ( if applicable )

### Calculating a change ( $\Delta$ ) in microstrain

Change in strain is calculated by subtracting the initial strain from the current strain:

$$\text{Change } (\Delta)\mu\epsilon = \mu\epsilon \text{ current} - \mu\epsilon \text{ initial}$$

or

$$\Delta\mu\epsilon = ( F^2 / 1000 \text{ current} - F^2 / 1000 \text{ initial} ) \times \text{Gauge-Factor} \times \text{Batch-Factor}$$

Where:

$\mu\epsilon$  = microstrain

$\Delta\mu\epsilon$  = change in microstrain

F is a reading in Hz.

Gauge-Factor

Batch-Factor ( if applicable )

To check whether the gauge is in Tension or Compression:

Positive  $\Delta\mu\epsilon$  indicates tensile strain.

Negative  $\Delta\mu\epsilon$  indicates compressive strain.

## Temperature Considerations

Where the Strain Gauge is cast into a concrete pile, there is usually little variation in temperature once the curing has occurred. Consequently, in the short term, temperature effects on the gauge and its readings will be negligible and corrections will not be necessary.

However, if an embedment Strain Gauge is to be monitored over the long term or is installed in a structural element where the concrete temperature is likely to change significantly, the temperature changes will have a greater impact on the data.

Similarly, surface mounted strain gauges **will** be affected by temperature changes. Less so if they are protected with a thermal cover.

Thermal influences are complex because it is not only the gauge that is affected but the element to which it is attached and the whole structure that is affected. The rate of temperature change and the distribution of the thermal gradients also play a major part in influencing the actual strain (load) at any point and its effect on the gauge itself and its readings. Consequently, in order to apply any correction for temperature it is necessary to first establish the effects of the temperature changes on the Strain Gauge and the medium in/on which it is installed.

A useful exercise to carry out on site to establish the in-situ effects of temperature changes is to observe the installed gauge readings, together with both ambient and gauge temperatures, when no other factors are changing. This should be carried out prior to any loading or other structural changes / works being carried out.

An alternative is to use a 'No Stress Strain Gauge' installed close to the monitoring Strain Gauges. This will enable an assessment of temperature effects on the gauge itself in the working environment for a particular location. For details of 'No Stress Strain Gauges', please contact Geosense.

## 6.0 MAINTENANCE

The Vibrating Wire Embedment Strain Gauge is a maintenance free device for most applications. This is because it is intended for sub-surface installation and would normally be irretrievably sealed into structural materials.

Maintenance of wiring connections between the Strain Gauge and any terminal panels / or loggers should involve occasional tightening of any screw terminals to prevent loose connections or cleaning contacts to prevent the build up of corrosion.

## 7.0 TROUBLESHOOTING

It is generally accepted that when a Vibrating Wire instrument is producing a stable reading on a suitable readout, the value will be correct. Only on very rare occasions will this be untrue.

In almost all cases, a fluctuating reading is a sign of a faulty signal from the sensor. The fault could be in either the sensor, the connecting cable, any switch boxes or the readout. The best way to fault find an instrument is to isolate it from all other instruments and connections. Where possible begin fault finding from the sensor itself.

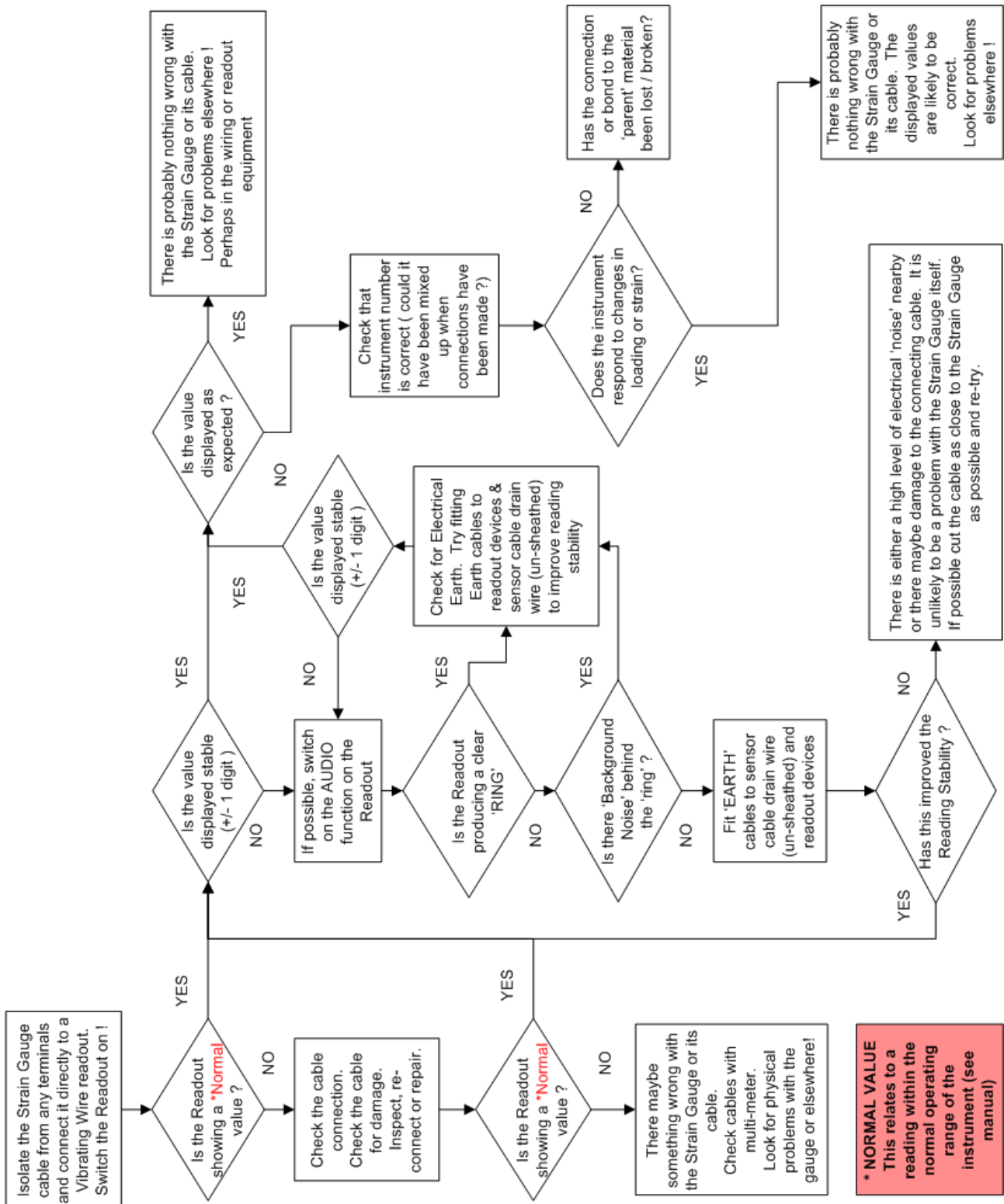



## 8.0 SPECIFICATION

Model Number	VWS - 2000	VWS - 2010	VWS - 2020	VWS - 2025	VWS - 2026
Type	Surface	Surface	Surface	Surface	Surface
Gauge Length (mm)	150	89	49	49	49
Overall Length (mm)	156	95	65	65	65
Operating Range (mm)	0.45	0.15	0.15	0.15	0.15
Strain Range ( $\mu\epsilon$ )	3000	3000	3000	3000	3000
Frequency Range (Hz)	850 - 1550	900 - 2000	1500 - 3000	1500 - 3000	1500 - 3000
Initial Zero (Mid-point - Linear Digit units)	User set ( 1380 )	User set ( 2400 )	User set ( 7250 )	User set ( 7250 )	User set ( 7250 )

Model Number	VWS - 2100	VWS - 2120	VWS - 2125
Type	Embedment	Embedment	Embedment
Gauge Length (mm)	150	50	250
Overall Length (mm)	156	54	260
Operating Range (mm)	0.45	0.10	0.75
Strain Range ( $\mu\epsilon$ )	3000	3000	3000
Frequency Range (Hz)	850 - 1550	1500 - 3000	1500 - 3000

The above technical specification is accurate at the time of the last document revision and is intended as guide only.

The information above is liable to change without notice.

For precise current / supplied specifications, please contact Geosense

Resolution	1 $\mu\text{C}$ ( Readout Dependent )
Accuracy	Better than 0.2% Full Scale
Thermal Effect	Less than 0.02% Full Scale per $^{\circ}\text{C}$ **
Operating Range	-20 to + 95 $^{\circ}\text{C}$
Temperature Sensor ( optional )	Thermistor ( 3k $\Omega$ @ 25 $^{\circ}\text{C}$ )
Over Range Capacity	Range + 20%
Excitation	Pluck or Swept Frequency

The above technical specification is accurate at the time of the last document revision and is intended as guide only.

The information above is liable to change without notice.

For precise current / supplied specifications, please contact Geosense

## 9.0 SPARE PARTS

As a Vibrating Wire Embedment Strain Gauge is a sealed unit, it is neither serviceable nor does it contain any replaceable parts.

Civil engineering sites are hazardous environments and instrument cables can be easily damaged, if they are not adequately protected. Geosense can therefore provide the following parts that may be required to effect repairs to instrument cables:

- PU coated 4 Core cable with foil shield and copper drain.
- PVC coated, armoured, 4 Core cable suitable for direct burial.
- Epoxy jointing kit for forming a waterproof cable joint.

Please contact Geosense for price and availability of the above components.



## 10.0 RETURN OF GOODS

### 11.1 Returns procedure

If goods are to be returned for either service/repair or warranty, the customer should contact Geosense for a **Returns Authorisation Number**, request a **Returned Equipment Report Form QF034** and, where applicable, a **Returned Goods Health and Safety Clearance Form QF038** prior to shipment. Numbers must be clearly marked on the outside of the shipment.

Complete the **Returned Equipment Report Form QF034**, including as much detail as possible, and enclose it with the returned goods.

All returned goods are also to be accompanied by a completed **Returned Goods Health and Safety Clearance Form QF038** attached to the outside of the package (to be accessible without opening the package).

Forms can be downloaded from our web site under the support section/returns

A copy of both forms should be faxed / e-mailed to the Geosense offices, in advance of shipping the goods.

#### 10.1.1 Chargeable Service or Repairs

##### Inspection & estimate

It is the policy of Geosense that an estimate is provided to the customer prior to any repair being carried out. A set charge for inspecting the equipment and providing an estimate is also chargeable.

#### 10.1.2 Warranty Claim

##### (See Limited Warranty Conditions)

This covers defects which arise as a result of a failure in design or manufacturing. It is a condition of the warranty that the Vibrating Wire Strain Gauge must be installed and used in accordance with the manufacturer's instructions and has not been subject to misuse.

In order to make a warranty claim, contact Geosense and request a **Returned Equipment Report Form QF034**. Tick the warranty claim box and return the form with the goods as above. You will then be contacted and informed whether your warranty claim is valid.

## 10.2 Packaging and Carriage

All used goods shipped to the factory **must** be sealed inside a clean plastic bag and packed in a suitable carton. If the original packaging is not available, Geosense should be contacted for advice. Geosense will not be responsible for damage resulting from inadequate returns packaging or contamination under any circumstances.

## 10.3 Transport & Storage

All goods should be adequately packaged to prevent damage in transit or intermediate storage.

## 11.0 LIMITED WARRANTY

The manufacturer, **Geosense Limited**, warrants the **Vibrating Wire Strain Gauge** manufactured by it, under normal use and service, to be free from defects in material and workmanship under the following terms and conditions:-

Sufficient site data has been provided to **Geosense** by the purchaser as regards the nature of the installation environment to allow **Geosense** to check material compatibility of the **VIBRATING WIRE STRAIN GAUGE** and other component parts.

In the absence of any site data being provided by the purchaser standard construction materials will be supplied. All costs for subsequent modifications will be borne by the purchaser.

The **Vibrating Wire Strain Gauge** equipment shall be installed in accordance with the manufacturer's recommendations.

The equipment is warranted for 1 year from the date of shipment from the manufacturer to the purchaser.

The warranty is limited to replacement of part or parts which, are determined to be defective upon inspection at the factory. Shipment of defective part or parts to the factory shall be at the expense of the Purchaser. Return shipment of repaired/replaced part or parts covered by this warranty shall be at the expense of the Manufacturer.

Unauthorised alteration and/or repair by anyone which, causes failure of the unit or associated components will void this **LIMITED WARRANTY** in its entirety.

**The Purchaser warrants through the purchase of the Vibrating Wire Strain Gauge equipment that he is familiar with the equipment and its proper use. In no event shall the manufacturer be liable for any injury, loss or damage, direct or consequential, special, incidental, indirect or punitive, arising out of the use of or inability to use the equipment sold to the Purchaser by the Manufacturer.**

The Purchaser assumes all risks and liability whatsoever in connection with the Strain Gauge equipment from the time of delivery to Purchaser.



Geosense Ltd

Nova House . Rougham Industrial Estate . Rougham . Bury St Edmunds . Suffolk . IP30 9ND . England .

Tel: +44 (0) 1359 270457 . Fax: +44 (0) 1359 272860 . email: [info@geosense.co.uk](mailto:info@geosense.co.uk) . [www.geosense.co.uk](http://www.geosense.co.uk)