

Accutorr[®]7
Vital Signs Monitor

Operator's Manual



© Copyright 2013-2016 Shenzhen Mindray Bio-Medical Electronics Co., Ltd. All rights reserved.

Release date: May 2016
Revision: 4.0

Intellectual Property Statement

SHENZHEN MINDRAY BIO-MEDICAL ELECTRONICS CO., LTD. (hereinafter called Mindray) owns the intellectual property rights to this Mindray product and this manual. This manual may refer to information protected by copyrights or patents and does not convey any license under the patent rights of Mindray, nor the rights of others.

Mindray intends to maintain the contents of this manual as confidential information. Disclosure of the information in this manual in any manner whatsoever without the written permission of Mindray is strictly forbidden.

Release, amendment, reproduction, distribution, rental, adaption and translation of this manual in any manner whatsoever without the written permission of Mindray is strictly forbidden.

mindray,  **MINDRAY**, and **MINDRAY** are the registered trademarks or trademarks owned by Mindray in China and other countries. All other trademarks that appear in this manual are used only for editorial purposes without the intention of improperly using them. They are the property of their respective owners.

Manufacturer's Responsibility

Contents of this manual are subject to changes without prior notice.

All information contained in this manual is believed to be correct. Mindray is not liable for errors contained herein nor for incidental or consequential damages in connection with the furnishing, performance, or use of this manual.

Mindray is responsible for the effects on safety, reliability and performance of this product, only if:

- all installation operations, expansions, changes, modifications and repairs of this product are conducted by Mindray authorized personnel;
- the electrical installation of the relevant room complies with the applicable national and local requirements;
- the product is used in accordance with the instructions for use.



- **Only skilled/trained clinical professionals should operate this equipment.**
 - **It is important for the hospital or organization that uses this equipment to perform a reasonable service/maintenance plan. Neglect of this may result in machine breakdown or personal injury.**
-

Warranty

Mindray warrants that components within its products will be free from defects in workmanship and materials for a period of three years from the date of purchase except that disposable or one-time use products are warranted to be free from defects in workmanship and materials up to a date one year from the date of purchase or the date of first use, whichever is sooner.

This warranty does not cover consumable items such as, but not limited to, batteries, external cables, and sensors.

Mindray shall not be liable for any incidental, special, or consequential loss, damage, or expense directly or indirectly arising from the use of its products. Liability under this warranty and the buyer's exclusive remedy under this warranty is limited to servicing or replacing the affected products, at Mindray option, at the factory or at an authorized distributor, for any product which shall under normal use and service appear to Mindray to have been defective in material or workmanship. Recommended preventative maintenance, as prescribed in the service manual, is the responsibility of the user and is not covered by this warranty.

No agent, employee, or representative of Mindray has any authority to bind Mindray to any affirmation, representation, or warranty concerning its products, and any affirmation, representation or warranty made by any agent, employee, or representative shall not be enforceable by buyer or user.

THIS WARRANTY IS EXPRESSLY IN LIEU OF, AND MINDRAY EXPRESSLY DISCLAIMS, ANY OTHER EXPRESS OR IMPLIED WARRANTIES, INCLUDING ANY IMPLIED WARRANTY OF MERCHANTABILITY, NON-INFRINGEMENT, OR FITNESS FOR A PARTICULAR PURPOSE, AND OF ANY OTHER OBLIGATION ON THE PART OF MINDRAY.

Damage to any product or parts through misuse, neglect, accident, or by affixing any non-standard accessory attachments, or by any customer modification voids this warranty. Mindray makes no warranty whatsoever in regard to trade accessories, such being subject to the warranty of their respective manufacturers.

A condition of this warranty is that the equipment or accessories which are claimed to be defective be returned when authorized, freight prepaid to Mindray DS USA, Inc., Mahwah, New Jersey 07430 or its authorized representative. Mindray shall not have any responsibility in the event of loss or damage in transit.

Exemptions

Mindray's obligation or liability under this warranty does not include any transportation or other charges or liability for direct, indirect or consequential damages or delay resulting from the improper use or application of the product or the use of parts or accessories not approved by Mindray or repairs by people other than Mindray authorized personnel.

This warranty does not extend to:

- Malfunction or damage caused by improper use or man-made failure.
- Malfunction or damage caused by unstable or out-of-range power input.
- Malfunction or damage caused by force majeure events, such as (i) flood, fire and earthquake or other similar elements of nature or acts of God; (ii) riots, war, civil disorders, rebellions, or revolutions in any country; or (iii) any other cause beyond the reasonable control of Mindray.
- Malfunction or damage caused by improper operation or repair by unqualified or unauthorized service people.
- Malfunction of the instrument or part whose serial number is not legible.
- Others not caused by instrument or part itself.

Service

Mindray maintains a network of service representatives and factory-trained distributors. Prior to requesting service, perform a complete operational check of the instrument to verify proper control settings. If operational problems continue to exist, In North America contact the Service Department at (800) 288-2121, ext: 8116 for Technical Support or (201) 995-8000 for assistance in determining the nearest field service location.

Please include the instrument model number, the serial number, and a description of the problem with all requests for service.

Any questions regarding the warranty should be directed to your local sales or service representative.

NOTE

-
- **Upon request, Mindray provides circuit diagrams, component part lists, descriptions, calibration instructions, or other information which assist the user's appropriately qualified technical personnel to repair those parts of the equipment which are designated by Mindray DS USA, Inc. as repairable.**
-

Company Contact

Manufacturer: Shenzhen Mindray Bio-Medical Electronics Co., Ltd.
Address Mindray Building, Keji 12th Road South, Hi-tech industrial park, Nanshan, Shenzhen 518057, P.R.China
Website www.mindray.com
E-mail Address: service@mindray.com.cn
Tel: +86 755 81888998
Fax: +86 755 26582680

Distributor: Mindray DS USA, Inc.
Address: 800 MacArthur Boulevard, Mahwah, New Jersey 07430 USA
Tel: 1.800.288.2121, 1.201.995.8000
Website: www.mindray.com

EC-Representative: Shanghai International Holding Corp. GmbH (Europe)
Address: Eiffestraße 80, 20537 Hamburg, Germany
Tel: 0049-40-2513175
Fax: 0049-40-255726

Preface

Manual Purpose

This manual contains the instructions necessary to operate the product safely and in accordance with its function and intended use. Observance of this manual is a prerequisite for proper product performance and correct operation and ensures patient and operator safety.

This manual is based on the maximum configuration and therefore some contents may not apply to your product. If you have any question, please contact Mindray.

This manual is an integral part of the product. It should always be kept close to the equipment so that it can be conveniently obtained when needed.

Intended Audience

This manual is intended for clinical professionals who are expected to have corresponding working knowledge of medical procedures, practices and terminology as required for the monitoring of patients.

Illustrations

All illustrations in this manual serve as examples only. They may not necessarily reflect the setup or data displayed on your equipment.

Manual Conventions

- Italic text is used to quote the referenced chapters or sections.
- [] is used to enclose screen text.
- → is used to indicate operational procedures.

FOR YOUR NOTES

Contents

1 Safety	1-1
1.1 Safety Information.....	1-1
1.1.1 Warnings.....	1-2
1.1.2 Cautions.....	1-3
1.1.3 Notes.....	1-4
1.2 Equipment Symbols.....	1-4
2 The Basics	2-1
2.1 Intended Use.....	2-1
2.2 Applied Parts.....	2-1
2.3 Main unit.....	2-2
2.3.1 Front View.....	2-2
2.3.2 Side View.....	2-4
2.3.3 Rear View.....	2-5
2.3.4 Bottom View.....	2-6
2.4 Main Screen.....	2-7
2.5 Menu.....	2-11
2.6 Operating Modes.....	2-11
2.6.1 Monitor Mode.....	2-11
2.6.2 Spot Check Mode.....	2-12
2.6.3 Standby Mode.....	2-12
2.6.4 Demo Mode.....	2-13
3 Basic Operation	3-1
3.1 Installation.....	3-1
3.1.1 Unpacking and Checking.....	3-2
3.1.2 Environmental Requirements.....	3-2
3.2 General Operation.....	3-2
3.2.1 Connection to AC Power.....	3-3
3.2.2 Using a Battery.....	3-3
3.2.3 Connecting Accessories.....	3-3
3.3 Turning On/Off Power.....	3-3
3.3.1 Turning Power On.....	3-3
3.3.2 Turning off the Monitor.....	3-4
3.4 Using Key, Knob, Touchscreen.....	3-5
3.4.1 Using Keys.....	3-5
3.4.2 Using the Knob.....	3-5
3.4.3 Using the Touchscreen.....	3-5
3.5 Changing General Settings.....	3-5
3.5.1 Setting up a Monitor.....	3-5

3.5.2 Changing Language.....	3-6
3.5.3 Configuring the Timeout of Clinician ID.....	3-6
3.5.4 Showing/Hiding Patient Name	3-6
3.5.5 Adjusting Alarm Volume.....	3-6
3.5.6 Adjusting Key Volume	3-7
3.5.7 Adjusting the Screen Brightness	3-7
3.5.8 Setting Screen	3-7
3.5.9 Configuring the Timeout of Measured Value.....	3-7
3.5.10 Configuring Measurement Colors	3-8
3.5.11 Setting the Date and Time.....	3-8
3.5.12 Configuring Unit	3-8
3.5.13 Configuring Printout	3-8
4 Patient Data Management	4-1
4.1 Admitting a Patient.....	4-1
4.1.1 Admitting a Patient by the Admit Patient Hardkey.....	4-1
4.1.2 Admitting a Patient by Barcode Scanner	4-2
4.1.3 Admitting a Patient from [Patient List].....	4-4
4.2 Manually Input Patient Data.....	4-5
4.3 Manually Save Patient Data	4-6
4.4 Reviewing Patient Data	4-7
4.4.1 Spot Check Trends	4-7
4.4.2 Continuous Trends.....	4-8
4.4.3 Graphic Trends.....	4-9
4.5 Transferring Data from the Monitor to USB Drive	4-10
5 Managing Configurations	5-1
5.1 Overview.....	5-1
5.2 Accessing [Manage Configuration] Menu.....	5-1
5.2.1 Setting Default Configuration	5-2
5.3 Saving Current Settings.....	5-2
5.4 Deleting a Configuration	5-2
5.5 Transferring a Configuration	5-3
5.6 Loading a Configuration	5-3
5.7 Restoring the Latest Configuration Automatically	5-3
6 Alarms	6-1
6.1 Alarm Categories	6-1
6.2 Alarm Levels.....	6-2
6.3 Alarm Indicators.....	6-2
6.3.1 Alarm Lamp	6-2
6.3.2 Audible Alarm Tones	6-3
6.3.3 Alarm Messages	6-3

6.3.4 Flashing Numerics.....	6-3
6.3.5 Alarm Status Symbols.....	6-4
6.4 Setting Alarms	6-4
6.5 Selecting Alarm Properties	6-5
6.5.1 Changing the Alarm Volume.....	6-5
6.5.2 Setting the Minimum Alarm Volume	6-5
6.5.3 Setting the Interval between Alarm Sounds	6-5
6.5.4 Adjusting Alarm Limits Automatically.....	6-5
6.6 Pausing Alarms	6-7
6.7 Switching Off Alarm Sound	6-7
6.8 Resetting Alarms.....	6-7
6.9 Setting the Reminder Tone.....	6-8
6.10 Latching Alarms.....	6-8
6.11 Actions for Alarm Occurrence	6-9
6.12 Nurse Call	6-9
7 Monitoring SpO₂	7-1
7.1 Overview.....	7-1
7.2 Safety.....	7-2
7.3 Identifying SpO ₂ Module	7-2
7.4 Applying the Sensor	7-3
7.5 Changing SpO ₂ Settings.....	7-3
7.5.1 Accessing SpO ₂ Menu.....	7-3
7.5.2 Adjusting the Desat Alarm.....	7-3
7.5.3 Setting SpO ₂ Sensitivity	7-3
7.5.4 Changing Averaging Time	7-4
7.5.5 Monitoring SpO ₂ and NIBP Simultaneously	7-4
7.5.6 Sat-Seconds Alarm Management	7-4
7.5.7 Changing the Speed of Pleth Wave.....	7-6
7.5.8 Setting the Alarm Level for SpO ₂ Sensor Off Alarm	7-6
7.6 Measurement Limitations	7-6
7.7 Masimo Information.....	7-6
7.8 Nellcor Information.....	7-7
8 Monitoring PR	8-1
8.1 Overview.....	8-1
8.2 PR Source.....	8-1
8.3 Pulse Tone.....	8-1
9 Monitoring NIBP	9-1
9.1 Overview.....	9-1
9.2 Safety.....	9-2
9.3 Measurement Limitations	9-2

9.4 NIBP Measurement Mode.....	9-3
9.5 Measuring NIBP	9-3
9.5.1 Preparing the Patient.....	9-3
9.5.2 Preparing to Measure NIBP.....	9-3
9.5.3 Starting NIBP measurement.....	9-4
9.5.4 Stopping NIBP Measurement.....	9-4
9.5.5 Correcting the Measurement when Cuff is not at Heart Level	9-5
9.6 Understanding the NIBP Numerics.....	9-5
9.7 Setting NIBP.....	9-5
9.7.1 Setting Interval.....	9-5
9.7.2 Setting the Initial Cuff Inflation Pressure.....	9-5
9.7.3 Setting NIBP End Tone.....	9-6
9.7.4 Switching On/Off Measurement on Clock.....	9-6
9.7.5 Configuring a Custom Program.....	9-6
9.7.6 Setting NIBP Alarm Properties	9-7
9.7.7 Setting the Pressure Unit.....	9-7
9.8 Assisting Venous Puncture.....	9-7
9.9 Care and Cleaning of Reusable Cuffs	9-8
9.9.1 Reusable Cuffs with Bladders	9-8
9.9.2 Cleaning	9-8
9.9.3 Reusable Bladderless Cuffs.....	9-9
10 Monitoring Temp	10-1
10.1 Overview	10-1
10.1.1 Setting Temp.....	10-2
10.2 Preparation.....	10-2
10.2.1 Selecting Measuring Site	10-2
10.2.2 Taking a Temperature in Predictive Mode.....	10-3
10.2.3 Taking a Temperature in Monitor Mode.....	10-4
10.3 Disinfecting Temperature Probe	10-4
11 Clinical Scoring	11-1
11.1 Overview	11-1
11.1.1 MEWS (Modified Early Warning Score).....	11-1
11.1.2 NEWS (National Early Warning Score).....	11-1
11.1.3 Customizable Scoring.....	11-2
11.2 Entering the Calculation Screen.....	11-2
11.2.1 Scoring Screen	11-2
11.2.2 Score Tile	11-2
11.3 Calculating a Score	11-3
11.4 Clinical Scoring Screen.....	11-3
11.4.1 Score Tile in the Main Screen	11-3
11.4.2 Scoring Screen	11-3

11.5 Obtaining the Total Score	11-5
11.6 Managing Scorings.....	11-7
11.6.1 Importing the Scoring	11-7
11.6.2 Selecting Default Scoring.....	11-7
11.6.3 Deleting the Scoring.....	11-7
11.6.4 Loading a Scoring.....	11-7
12 Recording.....	12-1
12.1 Using a Recorder	12-1
12.2 Loading Paper	12-1
12.3 Setting the Recorder.....	12-2
12.4 Starting and Stopping Recordings.....	12-2
12.5 Reports	12-3
12.5.1 Real-time Recording	12-3
12.5.2 Graphic Trend Recording	12-3
12.5.3 Continuous Trends Recording.....	12-3
12.5.4 Spot Check Trends Recording	12-4
12.6 Removing a Paper Jam.....	12-4
12.7 Cleaning the Recorder Printhead.....	12-4
13 Network.....	13-1
13.1 Network Connection.....	13-1
13.1.1 Selecting a Network Type	13-2
13.1.2 Setting the Wired Network.....	13-2
13.1.3 Setting the Wireless Network (Optional)	13-2
13.1.4 WLAN Test	13-3
13.1.5 Selecting WLAN Band and Channels.....	13-4
13.1.6 Setting up the Wireless Network (Optional).....	13-4
13.2 Setting Data Send Method.....	13-5
13.2.1 ADT Communication Setup.....	13-5
13.2.2 EMR Communication Setup.....	13-5
13.2.3 NTP Server Setup	13-5
13.2.4 Realtime Data Send Interval (for HL7 only).....	13-6
13.2.5 Alarm Server Settings (for HL7 only)	13-6
13.3 Connecting the monitor to the CMS	13-6
13.3.1 Setting the CMS.....	13-6
13.3.2 Selecting a CMS.....	13-6
13.3.3 Clearing the Selected CMS at Startup.....	13-7
13.4 Managing Certificates	13-7
13.5 Setting the Multicast Parameters.....	13-7
13.5.1 DIAP Communication Setup.....	13-7
14 Battery.....	14-1

14.1 Overview	14-1
14.2 Charging a Battery	14-1
14.3 Replacing a Battery	14-1
14.4 Battery Guidelines	14-2
14.5 Battery Maintenance	14-3
14.5.1 Conditioning a Battery	14-3
14.5.2 Checking a Battery	14-3
14.6 Recycling a Battery	14-4
15 Care, Cleaning and Maintenance.....	15-1
15.1 Cleaning and Disinfection	15-1
15.1.1 Cleaning	15-2
15.1.2 Disinfecting	15-2
15.1.3 Sterilization	15-3
15.2 General Inspection	15-3
15.3 Maintenance and Testing Schedule	15-3
15.4 Checking Monitor Information	15-4
15.5 Visual Inspection	15-5
15.6 Power-on Test	15-5
15.7 Battery Check	15-6
15.8 Calibrating the Touchscreen	15-6
15.9 Formatting the Storage Card	15-6
15.10 Modifying Password	15-6
16 Accessories.....	16-1
16.1 SpO ₂ Accessories	16-1
16.2 NIBP Accessories	16-2
16.3 Temp Accessories	16-3
16.4 Others	16-3
A Product Specifications	A-1
A.1 Classifications	A-1
A.2 Environmental Specifications	A-1
A.3 Power Supply Specifications	A-2
A.4 Physical Specifications	A-2
A.5 Hardware Specifications	A-2
A.6 Wireless Network (Optional)	A-4
A.7 Measurement Specifications	A-5
B EMC and Radio Regulatory Compliance	B-1
B.1 EMC	B-1
B.2 Radio Regulatory Compliance	B-5
C Default Configurations	C-1

C.1 Parameter Configuration.....	C-1
C.2 General Configuration.....	C-4
C.3 User Maintenance Items.....	C-5
D Alarm Messages	D-1
D.1 Physiological Alarm Messages	D-1
D.2 Technical Alarm Messages.....	D-1
E Symbols and Abbreviations	E-1
E.1 Symbols.....	E-1
E.2 Abbreviations	E-3
F Anomalies.....	F-1
F.1 NIBP Smart Inflation Anomaly.....	F-1

FOR YOUR NOTES

1 Safety

1.1 Safety Information

WARNING

- Indicates a potential hazard situation or unsafe practice that, if not avoided, could result in death or serious injury.
-

CAUTION

- Indicates a potential hazard or unsafe practice that, if not avoided, could result in minor personal injury or product/property damage.
-

NOTE

- Provides application tips or other useful information to ensure that you get the most from your product.
-

1.1.1 Warnings

WARNING

- **This equipment is restricted to one patient at a time.**
 - **Before putting the system into operation, the operator must verify that the equipment, connecting cables and accessories are in correct working order and operating condition.**
 - **To avoid risk of electric shock, this equipment must only be connected to a properly grounded power outlet. If a properly grounded power outlet is not available, operate the monitor on battery power.**
 - **Ensure that the equipment is supplied with continuous electric power during operation. Sudden power failure may lead to the loss of patient data.**
 - **The equipment is magnetic resonance (MR) unsafe. To avoid an explosion hazard, do not use the equipment in the presence of oxygen-rich atmospheres, flammable anesthetics, or other flammable agents (such as gasoline).**
 - **Before connecting the equipment to a power line, check that the voltage and frequency ratings of the power line are the same as those indicated on the equipment's label or in this manual.**
 - **Do not open the equipment housings. All servicing or future upgrades must be carried out by Mindray trained and authorized personnel.**
 - **Do not come into contact with patients during defibrillation. Otherwise serious injury or death could result.**
 - **Do not touch the equipment's metal parts or connectors when in contact with the patient; otherwise patient injury may result.**
 - **Do not rely exclusively on the audible alarm system for patient monitoring. Adjustment of alarm volume to a low level or off may result in a hazard to the patient. Remember that alarm settings should be customized according to different patient situations and always keeping the patient under close surveillance is the most reliable way for safe patient monitoring.**
 - **The physiological data and alarm messages displayed on the equipment should be reviewed by a clinician before being used for diagnostic interpretation and treatment.**
 - **To avoid inadvertent disconnection, route all cables in a way to prevent a stumbling hazard. Wrap and secure excess cabling to reduce risk of entanglement by patients or personnel.**
 - **The equipment uses a mains plug as isolation means to the mains power supply. Please do not position the equipment in a place difficult to operate the mains plug.**
 - **Magnetic and electrical fields are capable of interfering with the proper performance of the equipment. For this reason, make sure that all external devices operated in the vicinity of the equipment comply with the relevant EMC requirements. Mobile phones and X-ray equipment are a possible source of interference as they may emit higher levels of electromagnetic radiation.**
-

1.1.2 Cautions

CAUTION

- **Only use parts and accessories specified in this manual.**
 - **Remove the battery before shipping the monitor or if it will not be used for an extended period of time.**
 - **Carefully route patient cabling to reduce the possibility of patient entanglement.**
 - **Disposable accessories are not designed to be reused. Reuse may cause a risk of contamination and affect the measurement accuracy.**
 - **Always install or carry the equipment properly to avoid damage caused by a drop, impact, strong vibration or other mechanical force.**
 - **Dry the equipment immediately in case of rain or water spray.**
 - **When no battery is installed, make sure that the power supply is continuous. A power interruption will result in patient data loss.**
 - **Store and use the equipment in specified environmental condition. The monitor and accessories may not meet the performance specification due to aging, stored or used outside the specified temperature and humidity range.**
-













1.1.3 Notes

















NOTE

- **Keep this manual in the vicinity of the equipment so that it can be easily located when needed.**
- **The software was developed in compliance with IEC60601-1-4. The possibility of hazards arising from software errors is minimized.**
- **This manual describes all the equipment features and options. Your equipment may not have all of them.**
- **During normal use, the operator is expected to face the front of the equipment.**
- **Put the equipment in a location where you can easily view and operate the equipment.**
- **The equipment uses a mains plug as a means of isolation to the mains power supply. Do not position the equipment in a place difficult to access the mains plug.**
- **When disposing of the packaging material, be sure to observe the applicable waste control regulations and keep it out of children's reach.**
- **At the end of its service life, the equipment, and its accessories, must be disposed of in compliance with the guidelines regulating the disposal of such products. If you have any questions concerning disposal of the equipment, please contact Mindray.**

1.2 Equipment Symbols

Some symbols may not appear on your equipment.

	Refer to instruction manual/ booklet		ON/OFF for a part of equipment
	General Warning Sign		Atmospheric pressure limitation
	Alternating current		Battery indicator
	Alarm Reset		NIBP Start/Stop key
	ALARM PAUSED		Graphical recorder
	Admit patient key		Insertion Direction

	DEFIBRILLATION –PROOF TYPE CF APPLIED PART		Input/Output
	Network connector		Equipotentiality
	USB connector		MANUFACTURER
	Serial number		DATE OF MANUFACTURE
	CATALOGUE NUMBER		Protection against fluid ingress
	Temperature limit		Humidity limitation
	Interference may occur in the vicinity of equipment marked with this symbol.		
	The product bears CE mark indicating its conformity with the provisions of the Council Directive 93/42/EEC concerning medical devices and fulfills the essential requirements of Annex I of this directive.		
	The following definition of the WEEE label applies to EU member states only. This symbol indicates that this product should not be treated as household waste. By ensuring that this product is disposed of correctly, you will help prevent bringing potential negative consequences to the environment and human health. For more detailed information with regard to returning and recycling this product, please consult the distributor from whom you purchased it. * For system products, this label may be attached to the main unit only.		
	The presence of this label indicates the machine was certified by ETL with the statement: Conforms to AAMI Std ES 60601-1, IEC Std 60601-1-6, IEC Std 60601-1-8, IEC Std 60601-2-49, IEC Std 80601-2-30, ISO Std 80601-2-56, ISO Std 80601-2-61. Certified to CSA Std C22.2 NO. 60601-1, NO. 60601-1-6, NO. 60601-1-8, NO. 60601-2-49, NO. 80601-2-30, NO. 80601-2-56, NO. 80601-2-61.		

FOR YOUR NOTES

2 The Basics

2.1 Intended Use

The monitor is intended for monitoring physiologic parameters, including Pulse Oximetry (SpO₂), Pulse Rate (PR), Non Invasive Blood Pressure (NIBP) and Temperature (TEMP), on adult, pediatric, and neonatal patients in healthcare facilities by physicians or appropriate medical staff under the direction of physicians.

This monitor is intended for use only by clinical professionals or under their guidance. It must only be used by persons who have received adequate training in its use.

2.2 Applied Parts

The applied parts of the monitor include followings:

- SpO₂ sensor and cable
- NIBP tubing and cuff
- Temp probes and cable

2.3 Main unit

2.3.1 Front View

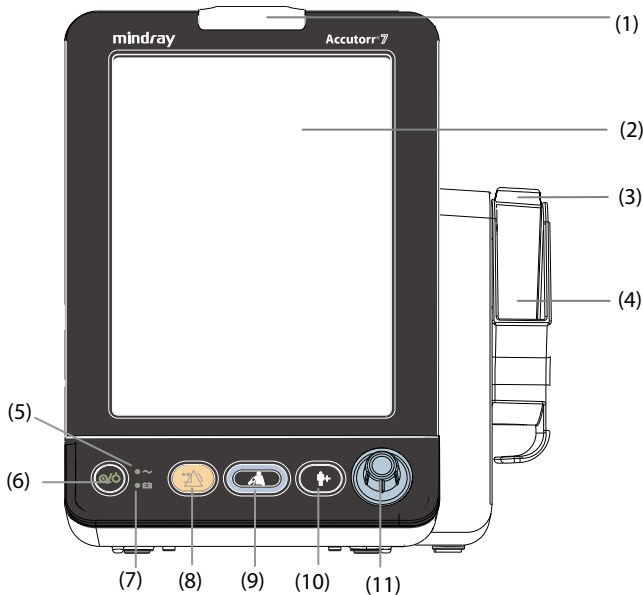

(1) Alarm indicator

When a physiological alarm or a technical alarm occurs, this indicator will flash as defined below.

- ◆ High priority alarm: the lamp quickly flashes red.
- ◆ Medium priority alarm: the lamp slowly flashes yellow.
- ◆ Low priority alarm: the lamp is yellow without flashing.

(2) Display screen

(3) Temperature probe well

(4) Probe cover pack holder

(5) AC power indicator

- ◆ On: indicates that the monitor is connected to the AC power.
- ◆ Off: indicates that the monitor is not connected to the AC power.

(6) Power ON/OFF switch

- ◆ Press this key to turn the monitor on.
- ◆ If no parameter is being measured, press this key to enter Standby mode.
- ◆ When the monitor is on, press and hold this key for more than 2 seconds to turn the monitor off.

An indicator is built into this switch. It turns on when the monitor is on and turns off when the monitor is off.

- (7) Battery indicator
 - ◆ On: indicates that the battery is installed and the AC power is connected.
 - ◆ Off: indicates that no battery is installed when AC power is connected, or indicates that the battery is installed, but no AC power is connected when the monitor is powered off.
 - ◆ Flashing: indicates that the monitor is powered by battery.
- (8) Alarm Reset key
 - ◆ Press this key to disable the audio of present alarms.
 - ◆ Press and hold this key for more than 2 seconds to pause or restore alarms.
- (9) NIBP Start/Stop key
 - ◆ Press to start or stop NIBP measurements.
- (10) Admit patient key
 - ◆ Press this key to admit a new patient.
 - ◆ Press this key to return to the main screen.
- (11) Knob
 - ◆ Rotate the knob clockwise or counterclockwise to move the cursor.
 - ◆ Press the knob to select one item, such as accessing a menu or confirming the selection.

2.3.2 Side View

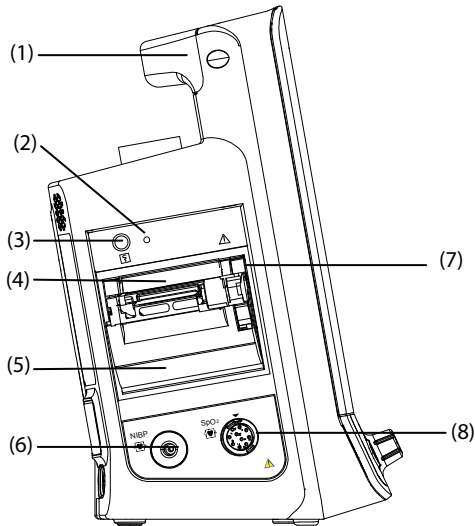

- (1) Handle
- (2) Recorder indicator
- (3) Start/stop recording key
- (4) Paper outlet
- (5) Recorder door
- (6) Connector for NIBP cuff
- (7) Recorder door latch
- (8) Connector for SpO₂ cable

2.3.3 Rear View

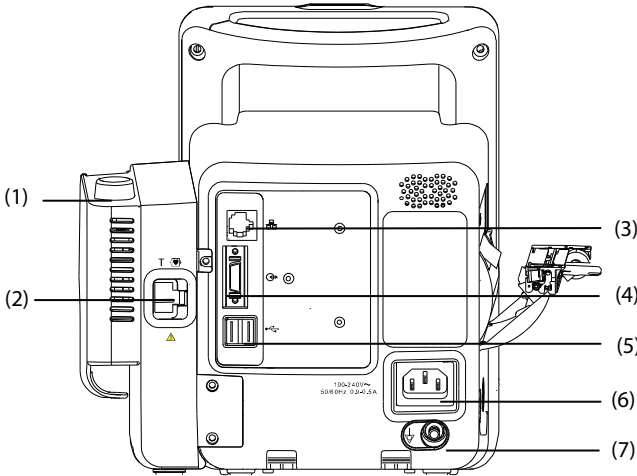

- (1) Temperature probe well
- (2) Connector for temperature probe
- (3) Network connector: It is a standard RJ45 connector used to communicate with external devices, such as central monitoring system, eGateway, or for upgrading the system software.
- (4) Multi-function connector: connects to the hospital's nurse call system, or connects external devices through DIAP protocol.
- (5) USB connector: connects to barcode scanner or USB disk.
- (6) AC power input
- (7) Equipotential grounding terminal

NOTE

-
- **When using the equipment with other devices, their equipotential grounding terminals should be connected together to eliminate a possible difference in ground potential.**
-

2.3.4 Bottom View

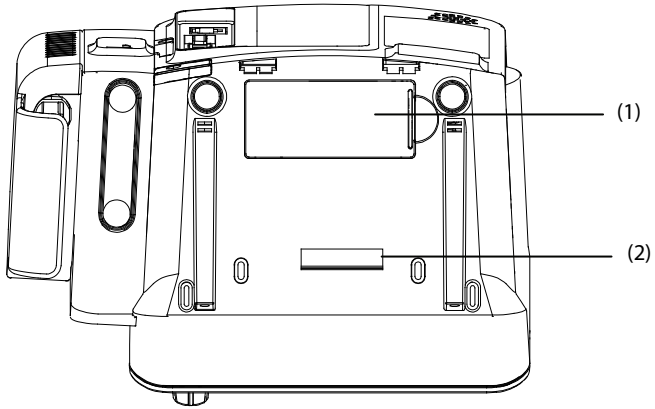

- (1) Battery compartment door
- (2) Quick release mount latch point

2.4 Main Screen

The main screen has three display modes. They are all parameter screen, trend screen and NIBP list screen.

■ All Parameter Screen

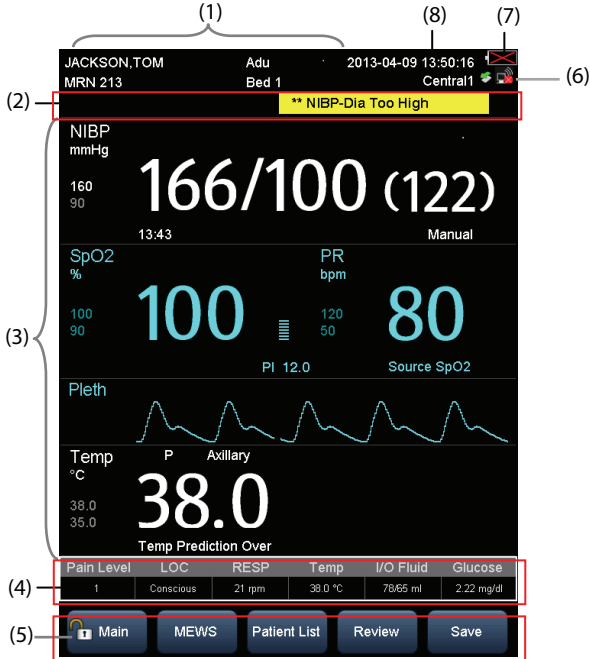

■ Trend Screen

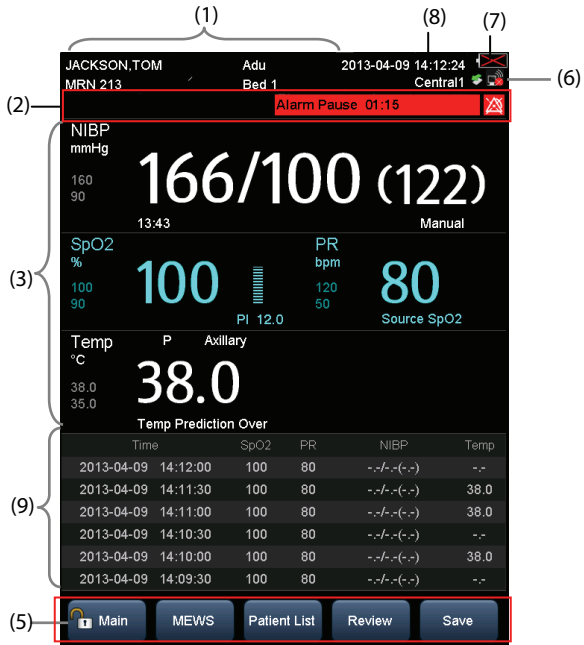

■ NIBP List Screen

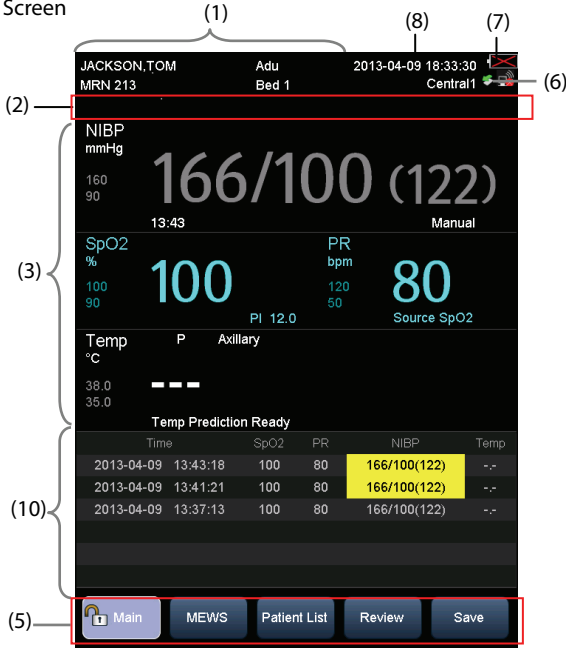

(1) Patient Information/System Message Area

This area normally shows patient information, such as patient medical record number, patient name, patient category, room, bed number, clinician ID. When a system related message is presented, the second line of this area will display the system prompt message for 30 seconds. The patient information in this area will be covered temporarily.

(2) Alarm Information Area

There are three sections in this area: The left side of this area shows the technical alarm message or prompt message; the middle area shows the physiological alarm message; and the right side of this area shows the alarm symbol. When there are multiple messages, they will scroll.



indicates alarms are paused.



indicates alarms are reset.







indicates alarm sounds are turned off.

(3) Parameter and waveform area: displays parameters and waveforms.

(4) Manual input area: manually input physiological related values. This area does not display by default. Refer to **4.2 Manually Input Patient Data** for additional information.

(5) Menu QuickKeys

- ◆ Main: Accesses the **[Main]** screen to configure the monitor, or quickly returns to the main screen.

- ◆ Scoring: Accesses the [**Scoring**] screen to evaluate a patient's condition. Refer to **11 Clinical Scoring**.
 - ◆ Patient List: Accesses the [**Local Patient List**] and [**ADT Database**] screen to admit a patient stored in the monitor or ADT database. Refer to **4.1.3 Admitting a Patient from [Patient List]**.
 - ◆ Review: Displays the spot check trends, continuous trends and graphic trends. Refer to **4.4 Reviewing Patient Data**.
 - ◆ Save: Accesses the [**Results**] screen to manually save patient data. Refer to **4.3 Manually Save Patient Data**.
- (6) Network and USB connection area
- Display CMS information or Spot Check mode. For details for how to configure CMS, refer to **13.3 Connecting the monitor to the CMS**.
Indicate the connection of network or USB to this monitor.
-  indicates monitor is successfully connected to a wired network.
 -  indicates the wireless function (optional) is working.
 -  indicates monitor has failed to connect a wired network.
 -  indicates the wireless function (optional) is not working.
 -  indicates a USB drive is inserted.
- (7) Battery status: indicates the status of the battery. For details, refer to **Chapter 14 Battery**.
- (8) System time
- (9) Tabular trend area. This area displays only in Trend screen mode.
- (10) NIBP list area. This area displays only in NIBP List screen mode.

2.5 Menu

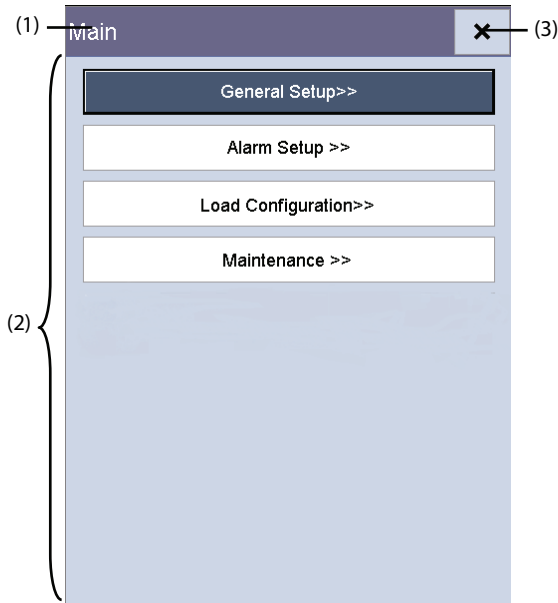

A menu in this monitor is usually composed of:

- (1) Heading: provide a title or description for the current menu.
- (2) Main body: displays options, buttons, prompt messages, etc. A menu button followed by ">>" opens a secondary window to reveal more options or information.
- (3) : select to exit the current menu.

2.6 Operating Modes

2.6.1 Monitor Mode

The monitor will automatically enter monitor mode after power on. Monitor mode is a common mode for monitoring patient vital signs.

NOTE

-
- **In Monitor mode, physiological and technical alarms, and prompt messages are supported.**
-

2.6.2 Spot Check Mode

The Spot Check mode is intended for on-spot measurement in a short time period. When Spot Check mode is On, **[Spot Check]** displays in the Network and USB connection area at the top of the screen.

To enter Spot Check mode, select **[Main]**→**[Maintenance>>]**→**[User Settings>>]**→Enter required password→Set **[Spot Check]** to **[On]**.

NOTE

-
- **In Spot Check mode, technical alarms and prompt messages are supported, but no physiological alarms.**
-

Monitor Mode vs. Spot Check Mode

The Monitor mode and Spot Check modes have all the features in common except the following:

Functions	Monitor Mode	Spot Check Mode
Configure and use Sat-Seconds (Nellcor)	Yes	No
Access [Alarm Setup] tab	Yes	No
Access [Continuous Trends] tab	Yes	No
Access [Graphic Trends] tab	Yes	No
Connect to the CMS	Yes	No

2.6.3 Standby Mode

In Standby mode, the patient is not being monitored, but the monitor is still powered on.

If no parameter is being measured, you can press the power switch to enter Standby mode. A warning pops up. Select **[Yes]** to enter the Standby mode.

When the monitor is powered by a battery, it will automatically enter the Standby mode when the following conditions are satisfied:

- No key operation within 10 minutes.
- No unacknowledged alarms.

To exit Standby mode, use any one of the following methods:

- Press any hardkey on the front panel.
- Rotate the knob.
- Connect SpO₂ sensor, and let the monitor receive SpO₂ signal for more than 5 seconds.
- Remove the temperature probe from the probe well.

NOTE

- **If the monitor enters and then exits Standby mode during patient monitoring, you must re-admit the patient before continuing monitoring.**
-

2.6.4 Demo Mode

Demo mode is password protected, and it is used for demonstration purpose only.

To enter Demo mode:

1. Select **[Main]**→**[Maintenance>>]**.
2. Select **[Demo>>]**→Enter required password→Select **[OK]**.

To exit Demo mode:

1. Select **[Main]**→**[Maintenance>>]**.
2. Select **[Exit Demo]**.

WARNING

- **The Demo mode is for demonstration purpose only. To avoid the potential risk of the simulated data being mistaken for the monitored patient's data, do not enter the Demo mode while monitoring a patient. Otherwise, improper patient monitoring and delayed treatment could result.**
-

FOR YOUR NOTES

3 Basic Operation

3.1 Installation

WARNING

- **Connect only approved devices to this equipment. Devices connected to the equipment must meet the requirements of the applicable IEC standards (e.g. IEC 60950 safety standards for information technology equipment and IEC 60601-1 safety standards for medical electrical equipment). The system configuration must meet the requirements of the IEC 60601-1 medical electrical systems standard. Any personnel who connect devices to the equipment's signal input/output port is responsible for providing evidence that the safety certification of the devices has been performed in accordance to the IEC 60601-1. If you have any questions, please contact Mindray.**
 - **If it is not evident from the equipment specifications whether a particular combination with other devices is hazardous, for example, due to summation of leakage currents, please consult the manufacturers or else an expert in the field, to ensure the necessary safety of patients and all devices concerned will not be impaired by the proposed combination.**
 - **Use only screws and brackets specified by Mindray, or the screw could touch the internal battery, causing monitor damage.**
-
-

CAUTION

- **The equipment should be installed by authorized Mindray personnel.**
-

NOTE

- **The software copyright of the equipment is solely owned by Mindray. No organization or individual shall resort to modifying, copying, or exchanging it or to any other infringement on it in any form or by any means without due permission.**
-
-

3.1.1 Unpacking and Checking

Before unpacking, examine the packing case carefully for signs of damage. If any damage is detected, contact the carrier or Mindray.

If the packing case is intact, open the package and remove the equipment and accessories carefully. Check all materials against the packing list and check for any mechanical damage. Contact Mindray in case of any problem.

CAUTION

- **When disposing of the packaging material, be sure to observe the applicable waste control regulations and keep it out of children's reach.**
- **Before use, please verify whether the packages are intact, especially the packages of single use accessories. In case of any damage, do not apply it to patients.**

NOTE

- **Save the packing case and packaging material as they can be used if the equipment must be reshipped.**
-
-

3.1.2 Environmental Requirements

The operating environment of the equipment must meet the requirements specified in this manual.

The equipment operating environment should be reasonably free from noise, vibration, dust, corrosive, flammable and explosive substances. To maintain good ventilation, the equipment should be at least 2 inches (5 cm) away from surrounding objects.

When the equipment is moved from one place to another, condensation may occur as a result of temperature or humidity difference. In this case, never start the system before the condensation disappears.

CAUTION

- **Make sure that the equipment operating environment meets the specifications. Otherwise unexpected consequences, e.g. damage to the equipment, could result.**
-
-

3.2 General Operation

Read this operator's manual carefully before using this monitor. Familiarize yourself with the equipment's function and operation, and observe the warnings and cautions included in the manual.

3.2.1 Connection to AC Power

This monitor can be powered by AC power or battery. Connect the power cord to the AC input on the back of the monitor, and connect the other end of the power cord to the power outlet.

WARNING

- **Always use the accompanying power cord with the monitor.**
 - **Use the battery if the integrity of the protective earth conductor or the protective earthing system in the installation is in doubt.**
-

3.2.2 Using a Battery

This monitor can be equipped with rechargeable lithium-ion battery. If a battery is installed, the monitor system automatically switches to the battery for power if AC power is interrupted.

Installing a Battery

The battery compartment cover is on the bottom of the monitor. Refer to **14.3 Replacing a Battery** for additional information regarding battery installation.

NOTE

- **When a battery has been stored for a long time, or the battery is depleted, recharge the battery at once. Otherwise, the low battery may not be sufficient to power the monitor if the AC power is unavailable.**
-

Charging a Battery

The battery is charged whenever the monitor is connected to an AC power source regardless of whether the monitor is turned on or not.

When the battery is charging, the battery indicator is On. The battery charge icon on the screen dynamically displays the charging status when the monitor is powered on.

3.2.3 Connecting Accessories

Insert the hose part of NIBP cuff to the connector on the side of monitor; insert the SpO₂ cable into the SpO₂ cable connector on the side of the monitor; insert the temperature probe cable into the TEMP probe connector on the back of the monitor.

3.3 Turning On/Off Power

3.3.1 Turning Power On

Once the monitor is installed, before beginning measurements.

1. Check the monitor for any mechanical damage, and make sure that all external cables, plug-ins and accessories are properly connected.

2. Check the power supply specification is met if mains power is used. Only use a power outlet that is properly grounded.
3. Plug the power cord into the AC power source. If you run the monitor on battery power, ensure that the battery is sufficiently charged.
4. Press the power on/off switch on the monitor's front panel.

The monitor will perform alarm system self-test during start-up. After pressing the power on/off button, the system sounds a beep, and the alarm lamp simultaneously turns yellow, then red, and then turns off, with the start-up screen being shown. Then the start-up screen disappears. The alarm system self-test succeeds. The monitor enters the normal monitoring screen.

WARNING

- **Check that visual and auditory alarm signals are presented correctly when the equipment is powered on. Do not use the equipment for any monitoring procedure on a patient if you suspect it is not working properly, or if it is mechanically damaged. Contact your service personnel or Mindray.**
-

NOTE

- **Carefully check if the system performs the self-test as described above. Contact your service personnel or Mindray if the self-test is abnormal.**
-

3.3.2 Turning off the Monitor

Before turning off the monitor:

1. Ensure that monitoring of the patient has been completed.
2. Disconnect cables and sensors from the patient.
3. Make sure to save or clear the patient monitoring data as required.

Then press and hold the power on/off switch for more than 2 seconds to turn off monitor. There is a prompt message when the system is shutting down.

CAUTION

- **Press and hold the power on/off switch for 10 seconds to forcibly shut down the monitor if it could not be shut down normally. This may cause loss of patient data.**
 - **The monitor restores the latest configuration if it restarts within 60 seconds after a power failure. The monitor restores the default configuration, rather than the latest configuration, if it restarts 120 seconds after a power failure. The monitor may load either the latest configuration or the default configuration if it restarts from 60-120 seconds after a power failure.**
 - **Power failure may cause data corruption on the SD card. It is recommended to turn off the monitor according to the normal procedures. Do not directly unplug the power cord, unless there is a charged battery installed, or remove the battery before shutting down the monitor.**
-



NOTE

- To completely disconnect the power supply, unplug the power cord.
-

3.4 Using Key, Knob, Touchscreen

3.4.1 Using Keys

The monitor has three types of keys:

- Softkey: A softkey is a graphic key on the screen, giving you fast access to certain menus or functions. The monitor has two types of softkeys:
 - ◆ Parameter keys: Each parameter area or waveform area can be seen as a softkey. You can enter a parameter setup menu by selecting its corresponding parameter area or waveform area.
 - ◆ QuickKeys: QuickKeys are configurable graphical keys, located at the bottom of the main screen.
- Hardkeys: A hardkey is a physical key on a monitoring device, such as the Alarm Reset hardkey  and admit patient hardkey  on the front panel.
- Pop-Up Keys: Pop-up keys are task-related menu keys that appear automatically on the monitor screen when required. For example, the confirm pop-up key appears only when you need to confirm a change.

3.4.2 Using the Knob

Using the knob on the front panel of the monitor can do the following operations:

- Rotate the knob clockwise or counterclockwise to move the cursor.
- Press the knob to select one item, such as accessing a menu or confirming the selection

3.4.3 Using the Touchscreen

Select screen items by pressing them directly on the monitor's screen.

You can disable touchscreen operation by pressing and holding the **[Main]** QuickKey for 3 seconds. Then a padlock symbol  on the **[Main]** QuickKey is displayed.

When the screen is locked, you can enable the touchscreen operation by pressing and holding the **[Main]** Quickkey for 3 seconds.

3.5 Changing General Settings

This section covers only general settings such as language, brightness, date and time, etc. Measurement settings and other settings can be referred to in the respective sections.

3.5.1 Setting up a Monitor

To install a monitor or change the monitor's location, you need to set it as follows:

1. Select **[Main]**→**[Maintenance >>]**→**[User Settings >>]**→Enter the required password→Select **[Ok]** and then access **[User Settings]** menu.
2. Set up **[Monitor Name]**, **[Department]** and **[Bed No.]**.

You can set **[Changing Bed No.]** to:

- **[Unprotected]**: enables you to change Bed No. from the **[Patient Demographics]** menu.
- **[Protected]**: prevents you from changing Bed No. from the **[Patient Demographics]** menu.

3.5.2 Changing Language

1. Select **[Main]**→**[Maintenance >>]**→**[User Settings >>]**→Enter the required password Select **[Ok]** to access **[User Settings]** menu.
2. Select **[Language]** and then select the desired language.
3. Restart the monitor.

3.5.3 Configuring the Timeout of Clinician ID

You can configure the retention time of a clinician ID each time it is entered. If a clinician ID is entered, but there is no activity on the monitor for a configured period of time, the monitor will clear the ID.

1. Select **[Main]**→**[Maintenance >>]**→**[User Settings >>]**→Enter the required password→Select **[Ok]** and then access **[User Settings]** menu.
2. Select **[Clinician ID Time out]** and then set the time.

3.5.4 Showing/Hiding Patient Name

You can show or hide the current patient name in the main screen. To do so, follow this procedure:

1. Select **[Main]**→**[Maintenance >>]**→**[User Settings >>]**→Enter the required password→Select **[Ok]** and then access **[User Settings]** menu.
2. Select **[Patient Demographics]**.
3. Set **[Display Patient Name]** to **[Yes]** or **[No]**.
 - ◆ **[Yes]**: the patient's name display in the main screen.
 - ◆ **[No]**: the patient's name does not display in the main screen.

3.5.5 Adjusting Alarm Volume

1. Select **[Main]**→**[General Setup>>]**.
2. Select **[Alarm Volume]** and then select the appropriate volume. The alarm volume range is between X to 10. X is the minimum volume, which depends on the setting of minimum alarm volume (refer to **6.5.2 Setting the Minimum Alarm Volume**), and 10 the maximum volume.

The alarm tone is switched off when the volume is set to [0].

WARNING

- **Do not rely exclusively on the audible alarm system for patient monitoring. Adjustment of alarm volume to a low level may result in a hazard to the patient. Always keep the patient under close surveillance.**
-

3.5.6 Adjusting Key Volume

1. Select [Main]→[General Setup>>].
2. Select [Key Volume] and then select the appropriate volume: 0-10, in which 0 means off, and 10 the maximum volume.

The monitor can provide a tone according to the settings in key volume when you press the knob or hard key, or touch the screen.

3.5.7 Adjusting the Screen Brightness

1. Select [Main]→[General Setup>>].
2. Select [Brightness] and select the appropriate setting for the screen brightness. 10 is the brightest, and 1 is the dimmest.

If the monitor operates on battery power, you can set a dimmer screen to prolong the battery operating time. When the monitor enters Standby mode, the screen automatically changes to the dimmest setting.

3.5.8 Setting Screen

You can set the main screen to one of the three pre-defined layouts as desired.

To set the screen:

1. Select [Main]→[General Setup>>].
2. Select [Display Setup] and set the main screen to different layout: All Parameters display, Trend display or NIBP List display.
 - ◆ All Parameters display includes parameter area, waveform area, but no trend.
 - ◆ Trend display includes parameter area, tabular trends, but no waveform area.
 - ◆ NIBP List display includes parameter area, NIBP list, but no waveform area.

Refer to **2.4 Main Screen** for additional information.

3.5.9 Configuring the Timeout of Measured Value

You can configure the retention time for the digital value of the current NIBP and temperature measurement displayed on the screen.

To set the timeout:

1. Select **[Main]**→**[General Setup>>]**.
2. Select **[Parameter Time Out]** and select an appropriate setting.

The options are 5 min, 10 min, 15 min, and 30 min and off. When **[Off]** is selected, the digital value of the current NIBP and temperature measurement will display on the screen until a new measured value replaces it.

3.5.10 Configuring Measurement Colors

You can set the desired color for SpO₂, NIBP, Temp and PR.

Select **[Main]**→**[General Setup>>]**→**[Parameter Color Setup>>]** and then the **[Select Color]** menu pops up.

3.5.11 Setting the Date and Time

1. Select **[Main]**→**[General Setup>>]**→**[System Time>>]**.
2. Set **[Date]** and **[Time]**.
3. Select **[Date Format]** and toggle between **[yyyy-mm-dd]**, **[mm-dd-yyyy]** and **[dd-mm-yyyy]**.
4. Select **[Time Format]** and toggle between **[24h]** and **[12h]**.

CAUTION

- **Changing date and time affects the storage of trends and events and may cause data loss. Save or record any needed data prior to changing the date and time.**
-

3.5.12 Configuring Unit

You can configure the measurement unit.

To enter the **[Unit Setup]** menu, select **[Main]**→**[General Setup>>]**→**[Unit Setup>>]** and then the **[Unit Setup]** menu pops up.

3.5.13 Configuring Printout

You can select the items to be printed on the strip. By default, all items are selected.

To enter the **[Print Setup]** menu, select **[Main]**→**[General Setup>>]**→**[Print Setup>>]** and then the **[Print Setup]** menu pops up.

4 Patient Data Management

4.1 Admitting a Patient

The monitor displays and stores physiological data in the trends as soon as a patient is connected. This allows you to monitor a patient that is not admitted yet. However, it is recommended that you fully admit a patient so that you can clearly identify your patient, on recordings, reports and networking devices.

NOTE

- **If the monitor enters and then exits Standby mode during patient monitoring, you must re-admit the patient before continuing monitoring.**
-

4.1.1 Admitting a Patient by the Admit Patient Hardkey

1. Press the  hardkey to access the [Patient Demographics] menu.

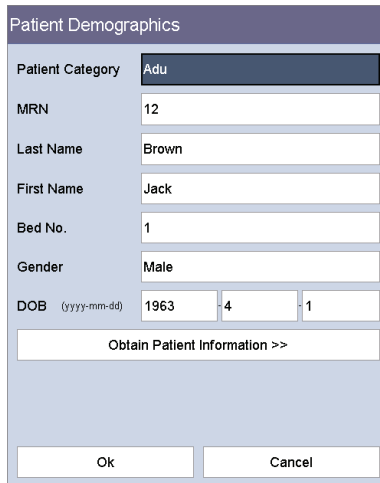

The screenshot shows a 'Patient Demographics' form with the following fields and values:

Patient Category	Adu
MRN	12
Last Name	Brown
First Name	Jack
Bed No.	1
Gender	Male
DOB (yyyy-mm-dd)	1963 4 1

Below the fields is a button labeled 'Obtain Patient Information >>' and at the bottom are 'Ok' and 'Cancel' buttons.

2. Enter the demographic details.
If the monitor is connected to ADT server, when you input patient MRN, the monitor performs as follows:
 - ◆ If a matching patient MRN is found in the ADT server, the monitor will automatically populate the [Patient Demographics] fields according to the patient data stored in the ADT server.
 - ◆ If no matching patient MRN is found in the ADT server, the message 'Failed to obtain patient information' will display.
3. Select [Ok].

You can configure the **[Patient Demographics]** menu.

1. Select **[Main]**→**[Maintenance >>]**→**[User Settings >>]**→enter the required password→select **[Ok]** to access **[User Settings]** menu.
2. Select **[Patient Demographics >>]**.
3. Select the desired items in **[Patient Demographics]** menu.
 - ◆ **[Required Information]**: these items are required when you send the data to the eGateway.
 - ◆ **[Optional Information]**: these items are optional and not required when admitting a patient. You can also customize four options as optional information.
4. Select **✕** to save the configuration and exit the menu.

NOTE

- **In the Patient Demographics menu, the items with the '*' symbol indicate a required field. The patient data cannot be sent to eGateway until all the required data is entered.**
 - **If a clinician ID is entered, but there is no activity on the monitor for a configured period of time, the monitor clears the clinician ID. Refer to *Section 3.5.3 Configuring the Timeout of Clinician ID.***
-

4.1.2 Admitting a Patient by Barcode Scanner

The monitor provides the ability to admit a patient through linear or two-dimension barcode scanner.

NOTE

- **If the patient demographics are obtained from barcode scanner, the patient demographics cannot be changed.**
-

4.1.2.1 With Linear (1D) Barcode Scanner

To admit a patient with a 1D barcode scanner, follow this procedure:

1. Connect the barcode scanner to the USB connector on the monitor.
2. Aim the barcode scanner at the barcode.
3. Select **[Ok]** on the **[Patient Demographics]** menu to admit the patient.

4.1.2.2 With Two-Dimension (2D) Barcode Scanner

Configuring the Scanner

When the scanner is first used in your hospital, you need to clear and re-establish the data format for the scanner before admit a patient.

1. Connect the barcode scanner to the USB connector on the monitor.
2. Aim the scanner at the following barcode to clear the previous data format.



Clear All Data Formats

3. Aim the scanner at the 2D image which contains your hospital's barcode data format. Contact the scanner manufacturer for obtaining this image.

Setting the Monitor

After you have set up the data format for the 2D scanner, follow this procedure to set up the monitor:

1. Select **[Main]**→**[Maintenance >>]**→**[User Settings >>]**→enter the required password→select **[Ok]** to access **[User Settings]** menu.
2. Select **[Scanner Setup>>]**→**[2D Barcode Setup>>]**. The setup screen displays.
3. Establish the relationship between the monitor data and barcode data for selectable patient demographics. For example, the monitor has an option of **[Adult]** for patient category. In your hospital barcode, the text may read as **[Adu]**. You need to input **[Adu]** for the field **[Adult]** to establish the relationship. The following aspects need to establish the relationship:
 - ◆ Patient Category
 - ◆ Gender
 - ◆ Month
4. Select **✕** to save the configuration and exit the **[2D Barcode Setup]** menu.
5. Select the desired pop-up menu if you scan the patient barcode.
 - ◆ **[Patient Demographics]**: the **[Patient Demographics]** menu displays.
 - ◆ **[ADT Database]**: the **[ADT Database]** tab displays.

NOTE

-
- **If there is existing open menu or window, the **[Patient Demographics]** menu or **[ADT Database]** tab will not pop up.**
-

6. Select **✕** to save the configuration and exit the menu.

Admitting a Patient

To admit a patient, follow this procedure:

1. Connect the barcode scanner to the USB connector on the monitor.
2. Aim the scanner at the clinician barcode and press the scan button at the barcode scanner. The clinician ID will populate the **[Clinician ID]** field in the **[Patient Demographics]** menu.
3. Aim the scanner at the patient barcode and press the scan button on the barcode scanner. The pop-up menu that opens depends on if **[Patient Demographics]** or **[ADT Database]** is selected at the **[Scanner Setup>>]** menu.
4. Select **[Ok]** to admit the patient.

4.1.3 Admitting a Patient from [Patient List]

Admit a Patient from [Local Patient List]

1. Press **[Patient List]** QuickKey, and then **[Local Patient List]** screen displays.
2. Select the page key (for example \wedge \vee), and then use the up or down arrow beside the key to turn to another page, or select **[Scroll]** and then use the up or down arrow beside the key to select the desired patient.
3. Select **[Admit]** to access **[Patient Demographics]** menu.
4. Select **[Ok]**. If necessary, you can modify patient information and then select **[Ok]**.

In **[Local Patient List]**, you also can:

- Select **[Add New]**, and then **[Patient Demographics]** menu displays. Input patient information and then select **[Ok]** to admit the patient.
- Select **[Delete]** to remove currently selected patient from the monitor.
- Select **[Delete All]** to remove all the patients from the monitor.

NOTE

-
- **When a patient's demographics are deleted, the corresponding patient data is also deleted from the monitor.**
 - **You cannot delete the patient currently being monitored.**
-

Admitting a Patient from [ADT Database]

When the monitor is connected to ADT database through the eGateway, the monitor can obtain patient information from the ADT database.

1. Access the **[ADT Database]** screen by either way.
 - ◆ Select **[Patient List]** QuickKey→**[ADT Database]** tab.
 - ◆ Aim the 2D barcode scanner at the patient barcode. Refer to **4.1.2.2 With Two-Dimension (2D) Barcode Scanner** for scanner and monitor configuration.
2. Search a patient.
 - ◆ Input **[Department]** name, and then the system searches for the patient within the department.
 - ◆ Input **[MRN]**, and then the system searches for the patient according to the input medical record number.
 - ◆ Input **[Last Name]** and/or **[First Name]**, and the system searches for the patient by last name and/or first name.
3. Select the page key (for example, \wedge \vee), and then use the up or down arrow beside the key to turn to another page, or select **[Scroll]** and then use the up or down arrow beside the key to select the desired patient.
4. Select **[Admit]** to access **[Patient Demographics]** menu.
5. Select **[Ok]**. If necessary, you can modify patient information and then select **[Ok]**.

4.2 Manually Input Patient Data

You can choose whether to display the manual input area on the screen and configure the items to be displayed in the manual input area:

1. Select **[Main]**→**[Maintenance >>]**→**[User Settings >>]**→enter the required password→Select **[Ok]** to access **[User Settings]** menu.
2. Select **[Manual Inputs>>]**. The following screen displays.

3. In the **[Manual Inputs Setup]** menu, you can
 - ◆ Configure the items to be displayed in the manual input area.
 - ◆ Select **[Manual Input Area]** and toggle between **[On]** and **[Off]** to display or hide the manual input area in the main screen.

The following picture shows the manual input area which is located at the bottom of the screen if **[Manual Input Area]** is turned on.

Pain Score	Temp	Blood Sugar	RR	I/O Fluid	LOC
2	36.0 °C	36.00 mmol/L	22 rpm	85/33 ml	Alert

After the manual input area is selected, the **[Manual Inputs]** menu pops up. The displayed items correspond to the settings in **[Manual Inputs Setup]**.

Manual Inputs

Manual Inputs

Pain Score Height cm

Temp °C Weight kg

Blood Sugar mmol/L I/O Fluid / ml

RR rpm LOC(AVPU)

Modifiers

Patient Position O2 Source

NIBP Location Inspired O2% %

Temp Position O2 Flow Rate LPM

4. Select to save the configuration and exit the menu.

4.3 Manually Save Patient Data

Select the [Save] QuickKey to save the demographics, scoring data, and manually entered data for the current patient.

You can configure the data processing mode for the manually saved data.

1. Select [Main]→[Maintenance >>]→[User Settings >>]→enter the required password→select [OK] to access [User Settings] menu.
2. Select ["Save" Button Options >>].
3. In ["Save" Button Setup] menu, select the followings:
 - ◆ [Automatically Send On Manual Save]: the data saves locally and is sent to the external devices when the [Save] QuickKey is selected and confirmed.
 - ◆ [Automatically Record On Manual Save]: the data saves locally and prints to the recorder when the [Save] QuickKey is selected and confirmed.
 - ◆ [Clear Clinician ID at Saving] : the data saves locally and the monitor clears the clinician ID when the [Save] Quickkey is selected.
 - ◆ [Open 'Results' Menu at Saving]: the data saves locally and the [Results] menu displays when the [Save] QuickKey is selected. You can edit patient demographics and manual input data at [Results] menu.
 - ◆ [Discharge Patient at Spot Check Saving] : the data saves locally and the monitor discharges the current patient when the [Save] QuickKey is selected.
4. Select to save the configuration and exit the menu.

4.4 Reviewing Patient Data

Select **[Review]** QuickKey, and you can review the trends.

In Monitor mode, you can view:

- Spot check trends
- Continuous trends
- Graphic trends

In Spot Check mode, you can only view Spot Check Trends.

4.4.1 Spot Check Trends

Select the **[Spot Check Trends]** tab to access the Spot Check Trends screen.

The screenshot shows the 'Spot Check Trends' screen with a table of patient data. The table has columns for MRN, Time, SpO2, PR, NIBP, Temp, CO2(ET/FI), and RR. Annotations (1) through (4) point to specific features: (1) points to the table itself, (2) points to the bottom button area, (3) points to the data status icons (question marks) on the left, and (4) points to a yellow highlight in the PR column for the first row.

MRN	Time	SpO2	PR	NIBP	Temp	CO2(ET/FI)	RR
55	2016-04-12 10:28:21	96	80	166/100 (122)	37.6	38/2	20
Unknown	2016-04-12 09:42:14	100	--	166/100 (122)	37.6	38/2	20
Unknown	2016-04-12 09:42:11	100	--	166/100 (122)	37.6	38/2	20
Unknown	2016-04-11 21:23:29	100	80	166/100 (122)	37.6	38/2	20
Unknown	2016-04-11 21:22:41	100	80	166/100 (122)	37.6	38/2	20

At the bottom, there is a status bar with icons for 'Pat. Info. Incomplete', 'Send Successful', 'Saved to Device Only', and 'Send Failure'. Below this is a page indicator '1/1' and an 'Edit' button. At the very bottom are 'Delete', 'Print', and 'Send' buttons.

(1) Tabular trend

(2) Button area

(3) Data status

(4) Parameter value triggering alarm





In this tab, you can:

- Select **[MRN]** or **[Name]** and then select the desired patient.
- Select **[Filter]** to select parameter trends you want to review.
- Select the page key (for example and then use up or down arrow beside the key to turn the page.
- Select **[Edit]** to edit patient demographics or manual input data of selected patient.
- Select **[Delete]** to delete the trend data of selected patient.
- Select **[Print]** to print the trend data of selected patient.
- Select **[Send]** to transmit the selected patient's trend data to the EMR through an eGateway.

NOTE

- The trend data can only be sent out when the monitor is connected to Electronic Medical Record system (EMR).

In the spot check tabular trends:

- Parameter value triggering high level alarm has a red background; parameter value triggering medium or low level alarm has a yellow background.
- The required patient demographics that is not fully filled display as 
- Patient data successfully sent to the EMR displays as 
- Patient data that failed to transmit to the EMR displays as 
- Patient data that is cached on the device but not transmitted displays as 

4.4.2 Continuous Trends



Select **[Continuous Trends]** tab to access the Continuous Trends screen.



MRN	All	Interval	2 h		
MRN	Time	SpO2	PR	NIBP	Temp
Unknown	2013-11-07 16:00:00	98	49	160/60/93	38.0 15.57
test	2013-11-07 14:00:00	90	60	--/--/--	--
test	2013-11-07 12:00:00	90	60	--/--/--	41.0 10.02
test	2013-11-07 10:00:00	--	--	--/--/--	40.0 09.59
Unknown	2013-05-11 22:00:00	100	80	--/--/--	38.0 21.59
Unknown	2013-05-11 20:00:00	100	80	--/--/--	38.0 19.59
Unknown	2013-05-11 18:00:00	100	80	--/--/--	38.0 17.59
Unknown	2013-05-11 16:00:00	100	80	--/--/--	38.0 15.59
Unknown	2013-05-11 14:00:00	100	80	--/--/--	38.0 13.59
Unknown	2013-05-11 12:00:00	100	80	--/--/--	38.0 11.59
Unknown	2013-05-11 10:00:00	100	80	--/--/--	38.0 09.59

- (1) Tabular trend (2) Button area (3) Parameter value triggering alarm

In this tab, you can:

- Select **[MRN]** or **[Name]** to select the desired patient.
- Select **[Interval]** to set the interval for the data to be displayed.
- Select the page key (for example  1/1 ), and then use up or down arrow beside the key to turn the page.
- Select **[Print]** to print the trend data of selected patient.
- Select **[Delete All]** to delete the trend data of selected patient.

Parameter value triggering high level alarm has a red background; parameter value triggering medium or low level alarm has a yellow background.

4.4.3 Graphic Trends

Select **[Graphic Trends]** tab to access the Graphic Trends screen. The Graphic Trend screen displays the current patient's physiological trend.

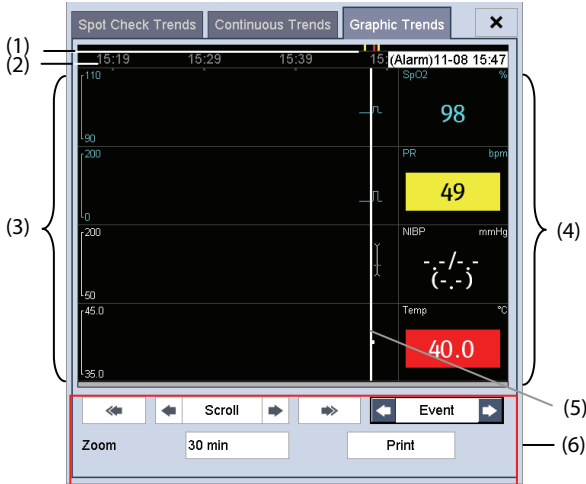

- (1) Event mark area
- (2) Time scale
- (3) Graphic area
- (4) Parameter area
- (5) Cursor
- (6) Button area

A timestamp indicating your current position is displayed above the parameter area. The parameter value corresponding to the cursor time appears in the parameter area. The measurement value that triggered a high level alarm has red background. The measurement that triggered the medium/low level alarm has a yellow background.

Events are marked with colors in the event mark area. Red represents a high level alarm event. Yellow represents a medium/low level alarm event.

In the Graphic Trends screen, you can:

- Select **[Zoom]** to set the time length of the trend displayed on the screen.
- Select **[Scroll]** and control or key to move the cursor. Select or to move the cursor to the previous or next page.
- Select **[Event]** and control or key to quickly locate the event.
- Select **[Print]** to print the selected patient's graphic trend data currently on the screen.

NOTE

- **Pausing or switching off alarms will not be recorded as events. The time of these operations will not be recorded in the system log.**
 - **A total loss of power has no impact on the saved events.**
 - **Events recorded earlier might be overwritten by later ones if the storage memory reaches capacity.**
-

4.5 Transferring Data from the Monitor to USB Drive

1. Insert a USB drive into the USB connector on the monitor.
 2. Select **[Main]**→**[Maintenance >>]**→**[User Settings >>]**→enter the required password→select **[Ok]** to access **[User Settings]** menu.
 3. Select **[Transfer Data to USB]**.
 4. Select **[Period]** and select your desired time.
 5. Select **[Transfer Data]**.
-

CAUTION

- **The USB drive you use may have write-protect function. In this case, please make sure the USB drive for data transfer is in read/write mode.**
 - **Do not remove the storage medium during data transfer process. Otherwise, data files may be damaged.**
 - **The normal monitoring function will be affected during data export. Do not perform any monitoring activity during data export.**
-

5 Managing Configurations

5.1 Overview

When performing continuous patient monitoring, the clinical professional often needs to adjust the monitor's settings according to the patient's condition. The collection of all these settings is called a configuration. The monitor provides different sets of configurations to accommodate the varying patient categories and departments. You can change the settings from a default configuration and then save it as a user configuration.

WARNING

- **The configuration management function is password protected. The configuration management tasks must be performed by clinical professionals.**
-

The system configuration items can be classified as:

- **Parameter configuration items**
These items relate to parameters, e.g. alarm switch, alarm limits.
- **Conventional configuration items**
These items define how the monitor works, e.g., display setup, print and alarm settings.
- **User maintenance items**
These items relate to user maintenance settings, e.g., unit setup, time format.

For the important configuration items and their default values and user maintenance items, see Appendix C Default Configurations.

5.2 Accessing [Manage Configuration] Menu

1. Select **[Main]**→**[Maintenance >>]**→**[User Settings >>]**. Enter the required password and then select **[Ok]**.
2. Select **[Manage Configuration >>]**.

5.2.1 Setting Default Configuration

The monitor will load the pre-set default configuration in the following cases.

- The monitor restarts after being switched off for more than 120 seconds.
- A patient is admitted.
- A patient is discharged.
- Patient category is changed.

The default configuration may come from the latest configuration, the factory default configuration or the user configuration.

To set the default configuration:

1. Select [**Select Default Config >>**] in the [**Manage Configuration**] menu.
2. Select [**Load the Latest Config**] or [**Load the Specified Config**] in [**Select Default Config**] menu.

When you select [**Load the Specified Config**], the configuration (adult, pediatric or neonate) to be restored is subject to the patient category. This configuration can be either factory configuration or saved user configuration. Take adult as an example, select [**Default Adult Config**] and toggle between [**Defaults**] and user configuration(s).

NOTE

- **When the monitor powers on, it shows what configuration is restored in the message area for about 30 seconds.**
-

5.3 Saving Current Settings

Current settings can be saved as user configuration. Up to 3 user configurations can be saved.

To save current settings:

1. Select [**Save Current Settings As>>**] in the [**Manage Configuration**] menu.
2. In the popup dialog box, enter the configuration name and then select [**Ok**].

5.4 Deleting a Configuration

To delete a configuration:

1. Select [**Delete Config >>**] in the [**Manage Configuration**] menu. The popup menu shows the existing user configurations on the monitor. Selecting [**Config on USB drive >>**] will show the existing user configurations on the USB drive.
2. Select the user configurations you want to delete and then select [**Delete**].
3. Select [**Yes**] in the popup.

5.5 Transferring a Configuration

When installing several monitors with identical user configuration it is not necessary to set each unit separately. Use a USB drive to transfer the configuration from monitor to monitor.

To export the current monitor's configuration:

1. Insert a USB disk to the monitor's external device connector.
2. Select [**Export Config >>**] in the [**Manage Configuration**] menu.
3. In the [**Export Config**] menu, select the configurations and the user maintenance settings to be exported. Then select the [**Export**] button. A status message will report completion of the transfer.

To import the configuration from the USB drive to the monitor:

1. Insert a USB drive into the monitor's external device connector.
2. Select [**Import Config >>**] in the [**Manage Configuration**] menu.
3. In the [**Import Config**] menu, select the configurations and the user maintenance settings to be imported. Then select the [**Import**] button. A status message will report completion of the transfer.

5.6 Loading a Configuration

You may make changes to some settings during operation. However, these changes or the pre-selected configuration may not be appropriate for the newly admitted patient. Therefore, the monitor allows you to load a desired configuration so as to ensure that all the settings are appropriate for your patient.

To load a configuration:

1. Select [**Main**]→[**Load Configuration >>**]. The popup menu shows the existing configurations on the monitor. Selecting [**Config on USB drive >>**] will show the existing configurations on the USB drive.
2. Select a desired configuration.
3. Select [**Load**].

The current configuration is shown at the top of the [**Load Configuration**] menu.

5.7 Restoring the Latest Configuration Automatically

During operation, you may make changes to some settings. However, these changes may not be saved as user configurations. To prevent the changes from being lost in case of a sudden power failure, the equipment stores the configuration in real time. The saved configuration is the latest configuration.

The monitor restores the latest configuration if it restarts within 60 seconds after a power failure. And it restores the default configuration, rather than the latest configuration, if it restarts 120 seconds after a power failure. The monitor loads either the latest configuration or the default configuration if it restarts from 60-120 seconds after a power failure.

FOR YOUR NOTES

6 Alarms

Alarms, triggered by an abnormal vital sign or technical issue with the monitor, are visually and audibly indicated to the user.

WARNING

- **A potential hazard can exist if different alarm presets are used for the same or similar equipment in any single area, e.g. an intensive care unit or cardiac operating room.**
 - **If your equipment is connected to a CMS, remote suspension, inhibition, and reset of monitor alarms via the CMS may cause a potential hazard. For details, refer to the CMS's instructions for use.**
-
-

6.1 Alarm Categories

The equipment's alarms can be classified into two categories: physiological alarms and technical alarms.

1. Physiological alarms

Physiological alarms, also called patient status alarms, are triggered by a monitored parameter value that violates set alarm limits or an abnormal patient condition. The physiological alarms occur only in Monitor mode.

2. Technical alarms

Technical alarms, also called system status alarms, are triggered by a device malfunction or a patient data distortion due to improper operation or mechanical problems.

Apart from the physiological and technical alarm messages, the monitor shows some messages telling the system status or patient status. System related messages are displayed in system message area; parameter related messages are displayed in the respective parameter message area.

6.2 Alarm Levels

By severity, the equipment's alarms can be classified into three categories: high level, medium level and low level.

	Physiological Alarms	Technical Alarms
High level	Indicate that your patient is in a life threatening situation and an emergency treatment is demanded.	Indicate a severe device malfunction or an improper operation, which could make it possible that the monitor cannot detect critical patient status and thus threaten the patient's life, such as low battery.
Medium level	Indicate that your patient's vital signs appear abnormal and an immediate treatment is required.	Indicate a device malfunction or an improper operation, which may not threaten the patient's life, but may compromise the monitoring of vital physiological parameters.
Low level	Indicates that your patient's vital signs appear abnormal and immediate treatment may be required.	Indicate a device malfunction or an improper operation, which may compromise a certain monitoring function, but will not threaten the patient's life.

6.3 Alarm Indicators

When an alarm occurs, the equipment will indicate it to the user through visual or audible alarm indications.

- Alarm lamp
- Audible alarm tones
- Alarm message
- Flashing numerics

6.3.1 Alarm Lamp

If a technical alarm or physiological alarm occurs, the alarm lamp will flash. The color and flashing frequency match the alarm level as follows:

- High level alarms: the lamp quickly flashes red.
- Medium level alarms: the lamp slowly flashes yellow.
- Low level alarms: the lamp lights yellow without flashing.

NOTE

-
- **When multiple alarms of different levels occur simultaneously, the alarm lamp flashes and the alarm tone sounds according to the alarm of the highest level, and the alarm messages are displayed circularly.**
-

6.3.2 Audible Alarm Tones

The monitor uses different alarm tone patterns to match the alarm priority.

The alarm tone is distinct from keystroke tone and pulse tone in frequency.

The alarm tones identify the alarm levels as follows:

- High level alarms: triple+double beeps+triple+double beep
- Medium level alarms: triple beep
- Low level alarms: single beep

The interval of alarm tone is configurable. Refer to section **6.5.3 Setting the Interval between Alarm Sounds**.

NOTE

- **When multiple alarms of different levels occur simultaneously, the monitor will select the alarm of the highest level, light the alarm lamp and give alarm sounds accordingly. Multiple alarm messages scroll on the screen.**
 - **Some physiological alarms, such as the Desat alarm, are exclusive. They have identical alarm tones and alarm lights as normal high level physiological alarms, but their alarm messages are displayed exclusively. When an exclusive physiological alarm and a normal high level physiological alarm are triggered simultaneously, only the exclusive physiological alarm message is displayed.**
-

6.3.3 Alarm Messages

When an alarm occurs, an alarm message will appear in the technical or physiological alarm area.

The alarm message has different background color which matches the alarm level.

- High level alarms: red
- Medium level alarms: yellow
- Low level alarms: yellow

For physiological alarms, the asterisk symbols (*) before the alarm message match the alarm level as follows:

- High level alarms: ***
- Medium level alarms: **
- Low level alarms: *



When there are multiple messages, the messages scroll.

6.3.4 Flashing Numerics

If an alarm triggered by an alarm limit violation occurs, the numeric of the measurement in alarm will flash every second, and the corresponding alarm limit will also flash at the same frequency indicating the high or low alarm limit is violated.

6.3.5 Alarm Status Symbols

Apart from the aforementioned alarm indicators, the equipment also uses the following symbols telling the alarm status:

-  indicates alarms are paused.
-  indicates alarms are reset.
-  indicates the alarm sound is turned off.

6.4 Setting Alarms

You can set the switch, limit and level of physiological alarms.

Select **[Main]**→**[Alarm Setup >>]**, and then access the **[Alarm Setup]** screen.

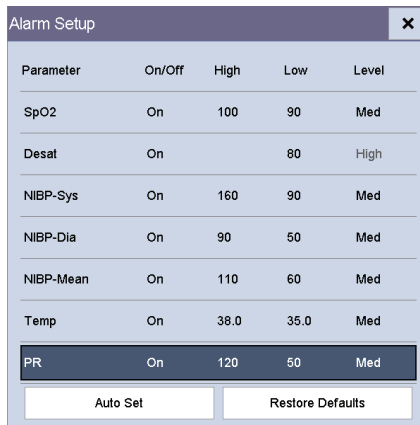

Parameter	On/Off	High	Low	Level
SpO2	On	100	90	Med
Desat	On		80	High
NIBP-Sys	On	160	90	Med
NIBP-Dia	On	90	50	Med
NIBP-Mean	On	110	60	Med
Temp	On	38.0	35.0	Med
PR	On	120	50	Med

Auto Set Restore Defaults

- **[Auto Set]**: The monitor will create new alarm limits based on the measured values.
- **[Restore Defaults]**: The restored defaults depend on the settings in **[Select Default Config]** screen. If the latest configuration is set as the default configuration, then the factory configuration will be loaded for the alarm settings; if a specified configuration is set as the default configuration, then the specified configuration will be loaded for the alarm settings. Refer to **5.2.1 Setting Default Configuration**.

WARNING

- **Make sure that the alarm limits settings are appropriate for your patient before monitoring.**
 - **Setting alarm limits to extreme values may cause the alarm system to become ineffective. For example, High oxygen levels may predispose a premature infant to retrolental fibroplasia. If this is a consideration do NOT set the high alarm limit to 100%, which is equivalent to switching the alarm off.**
-

6.5 Selecting Alarm Properties

6.5.1 Changing the Alarm Volume

Select [Main]→[General Setup >>]→[Alarm Volume].

The alarm volume range is between X and 10. X is the minimum volume, which depends on the setting of minimum alarm volume (refer to **6.5.2 Setting the Minimum Alarm Volume**), and 10 is the maximum volume.

When alarm volume is set to 0, the alarm sound is turned off and a  symbol appears on the screen.

6.5.2 Setting the Minimum Alarm Volume

The minimum alarm volume refers to the minimum value you can set for the alarm volume, which is not affected by user or factory default configurations.

1. Select [Main]→[Maintenance >>]→[User Settings >>]→Enter the required password→Select [Ok] to access [User Settings] menu.
2. Select [Alarm Setup >>] to access [Alarm Setup] menu.
3. Select [Minimum Alarm Volume] and then select the appropriate settings.

6.5.3 Setting the Interval between Alarm Sounds

1. Select [Main]→[Maintenance >>]→[User Settings >>]→Enter the required password→Select [Ok] to access [User Settings] menu.
2. Select [Alarm Setup >>] to access [Alarm Setup] menu.
3. Select [High Alarm Interval (s)], [Med Alarm Interval (s)] and [Low Alarm Interval (s)] in turn and then select the appropriate settings.

WARNING

- **When the alarm sound is switched off, the equipment will give no audible alarm tones even if a new alarm occurs. Therefore the user should be very careful about whether to switch off the alarm sound or not.**
 - **Do not rely exclusively on the audible alarm system for patient monitoring. Adjustment of alarm volume to a low level may result in a hazard to the patient. Always keep the patient under close surveillance.**
-

6.5.4 Adjusting Alarm Limits Automatically

The monitor can automatically adjust alarm limits according to the measured vital signs, using the auto limits function. When auto limits are selected, the monitor calculates safe auto limits based on the latest measured values.

To get accurate auto alarm limits, you need to collect a set of measured vital signs as a baseline. Then, in the main menu, select [Main]→[Alarm Setup >>]→[Auto Set]→Select [Ok] in the pop-up window. The monitor will create new alarm limits based on the

measured values.

Before applying these automatically created alarm limits, confirm if they are appropriate for your patient. If not, you can adjust them manually.

The monitor calculates the auto limits based on the following rules.

Parameter	Low alarm Limit		High alarm Limit		Auto-set alarm limit Range
	Adult/Pediatric	Neonate	Adult/Pediatric	Neonate	
SpO ₂	Same as the default alarm limit	Same as the default alarm limit	Same as the default alarm limit	Same as the default alarm limit	Same as the measurement range
PR	(PR×0.8) or 40 bpm, whichever is greater	(PR-30) or 90 bpm, whichever is greater	(PR×1.25) or 240 bpm, whichever is smaller	(PR+40) or 200 bpm, whichever is smaller	Adult/Pediatric: 35 to 240 bpm Neonate: 55 to 225 bpm
NIBP-S	(SYS×0.68) + 10 mmHg	(SYS-15) or 45 mmHg, whichever is greater	(SYS×0.86) + 38 mmHg	(SYS+15) or 105 mmHg, whichever is smaller	Adult: 45 to 270 mmHg Pediatric: 45 to 185 mmHg Neonate: 35 to 115 mmHg
NIBP-D	(Dia×0.68) + 6 mmHg	(Dia-15) or 20 mmHg, whichever is greater	(Dia×0.86) + 32 mmHg	(Dia + 15) or 80 mmHg, whichever is smaller	Adult: 25 to 225 mmHg Pediatric: 25 to 150 mmHg Neonate: 20 to 90 mmHg
NIBP-M	(Mean×0.68) + 8 mmHg	(Mean-15) or 35 mmHg, whichever is greater	(Mean×0.86) + 35 mmHg	(Mean + 15) or 95 mmHg, whichever is smaller	Adult: 30 to 245 mmHg Pediatric: 30 to 180 mmHg Neonate: 25 to 105 mmHg
Temp	(T-0.5) °C	(T-0.5) °C	(T+0.5) °C	(T+0.5) °C	Same as the measurement range

6.6 Pausing Alarms

You can temporarily disable alarm sound of all alarms by pressing and holding  hardkey on the panel for above 2 seconds.

When alarms are paused,

- The alarms pause symbol  and the remaining alarm pause time are displayed in Alarm Information area.
- For physiological alarms, alarm indicators are not shown. New physiological alarms will not be presented. If the alarm condition still exists once the pause time expires, the alarms will be presented.
- For technical alarms, alarm sounds are paused, but alarm lamps and alarm messages remain presented.

The default alarm pause time is 2 minutes. When the alarm pause time expires, or the low battery alarm occurs, the alarm paused status is automatically deactivated. You can also cancel the alarm paused status by pressing and holding the  hardkey for more than 2 seconds.

6.7 Switching Off Alarm Sound

When alarm volume is set to 0, the alarm sound is turned off. In the audio alarm off state,

- The Audio Off symbol  is displayed.
- Audio indication of all alarms is suspended.

You can cancel the alarm sound off status by setting alarm volume to a value from 1 to 10.

WARNING

- **Pausing or switching off alarms may result in a hazard to the patient. Please be very careful.**
-

6.8 Resetting Alarms

By pressing the  hardkey, you can reset the alarm system to acknowledging the on-going alarms and enable the alarm system to respond to a subsequent alarm condition.

For physiological alarms, except the NIBP-related alarms, when the alarm system is reset:

- The alarm sound is silenced.
- A √ appears before the alarm message, indicating that the alarm is acknowledged.
- The icon  appears in the alarm symbol area.
- The parameter numeric and alarm limits still flash.

The indication of alarm lamp for the physiological alarm depends on the alarm light setting.

- When **[Alarm Light on Alarm Reset]** is set to **[On]**, the alarm lamp remains flashing.
- When **[Alarm Light on Alarm Reset]** is set to **[Off]**, the alarm lamp stops flashing.

To set **[Alarm Light on Alarm Reset]**:

1. Select **[Main]**→**[Maintenance >>]**→**[User Settings >>]**→enter the required password→Select **[Ok]** to access **[User Settings]** menu.
2. Select **[Alarm Setup >>]** to enter the **[Alarm Setup]** menu.
3. Select **[Alarm Light on Alarm Reset]**, and toggle between **[On]** and **[Off]**.

The default setting for **[Alarm Light on Alarm Reset]** is **[On]**.

Technical alarms give different alarm indicators when the alarm system is reset:

- For some technical alarms, including the NIBP-related alarms, a ✓ appears before the alarm message and  appears in the alarm symbol area, indicating that the alarm is acknowledged. The indication of the alarm lamp depends on the alarm light setting.
- Some technical alarms are changed to the prompt messages.
- Some technical alarms are cleared. The monitor gives no alarm indications.

For details about the indications of technical alarms when the alarm system is reset, refer to **D.2 Technical Alarm Messages**.

6.9 Setting the Reminder Tone

When the alarm volume is set to zero, or alarm is reset, the monitor can issue a periodical reminder tone. The interval of the reminder tone is 1 minute. You can switch on or off the reminder tone.

1. Select **[Main]**→**[Maintenance >>]**→**[User Settings >>]**→Enter required password→Select **[Ok]** to access **[User Settings]** menu.
2. Select **[Alarm Setup >>]** to access **[Alarm Setup]** menu.
3. Set **[Reminder Tone]** to **[On]** or **[Off]**.

6.10 Latching Alarms

The latching setting for physiological alarms defines how alarm indicators behave when you do not acknowledge them.

- If an alarm is latched, alarm indications remain presented even though alarm conditions end, except that:
 - ◆ The parameter reading and violated alarm limit stop flashing.
 - ◆ The time when the alarm is last triggered is displayed after the alarm message.
- If an alarm is not latched, the alarm indications disappear as soon as the alarm conditions end.

When the alarm system is reset, the latched physiological alarms are cleared.

To latch a physiological alarm,

1. Select [**Main**]→[**Maintenance >>**]→[**User Settings >>**]→Enter required password→Select [**Ok**] and then access [**User Settings**] menu.
2. Select [**Alarm Setup >>**].
3. Set [**Alarm Latch**] to [**High only**], [**High&Med**], [**All**] or [**Off**].
 - ◆ [**High only**]: only high priority alarms are latched;
 - ◆ [**Hi&Med**]: both high priority alarms and medium priority alarms are latched;
 - ◆ [**All**]: all alarms are latched; and
 - ◆ [**Off**]: no alarm will be latched.

Only the unacknowledged physiological alarm can be latched. The latched alarms will be cleared when the monitor enters the alarm reset state.

NOTE

- **Changing of alarm priority may affect the latching status of corresponding alarm. Determine if you need to reset the latching status for the specific alarm after changing its alarm priority.**
-

6.11 Actions for Alarm Occurrence

When an alarm occurs, observe the following steps and take proper actions:

1. Check the patient's condition.
2. Confirm the alarming parameter or alarm category.
3. Identify the source of the alarm.
4. Take proper action to eliminate the alarm condition.
5. Make sure the alarm condition is corrected.

For details about how to deal with specific alarms, refer to **Appendix D Alarm Messages**.

6.12 Nurse Call

The monitor provides a multi-function connector to output nurse call signals when a user-defined alarm occurs. To obtain a nurse call signal, use the nurse call cable (P/N: 009-003116-00) we supply to connect the hospital nurse call system to the multi-function connector of the monitor and then follow this procedure:

1. Select [**Main**]→[**Maintenance >>**]→[**User Settings >>**]→Enter required password→Select [**Ok**] and then access [**User Settings**] menu.
2. Select [**Nurse Call >>**] to access the [**Nurse Call Setup**] menu.
3. Select [**Signal Type**] and toggle between [**Pulse**] and [**Continuous**].
 - ◆ [**Pulse**]: the nurse call signal is a pulse signal and each pulse lasts 1 second. When multiple alarms occur simultaneously, only one pulse signal is output. If an alarm occurs but the previous one is not cleared yet, a new pulse signal will also be outputted.
 - ◆ [**Continuous**]: the nurse call signal lasts until the alarm ends, i.e. the duration of a nurse call signal equals to that of the alarm condition.

4. Select [**Contact Type**] and toggle between [**Normally Open**] and [**Normally Closed**].
 - ◆ [**Normally Open**]: Select if your hospital's nurse call relay contact is normally open.
 - ◆ [**Normally Closed**]: Select if your hospital's nurse call relay contact is normally closed.
5. Select [**Alarm Level**] and set the alarm level for nurse call-triggering alarms.
6. Select [**Alarm Category**] and then select the category to which the nurse call-triggering alarms belong.

Alarm conditions are indicated to nurses only when:

1. The nurse call system is enabled
2. An alarm that meets your preset requirements occurs, and
3. The monitor is not in the alarm paused or silence status.

If no setting is selected from [**Alarm Level**] or [**Alarm Category**], no nurse call signal will be triggered if alarms occur.

WARNING

- **To obtain the nurse call signal, use the nurse call cable (PN: 009-003116-00) we supply. Otherwise the nurse call function will not work and the monitor may be damaged.**
 - **Do not rely exclusively on the nurse call system for alarm notification. Remember that the most reliable alarm notification combines audible and visual alarm indications with the patient's clinical condition.**
-

7 Monitoring SpO₂

7.1 Overview

SpO₂ monitoring is a non-invasive technique used to measure the amount of oxygenated hemoglobin by measuring the absorption of selected wavelengths of light. The light generated in the probe passes through the tissue and is converted into electrical signals by the photodetector in the probe. The SpO₂ module processes the electrical signal and displays a waveform and digital values for SpO₂ and pulse rate.

This device is calibrated to display functional oxygen saturation. It provides the following.

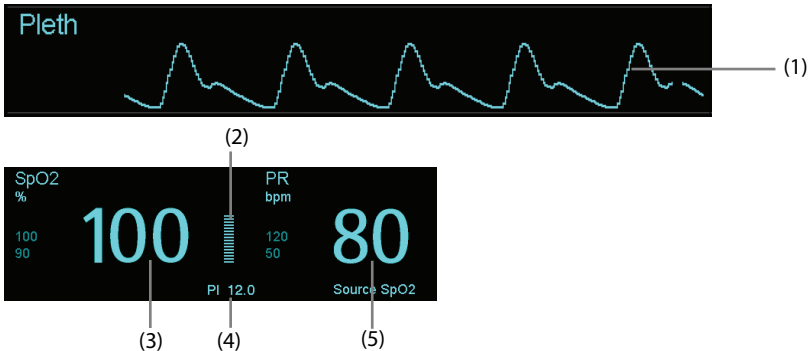

- (1) Pleth waveform (Pleth): visual indication of patient's pulse. The waveform is not normalized.
- (2) PI indicator: Graphic Indication of arterial pulse signal strength.
- (3) Oxygen saturation of arterial blood (SpO₂): percentage of oxygenated hemoglobin in relation to the sum of oxyhemoglobin and deoxyhemoglobin.
- (4) Perfusion index (PI): PI is available for Masimo SpO₂ module. PI gives the numerical value for the pulsatile portion of the measured signal caused by arterial pulsation. PI is an indicator of the pulsatile strength. You can also use it to assess the quality of SpO₂ measurement.
 - ◆ Above 1 is optimal
 - ◆ Between 0.3 and 1 is acceptable.
 - ◆ Below 0.3 indicates low perfusion. When PI is below 0.3, a question mark (?) is displayed to the right of the SpO₂ value, indicating that the SpO₂ value may be inaccurate. Reposition the SpO₂ sensor or find a better site. If low perfusion persists, choose another method to measure oxygen saturation if possible.
- (5) Pulse rate (derived from pleth wave): detected pulsations per minute. Obtain PR through the SpO₂ or NIBP measurement. When simultaneously measuring NIBP and SpO₂, the PR source is from SpO₂.

NOTE

- **If the message "SpO₂ Low Perf." or "SpO₂ Weak Pulse" displays, check sensor application, re-apply or remove the sensor if necessary, to obtain a better signal.**
 - **A function tester or SpO₂ simulator can be used to verify the sensor functions.**
 - **A function tester or SpO₂ simulator can be used to determine the pulse rate accuracy.**
 - **A function tester or SpO₂ simulator cannot be used to assess the accuracy of an SpO₂ module or an SpO₂ sensor.**
-



7.2 Safety

WARNING

- **Only use SpO₂ sensors specified in this manual. Follow the SpO₂ sensor's instructions for use and adhere to all warnings and cautions.**
 - **When a trend toward patient deoxygenation is indicated, blood samples should be analyzed by a laboratory co-oximeter to completely understand the patient's condition.**
 - **Prolonged monitoring may increase the risk of undesirable changes in skin characteristics, such as irritation, reddening, blistering or burns. Inspect the sensor site every two hours and move the sensor if the skin quality changes. Change the application site every four hours. For neonates, or patients with poor peripheral blood circulation or sensitive skin, inspect the sensor site more frequently.**
-

7.3 Identifying SpO₂ Module

To identify which SpO₂ module is incorporated into your monitor, see the company logo located at the side panel. The color of the cable connector matches the company as shown below:

- Masimo SpO₂ module: a purple connector with the Masimo SET logo 
- Nellcor SpO₂ module: a grey connector with the Nellcor logo 

The SpO₂ sensor connectors are mutually exclusive.

7.4 Applying the Sensor

WARNING

- If the sensor is too tight because the application site is too large or becomes too large due to edema, excessive pressure for prolonged periods may result in venous congestion distal from the application site, leading to interstitial edema and tissue ischemia.
-

NOTE

- Place the SpO₂ sensor so that the light source is against the application site.
 - Check if the sensor is in normal condition before monitoring. Do not use the SpO₂ sensor if the package or the sensor is found damaged.
 - Do not apply the sensor on a limb with an intravenous infusion or arterial catheter in place.
-

1. Select an appropriate sensor according to the module type, patient category and weight.
2. Clean the application site. For example, remove colored nail polish.
3. Apply the sensor to the patient.
4. Select an appropriate adapter cable according to the connector type and plug this cable into the SpO₂ connector.
5. Connect the sensor cable to the adapter cable.

7.5 Changing SpO₂ Settings

7.5.1 Accessing SpO₂ Menu

By selecting the SpO₂ parameter or waveform area, you can access the **[SpO₂ Setup]** menu.

7.5.2 Adjusting the Desat Alarm

The Desat alarm is a high level alarm notifying you of potentially life threatening drops in oxygen saturation.

Select **[Alarm Setup >>]** from the **[SpO₂ Setup]** menu. From the pop-up menu, you can set low alarm limit and alarm switch for **[Desat]**. When the SpO₂ value is below the Desat alarm limit and Desat alarm switch is set to **[ON]**, the message **[SpO₂ Desat]** is displayed.

7.5.3 Setting SpO₂ Sensitivity

For Masimo SpO₂ module, you can set **[Sensitivity]** to **[Maximum]** or **[Normal]** in the **[SpO₂ Setup]** menu.

When monitoring neonatal or non-critically ill patients who tend to move a lot, noise or

invalid signals may be caused. In this case, it is recommended that the sensitivity is set to **[Low]** or **[Normal]** so that the interference caused by motion can be filtered and therefore the measurement stability can be ensured.

7.5.4 Changing Averaging Time

The SpO₂ value displayed on the monitor screen is the average of data collected within a specific time. The shorter the averaging time is, the quicker the equipment responds to changes in the patient's oxygen saturation level. Contrarily, the longer the averaging time is, the slower the equipment responds to changes in the patient's oxygen saturation level, but the measurement accuracy will be improved. For critically ill patients, selecting shorter averaging time will help understanding the patient's state.

To set the Masimo SpO₂ averaging time, select **[Averaging]** in the **[SpO2 Setup]** menu and then toggle between **[2-4 s]**, **[4-6 s]**, **[8 s]**, **[10 s]**, **[12 s]**, **[14 s]** and **[16 s]**.

7.5.5 Monitoring SpO₂ and NIBP Simultaneously

When monitoring SpO₂ and NIBP on the same limb simultaneously, you can switch **[NIBP Simultaneous]** on in the **[SpO2 Setup]** menu to lock the SpO₂ alarm status until the NIBP measurement ends. If you switch **[NIBP Simultaneous]** off, low perfusion caused by NIBP measurement may lead to inaccurate SpO₂ readings and therefore cause false physiological alarms.

7.5.6 Sat-Seconds Alarm Management

With traditional alarm management, high and low alarm limits are set for monitoring oxygen saturation. During monitoring, as soon as an alarm limit is violated, an audible alarm immediately sounds. When the patient % SpO₂ fluctuates near an alarm limit, the alarm sounds each time the limit is violated. Such frequent alarms can be distracting. Nellcor's Sat-Seconds alarm management technique is used to reduce these nuisance alarms.

The Sat-Seconds feature is available with the Nellcor SpO₂ module to decrease the likelihood of false alarms caused by motion artifacts. To set the Sat-Seconds limit, select **[Sat-Seconds]** in the **[SpO2 Setup]** menu and then select the appropriate setting.

With Sat-Seconds alarm management, high and low alarm limits are set in the same way as traditional alarm management. A Sat-Seconds limit is also set. The Sat-Seconds limit controls the amount of time that SpO₂ saturation may be outside the set limits before an alarm sounds. The method of calculation is as follows: the number of percentage points that the SpO₂ saturation falls outside the alarm limit is multiplied by the number of seconds that it remains outside the limit. This can be stated as the equation:

$$\text{Sat-Seconds} = \text{Points} \times \text{Seconds}$$

Only when the Sat-Seconds limit is reached, the monitor gives a Sat-Seconds alarm. For example, the figure below demonstrates the alarm response time with a Sat-Seconds limit set at 50 and a low SpO₂ limit set at 90%. In this example, the patient % SpO₂ drops to 88% (2 points) and remains there for 2 seconds. Then it drops to 86% (4 points) for 3 seconds, and then to 84% (6 points) for 6 seconds. The resulting Sat-Seconds are:

% SpO ₂	Seconds	Sat-Seconds
2×	2=	4
4×	3=	12
6×	6=	36
Total Sat-Seconds=		52

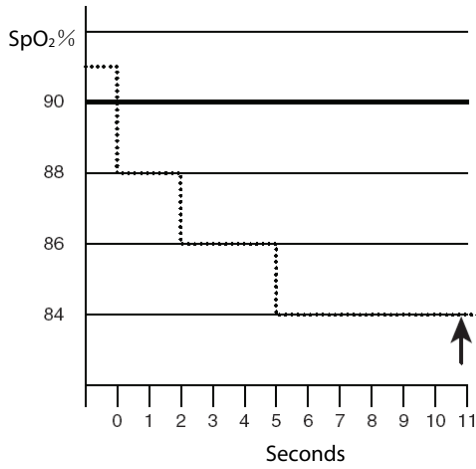

After approximately 10.9 seconds, a Sat-Second alarm would sound, because the limit of 50 Sat-Seconds would have been exceeded.

Saturation levels may fluctuate rather than remaining steady for a period of several seconds. Often, the patient % SpO₂ may fluctuate above and below an alarm limit, re-entering the non-alarm range several times. During such fluctuation, the monitor integrates the number of %SpO₂ points, both positive and negative, until either the Sat-Seconds limit is reached, or the patient %SpO₂ re-enters the non-alarm range and remains there.

7.5.7 Changing the Speed of Pleth Wave

In the [SpO2 Setup] menu, select [Sweep] and then select the appropriate setting. The faster the waveform sweeps, the wider the waveform is.

7.5.8 Setting the Alarm Level for SpO₂ Sensor Off Alarm

In the [SpO2 Setup] menu, select [SpO2SensorOff Lev.] and then select the appropriate setting.

7.6 Measurement Limitations

If the SpO₂ measurement seems out of range or inaccurate, check the patient's vital signs. Then check the equipment and SpO₂ sensor. The following factors may influence the accuracy of measurement:

- Ambient light
- Physical movement
- Low perfusion
- Electromagnetic interference, such as MRI environment
- Electrosurgical units
- Dysfunctional hemoglobin, such as carboxyhemoglobin (COHb) and methemoglobin (MetHb)
- Presence of certain dyes, such as methylene and indigo carmine
- Inappropriate positioning of the SpO₂ sensor, or use of incorrect SpO₂ sensor
- Drop of arterial blood flow to immeasurable levels caused by shock, anemia, low temperature or vasoconstrictor.

7.7 Masimo Information



- Masimo Patents

This device is covered under one or more the following U.S.A. patents: 5,758,644, 6,011,986, 6,699,194, 7,215,986, 7,254,433, 7,530,955 and other applicable patents listed at: www.masimo.com/patents.htm.

- No Implied License

Possession or purchase of this device does not convey any express or implied license to use the device with unauthorized sensors or cables which would, alone, or in combination with this device, fall within the scope of one or more of the patents relating to this device.

7.8 Nellcor Information



- **Nellcor Patents**

This device may be covered by one or more of the following US patents and foreign equivalents: 5,485,847, 5,676,141, 5,743,263, 6,035,223, 6,226,539, 6,411,833, 6,463,310, 6,591,123, 6,708,049, 7,016,715, 7,039,538, 7,120,479, 7,120,480, 7,142,142, 7,162,288, 7,190,985, 7,194,293, 7,209,774, 7,212,847, 7,400,919.

- **No Implied License**

Possession or purchase of this device does not convey any express or implied license to use the device with unauthorized replacement parts which would, alone, or in combination with this device, fall within the scope of one or more of the patents relating to this device.

FOR YOUR NOTES

8 Monitoring PR

8.1 Overview

The pulse numeric counts the arterial pulsations that result from the mechanical activity of the heart. The pulse value can be from SpO₂ or NIBP. The PR parameter area displays its source.



- (1) PR high limit
- (2) PR low limit
- (3) Pulse rate (PR): detected pulsations per minute
- (4) PR Source

NOTE

-
- **A function tester or SpO₂ simulator can be used to determine the pulse rate accuracy.**
-

8.2 PR Source

The current pulse source is displayed in the PR parameter area. The pulse rate is:

- stored in the monitor's database and reviewed in the graphic/tabular trends.
- sent via the network to the central monitoring system, if available.

8.3 Pulse Tone

You can change the pulse tone volume by adjusting [Beat Volume] in the [SpO₂ Setup] menu. When a valid SpO₂ value exists, the system will adjust the pulse tone according to the SpO₂ value.

FOR YOUR NOTES

9 Monitoring NIBP

9.1 Overview

The monitor uses the oscillometric method to measure the non-invasive blood pressure (NIBP). This measurement can be used for adults, pediatric and neonatal patients. To understand how this method works, we will compare it to the auscultative method.

With auscultation, Clinicians listen to the Korotkoff sounds to determine blood pressure when using the auscultatory method. The estimated mean pressure can then be calculated with reference to these.

Since the monitor cannot hear the Korotkoff sounds to determine the blood pressure, it measures cuff pressure oscillation amplitudes. Oscillations are caused by blood pressure pulses against the cuff. The oscillation with the greatest amplitude is the mean pressure. This is the most accurate parameter measured by the oscillometric method. Once the mean pressure is determined, the systolic and diastolic pressures are calculated with reference to the mean.

The auscultation determines systolic and diastolic pressures and calculates the mean pressure. The oscillometric method measures the mean pressure and determines the systolic and diastolic pressures.

As specified by IEC 80601-2-30, NIBP measurements can be performed during electro-surgery and discharge of defibrillator.

NIBP diagnostic significance must be decided by the clinician who performs the measurement.

NOTE

-
- **Blood pressure measurements determined with this device are equivalent to those obtained by a trained observer using the cuff/stethoscope auscultatory method or an intra-arterial blood pressure measurement device, within the limits prescribed by the American National Standard, Manual, electronic, automated sphygmomanometers, or standards of IEC80601-2-30, EN1060-1, EN1060-3, EN1060-4 and SP10.**
-

9.2 Safety

WARNING

- **During NIBP measurement, the inflated cuff applies pressure on the application site. The clinician determines if NIBP measurement is suitable for the patient.**
 - **Be sure to select the correct patient category setting for your patient before measurement. Incorrect patient category selection may present a safety hazard.**
 - **Do not measure NIBP on patients with sickle-cell disease or on the limb where skin damage has occurred or is expected.**
 - **Use clinical judgement to determine whether to perform frequent unattended blood pressure measurements on patients with severe blood clotting disorders because of the risk of hematoma in the limb fitted with the cuff.**
 - **Do not use the NIBP cuff on a limb with an intravenous infusion or arterial catheter in place. This could cause tissue damage around the catheter when the infusion is slowed or blocked during cuff inflation.**
 - **NIBP measurements can be affected by the measurement site, the position of the patient, patient movement, or the patient's physiologic condition. If the NIBP measurement seems out of range or inaccurate, determine the patient's vital signs by alternative means and then verify that the monitor is working correctly.**
 - **Make sure the hose connecting the NIBP cuff and the monitor is not blocked, twisted, or tangled.**
 - **Do not apply the cuff on the arm on the side of a mastectomy.**
 - **Continuous cuff pressure due to connection tubing kinking may cause blood flow interference resulting injury to the patient.**
-

9.3 Measurement Limitations

The equipment cannot measure blood pressure when the patient's heart rate is below 40 bpm or above 240 bpm, or if the patient is on a heart-lung machine.

The equipment may fail to measure or produce inaccurate blood pressure measurements under the following conditions:

- If arterial pressure pulses are hard to detect
- In the presence of excessive and continuous patient movement such as shivering or convulsions
- During certain cardiac arrhythmias
- Rapid blood pressure changes
- Severe shock or hypothermia that reduces blood flow to the peripheries
- Obesity, where a thick layer of fat surrounding a limb dampens the oscillations emanating from the artery

9.4 NIBP Measurement Mode

There are the following modes of measuring NIBP:

- Manual: measurement on demand.
- Auto: continually repeated measurements at set intervals.
- STAT: continually rapid series of measurements over a five minute period, then return to the previous mode.
- Program: continually automatic measurement at set durations and intervals.

To set NIBP measurement mode, select NIBP parameter area to access **[NIBP Setup]** menu:

- Select **[Interval]** to select manual mode or auto NIBP measurement interval.
- Select **[NIBP STAT]** to start a continuous NIBP measurement.

9.5 Measuring NIBP

9.5.1 Preparing the Patient

In normal use, perform NIBP measurement on a patient who is in the following position:

- Comfortably seated
- Legs uncrossed
- Feet flat on the floor
- Back, arm and feet supported
- Middle of the cuff at the level of the right atrium of the heart.

NOTE

-
- **It is recommended that the patient relax as much as possible before the NIBP measurement is performed and that the patient does not talk during measurement.**
 - **It is recommended that the patient sit still for 5 min before the first measurement is taken.**
 - **The operator should not touch the cuff and tubing during the NIBP measurement.**
 - **Other factors that have been shown to result in an overestimation of blood pressure are labored breathing, full bladder, pain etc.**
-

9.5.2 Preparing to Measure NIBP

1. Power on the monitor.
2. Verify that the patient category is correct. If not, select the  hardkey → **[Patient Demographics]** → **[Patient Category]** and set the patient category to **[Adult]**, **[Pediatric]** or **[Neonatal]**.
3. Connect the NIBP hose to the monitor

4. Select the appropriate sized cuff by referring to the limb circumference marked on the cuff.
The width of the cuff should be 40% (50% for neonates) of the limb circumference, or 2/3 of the upper arm's length. The inflatable part of the cuff should be long enough to encircle at least 50% to 80% of the limb.
5. Apply the cuff to the patient's upper arm or thigh and make sure the Φ marking on the cuff is aligned with the artery. Do not wrap the cuff too tightly around the limb. It may cause discoloration, and ischemia of the extremities. Make sure that the edge of cuff is within the marked range. If it is not, use a cuff that fits properly.
6. Connect the cuff to the NIBP hose. Avoid compression or restriction of NIBP hose. Air must pass unrestricted through the tubing.

WARNING

- **Continuous cuff pressure due to connection tubing kinking may cause blood flow interference and resulting harmful injury to the patient**
-

NOTE

- **Equipment use is restricted to one patient at a time.**
-

9.5.3 Starting NIBP measurement

Start the NIBP measurement in one of the following ways:

- Press the  hardkey on the monitor's front panel.
- Access [NIBP Setup] menu, and then select [Start NIBP] key to start a manual, programmed or automatic NIBP measurement with preset interval.
- Access [NIBP Setup] menu, and then select [NIBP STAT] to start a continuous NIBP measurement.

WARNING

- **Continuous non-invasive blood pressure measurements may cause purpura, ischemia and neuropathy in the limb with the cuff. Periodically examine the limb under the cuff to ensure skin color and integrity. If anything abnormal is seen, move the cuff to another site or stop the non-invasive blood pressure measurements immediately.**
-

9.5.4 Stopping NIBP Measurement

- Press the  hardkey on the monitor's front panel to stop a manual NIBP measurement, or a continuous NIBP measurement.
- Access [NIBP Setup] menu and then select [Stop All] to stop all the NIBP measurement, including manual, continuous, and auto NIBP measurement.

9.5.5 Correcting the Measurement when Cuff is not at Heart Level

Apply the cuff to a limb at the same level as the patient's heart. If the cuff is not at the heart level, do the following to the displayed value:

- Add 0.75 mmHg (0.10 kPa) for each centimetre higher, or
- Deduct 0.75 mmHg (0.10 kPa) for each centimeter lower.

9.6 Understanding the NIBP Numerics

The NIBP display generally shows numerics as shown below. Your display may be configured to look slightly different.

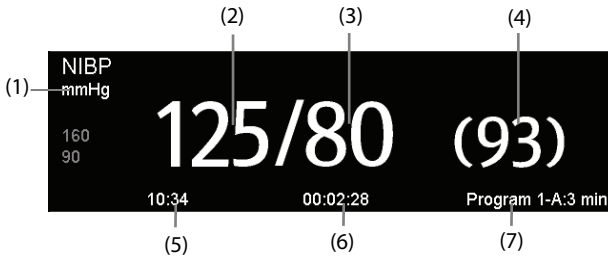

- (1) Unit of pressure: mmHg or kPa
- (2) Systolic pressure
- (3) Diastolic pressure
- (4) Mean pressure obtained after the measurement and cuff pressure obtained during the measurement
- (5) Time of last measurement
- (6) Time remaining to next measurement
- (7) Measurement mode

9.7 Setting NIBP

Select NIBP parameter area to access the **[NIBP Setup]** menu.

9.7.1 Setting Interval

In **[NIBP Setup]** menu, you can select **[Interval]** and set to:

- **[Manual]**: NIBP measurement is started manually.
- **[1 min]**, **[2 min]**, **[2.5 min]**, **[3 min]**, **[5 min]**, **[10 min]**, **[15 min]**, **[20 min]**, **[30 min]**, **[1 h]**, **[1.5 h]**, **[2 h]**: The monitor automatically measures NIBP based on the specified time interval.
- **[Program 1]** and **[Program 2]**: The monitor automatically measures NIBP based on a program configured by user.

9.7.2 Setting the Initial Cuff Inflation Pressure

You can set the initial cuff inflation pressure manually. In the **[NIBP Setup]** menu, select

[Initial Pressure] and then select the appropriate setting.

The initial inflation pressure range is as follows:

Patient Category	Range (mmHg)	Default (mmHg)
Adult	80 - 280	160
Pediatric	80 - 210	140
Neonate	60 - 140	90

NOTE

-
- For known hypertensive patients, you need to set the initial cuff pressure to a higher value to reduce the measurement time.
-

9.7.3 Setting NIBP End Tone

The monitor can issue a reminder tone at the completion of NIBP measurement. The NIBP End Tone is off by default. You can switch it on by accessing the [NIBP Setup] menu.

9.7.4 Switching On/Off Measurement on Clock

In auto measuring mode, if the clock is enabled, the NIBP automatic measurement interval will be synchronized with the real time clock.

For example, if [Clock] is set to [On], and [Interval] is set to [20 min], and then you start an NIBP auto measurement at 14: 03, the next measurement will be taken at 14: 20, and the following measurement time will be 14:40, 15:00 and so on.

9.7.5 Configuring a Custom Program

In the [NIBP Setup] menu, you can select [Custom Program>>] to configure the duration of automatic measurement cycle, and the time interval between two NIBP measurements. You can define two programs, respectively program 1 and program 2. Each program can at most include five cycles: A, B, C, D, and E. In each cycle, the [Duration] and [Interval] can be set individually.

You can start the programmed NIBP measurement manually, and then the monitor automatically performs the measurement based on the cycle and interval you have defined. To start the sequence measurement, follow this procedure:

1. Select the NIBP parameter window to enter the [NIBP Setup] menu.
2. Set [Interval] to [Program 1] or [Program 2].
3. Select [Start NIBP], or Press the  hardkey.

When the programmed NIBP measurement is in use, the NIBP parameter area displays as follows:

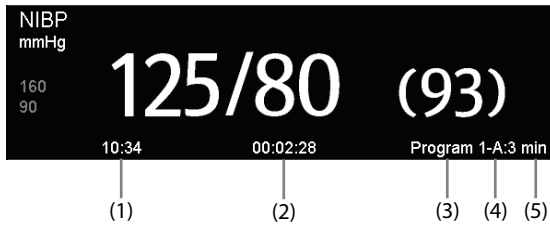

- (1) Time of last measurement
- (2) Time remaining to next measurement
- (3) Program name
- (4) Cycle name
- (5) NIBP measurement Interval

9.7.6 Setting NIBP Alarm Properties

Select [**Alarm Setup >>**] from [**NIBP Setup**] menu. You can set the alarm properties for this parameter in the popup menu.

9.7.7 Setting the Pressure Unit

1. Select [**Main**]→[**General Setup >>**]→[**Unit Setup >>**].
2. In the popup menu, select [**Pressure**] and toggle between [**mmHg**] and [**kPa**].

9.8 Assisting Venous Puncture

You can use the NIBP cuff to cause sub-diastolic pressure to block the venous blood vessel and therefore help venous puncture.

1. Select [**VeniPuncture >>**] from the [**NIBP Setup**] menu. In the pop-up menu, verify that the [**Cuff Press.**] value is appropriate. Change it if necessary.
2. Select the [**VeniPuncture**] key.
3. Puncture vein and draw blood sample.
4. When the puncture is complete, select [**VeniPuncture**] key, or press the  hardkey on the monitor's front panel to deflate the cuff. The cuff deflates automatically after a set time if you do not deflate it.

During puncture, the NIBP display shows the real-time inflation pressure of the cuff, destination inflation pressure, and the remaining time in venous puncture mode.

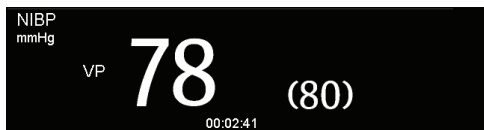

9.9 Care and Cleaning of Reusable Cuffs

NOTE

- **Accuracy of cuff-pressure transducers/indicators is to be verified at intervals specified by the manufacturer.**
-

9.9.1 Reusable Cuffs with Bladders

Take out the bladder before cleaning and disinfecting the cuff.

9.9.2 Cleaning

Hand or machine washes the cuff in warm water or with mild detergent. Clean the bladder with a damp cloth. Air dry the cuff thoroughly after washing.

NOTE

- **Machine washing may shorten the service life of the cuff.**
-

9.9.2.3 Disinfection

Disinfect the cuff with a cloth dampened in 70% isopropanol or with ultraviolet light. Also disinfect the bladder with ultraviolet light.

NOTE

- **Prolonged use of disinfectant may cause discoloration of the cuff.**
-

Replace the bladder after cleaning and disinfecting the cuff:

1. Place the bladder on the top of the cuff (as shown below).
2. Roll the bladder lengthwise and insert it into the large opening.

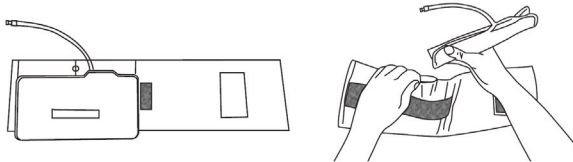

3. Hold the hose and the cuff and shake the complete cuff until the bladder is in position.
4. Thread the hose from inside the cuff, and out through the small hole under the internal flap.

9.9.3 Reusable Bladderless Cuffs

Clean cuffs with warm water and a mild detergent. Do not use a detergent containing hand conditioners, softeners, or fragrances.

Antimicrobial Definition

Bladderless cuffs are treated with an antimicrobial coating. Antimicrobial technology effectively controls a broad spectrum of bacteria, fungi, algae and yeasts on a wide variety of treated substrates.

FOR YOUR NOTES

10 Monitoring Temp

10.1 Overview

The SmarTemp™ Temp module is intended for monitoring oral, axillary and rectal temperature of adult and pediatric patients and axillary temperature of neonatal patients.

Temperature can be measured in either Predictive mode or Monitor mode. The default is Predictive mode.

WARNING

- **Do not take oral temperature on the infant (0-3 years).**
 - **Do not take rectal temperature on the neonate (0-28 days).**
 - **Use only the specified temperature probe and probe cover. Using other probe or probe cover, or not using probe cover may cause damage to the monitor or failure to meet the declared specifications in this manual.**
 - **The temperature probe cover is disposable. Re-use of probe cover may result in patient cross-contamination.**
 - **Use disposable probe covers for temperature measurement. Failure to use a probe cover can cause inaccurate temperature readings, and patient cross-contamination.**
 - **Check the disposable probe cover for damage before using. Never use any probe cover that show signs of damage or contamination for temperature measurement.**
 - **Be careful to avoid damaging the temperature probe. Place the temperature probe in the probe well when not in use.**
 - **Prior to taking a temperature, instruct the patient not to bite down on the probe, as patient injury and damage to the probe may result.**
 - **Ensure that probe covers are disposed of according to local regulations or hospital's requirements.**
 - **Accuracy verification of the temperature module is required every two years or according to your hospital's policy. Please contact Mindray Technical Support department if accuracy verification is needed.**
-
-

NOTE

- **Patient actions may interfere with oral temperature measurements. Ingesting hot or cold liquids, eating food, chewing gum, brushing teeth, smoking, or performing strenuous activities may affect temperature readings for up to 20 minutes after ending the activity.**
 - **In the axillary mode, the probe should directly contact the patient's skin. Measuring through patient's clothes or long-term exposure of patient's armpit to the air may result in inaccurate temperature readings.**
 - **Choose appropriate probe according to measurement site. Using the incorrect probe may cause patient's discomfort and inaccurate measurements.**
 - **Improper use of probe may also cause patient's discomfort and inaccurate measurements.**
 - **In the rectal mode, incorrect probe placement may result in bowel perforation.**
 - **Hospital staff should wash their hands after the patient's temperature measurement is taken. This will significantly reduce the risk of cross contamination and nosocomial contamination.**
-

10.1.1 Setting Temp

Select Temp parameter area to access **[Temp Setup]** menu. You can set:

- Temp type: **[Predictive]** or **[Monitor]**.
- Temperature measurement site: the measurement site is related to the probe type. When using oral/axillary probe, you can select the site **[Oral]** and **[Axillary]**; when using rectal probe, you can select **[Rectal]**.

You can select the temperature type and measurement site only when the probe is in the probe well.

10.2 Preparation

10.2.1 Selecting Measuring Site

The temperature module can be configured with 2 types of temperature probe:

- oral/axillary probe (blue), and
- rectal probe (red)

Use the blue oral/axillary probe with blue probe well, and use the red rectal probe with red well.

Be sure to select correct probe according to the measurement site.

- Oral/Axillary probe: this probe type is intended for taking oral or axillary temperature of adult and pediatric patients, or axillary temperature for neonatal patients.
- Rectal probe: this probe type is intended for taking rectal temperature for adult and pediatric patients.

When oral/axillary probe is used, the measurement site will automatically be set to **[Oral]**. You can change the site in **[Temp Setup]** menu.

10.2.2 Taking a Temperature in Predictive Mode

1. Make sure that the probe is placed in the probe well.
2. Make sure that the temperature measurement type and site settings are correct.
3. Remove the probe from the probe well and insert it into a cover in the probe cover pack. Press the probe handle down firmly until the cover engages with the probe.

The temperature module starts to warm up when the probe is taken out of the probe well. The message "Temp Warming Up" displays in Temp parameter area. The warming up time is about 2 seconds at room temperature. The monitor sounds two beeps and displays the message "Temp Prediction Ready" on the screen when warm-up is complete. Then you can place the probe at the measurement site.

4. Place the probe at the measurement site and wait until the measurement stabilizes.

When the dynamic symbol  appears, it indicates that the monitor starts to take the measurement.

- ◆ When taking an oral temperature, apply the probe under the patient's tongue from either side of the mouth. Make sure that the probe reaches the rear sublingual pocket. Have the patient close his/her lips to hold the probe. Use your hand to hold the probe in place. Make sure that the probe contacts with the patient's oral tissue throughout the measurement.
- ◆ When taking an axillary temperature, lift the patient's arm to expose the entire armpit. Apply the probe as high as possible in the armpit. Check that the probe tip is completely surrounded by the axillary tissue. Lower the patient's arm so that it is tightly placed at the patient's side. Keep the patient's arm and the probe in place throughout the measurement.
- ◆ When taking a rectal temperature, separate the patient's buttocks with one hand, and gently glide the probe 0.6 inch (1.5 cm) inside the rectum with the other hand. For pediatric patients, the depth of insertion is less. Tilt the probe so that it always contacts with patient's tissue. Lubricant can be used in rectal mode.

The monitor sounds a beep when the temperature measurement is complete.

5. Withdraw the probe. Firmly press the ejection button on the top of the probe to eject the probe cover. Replace the probe into the probe well.

In Predictive mode, the monitor automatically enters Monitor mode in the following cases:

- Accurate temperature is not reached.
- Neither measurement is taken nor is the probe replaced in the probe well in 60 seconds after the probe is withdrawn from the well.

The temperature type automatically changes to Predictive mode when the probe returns to the probe well.

NOTE

- **In Predictive mode, place the temperature probe at the measurement site as soon as probe warmup is complete; otherwise, an inaccurate temperature reading may result.**
 - **In Predictive mode, if the probe temperature is high due to the environmental temperature or other causes, cool the probe and then measure the patient's temperature.**
 - **The temperature reading displays continuously until the probe is again removed from the probe well.**
-

10.2.3 Taking a Temperature in Monitor Mode

To measure a temperature in the Monitor mode,

1. Make sure that the probe is placed in the probe well.
2. Make sure that the temperature measurement type and site settings are correct.
3. Remove the probe from the probe well and insert it into a cover in the probe cover pack. Press the probe handle down firmly until the cover engages with the probe.
4. Place the probe at the measurement site and then the monitor measures the site temperature. Refer to Step 4 in **10.2.2 Taking a Temperature in Predictive Mode** for how to place a probe.
5. Withdraw the probe. Firmly press the ejection button on the top of the probe to eject the probe cover. Replace the probe into the probe well.

NOTE

- **In Monitor mode, record the measured value prior to taking the probe away from the measurement site. The monitor will automatically stop measuring temperature after 10 minutes from the start of the measurement.**
-

10.3 Disinfecting Temperature Probe

The recommended disinfectants include: ethanol 70%, isopropanol 70%, glutaraldehyde-type 2% liquid disinfectants

To disinfect the temperature probe:

1. Disconnect the temperature probe from Temp connector.
2. Disinfect the probe with a soft cloth dampened with the recommended disinfectant.
3. Wipe off all the remaining disinfectants from the probe with a soft cloth dampened with water.
4. Dry the probe in a cool place.

WARNING

- **Properly dispose of the used soft cloth.**
-

11 Clinical Scoring

11.1 Overview

The Clinical Scoring function helps a clinician quickly determine the severity of illness of a patient based on a calculated score, so that the clinician can take necessary measures according to the indication provided by the Clinical Scoring function.

The monitor supports the following scorings:

- MEWS (Modified Early Warning Score)
- NEWS (National Early Warning Score)
- Customizable Score

WARNING

- **The Clinical Score is intended to be used only by healthcare professionals and to be serviced by trained personnel.**
 - **The scores and clinical responses in the clinical scores are for reference and cannot be alone used for diagnostic interpretation.**
 - **Both MEWS and NEWS are not applicable to pregnant woman, COPD (Chronic Obstructive Pulmonary Disease) patients and those under 16 years old.**
-

11.1.1 MEWS (Modified Early Warning Score)

The MEWS calculates a total score and provides a clinical response based on the following five parameters:

- ◆ Pulse Rate
- ◆ Systolic NIBP
- ◆ Respiration Rate
- ◆ Temperature
- ◆ AVPU (Alert, Reacting to Voice, Reacting to Pain, and Unresponsive)

This scoring is only applicable to adult.

11.1.2 NEWS (National Early Warning Score)

The NEWS calculates a total score and provides a clinical response based on the following seven parameters:

- ◆ Respiration Rate
- ◆ SpO₂
- ◆ Supplemental Oxygen
- ◆ Temperature
- ◆ Systolic NIBP
- ◆ Pulse Rate

- ◆ AVPU

This scoring is only applicable to adult.

11.1.3 Customizable Scoring

The customizable scoring can provide a clinical response based on the selected multiple parameters or single parameter.

- ◆ Multiple parameter scoring: calculate a total score and provide a clinical response based on the multiple parameters which are defined.
- ◆ Individual parameter scoring (IPS): provide a clinical response whenever any individual parameter value is out of range.

The available parameters in customizable scoring include:

- ◆ Respiration Rate
- ◆ SpO₂
- ◆ Supplemental Oxygen
- ◆ Temperature
- ◆ Systolic NIBP
- ◆ Pulse Rate
- ◆ Level of Consciousness (either AVPU or GCS)
- ◆ Blood Sugar
- ◆ Urine Output
- ◆ Catheter
- ◆ Pain Score
- ◆ Pain
- ◆ Inspired O₂%
- ◆ Airway
- ◆ Three customizable parameters

The applicable patient category can be defined with the Mindray Clinical Scoring Config Tool. Refer to **Clinical Scoring Config Instruction for Use** (P/N: 046-007126-00) for customizable scorings.

11.2 Entering the Calculation Screen

You can calculate a score in the scoring screen or in the score tile.

11.2.1 Scoring Screen

Select [**Scoring**] QuickKey to access the Scoring screen.

11.2.2 Score Tile

The score tile is located in the main screen. By default, the scoring tile is not displayed. The scoring tile will activate when you select a default scoring or load a scoring.

11.3 Calculating a Score

To calculate a score, follow this procedure:

1. Select the default scoring or load a scoring for the applicable patient category. Refer to **11.6.2 Selecting Default Scoring** or **11.6.4 Loading a Scoring**.
2. Obtain the value of all parameters, and then total score will be automatically calculated. Refer to **11.5 Obtaining the Total Score**.
3. If necessary, record the scoring data. Refer to **11.4 Clinical Scoring Screen**.

11.4 Clinical Scoring Screen

11.4.1 Score Tile in the Main Screen

The MEWS, NEWS and multi-parameter score tile display as following:

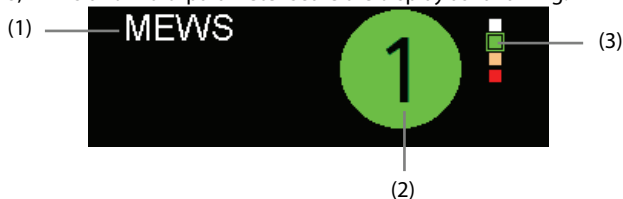

- (1) Name for clinical score
- (2) Total score: the background color indicates the current score level.
- (3) Score level indicator

It indicates that the warning level increases from top to bottom. The current level is enclosed in the square frame.

The IPS score tile displays as following:

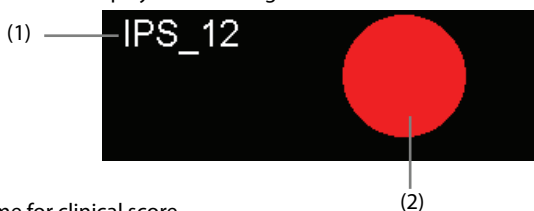

- (1) Name for clinical score
- (2) Score Status
 - ◆ Red : indicates that at least one parameter is out of the defined range.
 - ◆ White : indicates that all the parameters are within the normal range.

11.4.2 Scoring Screen

The MEWS, NEWS or multi-parameter score screen display as following:

(3)

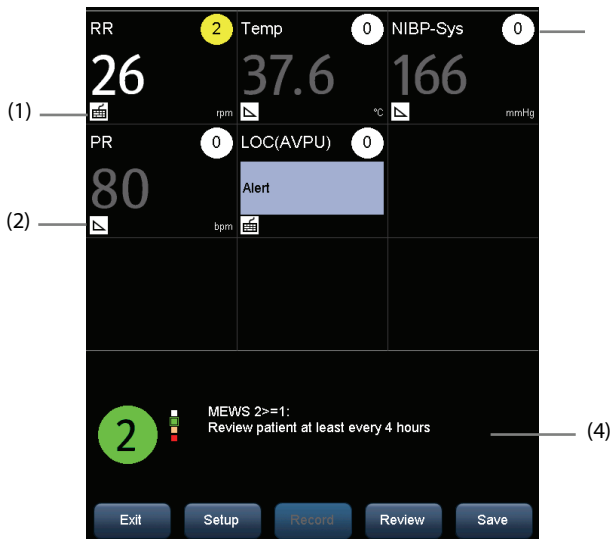

- (1) Icon for manual input
You need to manually input the parameter.
- (2) Icon for real-time monitoring
The parameter value is from the monitor
- (3) Score for single parameter
- (4) Recommended clinical response

The IPS score screen displays as following:



- (1) Icon for manual input
You need to manually input the parameter.
- (2) Icon for real-time monitoring
The parameter value is from the monitor
- (3) Score status for single parameter
 - ◆ Red : indicates that the parameter is out of the defined range.
 - ◆ White : indicates that the parameter is within the normal range.
- (4) Recommended clinical response

In the above screens, you can:

- Select **[Review]** to open the patient review screen. Refer to **4.4 Reviewing Patient Data** for details.
- Select **[Record]** to print the current patient scoring data with a recorder.
- Select **[Save]** to save the scoring data in the **[Results]** screen. Refer to **4.3 Manually Save Patient Data**.
- Select **[Exit]** to go to the main screen.

11.5 Obtaining the Total Score

The IPS only calculates the parameter status. The IPS does not have total score.

For other scorings, the total score will automatically be calculated when each required parameter tile has a value. To calculate a score, follow this procedure:

1. Start monitoring parameters. Their values are automatically obtained.
2. Manually input the values for the parameters that are not monitored.

NOTE

- **If the value is measured by the monitor, the value displays in grey. You cannot manually input the value.**
- **When you are in the scoring screen, if an alarm for the monitoring parameter occurs, the alarm indicators still can be seen in the monitor display.**

The parameter input range is as follows:

Parameter	Range
Pulse Rate	20 bpm -300 bpm
Systolic NIBP	40 mmHg -270 mmHg (Adult) 40 mmHg -200 mmHg (Pediatric) 40 mmHg -135 mmHg (Neonate)
Respiration Rate	0-150 rpm
Temperature	0.1°C – 50.0°C (32.1°F – 122.0°F)
Level of Consciousness	AVPU: Alert, Reacting to Voice, Reacting to Pain, Unresponsive GCS: 1-15
Supplemental Oxygen	Yes, No
SpO ₂	0% – 100%
Urine Output	0 -300 ml/h (0 – 10 ml/h/kg)
Catheter	Yes, No
Blood Sugar	1.0 mg/dl -720.0 mg/dl (0.06 mmol/L -40.00 mmol/L)
Pain Score	0-10
Pain	None, Mild, Moderate, Severe
Inspired O ₂ %	21% -100%
Airway	Clear, Obstruction
Customizable parameter	The input range depends on the decimal point. The decimal point is customizable in Mindray Clinical Scoring Config Tool. 0 – 9999 (decimal point as 1) 0.0 – 999.9 (decimal point as 0.1) 0.00 – 99.99 (decimal point as 0.01)

11.6 Managing Scorings

11.6.1 Importing the Scoring

You can import MEWS, NEWS and customized scorings into the monitor. Up to five scoring protocols can be imported into the monitor.

1. Connect the USB drive to the USB connector on the monitor.
2. Select **[Main]** → **[Maintenance>>]** → **[User Settings>>]** → Enter the required password → **[Manage Scoring>>]** → **[Import Scoring>>]**.
3. In the **[Import Scoring]** menu, select the scorings to be imported. Then select **[Import]**. A status message will report completion of the import.

NOTE

-
- **To load the customized scoring protocols to the USB drive, refer to *Clinical Scoring Config Instruction for Use (P/N: 046-007126-00)*.**
-

11.6.2 Selecting Default Scoring

The monitor does not provide default scoring. To select a default scoring:

1. Select **[Main]** → **[Maintenance>>]** → **[User Settings>>]** → Enter the required password → **[Manage Scoring>>]** → **[Select Default Scoring>>]**.
2. Set the default scoring for the applicable patient category.

After the default scoring is set, when a patient category is changed, the monitor will automatically use the default scoring.

11.6.3 Deleting the Scoring

To delete the scoring:

1. Select **[Main]** → **[Maintenance>>]** → **[User Settings>>]** → Enter the required password → **[Manage Scoring>>]** → **[Delete Scoring>>]**.
2. In the **[Delete Scoring]** menu, select the scoring to be deleted.
3. Select **[Delete]**.

11.6.4 Loading a Scoring

The default scoring may not be appropriately for the new patient. You can load a scoring so as that the scoring is appropriate for your patient.

To load a scoring:

1. Select **[Scoring]** → **[Setup]** → **[Load Scoring>>]**.
2. Select the desired scoring to be loaded.
3. Select **[Load Scoring]**.

FOR YOUR NOTES

12 Recording

12.1 Using a Recorder

The thermal recorder records patient information, parameters numerics (measured value and manual input value), SpO₂ waveforms (if configured), and so on.

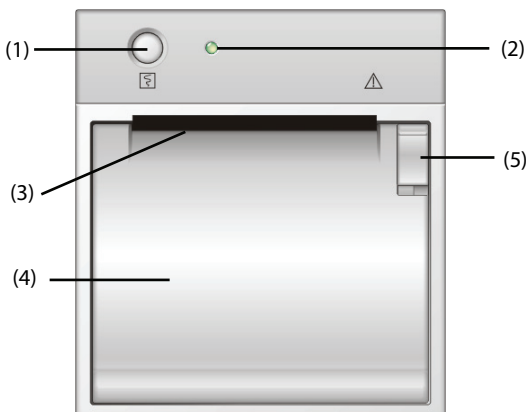

- (1) Start/Stop key: press to start a recording or stop the current recording.
- (2) Indicator
 - ◆ On: when the recorder is working properly.
 - ◆ Off: when the monitor is switched off.
 - ◆ Flash: when a recorder error has occurred, e.g., the recorder runs out of paper.
- (3) Paper outlet
- (4) Recorder door
- (5) Latch

12.2 Loading Paper

1. Press the latch in the upper right corner of the recorder door to open the door.
2. Insert a new roll into the compartment as shown below.
3. Close the recorder door.
4. Check if paper is loaded correctly and the paper end is feeding from the top.

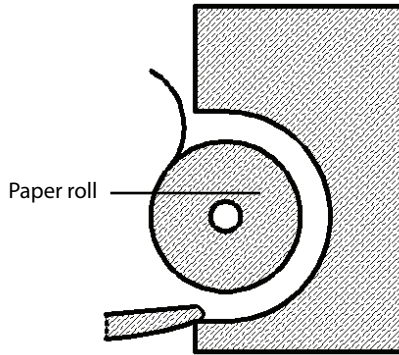

CAUTION

- **Use only specified thermal paper. Otherwise, it may cause damage to the recorder's printhead, the recorder may be unable to print, or poor print quality may result.**
 - **Never pull the recorder paper with force when a recording is in process. Otherwise, it may cause damage to the recorder.**
 - **Do not leave the recorder door open unless you are replacing the recorder paper or correcting an error.**
-

12.3 Setting the Recorder

Select **[Main]**→**[General Setup >>]**→**[Print Setup >>]** to access the **[Print Setup]** menu and select the items as you want.

12.4 Starting and Stopping Recordings

To manually start a recording, you can either:

- Press **[F5]** hardkey on the recorder.
- Select **[Record]** key in graphic or tabular trend.

The monitor will automatically start recording when the **[Save]** QuickKey is selected to save the manual input patient data if **[Automatically Record on Manual Save]** is enabled from the **[User Settings>>]** menu.

- To manually stop the current recording, you select **[F5]** hardkey.

Recordings stop automatically when:

- A recording is completed.
- The recorder runs out of paper.
- When the recorder has an alarm condition.

When a recording is stopped, the following markers will be added:

- Automatically stopped recording: print two columns of '*' at the end of the printout.
- Manually or abnormally stopped recording: print one column of '*' at the end of the printout.

12.5 Reports

12.5.1 Real-time Recording

Real-time recording strip includes recording time, parameter values displayed on the screen, as well as SpO₂ waveform, patient information and manual inputs as configured in the [Print Setup] menu.

12.5.2 Graphic Trend Recording

Graphic trend strip includes patient information, recording time, and graphic trends of all the parameters on the screen.

In graphic trends strip:

- The mark "A" is shown on the event time.
- NIBP measurement taken in Spot Check mode shows as "X".
- The predictive temperature and PR (from NIBP) measurement show as "■".



12.5.3 Continuous Trends Recording

The continuous trends strip includes patient information, recording time, measured value, the saving time for each measurement, and NIBP and Temp complete time.

To print the continuous trends,

1. Choose one patient, and then select [Record] in the [Continuous Trends] screen.
2. Set the start and end time for the recording.
3. Select [Record] to start recording.

In the continuous trends strip:

- The mark '?' before the time indicates that system time is changed.
- The mark '*' before the parameter value indicates that an alarm is triggered.

12.5.4 Spot Check Trends Recording

The spot check trends strip includes patient information, recording time, measured value and measurement complete time. When **[Filter]** is set to **[Manually Saved]** or **[All]**, the manual input data can be recorded.

To print the spot check trends,

1. Select the patient and filter.
2. Select **[Print]**.

If several patients are selected, the recorder will print the data in sequence. Data from different patients are separated by " | ".

12.6 Removing a Paper Jam

If the recorder works incorrectly or produces unusual sound, check if there is a paper jam. If a paper jam is detected, follow this procedure to remove it:

1. Open the recorder door.
2. Take out the paper and tear off the wrinkled or torn part.
3. Reload the paper and close the recorder door.

Refer to section **12.2 Loading Paper** for additional information.

12.7 Cleaning the Recorder Printhead

If the recorder has been used for a long time, deposits of paper debris may collect on the printhead compromising the print quality and shortening the lifetime of the roller. Follow this procedure to clean the printhead:

1. Take measures against the static electricity such as Disposable Wrist Strap for the work.
2. Open the recorder door and take out the paper.
3. Gently wipe around the printhead using cotton swabs dampened with alcohol.
4. After the alcohol has completely been dried, reload the paper and close the recorder door.

Refer to section **12.2 Loading Paper** for additional information.

CAUTION

- **Do not use anything that may destroy the thermal element.**
 - **Do not add unnecessary force to the thermal head.**
-

13 Network

13.1 Network Connection

The monitor can be connected to the central station through the network.

- The Accutorr 7 transmits waveforms and numerics of parameters (Temp, SpO₂, NIBP), related alarms and alarm settings, patient information, and operating mode to the central station. The waveforms, numerics, alarms, alarm settings, patient information, and operating mode displayed on central station are consistent with Accutorr 7.
- The central station transmits alarm settings, parameter settings, patient information and operating mode settings (enter or exit the Standby mode) to the Accutorr 7. The alarm settings, parameter settings, patients' information and operating mode settings of the Accutorr 7 are consistent with central station.

The monitor can be connected to the ADT system and the EMR system through the eGateway.

- The Accutorr 7 transmits the query command message to the ADT system. When the ADT system receives the query command message, the ADT system will transmit the patients' information to the Accutorr 7.
- The Accutorr 7 transmits numerics of Temp, SpO₂, NIBP, related alarms and alarm settings, patient information, operating mode, and historical data, including trends and events, to the EMR. When the EMR receives the data, the EMR will send a success message to the Accutorr 7.

CAUTION

- **Disconnecting from the network may result in data loss, including parameter waveforms and measurements, alarm events, trends and patient data, or cause functional failure. In the case of network disconnection, check the patient and solve the network problem as soon as possible.**
-

13.1.1 Selecting a Network Type

The equipment supports both wired and wireless (optional) networking. To set the network type,

1. Select **[Main]**→**[Maintenance >>]**→**[User Settings >>]**→Enter the required password→Select **[Ok]** to access the **[User Settings]** menu.
2. Select **[Network>>]**→**[Monitor Network Setup >>]** to access the **[Monitor Network Setup]** menu.
3. Set **[Network Type]** to **[LAN]** or **[WLAN]**.

13.1.2 Setting the Wired Network

To set the wired network, follow this procedure:

1. Select **[Main]**→**[Maintenance>>]**→**[User Settings >>]**→enter the required password→Select **[Ok]** to access the **[User Settings]** menu.
2. Select **[Network >>]**→**[Monitor Network Setup >>]** to access the Monitor Network Setup menu.
3. Set the **[Network Type]** to **[LAN]**.
4. Set the **[Address Type]** to **[DHCP]** or **[Manual]**.
 - ◆ If **[Address Type]** is set to **[DHCP]**, the monitor can automatically acquire network parameters.
 - ◆ If **[Address Type]** is set to **[Manual]**, you need to manually input the monitor IP address, subnet mask and gateway address.
5. Click **[Ok]** to confirm the setting.

13.1.3 Setting the Wireless Network (Optional)

The monitor can be connected to a wireless network via a built-in Wi-Fi module. To set the wireless network:

1. Select **[Main]**→**[Maintenance>>]**→**[User Settings >>]**→enter the required password→Select **[Ok]** to access the **[User Settings]** menu.
2. Select **[Network >>]**→**[Monitor Network Setup >>]** to access the Monitor Network Setup menu.
3. Set the **[Network Type]** to **[WLAN]**.
4. Set the **[Address Type]** to **[DHCP]** or **[Manual]**.
 - ◆ If **[Address Type]** is set to **[DHCP]**, the monitor can automatically acquire network parameters.
 - ◆ If **[Address Type]** is set to **[Manual]**, you need to manually input the monitor IP address, subnet mask and gateway address.
5. Select **[WLAN Setup >>]** to access the WLAN setup menu.
6. Select **[Network Name (SSID)]** and enter the network name, ,

7. Select a security mode from the the **[Security]** drop-down list and configure the items.
 - ◆ **[WEP OFF]**, **[WPA PSK]**, **[WPA2 PSK]**: When you select one of these security modes, you need to enter a password for the wireless network.
 - ◆ **[WEP ON]** : When you select this security mode, you need to configure **[Password]**, **[Key Index]**, and **[AUT. Type]**.
 - ◆ **[WPA TKIP]**, **[WPA2 AES]**, **[CCKM TKIP]**, **[CCKM AES]**, **[WPA PSK AES]**, **[WPA_AES]**: These security modes are Wi-Fi Protected Access (WPA/WPA2) enterprise encryption modes. When you select one of these security modes, you need to configure additional items such as **[EAP Method]**, **[AUT. Protocol]**, **[Identity]**, **[Anonymity]**, and **[CA Certificate]**. You need to import the desired certificate to the monitor before you can select a certificate. For how to manage certificates, see **13.4 Managing Certificates**.
7. Click **[Ok]** to confirm the setting.

13.1.4 WLAN Test

To test the availability of the wireless network, follow this procedure:

1. Select **[Main]**→**[Maintenance>>]**→**[User Settings >>]**→enter the required password→Select **[Ok]** to access the **[User Settings]** menu.
2. Select **[Network >>]**→**[Monitor Network Setup >>]** to access the Monitor Network Setup menu.
3. Set the **[Network Type]** to **[WLAN]**.
4. Select **[Ok]**.
5. Select **[WLAN Test >>]** in the **[Network Setup]** menu.
6. Enter the **[IP Address]** of wireless AP in the **[WLAN Test >>]** menu.
7. Click **[Connection Test]**.

You should not change the monitor's IP address randomly. If you want to know details about IP address setup, contact the technical personnel in charge of the CMS.

NOTE

- **When the network type is set to LAN, the monitor uses the wired network to obtain data, and the screen displays the icon of a wired network.**
 - **When the network type is set to WLAN, the monitor uses the optional wireless network to obtain data, and the screen displays the icon of a wireless network.**
 - **The design, installation and maintenance of the wireless network's distribution should be performed by authorized personnel.**
 - **In a wireless (optional) network, the existence of obstacles (such as walls) will affect data transmission or even cause wireless network interruption.**
 - **An access point (AP) supports a maximum of 16 monitors through the wireless network.**
-

13.1.5 Selecting WLAN Band and Channels

The monitor supports 2.4GHz and 5GHz WLAN. To select WLAN band rate and channels, follow this procedure:

1. Select **[Main]**→**[Maintenance>>]**→**[User Settings >>]**→enter the required password→Select **[Ok]** to access the **[User Settings]** menu.
2. Select **[Network >>]**→**[WLAN Setup]**.
3. Set **[WLAN Band]** to **[Auto]**, **[5G]**, or **[2.4G]** according to the band you are using. The default is **[Auto]**, which means the monitor can automatically identify the WLAN band.
5. Select **[Aut. Server Type]** to set the type of authentication server.
6. Select **[BG Channel]** to set the type of B and G channels.
7. Select **[A Channel]** to set the type of A channel.

13.1.6 Setting up the Wireless Network (Optional)

The network will have the following capabilities:

- Support the 802.11a/b/g/n wireless protocol
- Have a channel bandwidth of 20 MHz
- Support WPA2-PSK, WPA2-PSK, WPA-Enterprise, or WPA2-Enterprise
- Provide a signal strength at the monitor of no less than -65 dBm

NOTE

- **Keep network authentication information (e.g, password) safe to protect the network from being accessed by unauthorized users.**
 - **The total throughput of all the wireless devices connected to the wireless network should be less than the effective transmitting capability of the wireless network. The throughput capacity of a single Accutorr 7 is 700 kbps.**
 - **Do not connect non-approved devices to the wireless network.**
 - **To avoid co-channel interference, where the monitor is located, the signal strength of other Wi-Fi access points (AP) on the same channel should be no greater than -85 dBm.**
 - **To avoid signal blocking, where the monitor is located, the signal strength of other Wi-Fi access points (AP) on adjacent channels should be no greater than -50 dBm.**
 - **The recommended distance between the patient monitor and other non-Wi-Fi wireless devices, including wireless devices at the frequency of 2.4GHz (e.g. cellular mobile communication networks, microwave ovens, interphones, cordless phones and electro-surgical units) is no less than 20 cm.**
-

13.2 Setting Data Send Method

You can choose to send the monitor data to hospital system through eGateway or HL7 protocol.

1. Select **[Main]**→**[Maintenance >>]**→**[User Settings >>]**→Enter the required password→Select **[Ok]**→**[Network>>]**.
2. Set **[Data Send Method]** to **[eGateway]** or **[HL7]**.

13.2.1 ADT Communication Setup

1. Select **[Main]**→**[Maintenance >>]**→**[User Settings >>]**→Enter the required password→Select **[Ok]** to access **[User Settings]** menu.
2. Select **[Network>>]**→ **[ADT Communication>>]** to access **[ADT Communication Setup]** menu.
3. Set IP address and port, and switch on/off ADT query.
4. Select **[Ok]** to exit the menu.

13.2.2 EMR Communication Setup

1. Select **[Main]**→**[Maintenance >>]**→**[User Settings >>]**→Enter the required password→Select **[Ok]** to access User Settings menu.
2. Select **[Network>>]**→**[EMR Communication>>]** to access **[EMR Communication Setup]** menu.
3. Set the IP address and port.
4. Select **[Ok]** to exit the menu.

13.2.3 NTP Server Setup

1. Select **[Main]**→**[Maintenance >>]**→**[User Settings >>]**→Enter the required password→Select **[Ok]** to access User Settings menu.
2. Select **[Network>>]**→**[NTP Setup>>]**.
3. Select **[NTP Setup>>]** to enter the NTP Setup menu. Set the following properties:
 - ◆ Set IP address and port.
 - ◆ Set the interval.
 - ◆ Set the time zone.
 - ◆ Switch on/off the daylight saving time.
4. Select **[Ok]** to exit the menu.

To manually start one time synchronization with the NTP server, follow this procedure:

1. Select **[Main]**→**[Maintenance >>]**→**[User Settings >>]**→Enter the required password→Select **[Ok]** to access User Settings menu.
2. Select **[Network>>]**→**[NTP Setup>>]**→**[Manual]**.

13.2.4 Realtime Data Send Interval (for HL7 only)

The monitor will send out the monitored parameter data at the set intervals.

1. Select [Main]→[Maintenance >>]→[User Settings >>]→Enter the required password→Select [Ok] to access User Settings Menu.
2. Select [Network>>]→[EMR Communication>>].
3. Set [Real Data Send] to an appropriate setting.

13.2.5 Alarm Server Settings (for HL7 only)

1. Select [Main]→[Maintenance >>]→[User Settings >>]→Enter the required password→Select [Ok] to access User Settings menu.
2. Select [Network>>]→[Alarm Server Setup].
3. Set the IP address and port.
4. Select [Ok] to exit the menu.

13.3 Connecting the monitor to the CMS

To connect the monitor to the CMS, proceed as follows:

1. Select [Main]→[Maintenance >>]→[User Settings >>]→enter the required password→Select [Ok]→[Network >>]→[Monitor Network Setup >>].
2. Set [Network Type] and [Address Type].
3. Input the monitor IP address, subnet mask and gateway address if the [Address Type] is set to [Manual].
4. Connect the monitor to the CMS through either of the following methods:
 - ◆ Admit the monitor on the CMS. Refer to the *Hypervisor VI Operator's Manual (PN: 300B-20-47610)* for details of admitting a monitor.
 - ◆ Setting the CMS (refer to section **13.3.1 Setting the CMS** for details), and then selecting a CMS (refer to section **13.3.2 Selecting a CMS** for details).

13.3.1 Setting the CMS

You can configure up to 30 central stations (CMS) for your monitor. To set the CMSs,

1. Select [Main]→[Maintenance>>]→[User Settings >>]→enter the required password→Select [Ok]→[Network >>].
2. Set [Select CMS] to [On].
3. Select [Central Station Setup >>].
4. Set CMS names and corresponding IP addresses.

13.3.2 Selecting a CMS

If [Select CMS] is enabled, you can select the CMS for the current monitoring.

To select the CMS, select the prompt message area at the bottom of the screen. Then the selected CMS name will display.

If the CMS you select does not have a name, this area displays "???"

13.3.3 Clearing the Selected CMS at Startup

You can clear the selected CMS each time the monitor restarts after being powered off for more than 2 minutes.

To clear the selected CMS,

1. Select **[Main]**→**[Maintenance>>]**→**[User Settings >>]**→enter the required password→Select **[Ok]**→**[Network >>]**.
2. Set **[Clear CMS IP at startup]** to **[On]**.

The selected CMS will not be cleared when only one CMS is configured, or the monitor is restarted within 2 minutes.

This function is switched off by default.

13.4 Managing Certificates

You can import or delete the monitor's certificates.

1. Select **[Main]**→**[Maintenance>>]**→**[User Settings>>]**→enter the required password→**[Network >>]**→**[Certificates Maintenance >>]**.
2. Select **[Import certificates >>]** or **[Delete certificates >>]**.

13.5 Setting the Multicast Parameters

To set the Multicast parameters:

1. Select **[Main]**→**[Maintenance >>]**→**[User Settings >>]**→Enter the required password→Select **[Ok]** to access **[User Settings]** menu.
2. Select **[Network >>]**→**[Multicast Setup >>]**.
3. Set **[Multicast Addr]** and **[TTL]**.

13.5.1 DIAP Communication Setup

1. Select **[Main]**→**[Maintenance >>]**→**[User Settings >>]**→Enter the required password→Select **[Ok]** to access User Settings menu.
2. Select **[DIAP Communication>>]** to access **[DIAP Communication Setup]** menu.
3. Set the baud rate.
4. Select **[Ok]** to exit the menu.

FOR YOUR NOTES

14 Battery

14.1 Overview





The monitor is designed to operate from battery power when AC power is interrupted. The battery is charged whenever the monitor is connected to an AC power source regardless of whether or not the monitor is turned on. Since no external battery charger is supplied, the battery can only be charged inside the monitor. In case of power failure, the equipment automatically runs from the battery.

The battery is to be used if the integrity of the protective earth conductor or the protective earthing system in the installation is in doubt.

NOTE

- **It is recommended to always install a fully charged battery in the monitor to ensure normal monitoring in case of accidental power failure.**
-

The on-screen battery symbol indicates the battery status as follows:

-  Indicates that the battery is fully charged. The solid portion represents the current charge level of the battery in proportion to its maximum charge level.
-  Indicates that the battery has a low charge level and needs to be charged.
-  Indicates that the battery is almost depleted and needs to be charged immediately. Otherwise, the monitor automatically shuts down.
-  Indicates that no battery is installed.

The capacity of the battery is limited. When the battery is low, the technical alarm area displays **[Low Battery]**, the alarm light flashes, and the monitor produces an alarm sound.

If the battery is depleted, the battery symbol on the screen flashes, the technical alarm area displays **[Battery Depleted]**, the alarm light flashes, and the monitor produces alarm sound. Connect the equipment to AC mains to run the equipment and charge the battery. Otherwise the monitor will shut down.

14.2 Charging a Battery

The battery is charged whenever the monitor is connected to an AC power source regardless of whether or not the monitor is turned on. When the battery is charging, the AC power indicator and battery indicator are both On. If the monitor is powered on, the battery status symbol on the monitor screen displays  when the charging is complete.

14.3 Replacing a Battery

1. Power off the monitor.

2. Open the battery compartment door.
3. Push aside the battery latch and remove the battery.
4. Place a new battery into the slot with its contact point inward.
5. Close the battery compartment door.

14.4 Battery Guidelines

Life expectancy of a battery depends on how frequently and how long it is used. For a properly maintained and stored lithium ion battery, its life expectancy is about 3 years. For more aggressive use models, life expectancy can be less. We recommend replacing lithium-ion batteries after 500 full charge/discharge cycles or every 3 years from first use, whichever occurs first.

To get the most out of the battery, observe the following guidelines:

- The battery performance test must be performed once a year, before monitor repairs, or whenever battery performance is suspect.
- Condition the batteries every three months, or when their run time becomes noticeably shorter.
- Remove the battery before shipping the monitor or if it will not be used for an extended period of time.
- Remove the battery from the monitor if it is not being used regularly. (Leaving the battery in a monitor that is not in regular use will shorten the battery life).
- When storing batteries, make sure that the battery terminals do not come into contact with metallic objects. If batteries are stored for an extended period of time, they should be placed in a cool place with a partial charge of 40% to 60% capacity. Storing batteries at a high temperature for an extended period of time will significantly shorten the life expectancy of a battery. Do not store the battery at a temperature beyond -20 °C - 60 °C (-4°F - 140°F).

CAUTION

- **Keep the battery out of children's reach.**
 - **Use only specified batteries.**
 - **Keep the batteries in their original package until you are ready to use them.**
 - **Do not expose batteries to liquid.**
 - **High ambient temperature shortens battery run time.**
 - **Extremely high ambient temperature may cause battery overheat protection, and then the monitor will turn off.**
 - **If the battery shows signs of damage or signs of leakage, replace it immediately. Do not use a faulty battery in the monitor.**
 - **Do not crush, drop or puncture the battery. Mechanical abuse can lead to internal damage and internal short circuits. If a battery has been dropped or banged against a hard surface, whether damage is externally visible or not, remove the battery from use and dispose of it properly.**
 - **The Lithium-ion batteries have a service life of 3 years. Please replace your battery when it reaches the end of its service life. Failure to replace the battery may cause serious damage to your device from battery overheating.**
-

NOTE

- **Remove the battery before shipping the monitor or if it will not be used for an extended period of time.**
 - **Charge the battery in this monitor.**
-

14.5 Battery Maintenance

14.5.1 Conditioning a Battery

A battery should be conditioned before it is used for the first time. A battery conditioning cycle is one uninterrupted charge of the battery, followed by an uninterrupted battery discharge and charge. Batteries should be conditioned regularly to maintain their useful life.

To condition a battery:

1. Disconnect the monitor from the patient and stop all monitoring or measuring.
2. Turn off the monitor. Disconnect the monitor from the AC power.
3. Connect the monitor to the AC power. Allow the battery to be charged uninterrupted for 6.5 hours until the battery is full.
4. Remove the AC power and allow the monitor to run from the battery until the battery is completely depleted and the monitor automatically shuts off.
5. Again connect the monitor to the AC power. Fully charge the battery again for use or charge it to 40 – 60% for storage.

NOTE

- **The battery charge level indicator does not indicate the capacity or operating time of the battery. It only indicates the current battery charge level. The actual battery capacity decreases over time with the use of the battery. For an old battery, its capacity and operating time may not fulfill battery specifications even if the battery charge level indicates the battery is in full charge. Please replace the battery if its operating time is significantly lower than the specified time.**
-

14.5.2 Checking a Battery

The performance of a rechargeable battery will deteriorate over time. The battery performance test must be performed once a year, before monitor repairs, or whenever battery performance is suspect.

To check battery performance:

1. Disconnect the monitor from the patient and stop all monitoring or measuring.
2. Turn off the monitor. Disconnect the monitor from the AC power.
3. Install the battery.
4. Connect the monitor to AC power. Allow the battery to be charged uninterrupted for 6.5 hours until the battery is full.

5. Note the time. Remove AC power and allow the monitor to run from the battery until it shuts off. Note the time again. Calculate the run time by subtracting the start time from the end time.

The operating time of a battery directly reflects its performance. If the operating time of a battery is noticeably shorter than that stated in the specifications, contact your Mindray service personnel.

NOTE

- **The battery may be damaged or may have malfunctioned if it only operates for a short time after being fully charged. The operating time depends on the configuration and operation. For example, measuring NIBP more frequently will also shorten the operating time.**
 - **Replace a battery that has visual signs of damage or no longer holds a charge. Remove the old battery from the monitor and recycle it according to local laws.**
-

14.6 Recycling a Battery

Remove the old battery from the monitor and recycle it properly. Follow local laws for proper battery disposal.

WARNING

- **Do not disassemble batteries, dispose of them in fire, or cause them to short circuit. They may ignite, explode, leak or heat up, causing personal injury.**
-

15 Care, Cleaning and Maintenance

The monitor should be maintained and cleaned on a regular basis. This chapter describes the basic cleaning, disinfection and test method.

WARNING

- **Failure of the responsible individual, hospital or institution using this equipment to implement a satisfactory maintenance schedule may cause undue equipment failure and possible health hazards.**
 - **The safety checks or maintenance involving any disassembly of the equipment should be performed by professional servicing personnel. Otherwise, undue equipment failure and possible health hazards could result.**
 - **If you discover a problem with any of the equipment, contact your service personnel or Mindray.**
 - **The responsible hospital or institution shall carry out all cleaning and disinfection procedure specified in this chapter.**
 - **Do not open the equipment housings. All servicing and future upgrades must be carried out by the personnel trained and authorized by Mindray only.**
 - **No modification of this equipment is allowed.**
 - **The service personnel must be properly qualified and thoroughly familiar with the operation of the equipment.**
-

15.1 Cleaning and Disinfection

This section describes cleaning and disinfection procedure for the monitor only. For the cleaning and disinfection of other reusable accessories, refer to instructions for use of corresponding accessories.

Keep the equipment and accessories clean. To avoid damage to the equipment, follow these guidelines:

- Always dilute cleaners and disinfectants according the manufacturer's instructions or use lowest possible concentration.
- Do not immerse any part of the equipment into liquid.
- Do not pour liquid onto the equipment or accessories.
- Do not allow liquid to enter the case.
- Never use abrasive materials, or corrosive cleaners (such as acetone or acetone-based cleaners).

WARNING

- **Be sure to turn off the monitor and disconnect all power cables from the outlets before cleaning the equipment.**
 - **Use only Mindray approved cleaners and disinfectants and methods listed in this chapter to clean or disinfect your equipment. Warranty does not cover damage caused by unapproved substances or methods.**
 - **We make no claims regarding the efficacy of the listed chemicals or methods as a means for controlling infection. For infection control methods, consult your hospital's Infection Control Officer or Epidemiologist.**
-
-

CAUTION

- **If you spill liquid on the equipment or accessories, contact Mindray or your service personnel.**
-

15.1.1 Cleaning

Clean your equipment on a regular basis. Consult your hospital's regulations before cleaning the equipment.

The recommended cleaning agents include:

- Sodium hypochlorite bleach (10%)
- Isopropanol (70%)

To clean your equipment, follow these rules:

1. Shut down the monitor and disconnect it from AC power.
2. Clean the display screen using a soft, clean cloth dampened with a cleaning agent.
3. Clean the exterior surface of the equipment using a soft cloth dampened with a cleaning agent.
4. Wipe off all the cleaning solution with a dry cloth after cleaning if necessary.
5. Dry your equipment in a ventilated, cool place.

15.1.2 Disinfecting

If disinfecting is required because of hospital policy, cleaning the equipment before disinfecting is recommended.

The recommended disinfectants include:

- Sodium hypochlorite bleach (10%)
- Isopropanol (70%)
- Perform® classic concentrate OXY

15.1.3 Sterilization

Sterilization is not recommended for this equipment, related products, accessories, or supplies unless otherwise indicated in the Instructions for Use that accompany the products, accessories or supplies.

15.2 General Inspection

Before first use, follow these guidelines when inspecting the equipment:

- Make sure that the environment and power supply meet the specifications.
- Inspect the equipment and its accessories for mechanical damage.
- Inspect all power cords for damage, and make sure that their insulation is in good condition.
- Make sure that only specified accessories are applied.
- Inspect if the alarm system functions correctly.
- Make sure that the recorder functions correctly and the recorder paper meets the requirements.
- Make sure that the battery meets the performance requirements.
- Make sure that the monitor is in good working condition

In case of any damage or abnormality, do not use the equipment. Contact the hospital's biomedical engineers or your service personnel immediately.

15.3 Maintenance and Testing Schedule

The following maintenance and tests, except for visual inspection, power on test, touchscreen calibration, and battery check, should be carried out by the service personnel only. Ensure the monitor is safety and performance tested by qualified service personnel before initial installation, after repair or upgrade or during regularly scheduled maintenance. Contact your service personnel if any maintenance is required.

Make sure to clean and disinfect (if required) the equipment before any test and maintenance.

CAUTION

- **Care should be taken to change the settings in [User Settings >>] and [Factory Maintenance >>] menus to avoid data loss.**
 - **Service personnel should acquaint themselves with the test tools and make sure that test tools and cables are applicable.**
-

Check/Maintenance Item		Recommended Frequency
Performance Test		
Visual inspection		When first installed or after reinstalled.
NIBP test	Pressure check	1. If the user suspects that the measurement is incorrect. 2. Following any repairs or replacement of the module. 3. Once a year for NIBP tests. 4. Once every two years for SpO ₂ test and Temp test.
	Leakage test	
SpO ₂ test		
Temp test		
Nurse call relay performance test		If user suspects that the nurse call or analog output does not work well.
Electrical safety tests		
Electrical safety tests		Once every two years, or as required.
Other tests		
Power on test		1. When first installed or after reinstalled. 2. Following any maintenance or the replacement of any main unit parts.
Touchscreen calibration		1. When the touchscreen appears abnormal. 2. After the touchscreen is replaced.
Recorder check		Following any repair or replacement of the recorder.
Battery check	Functionality test	1. When first installed. 2. Whenever a battery is replaced.
	Performance test	Once a year or if the battery run time reduced significantly.

15.4 Checking Monitor Information

Select **[Main]**→**[Maintenance >>]**→**[Monitor Information>>]**, you can view

- system software version
- copyright information
- system configuration by selecting **[Monitor Configuration>>]**, or
- status information, such as start time, self-test error, and so on by selecting **[Monitor Log>>]**

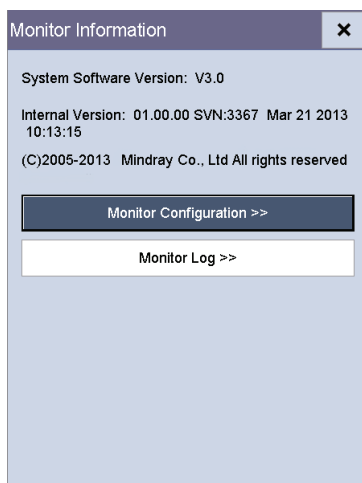

You can print out the log information for the convenience of troubleshooting. Select **[Recorder]** from the **[Monitor Log]** menu to do recording. The information will not be saved after system shutdown.

15.5 Visual Inspection

Perform an overall inspection on the appearance of the equipment. The test is passed if the equipment has no obvious signs of damage. Follow these guidelines when inspecting the equipment:

1. Carefully inspect the case, display screen, buttons, and knob for obvious signs of damage.
2. Inspect all external connections for loose connectors, bent pins or frayed cables.
3. Inspect all connectors on the equipment for loose connectors or bent pins.
4. Make sure that safety labels and data plates on the equipment are clearly legible.

15.6 Power-on Test

This test is to verify that the equipment can power up correctly. This test is passed if the equipment starts up by following this procedure:



1. Insert the battery in the battery compartment, and connect the equipment to the AC mains. The AC mains indicator and battery indicator light up.
2. Press the  button on the front panel to turn on the equipment. The work status indicator lights up inside the Power button.
3. The screen lights up.
4. The main interface is displayed. Now the equipment is correctly started.

15.7 Battery Check

Refer to **14.5.2 Checking a Battery** for battery check instructions.

15.8 Calibrating the Touchscreen

Recalibrate the touchscreen whenever the touch interface becomes difficult to maneuver.

1. Select **[Main]**→**[Maintenance>>]**→**[Touchscreen Calibration]**.The  symbol will appear at different positions of the screen.
2. Select, in turn the central point of the  symbol. After the calibration is completed, the message **[Screen Calibration Completed!]** is displayed.
3. Select **[Ok]** to confirm the completion of the calibration.

15.9 Formatting the Storage Card

The monitor is configured with an SD card for saving data. To format the storage card:

1. Select **[Main]**→**[Maintenance >>]**→**[User Settings >>]**→Enter the required password→Select **[Ok]** to access the **[User Settings]** menu.
2. Select **[Format Storage Card]**, and then select **[Ok]** in the pop-up dialog.

15.10 Modifying Password

1. Select **[Main]**→**[Maintenance >>]**→**[User Settings >>]**→Enter the required password→Select **[Ok]** to access the **[User Settings]** menu.
2. Select **[Modify Password>>]**.
3. Enter new password and then select **[Ok]**.

16 Accessories

The material that patients will come into contact with has passed the bio-compatibility test and is verified to be in compliance with ISO 10993-1.

WARNING

- **Only use accessories specified in this chapter. Using other accessories may cause damage to the equipment or not meet the claimed specifications.**
- **Single-use accessories are not designed to be reused. Reuse may cause a risk of contamination and affect the measurement accuracy.**
- **Check the accessories and their packages for any sign of damage. Do not use them if any damage is detected.**
- **Dispose of accessories according to your hospital regulations.**
- **Use the accessories before the expiration date if their expiration date is indicated.**
- **For more details about the accessories, refer to the instructions for use of corresponding accessories.**

16.1 SpO₂ Accessories

Extension Cable

Module type	Remarks	Part No.
Masimo SpO ₂	8 pins, 2.1 m	115-020768-00
Nellcor SpO ₂	8 pins, 2.5 m	0010-20-42712

SpO₂ Sensors Masimo SpO₂ module

Type	Model	Patient Category	Part No.
Disposable	LNCS Pdtx	Pediatric	0600-00-0122
	LNCS Adtx	Adult	0600-00-0121
	LNCS NeoPt	Neonate (<1 kg)	0600-00-0156
	LNCS Neo	Adult and Pediatric (>40 Kg), neonate(<3 Kg)	0600-00-0157
	LNCS Inf	Pediatric and Neonate (3 to 20 Kg)	0600-00-0158
Reusable	LNCS DCI	Adult (Finger)	0600-00-0126
	LNCS DCIP	Pediatric (Finger)	0600-00-0127

Wavelength emitted by the sensors is between 600 nm and 1000 nm.

The maximum photic output consumption of the sensor is less than 18 mW.

The information about the wavelength range and maximum photic output consumption

can be especially useful to clinicians (for example, when photodynamic therapy is performed).

16.2 NIBP Accessories

Tubing

Type	Patient Category	Part No.
Reusable	Adult, Small Adult, Child	6200-30-09688
	Neonate	6200-30-11560

Reusable Cuff

Patient Category	Measurement Site	Limb Circumference (cm)	Part No.
Child	Arm	10 to 19	0683-15-0001-01
Small Adult		18 to 26	0683-15-0002-01
Adult		24 to 35	0683-15-0003-01
Adult Long		27.5 to 36.5	0683-15-0006-01
Large Adult		33 to 47	0683-15-0004-01
Large Adult Long		35.5 to 46	0683-15-0007-01
Adult	Thigh	44 to 66	0683-15-0005-01
Child	Arm	10 to 19	115-027713-00
Small Adult		18 to 26	115-027714-00
Adult		24 to 35	115-027715-00
Large Adult		33 to 47	115-027716-00
Adult	Thigh	46 to 66	115-027717-00
Adult Long	Arm	24 to 35	115-027718-00
Large Adult		33 to 47	115-027719-00
/	/	Starter kit	115-031807-00

Disposable Cuff

Patient Category	Measurement Site	Limb Circumference (cm)	Part No.
Neonate	Arm	3.1 to 5.7	001B-30-70692
		4.3 to 8.0	001B-30-70693
		5.8 to 10.9	001B-30-70694
		7.1 to 13.1	001B-30-70695
Child		10 to 19	0683-14-0001-01
Small Adult		18 to 26	0683-14-0002-01
Adult		24 to 35	0683-14-0003-01
Adult Long		27.5 to 36.5	0683-14-0006-01
Large Adult		33 to 47	0683-14-0004-01

Patient Category	Measurement Site	Limb Circumference (cm)	Part No.
Large Adult Long		35.5 to 46	0683-14-0007-01
Adult	Thigh	46 to 66	0683-14-0005-01
Child		10 to 19, 10 pcs/box	115-027563-00
Small Adult	Arm	18 to 26, 10 pcs/box	115-027564-00
Adult		24 to 35, 10 pcs/box	115-027565-00
Large Adult		33 to 47, 10 pcs/box	115-027566-00
Adult	Thigh	46 to 66, 5 pcs/box	115-027567-00
Adult Long	Arm	24 to 35, 10 pcs/box	115-027568-00
Large Adult		33 to 47, 10 pcs/box	115-027569-00

16.3 Temp Accessories

Probe Well

Type	Description	Part No.
Reusable	Blue, Oral/Axillary	M09A-20-62062
	Red, Rectal	M09A-20-62062-51

Temp Probes

Type	Patient Category	Measurement Site	Part No.
Reusable	Adult, Pediatric, Neonate	Oral/Axillary	6006-30-39598
	Adult, Pediatric	Rectal	6006-30-39599

Probe Cover

Type	Patient Category	Description	Part No.
Disposable	Adult, Pediatric, Neonate	Cover, 20 pcs/pack	M09A-20-62124
	Adult, Pediatric, Neonate	Cover, 2000 pcs/pack	M09A-30-62128

16.4 Others

Material	Part No.
Welch Allyn SureTemp Plus Probe Covers	0198-00-0044
Welch Allyn SureTemp Plus Thermometer Module	0992-00-0198
Welch Allyn SureTemp Plus Oral Probe	0992-00-0213-02
Quick Release Mounting Bracket for Rolling Stand	045-001054-00
Quick Release Mounting Bracket for Wall Mount	045-001055-00
Rolling Stand with Quick Release Mount	045-001057-00
Bin for Rolling Stand	115-037732-00
Casters for Rolling Stand	0401-00-0055
Wall Mount Bracket	045-001059-00

Material		Part No.
Wall Mount Kit, 6" Arm		115-025386-00
Bedrail Clamp		115-020575-00
Nurse Call Cable		009-003116-00
Serial Port Cable		009-003436-00
Recorder Paper		0683-00-0505-02
U.S. Power Cord		DA8K-10-14452
USB disk		023-000217-00
Accessories Kit	Component	Part No.
Barcode Scanner Kit (115-008393-00)	1D Bar Code Scanners	023-000254-00
	USB Cable of ASYMBOL Scanner	009-001397-00
Accutorr 7 Welch Allyn Temp Support Kit (115-025041-00)	Accutorr 7 Welch Allyn Temp Support Assembly	115-022908-00
	Accutorr 7 Welch Allyn Temp Support Installation Guide	046-006016-00
Li-ion Battery Kit (115-018012-00)	Li-ion Battery, LI23S002A, 11.1V 4500mAh	022-000008-00
2D Barcode Scanner Kit (115-039575-00)	2D Barcode Scanner	023-001286-00
	USB Cable of Scanner	009-001397-00
2D Barcode Scanner (Support RFID) Kit (115-039635-00)	2D Barcode Scanner (Support RFID)	023-001288-00
	USB Cable of Scanner	009-001397-00

A Product Specifications

A.1 Classifications

The equipment is classified, according to IEC60601-1:

Type of protection against electrical shock	CLASS I EQUIPMENT, equipment energized from an external and internal electrical power source.
Degree of protection against electrical shock	DEFIBRILLATION-PROOF TYPE CF APPLIED PART for SpO ₂ , NIBP, and TEMP
Mode of operation	Continuous
Degree of protection against harmful ingress of water	IPX1 (protection against vertically falling water drops)
degree of safety of application in the presence of a FLAMMABLE ANAESTHETIC MIXTURE WITH AIR or WITH OXYGEN OR NITROUS OXIDE	EQUIPMENT not suitable for use in the presence of a FLAMMABLE ANAESTHETIC MIXTURE WITH AIR or WITH OXYGEN OR NITROUS OXIDE
Degree of mobility	Portable

A.2 Environmental Specifications

Main Unit

Item	Operating conditions	Storage conditions
Temperature (°C)	0 to 40 (without Temp module) 5 to 40 (with Temp module)	-20 to 60
Relative humidity (noncondensing)	15% to 95%	10% to 95%
Barometric (kPa)	57.0 to 107.4	16.0 to 107.4

WARNING

- **The equipment may not meet the performance specifications given here if stored or used outside the specified temperature and humidity ranges.**
-
-

NOTE

- **The environmental specifications of parameter modules are the same as those of the main unit.**
-
-

A.3 Power Supply Specifications

AC Power

Line voltage	100 to 240 VAC ~ ($\pm 10\%$)
Current	0.9 to 0.5A
Frequency	50/60 Hz ($\pm 3\text{Hz}$)
Fuse	T2AL-250V

Battery

Battery Type	Rechargeable lithium-ion, LI23S002A
Voltage	11.1 VDC
Capacity	4500 mAh
Run time	At least 8 hours when powered by a new fully-charged battery at $25\text{ }^{\circ}\text{C} \pm 5\text{ }^{\circ}\text{C}$ ($77\text{ }^{\circ}\text{F} \pm 41\text{ }^{\circ}\text{F}$) with SpO ₂ cable connected, and auto NIBP measurements at an interval of 15 minutes.
Charge time	Monitor power off: less than 5.5 hours to 90%; less than 6.5 hours to 100%. Monitor power on: less than 10.5 hours to 90%; less than 11.5 hours to 100%.
Shutdown delay	At least 20 minutes (after a low battery alarm first occurs)

A.4 Physical Specifications

Size	178mm×150mm×260mm (70.08 inch × 59.05 inch × 102.36 inch)
Weight	≤2.5 kg (5.51 lb)(with SpO ₂ module, NIBP module, recorder module and a battery)

A.5 Hardware Specifications

Display

Screen type	Color TFT LCD
Screen Size (diagonal)	8.4"
Resolution	800 × 600 pixels

Recorder

Method	Thermal dot array
Paper speed	25 mm/s
Number of waveform channels	1

A.5.1 LEDs

Alarm lamp	1 (two color coded: yellow and red)
Power on LED	1 (green)
AC power LED	1 (green)
Battery LED	1 (green)

A.5.2 Audio Indicator

Speaker	Give alarm tones (45 to 85 dB), key tones, pulse tone; power-on self check tone, support PITCH TONE and multi-level tone modulation; alarm tones comply with IEC 60601-1-8.
---------	---

A.5.3 Monitor Interface Specifications

Power	1 AC power input connector
Wired network	1 RJ45 connector
USB	2 standard connectors, USB 2.0
Equipotential Grounding Terminal	1
Multi-Functions Connector	1 MINI-D RIBBON connector

A.5.4 Outputs

Nurse Call Signal	
Amplitude	High level: >3V, providing a maximum of 3 mA output current; Low level: <0.5 V, receiving a maximum of 5 mA input current
Rising and falling time	≤ 1 ms
Alarm Output (Network connector)	
Alarm delay time from monitor to remote equipment	The alarm delay time from the monitor to remote equipment is ≤2 seconds, measured at the monitor's signal output connector.

A.5.5 Data Storage

Trends	5000 groups
--------	-------------

A.6 Wireless Network (Optional)

Standards	IEEE 802.11a/b/g/n
Modulation mode	DSSS and OFDM
Operating frequency	For 2.4G frequency bands (FCC): 2.4GHz to 2.483GHz (only use Channels 1 to 11) For 5G frequency bands (FCC): 5.15GHz to 5.35GHz, 5.725GHz to 5.825GHz
Priority	All communication data types shall have the same priority.
Channel spacing	IEEE 802.11a: 20MHz IEEE 802.11b/g: 5MHz IEEE 802.11n at 2.4 GHz: 5MHz IEEE 802.11n at 5 GHz: 20MHz
Wireless baud rate	IEEE 802.11a: 6 to 54 Mbps IEEE 802.11b: 1 to 11 Mbps IEEE 802.11g: 6 to 54 Mbps IEEE 802.11n (at both 2.4GHz and 5GHz): 6.5 to 72.2 Mbps
Data latency	Total delay of data transmission from the monitor to the CMS: $\leq 2s$. Delay of configuration settings transmission from CMS to Accutorr 7: $\leq 2s$
Roaming	Network switchover is automatically executed when the Accutorr 7 moves from the coverage area of AP1 to that of AP2.
System capacity	Number of the Accutorr 7 supported by a single AP is ≤ 16 . Each Accutorr 7 can communicate with the CMS.
Data security	Security standards: WPA-PSK, WPA2-PSK, WPA-Enterprise/WPA2-Enterprise EAP methods: PEAP-MsCHAPv2, PEAP-GTC, PEAP-TLS, EAP-TTLS, EAP-TLS, EAP-FAST, and EAP-LEAP Encryption modes: TKIP and AES
Resistance to wireless interference	The wireless functions of Accutorr 7 are normal when the following conditions exist simultaneously: <ol style="list-style-type: none"> 1. The distance between interfering devices (including wireless devices at the frequency of 2.4GHz such as cellular communication devices, microwave ovens, intercoms, cordless phones and electro-surgical units, excluding Wi-Fi) and the monitor is greater than 20 cm. 2. Co-channel interference (CCI) on the Wi-Fi network should be no greater than -85dBm. 3. Adjacent-channel interference (ACI) on the Wi-Fi network should be no greater than -50dBm.
Dynamic networking stability	The Accutorr 7 meets its functional requirements when it moves at a rate of no more than 3.75 m/s within a 15 m non-blocking linear distance.
Network interruption alarm	When a network interruption occurs, the equipment shows a disconnection icon on the screen and presents the related alarms.

	When the network interruption is resolved, wireless connection recovers automatically.
--	--

A.7 Measurement Specifications

A.7.1 SpO₂

Alarm limit	Range (%)	Step (%)
SpO ₂ High	(low limit + 2) to 100	1
SpO ₂ Low	Masimo: Desat to (high limit – 2) Nellcor: Desat or 20 (whichever is greater) to (high limit – 2)	
Desat	0 to (high limit – 2)	

Masimo SpO₂ Module

Standards	Meet standards of ISO 9919, ISO 80601-2-61
SpO ₂ Measurement range	1 to 100%
PI measurement range	0.02% to 20%
SpO ₂ Resolution	1%
Accuracy ¹	70 to 100%: ±2% (measured without motion in adult/pediatric mode) 70 to 100%: ±3% (measured without motion in neonate mode) 70 to 100%: ±3% (measured with motion) 1% to 69%: Not specified.
Refreshing rate	1 s
Response time	≤ 20 s (PR 75 bpm, average time 8 s, SpO ₂ value rises from 60% to 95%)
SpO ₂ averaging time	2-4 s, 4-6 s, 8 s, 10 s, 12 s, 14 s, 16 s
Low perfusion conditions	Pulse amplitude: >0.02% Light penetration: >5%
Low perfusion SpO ₂ accuracy ²	±2%

¹ The Masimo pulse oximeter with sensors has been validated for no motion accuracy in human blood studies on healthy adult volunteers in induced hypoxia studies in the range of 70% to 100% SpO₂ against a laboratory co-oximeter and ECG monitor. This variation equals plus or minus one standard deviation. Plus or minus one standard deviation encompasses 68% of the population.

The Masimo pulse oximeter with sensors has been validated for motion accuracy in human blood studies on healthy adult volunteers in induced hypoxia studies while performing rubbing and tapping motions at 2 to 4 Hz. At an amplitude of 1 to 2 cm and non-repetitive motion between 1 to 5 Hz. At an amplitude of 2 to 3 cm in induced hypoxia studies in the range of 70% to 100% SpO₂ against a laboratory co-oximeter and ECG monitor. This variation equals plus or minus one standard deviation. Plus or minus one standard deviation encompasses 68% of the population.

² The Masimo pulse oximeter has been validated for low perfusion accuracy in bench top testing against a Biotek Index 2 simulator and Masimo's simulator with signal strengths of

greater than 0.02% and a % transmission of greater than 5% for saturations ranging from 70 to 100%. This variation equals plus or minus one standard deviation. Plus or minus one standard deviation encompasses 68% of the population.

Nellcor SpO₂ Module

Standards	Meet standards of ISO 9919, ISO 80601-2-61
Measurement range	0 to 100%
Resolution	1%
Accuracy	70 to 100%: $\pm 2\%$ (adult/pediatric) 70 to 100%: $\pm 3\%$ (neonate) 0% to 69%: Not specified.
Refreshing rate	1 s
Response time	≤ 30 s (PI > 0.3, no disturbance, SpO ₂ value sudden change within 70% - 100%)
* When the SpO ₂ sensor is applied for neonatal patients as indicated, the specified accuracy range is increased by $\pm 1\%$, to compensate for the theoretical effect on oximeter measurements of fetal hemoglobin in neonatal blood.	

Information of the Test Subjects of the Clinical Study Report

Skin color	Gender	Number	Age (years)	Health
Black	Male	1	28.2 \pm 9.19	Healthy
	Female	1		
Yellow	Male	3		
	Female	9		

A.7.2 PR

Module	PR High Limit	PR Low Limit	Step (bpm)
Masimo SpO ₂ Module	(low limit +2) to 240	25 to (high limit-2)	1
Nellcor SpO ₂ Module	(low limit +2) to 300	20 to (high limit-2)	
NIBP Module	(low limit +2) to 240	40 to (high limit-2)	

PR from Masimo SpO₂ Module

Measurement range	25 to 240 bpm
Resolution	1 bpm
Response time	≤ 20 s (PR value sudden change within 25 – 240 bpm)
Accuracy	± 3 bpm (without motion) ± 5 bpm (with motion)
Refreshing rate	1 s

PR from Nellcor SpO₂ Module

Measurement range	20 to 300 bpm
Resolution	1 bpm
Response time	≤ 30 s (PI > 0.3, no disturbance, PR value sudden change within 25 – 250 bpm)
Accuracy	20 to 250 bpm: ±3 bpm 251 to 300 bpm, not specified
Refreshing rate	1 s

PR from NIBP Module

Measurement range	40 to 240 bpm
Resolution	1 bpm
Accuracy	±3 bpm or ±3%, whichever is greater

A.7.3 NIBP

Standards	Meet standards of IEC80601-2-30, EN1060-1, EN1060-3, EN1060-4 and SP10			
Technique	Oscillometry			
Mode of operation	Manual, Auto, STAT and Program			
Auto mode repetition intervals	1, 2, 2.5, 3, 5, 10, 15, 20, 30, 60, 90 or 120 min			
STAT mode cycle time	5 min			
Max measurement time	Adult, pediatric: 180 s Neonate: 90 s			
Heart rate range	40 to 240 bpm			
Measurement ranges (mmHg)		Adult	Pediatric	Neonate
	Systolic	40 to 270	40 to 200	40 to 135
	Diastolic	10 to 210	10 to 150	10 to 100
	Mean	20 to 230	20 to 165	20 to 110
Accuracy	Max mean error: ±5 mmHg Max standard deviation: 8 mmHg			
Static pressure measurement range	0 mmHg to 300 mmHg			
Static pressure measurement accuracy	±3 mmHg			
Resolution	1 mmHg			
Initial cuff inflation pressure range (mmHg)	Adult:		80 to 280	
	Pediatric:		80 to 210	
	Neonate:		60 to 140	
Default initial cuff inflation pressure (mmHg)	Adult:		160	
	Pediatric:		140	

	Neonate: 90	
Software overpressure protection	Adult: 297±3 mmHg Pediatric: 240±3 mmHg Neonate: 147±3 mmHg	
Hardware overpressure protection	Adult: ≤330 mmHg Pediatric: ≤330 mmHg Neonate: ≤165 mmHg	
Alarm limit	Range (mmHg)	Step (mmHg)
Sys High	Adult: (low limit+5) to 270 Pediatric: (low limit+5) to 200 Neonate: (low limit+5) to 135	5
Sys Low	40 to (high limit-5)	
Mean High	Adult: (low limit+5) to 230 Pediatric: (low limit+5) to 165 Neonate: (low limit+5) to 110	
Mean Low	20 to (high limit-5)	
Dia High	Adult: (low limit+5) to 210 Pediatric: (low limit+5) to 150 Neonate: (low limit+5) to 100	
Dia Low	10 to (high limit-5)	

* Measurement accuracy verification: In adult and pediatric modes, the blood pressure measurements measured with this device are in compliance with the American National Standard for Electronic or Automated Sphygmomanometers (ANSI/AAMI SP10) in terms of mean error and standard deviation by comparing with intra-arterial or auscultatory measurements (depending on the configuration) in a typical patient population. For auscultatory reference, the 5th Korotkoff sound was used to determine the diastolic pressure.

In neonatal mode, the blood pressure measurements measured with this device are in compliance with the American National Standard for Electronic or Automated Sphygmomanometers (ANSI/AAMI SP10) in terms of mean error and standard deviation by comparing with intra-arterial measurements (depending on the configuration) in a typical patient population.

A.7.4 Temp

Standards	Meets standards of ASTM E1112, ASTM E1104, ISO 80601-2-56	
Technique	Thermal resistance (use thermistor to measure temperature)	
Measurement range	Monitor mode: 25 to 44°C (77 to 111.2 °F) Predictive mode: 35 to 43°C (95 to 109.4 °F)	
Accuracy (Monitor mode)	25°C to 32°C (not include 32°C): ± 0.2°C 32°C to 44 °C (include 32°C): ±0.1°C or 77°F to 89.6°F (not include 89.6°F): ± 0.4°F 89.6°F to 111.2°F (include 89.6°F): ± 0.2°F	
Resolution	±0.1°C	
Minimum measurement time for accurate readings	Monitor mode: <60 s Predictive mode: <20 s (typical test: < 12s)	
Alarm limit	Range	Step
Temp High	(low limit +1) °C to 44°C (low limit +1.8) °C to 111.2°F	0.1°C
Temp Low	25°C to (high limit -1) °C 77°F to (high limit -1.8) °F	0.2°F

Statistical Results of Clinical Investigation Data

	Clinical BIAS (Δcb)	Limits of Agreement (LA)	Clinical Repeatability (σ)
Oral	0.02	0.33	0.1
Axilla	0.06	0.38	0.13
Rectum	-0.05	0.48	0.14

FOR YOUR NOTES

B EMC and Radio Regulatory Compliance

B.1 EMC

The device meets the requirements of IEC 60601-1-2. All the accessories listed in Chapter 16 also meet the requirements of IEC 60601-1-2 when in use with this device.

NOTE

- **Using accessories, transducers and cables other than those specified may result in increased electromagnetic emission or decreased electromagnetic immunity of the equipment.**
- **The device or its components should not be used adjacent to or stacked with other equipment. If adjacent or stacked use is necessary, the device or its components should be observed to verify normal operation in the configuration in which it will be used.**
- **The device needs special precautions regarding EMC and needs to be installed and put into service according to the EMC information provided below.**
- **Other devices may interfere with this device even though they meet the requirements of CISPR.**
- **When the input signal is below the minimum amplitude provided in technical specifications, erroneous measurements could result.**
- **Portable and mobile communication equipment may affect the performance of this device.**
- **Other devices that have RF transmitter or source may affect this device (e.g. cell phones, PDAs, and PCs with wireless function).**

Guidance and Declaration – Electromagnetic Emissions		
The device is intended for use in the electromagnetic environment specified below. The customer or the user of the device should assure that it is used in such an environment.		
Emission tests	Compliance	Electromagnetic environment – guidance
Radio frequency (RF) emissions CISPR 11	Group 1	The device uses RF energy only for its internal function. Therefore, its RF emissions are very low and are not likely to cause any interference in nearby electronic equipment.
RF emissions CISPR 11	Class A	The device is suitable for use in all establishments other than domestic and those directly connected to the public low-voltage power supply network that supplies buildings used for domestic purposes
Harmonic emissions IEC61000-3-2	Class A	
Voltage Fluctuations/Flicker Emissions IEC 61000-3-3	Complies	

WARNING

- **This equipment/system is intended for use by healthcare professionals only. This equipment/ system may cause radio interference or may disrupt the operation of nearby equipment. It may be necessary to take mitigation measures, such as re-orienting or relocating the [ME EQUIPMENT or ME SYSTEM] or shielding the location.**

Guidance and Declaration – Electromagnetic Immunity			
The device is intended for use in the electromagnetic environment specified below. The customer or the user of the device should assure that it is used in such an environment.			
Immunity test	IEC60601 test level	Compliance level	Electromagnetic environment – guidance
Electrostatic discharge (ESD) IEC 61000-4-2	±6 kV contact ±8 kV air	±6 kV contact ±8 kV air	Floors should be wood, concrete or ceramic tile. If floors are covered with synthetic material, the relative humidity should be at least 30%.
Electrical fast transient/burst IEC 61000-4-4	±2 kV for power supply lines ±1 kV for input/output lines	±2 kV for power supply lines ±1 kV for input/output lines	Mains power quality should be that of a typical commercial or hospital environment.
Surge IEC 61000-4-5	±1 kV line(s) to line(s) ±2 kV line(s) to earth	±1 kV line(s) to line(s) ±2 kV line(s) to earth	
Voltage dips, short interruptions and voltage variations on power supply input lines IEC 61000-4-11	<5 % UT (>95 % dip in UT) for 0.5 cycle 40 % UT (60 % dip in UT) for 5 cycles 70 % UT (30 % dip in UT) for 25 cycles <5 % UT (>95 % dip in UT) for 5 s	<5 % UT (>95 % dip in UT) for 0.5 cycle 40 % UT (60 % dip in UT) for 5 cycles 70 % UT (30 % dip in UT) for 25 cycles <5 % UT (>95 % dip in UT) for 5 s	Mains power quality should be that of a typical commercial or hospital environment. If the user of our product requires continued operation during power mains interruptions, it is recommended that our product be powered from an uninterruptible power supply or a battery.
Power frequency (50/60 HZ) magnetic field IEC 61000-4-8	3 A/m	3 A/m	Power frequency magnetic fields should be at levels characteristic of a typical location in a typical commercial or hospital environment.
Note: UT is the AC mains voltage prior to application of the test level.			

Guidance and Declaration – Electromagnetic Immunity			
The device is intended for use in the specified electromagnetic environment. The customer or the user of the device should assure that it is used in such an environment as described below.			
Immunity test	IEC60601 test level	Compliance level	Electromagnetic environment – guidance
Conducted RF IEC61000-4-6	3 Vrms 150 kHz to 80 MHz	3Vrms	Portable and mobile RF communications equipment should be used no closer to any part of the system, including cables, than the recommended separation distance calculated from the equation appropriate for the frequency of the transmitter. Recommended separation distances: $d = 1.2\sqrt{P}$
Radiated RF IEC61000-4-3	3V/m 80MHz to 2.5GHz	3V/m	Recommended separation distances: 80 MHz – 800 MHz $d = 1.2\sqrt{P}$ 800MHz-2.5GHz $d = 2.3\sqrt{P}$ Where, P is the maximum output power rating of the transmitter in watts (W) according to the transmitter manufacturer and d is the recommended separation distance in meters (m).b Field strengths from fixed RF transmitters, as determined by an electromagnetic site survey a, should be less than the compliance level in each frequency range b. Interference may occur in the vicinity of equipment marked with the following  symbol:
<p>Note 1: At 80 MHz to 800 MHz, the separation distance for the higher frequency range applies.</p> <p>Note 2: These guidelines may not apply in all situations. Electromagnetic propagation is affected by absorption and reflection from structures, objects and people.</p> <p>Note 3: The device that intentionally receives RF electromagnetic energy at the exclusion band (2395.825MHz-2487.645MHz) is exempt from the essential performance requirements, but remains safe.</p>			
a Field strengths from fixed transmitters, such as base stations for radio (cellular/cordless) telephones and land mobile radios, amateur radio, AM and FM radio broadcast and TV broadcast cannot be predicted theoretically with accuracy. To assess the electromagnetic			

environment due to fixed RF transmitters, an electromagnetic site survey should be considered. If the measured field strength in the location in which the [ME EQUIPMENT or ME SYSTEM] is used exceeds the applicable RF compliance level above, the [ME EQUIPMENT or ME SYSTEM] should be observed to verify normal operation. If abnormal performance is observed, additional measures may be necessary, such as re-orienting or relocating the [ME EQUIPMENT or ME SYSTEM].

b Over the frequency range 150 kHz to 80 MHz, field strengths should be less than 3V/m.

WARNING

- **The device may be configured with a wireless network module to receive wireless signals. Other devices may interfere with this device even though they meet the requirements of CISPR.**

Recommended separation distances between portable and mobile RF communications equipment and the device

The device is intended for use in an electromagnetic environment in which radiated RF disturbances are controlled. The customer or the user of the device can help prevent electromagnetic interference by maintaining a minimum distance between portable and mobile RF communications equipment (transmitters) and the device as recommended below, according to the maximum output power of the communications equipment.

Rated maximum output power of transmitter (W)	Separation distance in meters (m) according to frequency of the transmitter		
	150 kHz – 80 MHz $d = 1.2\sqrt{P}$	80 MHz – 800 MHz $d = 1.2\sqrt{P}$	800 MHz – 2.5 GHz $d = 2.3\sqrt{P}$
0.01	0.12	0.12	0.23
0.1	0.38	0.38	0.73
1	1.20	1.20	2.30
10	3.80	3.80	7.30
100	12.00	12.00	23.00

For transmitters rated at a maximum output power not listed above, the recommended separation distance d in metres (m) can be estimated using the equation applicable to the frequency of the transmitter, where P is the maximum output power rating of the transmitter in watts (W) according to the transmitter manufacturer.

Note 1: At 80 MHz and 800 MHz, the separation distance for the higher frequency range applies.

Note 2: These guidelines may not apply in all situations. Electromagnetic propagation is affected by absorption and reflection from structures, objects and people.

B.2 Radio Regulatory Compliance

RF parameters (For Cyberlink Wireless Module)

Item	IEEE 802.11b	IEEE 802.11g	IEEE 802.11n
Operating Frequency Band (MHz)	2412~2472	2412~2472	2412~2472
Modulation	DSSS and CCK	OFDM	OFDM
Transmitter Output Power (dBm)	<20 (Avg) <30 (Peak)	<20 (Avg) <30 (Peak)	<20 (Avg) <30 (Peak)

RF parameters (For MSD45N Wireless Module)

Item	IEEE 802.11b/g/n	IEEE 802.11a/n
Operating Frequency Band (MHz)	2412~2462	5150~5250 5250~5350 (Slave) 5725~5850
Modulation	802.11b: DSSS (DBPSK/DQPSK/CCK) 802.11g/n: OFDM (BPSK/QPSK/16QAM/64QAM)	OFDM (BPSK/QPSK/16QAM/64QAM)
Transmitter Output Power (dBm)	<20 (Average) <30 (Peak)	<20 (Average) <30 (Peak)

The radio module MSD45N is complied with the essential requirements and other relevant provisions of Directive 1999/5/EC (Radio Equipment and Telecommunications Terminal Equipment Directive).

The device, including the MSD45N wireless module, complies with part 15 of the FCC Rules. Operation is subject to the condition that this device does not cause harmful interference.

The device, when configured with the WM1010BGN wireless module, complies with part 15 of the FCC Rules. Operation is subject to the condition that this device does not cause harmful interference.

Operation of this equipment requires the prior coordination with a frequency coordinator designated by the FCC for the Wireless Medical Telemetry Service.

This Wi-Fi device complies with Canadian ICES-001. Cet appareil ISM est conforme a la norme NMB-001 du Canada.

FCC and Industry Canada Radio Compliance of the device configured with MSD45N wireless module: This device complies with Part 15 of the FCC Rules and RSS-210 of Industry Canada. Operation is subject to the following two conditions: (1) this device may not cause harmful interference, and (2) this device must accept any interference received, including interference that may cause undesired operation. Any changes or modifications to this equipment not expressly approved by Mindray may cause harmful radio frequency interference and void your authority to operate this equipment.

Federal Communications Commission (FCC) Statement

The wireless module has been tested and found to comply with the limits for a class B digital device, pursuant to Part 15 of the FCC rules. These limits are designed to provide reasonable protection against harmful interference in a residential installation. This equipment generates, uses and can radiate radio frequency energy and, if not installed and used in accordance with the instructions, may cause harmful interference to radio communications. However, there is no guarantee that interference will not occur in a particular installation. If this equipment does cause harmful interference to radio or television reception, which can be determined by turning the equipment off and on, the user is encouraged to try to correct the interference by one or more of the following measures:

- Reorient or relocate the receiving antenna.
- Increase the separation between the equipment and receiver.
- Connect the equipment into an outlet on a circuit different from that to which the receiver is connected.
- Consult the dealer or an experienced radio/TV technician for help.

The maximum antenna gain permitted complies with the e.i.r.p. limits as stated in RSS-210.

The maximum antenna gain permitted complies with the e.i.r.p. limits specified for point-to-point operation, as stated in RSS-210.



The radio device used in this product is in compliance with the essential requirements and other relevant provisions of Directive 1999/5/EC (Radio Equipment and Telecommunications Terminal Equipment Directive).

WARNING

- **Keep a distance of at least 20 cm away from the monitor when Wi-Fi function is in use.**
-

C Default Configurations

This chapter lists some of the most important factory default settings in configuration management. You cannot change the factory default configuration itself. However, you can make changes to the settings from the factory default configuration and then save the changed configuration as a user configuration.

C.1 Parameter Configuration

C.1.1 NIBP

Name		Default Config	Saved at Power Failure	Affected by Defaults
Alarm On/Off		On	Yes	Yes
Alarm Priority		Med	Yes	Yes
Interval		Manual	Yes	Yes
Clock		On	Yes	Yes
NIBP End Tone		0	Yes	Yes
Program		Program 1	Yes	Yes
Cuff Press. (mmHg) in VeniPuncture	Adult	80	Yes	Yes
	Pediatric	60		
	Neonate	40		
Initial Pressure	Adult	160	Yes	No
	Pediatric	140		
	Neonate	90		
NIBP-Sys High (mmHg)	Adult	160	Yes	Yes
	Pediatric	120		
	Neonate	90		
NIBP-Sys Low (mmHg)	Adult	90	Yes	Yes
	Pediatric	70		
	Neonate	40		
NIBP-Mean High (mmHg)	Adult	110	Yes	Yes
	Pediatric	90		
	Neonate	70		
NIBP-Mean Low (mmHg)	Adult	60	Yes	Yes
	Pediatric	50		
	Neonate	25		
NIBP-Dia High (mmHg)	Adult	90	Yes	Yes
	Pediatric	70		
	Neonate	60		
NIBP-Dia Low (mmHg)	Adult	50	Yes	Yes
	Pediatric	40		

Name		Default Config	Saved at Power Failure	Affected by Defaults
	Neonate	20		

C.1.2 SpO₂

Name	Default Config	Saved at Power Failure	Affected by Defaults
Alarm On/Off	On	Yes	Yes
Alarm Priority	Med		
SpO ₂ High	Adult/pediatric:100 Neonate: 95		
SpO ₂ Low	90		
Desat Low	80		
Sat-Seconds (Nellcor)	0 s		
NIBP Simultaneous	Off		
Sweep	25 mm/sec		
Beat Volume	2		
SpO ₂ Sensor Off Lev.	Monitor mode: Low Spot Check mode: Off	Yes	No
Sensitivity (Masimo)	Normal		
Averaging (Masimo)	8 s		

C.1.3 PR

Name		Default Config	Saved at Power Failure	Affected by Defaults
Alarm On/Off		On	Yes	Yes
Alarm Priority		Med		
PR High	Adult	120		
	Pediatric	160		
	Neonate	200		
PR Low	Adult	50		
	Pediatric	75		
	Neonate	100		
PR Source		SpO ₂		
Beat Volume		2		

C.1.4 Temp

Name		Default Config	Saved at Power Failure	Affected by Defaults
Alarm On/Off		Off	Yes	Yes
Alarm Priority		Med	Yes	Yes
Temp High		38.0	Yes	Yes
Temp Low		35.0	Yes	Yes
Temp Type		Predictive	No	No
Temp Position	Oral/Axillary probe: Oral for adult and pediatric Axillary for neonate		No	No
	Rectal probe: Rectal			

C.2 General configuration

C.2.1 Alarm

Name	Default Config	Saved at Power Failure	Affected by Defaults
Latching Alarm	Off	Yes	No
Minimum Alarm Volume	2		
High Alarm Interval (s)	10 s		
Med Alarm Interval (s)	20 s		
Low Alarm Interval (s)	20 s		
Reminder Tone	On		
Alarm Light on Alarm Reset	On		

C.2.2 Review

Name	Default Config	Saved at Power Failure	Affected by Defaults
Spot Check Trends	Name/MRN button	MRN	Yes
	Option for Name/MRN button	All	
	Filter	All	
Continuous Trends	Name/MRN button	MRN	
	Option for Name/MRN button	Current patient	
	Interval	30 s	
Graphic Trends	Zoom	6 h	

C.2.3 Record

Name	Default Config	Saved at Power Failure	Affected by Defaults
SpO ₂ Waveform	Selected	Yes	No
Manual Inputs	Selected		

C.2.4 Others

Name	Default Config	Saved at Power Failure	Affected by Defaults
Brightness	5	Yes	Yes
Alarm Volume	2		
Key Volume	2		
Display Setup	All Parameters		
Parameter Time Out	15 min		
Height	cm	Yes	No
Weight	kg		
Pressure	mmHg		
Temp	°C		
Glucose	mg/dl		
I/O Fluid	ml		
Date	Current date	/	/
Time	Current time	/	/
Date Format	yyyy-mm-dd	Yes	No
Time Format	24 h	Yes	No

C.3 User Maintenance Items

Name	Default Config	Saved at Power Failure	Affected by Defaults
Spot Check	Off	Yes	No
SPO ₂ Tone	Mode 1		
Clinician ID Time Out	10 min		
Language	English		
Network Type	LAN		
Clear CMS IP at Startup	Off		
Data Send Method	eGateway		

FOR YOUR NOTES

D Alarm Messages

This chapter lists only the most important physiological and technical alarm messages. Some messages appearing on your monitor may not be included. In the “Solution” column, corresponding solutions are given instructing you to troubleshoot problems. If the problem persists, contact your service personnel.

- “*” means the alarm level is user-adjustable.
- XX represents a measurement or parameter label, such as NIBP, PR, etc.

D.1 Physiological Alarm Messages

Alarm Message	Alarm Priority	Cause	Solution
XX Too High	Med*	XX value exceeds the upper alarm limit.	Check the patient’s condition and check if the patient category and alarm limit settings are correct.
XX Too Low	Med*	XX value is lower than the lower alarm limit.	
SpO ₂ Desat	High	The SpO ₂ value has fallen below the desaturation alarm limit.	Check the patient’s condition and check if the alarm limit settings are correct.
No Pulse	High	The pulse signal was so weak that the monitor cannot perform pulse analysis.	Check the patient’s condition, SpO ₂ sensor and measurement site.

D.2 Technical Alarm Messages

D.2.1 NIBP Alarm Messages

Alarm Message	Clearable? (Yes/No)	Alarm Level	Cause	Solution
NIBP-Sys Limit Err	No	Low	The parameter alarm limit is inadvertently changed.	Contact Mindray or your service personnel.
NIBP-Dia Limit Err	No	Low		
NIBP-Mean Limit Err	No	Low		
NIBP-Sys Over Upper Limit	Yes	Low	The measured pressure is greater than the specified NIBP measurement upper limit.	Check the patient’s condition and keep the patient relaxed and still. If the error remains, contact Mindray or your service personnel.
NIBP-Dia Over Upper Limit	Yes	Low		
NIBP-Mean Over Upper Limit	Yes	Low		

Alarm Message	Clearable? (Yes/No)	Alarm Level	Cause	Solution
NIBP-Sys Over Lower Limit	Yes	Low	The measured pressure is lower than the specified NIBP measurement lower limit.	Restart the monitor and retry. If the error remains, contact Mindray or your service personnel.
NIBP-Dia Over Lower Limit	Yes	Low		
NIBP-Mean Over Lower Limit	Yes	Low		
NIBP SelfTest Err	Yes	High	SelfTest Failed. The cause may be the transducer or A/D sampling error.	Restart the monitor and retry. If the error remains, contact Mindray or your service personnel.
NIBP Init Err	Yes	Low	An error occurred to the NIBP module, or there is a problem with the communications between the module and the monitor.	Restart the monitor. If the error remains, contact Mindray or your service personnel.
NIBP Comm Err	Yes	High	An error occurred to the NIBP module, or there is a problem with the communications between the module and the monitor.	Restart the monitor. If the error remains, contact Mindray or your service personnel.
NIBP Loose Cuff	Yes	Low	The NIBP cuff is not properly connected, or there is a leak in the airway.	Check the patient's condition and verify patient type. Replace with an appropriate cuff and connect it correctly. If the problem still exists, contact your service personnel.
NIBP Air Pressure Err	Yes	Low	An error occurred to the air pressure.	Check the air pressure. Restart the monitor and retry. If the error remains, contact your service personnel.
NIBP Weak Signal	Yes	Low	The patient's pulse is weak or the cuff is loose.	Check the patient's condition and change the cuff application site. If the error persists, replace the cuff.

Alarm Message	Clearable? (Yes/No)	Alarm Level	Cause	Solution
NIBP Overrange	Yes	Low	The measured NIBP value is not within the specified range.	Contact Mindray or your service personnel.
NIBP Excessive Motion	Yes	Low	Patient's arm moves too much.	Check the patient's condition and reduce the patient motion.
NIBP Cuff Overpress.	Yes	Low	The NIBP airway may be occluded.	Check the airway and measure again.
NIBP Signal Saturated	Yes	Low	The NIBP signal is saturated.	Check the patient's condition and reduce the patient motion or other sources.
NIBP Air Leak	Yes	Low	The NIBP airway may leak air.	The NIBP cuff is not properly connected, or there is a leak in the airway.
NIBP Equip Err	Yes	High	System error; or pump, A/D sampling or pressure transducer error; or pointer error during software running.	Check the patient's condition and NIBP connections, or replace the cuff.
NIBP Timeout	Yes	Low	Time is out. In Adult/Pediatric mode, the measurement time is over 120 seconds; in neonate mode, the time is over 90 seconds.	
NIBP Cuff Type Wrong	Yes	Low	The cuff type applied mismatches the patient category.	Verify the patient category and replace the cuff.
NIBP Illegally Reset	Yes	Low	An illegal reset occurred during NIBP measurement.	Check if the airway is occluded.
VeniPuncture timeout	Yes	Low	System deflates the cuff after a certain time.	No operation is required.

D.2.2 SpO₂ Alarm Messages

Alarm Message	Clearable? (Yes/No)	Alarm Level	Cause	Solution
SpO ₂ Sensor Off (Masimo, Nellcor)	Yes	Low*(Monit or mode) Off* (Spot Check mode)	The SpO ₂ sensor has become detached from the patient or the module, or there is a fault with the SpO ₂ sensor, or an unspecified SpO ₂ sensor has been used.	Check the sensor application site and the sensor type, and make sure if the sensor is damaged. Reconnect the sensor or use a new sensor.
SpO ₂ Sensor Fault (Masimo)	No	Low		
SpO ₂ No Sensor (Masimo, Nellcor)	Yes	Low		
SpO ₂ Unknown Sensor (Masimo)	No	Low		
SpO ₂ Too Much Light (Masimo)	No	Low	There is too much light on the SpO ₂ sensor.	Move the sensor to a place with lower level of ambient light or cover the sensor to minimize the ambient light.
SpO ₂ No Pulse (Nellcor)	No	Low	SpO ₂ sensor failed to obtain pulse signal.	Move the sensor to a site with better perfusion.
SpO ₂ Comm Stop (Masimo, Nellcor)	No	High	An error occurred to the SpO ₂ module, or there is a problem with the communications between the module and the monitor.	Restart the monitor. If the error remains, contact your service personnel.
SpO ₂ Comm Abnormal (Masimo, Nellcor)	Yes	High		
SpO ₂ Init Err	Yes	High		
SpO ₂ Board Fault (Masimo)	No	Low	There is a problem with the SpO ₂ measurement board.	Do not use the module and contact your service personnel.
SpO ₂ Low Signal (Masimo)	No	Low	The SpO ₂ signal is too low or too weak.	Adjust the sensor application site.
SpO ₂ Weak Signal	No	Low		

Alarm Message	Clearable? (Yes/No)	Alarm Level	Cause	Solution
(Nellcor)				
SpO ₂ Interference (Masimo)	No	Low	The SpO ₂ signal has been interfered.	Check for any possible sources of signal noise around the sensor and check the patient for great motion.
SpO ₂ Comm Err (Masimo, Nellcor)	Yes	High	An error occurred to the SpO ₂ module, or there is a problem with the communications between the module and the monitor.	Restart the monitor. If the error remains, contact Mindray service personnel.
SpO ₂ Limit Err (Masimo, Nellcor)	No	Low	The alarm limit of SpO ₂ is changed inadvertently.	Contact your service personnel.
PR Limit Err (Masimo, Nellcor)	No	Low	The alarm limit of PR is changed inadvertently.	Contact your service personnel.
PR Overrange (Masimo, Nellcor, or from NIBP)	No	Low	The measured PR value exceeds the measurement range.	Contact your service personnel.

* means the alarm level is user-adjustable.

D.2.3 Temperature Alarm Messages

Alarm Message	Clearable? (Yes/No)	Alarm Level	Cause	Solution
Temp Init Err	Yes	High	An error occurred to the Temp module, or there is a problem with the communications between the module and the monitor, or Temp calibration error.	Restart the monitor. If the error remains, contact your service personnel.
Temp Comm Err	No	High	An error occurred to the Temp module, or there is a problem with the communications between the module and the monitor.	Restart the monitor. If the error remains, contact Mindray or service personnel.
Temp Alarm Limit Err	No	High	The alarm limit of Temp is changed inadvertently.	Contact Mindray or your service personnel.
Warmup Timed Out	Yes	Med	The initial probe temperature in measurement is too high.	Cool the probe and retry.
Warming Resistor Err	No	Med	The thermal resistor on the temperature probe has an error (Can not work properly).	Replace temperature probe.
Ambient Temp Overrange	Yes	Med	The environmental temperature is out the range of the monitor's measurement.	Change an environment and retry.
Temp Voltage Err	Yes	Med	The voltage is too high or too low.	Check the power supply.
Temp Prediction Err	Yes	Low	The measuring operation is improper.	Retry the measurement.
Temp SelfTest Err	No	High	An error occurs during Temp module initialization.	Replace the module.
Temp Over	No	High	The patient's	Reduce the patient's

Alarm Message	Clearable? (Yes/No)	Alarm Level	Cause	Solution
High Limit			temperature is too high, or an error occurs.	temperature, or replace the module.
Temp Over Low Limit	No	High	The patient's temperature is too low, or an error occurs.	Raise the patient's temperature, or replace the module.
Temp No Probe	Yes	Med	The probe is disconnected.	Reconnect the probe.
Temp Probe Misplaced	Yes	Med	The temperature probe is not well placed, or not inserted into probe well.	1. Check if the probe well is installed. 2. Properly re-insert the probe into probe well.
Temp Measuring Timeout	Yes	Med	The measuring time is over 5 minutes in Monitor mode.	Return the sensor to the probe well, and take a temperature again.

D.2.4 Recorder Alarm Messages

Alarm Message	Clearable? (Yes/No)	Alarm Level	Cause	Solution
Recorder Init Error	Yes	Low	An error occurred to the module, or there is a problem with the communication between the module and the monitor.	Restart the monitor. If the problem still exists, contact Mindray or your service personnel.
Recorder Selftest Error	Yes	Low		
Recorder Unavailable	Yes	Low		
Recorder Comm Error	Yes	Low		
Recorder Vlt High	No	Low	There is a problem with the system power supply. Restart the monitor.	If the message is prompted for several times, contact Mindray or your service personnel.
Recorder Vlt Low	No	Low		
Recorder Head Hot	No	Low	The recorder has been working for too long time.	Stop the recording and resume the recording until the recorder's print head cools down.
Rec Head Wrong Pos.	Yes	Low	The thermal head of the recorder is in wrong position.	Restore the control lever of the recorder to its previous position.

Alarm Message	Clearable? (Yes/No)	Alarm Level	Cause	Solution
Recorder out of paper	Yes	Low	The recorder paper is used up.	Replace with a new paper roll.

D.2.5 Power Alarm Messages

Alarm Message	Clearable? (Yes/No)	Alarm Level	Cause	Solution
12V Too High	No	High	There is a problem with the system power supply.	Restart the monitor. If the problem still exists, contact Mindray or your service personnel.
12V Too Low	No	High		
5V Too High	No	High		
5V Too Low	No	High		
3.3V Too High	No	High		
3.3V Too Low	No	High		
Battery Too Low	No	Med	The battery charge is too low.	Connect the monitor to an AC power source and allow the batteries to charge immediately.
Battery Depleted	No	High	The battery charge is almost depleted.	
Power Board Comm Err	No	High	No data from power module has been received for 5 seconds.	Restart the monitor. If the problem still exists, contact Mindray or your service personnel.
RT Clock Need Reset	No	Low	There is a problem with the button cell.	Reset the system time and restart the monitor. If the problem still exists, contact Mindray or your service personnel.
PWR interrupted. Check meas. State.	Yes	Low	Power supply to the monitor was interrupted.	Check the measurements when the monitor restarts. If the problem still exists, contact your service personnel or Mindray.

D.2.6 System Alarm Messages

Alarm Message	Clearable? (Yes/No)	Alarm Level	Cause	Solution
No CMS	Yes	Low	The monitor is disconnected from the CMS.	Check network connection.

FOR YOUR NOTES

E Symbols and Abbreviations

E.1 Symbols

μA	microampere
μV	microvolt
μs	Microsecond
A	ampere
Ah	ampere hour
bpm	beat per minute
bps	bit per second
$^{\circ}\text{C}$	centigrade
cm	centimeter
dB	decibel
DS	dyne second
$^{\circ}\text{F}$	fahrenheit
g	gram
GHz	gigahertz
h	hour
Hz	hertz
in	inch
k	kilo
kg	kilogram
kPa	kilopascal
L	litre
lb	pound
m	meter
mAh	milliampere hour
Mb	mega byte
mg	milligram
min	minute
ml	milliliter
mm	millimeter
mmHg	millimeters of mercury
ms	millisecond
mV	millivolt
mW	milliwatt
M Ω	megaohm
nm	nanometer
rpm	breaths per minute
s	second

V	volt
VA	volt ampere
Ω	ohm
W	watt
—	minus
-	negative
%	percent
/	per; divide; or
~	to
+	plus
=	equal to
<	less than
>	greater than
\leq	less than or equal to
\geq	greater than or equal to
\pm	plus or minus
x	multiply
©	copyright

E.2 Abbreviations

AAMI	Association for Advancement of Medical Instrumentation
AC	alternating current
ADT	Admit/Discharge/Transfer
Adu	adult
AVPU	Alert, Reacting to Voice, Reacting to Pain, Unresponsive
CE	Conformité Européenne
CISPR	International Special Committee on Radio Interference
CMOS	complementary metal oxide semiconductor
CMS	central monitoring system
DC	direct current
Dia	diastolic
DIAP	Datascope Improved ASCII Protocol
DPI	dot per inch
EEC	European Economic Community
EMC	electromagnetic compatibility
EMI	electromagnetic interference
EMR	Electronic Medical Record
GCS	Glasgow Comma Scale
ID	identification
IEC	International Electrotechnical Commission
IPS	Individual Parameter Score
ISO	International organization for standardization
IEEE	Institute of Electrical and Electronic Engineers
IP	internet protocol
LED	light emitting diode
MDD	Medical Device Directive
MetHb	methemoglobin
MEWS	Modified Early Warning Score
MRI	magnetic resonance imaging
N/A	not applied
Neo	neonate
NEWS	National Early Warning Score
NIBP	noninvasive blood pressure
NIBP-D	NIBP-diastolic pressure
NIBP-M	NIBP-mean pressure
NIBP-S	NIBP-systolic pressure
P	power
PD	photodetector

Ped	pediatric
Pleth	plethysmogram
PR	pulse rate
RAM	random access memory
ROM	read-only memory
SpO2	arterial oxygen saturation from pulse oximetry
TD	temperature difference
TEMP	temperature

F Anomalies

F.1 NIBP Smart Inflation Anomaly

The NIBP smart inflation function is not fully functional at this time and so may not perform as expected. The function, accessible only through the [**Factory Maintenance**] menu, is used for research and development only. Although there is no distinct difference between smart inflation and normal inflation, it is recommended to keep the function [**Off**].

NOTE

- **The anomaly would not present a safety hazard to either the operator or the patient.**
-

FOR YOUR NOTES

P/N: 046-005276-00 (4.0)
SW Version: 03.07.XX