

Volkswagen Crafter 2006 - 02/2017
Mercedes Sprinter 03/2006 -

Partnr.: VW-107-B1U

- Fitting instructions electric wiring kit tow bar with 12-N socket up to DIN/ISO Norm 1724.
- We would expressly point out that assembly not carried out properly by a competent installer will result in cancellation of any right to damage compensation, in particular those arising by virtue of the product liability act.
- Contents of these kits and their fitting manuals are subject to alteration without notice, please ensure that these instructions are read and fully understood before commencing installation.
- Do not overload circuits; the maximum loads per connection are detailed in this manual.
- Attention! Before Installation, please read this manual carefully and inform your customer to consult the vehicle owners manual to check for any vehicle modifications required before towing.
- In the event of functional problems, troubleshooting must be limited to about 0.5 hours, contact the technical support:
t.skinner@ecs-electronics.com / 07440 202 052.

TECHNICAL SUPPORT

CALL
07440
202
052

ECS ELECTRONICS

MONDAY TO FRIDAY
08.00 - 11.00 am
12.00 - 05.00 pm
t.skinner@ecs-electronics.com
www.ecs-electronicsuk.co.uk

Part list

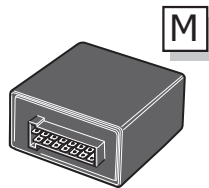
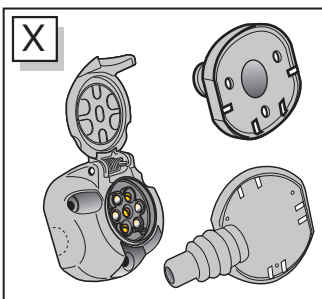
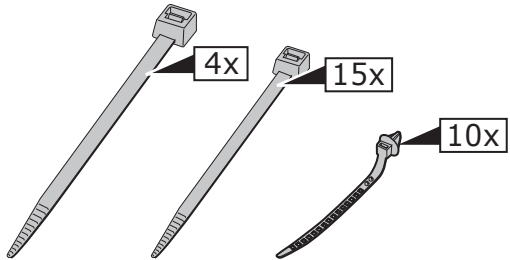
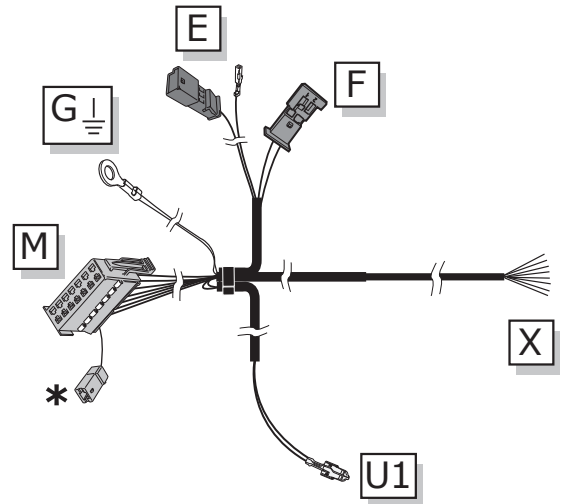
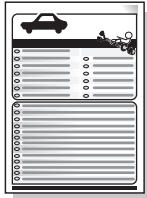
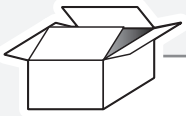

* Reverse signal preparation
 **Pag. 12**

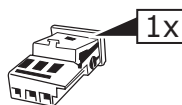
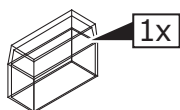
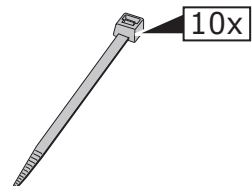
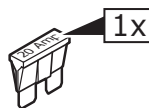
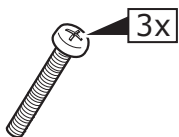

ROUTING

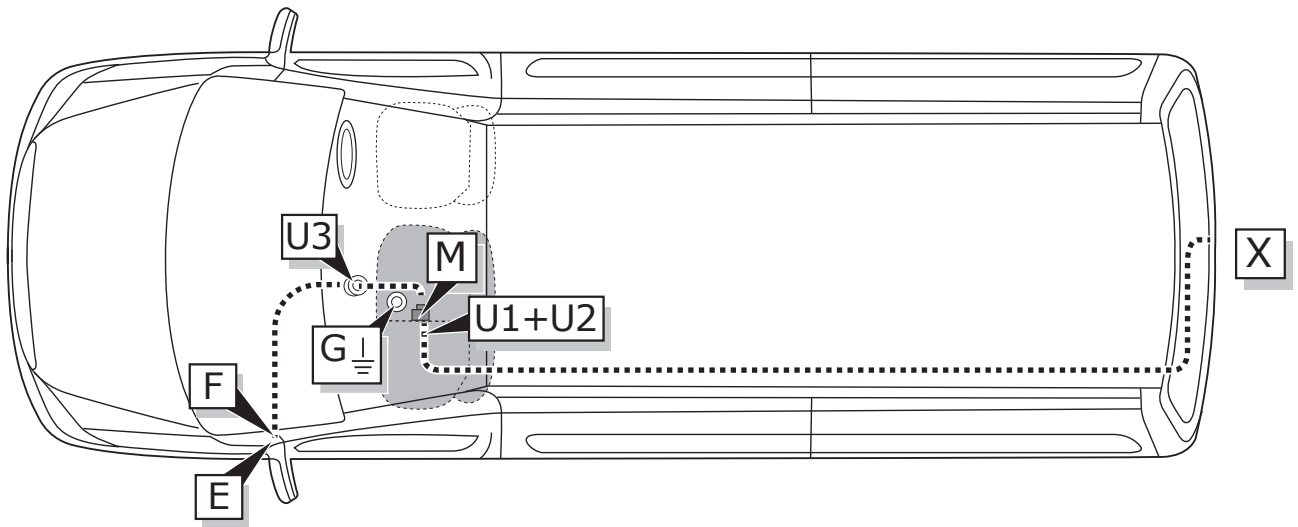

1

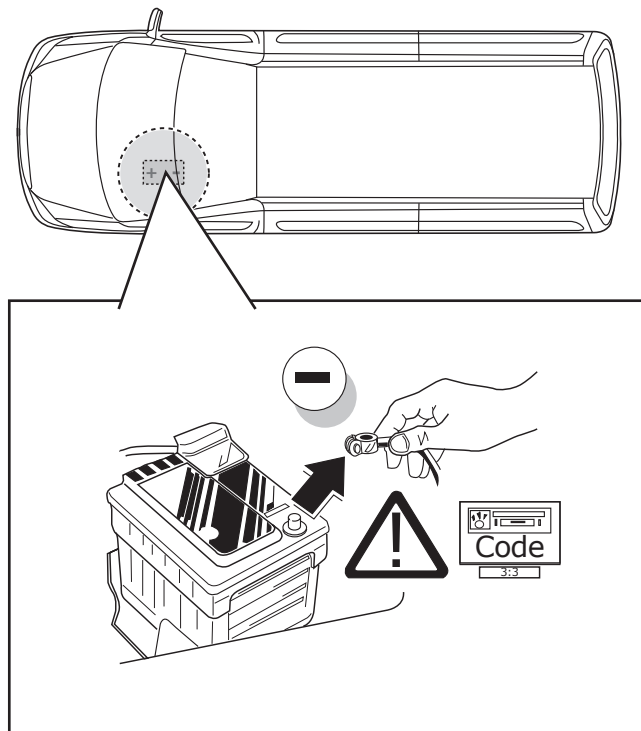

2

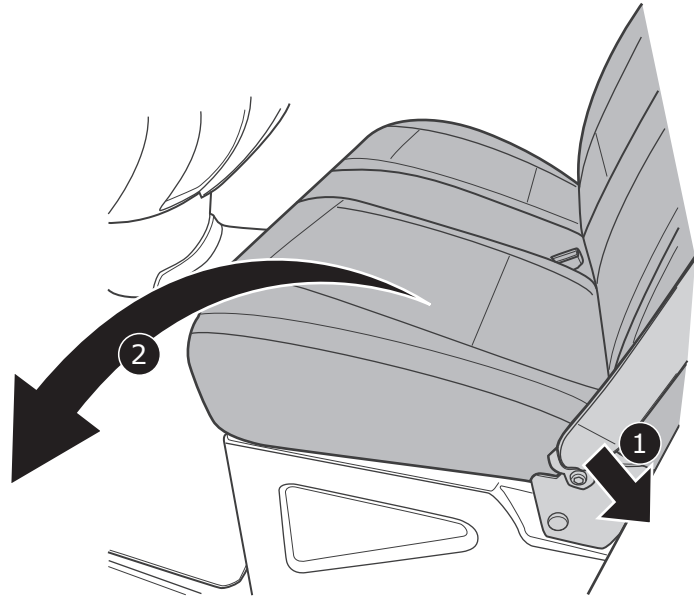
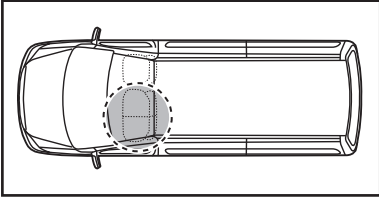

3

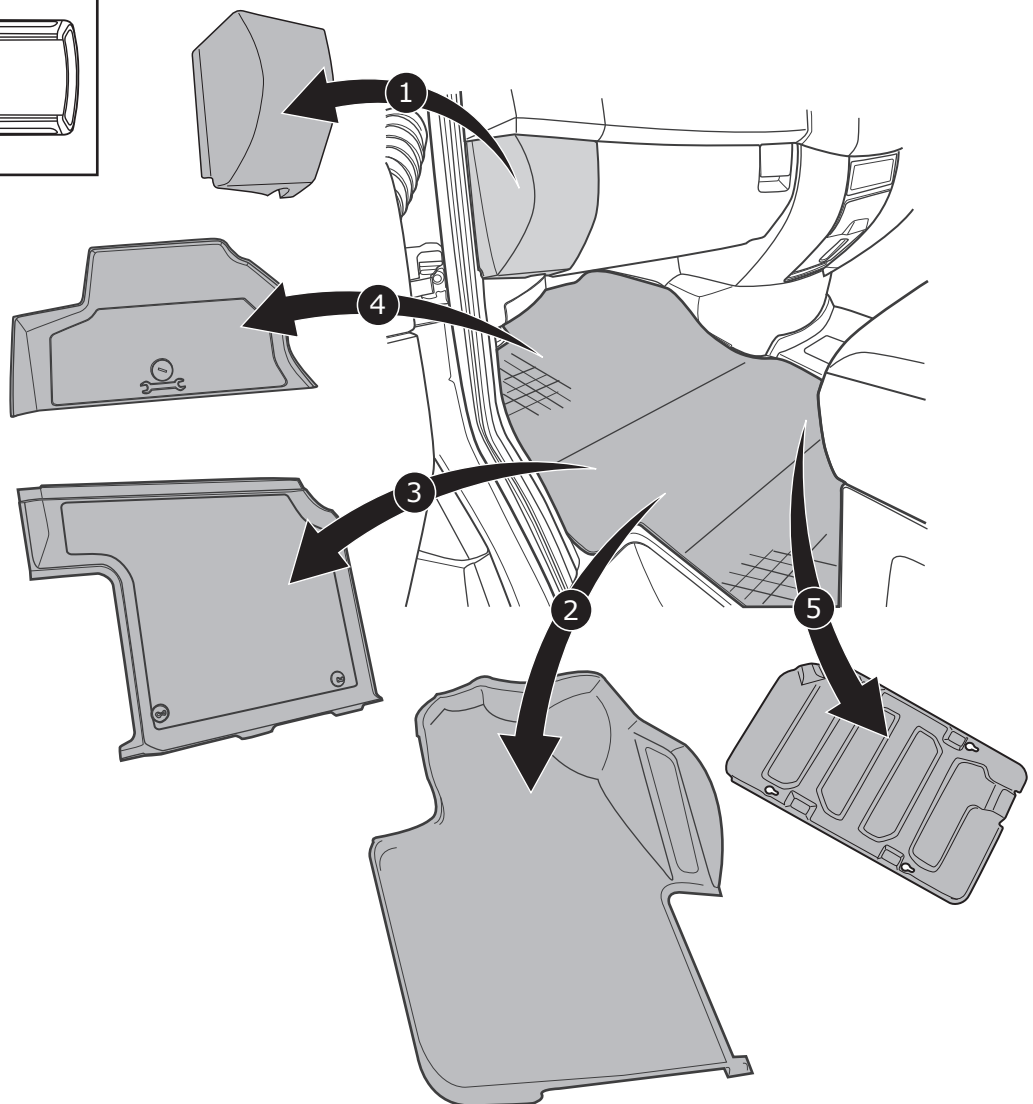
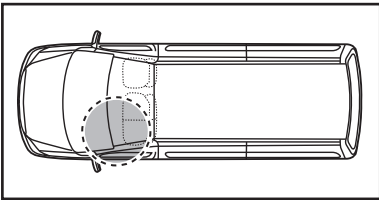

4

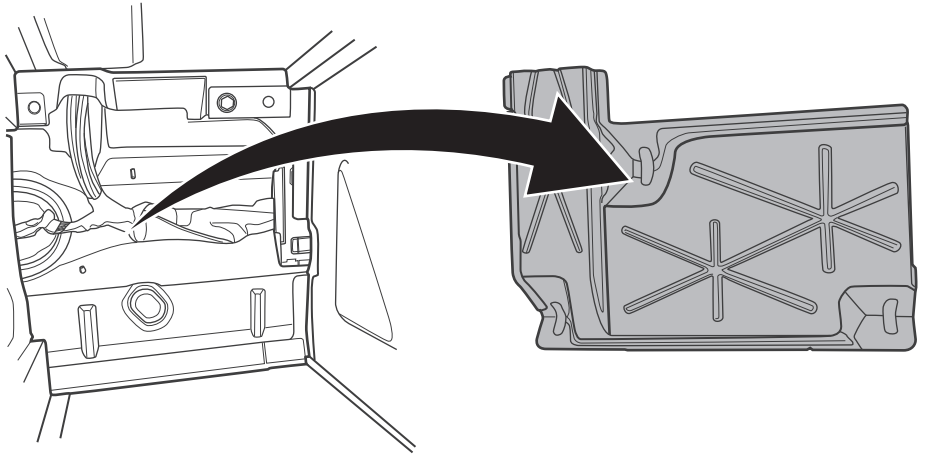
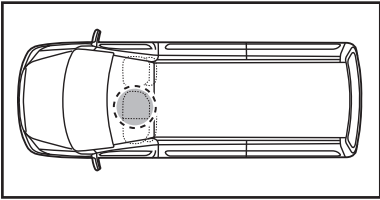

5

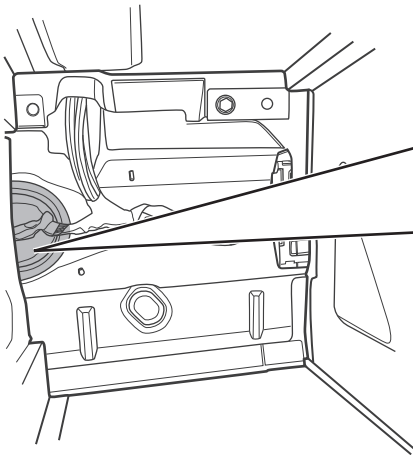

Underside

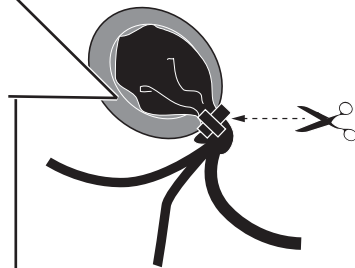

1

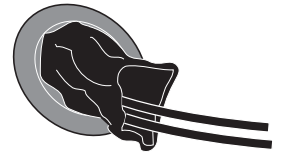

2

3

6

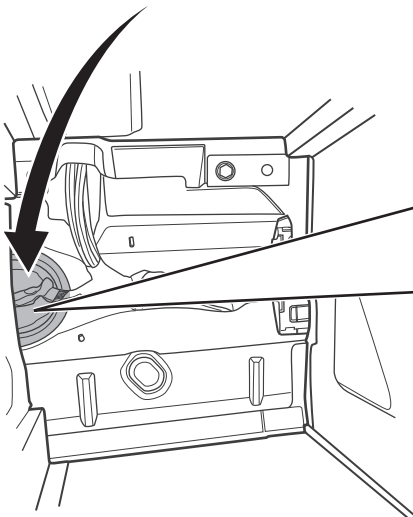
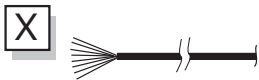

1



Underside

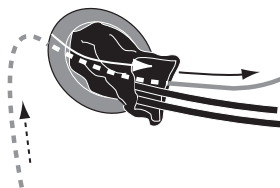

2

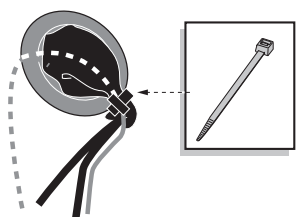

3

15x

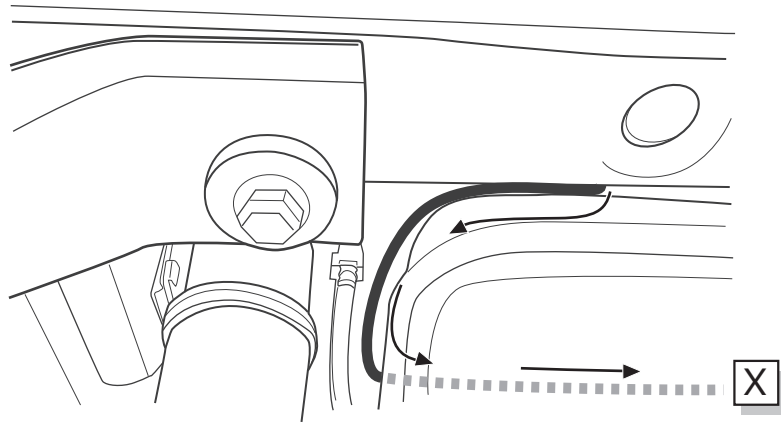
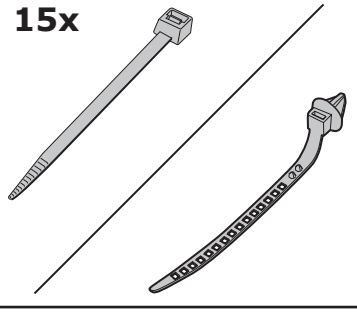

1

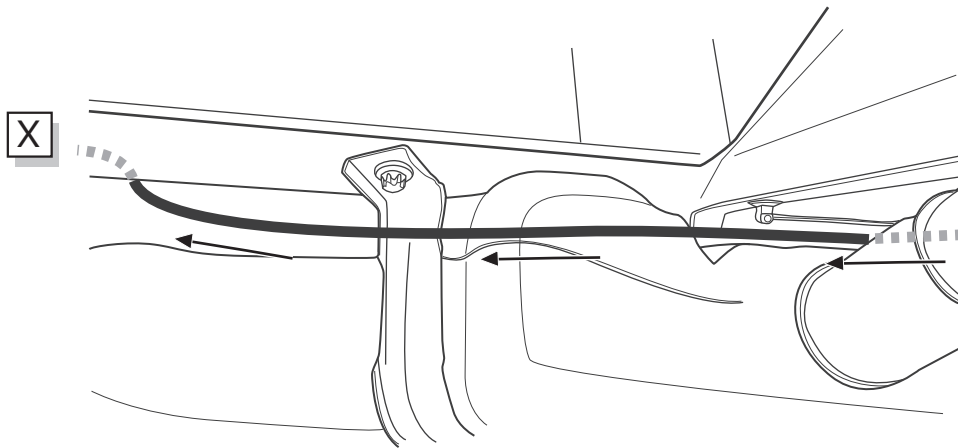

2

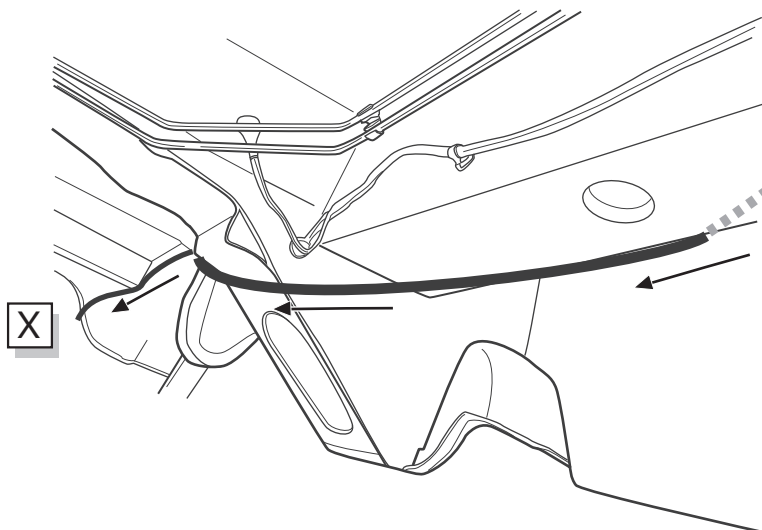

3

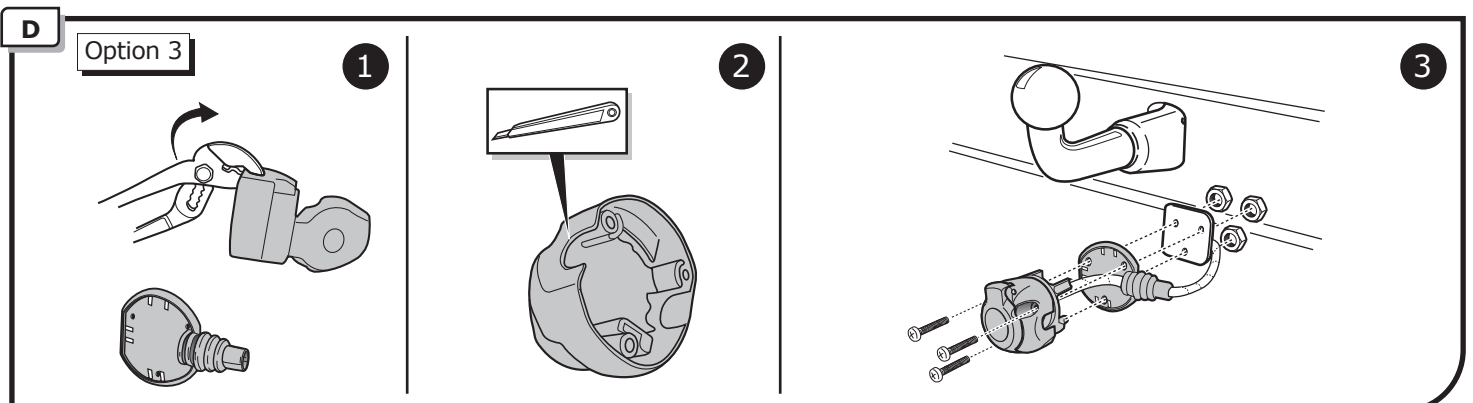
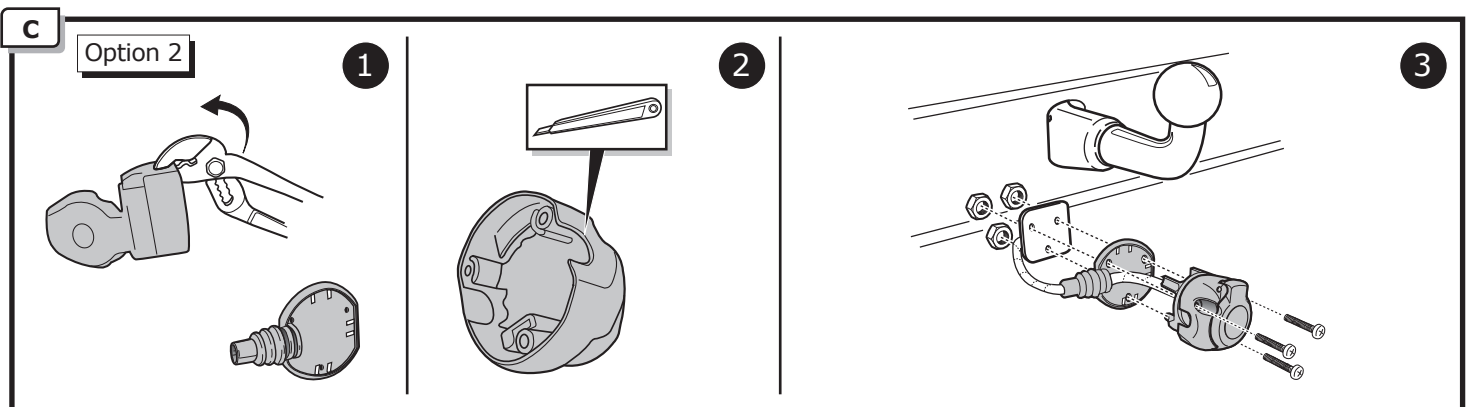
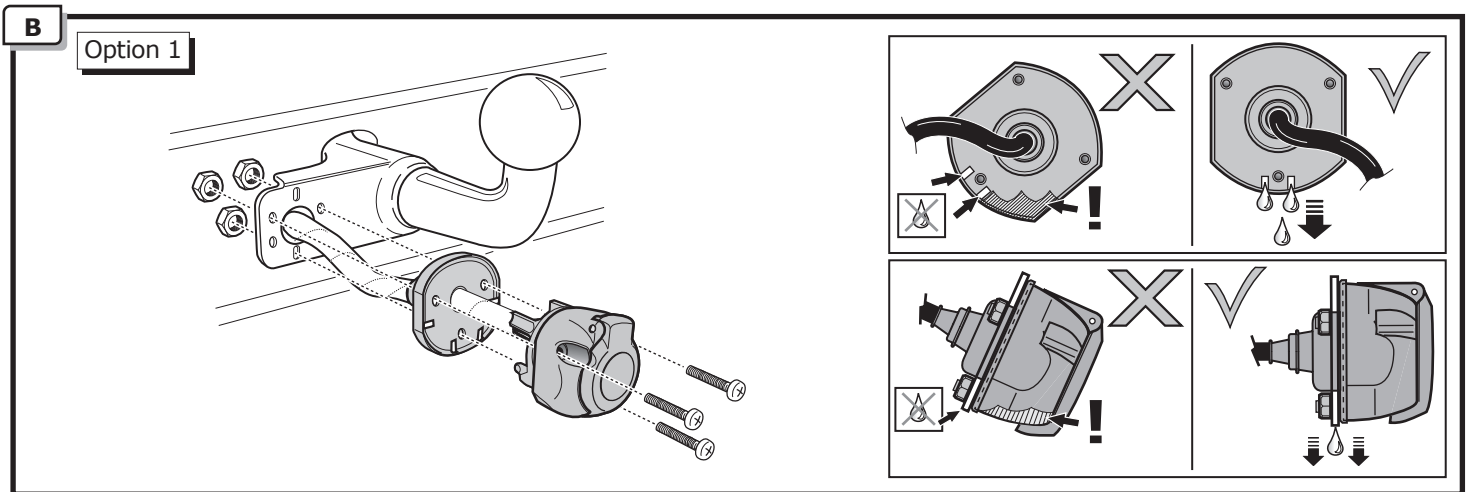
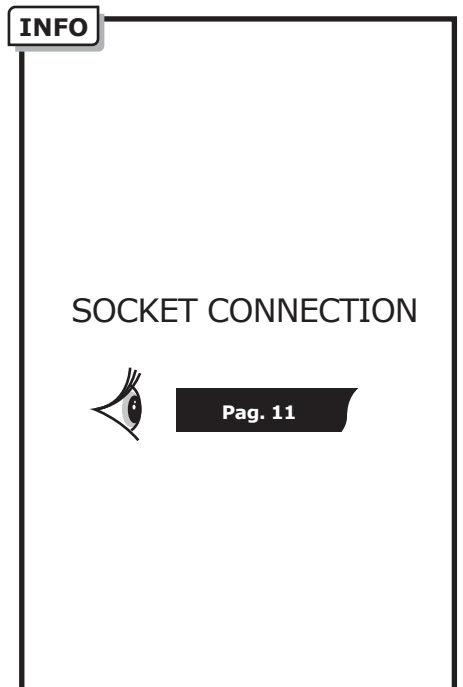
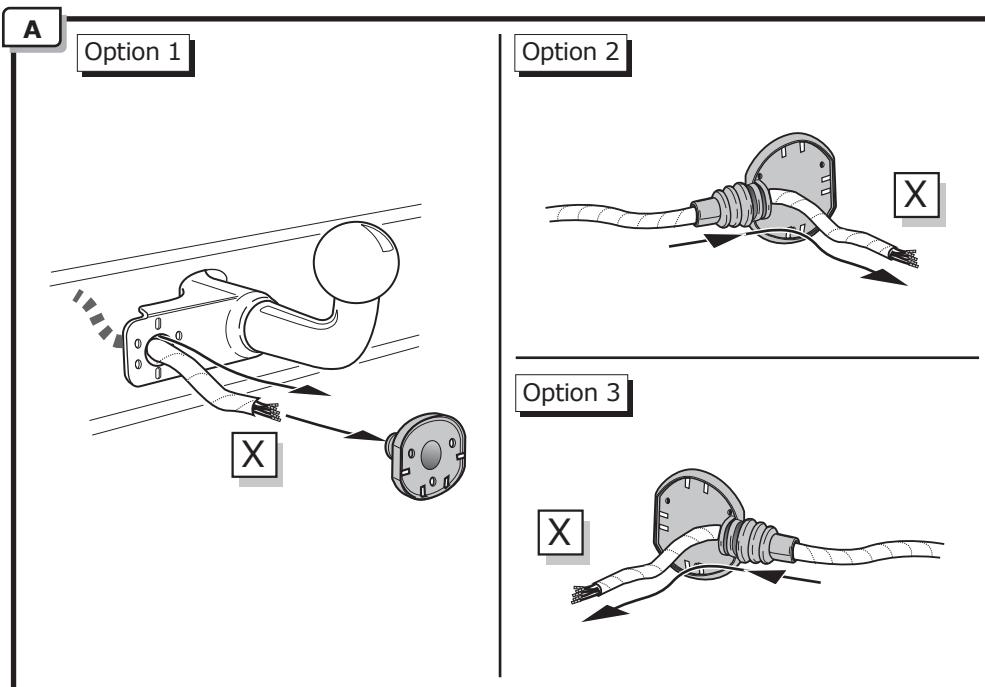

8

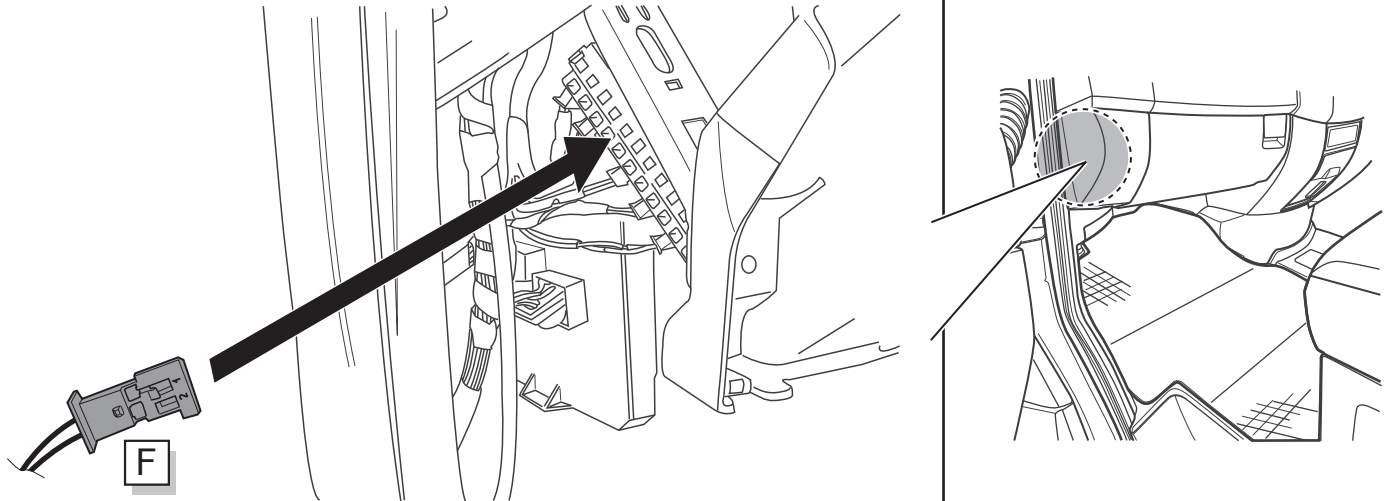

9

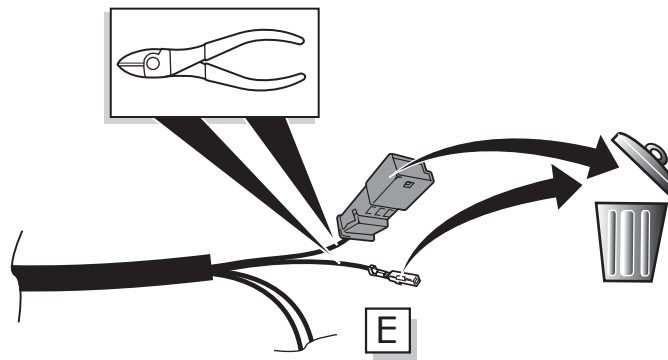

This connection is no longer needed.

1

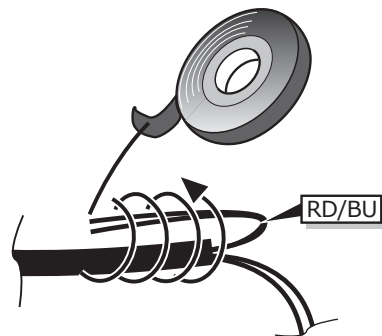

Please Isolate.

2

10

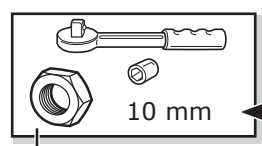
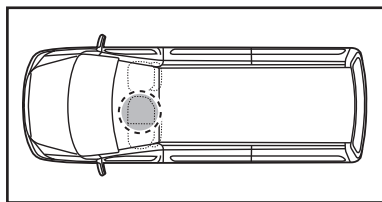

1

2

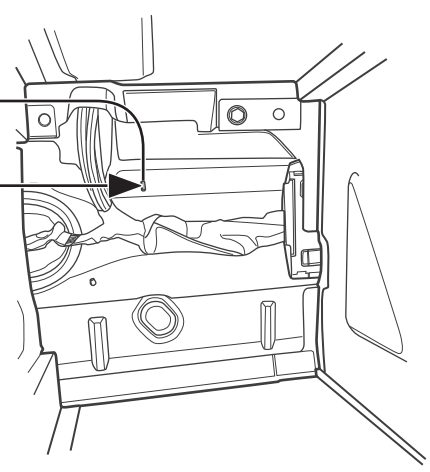

11

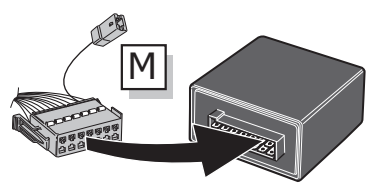

1

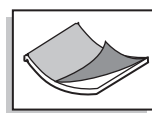

2

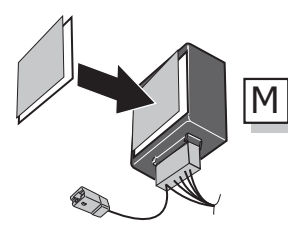
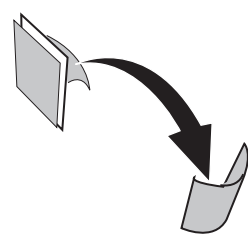

3

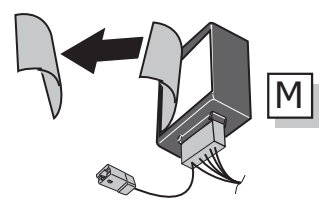

4

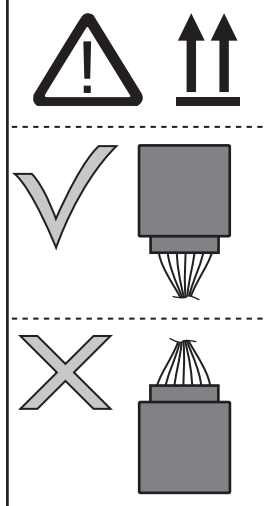

12

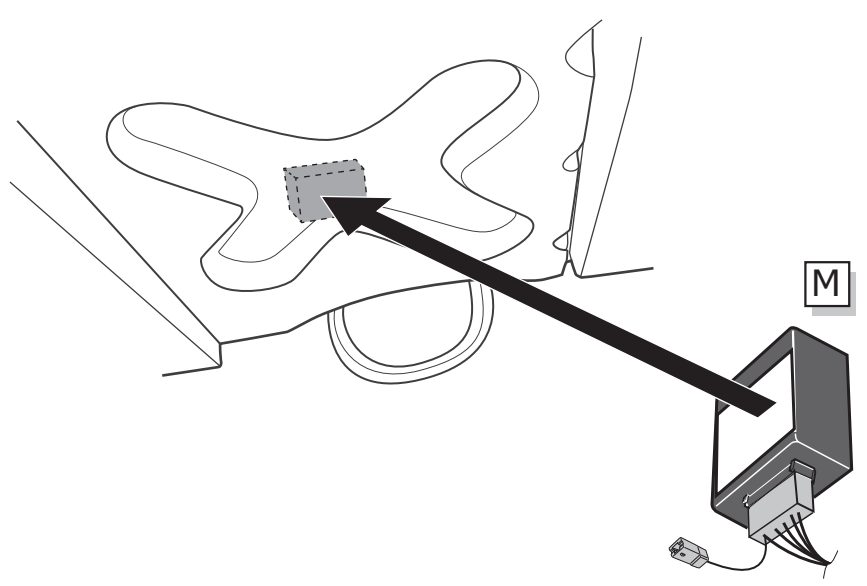
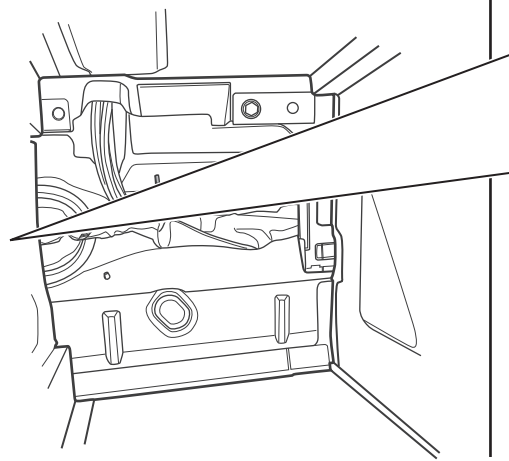
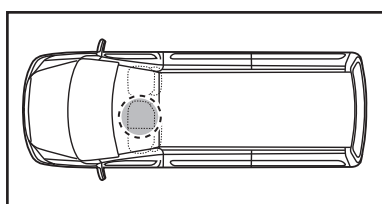

M

13

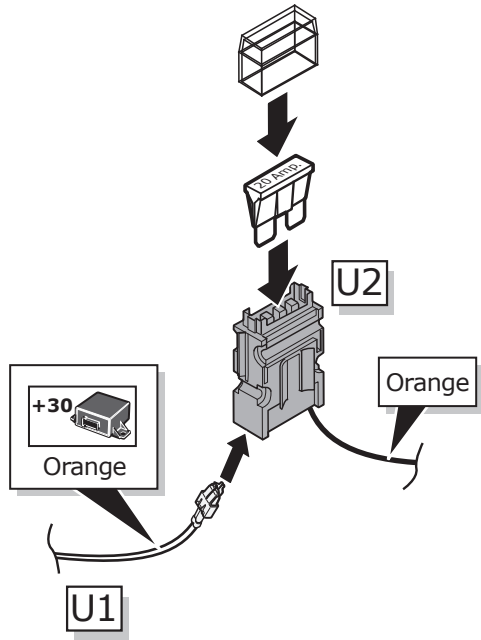
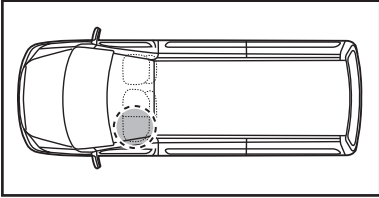

14

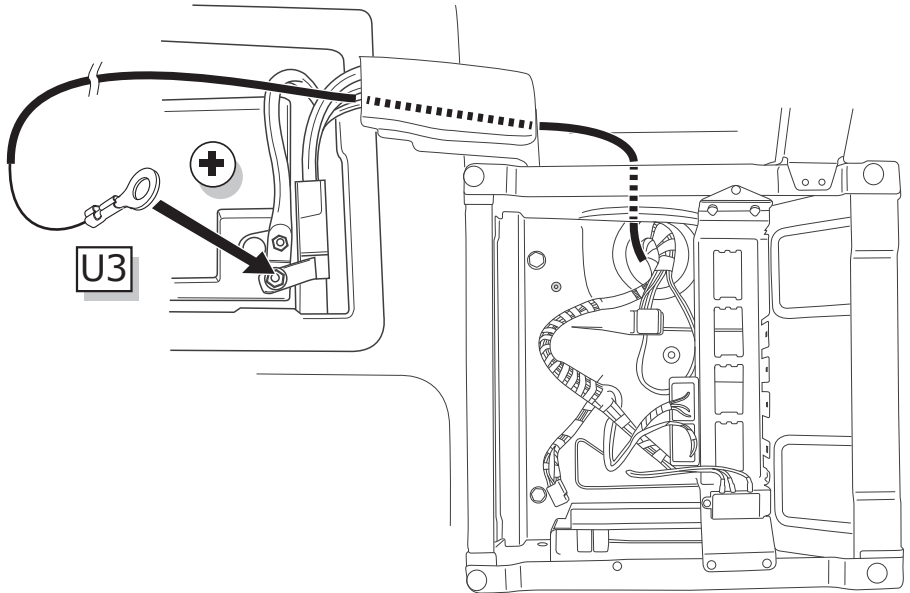
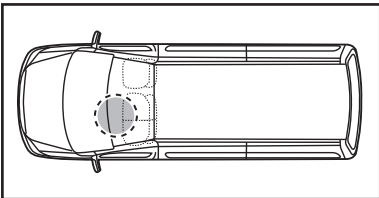

15

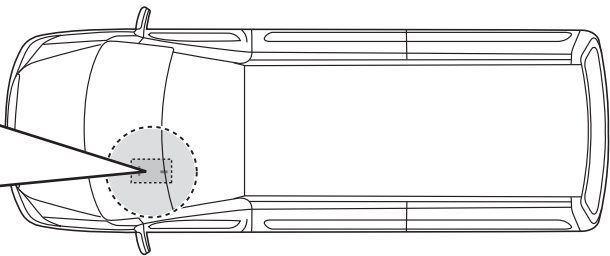
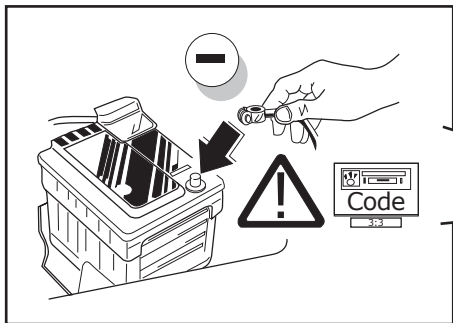

! TEST ALL THE CIRCUITS WITH A TEST DEVICE WITH THE CORRECT POWER LOAD FOR EACH FUNCTION. A TEST DEVICE WITH LED'S CANNOT BE USED FOR THIS PURPOSE.

INFO

REINSTALL TRIM.

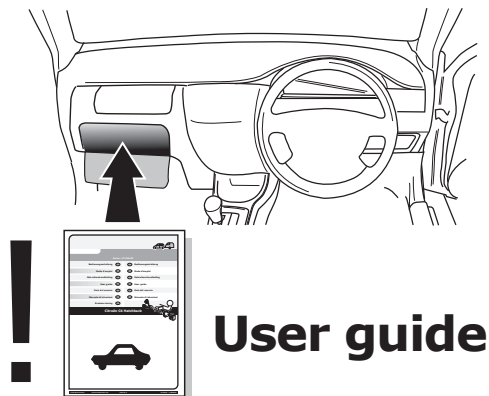

INFO

SOCKET CONNECTION

DIN/ISO 1724							
	1/L	2	3/31	4/R	5/58-R	6/54	7/58-L
Pmax	21W	21W		21W	42W	3x21W	42W
Colour	Black/White	Blue	Brown	Black/Green	Grey/Red	Black/Red	Grey/Black

Reverse signal preparation

A

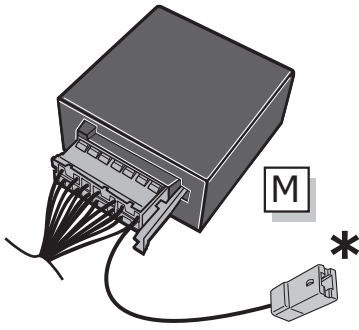

1

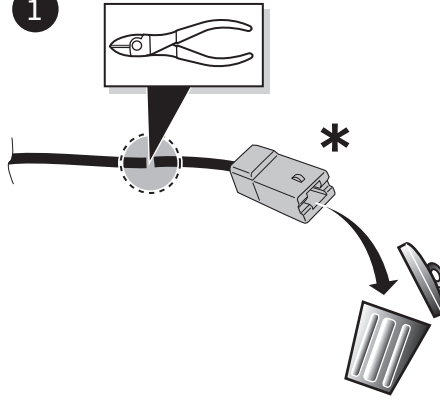

2

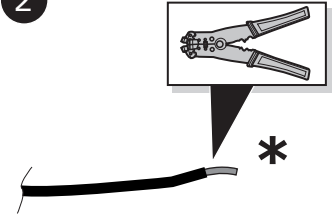

B

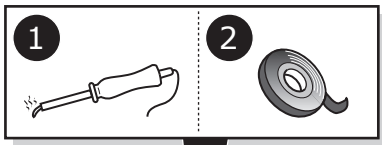

⚠ MAX = 21W

