

RCA JUNIOR VOLTOHMYST®

Type WV-77C

ELECTRONIC METER

- Specifications
- Operation
- Applications
- Maintenance

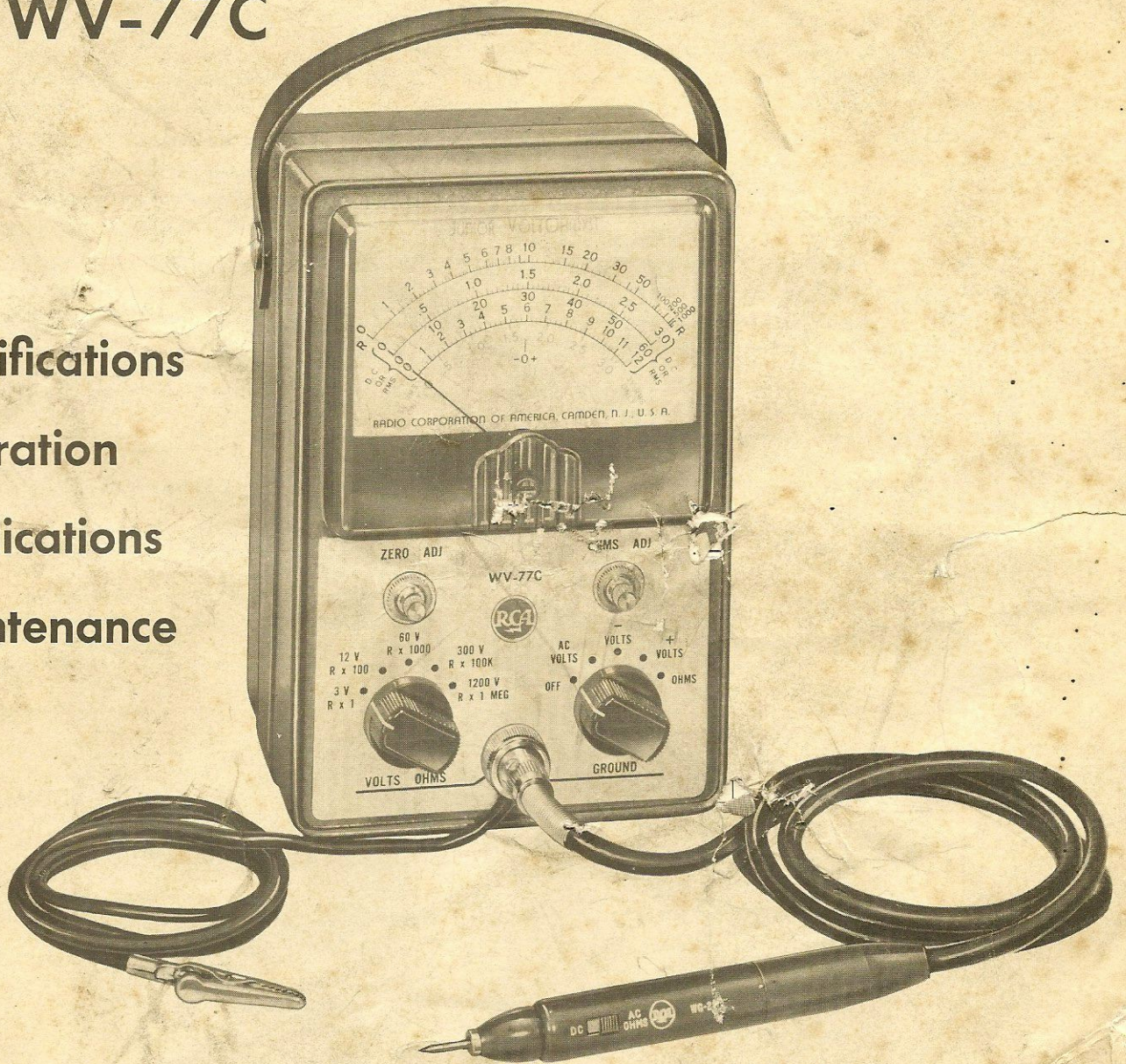

RADIO CORPORATION of AMERICA
 TEST AND MEASURING EQUIPMENT HARRISON, N. J.

Safety Precautions

The metal case of this instrument is connected to the ground of the internal circuit. For proper operation, the ground cable of the WV-77C should always be connected to the ground of the equipment under test. The WG-299B DC/AC-Ohms Probe and Cable has a shield throughout its length which is connected to the instrument ground and case. Always handle the WG-299B by the insulated probe housing.

An important point to remember is that there is always danger inherent in testing electrical equipment which operates at hazardous voltages. Therefore, the operator should thoroughly familiarize himself with the equipment under test before working on it, bearing in mind that high voltages may appear at unexpected points in defective equipment. Additional precautions which experience in the industry has shown to be important are listed below.

1. It is good practice to remove power before connecting test leads to high-voltage points. If this is impractical, be especially careful to avoid accidental contact with equipment racks and other objects which

can provide a ground. Working with one hand in your pocket and standing on a properly insulated floor lessens the danger of shock.

2. Filter capacitors may store a charge large enough to be hazardous. Therefore, discharge filter capacitors before attaching test leads.

3. Remember that leads with broken insulation provide the additional hazard of high voltages appearing at exposed points along the leads. Check test leads for frayed or broken insulation before working with them.

4. To lessen the danger of accidental shock, disconnect test leads immediately after test is completed.

5. Remember that the risk of severe shock is only one of the possible hazards. Even a minor shock can place the operator in hazard of more serious risks such as a bad fall or contact with a source of higher voltage.

6. The experienced operator continuously guards against injury and does not work on hazardous circuits unless another person is available to assist in case of accident.

ACCESSORIES

Supplied with WV-77C

1 DC/AC-Ohms Probe and Cable Type WG-299B
1 Slip-On Alligator Clip Stock No. 210088
1 1.5-Volt Battery Type VS036
1 RCA-12AU7 Tube 1 Registration Card
1 RCA-12AL5 Tube Clip Insulator 1 Instruction Booklet

Available on Separate Order

For Measuring AC Voltages at Frequencies from 50 Kc to 250 Mc:
Crystal-Diode Probe Type WG-301A
For Increasing DC Voltage Range to 50,000 Volts:
High-Voltage Probe Type WG-289
Multiplier Resistor Type WG-206

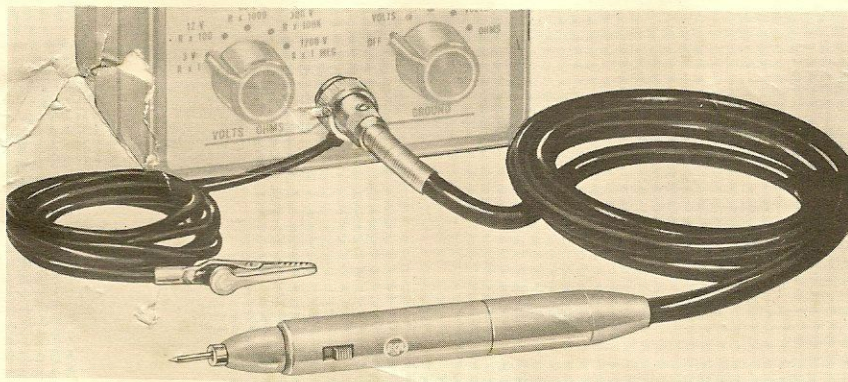

Cables and probe supplied with WV-77C

Devices or arrangements shown or described herein may use patents of RCA or others. Information contained herein is furnished without responsibility by RCA for its use and without prejudice to RCA's patent rights.

© 1956 by Radio Corporation of America
All Rights Reserved
TMK ®, Marca Registrada

TEST AND MEASURING EQUIPMENT
RADIO CORPORATION OF AMERICA, HARRISON, NEW JERSEY

Instr. WV-77C (1) 10-56
Printed in U.S.A.

CONTENTS

	<i>Page</i>
Safety Precautions	2
General Description	4
Functions of Controls and Terminals.....	4
Specifications	5
Operation and Applications.....	5
Accessories	8
Special Applications	8
Maintenance	9
Schematic Diagram	10
Replacement Parts List.....	11

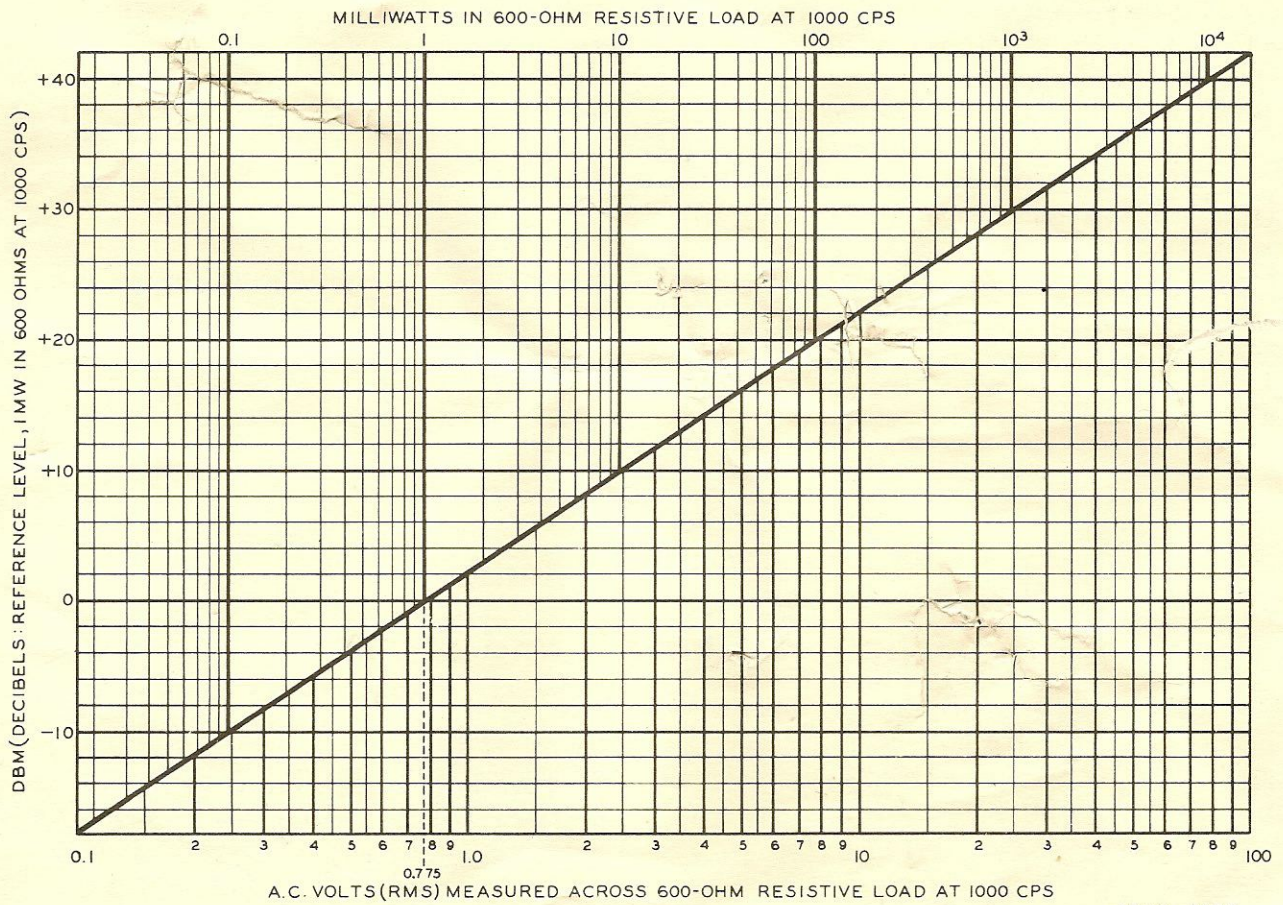

Note: For loads other than 600 ohms, see table on page 10

Figure 1. Chart for conversion of rms voltage to dbm values.

General Description

The Junior VoltOhmyst* WV-77C is designed to measure dc voltages from 0.1 volt to 1200 volts, rms sine-wave voltages from 0.1 volt to 1200 volts, and resistance values from 0.2 ohm to 1000 megohms. The ac voltmeter of the WV-77C features an electron tube as the half-wave rectifier. It is a peak indicating type and is calibrated in terms of the rms voltage of a sine wave. The WV-77C has high input impedance on all dc and ac voltage ranges. Only two cables are used with this instrument for all measurements, providing ease and flexibility in operation.

The frequency range of the WV-77C, depending on the impedance of the voltage source, is flat to approximately 3 megacycles. When the auxiliary WG-301A Crystal Diode Probe is used, the dc voltage ranges are accurate to within $\pm 10\%$ from 50 Kc to 250 Kc.

The WV-77C is equipped with a single unit probe, the WG-299B DC/AC-Ohms Probe and Cable. This probe is provided with a built-in switch which permits quick adaptation to either dc-voltage measurements or ac-voltage and resistance measurements without requiring a change of probes and cables.

The Junior VoltOhmyst utilizes a push-pull amplifier type dc bridge circuit which affords excellent linearity of response, good stability, and very high input impedance. (See Schematic Diagram, Fig. 5.) When no measurement is being made, the cathode cur-

rents through the triodes of V2 are equal. When a measurement is being made, a voltage is applied between the grid of V2A and ground to provide a change in cathode current of this triode unit. Since resistor R20 functions as a cathode-coupling element, the change in cathode current through this resistor alters the grid-to-cathode potential of V2B, a condition which modifies the cathode current of V2B. When, for example, the current flow through V2A increases, the flow of current through V2B decreases. The meter reading is proportional to the difference between the plate currents of the triodes.

Additional features of the WV-77C include provision for zero-center indication, useful in discriminator and bias measurements; separate scales for low ac-voltage measurements; a circuit design which allows measurements of the ac component of a signal when the dc component is present and vice versa; a separate dc probe with a 1-megohm resistor which minimizes capacitance-loading effects; and electronic protection against meter burn-out.

The WV-77C Junior VoltOhmyst is a light-weight compact, and versatile instrument. A reliable measuring device, it will prove extremely useful in television applications as well as in many industrial applications.

*Trade Mark "VoltOhmyst" Reg. U. S. Pat. Off.

Functions of Controls and Terminals

Function selector—Has two functions; turns the power off in "OFF" position, and permits choice of type of measurement to be made.

Range selector—Permits choice of range for the desired voltage or resistance measurement.

ZERO ADJ control—Used to position the meter pointer at either the left-hand "0" position or to the zero-center "-0+" position, when function selector is set to "+VOLTS".

OHMS ADJ control—Used to position the meter

pointer at the extreme right line on the "R" scale when the function selector is in "OHMS" position.

VOLTS OHMS terminal—Voltages and resistances to be measured are applied between this terminal and the clip of the GROUND cable as described under "operation" below.

GROUND cable—is directly connected to the chassis of the instrument. It serves as a common ground for the WV-77C and the chassis of the equipment under test or associated test instruments.

Specifications

Electrical

DC Voltmeter:

Ranges..... 0 to 3, 12, 60, 300, 1200 volts

Input Resistance (With

With WG-299B switch set to "DC":

All Ranges..... 11 megohms

Accuracy:

With Function Selector Set on "+VOLTS"

±3% of full scale

With Function Selector Set on "-VOLTS"

±5% of full scale

AC Voltmeter:

Ranges:

RMS Values of Sine Waves..... $\left\{ \begin{array}{l} 0 \text{ to } 3 \text{ volts on} \\ \text{separate scale} \\ 0 \text{ to } 12, 60, 300, \\ 1200 \text{ volts} \end{array} \right.$

Accuracy..... ±5% of full scale

Input Resistance and Capacitance—Approx.

(with WG-299B switch set to "AC"):

3, 12, and 60-V Ranges... 0.2 megohm shunted by 75 $\mu\mu\text{f}$

300-V Range..... 1 megohm shunted by 50 $\mu\mu\text{f}$

1200-V Range..... 2 megohms shunted by 50 $\mu\mu\text{f}$

Frequency Response (with WG-299B switch set to "AC"):

For Source Impedance of 100 Ohms#... flat within ±1 db
from 30 cps to
3 Mc.

For Source Impedance of 1000 Ohms#... flat within ±1 db
from 30 cps to
0.75 Mc.

With Crystal-Diode Probe WG-264▲... flat within ±1 db
from 50 Kc. to
250 Mc.

Maximum Input Voltages:

Combined AC Peak Voltage and DC Voltage:

When Instrument is Set up to Measure DC... 1800 peak volts

When Instrument is Set up to Measure AC:

3-volt, 12-volt, and 60-volt ranges..... 400 dc volts

300-volt and 1200-volt ranges..... 600 dc volts*

Ohmmeter:

Ranges, five..... 0 to 1000 megohms

Center-Scale Values

10, 1000, 10000 ohms, 1.0 megohm, 10 megohms

Meter Movement:

DC Current for Full-Scale Deflection..... 200 μa

Tube Complement:..... 1 RCA-12AL5, 1 RCA-12AU7

Power Supply:

Voltage Rating..... 105 to 125 volts

Frequency Rating..... 50 to 60 cps

Consumption..... 5 watts approx.

Battery:

1.5-volt cell..... RCA Type VS036

Mechanical

Over-all Dimensions:

Height..... 8 inches

Width..... 5 $\frac{3}{8}$ inches

Depth..... 4 $\frac{1}{2}$ inches

Weight..... 4 pounds

#The frequency response shown is for only the 3, 12, and 60-volt ranges.

The instrument is accurate at power-line frequencies for all ranges.

▲Available on separate order.

*Combined AC Peak and DC Voltages must not exceed 1800 volts.

Operation and Applications

Preliminary Adjustments:

To prepare the WV-77C for use, make the following connections and adjustments:

1. Connect the WG-299B DC/AC-Ohms Probe and Cable to the VOLTS OHMS terminal.
2. Plug the power cord into an ac outlet supplying 105-125 volts at 50/60 cycles, and adjust the controls as indicated below:
 - a. Turn the function selector to "+VOLTS" position, and allow several minutes for the instrument to warm up.
 - b. Adjust the ZERO ADJ control to position the meter pointer at the left-hand "0".

NOTE: To check this adjustment, notice whether or not the position of the meter pointer changes when the function selector is switched to "-VOLTS". If the pointer position changes, readjust the mechanical zero control as described in the Maintenance Section.

- c. Turn the function selector to "OHMS" position. The pointer should deflect to approximately full scale.
- d. Rotate the OHMS ADJ control to position the pointer at the last line on the "R" (ohms) scale.

The instrument is now ready for use.

DC-Voltage Measurements:

CAUTION: See Maximum Input Voltages, under ELECTRICAL SPECIFICATIONS.

When making dc-voltage measurements, the sliding switch on the WG-299B probe should be set to "DC".

The WV-77C has five dc-voltage ranges: 0 to 3, 12, 60, 300, and 1200 volts. Although the meter is protected against burn-out, it is good practice to make a trial measurement at a higher range setting than is considered necessary, because long-continued or repeated overload of the meter movement may eventually impair the accuracy of indication.

To measure dc voltages, proceed as outlined below:

1. Set the function selector to "+VOLTS" or to "-VOLTS", as required.
2. Connect the Ground Cable clip to ground or low side of source voltage.
CAUTION: See first paragraph of "Safety Precautions" on page 2.
3. Set the range selector to a position considerably higher than the voltage to be measured.
4. Touch or connect the DC/Direct Probe to the high side of the source voltage.
5. Reset the range selector to a position which gives a suitable pointer deflection.
6. Read the dc voltage from the scale corresponding to the range-selector setting.

Zero-Center Indication:

Zero-center indication is frequently useful because it allows observation of either positive or negative dc-voltage excursions without the necessity of resetting the function selector.

1. Set the function selector to "+VOLTS".
2. Rotate the ZERO ADJ control to position the pointer at the center "-0+".
3. Set the range selector to a position at least double the voltage to be measured.
4. After a test reading has been made, the range selector may be set to the lowest position which allows the pointer to remain on the scale.

Resistance Measurements:

When making resistance measurements, the sliding switch on the WG-299B probe should be set to "OHMS".

Before resistance measurements are made, the power should be removed from the equipment under test so that no voltages are present in the equipment.

1. Set the function selector to "OHMS" position.
2. Set the range selector to the position nearest to the value under measurement.
3. Connect the probe tip to the ground clip and adjust the ZERO ADJ control to position the pointer at the left-hand "0", if necessary.
4. Disconnect the WG-299B probe from the Ground Clip. Meter pointer will deflect approximately full scale. If meter pointer does not deflect to exactly full scale, use OHMS ADJ control to adjust setting accurately to the last line on the "R" scale. See Ohms Adjustment section on page 12 if it is necessary to frequently readjust the OHMS ADJ control.
5. Connect the clip of the Ground Cable to one terminal of the resistance to be measured.
6. Touch or connect the probe tip to the other terminal of the resistance to be measured.
7. Reset the range switch to give a convenient deflection on the "R" (ohms) scale.
8. Multiply the reading on the "R" scale by the factor indicated at the range-selector setting.

CAUTION: Low-current, low-resistance devices, such as thermocouples and meter movements, may be damaged unless a range above "R x 1" is used because the WV-77C applies up to 1.5 volts across the resistance under measurement when the range selector is set at "R x 1".

In the case of resistance measurements, the WG-299B probe of the WV-77C is always positive with respect to the Ground Cable. This facilitates the measurement of leakage resistance in components such as electrolytic capacitors where polarity must be observed.

Measurement of Resistance Values Above 1000 Megohms:

The leakage resistance of small mica and paper capacitors is usually above 1000 megohms. The circuit shown in Fig. 2 can be used to measure resistance values above 1000 megohms. An external dc voltage

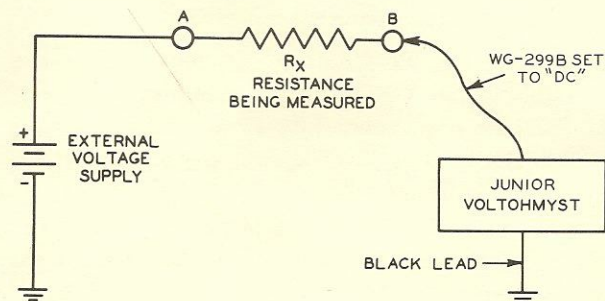

Figure 2. Circuit for measurement of resistance values above 1000 megohms.

source between 20 and 500 volts is utilized to obtain a measurable pointer deflection. Make circuit connections as shown in Fig. 2 and proceed as follows:

1. Set Selector switch to "+VOLTS" and measure the voltage at point "B".
2. Measure the voltage at point "A".
3. Compute the unknown resistance from the following formula:

$$R_x \text{ (megohms)} = \frac{11 \text{ (Volts at "A")} - \text{(Volts at "B")}}{\text{(Volts at "B")}}$$

EXAMPLE:

An unknown resistance is to be determined with the circuit of Fig. 2. An external voltage of 500 volts is applied. The WV-77C measures 2.5 volts at "B", and 500 volts at "A". Then,

$$R_x = \frac{11 (500 - 2.5)}{2.5} = 2200 \text{ megohms (approx.)}$$

AC-Voltage Measurements:

CAUTION: See Maximum Input Voltages, under "Specifications".

The switch on the WG-299B probe should be set to "AC" for all ac-voltage measurements.

1. Set the function selector at "AC VOLTS" position.
2. Set the range selector to a position considerably higher than the voltage to be measured.
3. Adjust the ZERO ADJ control if necessary to position the meter pointer at the left-hand "0". It will be necessary to readjust this control when switch-

5. Reset the range selector for a convenient deflection.
6. Read the ac voltage from the scale corresponding to the range-selector setting.

NOTE: If the 2.1-megohm dc input of the WV-77C loads the test circuit appreciably when making ac measurements in the presence of dc, a suitable blocking capacitor should be used ahead of the WG-299B probe to prevent this loading effect. For this purpose, a high-quality low leakage, paper capacitor of 0.5 μf (or larger) is suggested.

RESISTANCE MEASUREMENTS

(Set Function switch and WG-299B switch to "OHMS")

Resistance to be measured	Set Range Switch to:	Read from Scale	Multiply Reading by
0.2 to 1000Ω	Rx1	R	1
1000 to 10,000Ω	Rx100	R	100
10,000 to 100,000Ω	Rx1000	R	1000
100,000 to 100 Meg	Rx100K	R	100,000
100 to 1000 Meg	Rx1 MEG	R	1,000,000

DC-VOLTAGE MEASUREMENTS

(Set Function switch to "-VOLTS" or "+VOLTS" and set WG-299B switch to "DC")

Voltage to be measured	Set Range Switch to:	Read from Scale	Multiply Reading by
0.05 to 3V	3V	A	1
3 to 12V	12V	C	1
12 to 60V	60V	B	1
60 to 300V	300V	A	100
300 to 1200V	1200V	C	100

AC (RMS) VOLTAGE MEASUREMENTS

(Set Function switch to "AC VOLTS" and set WG-299B switch to "AC")

Voltage to be measured	Set Range Switch to:	Read from Scale	Multiply Reading by
0.1 to 3V	3V	D	1
3 to 12V	12V	C	1
12 to 60V	60V	B	1
60 to 300V	300V	A	100
300 to 1200V	1200V	C	100

NULL INDICATIONS (DC VOLTS)

(Set Function switch to "+VOLTS" and set WG-299B probe switch to "DC")

Voltage to be measured	Set Range Switch to:	Read from Scale	Multiply Reading by
-1.5 to +1.5V	3V	A	1
-6 to +6V	12V	C	1
-30 to +30V	60V	B	1
-150 to +150V	300V	A	100
-600 to +600V	1200V	C	100

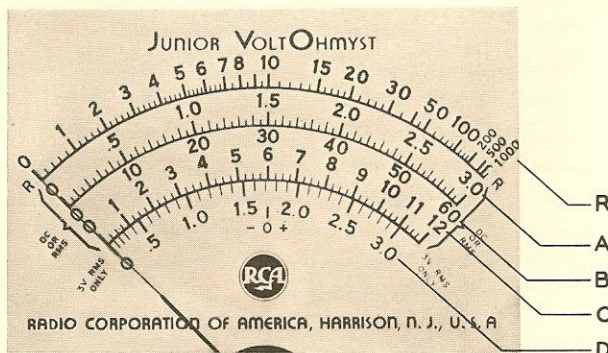

Figure 3. Details of WV-77C scales

ing from the 3-volt range to a higher range and vice versa.

4. Touch or connect the WG-299B probe to the high side of the source voltage.

ACCESSORIES

Available on Separate Order

The WG-301A Crystal-Diode Probe consists of a germanium rectifier and an RC network housed in a probe which slips onto the WG-299B Probe and Cable. The maximum voltage rating of the instrument with the WG-301A is 20 volts rms, in the presence of dc voltages up to 250 volts. The frequency range is 50 Kc to 250 Mc. Voltage readings are made on the dc scales in terms of rms volts for sine waves.

The WG-289 High-Voltage Probe in combination with a multiplier resistor WG-206 extends the dc rating of the WV-77C to a maximum of 50,000 volts for use in high-impedance circuits. DC scales are multiplied by a factor of 100, providing 4 full-scale positions of 300, 1200, 6000, and 30,000 volts. The 1200-volt range is also useful up to the maximum rating of 50,000 volts on the probe. When the probe is used, the total input resistance is increased to 1100 megohms, a valuable

feature for making measurement in phototube circuits, TV high-voltage power supplies, and other high-impedance circuits having inherently poor regulation.

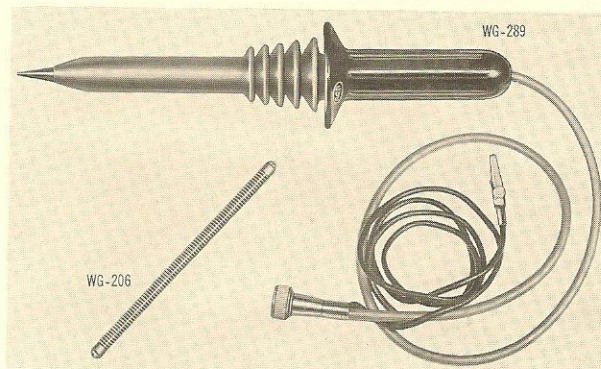

Figure 4. Accessory high-voltage probe and multiplier resistor for use with the WV-77C

Special Applications

The WV-77C is generally useful in the maintenance and servicing of ac, dc, af, and high-frequency equipment. When used with the WG-301A Crystal-Diode Probe, it can be used to measure rf voltages at frequencies between 50 Kc and 250 Mc. The special applications discussed below will serve to illustrate the wide field of usefulness of the WV-77C.

Oscillator Grid-Bias Measurement. The negative dc voltage developed at the grid of an oscillator tube is always proportional to the amplitude of oscillation. The WV-77C has high input impedance and can be used to measure this bias voltage. Comparative readings should be taken on each band of a multi-band receiver. The ganged tuning capacitor should be rotated through each band while the bias is measured.

AGC/AVC Voltage Measurements. Since the WV-77C has a high input resistance, it can be used to measure avc or agc voltage at the diode load resistor, along the bias buses, or at the grids of the tubes.

Output Indication. The WV-77C is a very useful output indicator for alignment of radio and television receivers. The WG-299B probe is usually connected to the load resistor of the second detector in AM and

TV receivers. In an FM receiver, the probe is connected to the limiter load resistor. The zero-center feature of the WV-77C is particularly useful in alignment of FM discriminators.

Bias-Cell Voltage Measurements. Bias-cell voltages can be accurately measured with the WV-77C.

Detection of Gassy Tubes. An occasional gassy tube may be encountered in electronic equipment. The presence of gas in an output tube or avc-controlled tube can lead to various circuit disturbances. Measurement of the grid bias in an RC-coupled circuit shows the presence of a gassy tube as an abnormally negative or positive value of bias. The same symptom can also be caused by a leaky coupling capacitor.

Insulation-Resistance Measurements. Current leakage through the insulating material of capacitors, coils, transformers, cables, and other components, can be measured with the WV-77C in terms of resistance. Values of leakage resistance above 1000 megohms can be measured with the circuit shown in Fig. 2.

DBM Measurements. The chart shown in Fig. 1 can be used to determine dbm values corresponding to

rms ac voltage values across a 600-ohm resistive load. A dbm value is defined as the number of decibels above or below a reference level of 1 milliwatt measured in a 600-ohm load at 1000 cycles. Accordingly, 0 dbm indicates a power level of 1 milliwatt; 10 dbm, 10 milliwatts; 20 dbm, 100 milliwatts; etc.

Because dbm are defined with respect to a 600-ohm load, power levels correspond to voltage values. Therefore, dbm can be measured in terms of rms voltages across a 600-ohm resistive load. For example, 0.775 rms volt indicates 0 dbm; 7.75 rms volts indicate 20 dbm, etc. While these measurements must be made with a sine waveform to avoid waveform error, any frequency can be used which is within the range of the WV-77C. A 1000-cps signal is used as a reference because the correlation between decibels and ear response is maximum at that frequency.

The chart shown in Fig. 1 provides rapid conversion of rms voltages to corresponding dbm values. Associated power levels can be read along the top of the chart. If the rms voltage is measured across a resistive load other than 600 ohms, the following correction factors

must be added algebraically to the dbm values read from the graph in figure 1.

Resistive Load at 1000 cps	Correction Factor*
600	0
500	+ 0.8
300	+ 3.0
250	+ 3.8
150	+ 6.0
50	+ 10.8
15	+ 16.0
8	+ 18.8
	+ 22.7

* Add algebraically to the dbm values read from graph in figure 1.

For resistive loads not listed in the above table, use the following formula for determining the correction factor:

$$\text{Correction Factor} = 10 \log \frac{600}{R}$$

where R is the load in ohms. When R is greater than 600, the correction factor is negative.

Maintenance

General

The WV-77C is manufactured and tested under strict engineering supervision. However, after long continued use the instrument may require tube replacement, or other attention.

Case opens into two sections by removing four screws: two holding the strap, one at the back, and one at the bottom of the case.

The performance of the Junior VoltOhmyst is dependent upon the quality and tolerances of its circuit components. If it becomes necessary to replace a component part, the stock number can be found in the Replacement Parts List, page 11. Only RCA replacement parts, or parts which have equivalent specifications, should be used.

Zero Setting of Pointer

Mechanical Adjustment

The pointer should rest at "0" when the power is off. If the pointer should come to rest at a deflected position when the Selector switch is turned to "OFF", adjust the pointer position mechanically, as follows:

1. Unscrew the meter-adjustment screw plug.
2. Insert a scriber or similar tool to engage the zero-adjustment lever, and move the lever laterally as required to bring the pointer to "0"

Caution: Extreme care must be taken to prevent insertion of the tool to a depth which will injure the pointer spring. The meter warranty does not cover such damage.

3. Replace the meter-adjustment screw plug.

If the difficulty remains, vigorously wipe the outside surface of the meter-case window with a clean, soft, dry cloth. If the

pointer moves away from its initial position and remains at another off-zero position for several minutes, the anti-static coating on the inside surface of the window is no longer effective. Requests for anti-static solution should be addressed to Radio Corporation of America, Order Service, Building 60, Camden, New Jersey. A 1-ounce bottle with instructions for use will be sent free to VoltOhmyst Meters users whose warranties are on file at the Camden RCA office.

Caution: The inside surface of the front half of the plastic meter case is coated with an anti-static solution to eliminate static effects on the action of the pointer. If maintenance necessitates removal of this case part, take care to avoid rubbing or scratching the inside surface.

Electrical Balance Check

1. Set the function selector to "+VOLTS".
2. By rotating the ZERO ADJ control, it should be possible to set the meter pointer at either zero or 65% of full deflection on any range.
3. Set the function selector to "-VOLTS".
4. By rotating the ZERO ADJ control, it should be possible to set the meter pointer at either zero or 15% of full-scale deflection on any range.

(Continued on page 12)

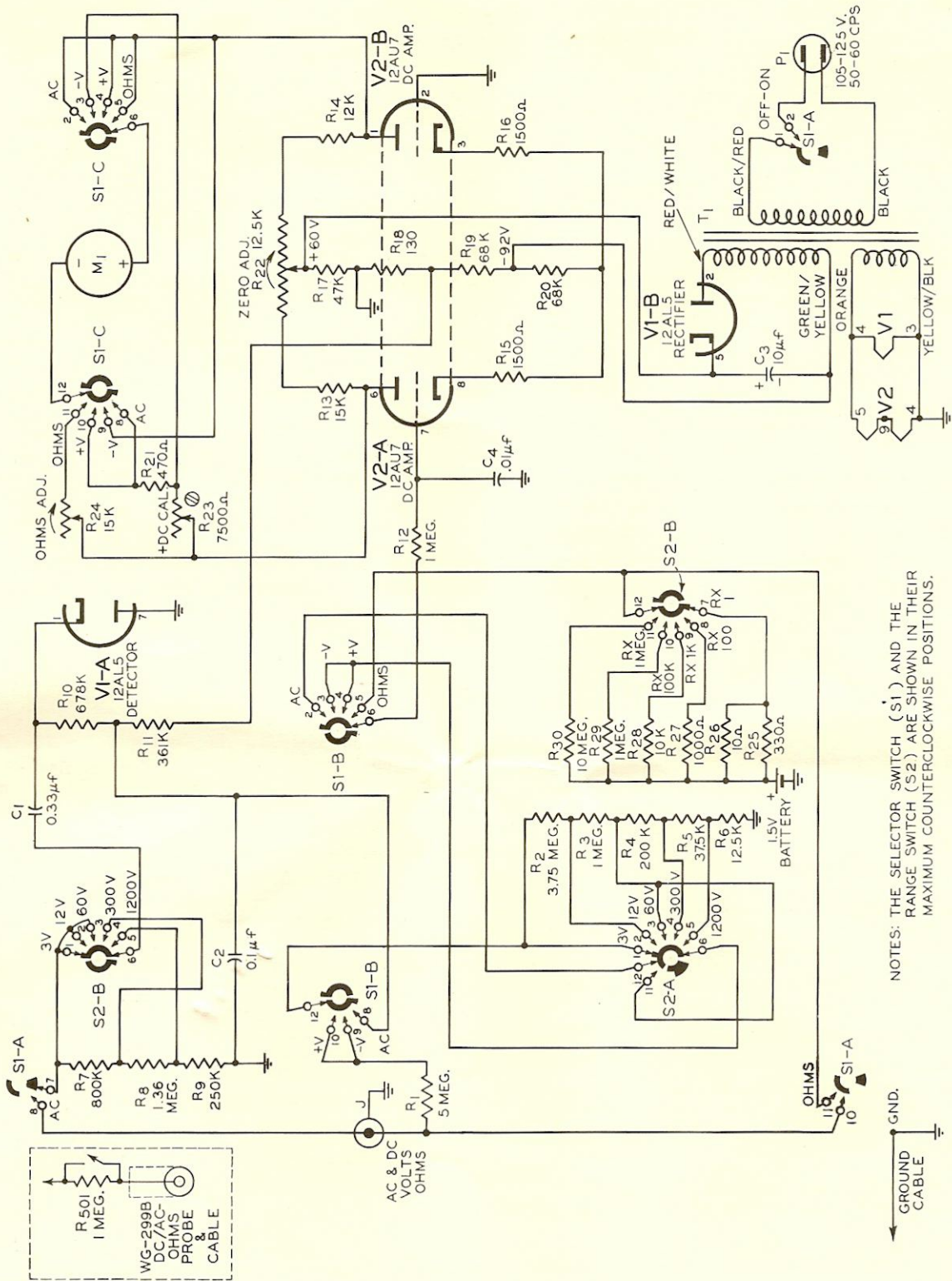

NOTES: THE SELECTOR SWITCH (S1) AND THE RANGE SWITCH (S2) ARE SHOWN IN THEIR MAXIMUM COUNTERCLOCKWISE POSITIONS.

ALL RESISTANCE VALUES ARE IN OHMS UNLESS OTHERWISE NOTED.

MEG.=MEGOHMS, μ . =OHMS, K=10.00

T-627080-2D

Figure 5. Schematic diagram of WV-77C

Replacement Parts List

JUNIOR VOLTOHMYST

Type WV-77C

When ordering replacement parts, include serial number and code number of instrument.
Parts should be ordered through a local RCA tube and parts distributor.

Symbol No.	Description	Stock No.	Symbol No.	Description	Stock No.
Capacitors					
C 1	Paper tubular, 0.33 μ f, \pm 10%, 400 volts.....	93848	R 23	Variable carbon, 7500 ohms, \pm 20%, $\frac{1}{2}$ watt.....	93839
C 2	Paper tubular, 0.1 μ f, \pm 20%, 200 volts.....	73784	R 24	Variable carbon, 15,000 ohms, \pm 20%, $\frac{1}{4}$ watt.....	213743
C 3	Dry electrolytic, 10 μ f, - 10%, + 100%, 250 volts.....	93849	R 25	Fixed composition, 330 ohms, \pm 5%, $\frac{1}{2}$ watt.....	502133
C 4	Paper tubular, 0.01 μ f, \pm 20%, 400 volts.....	73561	R 26	Fixed composition, 10 ohms, \pm 5%, 2 watts.....	522010
Resistors					
R 1	Carbon film type, 5 meg., \pm 1%, $\frac{1}{2}$ watt.....	55881	R 27	Fixed composition, 1000 ohms, \pm 5%, 1 watt.....	512210
R 2	Carbon film type, 3.75 meg., \pm 1%, $\frac{1}{2}$ watt.....	93840	R 28	Fixed composition, 10,000 ohms, \pm 5%, $\frac{1}{2}$ watt.....	502310
R 3	Carbon film type, 1 meg., \pm 1%, $\frac{1}{2}$ watt.....	55658	R 29	Same as R 12	
R 4	Carbon film type, 0.2 meg., \pm 1%, $\frac{1}{2}$ watt.....	56733	R 30	Fixed composition, 10 meg., \pm 5%, $\frac{1}{2}$ watt.....	502610
R 5	Carbon film type, 37,500 ohms, \pm 1%, $\frac{1}{2}$ watt.....	93841	Miscellaneous		
R 6	Carbon film type, 12,500 ohms, \pm 1%, $\frac{1}{2}$ watt.....	93842	J	Connector, cable, chassis receptacle.....	96257
R 7	Carbon film type, 0.8 meg., \pm 1%, $\frac{1}{2}$ watt.....	93843	M 1	Meter, dc, 0-200 μ amp. (blue).....	213484
R 8	Carbon film type, 1.36 meg., \pm 1%, $\frac{1}{2}$ watt.....	96259	P 1	Cord, power, with plug.....	70392
R 9	Carbon film type, 250,000 ohms, \pm 1%, $\frac{1}{2}$ watt.....	56728	S 1	Switch, "Selector", 2 section, 5 position, 6 circuit.....	213514
R 10	Carbon film type, 678,000 ohms, \pm 1%, $\frac{1}{2}$ watt.....	93845	S 2	Switch, "Range", 2 section, 5 position, 4 circuit.....	213513
R 11	Carbon film type, 361,000 ohms, \pm 1%, $\frac{1}{2}$ watt.....	96258	T 1	Transformer, power; primary, 117 volts, 50/60 cps.....	93835
R 12	Fixed composition, 1 meg., \pm 5%, $\frac{1}{2}$ watt.....	502510		Case, meter (plastic) blue.....	213485
R 13	Fixed composition, 15,000 ohms, \pm 5%, $\frac{1}{2}$ watt.....	502315		Clip, alligator: for ground cable.....	35262
R 14	Fixed composition, 12,000 ohms, \pm 5%, $\frac{1}{2}$ watt.....	502312		Clip, alligator: "slip-on" type.....	210088
R 15, 16	Fixed composition, 1500 ohms, \pm 5%, $\frac{1}{2}$ watt.....	502215		Handle, carrying.....	44091
R 17	Fixed composition, 47,000 ohms, \pm 5%, $\frac{1}{2}$ watt.....	502347		Insulator: for alligator clip.....	204717
R 18	Fixed composition, 130 ohms, \pm 5%, $\frac{1}{2}$ watt.....	33571		Knob, control.....	59543
R 19, 20	Fixed composition, 68,000 ohms, \pm 5%, $\frac{1}{2}$ watt.....	502368		Socket, tube, 7 pin.....	204825
R 21	Fixed composition, 470 ohms, \pm 5%, $\frac{1}{2}$ watt.....	502147		Socket, tube, 9 pin.....	204900
R 22	Variable carbon, 12,500 ohms, \pm 20%, $\frac{1}{4}$ watt.....	213744		Stud, carrying-handle.....	93854
WG-299B DC/AC-Ohms Probe and Cable					
				Bushing, tip: for front housing.....	212161
				Connector: internal, brass for cable.....	210190-A
				Connector, cable: female, with set screw.....	203574
				Shell: front end, blue.....	210195
				Shell: middle section, with shield, bushing, and insulator.....	212159
				Shell: rear section, blue.....	210202-A
				Spring, coil: for front end.....	210197
				Spring, switch: with insulator.....	212162
				Tip, probe: with switch slide and 1-meg. resistor.....	212160
				Washer, tip.....	212163

5. If steps 2 and 4 above cannot be accomplished, the two triode units of the 12AU7 tubes are not in close enough balance for this application and the tube should be replaced.

DC Zero Check

1. Set function selector to "—VOLTS".
2. Set range selector on "3V".
3. Rotate the ZERO ADJ control until the meter pointer is at zero.
4. Turn range switch to "1200V".
5. If the meter pointer deviates from zero by more than one division on the 0 to 12 meter scale, replace the 12AU7 (see section on Tube Replacement).

AC Zero Check

1. Set the range selector on "3V" and the function selector on "+VOLTS".
2. Rotate ZERO ADJ control until meter reads 10 volts on the 60V meter scale.
3. Turn the function selector to "AC VOLTS".
4. If the meter does not read between 7 and 13 volts, replace the 12AL5. The use of a 12AL5 which results in a meter reading outside of this 7-13 volt range will not impair the accuracy of the instrument but will, however, require more frequent adjustment of the ZERO ADJ control.

Calibration

1. Set the range selector to "60V" and the function selector to "+VOLTS".
2. Set the meter pointer to zero by using the ZERO ADJ control.
3. Set the sliding switch on the probe to "DC".
4. Connect the Ground Cable to the negative terminal and the probe tip to the positive terminal of a source of DC Voltage that has been adjusted to exactly 57 volts.
Note: The accuracy of calibration cannot exceed the accuracy of the voltage standards which are used.
5. Adjust the "DC CAL" control (R-23) inside the case for a meter reading of exactly 57 volts.
6. Remove the leads at the source of voltage.
7. Set the function selector to "—VOLTS".
8. Connect the Ground Cable to the positive terminal and the probe tip to the negative terminal of the dc-voltage source adjusted to exactly 57 volts. The WV-77C should read 57 volts within $\pm 3\%$.
9. If the WV-77C cannot be calibrated according to the foregoing steps the 12AU7 amplifier tube may not be properly balanced for this application.

Tube Replacement

All tubes supplied originally with the WV-77C have been thoroughly aged by operating them for several hours before installation in the instrument. This preliminary conditioning of a new tube helps to insure stability and dependable performance.

Before installing a 12AU7, the tube may be aged as follows: connect the plates together and apply 115 volts dc. Operate the grids and cathodes with no voltage applied, and operate the heaters at 6.3 volts. The tube should be operated in this manner for a minimum of 12 hours before it is installed in the instrument. The WV-77C then can be recalibrated.

An alternate, and usually satisfactory, aging procedure consists of operating the new tube in the WV-77C for approximately 36 hours, after which time the instrument may be recalibrated. If this procedure is unsatisfactory, the first aging procedure should be followed.

If it becomes necessary to replace the 12AL5, the tube can be aged for a minimum period of 36 hours by operating it in the WV-77C. After this period of time, the instrument may be recalibrated according to the procedure outlined under "AC Calibration Check".

Battery Testing and Replacement

Caution: Do not allow exhausted cells to remain inside the case of the WV-77C. Chemicals from deteriorated cells may damage the instrument.

The battery should be tested to insure accuracy of resistance measurements. To test battery, proceed as follows:

1. Set Function selector to "OHMS".
2. Set Range selector to "R x 1" scale.
3. Rotate OHMS ADJ control to bring pointer to full scale.
4. Short-circuit the probe tip and ground clip for about ten seconds.
5. Open the short-circuit and immediately observe the scale indication. An appreciable deviation from full-scale indication reveals weak cells which should be replaced.

Ohms Adjustment

In order to obtain exactly full-scale deflection of the meter when switching the range selector from a low range position to the R x 1MEG position, it may be necessary to readjust the OHMS ADJ control. The necessity for this readjustment can be minimized by checking the battery and installing a 12AU7 tube with a low value of grid current. Refer to Tube Replacement section.

RCA Repair Service

RCA maintains a complete repair service for the adjustment, calibration, and maintenance of RCA test equipment. If it becomes necessary to service this equipment, the report forms enclosed in this booklet should be filled out as described. It is important that:

1. Test equipment be packed carefully.
2. A full description of the trouble be included in the report.
3. All probes and cables be included with the instrument.

Attention to these details will help prevent damage in transit and delay in repairs.

