

Brakes

[FAQ Home](#)

[Volvo Maintenance FAQ for 7xx/9xx/90 Cars](#)

Component Identification:

[Brake Caliper Identification](#)

[Brake Pad Identification](#)

[Brake Rotor Identification](#)

Fluid and Pad Maintenance:

[Pad Wear Indicators?](#)

[Brake System Fluid Selection](#)

[Brake Fluid Flushing Procedures](#)

[Brake Bleeding](#)

[Brake Pressure Bleeder](#)

Pad Replacement:

[Brake Pads](#)

[Brake Pad Replacement](#)

[Brake Squeal](#)

[Brake Pad Anti-Squeal: Pastes and Shims](#)

Rotors:

[Brake Rotor Replacement](#)

[Brake Rotors Rusted On](#)

[Brake Rotor Installation Techniques to Minimize Pulsation](#)

[Rotor Turning and Torque](#)

Front Calipers:

[Caliper Guide Pins: Maintenance](#)

[Caliper Guide Pin Troubleshooting](#)

[Sticky Caliper: Internal Corrosion](#)

[Rebuilding Calipers](#)

Rear Brakes:

[Rear Ate Caliper Pins](#)

[Rear Brake Disk Removal](#)

[Rear Brake Piston Rotation](#)

[Dust Boots and Piston Cleaning](#)

[Parking Brake](#)

Master Cylinder:

[Don't Ruin Your MC While Bleeding](#)

[Replacement and Bleeding](#)

Brake Hoses:

[Brake Hose and Line Replacement](#)

[Brake Hose Deterioration and Brake Binding](#)

Troubleshooting:

[Low Pedal and Soft Brakes Problems](#)

[Hard Pedal Problems and Brake Booster Diagnosis](#)

[Brakes Pull When Applied: Control Arm Bushings](#)

[Brake Calipers Rattle on Mounting Bolts](#)

[Pulsating Brakes: Runout in Hub and Rotor](#)

[Intermittent Brake Failure: Bad Sensor Seal](#)

[Wheel Shudder: Diagnosis](#)

[Brake Shuddering and Suspension Bushings](#)

[Wheel Lockup](#)

[Brake Light "On" After Bleeding](#)

[Front Brake Squealing on 92-95 940/960](#)

[Brake Reservoir Seal Failure](#)

Upgrading:

[Stainless Steel Braided Lines](#)

[Upgrading Older 7XX Brakes to Later 9XX Jumbo Brakes](#)

[Brake Torques Table](#)

Component Identification:

Brake Caliper Identification.

Front Calipers:

[Editor:] Volvo 700 cars use a variety of calipers, rotors, and pads on the front hubs. Prior to working on the brakes, carefully identify which components you have so that you can acquire the correct parts.

[Inquiry:] Does anyone know if there is a way to tell which of the two caliper types (ATE or Girling) my 740 GLE is using without removing the wheels?

[Response: Paul Grimshaw] Refer to the product plate (located above passenger front headlight or in the trunk or door jamb). Go to position "E" (end of the second line on the right). The following codes apply:

- 2: Girling Front, ATE Rea
- 3: DBA/Bendix Front, ATE Rear
- 4: Girling Front and rear
- 5: DBA/Bendix Front, Girling Rear

ATE calipers are ONLY used on rear wheels. Note that DBA is the same as Bendix. The best way to identify front calipers is to look thru the wheel for a large iron bridge that reinforces the caliper body (with a slot on either side i.e. two slots):



Bendix caliper is in the left photo, Girling in the right. [Photos courtesy of [IPD](#), a retailer of Volvo brake components]

[Tip by Guid] Take special note, if you determine that you have Bendix calipers on your pre-1987 700, whether the two-piece hub/rotor conversion was performed on your car. When I bought my '86 (used), it had been converted. If so, you'll have to order pads for an '88+ to fit.

The quick way to tell the difference: if you have the one-piece (original '86) design, your pads will have flat tabs at the top ([REPCO 536](#) picture below). If you have the converted ('88+) design, the pads will have the added spring pins ([REPCO 1169](#) picture below).

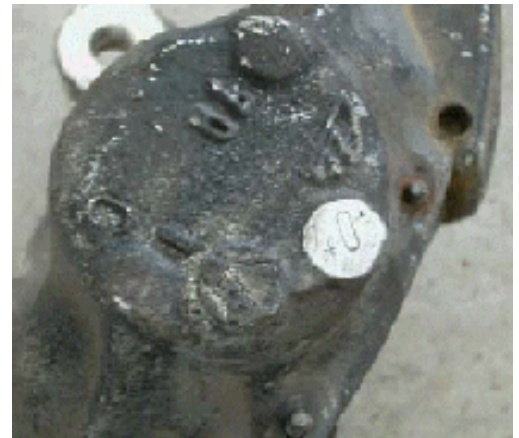

Rear Calipers:

[Another Inquiry] I'm close to needing rear brake pads on my wife's 90 740. Peeking through the rim, I see the capital letter "A" in sort of an Italic script, followed by a couple more smaller characters that I can't make out, cast onto the caliper. Can anyone tell me what kind of brakes they are, given such weak info? Now the bonus point question....what would the Volvo P/N's be for the pads? (Not that I would necessarily use Volvo pads. [Response: Ted D'Orazio] Your rear calipers are ATE. The p/n for the rear pad set is 271824. [Editor] Note that the rear calipers came with three piston sizes: 36mm, 38mm and 40mm, stamped on the caliper- see the photo. Replace with the identical size. Often the markings are obliterated due to rust or mechanical damage. You can measure the diameter of the piston when the pads are removed or measure the imprint on the back of the steel shim plate. Wagons generally use 40mm pistons.

Brake Pad Identification.

[Inquiry:] When I went to get a set of front disc brake pads for my 740t there were two types listed. Does anyone know which type I would need or how to tell Bendix from Girling?

[Response: JohnB] The Bendix pads have two tabs on the outer edge of the backing plate, some versions quite large, about 3/8 in by 3/16 in with a round cylinder welded/brazed on each tab, others with two vestigial nubs....both types come with slightly different anti-vibration springs so don't mix them. The Girling pads have a single big tab with a post on it and the anti-vibration spring wound around the post. Rotor size matters....the 11.25 in rotor works on Girling and Bendix brakes with separate rotor/hub. Make sure you know what hub/rotor you have. Finally, your minimum permissible pad thickness, when you are checking pads, is 3 millimeters per Volvo specs for the front pads and 2 millimeters for the rear.

Here is a visual guide to brake pads used in various caliper configurations in 700/900 cars, courtesy of [RPR](#) where each pad set can be ordered on-line.

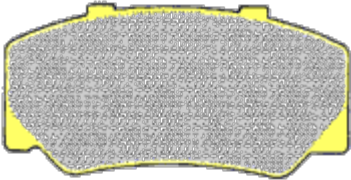
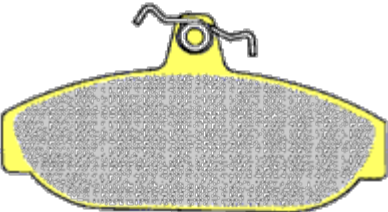
Front Pads:		
REPCO 536		700 w/ Bendix -87 original front. Volvo supercedes 83-87 Bendix pads to 88- Bendix pads. Order REPCO 1169 further down the page and update kit 3516813
REPCO 508		700 w/ Girling w/o ABS front 900 w/o ABS All front

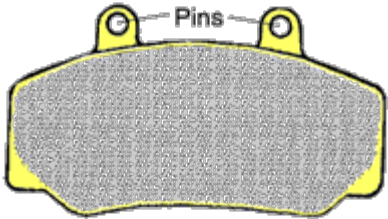
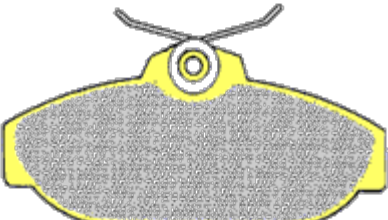
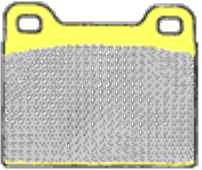
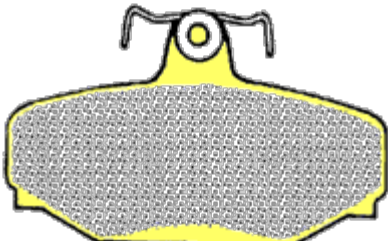
REPCO 1169		700 w/ Bendix (update) -87 front 700 w/Bendix 88- on front
REPCO 1198		740 w/ Girling ABS 91-92 front 900 w/Girling ABS 91-on front
RearPads:		
REPCO 102		700/900 w/ Ate rear
REPCO 3067		760 Girling w/ IRS rear 900 Girling w/ IRS rear

Brake Rotor Identification.

[Editor's Notes:] Volvo 700/900 series brakes came in a number of configurations: one-piece hub and rotor versus separate rotor and hub; solid versus ventilated rotors; various calipers for ABS and non-ABS; various rotor diameters and thicknesses. In addition, early 700 series may have been converted to two-piece hub and rotor configurations or to later "jumbo" rotors. Be very careful when replacing the rotors. The only sure test is to **measure** the diameter and thickness or look for a stamping showing the diameter on the hub and order the corresponding replacement from a knowledgeable parts department. The data in the two tables below are courtesy of VolvoCars and [RPR](#) a retailer of Volvo aftermarket parts. Note that they do not mention 10.25 inch diameter rotors which were fitted to a number of Girling-equipped cars. See the type chart for guidance on matching the rotor to the caliper (one or two pistons)

Brake Rotor Types:					
Rotor	Type	Diameter mm	Diameter in	Thickness	Caliper
Version	Solid	280.0	11.00	14.00	2-

1					piston
Version 2	Ventilated	262.4	10.50	22.00	2-piston
Version 3	Ventilated	287.0	11.25	22.00	2-piston
Version 4	Ventilated	280.0	11.00	26.00	1-piston

In the following chart, the "Absolute Minimum" thickness is the thickness at which replacement is mandatory. The "Minimum" thickness is used when you replace pads: if the measured rotor thickness at the points of pad contact is less than this number, replace the rotor. Conversion: 262.4mm= 10.5 inches; 280mm= 11 inches; 287mm= 11.25 inches. One inch =25.4mm.

Brake Rotor Identification Chart:		Rotor	Rotor Thickness				
Car Model	Year	Brake Type	Rotor Type	Diameter	New	Minimum	Abs. Min
Front Rotors:							
700	83-84	Bendix	Single rotor and hub	287.0	22	20.8	20.0
				262.4	22	20.8	20.0
700	83-84	Bendix	Separate rotor/hub	262.4	22	20.8	20.0
				262.4	22	20.8	20.0
700	83-84	Girling	Single rotor and hub	280.0	14	12.3	11.5
				262.4	22	20.8	20.0
700	83-84	Girling	Separate rotor/hub	262.4	22	20.8	20.0
700	to 87	ABS Bendix	Single	287.0	22	20.8	20.0
		(updated)	Separate	287.0	22	20.8	20.0
700	85-87	Bendix w/o ABS	Single	262.4	22	20.8	20.0
			Separate	262.4	22	20.8	20.0

700	85-87	Girling w/o ABS	Single	262.4	22	20.8	20.0
			Separate	262.4	22	20.8	20.0
740	88-90	Bendix w/o ABS	Separate	262.4	22	20.8	20.0
740	88-90	ABS Bendix	Separate	262.4	22	20.8	20.0
				287.0	22	20.8	20.0
740	88-90	Girling w/o ABS	Separate	262.4	22	20.8	20.0
740	88-90	ABS Girling	Separate	287.0	22	20.8	20.0
740	91-92	Bendix w/o ABS	Separate	287.0	22	20.8	20.0
740	91-92	Girling w/o ABS	Separate	287.0	22	20.8	20.0
740	91-92	ABS Girling	Separate	287.0	22	20.8	20.0
760	88-90	ABS Bendix	Separate	287.0	22	20.8	20.0
760	88-90	ABS Girling	Separate	287.0	22	20.8	20.0
900	91	Girling w/o ABS	Separate	287.0	22	20.8	20.0
	92 on	Girling w/o ABS	Separate	287.0	26	23.8	23.0
900	91 on	ABS Girling	Separate	287.0	26	23.8	23.0
Rear Rotors:							

All	All	Live Axle	Separate rotor/hub	281	9.6	8.9	8.4
All	All	Multilink IRS	Separate rotor/hub	265	10	8.5	8

Fluid and Pad Maintenance:

Pad Wear Indicators?

[Inquiry] Are there pad wear indicators to tell me when my brake pads are wearing out?
 [Editor] No! You have to inspect pad wear through the caliper slots to make sure you have adequate pad thickness. Unlike other cars, there is no noisemaker to let you know when you need new pads. And if they wear out? You may score the rotor, which will then need to be replaced.

Brake System Fluid.

Why Flush Brake Fluid Every Two Years?: Remember that brake fluid absorbs water vapor from the air. This water contributes greatly to poor stopping performance and to the decline of your hydraulic cylinders and brake components. In addition, high brake temperatures accelerate the rate at which the corrosion inhibitors in brake fluid break down. As the fluid ages, oxidation eats away at metal surfaces creating dissolved acids and sludge that are carried with the fluid as it surges back and forth with every application of the brakes. The contaminants are abrasive and increase seal, piston and bore wear in the calipers, wheel cylinders and master cylinder. They can also attack and damage ABS solenoid valves and cause these valves to jam and stick. For these reasons, Volvo recommends that you flush hydraulic systems every two years. This is most important for your brakes' hydraulic system. [Editor's Note: See [Brake Fluid Flushing Procedures](#) below for complete instructions. See <http://www.phxsyss.com/> for information on "StripDip" brake fluid test strips.]

Which Fluid Should I Use?

[Inquiry:] My friendly Volvo parts person says that my Volvo needs DOT 4+ brake fluid. Of course dealers use Volvo-labeled fluid. Is this equivalent to Castrol GTLMA which "Exceeds DOT 3 and DOT 4 specifications"?

[Response: Bob] The Castrol fluid is fine as long as it meets DOT 4. Use a pressure bleeder for most effective flushing. [Editor: See [Brake Fluid Comparison](#) for more information.]

Silicone DOT 5 Fluid Acceptable? Absolutely NOT: under no circumstances add or use in any way DOT 5 silicone-based fluids, which are completely incompatible with the materials used in Volvo brake systems. However, the new DOT 5.1 glycol fluids are fully compatible with your system.

Brake Fluid Flushing Procedures. [Digested from the Volvo Manual] Flush the fluid in your braking system at least once every two years to remove water and contaminants. The manual notes that you should de-pressurize the pressure flusher after doing each wheel, then operate the brake pedal several times, before going to the next wheel.

Master Cylinder Reservoir:

- Place plenty of paper under the master cylinder.
- Separate reservoir from master cylinder by gently pressing sideways and pulling out.
- Fill reservoir with fresh fluid.
- Connect power bleeding unit to reservoir (E-ezibleed or Power Bleeder, above.)
- Jack up car and remove wheels.

Rear Wheels:

Remove or press back pads on one rear wheel. [Editor's Note: Clamp off brake rubber line and open bleed screw on ABS-equipped cars so you don't force contaminated fluid back to the ABS unit. See [Brake Job Tips: Hose Clamp](#).]

- [Cars with multilink axles: Connect tube to lower bleed screw on caliper]
- Open bleed screw and drain off fluid until it runs clear. Tighten.
- [Cars with multilink axles: Close off bottom screw and bleed top screw to remove trapped air.]
- Repeat on the other rear wheel.
- Reassemble.

Front Wheels:

[Cars with Girling Single-Piston Calipers:]

- Connect tube to bleed screw, open one turn and press piston to bottom of caliper by pressing outer pad. [ABS-equipped cars: See [Brake Job Tips: Hose Clamp](#)]
- Open bleed screw and drain off fluid until it runs clear. Tighten
- Repeat on other front wheel.

[Cars with Bendix and Girling Two-Piston Calipers:]

- Connect tube to lower bleed screw. Open both screws about one turn. Place paper around upper screw.
- Press pistons to bottom of caliper. [ABS-equipped cars: See [Brake Job Tips: Hose Clamp](#)] Close upper screw.
- Open bottom screw and drain off fluid until it runs clear. Tighten. Connect tube to upper screw and repeat to remove any trapped air.

After doing all four wheels, operate the brake pedal several times. Pedal travel after 3-4 depressions (as if braking very hard), with the ignition off, should not exceed 55 mm for older cars and 50 mm for 1995 and up 900 series (all 960 and mid-year+ 940: see Service Bulletin 5-51-908 Jun 95)

Need to Flush Before Replacing Components.

[From RPR:] When changing components that use brake or clutch fluid, be sure to use the proper fluid (usually DOT 4 brake fluid for Volvos). It is also necessary to flush the lines

before installing slave cylinders, calipers etc. Many people simply pull the old unit off and then "slap" the replacement unit on which causes any old fluid or contaminants to damage the replacement when the lines are bled. Our experience with clutch slave cylinders went from a return rate of approximately 50% to less than 5% by simply advising installers to follow these simple instructions.

Brake Bleeding.

Basic Brake Bleeding Procedure.

[Tip from Abe Crombie] All you need is a turkey baster, a piece of 1/4" I. D. clear vinyl tubing and a coke bottle. Have 2-3 pints of the proper brake fluid on hand. If you are changing a part and air is already in system, then the order is important. If you are doing a flush/bleed then the order is not important. Use a turkey baster to suck out most of the old fluid from the master cylinder reservoir. Refill with fresh fluid. Leave the engine off. Go to whichever caliper is first in the bleed sequence and loosen the bleeder 1/8 turn. Attach the clear tubing and place end in coke bottle. Add just enough clean brake fluid to coke bottle so that tube is below the fluid level. Get in car and pump pedal slowly about 1-1/2 inches 10 times. Don't exceed this extension or you will press the master cylinder seals into corroded areas within the master cylinder and ruin them. Get out and check/top up fluid. See if the fluid in tube is clear, if so close bleeder and remove tube. If not, pump five more times. Go to next caliper and repeat until all have been done. The bleeder screw opening should be just enough to allow fluid to pass out. This can be determined by feeling resistance as you push pedal. If the pedal goes to floor w/o resistance then you should turn in bleeder screw 1/16 turn. The idea is to do have resistance to the master cylinder suction pulling fluid back in through tube. This way the fluid will be pulled from reservoir on upstroke of pedal and you will not need to do the pump x times, hold, open screw, close screw, pump x times thing. I have done this for 25 years and never had a problem and never had arguments with girlfriends, co-workers, family members as I didn't need their assistance. IF you have a buch of air in system then you will have to do the pump-open-close pump routine. For ABS-equipped cars, see the notes on [Brake Fluid Bleeding/Flushing Procedures for Cars with ABS](#). If you have lots of air in the lines and master cylinder, tap them as you bleed to loosen adhered air bubbles.

Brake Bleeding Sequences. [Editor's Note: These sequences apply to all cars per the Volvo manual]

Bleed the brake lines in this order:

- Cars without ABS and 1988 or later models with ABS:
 - LR, RR, RF, LF.
- Cars with ABS up to and including 1987:
 - use the reverse sequence: LF, RF, LR, RR.
- On Volvo models with 2 bleeder screws (upper and lower) on the front calipers: bleed the upper nipple
- On Volvo models with 3 bleeder screws on the front calipers: LR, LF top, RR, RF top, LF two bottom bleeders, RF two bottom bleeders (per Bentley)
- Highly recommended: use a pressure bleeder as noted below at [Brake Pressure Bleeder](#)

[Editor's Note: when bleeding, use the uppermost nipple to expel any air. When flushing fluid, use the lower nipple, then close and check the upper nipple for any trapped air. See

[Brake Fluid Flushing Procedures](#)]

ABS-Equipped Cars: See [Brake Fluid Bleeding/Flushing Procedures for Cars with ABS](#)

Rusted Bleed Screws: Tips for Removal.

[Tip from iadr/Cliff Pope] Here is a tip that's saved me a couple times when removing screws that the P.O. has not thought to lubricate- take a small ball peen hammer and give the bleeder screws the hardest hit you can without mushrooming the tip where the fluid comes out. To clarify, pretend you are driving them into the hole they are threaded into: don't hit them sideways. This seems to loosen the rust on the threads. Once you get it moving even a fraction, you have done it. Move it cautiously back and fro, until it will screw freely. Needless to say, try using PBlaster penetrant and a good six-point socket before going to extremes. Just be aware that too much torque can break off the hollow screw. If you snap it off you are in real trouble. I have never succeeded in extracting a broken one, so you will need a new caliper.]

[More Tips from Motor Magazine] Penetrating oil has a better chance of being effective in loosening a seized bleeder if you wire-brush rust/scale away from the caliper's bleeder bore before applying it. Be sparing, though. You don't want petroleum-based penetrants contaminating brake fluid. Also, filling the bore in the bleeder itself with a snug-fitting drill bit helps reinforce the bleeder against twisting forces as you try to unscrew it. We don't recommend heating the caliper casting with your torch to loosen seized bleeders; the heat may not just boil away brake fluid, it may damage seals or boots. Keeping the bleeder capped definitely helps prevent seizing; vacuum caps often make acceptable substitutes if actual bleeder caps are unavailable.

Master Cylinder Bleeding. If you need to bench bleed a rebuilt master cylinder, see Rob Bareiss' simple [bench bleeder tool](#) made from lengths of brake line.

Brake Pressure Bleeder.

A pressure bleeder works by pushing fluid into the reservoir at pressure to force the old fluid out the caliper nipples rather than suck it out from the nipples. Brake systems are pressure systems and are better able to deal with even this small pressure than a vacuum system which will always suck a little bit of air in at the nipple. These pressure bleeders are inexpensive and make brake system fluid maintenance very easy. Volvo recommends the use of a pressure bleeder at about 30 psi.

1. Motive Products Power-Bleeder Brake Pressure Bleeder:

[Tip from Steve Seekins] I recently received, tested, and reviewed a new product - Power Bleeder from Motive Products: <http://www.motiveproducts.com/>, [IPD](#) or other online retailers . The price is about the same, however it comes with a specific ATE reservoir cap adapted with a fitting and hose, has a large bottle which holds 2 full quarts/liters of fluid sufficient for a complete flush, and has built in pump and pressure gage. [Editor's Note: this is a great product for \$49.95. They are located in Berkeley, CA.] This can be pumped to 30 psi. Most of the time, 20 psi is all you need to bleed effectively.



2. Gunson Eezi-bleed Brake Pressure Bleeder:

[Comment:] For those outside North American, one can buy a Gunson's EEzi-bleed. Eezibleed works great - I have found that 25 psi works fine vice the recommended 20 psi. If you use pressures recommended (~20psi), you will not be in any danger of blowing off the fluid reservoir. I routinely use 25psi with a pressure reducer and have never had a problem. Just don't try to use a spare tire pumped up to 45psi or to a 150psi air hose! In this case, it will surely come apart somewhere! Only drawbacks: under heavy - i.e., daily use, the gaskets on the reservoir bottle got funky and required replacement, as did the gasket on the master cylinder reservoir adapter cap. After lots of use, the adapter cap failed and began leaking - threads would not hold. The cap itself seemed to either wear or stretch such that the threads would not hold tight and would slip. The result is that there was a very fine line between tightening the cap and having the cap pop up one thread resulting in lots of fluid (like a whole container) being blown out around the cap threads. My solution was to purchase a machined aluminum adapter cap from a local automotive tool supply house for about \$30 and use it in place of the supplied adapter cap. For complete system flushes, I find that the supplied reservoir bottle may be too small. This may be appropriate for the owner with 1-4 Volvos that get flushed every 1-2 years and the occasional new master cylinder or caliper. The Volvos cannot be gravity bled, and even with the pressure bleeder, you may need to use the pedal occasionally when bleeding the rear brakes on those cars with rear brake pressure limiting valves (non-ABS systems).



3. MityVac Vacuum Bleeder:

[Editor] The MityVac vacuum (not pressure) bleeder works, but you have to use care to ensure that air bubbles are not sucked in around the bleed screw nipple. [Tip from Mike] I've used a MityVac a couple of times to bleed my brakes. It's very time consuming (about 2 hr.) and a bit messy if you are not careful. Also, your hand will get a workout squeezing the damn thing. Be sure you have the proper sized nipple to fit over your bleeder screws or it will take you more time. And don't let your brake reservoir get below 3/4 full during the bleeding process. If you start to suck air, you of course have to start over and you may have to bleed the reservoir as well. [Tip from Dan] Use the hose on the bleed screws to avoid air bubbles. [Editor] My Mityvac is just not effective in bleeding: use a pressure bleeder instead.

4. Home-Made Pressure Bleeders.

[TV Pierce] You can make your own pressure bleeder. [Power Motive's](#) is nothing more than a garden sprayer with a brake reservoir cap attached to the end of the tube instead of a spray nozzle (they also add a pressure gauge -- but it's not really necessary). The sprayer is about \$10 at Home Depot, and a new reservoir cap should be \$2-\$3 at FCP Groton. Drill a hole through the cap, epoxy a tube fitting through the hole, then cut off the spray nozzle, and attach the reservoir cap. [Gary Gilliam] I made mine out of a cheap all plastic 4 liter (about \$13) garden sprayer, and an old master cap. I cut the hose just above the sprayer wand, attached a 5/16" brass fitting that is commonly used for repairing air lines: it is barbed on one end to stick inside the hose and has 1/4" NPT threads on the other. This was secured to the hose with a stainless hose clamp and a 1/2" hole was drilled in the extra master cylinder cap to receive the other end of the fitting. The fitting was secured to the cap with a 1/2" long brass NPT straight connector, adding a rubber washer on both sides coated in RTV for good measure.

I was going to add a pressure gauge, but never got around to it. It seems to work fine with just enough pumps to get things moving a bit.

Pad Replacement:

Brake Pads

Pad Selection.

What I've found over years and years of experimentation with different types of brakes ranging from soft OEM pads to full-on race pads is that there is NO SUCH THING as a completely dustless pad. Generally speaking however, the harder the compound, the less dust per mile accumulated on your wheels. Organic compounds (particularly older asbestos based pads) are about the worst. The Axxess nee PBR nee Repco pads are better than stock but the organic versions still have more dust accumulation than the Metalmasters. Of course, you get a significant increase in braking performance with these so what's a little dust when you can stop in 15% (guesstimate) less distance. Might save one's life one day. On that note, someone mentioned a tradeoff using metallic pads versus softer OEM type pads and their relative effect on rotors (wear). In my type of driving (90%+ freeway), I'm not on the brakes much which owes to my getting 90k+ miles per set AND original rotors after 221k miles. If you are driving more stop/go type traffic scenarios, there will be some additional wear on the rotors but not so much as to worry. (Either way, you're going to replace them anyhow...)

[TechTip from C. Smith of Stoptech] There is no such thing as an ideal "all around" brake pad. The friction material that is quiet and functions well at relatively low temperatures around town will not stop the car that is driven hard. If you attempt to drive many cars hard with the OEM pads, you will experience fluid boiling, pad fade and friction material transfer - end of discussion. The true racing pad, used under normal conditions will be noisy and will not work well at low temperatures around town.

Uneven Pad Wear. [Tech Tip from Wagner Brake] While inspecting for excessive pedal travel, brake linings appear worn in a tapered pattern, even though the pads have not reached minimum thickness. SOLUTION: Uneven pad wear is not normally related to excessive pedal travel, but it's not unusual to discover one problem while investigating another. Linings with tapered, uneven wear should be replaced if the difference in thickness from one end of the pad to the other 1/8 inch on floating calipers. This remains true even if the linings have not reached minimum thickness because this condition can result in pads becoming wedged in the caliper. If the pad that contacts the caliper piston is worn much more than the one on the other side of the rotor, something is interfering with the necessary sideways movement of the caliper. This may be corrosion, contamination, or improper assembly. Possible causes of excessive pedal travel are low fluid level in the reservoir, air in the hydraulic system, an open bleeder screw (avoid the use of Teflon tapes or pipe thread sealants which do not help seal and may cause contamination), improperly positioned pads, .., piston seal damage in one or more of the calipers, a leak past the piston cups in the master cylinder, excessive rotor runout or a bent rotor and bad or excessively loose wheel bearings.

Pad Break-In. [Tech Tip from C. Smith of Stoptech] Follow proper break in procedures for both pad and disc. All after market discs and pads should come with both installation and break in instructions. The procedures are very similar between manufacturers. With respect to the pads, the bonding resins must be burned off relatively slowly to avoid both fade and uneven deposits. The procedure is several decelerations with a brief cooling period between them. After the last stop, the system should be allowed to cool to ambient

temperature:

High Performance Metallic/Ceramic Pads. Typically, a series of ten increasingly hard stops of increasing severity from 60mph to 5 mph with normal acceleration in between should get the job done for a high performance street pad. During pad or disc break-in, **do not come to a complete stop**, so plan where and when you do this procedure with care and concern for yourself and the safety of others. If you come to a complete stop before the break-in process is completed there is the chance for the non-uniform pad material transfer to take place and the results will be what the whole process is trying to avoid. Fortunately the procedure is also good for the discs and will relieve any residual thermal stresses left over from the casting process (all discs should be thermally stress relieved as one of the last manufacturing processes) and will transfer the smooth layer of pad material onto the disc. If possible, new discs should be bedded with used pads of the same compound that will be used going forward. Again, heat should be put into the system gradually - increasingly hard stops with cool off time in between. Part of the idea is to avoid prolonged contact between pad and disc.

Street and Organic Pads. [Ken Crossner] Per PBR's pad instructions, use a similar technique as above, but subject the pads to a series of moderately applied brakes slowing from 30-35 mph down to 5 or 10 mph, and then accelerate gently up to 30-35 and repeat about 6 to 10 times. You are trying to only gradually warm up the components. Again, **don't come to a complete stop** during the exercise.

Brake Pad Replacement.

Rear Brake Pad Replacement:

[Tips from Andre] Changing the rear pads on ANY Volvo since the 70's is pretty much identical. You will need a hammer and a long narrow punch (a large dull nail works in a pinch). Since your car is new you don't have to worry about rust so everything will come apart easily. If the car is more than 3 years old, it is generally good to replace the hardware (i.e. brake pad retaining pins and retaining clip).



To Remove:

- Take off wheel
- Tap out the two pins just to the rear of the pads, passing from the inside of the caliper body to the outside. Tap on the outside exposed tip of the pins toward the center of the car using a small punch and hammer.
- Remove retaining clip
- Use large screw driver to lever the pads out using their mounting ear holes.
- Pull pads out.
- Check that the [pistons are angled correctly](#).

To Install:

- Place a hose on the bleeder; open the bleeder and at the same time squeeze the

pistons back using either adjustable pliers or a C-clamp. If the former, use an old steel shim to cover the the piston surface beneath the plier jaw to prevent boot tears. [Peter Penguin] If you have a tough time squeezing the piston back, remove the top caliper guide bolt, swing the caliper back and down (carefully supporting it with a bent coathanger so it does not place a strain on the brake hose), and either use a c-clamp or place a wood 2x4 in the caliper space and use a pry bar to lever the piston back. Tape a plastic zip-lock baggie onto the end of a 10" plastic hose connected to the bleeder valve. Then it can spin around without any spillage and it's easy to inspect it the old fluid for debris. If you have ABS brakes, place a hose clamp on the brake hose above so old fluid is not pushed up the line. Now is also the time to determine if the caliper bore is so rusted that the piston won't retract or sticks in place and the caliper should be replaced.

- Either re-use or replace the [anti-squeel shims](#) behind each pad. The outer one is stainless steel, the inner next to the pad backing is teflon-coated fiber. The shims are there to minimize squeal. Either clean them up and re-use them or drop by a dealer for some new ones. Cleaning works well for the stainless steel shim. If you have teflon coated and the teflon is damaged, replace. They come with new volvo OEM pads, but usually not with aftermarket pads. Apply synthetic brake grease to both sides of the teflon shim or, if you have no shim, to the back of the pad, to prevent squeal. Install the teflon shim between the pad backing and the steel shim, which goes next to the piston. Apply brake grease to metal-to-metal contact points between pad back and caliper.
- Apply some anti-seize on the pins and insert them. Don't forget the flat spring clip which is oriented so that the pins hold it in place. The first pin will go in very easily with a hammer and punch. The second pin will be a minor pain since the clip is in place. I usually use some pliers to help line it up with the receiving hole and then tap the pins in place with a hammer and punch until the compression ring seals are firmly in place in the caliper holes. The rings need to seat firmly in the caliper body, but the heads may protrude slightly depending on brand. Test that they are firmly in place by trying to press on the other end of the pin using the punch end: they should be well seated in place and not loose.
- Install wheel. See [Anti-Corrosion Advice](#) for tips on preventing stuck wheel bolts and wheels. [Torque wheel nuts correctly.](#)
- Be sure to seat the pads correctly. This is very simple and there should be instructions with the pads. Basically take the car up to 30 MPH and stop with even pressure. Repeat a few times.



Front Brake Pad Replacement. [Tips from Andre]

To Remove:

- Remove wheel
- Remove the two bolts on the back side of the calipers holding the caliper guide bolts in place. Use a quality six point socket for the bolt or a hex socket, as appropriate, and NOT an adjustable wrench or cheapie socket since the bolt may be corroded and stuck. Note that there is a lock nut next to the rubber caliper pin sleeve, which requires a thin 17mm wrench to hold while you rotate the bolt at the back. A bicycle

wrench is perfect for this. You can now pull the whole assembly away from the rotor. Due to wear, the old pads may get slightly stuck in a groove. Insert a large screw driver between the caliper and the rotor and lift... it will come off pretty without too much trouble.

- The spring pad retainer at the back of the caliper slides out. The pads can be removed.
- Place a hose on the bleeder; open the bleeder and at the same time squeeze the pistons back using either adjustable pliers or a c-clamp. Use an old steel shim or tape on the jaws to prevent boot tears. [Peter Penguin] If you have a tough time squeezing the piston back, place a wood 2x4 in the caliper space and use a pry bar to lever the piston back. Tape a plastic zip-lock baggie onto the end of a 10" plastic hose connected to the bleeder valve. Then it can spin around without any spillage and it's easy to inspect it the old fluid for debris. If you have ABS brakes, place a hose clamp on the brake hose above so old fluid is not pushed up the line.

To Install:

- Install anti-squeel shims or anti-squeel paste to back of pads. Apply brake grease to metal-to-metal contact points between pad back and caliper.
- Install pads
- Insert anti-rattle spring clip. Make sure this is correctly oriented to hold the pads in place. If it isn't, the pads will rattle.
- You can get the caliper lined up in the holes with pliers, and give it a gentle tap with a small hammer to seat it in place.
- Lubricate the caliper guide pins and inspect the rubber boots.
- Slide the whole assembly over the rotor and insert the bolts back in place.
- Install wheel. See [Anti-Corrosion Advice](#) for tips on preventing stuck wheel bolts and wheels. [Torque wheel nuts correctly](#).
- Be sure to seat the pads correctly. This is very simple and there should be instructions with the pads. Basically take the car up to 30 MPH and stop with even pressure. Repeat a few times.

Brake Lubricants:

[Tip from Brake and Front End Magazine, Nov 01] Use a synthetic moly or PAO-based lubricant for metal-to-metal contact points and a synthetic silicone brake lube for caliper assembly with rubber parts. Do not use white lithium or chassis grease in brake work. In disc brakes, lubrication points include the caliper slides and bushings, self-adjuster mechanisms on rear disc brakes with locking calipers, and the parking brake cables and linkage. Brake grease can also be used to dampen vibrations between disc brake pads and caliper pistons. But, it should not be applied between the pad and any noise suppression shims that may be used. Use it on the back of a bare pad or between the pad shim and caliper. One place you never, ever want to get any grease on is the friction surface of a brake lining - which is another reason for not using low-temperature or petroleum-based lubricants which can melt, run off and foul the linings. Grease-contaminated shoes or pads will be grabby and usually cause a brake pull to one side. The only cure is to replace the fouled linings with new ones. Cleaning is out of the question because solvents and cleaners can adversely affect the linings, too. [Fitz Fitzgerald] The brake lube is intended to be used at every point where the brake pad contacts another metal part, except the rotor:

- Apply a ring of lubricant to the back of the pad where the piston pushes against it.
- Apply lubricant to the spots where the edges of the metal backing plate touch the

- caliper housing (clean these areas first, both on the caliper and the pad).
- Apply to the caliper glide pins.

Should any grease (even a greasy fingerprint) get on the pad or rotor material, be sure to clean it off with brake cleaner.

Additional Replacement Tips:

[Inquiry:] Any hints on front/rear brake pad replacement? [Response:] Be sure to remove the sliding pins on both front calipers. Inspect them and replace if worn or badly rust pitted. Otherwise, clean them, grease with silicone based brake grease, and reinstall. Clean caliper sliding surfaces with small wire brush and blow clean (use a mask!!). Check to see if new pads are beveled on leading and trailing edges. If not, consider putting a 45 degree bevel on them. Use the brake grease on the backing plate, the anti-squeal plate and the edges of the backing plate that contact the caliper. Install the pads carefully so that the anti-rattle springs do not get broken (the springs on the new REPCO pads are much heavier than the earlier pads, so should not break like they did before).

I prefer the plain stainless backing plates rather than the black rubber coated ones. The rubber, though it may be thin simply adds a bit of softness to the pedal feel, as does any of the 'rubbery' anti-squeal treatments. I have found that just using the Volvo brake grease seems to solve the squeal problem as long as you clean rust off the caliper contact and sliding surfaces. The backing plates should have some slots or holes in them - creates a slightly of center contact surface for the pistons which apparently helps prevent squeal.

If you are replacing the rotors, clean the protective oil coating off the new ones with brake cleaner so you do not contaminate the pads. And remember that when you first get in the car after replacing pads, you will have to pump the brake pedal several times (not all the way down: just an inch or so) to move the caliper pistons back into position.

Brake Squeal. [Brake and Front End Magazine, Aug 04]

Brake squeal is caused by high frequency vibrations. When the brakes are applied and the pads contact the rotors, tiny surface irregularities in the rotors act like speed bumps causing the pads to jump and skip as they scrape against the rotors. This, in turn, causes the pads to shake and vibrate in the calipers and against the caliper pistons. It also causes the calipers to shake and vibrate on their mounts and bushings. The greater the play between all of these parts, the greater the amplitude of the vibrations and the louder the squeal. [Tips from Raybestos to eliminate brake squeal. These tips are generic and not specific to Volvo.]

- Before disassembly, mark the rotor-to-hub mounting position, to assure a remount in the same position.
- Clean the mounting surface of the rotor before mounting it on the disc brake lathe. [Editor's note: Volvo recommends NO TURNING ON A LATHE.]
- Apply a non-directional finish to the rotor with 120 to 150 grit sand paper, using moderate hand pressure against the sanding block in an up and down movement for approximately one minute per side.
- Wash the rotor thoroughly with soap and water.
- Clean the mounting area of the hub for a perfect hub-to-rotor fit.
- Inspect, clean and lubricate all possible metal to metal contact areas of movement

between the caliper halves.

- Lubricate all sliding and floating hardware components with a high temperature sliding caliper grease. Use new hardware whenever possible.
- Properly apply new shims to the pads.
- Lubricate contact areas between the shim and caliper piston, between the anti-rattle clip and caliper housing, between the shim and contact area on the caliper housing, and between the pad's locator buttons and caliper housing. Also lubricate any possible contact areas between the pad's plate and the caliper housing or bolts.
- Torque the caliper mounting bolts and the [wheel nuts](#) to specifications.
- Bed in the pads with 8 to 10 brake applications with moderately applied pedal pressure, from 40 mph to a complete or near stop about a quarter of a mile apart. If a good pedal feel and proper stopping distance is not achieved, continue the stops until the desired results appear.

While these procedures will not guarantee against a noise-related comeback, they will reduce the odds significantly. Moreover, these methods have been developed in the field by brake technicians and approved by others using the same techniques.

Brake Pad Anti-Squeal: Pastes and Shims. Brake Pad Anti-Squeal Treatments.

[Inquiry:] What's your experience regarding brake pad anti-squeal treatments? I've looked at the following

- Lucas foil stick-on shim pads
- Permatex spray-on elastomer for the back of the pads
- Various glue-like treatments that leave a ribbon of elastomer on the back of the pads
- Other techniques such as beveling the edges of the brake material, rounding off the metal backings, etc. My 740 Girlings do not use pad shim springs. I have had good luck with the foil shims, but how have you fared?

Shims. [Response: Don Foster] Try using the stainless shims (available from Volvo) behind the pads. Also, there are Teflon sheets (also from Volvo) you can insert between the stainless shim and the pad metal backing. Be sure the piston bears against metal. If you're truly climbing-the-walls desperate, there's some "goop" you can put on the back of the pads to dampen vibration (squealing). I've used it, it works, it's messy. But the shims are better (but from Volvo, not too cheap).

[Response: Benjamin] I too, tried the Lucas foil backings, with no success at all. What finally worked on my Saab was some cheap rubber-like adhesive shims from NAPA. They cost about \$3 per wheel, and stuck to the back of the pad like the Lucas foils, however these were rubber, and work great. This is the only thing I've tried that works. I tried the Lucas foils on my MetalMasters when I got them from SAS, with no results. I then put these rubbers ones on the MM's, and presto, the first squeal-free Saab I've had in over 7 years of owning different Saabs.

Caution: Aftermarket Pad Shims. [Editor] Several anecdotes have been received about Beck Arnley pad shims, which can come loose and score a groove in the rotor which may lead to rotor and wheel failure. If you use stick-on shims, make absolutely certain the pad backs are clean of grease before installing the shims: spray them first with brake cleaner. Loose shims need to be carefully installed in the calipers before finishing the job so they cannot migrate loose. Consider using paste or grease instead of a shim or stay with the Volvo OEM version.

Synthetic Grease.

[Response: Phil] For squeaky brakes get some synthetic brake lubricant or Dow Corning compound 111...it's a heavy silicone grease...real heavy and tacky...melts at 500 degrees F. Put a layer of this on the back of the pads. It won't wash off and they'll never squeak again. Don't get any on the pad braking surfaces or you may not squeak again either. Lubricating the caliper mounts, shims and bushings is also recommended to dampen vibrations here. The lubricant acts as a cushion to dampen vibrations. It also helps the parts slide smoothly so the pads wear evenly (uneven pad wear is a classic symptom of a floating caliper that is sticking and not centering itself over the rotor). How to apply grease: use a visible film of brake caliper lube on all pins and other contact surfaces (yes, even ss shims coated with nylon, etc.), both sides of the shims, and the backs of the pads in contact with the pistons. Don't worry about the stray dab on the pistons' outer edges, just make sure the grooves on the clips on either Girling or ATE calipers in which the pads slide are in place and properly lubricated. Your brakes should be fairly quiet

Anti-Squeel Paste.

[Response: Ceferino Lamb] For anti-squeal, for about 10 years now I've used that thick orange or red anti-squeal goo in the squeeze bottle. I've had no brake squeals since 86, when I sold the Pig-O-Steel (Nissan 280ZX), so the goo seems to work well, and is universally applicable. I always change my own pads and disks. You can buy it at almost any large auto parts shop (Pep Boys, Grand Auto, Kragen, etc), under several brand names. [Tom Francis] The secret of using this stuff is letting it dry for about an hour before the pads are installed.

Change the Pads.

Semi-metallic pads and those with a high metallic content tend to be more noisy than low-metallic pads or those with little or no steel or iron content. The best results are usually obtained by installing premium pads. Most premium pads also have chamfers and slots to reduce noise. [Adam] Try removing the pads and chamfering the all of the edges as well as removing any accumulated dust. A Dremel works well.

Rotors:

Brake Rotor Replacement

Front Brake Rotor Replacement.

Does the Brake Rotor Need Replacement? *Rotor Wear and Thickness.* See the [tables above](#) for minimum rotor thicknesses, measured with a micrometer in the wear surface. If the rotor is at this thickness, replace it. *Lip on Edge?* When I was changing out the pads I noticed that the rotors had a lip around the outer edge. The metal sticks out approx. 1/16 inch beyond the rest of the rotor. The rotors do not seem to be warped. Should grind this outer edge off so that the entire rotor is of uniform thickness? [Suggestions:] Regarding the lip, you don't really need to worry about this, unless the pads are riding on the lip.

Replacing the Rotors. Changing the rotors is very easy. With wheel off, remove the caliper (2 -13mm bolts) and hang it up with a wire so it does not strain the brake hoses. Then remove the caliper mounting bracket by removing the two 10mm allen or Torx-style

bolts. If the latter, use a 3/8 drive or larger socket as they tend to be difficult to turn. Unscrew the wheel locator index pin. Whack the rotor a few times with a mallet to loosen it and pull off rotor. [Tom Irwin] Hit the hubs with a wire cup brush chucked in a drill motor, cleaning off all corrosion everywhere the rotor mates with the hub. To avoid mismatch and subsequent vibration, the hubs must be shiny clean EVERYWHERE that the rotors touch, even around the wheel studs. Wipe the new rotor with solvent-based brake cleaner to remove its protective oil coating, Then replace the rotor, the caliper mount, and the caliper. When reinstalling the wheel, see [Anti-Corrosion Advice](#) for tips on preventing stuck wheel bolts and wheels. [Editor] While the manual suggests that you use new brake caliper mounting bolts, general consensus is that this is unnecessary. They can sometimes stretch causing them to come into contact with the inboard rotor surface. For peace of mind, use Loctite on the bolts when reinstalling.

Brake Rotor Identification. [Tip from Larry Jacobson] When I bought front disks for my '91 744T the Volvo dealer said there are three disks that are stock on that car and they all look the same. The only surefire way to get the [right disk](#) is to tell them the *exact* diameter and then they can match the part.

Brake Rotor Balance. [Editor] See the [note below](#) to match the balance lines on rotor and hub and minimize runout.

Brake Rotors: Premium versus Economy.

[Tips from Counterman Magazine, August 2001] What's the difference between "economy" rotors and "premium" rotors? Besides price, there are also differences in rotor quality, performance, fit and finish. Premium rotors typically follow the design of OEM rotors because rotors are engineered to meet certain noise, cooling, friction and performance characteristics. If a replacement rotor does not meet the OEM criteria, it may take the brake system out of compliance with FMVSS105 or FMVSS135 government safety standards

Economy rotors may not meet these requirements and may decrease braking effectiveness and increase pad wear. Because of this, some suppliers of premium rotors now "certify" their rotors as meeting all OEM requirements. One reason for these differences is the metallurgy of the rotors. Economy rotors are typically made in a less controlled environment, which results in poorer grain structure in the casting. This, in turn, affects the hardness of the metal, pad wear and noise. Economy rotors may also contain unwanted impurities, which can form hard spots, pits and pores in the casting. Premium rotors, by comparison, are made using higher quality control standards. This results in better castings with consistent strength and hardness.

Another difference between economy and premium rotors is that the former may not use the same number of cooling fins or a different configuration. This may reduce cooling and increase the risk of pedal fade under hard use. Surface finish is another difference that's hard to see, but affects pad break-in and stopping performance. If a rotor does not meet OEM requirements for surface finish, it should be resurfaced before it is installed. This shortens the life of the rotor and increases the risk of installer error or a comeback if the rotor is not turned properly. Dimensional accuracy is also critical. This applies not only to rotor runout and thickness variation (which can cause pedal vibrations, shudder and comebacks) but also all machined surfaces including the size, location and centering of the hub opening, the lug holes and the overall diameter and thickness of the rotor.

[Tips from Brake and Front End Magazine, Apr 2003] We have very good results installing slotted front rotors as well as a cross-drilled style, as the factory doesn't offer a heavy-duty rotor. The slotted rotors that we use undergo a factory three-stage heating process that prevents warpage. They cost a few more dollars than other brands, but they are well worth it when comebacks for this problem become history.

[Note from Tom Irwin] There is some evidence that Volvo OEM brake rotors for 960/90 cars are of lesser quality; buy aftermarket for better quality and lower prices from reputable suppliers such as [IPS](#), [FCP](#), [IPD](#), [RPR](#).

ABS Sensors. Do NOT remove or adjust the ABS sensors while changing pads or rotors. See [Brake Rotor Removal on 740 with ABS](#) . But DO clean them and the behind-the-rotor reluctor wheels off with a soft brush.

One-Part Hub/Rotor Versus Two-Part. In 1988, Volvo changed the front brakes from an integral one-part hub and rotor to a separate two-part hub/rotor system. In changing rotors while looking at a Haynes manual it's easy to get screwed up on the later two part hub/rotor. The manual suggest that there may be some problems removing these and that a puller may be necessary. No puller is necessary (just use a mallet on the back of the old rotor. You do have to remove the caliper holding bracket...remove the calipers and hang them with a piece of coathanger wire out of the way. Use a long bar and socket wrench to remove the two bolts that hold the caliper bracket on. Put them back with proper torque and blue loctite. You DON'T need to use new bolts unless the bolts won't torque up. Remove the conical wheel locating pin: it holds the rotor on. Make sure the new rotor and the hub/rotor mounting surface are clean when you put the new rotor back on.

Rear Brake Rotor Replacement. [Tip] Because the parking brake drum shoes are inside the rear brake rotor, make sure the handbrake is NOT applied when trying to remove the rear rotors. Corrosion can cement these in place so be prepared to knock them off. See [below](#).

Brake Rotors Rusted On.

[Inquiry:] I need advice on removing a rear brake disc that rusted solid on its hub. The parking brake is off, and I am able to manually rotate the disc, so I know its not the drum brake holding it. More than a few whacks with a mallet didn't help. I've sprayed penetrant wherever I could.

[Response:]

1. If you DON'T plan on changing your rotors (only for re-surfacing):

- let some penetrant (Liquid Wrench, PB Blaster) soak on the lug nut studs for as long as you can (where the studs meet the rotor). This is the location of most of the trouble. If you plan on keeping the rotors, don't get any on the "pad area" of the rotor.
- remove the wheel, replace the lug nuts back on the bolts for a couple of turns (so the top of the bolt doesn't show through the nut) and tap the head of the nut swinging towards the car. Ddon't use a hammer on the pad-area rotor. You can medium-tap the circumference of the center portion of the rotor as you spin it, also. It takes patience (My 1985 BMW 325es rears took me 2 hours). Editor's note: use a soft-faced mallet.

2. If you DO plan on changing the rotors:

Follow the steps above, but with increasing force. If it is STILL stuck, crawl under the car (which must be properly on jack stands), face outward and spin the rotor while **WAITING** on the outside edge of the rotor with a mallet/hammer (outwards). It **WILL** eventually come loose.

Just try not to have any part of your body under the rotor when it pops off (usually you can tell it's about to go). Editor's note: use a thin coat of anti-seize on mating surfaces between hub and rotor to easy later disassembly

Brake Rotor Installation Techniques to Minimize Pulsation.

[Editor's Note] Per the Volvo manual, cars built after week 11 of 1990 have hubs with balance lines inscribed onto them. Volvo states "the type of marking may differ; the component may be identified either by a paint spot or by a physical marking". The photo of the hub illustrating the mark in the Green Book shows a painted line on the outer bearing cone or cover shoulder. Volvo shows the corresponding mark on the brake rotor to be a mark in the form of a line scratched in along the edge of one of the mounting holes. After years of rusting, these marks are likely not visible. If they are, match the balance mark on the rotor with the balance mark on the hub . This matches the rotor and hub and minimizes runout. Make sure you have removed all rust from the portion of the hub that contacts the rotor. If the marks are not visible, just install the rotor in any orientation and do not worry about it.

[Tech Tip from Wagner Brake] If the balance lines are not present or are invisible when replacing or removing the rotor, refer to the following service procedure to minimize hub/rotor "stacked" runout:

1. Completely clean the hub area contacting the new/turned rotor.
2. Install the rotor on the hub, securing it with at least three lug nuts tightened to 20 lb. ft. (27 N-m) for testing.
3. Using a [dial indicator](#), determine the total runout of the system. The total rotor and hub runout must not exceed .002" (.05mm).
4. If the runout exceeds .002", proceed as follows:
 - Remove the rotor and rotate it clockwise until the next hole lines up with a stud;
 - Secure the rotor in the new position, reindexed as described in Step 2; and
 - Repeat the checking and rotation (reindexing process) until the system measures .002" or less total runout.
5. If .002" (.05mm) or less runout cannot be reached, the hub should be replaced and Steps 2 through 4 repeated when the new hub/rotor is installed.

Make sure you reinstall the wheel lug nuts with [proper torque values](#).

[Editor's Notes:] [Editor] (1) Note that Volvo recommends you first test runout without the rotor installed, marking the proper spot with a punch, then install the rotor with its mark matching the spot. Often, however, replacement rotors lack a balance line. (2) If your brake rotors continue to warp even after careful installation, then almost certainly you've got a sticking caliper or caliper guide pin. These can cause the pads to rest against the rotor, overheating and warping it. To isolate warping to a specific wheel, the easiest and most effective method is to use a brake hose clamp device on each brake hose. If the

condition disappears when the hose is clamped, examine the wheel for a cause. These clamps are commercially available from several tool manufacturers and are specially designed for this purpose. They are similar to vise grips, but are much friendlier to the hose. Be aware that higher brake pressures can push through the clamp and trap pressure in the brake. The brakes will quickly overheat, so keep your tests short.

Rotor Turning and Torque.

Should I Turn My Rotors? Volvo does **not** support or advise re-machining of brake rotors, ever. If you look at the machines most shops use to do this work they decide where to clamp the rotor down by eye-ball. When it goes back on the car it is usually worse than when you started. And when you get new rotors - DO NOT let anyone turn them before installation in order to "true them up". They are new, and in the best condition they will ever be in. Don't let anyone screw them up before you ever use them. If your turned rotors are pulsating, I suggest you throw them away and start over with a new set.

Wheel Torque and Warped Rotors. Volvo rotors will warp like crazy if the wheel nuts are over-tightened and/or not tightened evenly. If you see someone use an air wrench on your lug nuts when installing your wheels - warped rotors are just a few miles away. Our 1988 760 has gone through several sets of rotors. The problem has been solved since I now insist on a [torque wrench being used](#) after the lug nuts are hand tightened. Current rotors have over 40,000 miles and are living well. When you have work done at a tire shop they are there to do what you need done, not what is the fastest for them. Let them use the air tools on someone else's car.

Front Calipers:

Caliper Guide Pins: Maintenance

Guide Pin Discussion. In the Girling front brakes there is a retainer cage that fastens to two "ears" on the axle assembly. There are 2 hex socket bolts that hold this retainer on. At the back of the retainer are two sockets that each receive a floating locating pin encased by a rubber sleeve. The caliper is bolted to these pins so that it is free to move sideways a centimeter or so. The pins have to be lubricated and free to move. In my case one of these pins on each side was [frozen](#) and not moving. Thus when the brakes were applied the pistons were able to push the inside pad out but the caliper was not able to move in and pull the outer pad into firm contact. This caused noise and pulsing. [Tip] The front caliper is held by two floating guide pins which move within a bushing fitted into the caliper. Often this bushing shows corrosion and the pin can not be moved within the caliper. If so, the brake performance decreases as the two calipers cannot press the disc properly. To inspect the functioning of the brakes: remove the guide pin bolts and pull the caliper up and away from the guide pins. You should be able to easily move the guide pins in and out. If not, the pin or bushing is corroded or in need of lubricant.

Removing Caliper Guide Pins. [Tip from John B] On Girling it's pretty straightforward: remove the fixing bolt, pry the collar on the rubber boot from the caliper and then the boot and the guide pin should come out. Lube the new pin with synthetic brake grease and insert it, put the new boot over the lip and press the collar on so that the ridge on the rubber collar fits in the recess on the pin. On Bendix, it's a little more difficult, you have to

ensure the ridges on the boot inside mesh up with the indent on the boot mounting ridge. [Tip from Randy] Unless they are seized the guide pins simply slide in and out after removing the brake pad. If they are seized a good soaking with Aerokroil (or your favorite penetrating liquid) along with the application of the correctly sized socket to add torque and a hammer to add vibration will help. Clean the hole thoroughly and apply an anti seize compound before assembly. I actually sprayed a lot of Kroil into the boot and let it soak. The best aid in having penetrating fluid work is TIME- as in long soak time. [Chris Herbst] One effective way to free the pin is to turn it back and forth while trying to extract it. It's not the easiest thing to do, and if it doesn't work, you are going to be in the market for a caliper carrier, which is not expensive.

Lubricant Recommendations. [Tip from Motor Magazine] Most brake lubricants suitable for use today are silicone-based; petroleum-based lubes may cause some newer rubber components to swell. [Editor] Use a brake lubricant specifically made for use on the guide pins; most will say "synthetic" or "silicone". Replace any torn rubber covers. Check the operation and lubrication of the guide pins at each pad change.

Replacement Rubber Boots. Wagner and others make replacement rubber boots for caliper slide pins: these may be had online or from local auto stores. The Wagner kit for the 1995 Volvo 940, for example, is p/n H8213.

Rebuild Kit. Volvo has available a repair kit for the lower caliper guide. Cost for the Bendix version is approximately \$30 US. Repairing the damaged caliper guide with a kit may be preferable in some circumstances for some owners. The heart of the rebuild kit is a new guide pin with a different design from the old one. Actually, there are two guide pin rebuild kits: one for the lower guide pin only, and one for both upper and lower. The lower guide pin is the one that is most often jammed. To determine whether either of the guide pins are jammed, remove the wheel and brake pads, and pivot up the caliper. The caliper should move freely and easily back and forth on the upper guide pin. The lower guide pin should easily move in and out. If a guide pin is stick in position, it needs to be repaired or replaced. Since the rebuild kit for the lower guide pin is only around \$25, I recommend it.

Guide Pin Bore Maintenance. [John Sargent] To remove light corrosion from the caliper guide pin bores, use a 10mm rifle or .410 gauge shotgun bore cleaning brush in a drill to clean them. When replacing the pins, lubricate with the high temperature silicone brake grease noted above and make sure the rubber boots are in good condition.

Caliper Guide Pin Troubleshooting:

Pulling Brakes or Uneven Wear: Caliper Guide Pin Wear or Corrosion .

[Symptom 1: My 740 '86 had just turned 100K mi. but it seems to me that every time I step on the brake the car pulls towards the right.] [Symptom 2: Abnormal or unequal pad or rotor wear.] [Diagnosis 1:] It turned out that the caliper slide pin was stuck. The left disk got very hot, because the outer brake pad was constantly pressing the disk and that's why the left front brake was more effective than the right one (because the disk and pads were cold). Also the outer pad wears faster than the inner pad if you have this problem. I simply sanded the rust off the slide pin bore so that the slide pin moved easily and then lubed the slide pin and reassembled the caliper. It might also be a stuck brake piston. So check the pistons, they should move quite easily. I have also rebuilt all four calipers because some pistons were stuck. In my case the pistons were in excellent shape, but the

bores in the calipers were not. So I just removed the rust from the bores and rebuilt the calipers with new gaskets and dust boots.

[Diagnosis 2:] Your problem might be the same as on my '87 745: the guide pins on your calipers may have worn or corroded, which causes them to grab the pads and hold them against the rotors. Voila, premature pad and rotor wear, as well as poor acceleration and gas mileage. The guide pins are a fairly inexpensive fix, and the difference on my wagon was attention-getting.

[Diagnostic Note:] I have found that a damaged lower guide pin is easily detected. One may not need to completely reassemble the caliper to perform the check. If the guide pin is badly damaged, as mine was, the lower guide will be frozen in place with no in/out play. You can remove the bushing from the caliper carrier by pushing with an appropriate tool (a 13mm socket). Lots of force may be required if this bushing has not been removed for long time. Clean bushing AND inside caliper with fine sandpaper or a rifle cleaning [brush](#). Put copper grease on the bushing and slide the bushing inside the caliper. This should be possible without force. Make sure the bushing allows the pin to slide freely and is not too loose. Mount the caliper without the brake pads, and check if the unit slides easily left and right. (Lower bolt to be fixed). Re-mount the brake pads. Mount the wheel and spin it around. Put some Loctite on the thread of the lower bolt and tighten the bolt to 25 ft-lbs. [Assembly note: A common cause of damage to the lower caliper guide pin is over-torquing the guide pin bolt, common when replacing brake pads.]

[Diagnostic Note:] If you have a problem with uneven side-to-side pad wear or an intermittent brake pull, in many cases the problem can be detected by using an infrared pyrometer or "heat gun" type thermometer to test relative brake temperatures. To perform this test, apply the brakes at 30-50 mph at least a half-dozen times. After parking in a safe area, check the temperature of the brake rotors with the infrared temperature tester to see if each axle set displays essentially equal temperature readings. Obviously, if the side-to-side axle set temperature readings differ by at least 20%, then a problem exists with the calipers, brake hydraulics or brake pads.

[Cautionary Note:] Repairing or rebuilding a stuck caliper guide pin may not cure the problem of pulling under braking. Anything that causes a major mass to suddenly shift under braking can and will cause the car to pull. Examples of things that can cause this are worn or broken engine mounts and worn out suspension bushings. So, when you're working on your Brick's brakes, check the condition of the motor mounts and suspension bushings. You may find that you need more than brakes. Of course, this makes a perfect excuse for a set of IPD bars as part of the suspension rebuild.

See also the discussion of [caliper binding](#) and [brake hose deterioration](#).

Pulsing Brakes: Caliper Pins Seized . [Report: Don Willson] Pulsing brakes fixed. 1989 765T with ABS and 135,000 miles. I have not seen this solution discussed though there has been plenty of comment on the problem and other remedies. The symptoms were a pulsing of the brakes when light pressure was applied. I thought that it might be the over tightened wheel bolts or a warped rotor. So I jacked up the front and started investigating. Yes the wheel bolts were too tight but the rotor was true, they had been turned last June. What I found was a retainer locating pin was frozen in place. In replacing pads about 4 times on my wife's 744 or my previous 745 I had never realized that there might be other problems though if it had been a snake I'd have been bit.

One locating pin was free to move, I could push it in and the grease seal bellows would push it back out. However the other was stuck. With about a half of an hour of twisting and prying I was able to remove the pin without damaging the retainer though the pin was trash. At Volvo I found that you can only by a kit, 4 pins, 4 bellows, 4 caliper holding bolts and a tube of grease for \$98. I objected but bought the kit.

Reassembly was simple though I did clean out the pin sockets and polish the inner diameters with Scotchbrite on a stick on a hand drill, or use a cheap brass rifle cleaning [brush](#). Reassembly was simple with a liberal supply of grease and properly fitting the bellows. Then locating the brake pads and slipping the caliper over the pads and fastening the caliper bolts to the locating pins. Since these pins are free to rotate a thin 13mm open end wrench comes in handy to restrain the pin while tightening the caliper bolts.

Since I had the pins I decided to check the other side. I was not so fortunate, one pin was stuck so hard it twisted off and I had to get a replacement retainer, \$10.

My recommendation is that when replacing pads and or disks you check both retainers by pushing them to the outside of the car. If they do not move freely remove the retainer (2 hex socket bolts) and get to a vise where you can work the pins out. Replace the pins and bellows. Even if the retainer moves smoothly it might not be a bad idea to remove the pins, careful not do damage the bellows, clean the socket of old grease and any water and relube the pins. I suspect the grease is a silicone as it is water white (about like KY).

[Editor] See the notes under [Caliper Corrosion](#) and [Brake Hose Deterioration](#) for similar symptoms caused by deteriorating rubber hoses.

Brake Calipers Rattle: Guide Pin Wear. [Discussion from Dave Stevens]

The primary problem area with worn 700/900 front calipers is the sliding caliper guides. Most often the problem will be worn guide pins and/or guide pin sleeves (inserts), particularly the sleeves and most particularly the lower ones. Sometimes, if the rubber boot has been damaged or has become detached at one end, water may penetrate the guide pin sleeve and cause corrosion. Light corrosion can sometimes be successfully cleaned up with a wire wheel and a wire-type bottle brush (or rifle brush) in a drill. A mildly worn caliper will cause uneven wear of the pads/rotors and may pull the car slightly to the side during initial braking. A moderately worn caliper may also become sticky and under certain conditions may even chatter or hammer. A badly worn caliper may freeze momentarily or permanently, reducing braking and warping the rotors. Removing frozen caliper pins may require extended applications of a top quality penetrating oil.

At every pad change you should check each guide pin in its bushing -mine wiggle a little and this is probably normal, but slop is not. This gives you a chance to properly clean and lube the guide recess. Shoot with spray brake cleaner and use a rifle cleaning brush to clean the inside of the bore. When removing a caliper, hang it up with a length of coat hanger wire or a plastic tie to prevent damage to the brake lines.

After cleaning the guide pins and sleeves, use a good synthetic brake grease to extend the life of a worn caliper. Note that for Bendix calipers, an affordable repair kit is available (guide pins, sleeve inserts, rubber boots, bolts), so these calipers can often be fully restored. For Girling (Lucas) brakes only a guide pin repair kit is available (pins, boots, bolts). Repair kits containing piston seals and dust covers are also available from Volvo for both types of calipers, but by that time you should probably be looking at replacement

calipers. Now if the guide pins are damaged by pitting from corrosion or are badly worn (uncommon as they are rarely worn more than a couple thousandths of an inch) and the recesses are in good condition then simple guide pin replacement can extend the life of Girling calipers, but I wouldn't consider that a proper restoration. In most cases, new guide pins and replacement caliper frames with good sleeves would be all that's needed to restore Girling calipers. Replacement caliper frames are available from Volvo, but they cost almost as much as re-built calipers from Volvo. Anecdotally, re-built calipers from Volvo (and others) often have worn sleeves, and of course it will be the lower sleeve from the original caliper. The same story will be true when hunting for used calipers or caliper frames in the yards. A good economical solution is to find used caliper frames that have minimal caliper sleeve wear. Use a guide pin for testing -there should be no slop, but a very slight wiggle of a dry pin in a clean recess is probably okay and you probably only need to check the lower guide. Then get a caliper repair kit (new pins) either from Volvo or an aftermarket source like FCP Groton. The next best economical solution is quality re-built calipers from a reputable source. Note that calipers are unique for left and right, but the caliper frames are identical left to right (the anti-rattle clip is just moved to the other end of the frame). You can use this to your advantage. Knowing that the lower guide pin sleeve will suffer the most wear in the future. You want to choose a set of caliper frames where the least worn sleeves are at opposite ends or choose entire calipers where the least worn sleeves are either both down or both up. Now re-orient the caliper frames (switching the anti-rattle clip as needed to the top) so that in the end the least worn caliper sleeves will both be down.

This, with occasional re-lubrication of the guide pins using synthetic brake grease, will maximize the service life of your semi-restored or re-built calipers. Note that the high grade hex insert caliper mounting bolts are torque to yield and technically should be replaced, but few people ever do. Clean the threads and torque to 105 Nm (77 ft-lbs) using a drop of red Loc-Tite. The caliper guide pin bolts are tightened to 30 Nm (22 ft-lbs) -make sure the back, flat square is fully seated (hold it in place with a 19mm open end wrench to prevent rounding the corners).

Generously coat the contact areas on the back of the pads with brake grease (same stuff you used on the pins), keeping the pad and rotor surfaces perfectly clean.

Rattling Sound from Worn Guide Pines or Spring. [Dave Stevens] TSB 51907 dated Feb/94 covers '83-'91 700 series with Girling (Lucas) 2-piston front brake calipers. It simply mentions that excessive wear between the caliper guide pins and their bores might, in some cases" cause a rattling sound and that a guide pin replacement kit is available (P/N 271854-2) containing guide pins, bushings, dust seals and mounting bolts. Obviously this was not a totally uncommon problem for Volvo to have even bothered writing up the TSB.

As you and the others notes, a much more likely cause for front brake rattling noise is a broken anti-rattle spring on one of the brake pads. You can inspect these without removing the pads. If you're going to change the pads you should always pop the dust covers, clean and lubricate the caliper guide pins using high temp silicon grease. Use the same grease between the back of the pads, the stainless anti-rattle plates and the piston faces to help minimize any tendency for your brakes to squeal. If you've got ABS, now is also the time to clean up the tips of those sensors (check the 740 FAQ and archives for notes on this).

Sticky Caliper: Internal Corrosion. [Inquiry] Despite replacing componens, I still have what seems to be a bit of pad drag (very intermittent, comes and goes). Should I suspect a sticky caliper piston?

[Response: Gene Stevens] Jack up the car and take the wheels off. Have an assistant push the brake pedal down firmly while you carefully watch the piston when the pedal is released. By design, it is the soft piston seal reforming itself to a square cross section that draws the piston back slightly. It does not take much interference to keep that from happening. Remember, there are no return springs on a disc brake. A bad caliper will not "walk" back and forth with pedal pressure. (FYI, it is the piston finding its position on the pressure seal, and taking in fluid when the pads wear, that make disc brakes self-adjusting.)

The NUMBER ONE reason for piston drag is moisture getting behind the dust seal, collecting at the bottom, and causing a slight buildup of rust on the land between the dust seal and the pressure seal. The rust actually touches the piston and keeps it from free movement. These seals are usually damaged DURING service (carelessness when sliding the caliper over the pads or the use of spray goo on the inner pad). That's why the "bad" caliper symptom often appears shortly after the first rain after pad replacement.

If the pistons move nicely, rebuilding the calipers probably won't fix your problem (but it is good P.M.). I had a similar problem with the same single piston setup on mine, and found the stainless steel guide plates and preload springs had little dings in them from years of service, causing a grippy surface for the pads to ride on, so they didn't slide as freely as they should. A \$12 hardware kit fixed the problem.

If you DO rebuild the calipers, scrape any rust buildup you see on the thin area between the seals. If you find signs of rust BEHIND the pressure seal, it means there was moisture in the fluid and it was not bled every few years. Caliper bore surface is NOT critical, so scraping is allowable, but piston surface must be perfect. Scored or pitted pistons must be replaced.

Replacing Calipers

Rebuild It Yourself or Buy a Rebuilt Caliper? [Tips from Editor/Chuck Jeckell] The shop I worked in insisted on rebuilding calipers in-house. 60% or so had pitted pistons and/or bores. Caliper repair kits don't come with pistons or sleeves, so I'd buy the rebuilt calipers from a reputable rebuilder. Consider the cost and quality of doing it yourself: you do not have the tools or the expertise to extract rusted bleed screws, re-tap threads, polish pistons and bores to correct dimensions or insert sleeves, and make the caliper leak-and-seizure-free. Buy a rebuilt unit with a guarantee.

Quality Checks on Rebuilt Calipers. [Tip from Larry] Most rebuilders of Volvo parts are up to speed on the necessary quality of the cores they rebuild. However, Girling placed a cast-dimple at the bottom of each "half" of the front calipers. Mis-matched, incorrectly-rebuilt front calipers will have a dimple at the bottom and a dimple at the top. The resulting internal cross-directed hydraulic pressures will cause bleeding problems and weird failures of an otherwise sound brake system: remember a Volvo without ABS has 2 separate hydraulic systems. Second, take metric wrenches with you to the parts store make sure the bleed screw threads in the caliper are capable of holding the bleed screws, and while you're at it, do a visual inspection of the threads and seals in the caliper. Occasionally a Volvo owner/mechanic will break a brakeline as it enters the caliper. Rebuilders have been known to ruin the caliper threads when they remove the broken flare-nut from the caliper body, so you gotta look there also. The test will come when you

install them and bleed the brakes: look for leaks and piston seizures. Often the brake pads used in rebuilt sets are at the low end of the quality scale; you may want to replace them. In any event, make sure the new pads will fit the rebuilt calipers: sometimes the rebuilder refaces the inner surfaces and does not leave room for the pads. Check the slide pin lubricant: make sure they are adequately lubed with top quality brake grease. Avoid these problems by purchasing only high-quality rebuilds from a reputable retailer who will back the parts if problems arise. [Editor] Consider buying remanufactured units locally. If you have a quality problem requiring a return, you don't have the shipping and down time issues when the retailer is local instead of across the country.

Removing Caliper and Installing a Rebuilt Caliper. The only difficulty installing a caliper is likely to come from corroded brake pipe or line fittings. See the [notes](#) below for tips. To keep fluid from escaping the master cylinder with a brake line open: 1) Disconnect battery negative (or pull relevant fuse) to keep brake lights off. 2) Connect a bleeder hose to the caliper (hose routed to waste container). 3) Open the bleeder, then slowly press the brake pedal to the floor and block it there till you are finished. 4) Slowly press the caliper piston back to expell as much fluid from caliper as possible. 5) Close bleeder and remove caliper for bench work.

Ignore the Above and Rebuild Them Yourself? Check This Advice First. [Tips from Dave Stevens] Here are some caliper re-build tips from my own experience with my '95 940 (Lucas-Girling jumbo type 2 w/ABS). Unless you have access to compressed air, before removing the caliper and disconnecting the line, pop the piston almost all the way out using the brake pedal. Use the backing plates of old disc pads (or something equally thick) as a guide to how far you can safely push the piston out before it is about to go past the seals and spill fluid all over the caliper. To fully remove the piston, I prefer to do it on the bench to minimize the mess, but you can also swing the caliper away from the rotor and wrapping it in a towel use brake pressure to push it out. When removing the caliper you can clamp off the hose using something wide that won't damage the hose and its interior lining -a section of heater hose or a wound rag with locking pliers works fine for most people. Once on the bench you can usually easily blow the piston out with air (a tire pump with one of those tapered plastic fittings will often do the job). If you have trouble getting the piston out it's best to put it back on the car and use pedal pressure. Although not recommended, you can twist and pull the piston out, but you mustn't risk scratching the outside of the piston with anything like pliers. Either grab the rough inside of the piston with expanding pliers or try something like wedging in a single jaw of a large pair of channel lock pliers or use something fairly benign like an F-clamp with those plastic jaw covers or a smooth faced c-clamp wrapping a few turns of protective tape around the protruding piston.

The front caliper repair kit from Volvo includes two sets of piston dust covers, seals, guide pin dust covers and guide pin brake grease. Take this opportunity to replace the seals as well as the dust covers. It wouldn't be a horrid idea to do both front calipers to keep them performing evenly -a sticky piston can cause some initial pulling during braking. The seal grooves in the caliper recess are machined with a tapered bottom to aid in sealing and retraction. If, for whatever reason, you are re-installing a seal it may have taken on this taper. If so, then the narrowest edge of the seal should be installed as the leading edge, seated furthest into the caliper body. It's sometimes hard to tell, but the seals (at least the ones I've encountered) have a slightly tapered cross-section to fit these grooves. Use calipers (the measuring kind) or try to stand the seal on edge on a smooth level surface to determine which, if any, would be the narrow edge of the seal -it installs as the leading

edge. To aid in installation, start by thoroughly lubricating the caliper recess and newly installed piston seal with brake fluid. Apply a thin coat on the back end of the piston. Pull the new dust boot over the back end of the loose piston. It will fold inside out as you do this. Pull it on just far enough to firmly seat it on the back end of the piston. Now fold the open lip back so it hangs out over the back end of the piston. Holding the piston in front of the caliper recess, carefully poke (don't use anything sharp!) the outer ring of the dust boot into caliper recess and seat it in its groove. The dust boot should now be positioned properly and all you need to do is push the piston back into the piston recess and through the seal. Use something like a C-Clamp (or carpenter's F-Clamp) with the floating seat on the screw into the end of the piston. Be sure to keep the piston aligned straight in to avoid tearing the seal, although with these large pistons that's usually not a problem. There will be considerable resistance as you try to push it past the seal then all of a sudden it will go through. If the piston or clamp walks to the side immediately back off and straighten out. Initially it may seem like you're using a lot of force, but as long as you remain lined up it will suddenly pop into place and move in easily. Once it's pushed in all the way make sure the front lip of the dust cover is properly seated over the piston. Seat the piston fully to expel excess air before bleeding. Using spray brake cleaner, thoroughly clean the exposed end of the piston right back to the seal, pulling the dust boot forward for access.

When re-installing the caliper, lube and check the caliper guide pins for [wear](#) and replace as needed. After the hose is reconnected, remount the caliper loosely and perform an initial bleed (note that DOT4 fluid is called for). Then remove and hold that caliper facing down at an angle and tap the caliper vigorously with a mallet to dislodge any air bubbles that may be clinging to the walls inside the caliper, on the piston and around the seal so they will float to the top. Re-mount the caliper and bleed some more until this process runs clear. Torque the caliper mounting bolts properly to 105 Nm (930 inch-lbs). FYI it's 30 Nm (265 inch-lbs) for the guide pins and an even 90 Nm (63-65 ft-lbs) for the wheel nuts. Read the FAQ sections on [bleeding](#). Replacing the fluid and then [pressure bleeding](#) is certainly the best way to go and doesn't need a helper.

Rear Brakes:

Rear Ate Caliper Pins. [Inquiry] When replacing the rear Ate brake pad securing pins, is Loctite required or would spring tension be sufficient to hold them in place? [Response 1: Tom Irwin] No way dude! Loctite there will ruin your day. As you install the pins, notice the truncated, conical sleeve that is at the head of the pin. I usually give each one a light kiss with a hammer to seat them a bit more firmly. However, the tension springs are designed to retain the pins. [Response 2: Alan Carlo] Spring tension holds the pins in place. I put a light coating of anti-seize compound on the pins to prevent them from rusting in place. I have been doing it this way for many years without a problem. Inspect the pins though and if they are badly rusted or the spring on the end is damaged or missing replace them. I usually seat the pins with a pair of channel lock pliers as the spring makes it hard to use a hammer and punch. [Editor] When seated correctly, the heads are almost flush with the caliper body. I give them a good whack to seat them, using the round head of a small ball pein hammer. If you do not seat them, they will fall out. Test by trying to press in on the other end using a punch end: they should be firmly in place and not loose.

Rear Brake Disk Removal. [740] Chilton's repair manual tells me to remove the center grease cap when replacing my rear discs; but it does not appear to have grease caps and is not obvious to me how to remove. [Response:] Had mine off last week. The disks fit pretty snugly over the axle hubs and a bit of rust can glue them in place. Try knocking them loose with a few hammer blows. Also, you may need to loosen the handbrake adjustment (inside the car) to let the disk clear the shoes.

Rear Brake Piston Rotation. [Inquiry:] I'm about to attack one of the ATE calipers on my wife's 740 to cure a squealing brake problem. I've been thinking it must have a stuck piston, but in doing a little pre-reading in Haynes (good illustration) and Chiltons (well...), they talk about the pistons being in the proper rotation and its effect on brake squeal. It seems there is a little step in the piston surface that meets the pad, and it is supposed to be oriented to 20 degrees. I never noticed they were built that way. Does anyone know if it is very likely that they ever get rotated out of the proper position, and if so, what's the effect?

[Response: Jim Holst] The ATE piston is supposed to be oriented in the bore so that the part of the piston in the direction of the forward rotation of the rotor is slightly higher than the other side of the piston to reduce brake squeal. The piston notches are angled 20 degrees from front to rear. According to the manuals, you use Volvo special tools 2919 and 2918 to measure and turn the piston. Not having the special tools, I just replace the pads and assume the piston hasn't moved in the bore. To turn the piston in the bore you need a tool which will fit inside the piston and expand to grip the piston. Sort of a c-clamp in reverse.

[Response: John B] There's supposed to be a stainless steel shim between the piston and the pad...the shim has two punch-outs that fit in the rear caliper pistons at the proper angle. Although you can use the special Volvo tool or make one yourself, I've been satisfied with eyeballing the angle using the shim...the piston can be rotated with a needle nose pliers or a screwdriver tip...be careful not to tear the rubber dust cover/seal.

Dust Boots and Piston Cleaning. [Dave Stevens]

Removing Dust Boots. The piston does not need to be removed. The dust cover has a hard plastic collar at the base. The collar friction fits into a recess in the face of the caliper where the piston comes out. Just retract it as far as possible then carefully pry the old one out. Make sure you don't score the piston in the process. If you want to get one out undamaged you'll want to use a small screwdriver without too sharp a tip and carefully work around the inside edge as best you can. The older design with the clip ring around the base was easier to remove, but far more prone to damage not the least of which was poking through it with the end of the clip ring. Rear pistons especially often get (partially) frozen, evidenced by uneven pad wear, brake drag and to a certain extent additional brake squeal. Brake drag is evidenced by any significant resistance when hand turning the rotor (or wheel) after applying the brakes hard (some pad scuffing, especially on the high spots is normal). Brake drag is also evidenced by unevenly warm wheels side-to-side on the car after a long hard drive.

Cleaning a Frozen Piston. A thorough cleaning will normally fix a frozen piston without having to remove it. The best time to do this is when you're replacing the disc pads, but another good time is when you're replacing dust boots. You'll be amazed at how well this works and, if the seal isn't too badly worn you can keep this game up for a long time:

- o Remove the dust boot.
 - o Extend the piston as far out as possible without breaking past the seal. Use something like the backing plate of a worn disc pad as a guide as to how far you can safely go without popping the piston (you can actually go about another 1/16"-1/8" if you like living dangerously).
 - o Clean the piston surface thoroughly and as deep into the recess as possible (with brake fluid). A stiff toothbrush and clean brake fluid is great for this. For troublesome areas, try cut strips from a worn Scotch scrubby well lubricated with brake fluid.
 - o Generously lubricate the piston with brake fluid.
 - o Retract it fully.
 - o Re-extend it.
 - o Repeat the entire cleaning process (perhaps 5-6 times) until the piston will extend without residual dirt showing.
 - o Extend the piston and clean up all external residual brake fluid. Spray brake cleaner fluid is good for this.
 - o Replace the dust boot making sure it is clean and undamaged.
 - o Scrape any dirt and rust from the top and bottom areas where the disk pad slides and file off any rust on the top and bottom edges of the disk pad backing plate so that the disk pad doesn't bind when installed (but it should not be a sloppy fit).
 - o To help reduce brake squeal, apply high temp brake grease between the steel shim plates and the disk pad plus a generous glob between the piston and the outer shim. Some people (and manufacturers) will also chamfer the leading and trailing edges of the pad and cut a water groove across the middle of the pad (which also serves as a wear indicator) to help eliminate brake squeal.
-

Parking Brake.

Operation:

[karlos_uk]. I have a handbrake problem on my 940 Wentworth. The handbrake works well, BUT when the handbrake is pulled up hard, the car still rolls a few inches like the shafts in the axles are turning an inch or so. Is this normal or has something broken? It drives well and there are no odd noises. Is this a problem? [clan]. NO, this is entirely normal! It is the shoes rotating to their stops and it happens on all Volvos with separate handbrake shoes in their rear discs.

Adjustment:

[Inquiry:] How do I adjust my parking brake? [Response: John Kaiser] Remove the rear center ashtray from the console and the plastic mounting plate behind it by prying slightly on the two locking tabs on the bottom using a thin knife or screwdriver. Adjust the cable housing with wrench or pliers so that the handbrake lever can be tightened to 7-8 notches of which the first two must be free travel. Braking action should be felt at the fourth to sixth notch. To tighten, rotate clockwise. Also check cable at rear differential left side. Sometimes the cable pivot wears and comes loose. You may have to check the parking brake shoes by pulling rear rotors if you cannot procure satisfactory p-brake adjustment. [Response: Leo R.] Adjustment: If you remove the ash-tray-holder behind the lever cover you'll see an adjustment for the whole brake. In cars without "multi-link" (the majority of 740's, it is common that one of the 2 brake cables is going to fail due to broken strands or a loose or rusty fastening which couples the right cable to the left. Easily seen when you lift up your car a little.

Cable Replacement:

Failure Mode. The cables can chaffe against chassis undercarriage parts and wear or rust through. The shorter cable to the right brake passes through two slots welded to the rear axle. These slots have plastic bushings installed. If the bushings break- allowing the cable to rub against the edge of the steel bushing holder- the cable will quickly wear through.

Editor's Tips: Do NOT buy aftermarket cables: they rarely fit correctly. Pay the extra price for OEM Volvo cables. Regardless of which cable you replace, buy the two pins and clevis clips securing the cables in the middle of the axle as these invariably will be rusted. The replacement cables come with the rubber boots to be inserted on the brake backing plate and the longer cable comes with a new u-yoke mounted in the middle. The small pins inside the parking brake lever mechanism are made of rustproof steel and usually do not need to be replaced. Now is also a good time to consider new parking brake shoes and springs if yours are worn or rusted. The small A-frame assembly welded to the axle in the middle may be rusted and close to failure: you can replace it using a clamp-like [device](#) below. If you are replacing both sides of the cable assembly, do one side at a time so you can use the other side as an assembly reference. When reassembling, use a tiny dab of brake grease at parking brake spring and shoe contact points but don't get any on the brake surfaces (if you do, clean it off with brake cleaner and a towel). If all you need is a new pin in the middle of the axle fixing the yoke to the axle, then use a 5/32 x 2 inch cotter pin.

Replacing The Shorter Right Cable. [Inquiry] How do I replace one side of my emergency brake cable? [Response: Peter Fluitman] The short cable connects to the u-yoke on the middle of the axle and activates the right side parking brake. Remove the right wheel and the caliper (no need to break into the hydraulics) hanging the caliper from the spring using wire. Then pull off the rotor which is secured by the screwed-in wheel locator guide pin (10mm deep socket or wrench). Remove the handbrake shoes: the springs are strong and you may need brake spring pliers, a large screwdriver, or some long needle nose pliers to handle them. The end of the cable is attached, by a pin, to the actuating mechanism (Part #9485387, called by Volvo an "Expander") . To access this pin, remove the steel block at the 3 o'clock position on the backing plate (as you face the hub). To remove the steel block, remove the two 14-mm bolts, that secure it. Once you have removed the bolts, the steel block can be pulled towards the rear face of hub, allowing you to reach the pin. You may need a punch to "tap out" the pin. Remove the old cable and assemble the new cable in the mechanism and feed it through the backplate. The expander lasts a long time and merely needs to be lubricated. The expander has markings that show the movable lever goes at the top (i.e., towards the top of the wheel well). You should then replace the steel block, and tighten the two 14 mm hex bolts. Remember to put the rubber boot back: the longer angled side goes down. See below for parts orientation. Assemble the front shorter spring in the two shoe holes, then pull them apart and insert the slotted plate. Separate the rear of the shoes and bring both sides over the axle toward the rear. Insert the shoes into the flat springs on top and bottom. On the rear, the hooked top of the actuator abuts the top shoe; the slot in the bottom abuts the bottom shoe. To replace the longer return spring, use a big screwdriver or long needle nose pliers levered over the axle. First clip it in the bottom slotted hole nearest the rear of the shoe (not the round one) and then with a long flat head screw driver and using the axle as a lever, get close to the upper notch and then push it in using another screw driver in the other hand. Feed the cable through the 2 loops on the axle casing. Then attach the other end of the cable. Slacken the cable off inside the car underneath the centre console (you

shorten the outer cable) to attach the end at the middle of the axle. Use antiseize or brake grease on the pins and clevis clips. Re-fit the disk and the caliper. Adjust the cable length and brakes by setting the cable back to give you 6 or 7 clicks on the ratchet when the lever is pulled up and the brake is fully engaged.

Replacing the Long Cable Assembly to the Console. [Tips from Ken] The longer cable from the brake lever in the console feeds under the rear carpet and seat to the center of the axle where the metal u-clamp is secured to the axle lever, thence to the left parking brake. The shorter right cable joins the longer cable at the u-yoke and controls the right brake. Begin by removing the center armrest/console. Loosen up the cable to the max by turning the plastic adjusting nut as much as possible. Remove the rear seat and peel up the carpet for better access to the cable. Unfix the cable at the lever by bending the lock tab and removing the cable and its pin.

Loosen the lugnuts of the left wheel and jack up the rear of the vehicle (after chocking the front wheels on both sides from rear and front... THIS IS A MUST) and place it on jackstands. You need a good amount of clearance to comfortably get under the vehicle to disconnect things so plan to raise the axle using a floor jack.

The long cable goes to the LEFT parking brake. Remove the left wheel, the caliper (hanging it from the spring with wire) and then the rotor and remove the parking brake shoes. Removing the parking brake shoes is a huge pain because of the strong springs (tip: use brake spring pliers or a big screwdriver, levering it over the axle). See above for tips: the cable ends and shoes are the same on both sides. There are 2 pins and R-type retaining clips on a u-yoke at the center-left of the axle. Remove the pins which invariably will be rusted in place. [tip: buy new pins and clips since these will be rusted tight.]

With everything disconnected, remove the cable. About 1/2 between the rear axle and the hole into the console inside the vehicle, there is another retaining P-clamp. In order to remove the cable, you have to undo the bracket. This requires a 10mm wrench for one side, and a 10mm socket for the other side. Finally, a little yanking and tugging and a lot of bad words later, I got the cable out. Putting the new cable in was very, very easy and you basically just do everything in reverse. Start at the P-clamp location by threading the cable toward the body hole, being careful to place it in the sheet metal channels provided, then thread it back over the axle toward the left wheel. Secure the cable in the console box and thread the large plastic nut fully onto the cable sheath so as to loosen the cable end at the brake.

Bring the brake end of the cable over the axle and fix the u-yoke to the A-bracket on the axle using a pin and cotter clip. Place the cable on the correct side of the speedometer sensor wiring to the rear axle: don't let it chafe this wiring. Feed the end of the cable through the brake backing plate and connect as above. Make sure you insert the rubber boots at both ends into the body hole and the brake backing plate.

Shoe Replacement Tips.

Shoe Failure. The usual failure mode is either wear of the braking surface because somebody forgot to release the brake or rust causing the braking surface to separate from the shoe. In the Rust Belt, the latter is far more common. When you replace the rear calipers, consider replacing the parking brake shoes as well, especially if you suffer from rust.

Part Orientation. The shoes have large holes that go toward the front of the car and four smaller holes, two slotted, that go toward the rear. The front shorter spring goes in the large front holes; the longer rear return spring goes into the rear slotted holes NOT the round ones. The metal plate with two slots separates the shoes at the front and is installed just forward of the spring. The rear metal edges of the pads are narrower than the front and the tabs rest on the cast iron block on the brake frame. The pads fit into two metal flat springs at the top and bottom of the brake backing plate. The expanding actuator has two slots: the hooked one at the top abuts the top shoe; the slot in the bottom abuts the bottom shoe. When you pull the cable which passes through the brake dust shield, the actuator levers the rear of the pads outwards. [John Sargent] The brake shoe expander needs to be installed with the arrow up. The notches in the brake shoe and matching notches in the expander can be a little difficult to get aligned. If the notches are not aligned, the e-brake shoe tabs protrude away from the metal block and prevent the rotor from fitting. Make sure the notches nest together and the shoes will rest against their stops correctly.



Cable Installation and Tightening.

Cable Installation. [Inquiry] I can't join the end of the right cable to the steel yoke in the middle of the left cable: there is a large gap. [Response] Loosen the cable by threading the large plastic nut in the center console all the way on to the cable: this loosens the ends.



Rotor Installation. [Inquiry] After replacing my parking brake shoes, I can't get the rotor back on. The adjuster is full loosened. [Herb Goltz] There are a couple things to check-- first, did you free up the actuators that the cables connect to? They should pivot at two points, not just one. I live in the "rust belt" and have yet to encounter a set that weren't at least partially seized on my last 3 Volvos. Antiseize is your best friend once you get them moving again. Make sure that the new shoes fit all the way into the notches in the flat bar (I have had to do fine fitting with a small file on two cars). The other possibility is that your cables are seized in their sheaths-- you can check their operation once the shoes are in place but before the rotors go back on. One final thing that I have encountered is cooked return springs on the shoes.

[Mark] I like many others couldn't get the new rotor back on. I called the dealer and a mechanic gave me the BIG HINT. He said it was a two person job: one person pulls the cable towards the brake to allow sufficient slack to compress the shoes. He also said remove the center console and make sure that the cable was "Real Loose" by adjusting the hand brake adjuster out (i.e., screw the cable end fully into the large plastic nut). [Hint] If you are working alone, you can push the A-frame assembly on the axle either way to

loosen one end of the cable: hold it with a screwdriver or piece of wood jammed against an axle bracket.

960 Cable and Shoe Replacement

[Tips: Paul Golden] In a 960 with independent rear suspension, the rear e-brake hardware and shoes and dust shields were all gone and the cable from lever to axle was broken, all thanks to extensive rusting. There was no way I was taking out the gas tank to access the cable above. I was able to replace the cables by removing the exhaust system behind the catalytic converter as well as the heat shield. There is a cable clamp close to the heat shield that holds the cable off the heatshield to prevent rattles. I removed the center console and fished the new cable from inside. The two other cables were not fun. The aluminum had oxidized around the steel sleeve and made the cables very hard to remove, but with patience, lots of PB Blaster, and a pair of vise grips on a slide hammer I was able to work them out. I cleaned up everything and made sure the cable routing matched the original installation. The new dust shields were quite difficult to replace: they do not fit over the rear hub. I had to make a small cut in the new shields and remove the studs from the hub to get the job done. Installed new springs, hardware and shoes, put the studs back in hubs, installed rotor and brakes, adjusted hand brake and reinstalled the center console, heat shield and exhaust. Total job was over 7 hours and not fun. But if I had followed the manual it would have been much longer. [Tip] In my case, the cable was caught above the gas tank. One can barely get a 1/4 drive wrench above the axle to remove the cable clamp. I had to undo the corroded nut on the exhaust side and all the nuts in the front and back, the latter of which are the worst to access. If you have to replace the cables make sure to buy the clip that holds the left rear cable to the end of the front cable.

[Inquiry] I have a 95 960 sedan that has a parking brake that went south. The handle and shoes don't respond.[Response: John Shatzer] My experience with the V90 is that the shoe assembly rusts out, not the cable. When this happens, the brake level is loose (no resistance). Replace the parking brake shoes.

Shoe Failure Due to Rust.

[Jim Bowers] Most cars need to have a working handbrake to pass state inspections. I had already replaced the shoes on the right side as the friction material broke off when I opened it up for inspection to see why they wouldn't adjust very well. On the driver side the friction material was loose for about half the length on both shoes. Rust had separated the friction material from the shoe. This happened to my on the 745 as well. I guess if you live in the "salt belt" you should plan on replacing handbrake shoes every 8 years or so. By the way, in replacing the friction shoes, getting the return spring in place took several tries using different approaches. Finally, a big screw driver resting on the hub lifted the end into the shoe's hole. Easy once you have a viable method, but almost impossible otherwise. Another tip: use brake spring pliers.

Brake Flange Failure on Rear Axle. In the Rust Belt, the two flanges welded to the rear axle that attach to a yoke on the handbrake cable can rust off. [Herb Goltz] To repair, you need a Rear Parking Brake Cable Guide Repair Kit, either Scantech or Worldpac part number N5015-232079, available from FCPgroton.com for about \$20. I called and asked for it-- it is not on their website. It is essentially a conventional muffler clamp with a bracket welded on the top. [Jim Sousa] I repaired mine with a 1-1/2" galvanized repair hinge from Sears hardware, a hinge with both halves 1-1/2 long and triangular. I rolled

the end of one side of the hinge around a small bolt the size of the pivot pin and cut a slot in it to take the cable attachment. I attached the other half of the hinge to the axle using a muffler clamp. [Donn MacDonald] The Volvo part number you're looking for is 1232549-4 and it needs to be welded on to the rear axle. It hasn't showed in any Volvo parts catalogs for years but when you've been around as long as I have you accumulate a load of notes and references and this is one I've kept close at hand. Check with your local dealer and if they don't have it in stock they should be able to order it.

Master Cylinder:

Don't Ruin Your Master Cylinder While Bleeding. [Editor] Master cylinders can develop a corroded bore outside the area swept by the seals. If you bleed your brakes using the brake pedal, press the pedal only as far as it normally travels and no farther. If the seals enter the corroded area, they will almost instantly tear and the master cylinder will be ruined.

Replacement and Bleeding. [Editor] To replace your master cylinder:

- Spray the brake fittings under the master cylinder with PBlaster. Place rags under the master cylinder to protect your paint (brake fluid dissolves paint).
- Disconnect the brake fittings and 7mm master cylinder mounting nuts.
- [Manual transmission cars] If you have a hydraulic clutch, disconnect its hose from the reservoir and block the hose connection.
- Remove the master cylinder
- Don't consider rebuilding it: buy a rebuilt unit from an auto parts store
- The end of the servo pushrod should extend slightly beyond the face of the servo body by the following amounts:

Models to 1991			Models from 1992+	
	10"	2 X 8"	10"	2 X 8"
Without ABS	2.5mm	2.5mm	2.5mm	2.5mm
With ABS	0.5mm	33.4mm incl spacer	2.5mm	2.5mm

- Install master cylinder and tighten nuts to 23 Nm or 17 ft-lbs.
- Reconnect brake fittings and clutch hose.
- Bleed brakes. To bleed the master cylinder, pressure bleed the system WITH THE OLD PADS until the fluid runs clear, then press the pistons back in the calipers without loosening the bleed screws and install new pads, thereby reverse bleeding the master cylinder. Don't do this on ABS-equipped cars.
- Pressure test by pressing hard on the brake pedal for 30 seconds and inspect the master cylinder for leakage.

Another Bleeding Tip [Brake and Front End Magazine, Apr 09] You can use a blowgun to prime the bores of the cylinder. Place the tip of the blowgun at 90° to the port of the cylinder and blow. The master cylinder should be clamped with the bores in a horizontal and level position and the reservoirs filled to one half full. It is best to start with the port

next to the mounting flange. The low pressure created in the port will draw the fluid from the reservoir into the cylinder bore. You will know when the bore is primed when you see vapor coming from the port. This is all thanks to Bernoulli's Principal. It makes airplanes fly and carburetors deliver fuel. The velocity of the air passing the port is high and the pressure in the port and cylinder bore is low. The high pressure in the reservoir forces the fluid into the cylinder bore and out the port. This is the same principal that makes a carburetor work. The high pressure in the float bowl forces the fuel out of the low pressure created in the venturi.

Brake Hoses

Brake Hose and Line Replacement. [Inquiry:] Can anyone explain the details of replacing brake hoses and lines on a 1985 740? How long can I expect the factory originals to last? Do the hoses suddenly fail when old? [Response:] It is very unlikely that the original hoses will suddenly fail at ages less than 15 or 20 years unless the hose had been subjected to abrasion, cutting, or severe stretching/bending while working on the car. The mode of failure is usually loss of rigidity allowing the hose to 'balloon' under pressure so that the brake system pressure is not completely transmitted to the caliper - result - soft pedal. The other potential mode of failure is that the inner liner of the hose becomes soft and collapses inside the hose - the brake system pressure is transmitted to the caliper, but when the pedal is released, the hose collapses and acts like a check valve keeping pressure on the caliper - result is dragging brakes, overheating and warped rotors, and excessive rotor/pad wear. If your car is more than 10 or 15 years old, check those rubber lines carefully. If there are signs of deterioration, or if you can feel the line expand at all when someone steps hard on the pedal, then it is time to replace. You can buy the IPD DOT approved stainless braided brake lines for about the same price as the Volvo replacement parts.

Tool Requirements. DON'T USE A WRENCH that DOESN'T FIT PERFECTLY!! Don't use an open end wrench, an English 7/16 size, or the wrong metric size (most fittings are 11mm or 14mm); don't proceed until you get a wrench that fits right/tight on that particular fitting. Buy tubing fitting ("flare") wrenches - here it is worth avoiding the cheap grades of flare wrenches, since they are not thick enough and will spread enough to round the nut. Buy a [good professional set](#) such as SnapOn- they will work a lot better, and even though they may cost more than the inexpensive brand, if it saves you one or two fittings, they are well worth it. Don't use a cheater bar on the wrench: you will break off the wrench flats on the fitting. Use hand pressure with the wrench alone. Also, if there is evidence of steel tube twisting as you attempt to loosen, put on more penetrating oil and work it back and forth a very small amount lots of times. It will gradually work loose because the torsion of the tube inside the fitting will crack the rust. Takes lots of patience, but almost always works.

Removal Tips and Frozen Parts. Replacement is straightforward EXCEPT that you will likely find the fittings corroded in place. First clean off the fittings with brake cleaner to expose the threads as best you can. Then soak all fittings with good penetrant like PB 'Blaster' or 'Kroil' several times a day for a week or so prior to trying to remove. This may save some of the fittings and hard lines that you might otherwise have to replace due to frozen fittings. Often the copper tubing seizes in the threaded fitting, a result of corrosion and the soft copper binding. Often breaking the threads loose is the source of rounding or breaking the fitting hex flats, while the line frozen in the fitting causes twisting and failure of the line. Usually, if I can break the threads free, I can get the fitting loose from the line

with persistent back and forth motion and plenty of penetrating oil.

Safety Tip: If you use a torch to loosen the brake hose or line fittings, make sure you wear safety glasses, gloves, and longer clothing to cover exposed skin. The hoses can explode if you overheat them.

[Caveat:] I just finished replacing ALL the metal brake lines in my 740 since I couldn't get the rubber lines off. Soak before trying - but even on my '89 w/original lines I couldn't get them off with a flared open end wrench (they still spread a tiny bit and the old nuts weren't perfect) and rounded a few and the others actually CRACKED off leaving the threaded nipple part inside the rubber line. If you're committed to doing this (i.e., you don't mind going through the hell I went through to replace the metal lines - a lift would have at least helped greatly with the rear ones, but it's the right front caliper lines that are the real PITA) then you can cut the rubber lines on the car near where they connect to the metal lines and then get a socket over what's left to help get a better grip at least there. The big problem is the nut on the metal line. I did manage to get ONE of them free by using PB and heating with a torch. BUT even after I got them off the threads on the nipple weren't very healthy and seemed to thread rather loosely onto the new rubber hose, so I replaced that line too.

[Tip from Mike Missailidis] I can tell you that I successfully removed all six flexible brake lines without ruining even one hard line or flare nut. How? I used a Mac Tools 11mm flare nut wrench, started soaking the fittings once a week for two weeks with PB B'Laster prior to doing the work and used a propane torch to heat the fittings and let cool twice, spraying more PB B'Laster between heating and cooling and tapping on the fittings with a small hammer. Even so, it wasn't easy. [Editor] You can also try the old trick of first TIGHTENING the fitting a slight amount before loosening: this seems to break them free more easily without rounding off. Again, use a top quality flare wrench and tap with a hammer. [Rhys] I wire brush the crud away from the line fittings, and then use a small oxy-acetylene flame to heat the fittings - not to a visible heat of course - just heat them to expand them a bit. Normally I let them cool for ten minutes, then heat them a second time. A high quality flare nut wrench is then applied, and tapped with a hammer. If they move at all, then I apply a penetrating oil, and tighten and loosen the fitting to work the oil into the threads. If that doesn't do it, I tear the lines out and get to work, and make new lines myself. [Don Foster] I've been very successful loosening corroded fittings into flex hoses using an acetylene torch (with GREAT care), fitted with a small tip and using low flame. BUT!!! If you simply heat the flare nut, then the flex hose is very likely to explode (in your face). So, I wrap a sopping wet rag tightly around the flex hose right at its female end (where the line is corroded into it). This absorbs the heat from the flex hose fitting. Then I apply heat quickly to the corroded fitting and loosen using a good flare nut wrench. The 2-3 times I first tried it without the wet rag, the flex hose always exploded. The last 6 times I did it with a wet rag, it worked and the flex hose survived. *If the Hose is Trashed:* [James Souther] What works for me is to cut off the old rubber line by the junction (since it is trash anyway) and use a 6 pt deep well socket to release the joint. I use either a small pipe wrench or a curved jaw vise-grip aka locking plier tool for the other side.

[Inquiry] How do I disconnect and reconnect both redundant brake hoses on the front brakes of a non-ABS 740? The hoses don't appear to be able to pivot, and when I turn one, it curls up like a telephone cord. I'm thinking this can't be good for the hose.

[Response: JohnB] Look back up the flexible hose to where it attaches to a solid line.

Chances are there's a male fitting that screws into the female end of the rubber hose. You first unscrew the male fitting and release the rubber hose from the bracket (generally just pull a U-shaped sheet metal tab. Then you can unscrew the hose(s) from the caliper.

[Caveat:] If you run into problems, you can cut the metal line close to the nut and re-flare it at the end using a new metric European (not Asian) fitting. Two new nuts could be taken off of each short line you purchased and cut (available in 12" lengths.) The line has what is called an "ISO double flare" at 57.5 degrees. I remember that it can be duplicated with a normal flaring tool but takes a bit of talent and practice. It involves a two step procedure. You need a special double flaring tool to do the lines - the normal single flare tool will not do the job. And even with the tool - it takes a bit of practice to get them to come out right consistently. It is a lot easier to use the tool on the bench than it is under the fender of the car on the end of the brake line. It is well worth spending a few hours with penetrating oil and careful working back and forth of the nut than to try to repair a broken line. After replacement, the entire brake system will require flushing/bleeding (Use pressure bleeder like Eezibleed).



Installation Tips for New Hoses. [Zee] Pretty straight forward. I found it good to

1. Place a plastic membrane under the fluid bottle cap for extra suction to prevent fluid from gravity draining as fast while each old flex hose was loosened/disconnected. Open a bleed screw, block the brake pedal down with a wood stick, then close bleeder-to stop fluid loss from the master cylinder while lines are open.
2. It helped to loosen each end of the hose (fittings) to make sure they will let go. If one joint will not, you'll be better off tending to that before loosening or removing any of the others. I didn't need to soak the unions very long in penetrant [but see the cautions above about frozen fittings].
3. Unclip the ABS line (if you have ABS) from the flex hose. It will give you more room to work. Undo the upper end of the hose before the lower end. This makes it easier to unscrew the lower end because you can stand up the hose and rotate the thing.
4. You'll need two 14mm wrenches and an 11mm. Use quality flare wrenches to prevent rounding the fittings.
5. Use a large catch basin and some cardboard under it on the floor. You won't expel a lot of fluid, but this does leave a mess. [Art Benstein] Insert a sharpened golf tee in the end of the line or hose to prevent fluid loss.
6. First remove the hose at the brake line end, then at the caliper side.
7. Think about a way to "fill" the new hose with brake fluid before bleeding that column of air into a perfectly bled caliper. Even though you need to screw the lower end onto the caliper before joining the top end to the flare nut hard line, you can leave the lower end loose, connect the top, then let gravity bleed some brake fluid into the new hose to fill it just before tightening it to the caliper. It will minimize the amount of air you will introduce to your system. Clean up the caliper area later with a shot of brake cleaner.

Replacement Brake Lines. [Rob Bareiss]

Volvos and almost all European cars use the ISO 57.5 degree "double flare" lines- the end flares out and back in. It almost looks like a rivet. The fittings are European (not Asian) metric. When sourcing new lines, it's best to have the old

lines in hand unless you're sure what you're looking for. Dealers, most auto stores and Internet Volvo aftermarket retailers stock straight lengths of made-up brake lines as well as the correct hoses.

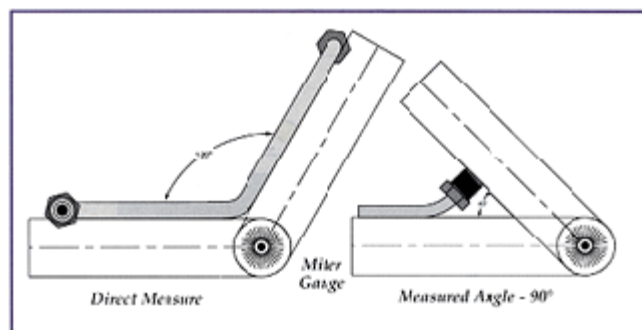

The length and bend at the flared fitting connection is important to prevent cross threading the fitting when the line is installed.

[Editor] The Volvo OEM brake lines are made from a copper-nickel alloy which is very resistant to corrosion, softer, and easier to bend. Dealers can obtain the exact replacement line for your application, pre-flared and ready to install. More expensive but far easier than adapting an aftermarket tube. [Adapted from Brake and Front End Magazine, Aug 04] Most jobbers stock pre-cut lengths of tubing with a flared connection on both ends. These pre-cut lines can be used to fabricate a replacement. With the proper tools and practice, the damaged lines can be duplicated from the pre-cut tubing.

Tube bending is part tool and part black art. The tool part is a bender that has the three following components: a bending die, a following die and a latch or fixture to hold the tube to the bending die. The purpose of the bending and following die is to maintain the diameter of the tube as it is bent to a specific angle. The black art is measuring the length between bends and bending to the correct angle. The length and bend at the flared fitting connection is important to prevent cross threading the fitting. You can "eyeball" it and use your bending tool to fabricate the line. When using this method, bend a little and compare a lot. Angles at the flared end of the tubing can be measured using a protractor and a piece of bar stock or a miter gauge. Brake fitting threads, by the way, are 10mm x 1.00mm pitch.

Preventing Fluid Loss from the Master Cylinder While Replacing Hoses or Calipers.

[Bruce Young] You can prevent master cylinder brake fluid loss from any/all open brake line(s) by blocking the brake pedal depressed before you start. Disconnect the battery (or pull a fuse) to keep brake lights off while the pedal prop is in place. The 700/900 Green Book shows the 700/900 pedal *fully depressed* by a special tool (easy to replicate with a 2x4, etc.). The book also says to open a bleeder first, and use a tube and container to catch the fluid that's expelled when the pedal is being depressed. I made a wooden prop that hooks to the bottom edge of the pedal and bears against the seat adjuster bar.

Brake Hose Deterioration and Brake Binding. [Inquiry] My front brakes are dragging - both sides and quite severe. On the right side the pads are worn evenly and the pistons move freely. How can I check the brake line for internal swelling/collapsing?

[Tip from Herb Goltz] An old brake hose acting like a one-way valve is a very common problem. The inside of the hose rubber deteriorates, creating a flap internally that blocks the return of fluid when the brake pedal is released, causing dragging brakes, warped

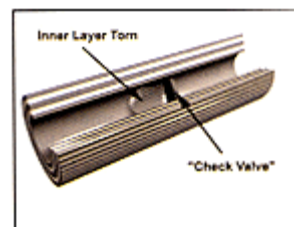

Fig. 7: Occasionally, the inner layer of a hose will tear or separate and form what is commonly referred to as a "one-way check valve".

rotors, and pad wear. Many "dragging" calipers get replaced for this reason.

[John Randstrom] The easiest way to check for a bad brake hose is to pump and release the brake pedal, then open the bleeder screws on the caliper. If pressurized fluid escapes the hose is bad. I have had quite a few hoses that were bad that caused a caliper to drag.

[Colin] Apply the brake a few times to get the brakes binding and then slacken the bleed nipples. If you get a spurt of fluid and the brake frees off you have a restriction preventing fluid returning back to the master cylinder reservoir. This could be brake lines or master cylinder. Do the same again but slacken the lines at the master cylinder this time, instead of the bleed nipples. If both brakes are binding equally it's more likely to be a master cylinder problem.

Troubleshooting:

Low Pedal and Soft Brakes Problems.

Low Pedal After Pad Change:

[Inquiry] I recently replaced the front pads on my Volvo. Now I have excessive travel of the pedal. I've tried bleeding the system with no luck. I assume there is air in there somewhere but can't f

[Response: Bob Dietz] Usually the wear lip on the rotor holds the pads away from the braking surface. Until the pad wears in the pedal will stay low. Additionally different brake pad compounds have a different pedal feel.

Bleeding for Soft Pedal:

[Excerpts from "Low Pedal Blues" by Bob Freudenberg, Motor Service magazine, Feb 00] You can find out all you need to know about the master cylinder by removing the lines, screwing brass or plastic plugs (either ISO or double flare) into the outlets, then applying the brakes. If the pedal's high and hard now, the master's properly bled and its seals are okay because, as we said, the pedal would sink gradually if it were bypassing. You have also confirmed that the booster's okay.

Continue in this process of elimination by capping lines or clamping hoses to isolate the wheels (clamp with a suitable rounded-jaw tool, please, not sharp-toothed Vise-Grips, or at least use heater hose to pad the jaws of whatever type of squeezing device you choose). Releasing one at a time should locate the problem.

When it comes to the bleeders at the wheels, we know most of you just open them and let

the fluid squirt. But that's thoroughly uncraftsmanlike. Not only will it make slippery puddles on the floor, it can shoot farther than you might expect (how about the 2,500+ psi of line pressure on some ABS-equipped cars?), perhaps ruining the paint on the car in the next bay. We use a tube and transparent bottle (which attaches to the chassis with a magnet) half full of fresh fluid because it's neat and it lets us see what we're getting out. Also, it eliminates the need for a helper if we're not using a pressure bleeder.

Hard Pedal Problems and Brake Booster Diagnosis. [Inquiry] My turbo's brakes feel like there is no engine assistance because the pedal is very difficult to push with minimal effect. [Response: Colin Shepherd] it sounds as if the servo/booster is not working . To test it, turn the engine off and pump the pedal half a dozen times to exhaust any residual vacuum. Then, maintaining a steady pressure on the pedal, start the engine. The pedal should sink about 1/2" as the vacuum does its work. If nothing happens, carefully pull the white vacuum check valve on the front of the booster out of its seal and see if there is vacuum at the servo/booster side of the valve with the engine running. If you don` t have vacuum there, either the valve is stuck shut, or you have a blockage in the plumbing. You should be able to get the valve as a separate part. Be very careful pushing the valve back in as the seal can be pushed back into the inside of the servo. If it turns out to be a faulty servo then it` s time for a a second mortgage, or a trip to the breakers yard !!!

[Inquiry] My 740GL has a soft pedal and air noise (like air escaping).

[Response: Bob & KSwan] First, visually inspect the vacuum hose and the check valve on the brake booster inside the engine compartment for damage. The valves are plastic and can get brittle over time. Next, pump the brake pedal 5 or 6 strokes to bleed off any vacuum. Now hold the pedal to the floor, and start the car. The pedal should drop a bit as vacuum builds. Hold pedal down and stop engine. Pedal should stay down. If it tends to push against your foot, you have a leak. If you can hear it inside, odds are the booster diaphragm is leaking. But try the check valve route first. Note, NEW boosters are \$400-500. They fail rarely so a used one will do.



Replacing the Booster. [Paul Golden] Replacing the booster takes about an hour and a half or less. Remove four nuts on the inside of firewall, the brake pin, two nuts for the master cylinder and gently pull the m/c out of the way. The booster comes out at a slight angle

Leaking or Missing O-Ring. [Tip] My car always suffered from hard pedal, but after investigating I found a missing o-ring between the master cylinder and the booster. Replacing this 5cm o-ring solved the problem.

Brakes Pull When Applied: Control Arm Bushings

[Inquiry:] Brakes seem to pull for an instant upon first application giving the steering wheel a small jerk when brakes first applied. Recent brake pad replacement and rotors turned seemed to help somewhat but did not cure problem. [Response 1: Steve Seekins] This is the classic symptom of bad radius rod to control arm bushings. There are 2 cone

shaped bushings at the front end of each radius rod where they connect to the control arm. Easily replaced, be sure you get the newer more durable ones. Also, when replacing, be sure to clean out the holes in the control arm of ALL corroded metal and rubber residue from the old bushings. Also, do not do final tightening of the bushing bolts at either end of the radius rod until the car is on the ground and the suspension fully loaded and settled - otherwise you risk premature failure of the new bushings. See [Radius Arm Bushing Replacement](#)

Brake Calipers Rattle on Mounting Bolts.

[Inquiry:] I have a '89 745GL with 226K miles and the brake calipers on both front wheels are rattling. I can jiggle them ever so slightly with my hands. The Volvo dealer says that this is a wear sign with so many miles on the car; I have only had the brake pads replaced when needed throughout the life of the car and I am the original owner. The dealer said that over time the bolt holes attaching the calipers to the car wear and get larger; it is not a safety concern but the only cure for this 'rattling' is to replace the calipers. This seems like an expensive fix and when I suggested that we get bigger bolts, they laughed. Any advice?

[Response:] There is an updated set of caliper slide pins, at least for Girling front calipers. I know, since I installed them on my car. As I recall, they meant to fix rattling calipers (and perhaps something else as well.) There was a Technical Service Bulletin to this effect, which is how I found out. Talk to a different mech/dealer. Sounds like your current mech/dealer is perhaps not aware of this fix. [Editor's Note:] This is Volvo TSB 51907, Feb 94. See also TSB 518910401, Apr 91 if you have Bendix calipers. Make sure your slide pins are adequately lubricated as well with top quality brake grease.

Pulsating Brakes: Runout in Hub and Rotor

[Tip from Don Willson] For 9 months I have been fighting pulsing brakes with 2 rotor turnings and freeing up the caliper pins. I was about ready to go buy new rotors but first I thought I would see how "wobbly" they were. I put a dial indicator on and found they were 0.006 inch and 0.008 inch runout. I cleaned the hub and inside of the rotor. Then I put the rotor on and tightened it down in each of the 5 positions, and on the opposite wheel. I found a position where the runout was least, about 0.003 to 0.004 inch, and reassembled the wheels. On a run around the block if felt good, I'll go make a highway run and see if it helped. The Volvo spec is 0.003 inch maximum runout.

[Response 2: Ross Gunn] I am a believer in the the importance of careful torquing of the wheel nuts. Regardless of the shape of the discs, I still believe that over-torque or uneven torque can preload the discs and then when they are heated through heavy braking, they can take a permanent set. This is just a conclusion I have come to after experiencing new discs that were OK for the first while and then began to wobble after some use (1000 or 2000 km.) I also have used a dial test indicator to find the best position of the discs and agree to the effectiveness of this method in getting a smooth feel. Sometimes a piece of aluminum foil added strategically between the hub and the wheel can help. Too bad the hubs can't be manufactured truer (more true? - more truly? - with less runout!).

[Editor's Note: See also [Brake Rotor Installation Techniques to Minimize Pulsation](#)]

[Response 3: George Downs] My second 122 had BENT front hubs! I had them trued at a

machine shop which brought the runout from 0.080 down to about 0.010". The disks were perfectly true. I finally got them down to 0.001" runout by sticking pieces of feeler stock between the disks and hubs in a trial and error method. I have not the faintest idea how they got that way but the PO had given up on ever having reasonable brakes.

Brake Rotor Pulsation: Causes. [Comments from Wagner Brake div. Of Cooper Industries:] Brake rotor thickness variation causes brake vibration due to changes in the braking force as thick and thin portions of the rotor pass between the pads. Eric Smith, Senior Instructor for Wagner Brake at the Moog World Training Center in St. Louis, says technicians sometimes pin the blame on a defective rotor, but often it's due to excessive system run-out, which has not been checked by the technician.

Smith says the run-out will cause the rotor to wear itself out of parallel, and is why turning or replacing the rotor won't solve the problem. System run-out can be caused by poor mating of flanges between the hub and rotor when assembled as a unit (by excessive rust, preventing a clean fit of the rotor on the flange), excessive run-out and even improper torquing of the wheel bolts. Once the rotor heats up during operation, if one lug is a little less tight than the others, the rotor will expand at that point and cause run-out, says Smith. Compounding this is the fact that the brake might only have run-out when the rotor is hot. When the customer takes the car back to the shop, it's cooled when checked by the technician and by that time the run-out disappears. If not corrected, though, it will eventually have a permanent run-out, and be worn out of parallel.

Make sure rotor run-out is below specifications before reinstallation; also make sure the hub is clean and rust free before installing the rotor. System run-out should be checked after installing the rotor (new or turned). If run-out is above spec, the solution may be as easy as re-indexing the rotor one stud at a time, until run-out is within spec. It may also be necessary to replace the hub assembly. And see [below](#) for tips on front end shimmy and vibration, which can feel similar to brake problems.

960/90 Series Pulsation Problems: Runout Issues.

[David Aidnik] I have two '94 960 wagons, and I have been less than satisfied with the pulsations during braking that are more or less notable on the two cars. Over the years of browsing this board for clues and answers, I have seen various possible causes, most of which allude to warped rotors or front control arm bushings.

These are true and reasonable clues, but the real culprit is the design itself: the braking force of the front brakes is transmitted directly to the car body through the control arm in compressive force. This direct transmission of the braking force straight through the axis of the control arm makes for a harsh transmission of road shock and any uneven forces of the pads/caliper and rotor. The requirements of measured runout at the rotor are quite stringent to minimize any pulsations.

Measured runout of even 0.0005 inch can be just barely discernable as pulsation in some conditions. This leads me to the conclusion that to do the brakes right or well when you replace the pads on this design requires that you have an indicator and a magnetic base to hold it to enable you to accurately measure the rotor runout.

After you take the caliper off the wheel mount, mark the hub & rotor positioning so you know how they were lined up before. Then take the rotor off the hub & clean both the mating faces of the hub & the rotor as best as possible using a wire brush & steel wool.

While you're there, you can also clean out the wheel sensor magnet and the brake dust off the hub. Then measure the runout. I started with the original position and tried several others of the five possible positions. At each, you make sure that there is no dust or dirt on the mating surfaces of rotor or hub, then carefully push it straight on and put three lug nuts on, snugged without moving the rotor. Then measure the runout near the center track of the brake pad. Hopefully you can find a position that gives 0.0005 inch or less.

You can reduce runout by careful cleaning of the rotor and hub mating surfaces: I reduced mine from 0.0015 to 0.0005 just by cleaning. Volvo manuals show a machine for double-grinding of rotors on the car. This is an indication of the sensitivity of this design to rotor runout.

Intermittent Brake Failure: Bad Sensor Seal. I was losing brake fluid because the brake failure sensor block's switch *seal* had deteriorated. The brake failure light had never illuminated and the entire brake system was in excellent working order. I'd noticed the fluid level in the reservoir dropping slowly; eventually would have aerated the master cylinder with consequent problems. The brake system has been fine and leak-free for the last 20K miles. [Also:] the whole 8-way distributor/brake warning thing is very expensive. The plastic plug/switch is not intended to seal against the hydraulic pressure, that is done (or not) by seals on the piston, changing the plastic plug will not stop the leak.

Wheel Shudder: Diagnosis

[Inquiry:] Has anybody ever had a problem when a steering wheel shakes anytime you brake on speeds higher than 30 mph? It seems to be brake rotors' uneven wear.

[Response: Paul Grimshaw, alt] Shaking under braking is usually associated with warped rotors. In Volvo cars, warping normally occurs if the wheel lug nuts have been improperly torqued or brakes have been over-heated or if they have been subjected to a number of heating and cooling cycles after having been machined. For this reason, it is always best to resist having the rotors turned and purchase new rotors anytime symptoms like you described are noted. Uneven wear on the rotors can only be confirmed by a dial caliper, just as rotor thickness can only be accurately judged by using a micrometer. For handy reference, Volvo rotors have the minimum rotor thickness value stamped on the rotor hat -- any rotor that has become thinner than specified should be replaced.

Uneven or excessive torquing of the wheel lug nuts can also warp rotors. One should always tighten the wheel nuts with a torque wrench to avoid over stressing the stud/nuts (900-series and older) or bolts (800-series and higher). See the [procedure tips](#) in Wheels.

Although brake rotor faults are the most common cause of what you describe, [worn bushings](#), [tie rod ends](#), [ball joints](#), or even [tire faults](#) cannot be ruled out either. See the FAQ [reference](#).

Brake Shuddering and Suspension Bushings. One reason we got some shuddering on braking our '90 745 was that the suspension bushings were shot. Those conical rubber bushings on the lower control rod where it enters the main lower suspension arm take a beating under braking, and eventually allow quite a bit of fore and aft movement of the wheel. Maybe the rotors are warped, but, especially if you get shaking without brake pedal

pulsing, could it be bushings? They're cheap, and take about an hour to do.

Wheel Lockup. [Problem:] I am having the left rear wheel lockup when braking hard on wet pavement. [Diagnosis:] Calipers are a common source of sticking brakes. On rare occasions this has been caused by degraded brake hoses. If your 740 is still running its original brake hoses now would be a good time to replace them before bleeding the brakes. What sometimes happens is that the inside of the hose swells up enough to form a rubber one-way valve where there should only be straight hose.

Brake Light "On" After Bleeding.

[Inquiry:] I just replaced the front brake pads on my 1988 740 GLE wagon. I bled the front brake lines and the brakes seemed to work well except that the brake light came on during hard stops. So I bled the entire system and replaced the entire volume of brake fluid. The brakes work very well now except that the brake light is on constantly. What is going on?

[Response 1: Stefan Schader] During your bleeding process you probably created a pressure imbalance in the dual brake system setting off the light. This light is activated when the floating balance piston moves to one side. Then a plunger drops activating the light and preventing the piston from going back to its neutral position. To reset this, unscrew the brake failure light sensor and then press the brake pedal to reset the piston to neutral. Then remount the sensor switch.

[Response 2: Peter James] You will need to undo the brake failure sensor switch and allow the piston to centralise before refitting the switch. If there is fluid present when you remove the switch from the junction block (in front of the passenger on the inner guard down towards the bottom) on RH drive cars (drivers side US) you will have to disassemble the block and renew the 2 "O" rings, tightening the switch will not work!

Front Brake Squealing on 92-95 940/960.

Volvo has come up with a shim kit (Part No. 272187-6) to correct this. Before installing the kit, though, here are a few things to check: If the caliper piston doesn't spring back when pressed in, replace the caliper; if the caliper dust seal has been corrupted and dirt got in, either rebuild or replace the caliper; if there's rust on the caliper, especially the guides, clean it up. Finally, install the shims to the upper section of the brake pad backing plates where the piston makes contact.

Brake Reservoir Seal Failure. Here's an interesting old car failure, perhaps something to put on the 10 year list and/or an FAQ for bricks:

The brake fluid in my master cylinder reservoir kept going down slowly over a few weeks...wouldn't leak fast enough to tell where it was going so I just kept adding fluid and looking. Now I see it appears to be coming from the seal(s) between the master cylinder reservoir and the master cylinder. Since this type of construction seems to be more and more the norm (a lot of old cars had integral reservoirs but that weighs a lot more) this is something to look for. The seals cost about \$7 apiece on my application (need 2) so it looks like a little job this evening--one of the few jobs no tools required, if I'm lucky and

the reservoir is self bleeding...If I may add a bit of cautionary advice to this, especially for older cars where the reservoir may be becoming somewhat brittle:

- Never lean on the reservoir or grab a hold of it to anchor yourself when applying wrench torque to something else under there.
- If your seals have begun to leak, be **very** careful when you remove the reservoir since it can be brittle.
- Until you get around to doing it you might find that two plastic zip ties over the top of the reservoir and under the master cylinder with a third horizontally around the reservoir (to hold the other two so that they do not slip off of the ends) will temporarily stop the leak.
- Push the reservoir over to one side to get it started, rather than prying straight up. Carefully pop the reservoir out and replace the seals.

Upgrading:

Stainless Steel Braided Lines.

Part Compatibility. IPD lists the stainless brakes lines for 740/760 1983-1987. Also for 740 with ABS from 1988-1991. As this excluded BOTH my '90 745 and '92 745T I asked them why. Basically the reply was, because they had an omission in the catalog (for the non-ABS models) and couldn't find a cross-reference for the ABS model. The 1983-1987 option, IPD model CG5205(non-ABS) is actually good up to model year 1992, and is printed that way on the lines (at least, since I'm guessing the 940's shared brake lines with one of these two categories of 740s). On the 1988-1991 w/ABS models, IPD model CG5206 was compatible with Volvo part number 1329611 (front) and 1329594 (rear). If anyone knows if these two Volvo parts correlate to other/later brake lines in the 7/9 series, please let me know.

Upgrading Older 7XX Brakes to Big Brakes or Later 9XX Jumbo Brakes.

[Inquiry] I've heard that fitting the "Jumbo" brakes from the 900 series on my 88 740 Turbo will help/cure the "warping problem". Three questions: a) Does anyone have a detailed parts list for the job ? b)Is there a reason NOT to do this ? and c)Can anyone supply step-by-step instructions for the job ?

Background. [John Sargent] There are two kinds of large-capacity brakes: "Jumbo and "Big" brakes. Jumbo brakes only came on ABS cars and they are all single piston/single brake line calipers using 11 inch, one-inch-thick rotors and larger pads. Big brakes (11.25" diameter) have different calipers, caliper holding brackets, and smaller pads than the Jumbo brakes. To upgrade an ABS car with either 10.25" or 11.25" rotors to Jumbo brakes you need calipers, caliper holding brackets, pads, and rotors, as noted below. The brake calipers do not bolt directly to the strut: a caliper holding bracket (or Jumbo Brake Bracket) is needed to mount the caliper to the strut. To upgrade a non-ABS car to Jumbo brakes, you need the same parts and two brake master cylinder plugs. You will be removing two brake lines and hoses, noted in the second section below. Jumbo Girling brakes with 11 inch rotors use the 1198 brake pad. The Girling brakes for both 11.25 inch (we call them the Big brakes) and 10.25 inch rotors take the 508 pad. ABS makes no difference on the pad use for Girling 11.25" and 10.25" rotors. [Tim] If you visit a pick-n-pull boneyard for parts, remember to take along a 10mm allen socket to pull the 2 bolts

that hold the caliper brackets in place.

Conversion for Cars with ABS:

[Response: Abe Crombie] I have done this to my parents' 88 764 turbo. It requires left and right calipers from a 92-94 960 or 92-95 740/940. It requires two rotors. The hubs are the same and the brackets on a complete caliper with slides/mounts will bolt with no mods to your struts at the same attaching points. The brake hoses are a direct fit to the newer calipers. I'm not so sure that the bigger brakes will fit if you have 14" wheels though. All jumbo brake 700/900 have 15" wheels and there are some references in parts catalog to differences in 91 and older with 14" brakes and 15" brakes. Their car does seem to have better brakes and it has had no trouble with brakes in the 50-60K miles since swap was made. I got all the pieces from a salvage parts place from a front-end total that had no useable front suspension pieces and had just arrived and had not been picked over.

[Inquiry:] I assume all the 92+'s have ABS as my '89 does? How are the rotors different (mine currently has the larger of the two available sizes - do I still need to change)?

[Response: Abe Crombie] The offset of the "jumbo" brake rotors are different and you will have to change the rotors as a result. The 95 to 98 960/s-v 90 are also different so don't get parts from one of those models.

Conversion for Cars without ABS:

[John Sargent] In order to upgrade your non-jumbo brakes to jumbos with larger rotors, you replace the calipers, rotors and pads with jumbo units from any of the following cars (as described above): a 1992 -1995 940; 1991-1992 turbo 740; 1992-1994 960. You will have to plug one brake line on non-ABS cars, since you are changing from a dual circuit to a single circuit for each front caliper. See the illustrations and procedures below. This conversion works whether you originally have Bendix or Girling brakes.

1. Re-Using Your Present Calipers and Installing Larger Big Brake Rotors

Girling Calipers. You can convert your 700 series cars with non-ABS Girling brakes to Big brake 11.25 inch rotors. These 700 series cars without ABS originally had 10.25 inch diameter discs. The 87 and earlier models were originally one piece disc and rotor, but many have been converted to 2 piece hub and rotor. If you have an 88, or later, you already have 2 piece hub and rotor. All you need are the caliper holding brackets from a 700 series with Girling ABS brakes (all ABS brakes appear to be 11.25 inch diameter, but a few early ABS cars have the 10.25 inch rotors), or the caliper holding brackets from a late model 700 series with the large discs, and new 11.25 inch diameter discs. You will use the same part number pads, but get some new ones. Remove the Girling caliper from your car. Now remove the caliper holding bracket from the strut, and discard it. Remove and replace the disc. Install the new caliper holding bracket from the donor car with Girling 11.25 inch diameter brakes. Reinstall the caliper with new pads. Wheel nut torque (63 ft-lbs) is very important on these cars. Uneven torquing will contribute to brake pedal pulse, and uneven wear of the disc.

Bendix Calipers. You can install the big brakes (11.25 inch diameter front rotors) on the early 700 series which are equipped with the small (10.25 inch diameter) rotors on the front with Bendix calipers. Assuming that you already have the separate hubs and rotors with your 10.25 inch diameter front Bendix brakes, all you need are the caliper holding

brackets for Bendix and the larger (11.25 inch diameter rotors). It is quite easy and does not involve opening the hydraulic brake lines like the installation of the Jumbo brakes on my 1987 745T. If you don't already have the separate hubs and rotors, the separate hubs can be purchased inexpensively from a wrecking yard.

2. Replacing Your Non-ABS Calipers with ABS Jumbo Calipers, Pads and Rotors

The Jumbo caliper brakes do provide more stopping power than the larger rotor Big brakes. The Jumbo brakes weigh a little more than the Big brakes, so you have a little more unsprung weight which is a very slight drawback.

Ordinarily a non-ABS Volvo has a dual master cylinder with dual front piston calipers. The pistons in these non-ABS calipers are hydraulically isolated from each other. Each brake circuit in a non-ABS car takes care of a front piston on each side and one rear piston. The Jumbo brakes are single piston, single line calipers and you must disconnect and plug two brake lines which connect to the front calipers. When done with this conversion from non-ABS to Jumbo brakes, you have regular dual circuit diagonal brakes just like about every other car which I am familiar with.



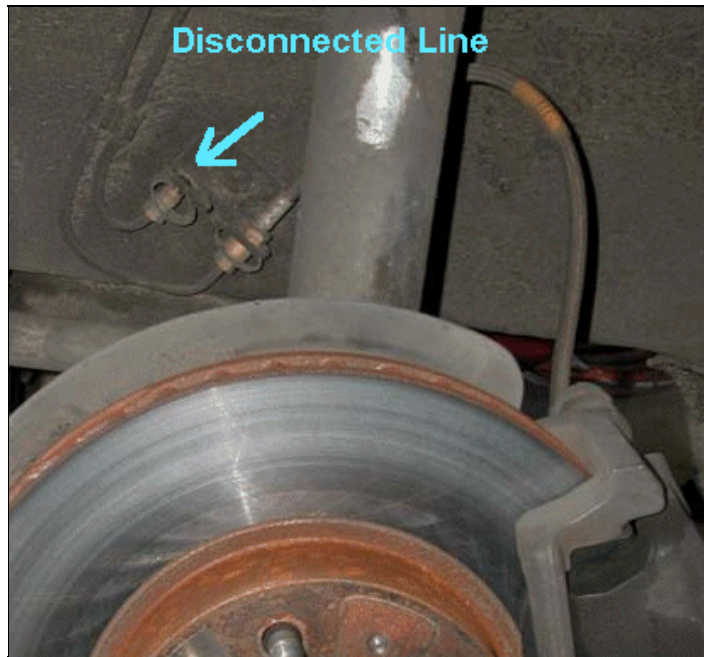
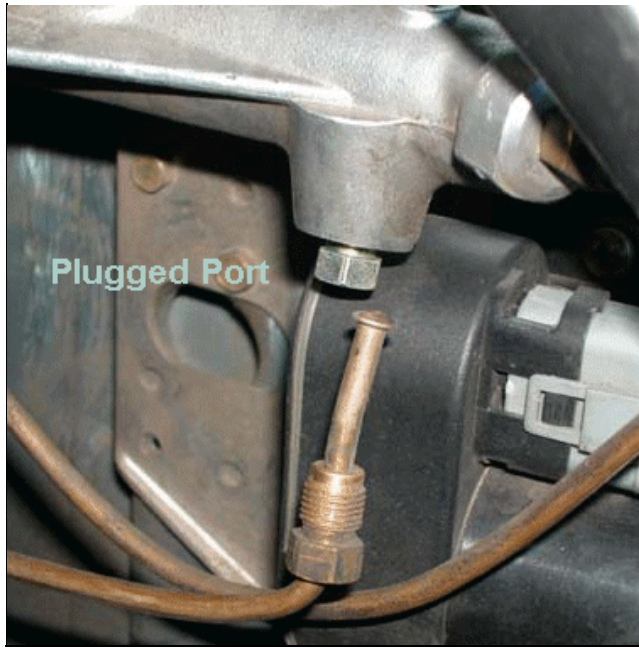

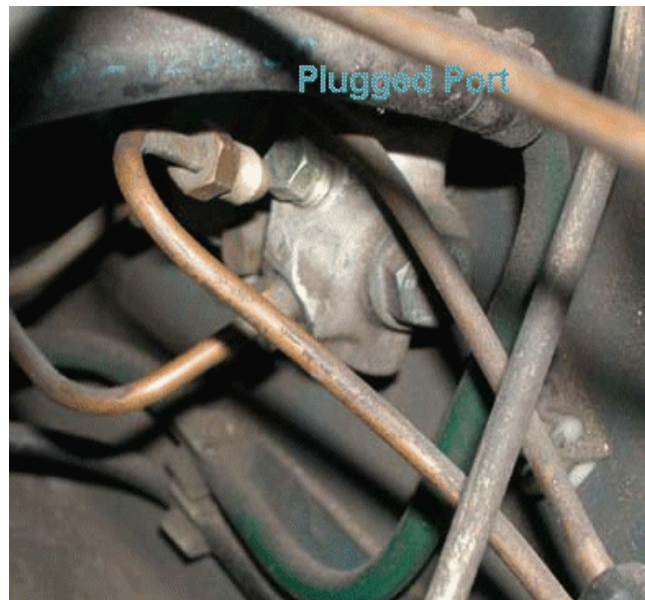

Parts needed include two ATE brake port plugs part number 1387506; the 11 inch Jumbo rotors; the Jumbo calipers from a 900-series car; and new 1198 pads for the calipers. You must disconnect two brake lines, one to the right brake at the master cylinder and one to the left brake at the brake junction block. Plug these ports. See the illustrations for information. Then remove the existing calipers, brackets, and rotors. Install the jumbo brackets to the strut bottoms, then the new 11 inch rotors and jumbo calipers. Install new 1198 pads.

Torques Table

Bolt	Torque Nm	Torque Ft-Lbs
Front brake caliper mounting bolt	100	74
Lower guide sleeve bolt (Bendix DBA)	34	25
Guide pin for Bendix caliper retainer	25	18.5

Guide pin screws upper/lower for Girling 2-piston caliper	34	25
Guide pin screws upper/lower for Girling single piston caliper	27	20
Rear brake caliper mounting bolt	58	43
Rear guide pin screws Girling w/ multilink axle	34	25
Master cylinder mounting nuts	14	10
Brake servo mounting nuts	14	10
Bleed screw (M8)	4.5	3.5
Bleed screw (M10)	10	7.5
Brake hoses to nipple	18	13
Brake rotor locating pin	8	6
Wheel lug nuts	85	63
ABS sensor rear multilink axle housing	8-12	6-9

For bolts not listed, snug them up. If they are safety critical, use Loctite.

[Volvo Maintenance FAQ for 7xx/9xx/90 Cars](#)
