

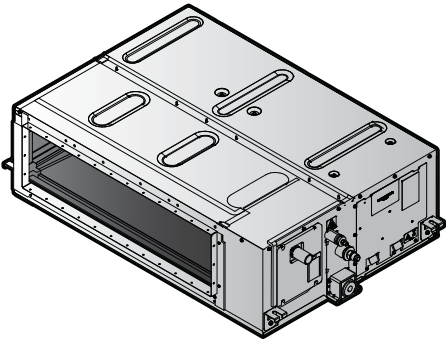

Installer and user reference guide  
VRV system air conditioner



FXMA50A5VEB  
FXMA63A5VEB  
FXMA80A5VEB  
FXMA100A5VEB  
FXMA125A5VEB

# Table of contents

<b>1</b>	<b>About the documentation</b>	<b>4</b>
1.1	About this document .....	4
<b>2</b>	<b>General safety precautions</b>	<b>5</b>
2.1	About the documentation .....	5
2.1.1	Meaning of warnings and symbols .....	5
2.2	For the installer .....	6
2.2.1	General .....	6
2.2.2	Installation site .....	7
2.2.3	Refrigerant — in case of R410A or R32.....	7
2.2.4	Electrical .....	9
<b>3</b>	<b>Specific installer safety instructions</b>	<b>12</b>
3.1	Instructions for equipment using R32 refrigerant .....	14
3.1.1	Installation space requirements.....	16
<b>For the user</b>		<b>17</b>
<b>4</b>	<b>User safety instructions</b>	<b>18</b>
4.1	General.....	18
4.2	Instructions for safe operation .....	19
<b>5</b>	<b>About the system</b>	<b>24</b>
5.1	System layout.....	24
5.2	Information requirements for fan coil units.....	25
<b>6</b>	<b>User interface</b>	<b>26</b>
<b>7</b>	<b>Before operation</b>	<b>27</b>
<b>8</b>	<b>Operation</b>	<b>28</b>
8.1	Operation range.....	28
8.2	About operation modes.....	28
8.2.1	Basic operation modes .....	28
8.2.2	Special heating operation modes.....	29
8.3	To operate the system .....	29
<b>9</b>	<b>Energy saving and optimum operation</b>	<b>30</b>
<b>10</b>	<b>Maintenance and service</b>	<b>31</b>
10.1	Precautions for maintenance and service .....	31
10.2	Cleaning the air filter and air outlet .....	32
10.2.1	To clean the air filter .....	32
10.2.2	To clean the air outlet .....	33
10.3	Maintenance before a long stop period.....	33
10.4	Maintenance after a long stop period.....	34
10.5	About the refrigerant.....	34
10.5.1	About the refrigerant leakage sensor .....	35
<b>11</b>	<b>Troubleshooting</b>	<b>37</b>
11.1	Symptoms that are NOT system malfunctions.....	38
11.1.1	Symptom: The system does not operate .....	38
11.1.2	Symptom: White mist comes out of a unit (Indoor unit) .....	39
11.1.3	Symptom: White mist comes out of a unit (Indoor unit, outdoor unit).....	39
11.1.4	Symptom: The user interface reads "U4" or "U5" and stops, but then restarts after a few minutes.....	39
11.1.5	Symptom: Noise of air conditioners (Indoor unit).....	39
11.1.6	Symptom: Noise of air conditioners (Indoor unit, outdoor unit) .....	39
11.1.7	Symptom: Dust comes out of the unit.....	39
11.1.8	Symptom: The units can give off odours .....	39
<b>12</b>	<b>Relocation</b>	<b>40</b>
<b>13</b>	<b>Disposal</b>	<b>41</b>
<b>For the installer</b>		<b>42</b>

<b>14 About the box</b>	<b>43</b>
14.1 Overview: About the box .....	43
14.2 Indoor unit .....	43
14.2.1 To unpack and handle the unit .....	43
14.2.2 To remove the accessories from the indoor unit .....	44
<b>15 About the units and options</b>	<b>45</b>
15.1 Identification .....	45
15.1.1 Identification label: Indoor unit .....	45
15.2 About the indoor unit .....	45
15.3 System layout .....	45
15.4 Combining units and options .....	46
15.4.1 Possible options for the indoor unit .....	46
<b>16 Unit installation</b>	<b>48</b>
16.1 Preparing the installation site .....	48
16.1.1 Installation site requirements of the indoor unit .....	48
16.2 Mounting the indoor unit .....	51
16.2.1 Guidelines when installing the indoor unit .....	51
16.2.2 Guidelines when installing the ducting .....	53
16.2.3 Guidelines when installing the drain piping .....	55
<b>17 Piping installation</b>	<b>59</b>
17.1 Preparing refrigerant piping .....	59
17.1.1 Refrigerant piping requirements .....	59
17.1.2 Refrigerant piping insulation .....	60
17.2 Connecting the refrigerant piping .....	60
17.2.1 About connecting the refrigerant piping .....	60
17.2.2 Precautions when connecting the refrigerant piping .....	61
17.2.3 Guidelines when connecting the refrigerant piping .....	62
17.2.4 Pipe bending guidelines .....	62
17.2.5 To flare the pipe end .....	62
17.2.6 To connect the refrigerant piping to the indoor unit .....	63
<b>18 Electrical installation</b>	<b>65</b>
18.1 About connecting the electrical wiring .....	65
18.1.1 Precautions when connecting the electrical wiring .....	65
18.1.2 Guidelines when connecting the electrical wiring .....	66
18.1.3 Specifications of standard wiring components .....	67
18.2 To connect the electrical wiring to the indoor unit .....	68
<b>19 Commissioning</b>	<b>70</b>
19.1 Overview: Commissioning .....	70
19.2 Precautions when commissioning .....	70
19.3 Checklist before commissioning .....	71
19.4 To perform a test run .....	71
<b>20 Configuration</b>	<b>72</b>
20.1 Field setting .....	72
<b>21 Hand-over to the user</b>	<b>78</b>
<b>22 Troubleshooting</b>	<b>79</b>
22.1 Solving problems based on error codes .....	79
22.1.1 Error codes: Overview .....	79
<b>23 Disposal</b>	<b>81</b>
<b>24 Technical data</b>	<b>82</b>
24.1 Wiring diagram .....	82
24.1.1 Unified wiring diagram legend .....	82
<b>25 Glossary</b>	<b>85</b>

# 1 About the documentation

## 1.1 About this document



### INFORMATION

Make sure that the user has the printed documentation and ask him/her to keep it for future reference.

#### Target audience

Authorised installers + end users



### INFORMATION

This appliance is intended to be used by expert or trained users in shops, in light industry, and on farms, or for commercial and household use by lay persons.



### WARNING

Make sure installation, servicing, maintenance, repair and applied materials follow the instructions from Daikin and, in addition, comply with applicable legislation and are performed by qualified persons only. In Europe and areas where IEC standards apply, EN/IEC 60335-2-40 is the applicable standard.

#### Documentation set

This document is part of a documentation set. The complete set consists of:

- **General safety precautions:**
  - Safety instructions that you must read before installing
  - Format: Paper (in the box of the indoor unit)
- **Indoor unit installation and operation manual:**
  - Installation and operation instructions
  - Format: Paper (in the box of the indoor unit)
- **Installer and user reference guide:**
  - Preparation of the installation, good practices, reference data,...
  - Detailed step-by-step instructions and background information for basic and advanced usage
  - Format: Digital files on <http://www.daikineurope.com/support-and-manuals/product-information/>

Latest revisions of the supplied documentation may be available on the regional Daikin website or via your dealer.

The original documentation is written in English. All other languages are translations.

#### Technical engineering data

- A **subset** of the latest technical data is available on the regional Daikin website (publicly accessible).
- The **full set** of latest technical data is available on the Daikin Business Portal (authentication required).

## 2 General safety precautions

### 2.1 About the documentation

- The original documentation is written in English. All other languages are translations.
- The precautions described in this document cover very important topics, follow them carefully.
- The installation of the system, and all activities described in the installation manual and in the installer reference guide **MUST** be performed by an authorised installer.

#### 2.1.1 Meaning of warnings and symbols



#### **DANGER**

Indicates a situation that results in death or serious injury.



#### **DANGER: RISK OF ELECTROCUTION**

Indicates a situation that could result in electrocution.



#### **DANGER: RISK OF BURNING/SCALDING**

Indicates a situation that could result in burning/scalding because of extreme hot or cold temperatures.



#### **DANGER: RISK OF EXPLOSION**

Indicates a situation that could result in explosion.



#### **WARNING**

Indicates a situation that could result in death or serious injury.



#### **WARNING: FLAMMABLE MATERIAL**



#### **CAUTION**

Indicates a situation that could result in minor or moderate injury.



#### **NOTICE**





Indicates a situation that could result in equipment or property damage.





#### **INFORMATION**

Indicates useful tips or additional information.

Symbols used on the unit:

Symbol	Explanation
	Before installation, read the installation and operation manual, and the wiring instruction sheet.
	Before performing maintenance and service tasks, read the service manual.
	For more information, see the installer and user reference guide.
	The unit contains rotating parts. Be careful when servicing or inspecting the unit.





Symbols used in the documentation:

Symbol	Explanation
	Indicates a figure title or a reference to it. <b>Example:</b> "▲ 1–3 Figure title" means "Figure 3 in chapter 1".
	Indicates a table title or a reference to it. <b>Example:</b> "■ 1–3 Table title" means "Table 3 in chapter 1".

## 2.2 For the installer

### 2.2.1 General

If you are NOT sure how to install or operate the unit, contact your dealer.

	<p><b>DANGER: RISK OF BURNING/SCALDING</b></p> <ul style="list-style-type: none"> <li>Do NOT touch the refrigerant piping, water piping or internal parts during and immediately after operation. It could be too hot or too cold. Give it time to return to normal temperature. If you MUST touch it, wear protective gloves.</li> <li>Do NOT touch any accidental leaking refrigerant.</li> </ul>
	<p><b>WARNING</b></p> <p>Improper installation or attachment of equipment or accessories could result in electrical shock, short-circuit, leaks, fire or other damage to the equipment. ONLY use accessories, optional equipment and spare parts made or approved by Daikin.</p>
	<p><b>WARNING</b></p> <p>Make sure installation, testing and applied materials comply with applicable legislation (on top of the instructions described in the Daikin documentation).</p>
	<p><b>CAUTION</b></p> <p>Wear adequate personal protective equipment (protective gloves, safety glasses,...) when installing, maintaining or servicing the system.</p>
	<p><b>WARNING</b></p> <p>Tear apart and throw away plastic packaging bags so that nobody, especially children, can play with them. Possible risk: suffocation.</p>

**WARNING**

Provide adequate measures to prevent that the unit can be used as a shelter by small animals. Small animals that make contact with electrical parts can cause malfunctions, smoke or fire.

**CAUTION**

Do NOT touch the air inlet or aluminium fins of the unit.

**CAUTION**

- Do NOT place any objects or equipment on top of the unit.
- Do NOT sit, climb or stand on the unit.

In accordance with the applicable legislation, it might be necessary to provide a logbook with the product containing at least: information on maintenance, repair work, results of tests, stand-by periods,...

Also, at least, following information **MUST** be provided at an accessible place at the product:

- Instructions for shutting down the system in case of an emergency
- Name and address of fire department, police and hospital
- Name, address and day and night telephone numbers for obtaining service

In Europe, EN378 provides the necessary guidance for this logbook.

### 2.2.2 Installation site

- Provide sufficient space around the unit for servicing and air circulation.
- Make sure the installation site withstands the weight and vibration of the unit.
- Make sure the area is well ventilated. Do NOT block any ventilation openings.
- Make sure the unit is level.

Do NOT install the unit in the following places:

- In potentially explosive atmospheres.
- In places where there is machinery that emits electromagnetic waves. Electromagnetic waves may disturb the control system, and cause malfunction of the equipment.
- In places where there is a risk of fire due to the leakage of flammable gases (example: thinner or gasoline), carbon fibre, ignitable dust.
- In places where corrosive gas (example: sulphurous acid gas) is produced. Corrosion of copper pipes or soldered parts may cause the refrigerant to leak.

### 2.2.3 Refrigerant — in case of R410A or R32

If applicable. See the installation manual or installer reference guide of your application for more information.

**NOTICE**

Make sure refrigerant piping installation complies with applicable legislation. In Europe, EN378 is the applicable standard.



### NOTICE

Make sure the field piping and connections are NOT subjected to stress.



### WARNING

During tests, NEVER pressurise the product with a pressure higher than the maximum allowable pressure (as indicated on the nameplate of the unit).



### WARNING

Take sufficient precautions in case of refrigerant leakage. If refrigerant gas leaks, ventilate the area immediately. Possible risks:

- Excessive refrigerant concentrations in a closed room can lead to oxygen deficiency.
- Toxic gas might be produced if refrigerant gas comes into contact with fire.



### DANGER: RISK OF EXPLOSION

**Pump down – Refrigerant leakage.** If you want to pump down the system, and there is a leak in the refrigerant circuit:

- Do NOT use the unit's automatic pump down function, with which you can collect all refrigerant from the system into the outdoor unit. **Possible consequence:** Self-combustion and explosion of the compressor because of air going into the operating compressor.
- Use a separate recovery system so that the unit's compressor does NOT have to operate.



### WARNING

ALWAYS recover the refrigerant. Do NOT release them directly into the environment. Use a vacuum pump to evacuate the installation.



### NOTICE

After all the piping has been connected, make sure there is no gas leak. Use nitrogen to perform a gas leak detection.



### NOTICE

- To avoid compressor breakdown, do NOT charge more than the specified amount of refrigerant.
- When the refrigerant system is to be opened, refrigerant MUST be treated according to the applicable legislation.



### WARNING



Make sure there is no oxygen in the system. Refrigerant may ONLY be charged after performing the leak test and the vacuum drying.

**Possible consequence:** Self-combustion and explosion of the compressor because of oxygen going into the operating compressor.

- In case recharge is required, see the nameplate of the unit. It states the type of refrigerant and necessary amount.
- The unit is factory charged with refrigerant and depending on pipe sizes and pipe lengths some systems require additional charging of refrigerant.



- ONLY use tools exclusively for the refrigerant type used in the system, this to ensure pressure resistance and prevent foreign materials from entering into the system.
- Charge the liquid refrigerant as follows:

If	Then
A siphon tube is present (i.e., the cylinder is marked with "Liquid filling siphon attached")	Charge with the cylinder upright. 
A siphon tube is NOT present	Charge with the cylinder upside down. 

- Open refrigerant cylinders slowly.
- Charge the refrigerant in liquid form. Adding it in gas form may prevent normal operation.



**CAUTION**

When the refrigerant charging procedure is done or when pausing, close the valve of the refrigerant tank immediately. If the valve is NOT closed immediately, remaining pressure might charge additional refrigerant. **Possible consequence:** Incorrect refrigerant amount.

2.2.4 Electrical



**DANGER: RISK OF ELECTROCUTION**

- Turn OFF all power supply before removing the switch box cover, connecting electrical wiring or touching electrical parts.
- Disconnect the power supply for more than 10 minutes, and measure the voltage at the terminals of main circuit capacitors or electrical components before servicing. The voltage MUST be less than 50 V DC before you can touch electrical components. For the location of the terminals, see the wiring diagram.
- Do NOT touch electrical components with wet hands.
- Do NOT leave the unit unattended when the service cover is removed.



**WARNING**

If NOT factory installed, a main switch or other means for disconnection, having a contact separation in all poles providing full disconnection under overvoltage category III condition, MUST be installed in the fixed wiring.



### WARNING

- ONLY use copper wires.
- Make sure the field wiring complies with the applicable legislation.
- All field wiring MUST be performed in accordance with the wiring diagram supplied with the product.
- NEVER squeeze bundled cables and make sure they do NOT come in contact with the piping and sharp edges. Make sure no external pressure is applied to the terminal connections.
- Make sure to install earth wiring. Do NOT earth the unit to a utility pipe, surge absorber, or telephone earth. Incomplete earth may cause electrical shock.
- Make sure to use a dedicated power circuit. NEVER use a power supply shared by another appliance.
- Make sure to install the required fuses or circuit breakers.
- Make sure to install an earth leakage protector. Failure to do so may cause electrical shock or fire.
- When installing the earth leakage protector, make sure it is compatible with the inverter (resistant to high frequency electric noise) to avoid unnecessary opening of the earth leakage protector.



### CAUTION

- When connecting the power supply: connect the earth cable first, before making the current-carrying connections.
- When disconnecting the power supply: disconnect the current-carrying cables first, before separating the earth connection.
- The length of the conductors between the power supply stress relief and the terminal block itself MUST be as such that the current-carrying wires are tautened before the earth wire is in case the power supply is pulled loose from the stress relief.



### NOTICE

Precautions when laying power wiring:



- Do NOT connect wiring of different thicknesses to the power terminal block (slack in the power wiring may cause abnormal heat).
- When connecting wiring which is the same thickness, do as shown in the figure above.
- For wiring, use the designated power wire and connect firmly, then secure to prevent outside pressure being exerted on the terminal board.
- Use an appropriate screwdriver for tightening the terminal screws. A screwdriver with a small head will damage the head and make proper tightening impossible.
- Over-tightening the terminal screws may break them.

Install power cables at least 1 meter away from televisions or radios to prevent interference. Depending on the radio waves, a distance of 1 meter may NOT be sufficient.



### WARNING

- After finishing the electrical work, confirm that each electrical component and terminal inside the electrical components box is connected securely.
- Make sure all covers are closed before starting up the unit.



### NOTICE

ONLY applicable if the power supply is three-phase, and the compressor has an ON/OFF starting method.

If there exists the possibility of reversed phase after a momentary black out and the power goes ON and OFF while the product is operating, attach a reversed phase protection circuit locally. Running the product in reversed phase can break the compressor and other parts.

## 3 Specific installer safety instructions

Always observe the following safety instructions and regulations.

### General



#### WARNING

Make sure installation, servicing, maintenance, repair and applied materials follow the instructions from Daikin and, in addition, comply with applicable legislation and are performed by qualified persons only. In Europe and areas where IEC standards apply, EN/IEC 60335-2-40 is the applicable standard.

### Unit installation (see "16 Unit installation" [▶ 48])

For additional installation site requirements, read also "3.1 Instructions for equipment using R32 refrigerant" [▶ 14].



#### WARNING

The appliance shall be stored in a room without continuously operating ignition sources (example: open flames, an operating gas appliance or an operating electric heater).



#### CAUTION

Appliance NOT accessible to the general public, install it in a secured area, protected from easy access.

This unit, both indoor and outdoor, is suitable for installation in a commercial and light industrial environment.



#### WARNING

Keep any required ventilation openings clear of obstructions.



#### CAUTION

This equipment is NOT intended for use in residential locations and will NOT guarantee to provide adequate protection to radio reception in such locations.



#### CAUTION

In case of installation WITHOUT duct on the air inlet side, fix the air filter on the service cover side by screw (field supply).

### Duct installation (see "16.2.2 Guidelines when installing the ducting" [▶ 53])



#### WARNING

Do NOT install operating ignition sources (example: open flames, an operating gas appliance or an operating electric heater) in the duct work.

**CAUTION**

- Make sure the installation of the duct does NOT exceed the setting range of the external static pressure for the unit. Refer to the technical datasheet of your model for the setting range.
- Make sure to install the canvas duct so vibrations are NOT transmitted to the duct or ceiling. Use a sound-absorbing material (insulation material) for the lining of the duct and apply vibration insulation rubber to the hanging bolts.
- When welding, make sure NOT to spatter onto the drain pan or the air filter.
- If the metal duct passes through a metal lath, wire lath or metal plate of the wooden structure, separate the duct and wall electrically.
- Install the outlet grille in a position where the airflow will not come into direct contact with people.
- Do NOT use booster fans in the duct. Use the function to adjust the fan rate setting automatically (see "20 Configuration" [▶ 72]).

**Refrigerant piping installation (see "17 Piping installation" [▶ 59])****CAUTION**

Piping MUST be installed according to instructions given in "17 Piping installation" [▶ 59]. Only mechanical joints (e.g. braze+flare connections) that are compliant with the latest version of ISO14903 can be used.

**CAUTION**

Install the refrigerant piping or components in a position where they are unlikely to be exposed to any substance which may corrode components containing refrigerant, unless the components are constructed of materials that are inherently resistant to corrosion or are suitably protected against corrosion.

**Electrical installation (see "18 Electrical installation" [▶ 65])****WARNING**

ALWAYS use multicore cable for power supply cables.

**WARNING**

- All wiring MUST be performed by an authorised electrician and MUST comply with the applicable legislation.
- Make electrical connections to the fixed wiring.
- All components procured on-site and all electrical construction MUST comply with the applicable legislation.



#### WARNING

- If the power supply has a missing or wrong N-phase, equipment might break down.
- Establish proper earthing. Do NOT earth the unit to a utility pipe, surge absorber, or telephone earth. Incomplete earthing may cause electrical shock.
- Install the required fuses or circuit breakers.
- Secure the electrical wiring with cable ties so that the cables do NOT come in contact with sharp edges or piping, particularly on the high-pressure side.
- Do NOT use taped wires, stranded conductor wires, extension cords, or connections from a star system. They can cause overheating, electrical shock or fire.
- Do NOT install a phase advancing capacitor, because this unit is equipped with an inverter. A phase advancing capacitor will reduce performance and may cause accidents.



#### WARNING

Use an all-pole disconnection type breaker with at least 3 mm between the contact point gaps that provide full disconnection under overvoltage category III.



#### WARNING

If the supply cord is damaged, it MUST be replaced by the manufacturer, its service agent or similarly qualified persons in order to avoid a hazard.



#### CAUTION

- Each indoor unit has to be connected to a separate user interface. Only a safety system compatible remote controller can be used as the user interface. See technical data sheet for remote controller compatibility (e.g. BRC1H52/82\*).
- The user interface has to be put in the same room as the indoor unit. For details, please refer to the installation and operation manual of the user interface.



#### CAUTION

In case shielded wire is used, connect the shielding to the outdoor unit side only.

#### Configuration (see "20 Configuration" [▶ 72])



#### WARNING

In case of R32 refrigerant, terminal connections T1/T2 are for fire alarm input ONLY. Fire alarm has a higher priority than R32 safety and shuts the entire system down.

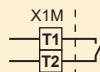

**a** Fire alarm input signal (potential free contact)

## 3.1 Instructions for equipment using R32 refrigerant



#### WARNING: MILDLY FLAMMABLE MATERIAL

The refrigerant inside this unit is mildly flammable.

**WARNING**

- Do NOT pierce or burn refrigerant cycle parts.
- Do NOT use cleaning materials or means to accelerate the defrosting process other than those recommended by the manufacturer.
- Be aware that the refrigerant inside the system is odourless.

**WARNING**

The appliance shall be stored so as to prevent mechanical damage and in a well-ventilated room without continuously operating ignition sources (example: open flames, an operating gas appliance or an operating electric heater) and have a room size as specified below.

**WARNING**

Make sure installation, servicing, maintenance and repair comply with instructions from Daikin and with applicable legislation and are executed **ONLY** by authorised persons.

**WARNING**

If one or more rooms are connected to the unit using a duct system, make sure:

- there are no operating ignition sources (example: open flames, an operating gas appliance or an operating electric heater) in case the floor area is less than the minimum floor area A (m<sup>2</sup>).
- no auxiliary devices, which may be a potential ignition source, are installed in the duct work (example: hot surfaces with a temperature exceeding 700°C and electric switching device);
- only auxiliary devices approved by the manufacturer are used in the duct work;
- air inlet AND outlet are connected directly to the same room by ducting. Do NOT use spaces such as a false ceiling as a duct for the air inlet or outlet.

**NOTICE**

- Precautions shall be taken to avoid excessive vibration or pulsation to refrigeration piping.
- Protection devices, piping and fittings shall be protected as far as possible against adverse environmental effects.
- Provision shall be made for expansion and contraction of long runs of piping.
- Piping in refrigerating systems shall be designed and installed such as to minimise the likelihood of hydraulic shock damaging the system.
- The indoor equipment and pipes shall be securely mounted and guarded such that accidental rupture of equipment or pipes cannot occur from events such as moving furniture or reconstruction activities.

**CAUTION**

Do NOT use potential sources of ignition in searching for or detection of refrigerant leaks.

**NOTICE**

- Do NOT re-use joints and copper gaskets which have been used already.
- Joints made in installation between parts of refrigerant system shall be accessible for maintenance purposes.



#### NOTICE

- Incomplete flaring may cause refrigerant gas leakage.
- Do NOT re-use flares. Use new flares to prevent refrigerant gas leakage.
- Use flare nuts that are included with the unit. Using different flare nuts may cause refrigerant gas leakage.

#### 3.1.1 Installation space requirements



#### CAUTION

The total refrigerant charge in the system cannot exceed the requirements for minimum floor area of the smallest room that is served. For minimum floor area requirements for indoor units, see the installation and operation manual of the outdoor unit.



#### WARNING

This appliance contains R32 refrigerant. For the minimum floor area of the room in which the appliance is stored refer to installation and operation manual of the outdoor unit.



#### NOTICE

- Pipework shall be protected from physical damage.
- Installation of pipework shall be kept to a minimum.



For the user

## 4 User safety instructions

Always observe the following safety instructions and regulations.

### 4.1 General



#### **WARNING**

If you are NOT sure how to operate the unit, contact your installer.



#### **WARNING**

This appliance can be used by children aged from 8 years and above and persons with reduced physical, sensory or mental capabilities or lack of experience and knowledge if they have been given supervision or instruction concerning use of the appliance in a safe way and understand the hazards involved.

Children SHALL NOT play with the appliance.

Cleaning and user maintenance SHALL NOT be made by children without supervision.



#### **WARNING**

To prevent electrical shocks or fire:

- Do NOT rinse the unit.
- Do NOT operate the unit with wet hands.
- Do NOT place any objects containing water on the unit.



#### **CAUTION**

- Do NOT place any objects or equipment on top of the unit.
- Do NOT sit, climb or stand on the unit.

- Units are marked with the following symbol:



This means that electrical and electronic products may NOT be mixed with unsorted household waste. Do NOT try to dismantle the system yourself: the dismantling of the system, treatment of the refrigerant, of oil and of other parts MUST be done by an authorised installer and MUST comply with applicable legislation.

Units MUST be treated at a specialised treatment facility for reuse, recycling and recovery. By ensuring this product is disposed of correctly, you will help to prevent potential negative consequences for the environment and human health. For more information, contact your installer or local authority.

- Batteries are marked with the following symbol:



This means that the batteries may NOT be mixed with unsorted household waste. If a chemical symbol is printed beneath the symbol, this chemical symbol means that the battery contains a heavy metal above a certain concentration.

Possible chemical symbols are: Pb: lead (>0.004%).

Waste batteries MUST be treated at a specialised treatment facility for reuse. By ensuring waste batteries are disposed of correctly, you will help to prevent potential negative consequences for the environment and human health.

## 4.2 Instructions for safe operation



### WARNING

- Do NOT modify, disassemble, remove, reinstall or repair the unit yourself as incorrect dismantling or installation may cause an electrical shock or fire. Contact your dealer.
- In case of accidental refrigerant leaks, make sure there are no naked flames. The refrigerant itself is entirely safe, non-toxic and mildly flammable, but it will generate toxic gas when it accidentally leaks into a room where combustible air from fan heaters, gas cookers, etc. is present. Always have qualified service personnel confirm that the point of leakage has been repaired or corrected before resuming operation.



### CAUTION

This unit is equipped with electrically powered safety measures, such as a refrigerant leak detector. In order to be effective, the unit must be electrically powered at all times after installation, except for short service periods.



**CAUTION**

- NEVER touch the internal parts of the controller.
- Do NOT remove the front panel. Some parts inside are dangerous to touch and appliance problems may happen. For checking and adjusting the internal parts, contact your dealer.



**WARNING**

This unit contains electrical and hot parts.



**WARNING**

Before operating the unit, be sure the installation has been carried out correctly by an installer.



**CAUTION**

It is unhealthy to expose your body to the air flow for a long time.



**CAUTION**

To avoid oxygen deficiency, ventilate the room sufficiently if equipment with burner is used together with the system.



**CAUTION**

Do NOT operate the system when using a room fumigation-type insecticide. Chemicals could collect in the unit, and endanger the health of people who are hypersensitive to chemicals.



**CAUTION**

NEVER expose little children, plants or animals directly to the airflow.



**WARNING**

Do NOT place a flammable spray bottle near the air conditioner and do NOT use sprays near the unit. Doing so may result in a fire.



**WARNING**

Keep any required ventilation openings clear of obstructions.

**Maintenance and service (see "10 Maintenance and service" [▶ 31])****CAUTION: Pay attention to the fan!**

It is dangerous to inspect the unit while the fan is running. Make sure to turn OFF the main switch before executing any maintenance task.

**CAUTION**

Do NOT insert fingers, rods or other objects into the air inlet or outlet. When the fan is rotating at high speed, it will cause injury.

**WARNING**

NEVER replace a fuse with a fuse of a wrong ampere ratings or other wires when a fuse blows out. Use of wire or copper wire may cause the unit to break down or cause a fire.

**CAUTION**

After a long use, check the unit stand and fitting for damage. If damaged, the unit may fall and result in injury.

**CAUTION**

Before accessing terminal devices, make sure to interrupt all power supply.

**DANGER: RISK OF ELECTROCUTION**

To clean the air conditioner or air filter, be sure to stop operation and turn all power supplies OFF. Otherwise, an electrical shock and injury may result.

**WARNING**

Be careful with ladders when working in high places.

**DANGER: RISK OF ELECTROCUTION**

Disconnect the power supply for more than 10 minutes, and measure the voltage at the terminals of main circuit capacitors or electrical components before servicing. The voltage MUST be less than 50 V DC before you can touch electrical components. For the location of the terminals, see the warning label for persons performing service and maintenance.



**CAUTION**

Turn off the unit before cleaning the air filter and air outlet.



**WARNING**

Do NOT let the indoor unit get wet. **Possible consequence:** Electrical shock or fire.

About the refrigerant (see "10.5 About the refrigerant" [▶ 34])



**WARNING: MILDLY FLAMMABLE MATERIAL**

The refrigerant inside this unit is mildly flammable.



**WARNING**

- Do NOT pierce or burn refrigerant cycle parts.
- Do NOT use cleaning materials or means to accelerate the defrosting process other than those recommended by the manufacturer.
- Be aware that the refrigerant inside the system is odourless.



**WARNING**

- The refrigerant inside the unit is mildly flammable, but normally does NOT leak. If the refrigerant leaks in the room and comes in contact with fire from a burner, a heater, or a cooker, this may result in fire, or the formation of a harmful gas.
- Turn OFF any combustible heating devices, ventilate the room, and contact the dealer where you purchased the unit.
- Do NOT use the unit until a service person confirms that the part from which the refrigerant leaked has been repaired.



**WARNING**

The appliance shall be stored in a room without continuously operating ignition sources (example: open flames, an operating gas appliance or an operating electric heater).

**WARNING**

The R32 refrigerant leakage sensor must be replaced after every detection or at the end of its lifetime. ONLY authorised persons may replace the sensor.

[Troubleshooting \(see "11 Troubleshooting" \[▶ 37\]\)](#)

**WARNING**

**Stop operation and shut OFF the power if anything unusual occurs (burning smells etc.).**

Leaving the unit running under such circumstances may cause breakage, electrical shock or fire. Contact your dealer.

## 5 About the system



### WARNING

- Do NOT modify, disassemble, remove, reinstall or repair the unit yourself as incorrect dismantling or installation may cause an electrical shock or fire. Contact your dealer.
- In case of accidental refrigerant leaks, make sure there are no naked flames. The refrigerant itself is entirely safe and non-toxic. R410A is a non-combustible refrigerant, and R32 is a mildly flammable refrigerant, but they will generate a toxic gas when they accidentally leak into a room where combustible air from fan heaters, gas cookers, etc. is present. Always have qualified service personnel confirm that the point of leakage has been repaired or corrected before resuming operation.



### NOTICE

Do NOT use the system for other purposes. In order to avoid any quality deterioration, do NOT use the unit for cooling precision instruments, food, plants, animals, or works of art.



### NOTICE

For future modifications or expansions of your system:

A full overview of allowable combinations (for future system extensions) is available in technical engineering data and should be consulted. Contact your installer to receive more information and professional advice.



### CAUTION

This unit is equipped with electrically powered safety measures, such as a refrigerant leak detector. In order to be effective, the unit must be electrically powered at all times after installation, except for short service periods.

### 5.1 System layout



### INFORMATION

The following illustration is an example and might NOT match your system layout.



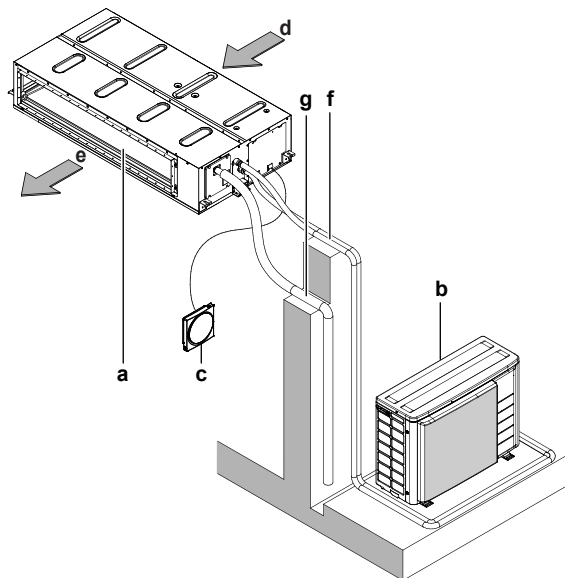

- a** Indoor unit
- b** Outdoor unit
- c** User interface
- d** Suction air
- e** Discharge air
- f** Refrigerant piping + transmission cable
- g** Drain pipe

## 5.2 Information requirements for fan coil units

Item	Symbol	Value	Unit
Cooling capacity (sensible)	$P_{\text{rated,c}}$	A	kW
Cooling capacity (latent)	$P_{\text{rated,c}}$	B	kW
Heating capacity	$P_{\text{rated,h}}$	C	kW
Total electric power input	$P_{\text{elec}}$	D	kW
Sound power level (cooling)	$L_{\text{WA}}$	E	dB(A)
Sound power level (heating)	$L_{\text{WA}}$	F	dB(A)
Contact details: DAIKIN INDUSTRIES CZECH REPUBLIC s.r.o. U Nové Hospody 1/1155, 301 00 Plzeň Skvrňany, Czech Republic			

	A	B	C	D	E	F
FXMA50	4	1.6	6.3	0.125	61	61
FXMA63	5.1	2	8	0.140	64	64
FXMA80	6.7	2.3	10	0.202	67	67
FXMA100	8.1	3.1	12.5	0.191	65	65
FXMA125	10.3	3.7	16	0.258	70	70

## 6 User interface



### CAUTION

- NEVER touch the internal parts of the controller.
- Do NOT remove the front panel. Some parts inside are dangerous to touch and appliance problems may happen. For checking and adjusting the internal parts, contact your dealer.



### NOTICE

Do NOT wipe the controller operation panel with benzine, thinner, chemical dust cloth, etc. The panel may get discoloured or the coating peeled off. If it is heavily dirty, soak a cloth in water-diluted neutral detergent, squeeze it well and wipe the panel clean. Wipe it with another dry cloth.



### NOTICE

NEVER press the button of the user interface with a hard, pointed object. The user interface may be damaged.



### NOTICE

NEVER pull or twist the electric wire of the user interface. It may cause the unit to malfunction.

This operation manual offers a non-exhaustive overview of the main functions of the system.

For more information about the user interface, see the operation manual of the installed user interface.

## 7 Before operation

**WARNING**

This unit contains electrical and hot parts.

**WARNING**

Before operating the unit, be sure the installation has been carried out correctly by an installer.

**CAUTION**

It is unhealthy to expose your body to the air flow for a long time.

**CAUTION**

To avoid oxygen deficiency, ventilate the room sufficiently if equipment with burner is used together with the system.

**CAUTION**

Do NOT operate the system when using a room fumigation-type insecticide. Chemicals could collect in the unit, and endanger the health of people who are hypersensitive to chemicals.

This operation manual is for the following systems with standard control. Before initiating operation, contact your dealer for the operation that corresponds to your system type and mark. If your installation has a customised control system, ask your dealer for the operation that corresponds to your system.

# 8 Operation

## 8.1 Operation range



### INFORMATION

For the operation limits see the technical data of the connected outdoor unit.

## 8.2 About operation modes







### INFORMATION

Depending on the installed system, some operation modes will not be available.



- The air flow rate may adjust itself depending on the room temperature or the fan may stop immediately. This is not a malfunction.
- If the main power supply is turned off during operation, operation will restart automatically after the power turns back on again.
- **Setpoint.** Target temperature for the Cooling, Heating, and Auto operation modes.
- **Setback.** A function that keeps the room temperature in a specific range when the system is turned off (by the user, the schedule function, or the OFF timer).

### 8.2.1 Basic operation modes

The indoor unit can operate in various operation modes.

Icon	Operation mode
	<b>Cooling.</b> In this mode, cooling will be activated as required by the setpoint, or by Setback operation.
	<b>Heating.</b> In this mode, heating will be activated as required by the setpoint, or by Setback operation.
	<b>Fan only.</b> In this mode, air circulates without heating or cooling.
 	<b>Auto.</b> In Auto mode, the indoor unit automatically switches between heating and cooling mode, as required by the setpoint.

## 8.2.2 Special heating operation modes

Operation	Description
<b>Defrost</b>	<p>To prevent a loss of heating capacity due to frost accumulation in the outdoor unit, the system will automatically switch to defrost operation.</p> <p>During defrost operation, the indoor unit fan will stop operation, and the following icon will appear on the home screen:</p>  <p>The system will resume normal operation after approximately 6 to 8 minutes.</p>
<b>Hot start</b>	<p>During hot start, the indoor unit fan will stop operation, and the following icon will appear on the home screen:</p> 

## 8.3 To operate the system

**INFORMATION**

For setting of the operation mode or other settings, see the reference guide or operation manual of the user interface.

## 9 Energy saving and optimum operation



### CAUTION

NEVER expose little children, plants or animals directly to the airflow.



### NOTICE

Do NOT place objects below the indoor and/or outdoor unit that may get wet. Otherwise condensation on the unit or refrigerant pipes, air filter dirt or drain blockage may cause dripping, and objects under the unit may get dirty or damaged.



### WARNING

Do NOT place a flammable spray bottle near the air conditioner and do NOT use sprays near the unit. Doing so may result in a fire.



### WARNING

Keep any required ventilation openings clear of obstructions.

Observe the following precautions to ensure the system operates properly.

- Prevent direct sunlight from entering a room during cooling operation by using curtains or blinds.
- Make sure the area is well ventilated. Do NOT block any ventilation openings.
- Ventilate often. Extended use requires special attention to ventilation.
- Keep doors and windows closed. If the doors and windows remain open, air will flow out of your room causing a decrease in the cooling or heating effect.
- Be careful NOT to cool or heat too much. To save energy, keep the temperature setting at a moderate level.
- NEVER place objects near the air inlet or the air outlet of the unit. Doing so may cause a reduced heating/cooling effect or stop operation.
- When the display shows  (time to clean the air filter), clean the filters (see "10.2.1 To clean the air filter" [▶ 32]).
- Condensation may form if the humidity is above 80% or if the drain outlet gets blocked.
- Adjust the room temperature properly for a comfortable environment. Avoid excessive heating or cooling. Notice that it may take some time for the room temperature to reach the set temperature. Consider using the timer setting options.
- Adjust the air flow direction to avoid cool air from gathering on the floor or warm air against the ceiling. (Up during cooling or dry operation to the ceiling and down during heating operation.)
- Avoid direct air flow to room inhabitants.

# 10 Maintenance and service

## 10.1 Precautions for maintenance and service



### NOTICE

Maintenance **MUST** be done by an authorised installer or service agent.

We recommend performing maintenance at least once a year. However, applicable legislation might require shorter maintenance intervals.



### CAUTION: Pay attention to the fan!

It is dangerous to inspect the unit while the fan is running.

Make sure to turn **OFF** the main switch before executing any maintenance task.



### CAUTION

Do **NOT** insert fingers, rods or other objects into the air inlet or outlet. When the fan is rotating at high speed, it will cause injury.



### NOTICE

**NEVER** inspect or service the unit by yourself. Ask a qualified service person to perform this work. However, as end user, you may clean the air filter and air outlet.



### WARNING

**NEVER** replace a fuse with a fuse of a wrong ampere ratings or other wires when a fuse blows out. Use of wire or copper wire may cause the unit to break down or cause a fire.



### CAUTION

After a long use, check the unit stand and fitting for damage. If damaged, the unit may fall and result in injury.



### NOTICE

Do **NOT** wipe the controller operation panel with benzine, thinner, chemical dust cloth, etc. The panel may get discoloured or the coating peeled off. If it is heavily dirty, soak a cloth in water-diluted neutral detergent, squeeze it well and wipe the panel clean. Wipe it with another dry cloth.



### CAUTION

Before accessing terminal devices, make sure to interrupt all power supply.



### DANGER: RISK OF ELECTROCUTION

To clean the air conditioner or air filter, be sure to stop operation and turn all power supplies **OFF**. Otherwise, an electrical shock and injury may result.



### WARNING

Be careful with ladders when working in high places.



**DANGER: RISK OF ELECTROCUTION**

Disconnect the power supply for more than 10 minutes, and measure the voltage at the terminals of main circuit capacitors or electrical components before servicing. The voltage **MUST** be less than 50 V DC before you can touch electrical components. For the location of the terminals, see the warning label for persons performing service and maintenance.

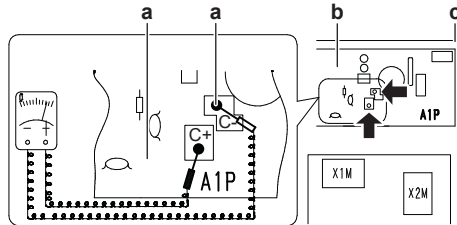

- a Residual voltage measuring points
- b Printed circuit board
- c Control box

Following symbols may occur on the indoor unit:

Symbol	Explanation
	Measure the voltage at the terminals of main circuit capacitors or electrical components before servicing.

## 10.2 Cleaning the air filter and air outlet



**CAUTION**

Turn off the unit before cleaning the air filter and air outlet.



**NOTICE**

- Do NOT use gasoline, benzene, thinner polishing powder or liquid insecticide. **Possible consequence:** Discoloration and deformation.
- Do NOT use water or air of 50°C or higher. **Possible consequence:** Discoloration and deformation.

### 10.2.1 To clean the air filter

**When to clean the air filter:**

- Rule of thumb: Clean every 6 months. If the air in the room is extremely contaminated, increase the cleaning frequency.
- Depending on the settings, the user interface can display the **"Time to clean filter"** notification. Clean the air filter when the notification displays.
- If the dirt becomes impossible to clean, change the air filter (= optional equipment).

**How to clean the air filter:**

- 1 Remove the filter fixing screw.** In case of installation without duct on the suction side, remove the filter fixing screw.
- 2 Remove the air filter.** Pull its cloth upward (in case of rear suction) or backward (in case of bottom suction).



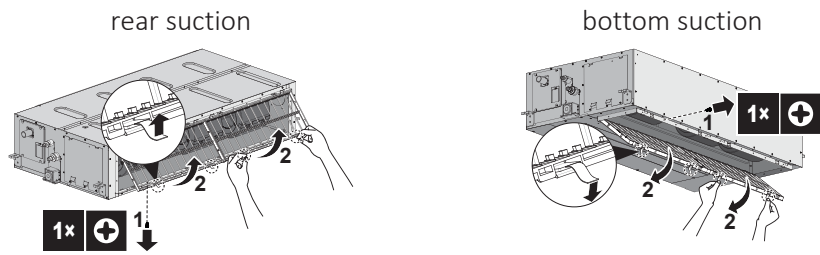

- 3 Clean the air filter.** Use a vacuum cleaner or wash with water. If the air filter is very dirty, use a soft brush and neutral detergent.

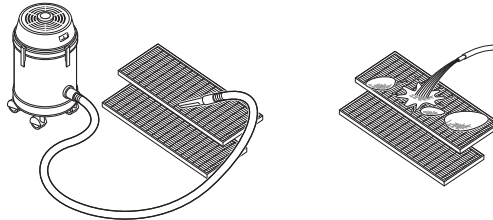

- 4 Dry the air filter in the shadow.**
- 5 Re-attach the air filter.** Align the 4 hanger brackets and push the 4 clips in their place and pull the cloth if necessary.
- 6** Confirm that all hangers are fixed.
- 7 Re-install the filter fixing screw.** In case of installation without duct on the suction side, re-install the filter fixing screw.

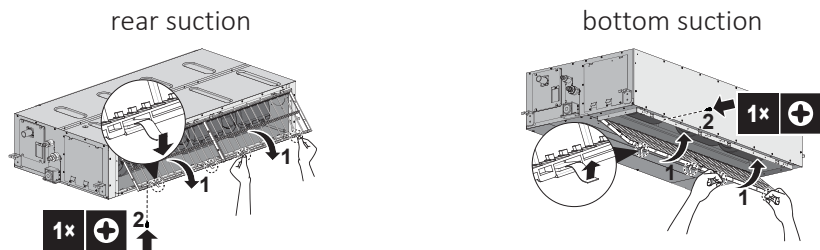

- 8** In case of bottom suction with duct, close the protective guard. In case of rear suction with duct, close service duct opening.
- 9** Turn ON the power.
- 10** To remove warning screens, see the reference guide of the user interface.

### 10.2.2 To clean the air outlet



#### WARNING

Do NOT let the indoor unit get wet. **Possible consequence:** Electrical shock or fire.

Clean with a soft cloth. If it is difficult to remove stains, use water or a neutral detergent.

## 10.3 Maintenance before a long stop period

E.g., at the end of the season.

- Let the indoor units run in fan only operation for about half a day in order to dry the interior of the units.

- Clean air filters and casings of indoor units (see "10.2 Cleaning the air filter and air outlet" [▶ 32]).
- Remove the batteries from the user interface (if applicable).

## 10.4 Maintenance after a long stop period

E.g., at the beginning of the season.

- Check and remove everything that might be blocking inlet and outlet vents of indoor units and outdoor units.
- Clean the air filter and the casing of the indoor unit (see "10.2 Cleaning the air filter and air outlet" [▶ 32]).
- Insert batteries in the user interface (if applicable).

## 10.5 About the refrigerant

This product contains fluorinated greenhouse gases. Do NOT vent gases into the atmosphere.

Refrigerant type: R32

Global warming potential (GWP) value: 675



### NOTICE

Applicable legislation on **fluorinated greenhouse gases** requires that the refrigerant charge of the unit is indicated both in weight and CO<sub>2</sub> equivalent.

**Formula to calculate the quantity in CO<sub>2</sub> equivalent tonnes:** GWP value of the refrigerant × total refrigerant charge [in kg] / 1000

Please contact your installer for more information.



### WARNING: MILDLY FLAMMABLE MATERIAL

The refrigerant inside this unit is mildly flammable.



### WARNING

The appliance shall be stored in a room without continuously operating ignition sources (example: open flames, an operating gas appliance or an operating electric heater).



### WARNING

- Do NOT pierce or burn refrigerant cycle parts.
- Do NOT use cleaning materials or means to accelerate the defrosting process other than those recommended by the manufacturer.
- Be aware that the refrigerant inside the system is odourless.

**WARNING**

- The refrigerant inside the unit is mildly flammable, but normally does NOT leak. If the refrigerant leaks in the room and comes in contact with fire from a burner, a heater, or a cooker, this may result in fire, or the formation of a harmful gas.
- Turn OFF any combustible heating devices, ventilate the room, and contact the dealer where you purchased the unit.
- Do NOT use the unit until a service person confirms that the part from which the refrigerant leaked has been repaired.

## 10.5.1 About the refrigerant leakage sensor

**WARNING**

The R32 refrigerant leakage sensor must be replaced after every detection or at the end of its lifetime. ONLY authorised persons may replace the sensor.

**NOTICE**

Functionality of the safety measures are periodically automatically checked. In case of malfunction, an error code will be displayed on the user interface.

**NOTICE**

The R32 refrigerant leakage sensor is a semiconductor detector which may incorrectly detect substances other than R32 refrigerant. Avoid using chemical substances (e.g. organic solvents, hair spray, paint) in high concentrations, in the close proximity of the indoor unit because this may cause misdetection of the R32 refrigerant leakage sensor.

**INFORMATION**

The sensor has a lifetime of 10 years. The user interface displays error "CH-05" 6 months before the end of the sensor lifetime and error "CH-02" after the end of the sensor lifetime. For more information, refer to the reference guide of the user interface and contact your dealer.

**In case of detection when the unit is in standby**

When the detection occurs when the unit is in standby, a "false detection check" will occur.

**False detection check**

- 1 The unit starts fan operation on the lowest setting.
- 2 The user interface displays error "**A0-13**", emits an alarm sound and the status indicator blinks.
- 3 The sensor checks if a refrigerant leakage or misdetection occurred.
  - No refrigerant leakage detected. **Result:** The system resumes normal operation after approximately 2 minutes.
  - Refrigerant leakage detected. **Result:**
    - 1 The user interface displays error "**A0-11**", emits an alarm sound and the status indicator blinks.
    - 2 Contact your dealer immediately. For more information, see the installation manual of the outdoor unit.

**In case of detection when the unit is turned on**

- 1** The user interface displays error "**A0-11**", emits an alarm sound and the status indicator blinks.
- 2** Contact your dealer immediately. For more information, see the installation manual of the outdoor unit.



**INFORMATION**

To stop alarm of the user interface see the reference guide of the user interface.



**INFORMATION**

The minimum airflow during normal operation or during the refrigerant leakage detection is always  $>240 \text{ m}^3/\text{h}$ .

# 11 Troubleshooting

If one of the following malfunctions occur, take the measures shown below and contact your dealer.



## WARNING

**Stop operation and shut OFF the power if anything unusual occurs (burning smells etc.).**

Leaving the unit running under such circumstances may cause breakage, electrical shock or fire. Contact your dealer.

The system **MUST** be repaired by a qualified service person.

Malfunction	Measure
If a safety device such as a fuse, a circuit breaker or a residual current device frequently actuates or the ON/OFF switch does NOT function properly.	Turn OFF all main power supply switches to the unit.
If water leaks from the unit.	Stop operation.
The operation switch does NOT function properly.	Turn OFF the power supply.
If the user interface displays  .	Notify your installer and report the error code. To display an error code see the reference guide of the user interface.

If the system does NOT operate properly except for the above mentioned cases and none of the above mentioned malfunctions is evident, investigate the system in accordance with the following procedures.

Malfunction	Measure
If the system does not operate at all.	<ul style="list-style-type: none"> <li>▪ Check if there is no power failure. Wait until power is restored. If a power failure occurs during operation, the system automatically restarts immediately after power is restored.</li> <li>▪ Check if no fuse has blown or breaker is activated. Change the fuse or reset the breaker if necessary.</li> </ul>
The system stops immediately after starting operation.	<ul style="list-style-type: none"> <li>▪ Check if air inlet or outlet of outdoor or indoor unit is not blocked by obstacles. Remove any obstacles and make sure the air can flow freely.</li> <li>▪ Check if the air filter is clogged (see "<a href="#">10.2.1 To clean the air filter</a>" [<a href="#">▶ 32</a>]).</li> </ul>

Malfunction	Measure
The system operates but cooling or heating is insufficient.	<ul style="list-style-type: none"> <li>▪ Check if air inlet or outlet of outdoor or indoor unit is not blocked by obstacles. Remove any obstacles and make sure the air can flow freely.</li> <li>▪ Check if the air filter is clogged (see "<a href="#">10.2.1 To clean the air filter</a>" [▶ 32]).</li> <li>▪ Check the temperature setting. Refer to the manual of the user interface.</li> <li>▪ Check if the fan speed setting is set to low speed. Refer to the manual of the user interface.</li> <li>▪ Check for open doors or windows. Close doors and windows to prevent wind from coming in.</li> <li>▪ Check if direct sunlight enters the room. Use curtains or blinds.</li> <li>▪ Check if there are too many occupants in the room during cooling operation. Check if the heat source of the room is excessive.</li> <li>▪ If the heat source of the room is excessive (when cooling). Cooling effect decreases if heat gain of the room is too large.</li> </ul>
Operation stops suddenly. (Operation lamp blinks.)	<ul style="list-style-type: none"> <li>▪ Check if the air filter is clogged (see "<a href="#">10.2.1 To clean the air filter</a>" [▶ 32]).</li> <li>▪ Check if air inlet or outlet of outdoor or indoor unit is not blocked by obstacles. Remove any obstacles, turn the breaker OFF and back ON. If the lamp still blinks, contact your dealer.</li> </ul>
An abnormal function happens during operation.	<ul style="list-style-type: none"> <li>▪ The air conditioner may malfunction because of lightning or radio waves. Turn the breaker OFF and back ON.</li> </ul>

If after checking all above items, it is impossible to fix the problem yourself, contact your installer and state the symptoms, the complete model name of the unit (with manufacturing number if possible) and the installation date (possibly listed on the warranty card).

## 11.1 Symptoms that are NOT system malfunctions

The following symptoms are NOT system malfunctions:

### 11.1.1 Symptom: The system does not operate

- The air conditioner does not start immediately after the ON/OFF button on the user interface is pressed. If the operation lamp lights, the system is in normal condition. To prevent overloading of the compressor motor, the air conditioner starts 5 minutes after it is turned ON again in case it was turned OFF just before. The same starting delay occurs after the operation mode selector button was used.
- The system does not start immediately after the power supply is turned on. Wait one minute until the micro computer is prepared for operation.

### 11.1.2 Symptom: White mist comes out of a unit (Indoor unit)

- When humidity is high during cooling operation. If the interior of an indoor unit is extremely contaminated, the temperature distribution inside a room becomes uneven. It is necessary to clean the interior of the indoor unit. Ask your dealer for details on cleaning the unit. This operation requires a qualified service person.
- Immediately after the cooling operation stops and if the room temperature and humidity are low. This is because warm refrigerant gas flows back into the indoor unit and generates steam.

### 11.1.3 Symptom: White mist comes out of a unit (Indoor unit, outdoor unit)

When the system is changed over to heating operation after defrost operation. Moisture generated by defrost becomes steam and is exhausted.

### 11.1.4 Symptom: The user interface reads "U4" or "U5" and stops, but then restarts after a few minutes

This is because the user interface is intercepting noise from electric appliances other than the air conditioner. The noise prevents communication between the units, causing them to stop. Operation automatically restarts when the noise ceases. A power reset may help to remove this error.

### 11.1.5 Symptom: Noise of air conditioners (Indoor unit)

- A "zeen" sound is heard immediately after the power supply is turned on. The electronic expansion valve inside an indoor unit starts working and makes the noise. Its volume will reduce in about one minute.
- A continuous low "shah" sound is heard when the system is in cooling operation or at a stop. When the drain pump is in operation, this noise is heard.
- A "pishi-pishi" squeaking sound is heard when the system stops after heating operation. Expansion and contraction of plastic parts caused by temperature change make this noise.

### 11.1.6 Symptom: Noise of air conditioners (Indoor unit, outdoor unit)

- A continuous low hissing sound is heard when the system is in cooling or defrost operation. This is the sound of refrigerant gas flowing through both indoor and outdoor units.
- A hissing sound which is heard at the start or immediately after stopping operation or defrost operation. This is the noise of refrigerant caused by flow stop or flow change.

### 11.1.7 Symptom: Dust comes out of the unit

When the unit is used for the first time in a long time. This is because dust has gotten into the unit.

### 11.1.8 Symptom: The units can give off odours

The unit can absorb the smell of rooms, furniture, cigarettes, etc., and then emit it again.

## 12 Relocation

Contact your dealer for removing and reinstalling the total unit. Moving units requires technical expertise.



# 13 Disposal

**NOTICE**

Do NOT try to dismantle the system yourself: dismantling of the system, treatment of the refrigerant, oil and other parts **MUST** comply with applicable legislation. Units **MUST** be treated at a specialised treatment facility for reuse, recycling and recovery.

For the installer

# 14 About the box

## 14.1 Overview: About the box

This chapter describes what you have to do after the box with the indoor unit is delivered on-site.

It contains information about:

- Unpacking and handling the unit
- Removing the accessories from the unit

Keep the following in mind:

- At delivery, the unit **MUST** be checked for damage. Any damage **MUST** be reported immediately to the claims agent of the carrier.
- Bring the packed unit as close as possible to its final installation position to prevent damage during transport.
- Prepare the path along which you want to bring the unit inside in advance.

## 14.2 Indoor unit

### 14.2.1 To unpack and handle the unit

Use a sling of soft material or protective plates together with a rope when lifting the unit in order to avoid damage or scratches to the unit.

- 1** Lift the unit by holding on to the hanger brackets without exerting any pressure on other parts, especially on refrigerant piping, drain piping and other resin parts.

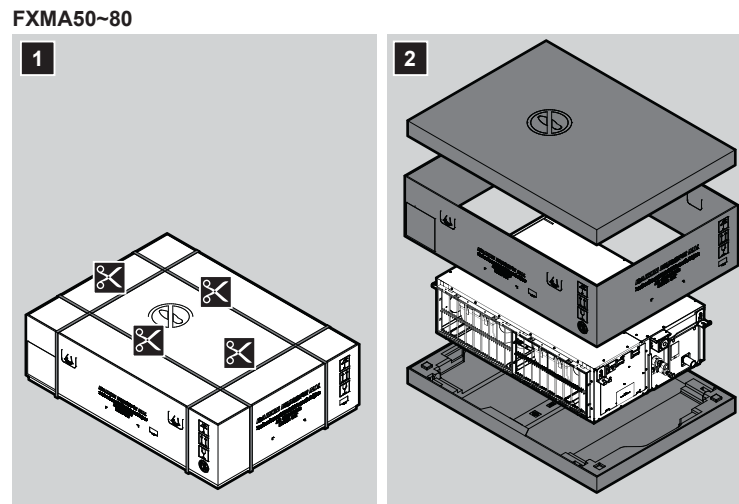

**FXMA100+125**

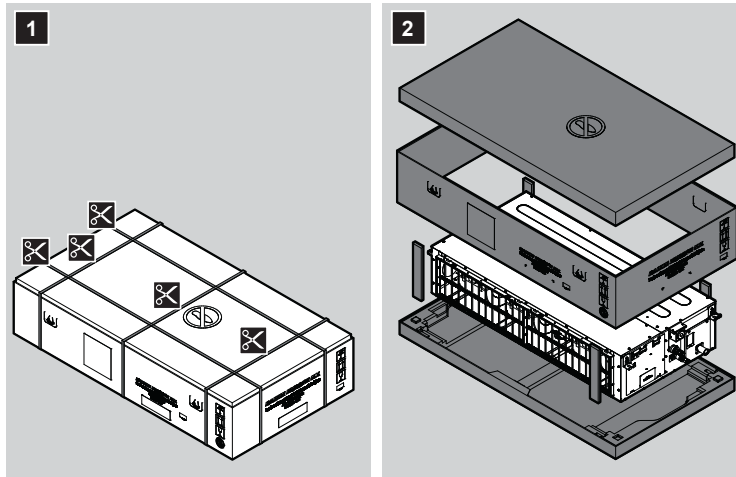

14.2.2 To remove the accessories from the indoor unit

- 1 Remove the air filter.
- 2 Remove the accessories from the inside of the unit.

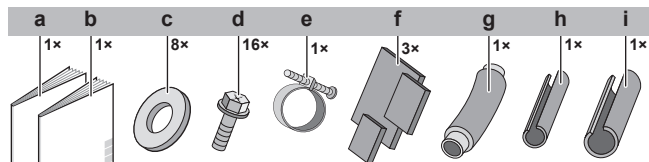
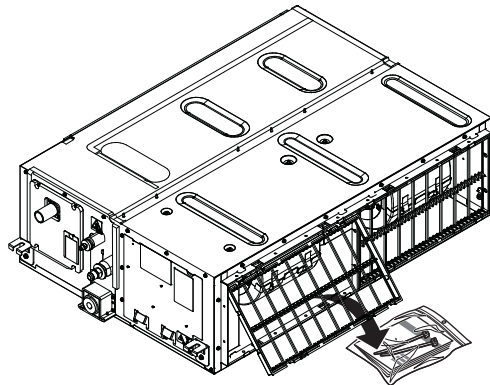

- a Installation and operation manual
- b General safety precautions
- c Washers for hanger brackets
- d Screws for duct flanges
- e Metal clamp
- f Sealing pads: Large (drain pipe), medium 1 (gas pipe), medium 2 (liquid pipe)
- g Drain hose
- h Insulation piece: Small (liquid pipe)
- i Insulation piece: Large (gas pipe)

# 15 About the units and options

## In this chapter

15.1	Identification.....	45
15.1.1	Identification label: Indoor unit.....	45
15.2	About the indoor unit.....	45
15.3	System layout.....	45
15.4	Combining units and options.....	46
15.4.1	Possible options for the indoor unit.....	46

## 15.1 Identification



### NOTICE

When installing or servicing several units at the same time, make sure NOT to switch the service panels between different models.

### 15.1.1 Identification label: Indoor unit

#### Location

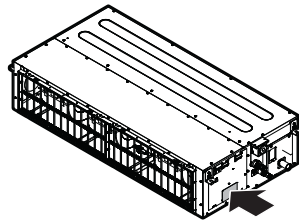

## 15.2 About the indoor unit



### INFORMATION

For the operation limits see the technical data of the connected outdoor unit.

## 15.3 System layout



### INFORMATION

The following illustration is an example and might NOT match your system layout.

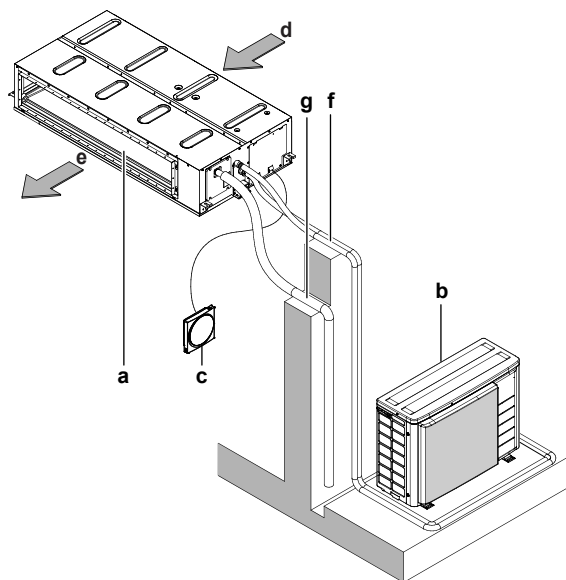

- a Indoor unit
- b Outdoor unit
- c User interface
- d Suction air
- e Discharge air
- f Refrigerant piping + transmission cable
- g Drain pipe

## 15.4 Combining units and options



### INFORMATION

Certain options may NOT be available in your country.

### 15.4.1 Possible options for the indoor unit

Make sure you have the following mandatory options:

- User interface: Only a safety system compatible user interface can be used. See the technical data sheet for user interface compatibility (e.g. BRC1H52\*)

**Note:** The user interface will generate a visible and audible warning in case of refrigerant leakage detection. E.g., BRC1H52\* user interfaces can generate an alarm of 65 dB (sound pressure, measured at a distance of 1 m from the alarm). Sound data is available in the technical data sheet of the user interface. The alarm should always be 15 dB louder than the background noise of the room. In case of higher background noise we recommend connecting an external alarm (field supply) to the optional output PCB of the indoor unit. This field supplied alarm must be mounted in every room where an indoor unit is installed.



### CAUTION

- Each indoor unit has to be connected to a separate user interface. Only a safety system compatible remote controller can be used as the user interface. See technical data sheet for remote controller compatibility (e.g. BRC1H52/82\*).
- The user interface has to be put in the same room as the indoor unit. For details, please refer to the installation and operation manual of the user interface.

- Optional output PCB (to provide output for external device): The PCB will trigger the external alarm in case of leak detection, sensor failure or when the sensor is disconnected. For the exact model name, see the option list of the indoor unit. For more information about this option, refer to the installation manual of the optional output PCB.
- An additional Installation box for the optional output PCB is required; see the option list of the indoor unit. For installation of the installation box, refer to the manual of the installation box. The wiring between the main PCB and the optional output PCB must be led together with the transmission cable; never use the same route as for the power supply cable. See "[18.2 To connect the electrical wiring to the indoor unit](#)" [[▶ 68](#)].

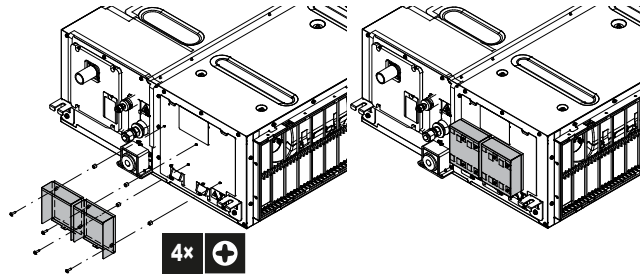

#### INFORMATION

All possible options are mentioned in the option list of the indoor unit. For more information about an option, refer to the installation and operation manual of the option.

# 16 Unit installation

## In this chapter

16.1	Preparing the installation site .....	48
16.1.1	Installation site requirements of the indoor unit .....	48
16.2	Mounting the indoor unit .....	51
16.2.1	Guidelines when installing the indoor unit .....	51
16.2.2	Guidelines when installing the ducting .....	53
16.2.3	Guidelines when installing the drain piping .....	55

## 16.1 Preparing the installation site

Choose an installation location with sufficient space for carrying the unit in and out of the site.

Avoid installation in an environment with a lot of organic solvents such as ink and siloxane.

Do NOT install the unit in places often used as work place. In case of construction works (e.g. grinding works) where a lot of dust is created, the unit MUST be covered.



### WARNING

The appliance shall be stored in a room without continuously operating ignition sources (example: open flames, an operating gas appliance or an operating electric heater).

### 16.1.1 Installation site requirements of the indoor unit

#### Minimum floor area requirements



### CAUTION

The total refrigerant charge in the system cannot exceed the requirements for minimum floor area of the smallest room that is served. For minimum floor area requirements for indoor units, see the installation and operation manual of the outdoor unit.



### INFORMATION

Also read the general installation site requirements. See the ["2 General safety precautions" \[p. 5\]](#) chapter.



### INFORMATION

The sound pressure level is less than 70 dBA.



### INFORMATION

Equipment meets the requirement for commercial and light-industrial location when professionally installed and maintained.



### NOTICE

The professional installer shall evaluate the EMC situation before installation, if the equipment is installed closer than 30 m to a residential location.



**CAUTION**

This equipment is NOT intended for use in residential locations and will NOT guarantee to provide adequate protection to radio reception in such locations.

**CAUTION**

Appliance NOT accessible to the general public, install it in a secured area, protected from easy access.

This unit, both indoor and outdoor, is suitable for installation in a commercial and light industrial environment.

**WARNING**

Keep any required ventilation openings clear of obstructions.

**NOTICE**

The equipment described in this manual may cause electronic noise generated from radio-frequency energy. The equipment complies to specifications that are designed to provide reasonable protection against such interference. However, there is no guarantee that interference will NOT occur in a particular installation.

It is therefore recommended to install the equipment and electric wires in such a way that they keep a proper distance from stereo equipment, personal computers, etc.

In places with weak reception, keep distances of 3 m or more to avoid electromagnetic interference of other equipment and use conduit tubes for power and transmission lines.

Do NOT install the unit in the following places:

- In places where a mineral oil mist, spray or vapour may be present in the atmosphere. Plastic parts may deteriorate and fall off or cause water leakage.

It is NOT recommended to install the unit in the following places because it may shorten the life of the unit:

- Where the voltage fluctuates a lot
- In vehicles or vessels
- Where acidic or alkaline vapour is present
- Take care that in the event of a water leak, water cannot cause any damage to the installation space and surroundings.
- Choose a location where the operation noise or the hot/cold air discharged from the unit will not disturb anyone.
- **Drainage.** Make sure condensation water can be evacuated properly.
- **Ceiling insulation.** When conditions in the ceiling exceed 30°C and a relative humidity of 80%, or when fresh air is inducted into the ceiling, then additional insulation is required (minimum 10 mm thickness, polyethylene foam).
- **Protective guards.** Make sure to install protective guards (field supply) on the suction and discharge side to prevent somebody from touching the fan blades or heat exchanger.
- **Spacing.** Mind the following requirements:

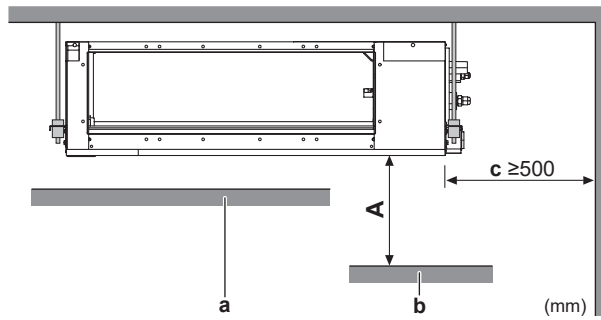

- A Minimum distance to the floor**  
2.5 m to avoid accidental touching
- a** Ceiling
- b** Floor surface
- c** Maintenance space

- **Discharge grille.** Minimum requirement installation height of discharge grille  $\geq 1.8$  m.

**Service space and ceiling opening size**

Make sure ceiling opening is big enough to ensure a sufficient clearance for maintenance and service.

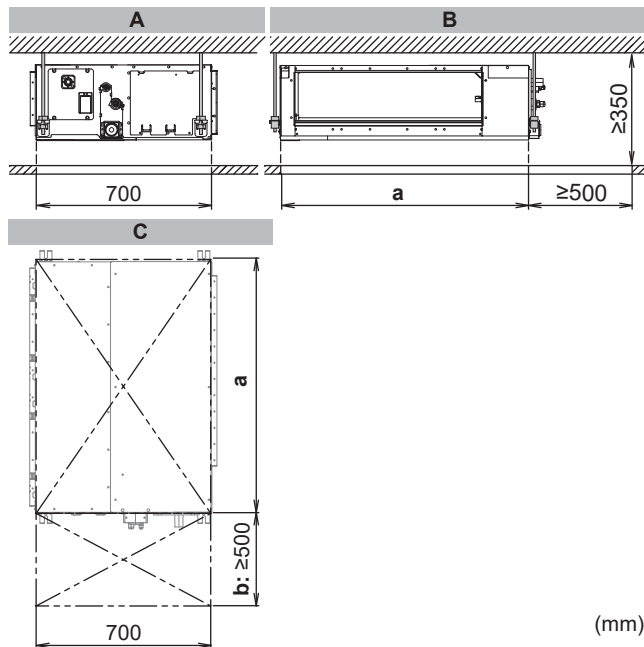

- A** Side view: refrigerant piping, drain piping, control box
- B** Side view: air inlet
- C** Top view
- a** Ceiling opening  
**Class 50~80:** 1000 mm  
**Class 100+125:** 1400 mm
- b** Service space

### Installation options

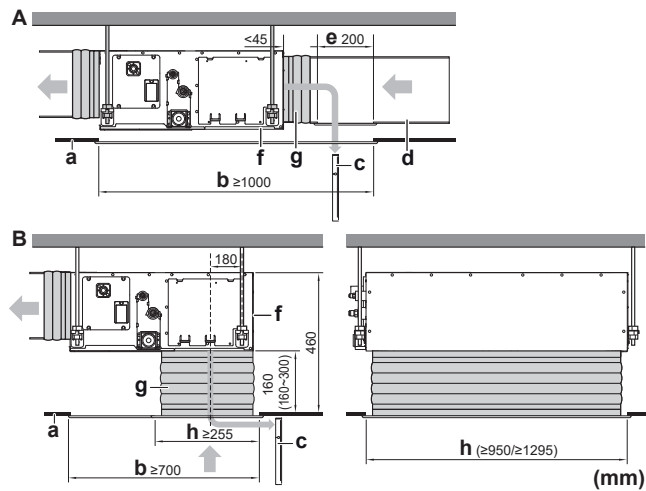

- A** Installation with rear canvas duct and duct service opening  
**B** Installation with bottom canvas duct and air inlet grill  
**a** Ceiling surface  
**b** Ceiling opening  
**c** Air filter  
**d** Air inlet duct  
**e** Duct service opening  
**f** Interchangeable plate  
**g** Canvas connection for air inlet side (field supply)  
**h** Minimum opening for protective guard (field supply)  
**Class 50~80:** 950×255 mm  
**Class 100+125:** 1295×255 mm

- **Air filter fixing.** In case of installation without duct on the air inlet side, fix the air filter on the service cover side by screw (field supply).



#### INFORMATION

Some options may require additional service space. Refer to the installation manual of the used option before installation.

## 16.2 Mounting the indoor unit

### 16.2.1 Guidelines when installing the indoor unit

#### Installation options



#### CAUTION

In case of installation WITHOUT duct on the air inlet side, fix the air filter on the service cover side by screw (field supply).



#### INFORMATION

The unit can be used with bottom suction by replacing the interchangeable plate by the air filter holding plate.

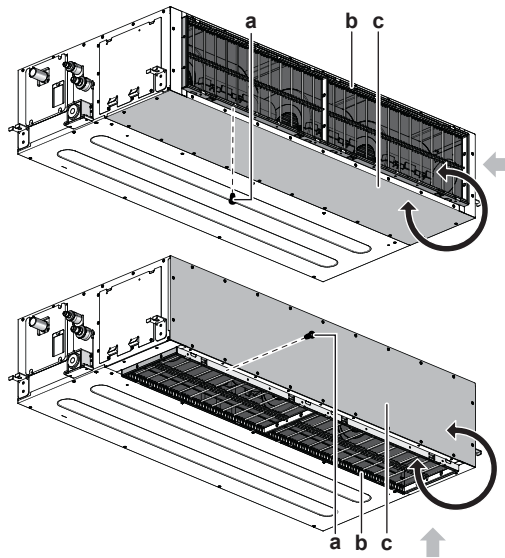

- a Thread cutting screw M4×20 (field supply) in case of installation without duct on air inlet side
- b Air filter holding plate with air filters
- c Interchangeable plate

- **Ceiling strength.** Check whether the ceiling is strong enough to support the weight of the unit. If there is a risk, reinforce the ceiling before installing the unit.
  - For existing ceilings, use anchors.
  - For new ceilings, use sunken inserts, sunken anchors or other field supplied parts.

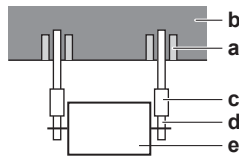

- a Anchor
- b Ceiling slab
- c Long nut or turnbuckle
- d Suspension bolt
- e Indoor unit

- **Suspension bolts.** Use M10 suspension bolts for installation. Attach the hanger bracket to the suspension bolt. Fix it securely using a nut and washer from the upper and lower sides of the hanger bracket.

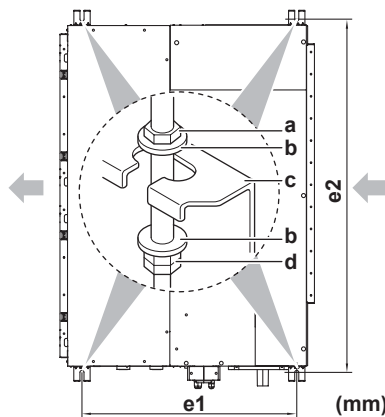

- a Nut (field supply)
- b Washer (accessories)
- c Hanger bracket
- d Double nut (field supply)
- e1 Suspension bolt pitch  
Class 50~125: 630 mm

- e2** Suspension bolt pitch  
**Class 50~80:** 1038 mm  
**Class 100~125:** 1438 mm

- **Level.** Make sure the unit is level at all four corners using a level or a water-filled vinyl tube.

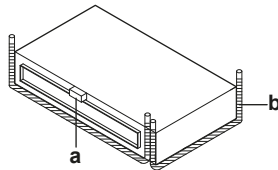

- a** Water level  
**b** Vinyl tube



#### NOTICE

Do NOT install the unit tilted. **Possible consequence:** If the unit is tilted against the direction of the condensate flow (the drain piping side is raised), the float switch might malfunction and cause water to drip.



#### INFORMATION

**Optional equipment.** When installing optional equipment, also read the installation manual of the optional equipment. Depending on the field conditions, it might be easier to install the optional equipment first.

#### Installation box for the optional output PCB

An additional Installation box for the optional output PCB is required; see the option list of the indoor unit. For installation of the installation box, refer to the manual of the installation box. The wiring between the main PCB and the optional output PCB must be led together with the transmission cable; never use the same route as for the power supply cable. See "[18.2 To connect the electrical wiring to the indoor unit](#)" [▶ 68].

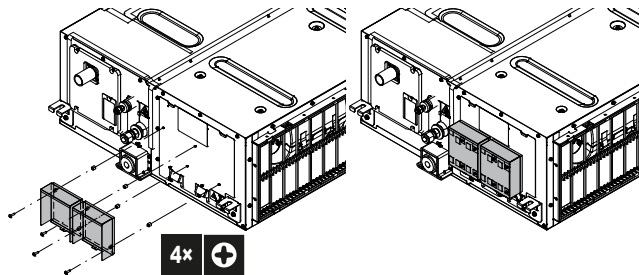

#### 16.2.2 Guidelines when installing the ducting



#### WARNING

Do NOT install operating ignition sources (example: open flames, an operating gas appliance or an operating electric heater) in the duct work.



**CAUTION**

- Make sure the installation of the duct does NOT exceed the setting range of the external static pressure for the unit. Refer to the technical datasheet of your model for the setting range.
- Make sure to install the canvas duct so vibrations are NOT transmitted to the duct or ceiling. Use a sound-absorbing material (insulation material) for the lining of the duct and apply vibration insulation rubber to the hanging bolts.
- When welding, make sure NOT to spatter onto the drain pan or the air filter.
- If the metal duct passes through a metal lath, wire lath or metal plate of the wooden structure, separate the duct and wall electrically.
- Install the outlet grille in a position where the airflow will not come into direct contact with people.
- Do NOT use booster fans in the duct. Use the function to adjust the fan rate setting automatically (see "20 Configuration" ▶ 72).

The ducting is to be field supplied.

- 1 Connect the canvas duct to the inside of the flange on both inlet and outlet side. For connecting the canvas duct, use field supply screws.
- 2 Connect the duct to the canvas duct.

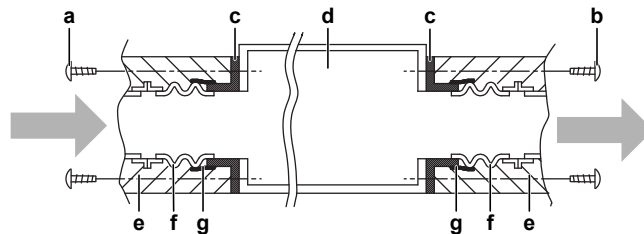

- a Screws for **inlet** duct flanges (field supply)
- b Screws for **outlet** duct flanges (accessory)
- c Flange (located on the unit)
- d Indoor unit
- e Insulation (field supply)
- f Canvas duct (field supply)
- g Aluminium tape (field supply)

- **Fixing screws.** When installing an air inlet duct, select fixing screws that stick out 5 mm on the inside of the flange to protect the air filter from damage during maintenance of the filter.

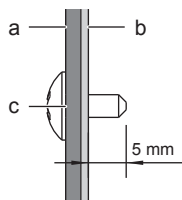

- a Air inlet duct
- b Inside of the flange
- c Fixing screw

- 3 Wind aluminium tape around the flange and duct connection. Make sure there are no air leaks at any other connection.
  - 4 Insulate the duct to prevent condensation from forming. Use glass wool or polyethylene foam 25 mm thick.
- **Filter.** Be sure to attach an air filter inside the air passage on the intake side. Use an air filter with dust collecting efficiency  $\geq 50\%$  (gravimetric method).

16.2.3 Guidelines when installing the drain piping

Make sure condensation water can be evacuated properly. This involves:

- General guidelines
- Connecting the drain piping to the indoor unit
- Checking for water leaks

**General guidelines**

- **Pipe length.** Keep drain piping as short as possible.
- **Pipe size.** Keep the pipe size equal to or greater than that of the connecting pipe (vinyl pipe of 25 mm nominal diameter and 32 mm outer diameter).
- **Slope.** Make sure the drain piping slopes down (at least 1/100) to prevent air from being trapped in the piping. Use hanging bars as shown.

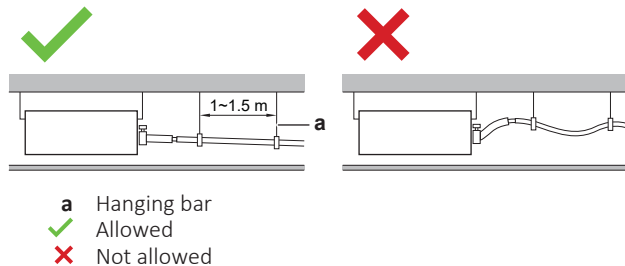

- **Condensation.** Take measures against condensation. Insulate the complete drain piping in the building.
- **Rising piping.** If necessary to make the slope possible, you can install rising piping.
  - Drain hose inclination: 0~75 mm to avoid stress on the piping and to avoid air bubbles.
  - Rising piping: ≤300 mm from the unit, ≤625 mm perpendicular to the unit.

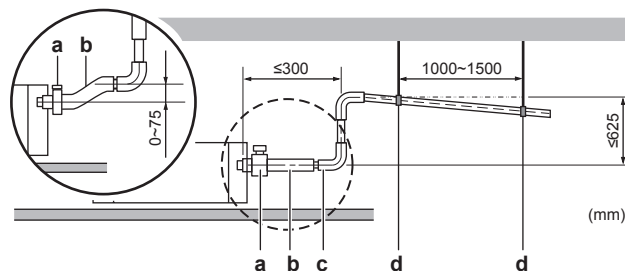

- a Metal clamp (accessory)
- b Drain hose (accessory)
- c Rising drain piping (vinyl pipe of 25 mm nominal diameter and 32 mm outer diameter) (field supply)
- d Hanging bars (field supply)

- **Combining drain pipes.** You can combine drain pipes. Make sure to use drain pipes and T-joints with the correct gauge for the operating capacity of the units.

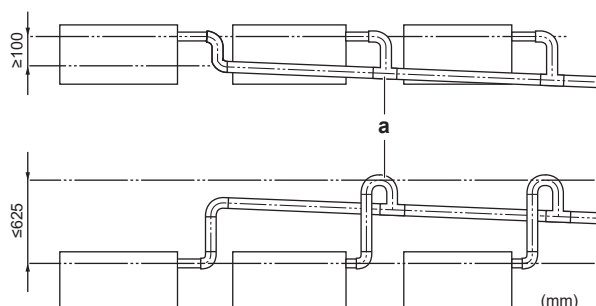

a T-joint

**To connect the drain piping to the indoor unit**



**NOTICE**

Incorrect connection of the drain hose might cause leaks, and damage the installation space and surroundings.

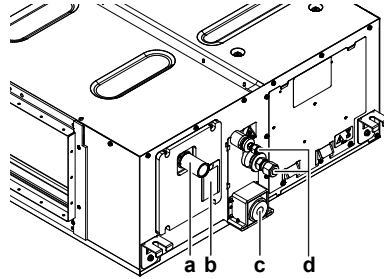

- a Drain pipe connection
- b Water inlet cover
- c Drain outlet for maintenance
- d Refrigerant pipes

**Drain piping connection**

- 1 Push the drain hose as far as possible over the drain pipe connection.
- 2 Tighten the metal clamp until the screw head is less than 4 mm from the metal clamp part.
- 3 Check for water leaks (see "To check for water leaks" [▶ 57]).
- 4 Wind the large sealing pad (= insulation) around the metal clamp and drain hose, and fix it with tie wraps.
- 5 Connect the drain piping to the drain hose.

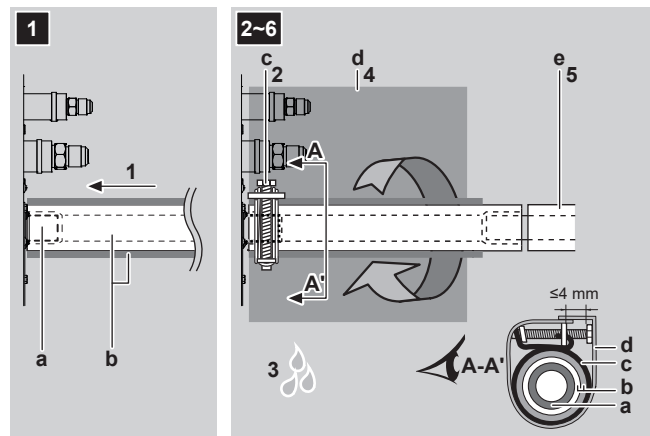

- a Drain pipe connection (attached to the unit)
- b Drain hose (accessory)
- c Metal clamp (accessory)
- d Large sealing pad (accessory)
- e Drain piping (field supply)



**NOTICE**

- Do NOT remove the drain pipe plug. Water might leak out.
- Use the drain outlet only to discharge the water if the drain pump is not used or before maintenance.
- Insert and remove the drain plug gently. Excessive force may deform the drain socket of the drain pan.



### Drain outlet for maintenance

#### Pull out the plug.

- Do NOT wiggle the plug up and down.

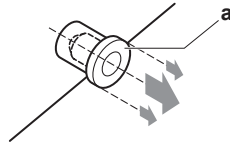

#### Push in the plug.

- Set the plug and push it in using a Phillips screwdriver.

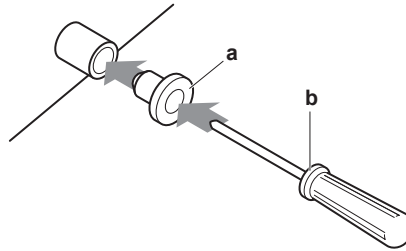

- a Drain plug
- b Phillips screwdriver

### To check for water leaks

The procedure differs depending on whether installation of the system is already completed. When installation of the system is not yet completed, temporarily connect the user interface and power supply to the unit.

#### When installation of the system is not yet completed

- Temporarily connect electrical wiring.
  - Remove the service cover.
  - Connect the power supply.
  - Connect the user interface.
  - Reattach the service cover.

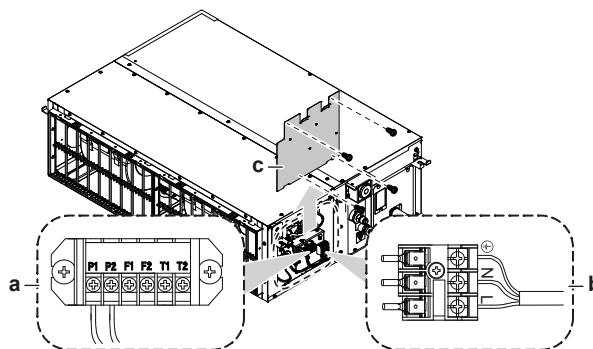

- a User interface terminal block
- b Power supply terminal block
- c Service cover with wiring diagram

- Turn ON the power supply.
- Start fan only operation (see the reference guide or the service manual of the user interface).
- Remove the water inlet cover (1 screw).
- Gradually pour approximately 1 l of water through the water inlet, and check for leaks.

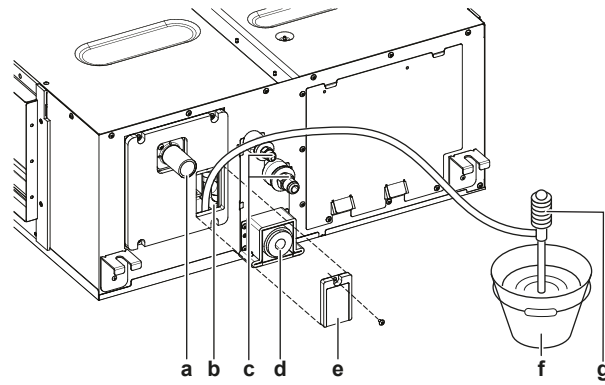

- a** Drain connection
- b** Water inlet
- c** Refrigerant pipes
- d** Drain outlet for maintenance
- e** Water inlet cover
- f** Bucket (adding water through water inlet)
- g** Portable pump

- 6** Turn OFF the power.
- 7** Disconnect the electrical wiring.
  - Remove the service cover.
  - Disconnect the power supply.
  - Disconnect the user interface.
  - Reattach the service cover.

**When installation of the system is already completed**

- 1** Start cooling operation (see the reference guide or the service manual of the user interface).
- 2** Gradually pour approximately 1 l of water through the water inlet, and check for leaks (see "[When installation of the system is not yet completed](#)" [▶ 57]).

# 17 Piping installation

## In this chapter

17.1	Preparing refrigerant piping .....	59
17.1.1	Refrigerant piping requirements .....	59
17.1.2	Refrigerant piping insulation .....	60
17.2	Connecting the refrigerant piping .....	60
17.2.1	About connecting the refrigerant piping .....	60
17.2.2	Precautions when connecting the refrigerant piping .....	61
17.2.3	Guidelines when connecting the refrigerant piping .....	62
17.2.4	Pipe bending guidelines .....	62
17.2.5	To flare the pipe end .....	62
17.2.6	To connect the refrigerant piping to the indoor unit .....	63

## 17.1 Preparing refrigerant piping

### 17.1.1 Refrigerant piping requirements



#### INFORMATION

Also read the precautions and requirements in the "[2 General safety precautions](#)" [▶ 5].



#### CAUTION

Piping **MUST** be installed according to instructions given in "[17 Piping installation](#)" [▶ 59]. Only mechanical joints (e.g. braze+flare connections) that are compliant with the latest version of ISO14903 can be used.



#### NOTICE

The piping and other pressure-containing parts shall be suitable for refrigerant. Use phosphoric acid deoxidised seamless copper for refrigerant.

- Foreign materials inside pipes (including oils for fabrication) must be ≤30 mg/10 m.

#### Refrigerant piping diameter

For piping connections of the indoor unit, use the following piping diameters:

Class	Pipe outer diameter (mm)	
	Liquid pipe	Gas pipe
50~80	Ø6.4	Ø12.7
100+125	Ø9.5	Ø15.9

#### Refrigerant piping material

- Piping material:** Phosphoric acid deoxidised seamless copper.
- Flare connections:** Only use annealed material.
- Piping temper grade and thickness:**

Outer diameter ( $\varnothing$ )	Temper grade	Thickness (t) <sup>(a)</sup>	
6.4 mm (1/4")	Annealed (O)	≥0.8 mm	
9.5 mm (3/8")			
12.7 mm (1/2")			
15.9 mm (5/8")			

<sup>(a)</sup> Depending on the applicable legislation and the maximum working pressure of the unit (see "PS High" on the unit name plate), larger piping thickness might be required.

### 17.1.2 Refrigerant piping insulation

- Use polyethylene foam as insulation material:
  - with a heat transfer rate between 0.041 and 0.052 W/mK (0.035 and 0.045 kcal/mh°C)
  - with a heat resistance of at least 120°C
- Insulation thickness

Pipe outer diameter ( $\varnothing_p$ )	Insulation inner diameter ( $\varnothing_i$ )	Insulation thickness (t)
6.4 mm (1/4")	8~10 mm	≥10 mm
9.5 mm (3/8")	10~14 mm	≥13 mm
12.7 mm (1/2")	14~16 mm	≥13 mm
15.9 mm (5/8")	16~20 mm	≥13 mm

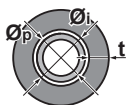

If the temperature is higher than 30°C and the humidity is higher than RH 80%, the thickness of the insulation materials should be at least 20 mm to prevent condensation on the surface of the insulation.

## 17.2 Connecting the refrigerant piping

### 17.2.1 About connecting the refrigerant piping

#### Before connecting the refrigerant piping

Make sure the outdoor and indoor unit are mounted.

#### Typical workflow

Connecting the refrigerant piping involves:

- Connecting the refrigerant piping to the indoor unit
- Connecting the refrigerant piping to the outdoor unit
- Insulating the refrigerant piping
- Keeping in mind the guidelines for:
  - Pipe bending
  - Flaring pipe ends
  - Using the stop valves

17.2.2 Precautions when connecting the refrigerant piping



**INFORMATION**

Also read the precautions and requirements in the following chapters:

- "2 General safety precautions" [▶ 5]
- "17.1 Preparing refrigerant piping" [▶ 59]



**DANGER: RISK OF BURNING/SCALDING**



**NOTICE**

- Use the flare nut fixed to the main unit.
- To prevent gas leakage, apply refrigeration oil only to the inside of the flare. Use refrigeration oil for R32 (FW68DA).
- Do NOT reuse joints.



**NOTICE**

- Do NOT use mineral oil on flared part.
- Do NOT reuse piping from previous installations.
- NEVER install a drier to this R32 unit to guarantee its lifetime. The drying material may dissolve and damage the system.



**NOTICE**

Take the following precautions on refrigerant piping into account:

- Avoid anything but the designated refrigerant to get mixed into the refrigerant cycle (e.g. air).
- Only use R32 when adding refrigerant.
- Only use installation tools (e.g. manifold gauge set) that are exclusively used for R32 installations to withstand the pressure and to prevent foreign materials (e.g. mineral oils and moisture) from mixing into the system.
- Install the piping so that the flare is NOT subjected to mechanical stress.
- Do NOT leave pipes unattended at the site. If the installation is NOT done within 1 day, protect the piping as described in the following table to prevent dirt, liquid or dust from entering the piping.
- Use caution when passing copper tubes through walls (see figure below).

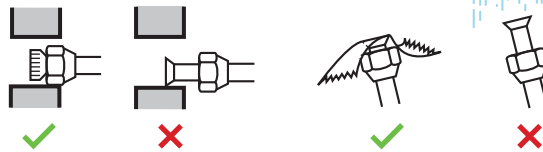

Unit	Installation period	Protection method
Outdoor unit	>1 month	Pinch the pipe
	<1 month	Pinch or tape the pipe
Indoor unit	Regardless of the period	



**INFORMATION**

Do NOT open the refrigerant stop valve before checking the refrigerant piping. When you need to charge additional refrigerant it is recommended to open the refrigerant stop valve after charging.

17.2.3 Guidelines when connecting the refrigerant piping

Take the following guidelines into account when connecting pipes:

- Coat the flare inner surface with ether oil or ester oil when connecting a flare nut. Tighten 3 or 4 turns by hand, before tightening firmly.

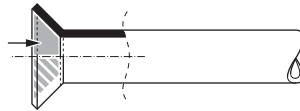

- ALWAYS use 2 wrenches together when loosening a flare nut.
- ALWAYS use a spanner and torque wrench together to tighten the flare nut when connecting the piping. This to prevent nut cracking and leaks.

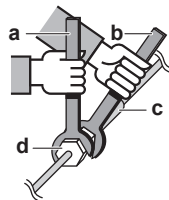

- a Torque wrench
- b Spanner
- c Piping union
- d Flare nut

Piping size (mm)	Tightening torque (N•m)	Flare dimensions (A) (mm)	Flare shape (mm)
∅6.4	15~17	8.7~9.1	
∅9.5	33~39	12.8~13.2	
∅12.7	50~60	16.2~16.6	
∅15.9	62~75	19.3~19.7	

17.2.4 Pipe bending guidelines

Use a pipe bender for bending. All pipe bends should be as gentle as possible (bending radius should be 30~40 mm or larger).

17.2.5 To flare the pipe end



**NOTICE**

- Incomplete flaring may cause refrigerant gas leakage.
- Do NOT re-use flares. Use new flares to prevent refrigerant gas leakage.
- Use flare nuts that are included with the unit. Using different flare nuts may cause refrigerant gas leakage.

- 1 Cut the pipe end with a pipe cutter.
- 2 Remove burrs with the cut surface facing down so that the chips do NOT enter the pipe.

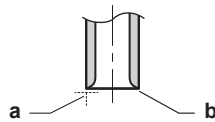

- a Cut exactly at right angles.
- b Remove burrs.

- 3 Remove the flare nut from the stop valve and put the flare nut on the pipe.
- 4 Flare the pipe. Set exactly at the position as shown in the following figure.

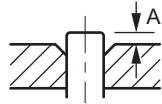

	Flare tool for R410A or R32 (clutch type)	Conventional flare tool	
		Clutch type (Ridgid-type)	Wing nut type (Imperial-type)
A	0~0.5 mm	1.0~1.5 mm	1.5~2.0 mm

- 5 Check that the flaring is properly made.

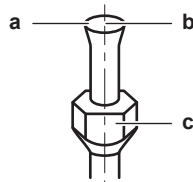

- a Flare's inner surface MUST be flawless.
- b The pipe end MUST be evenly flared in a perfect circle.
- c Make sure the flare nut is fitted.

### 17.2.6 To connect the refrigerant piping to the indoor unit



#### CAUTION

Install the refrigerant piping or components in a position where they are unlikely to be exposed to any substance which may corrode components containing refrigerant, unless the components are constructed of materials that are inherently resistant to corrosion or are suitably protected against corrosion.



#### WARNING: MILDLY FLAMMABLE MATERIAL

The refrigerant inside this unit is mildly flammable.

- **Pipe length.** Keep refrigerant piping as short as possible.
- **Flare connections.** Connect refrigerant piping to the unit using flare connections.
- **Insulation.** Insulate the refrigerant piping on the indoor unit as follows:

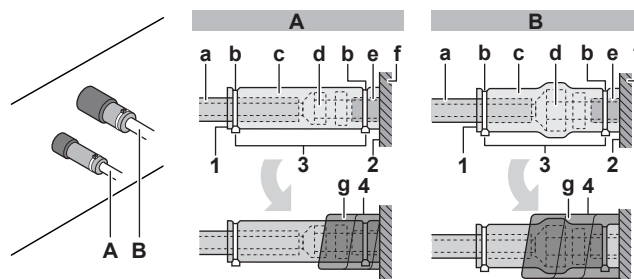

- A Liquid piping
- B Gas piping

- a Insulation material (field supply)

- b** Tie wrap (field supply)
  - c** Insulation pieces: Large (gas pipe), small (liquid pipe) (accessories)
  - d** Flare nut (attached to the unit)
  - e** Refrigerant pipe connection (attached to the unit)
  - f** Unit
  - g** Sealing pads: Medium 1 (gas pipe), medium 2 (liquid pipe) (accessories)
- 1** Turn up the seams of the insulation pieces.
  - 2** Attach to the base of the unit.
  - 3** Tighten the tie wrap on the insulation pieces.
  - 4** Wrap the sealing pad from the base of the unit to the top of the flare nut.

**NOTICE**

Make sure to insulate all refrigerant piping. Any exposed piping might cause condensation.



# 18 Electrical installation

## In this chapter

18.1	About connecting the electrical wiring .....	65
18.1.1	Precautions when connecting the electrical wiring .....	65
18.1.2	Guidelines when connecting the electrical wiring .....	66
18.1.3	Specifications of standard wiring components .....	67
18.2	To connect the electrical wiring to the indoor unit .....	68

## 18.1 About connecting the electrical wiring

### Typical workflow

Connecting the electrical wiring typically consists of the following stages:

- 1 Making sure the power supply system complies with the electrical specifications of the units.
- 2 Connecting the electrical wiring to the outdoor unit.
- 3 Connecting the electrical wiring to the indoor unit.
- 4 Connecting the main power supply.

### 18.1.1 Precautions when connecting the electrical wiring



#### **DANGER: RISK OF ELECTROCUTION**



#### **WARNING**

- All wiring **MUST** be performed by an authorised electrician and **MUST** comply with the applicable legislation.
- Make electrical connections to the fixed wiring.
- All components procured on-site and all electrical construction **MUST** comply with the applicable legislation.



#### **WARNING**

ALWAYS use multicore cable for power supply cables.



#### **INFORMATION**

Also read the precautions and requirements in the "[2 General safety precautions](#)" [[▶ 5](#)].



#### **INFORMATION**

Also read "[18.1.3 Specifications of standard wiring components](#)" [[▶ 67](#)].



**WARNING**

- If the power supply has a missing or wrong N-phase, equipment might break down.
- Establish proper earthing. Do NOT earth the unit to a utility pipe, surge absorber, or telephone earth. Incomplete earthing may cause electrical shock.
- Install the required fuses or circuit breakers.
- Secure the electrical wiring with cable ties so that the cables do NOT come in contact with sharp edges or piping, particularly on the high-pressure side.
- Do NOT use taped wires, stranded conductor wires, extension cords, or connections from a star system. They can cause overheating, electrical shock or fire.
- Do NOT install a phase advancing capacitor, because this unit is equipped with an inverter. A phase advancing capacitor will reduce performance and may cause accidents.



**WARNING**

Use an all-pole disconnection type breaker with at least 3 mm between the contact point gaps that provide full disconnection under overvoltage category III.



**WARNING**

If the supply cord is damaged, it MUST be replaced by the manufacturer, its service agent or similarly qualified persons in order to avoid a hazard.

18.1.2 Guidelines when connecting the electrical wiring

Keep the following in mind:

- If stranded conductor wires are used, install a round crimp-style terminal on the end of the wire. Place the round crimp-style terminal on the wire up to the covered part and fasten the terminal with the appropriate tool.

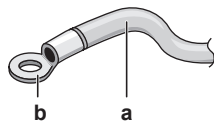

- a** Stranded conductor wire
- b** Round crimp-style terminal

- Use the following methods for installing wires:

Wire type	Installation method
Single-core wire	<p><b>a</b> Curled single-core wire  <b>b</b> Screw  <b>c</b> Flat washer</p>

Wire type	Installation method
Stranded conductor wire with round crimp-style terminal	<p> <b>a</b> Terminal  <b>b</b> Screw  <b>c</b> Flat washer   Allowed   NOT allowed </p>

### Tightening torques

Wiring	Screw size	Tightening torque (N•m)
Power supply cable	M4	1.2~1.4
Transmission cable (indoor↔outdoor)	M3.5	0.79~0.97
User interface cable		

- The earth wire between the wire retainer and the terminal must be longer than the other wires.



### 18.1.3 Specifications of standard wiring components

Component		
Power supply cable	MCA <sup>(a)</sup>	" 18-1 Minimum circuit ampacity" [ 68]
	Voltage	220~240 V/220 V
	Phase	1~
	Frequency	50/60 Hz
	Wire sizes	1.5 mm <sup>2</sup> (3-core wire) H07RN-F (60245 IEC 66)
Transmission wiring	For specification refer to the installation manual of the outdoor unit	
User interface cable	0.75 to 1.25 mm <sup>2</sup> (2-core wire) H05RN-F (60245 IEC 57) Length ≤500 m	
Recommended field fuse	6 A	
Residual current device	Must comply with applicable legislation	

<sup>(a)</sup> MCA=Minimum circuit ampacity. Stated values are maximum values (see electrical data of indoor unit for exact values).

18-1 Minimum circuit ampacity

Class				
50	63	80	100	125
1.8 A	2 A	2.4 A	3 A	3.2 A

## 18.2 To connect the electrical wiring to the indoor unit



### NOTICE

- Follow the wiring diagram (delivered with the unit, located at the inside of the service cover).
- For instructions on how to connect the optional equipment, see the installation manual delivered with the optional equipment.
- Make sure the electrical wiring does NOT obstruct proper reattachment of the service cover.

It is important to keep the power supply and the transmission wiring separated from each other. In order to avoid any electrical interference the distance between both wirings should ALWAYS be at least 50 mm.



### NOTICE

Be sure to keep the power line and transmission line apart from each other. Transmission wiring and power supply wiring may cross, but may NOT run parallel.

- Remove the service cover.
- User interface cable:** Route the cable through the frame, connect the cable to the terminal block (symbols P1, P2).
- Transmission cable:** Route the cable through the frame, connect the cable to the terminal block (make sure the symbols F1, F2 match with the symbols on the outdoor unit). Bundle the transmission cable with the user interface cable and fix them with a tie wrap on the wiring fixture.
- Power supply cable:** Route the cable through the frame and connect the cable to the terminal block (L, N, earth). Fix the cable with a tie wrap on the wiring fixture.



- a Circuit breaker
- b Residual current device

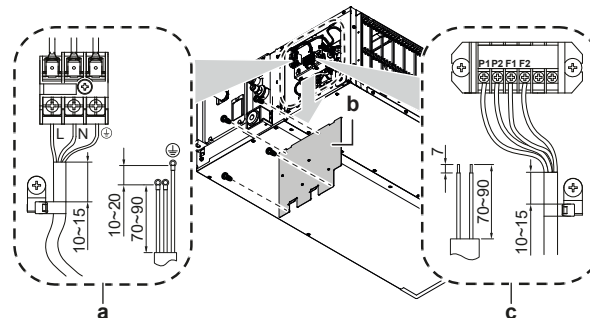

- a Power supply cable
- b Service cover with wiring diagram
- c User interface cable and transmission cable

- 5 Plastic clamp for tie wrap:** Pass tie wraps through the plastic clamps and fasten to fix the cables.

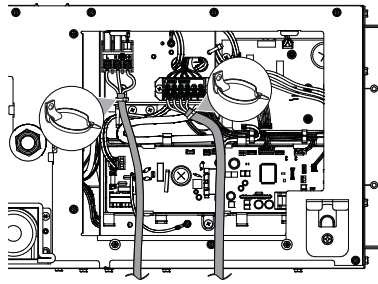

- 6** Reattach the service cover.

### Complete system example

1 user interface controls 1 indoor unit.

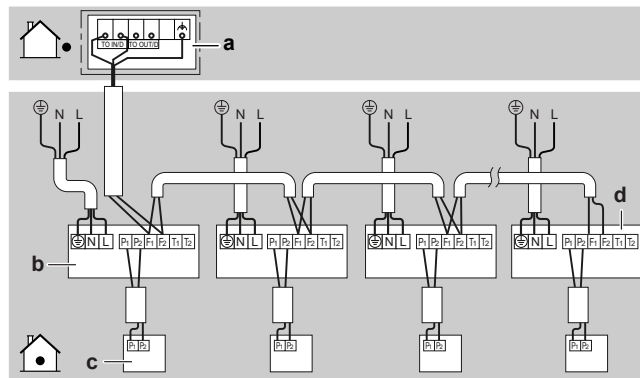

- a Outdoor unit
- b Indoor unit
- c User interface
- d Most downstream indoor unit



#### NOTICE

Group control connection is NOT allowed.



#### CAUTION

- Each indoor unit has to be connected to a separate user interface. Only a safety system compatible remote controller can be used as the user interface. See technical data sheet for remote controller compatibility (e.g. BRC1H52/82\*).
- The user interface has to be put in the same room as the indoor unit. For details, please refer to the installation and operation manual of the user interface.



#### CAUTION

In case shielded wire is used, connect the shielding to the outdoor unit side only.

# 19 Commissioning



## NOTICE

**General commissioning checklist.** Next to the commissioning instructions in this chapter, a general commissioning checklist is also available on the Daikin Business Portal (authentication required).

The general commissioning checklist is complementary to the instructions in this chapter and can be used as a guideline and reporting template during the commissioning and hand-over to the user.

## In this chapter

19.1	Overview: Commissioning .....	70
19.2	Precautions when commissioning.....	70
19.3	Checklist before commissioning.....	71
19.4	To perform a test run .....	71

## 19.1 Overview: Commissioning

This chapter describes what you have to do and know to commission the system after it is installed.

### Typical workflow

Commissioning typically consists of the following stages:

- 1 Checking the "Checklist before commissioning".
- 2 Performing a test run for the system.

## 19.2 Precautions when commissioning



## INFORMATION

During the first running period of the unit, the required power may be higher than stated on the nameplate of the unit. This phenomenon is caused by the compressor, that needs a continuous run time of 50 hours before reaching smooth operation and stable power consumption.



## NOTICE

Before starting up the system, the unit **MUST** be energised for at least 6 hours to avoid compressor breakdown during startup.



## NOTICE

**ALWAYS** operate the unit with thermistors and/or pressure sensors/switches. If **NOT**, burning of the compressor might be the result.



## NOTICE

**Cooling operation mode.** Perform the test run in cooling operation mode so that stop valves failing to open can be detected. Even if the user interface was set to heating operation mode, the unit will run in cooling operation mode during 2-3 minutes (although the user interface will display the heating icon), and then automatically switch to heating operation mode.

## 19.3 Checklist before commissioning

- 1 After the installation of the unit, check the items listed below.
- 2 Close the unit.
- 3 Power up the unit.

<input type="checkbox"/>	You read the complete installation and operation instructions, as described in the <b>installer and user reference guide</b> .
<input type="checkbox"/>	The <b>indoor unit</b> is properly mounted.
<input type="checkbox"/>	The <b>outdoor unit</b> is properly mounted.
<input type="checkbox"/>	Make sure <b>drain piping</b> is properly installed, insulated and drainage flows smoothly. Check for water leaks. <b>Possible consequence:</b> Condensate water might drip.
<input type="checkbox"/>	The <b>ducting</b> is properly installed and insulated.
<input type="checkbox"/>	The <b>refrigerant pipes</b> (gas and liquid) are installed correctly and thermally insulated.
<input type="checkbox"/>	There are NO <b>refrigerant leaks</b> .
<input type="checkbox"/>	There are NO <b>missing phases</b> or <b>reversed phases</b> .
<input type="checkbox"/>	The system is properly <b>earthed</b> and the earth terminals are tightened.
<input type="checkbox"/>	The <b>fuses</b> or locally installed protection devices are installed according to this document, and have NOT been bypassed.
<input type="checkbox"/>	The <b>power supply voltage</b> matches the voltage on the identification label of the unit.
<input type="checkbox"/>	There are NO <b>loose connections</b> or damaged electrical components in the switch box.
<input type="checkbox"/>	There are NO <b>damaged components</b> or <b>squeezed pipes</b> on the inside of the indoor and outdoor units.
<input type="checkbox"/>	The <b>stop valves</b> (gas and liquid) on the outdoor unit are fully open.

## 19.4 To perform a test run



### INFORMATION

- Perform the test run according to the instructions in the outdoor unit manual.
- The test run is only completed if there is no malfunction code displayed on the user interface or the outdoor unit 7-segment display.
- See the service manual for the complete list of error codes and a detailed troubleshooting guideline for each error.



### NOTICE

Do NOT interrupt the test run.

## 20 Configuration

### 20.1 Field setting

Make the following field settings so that they correspond with the actual installation setup and with the needs of the user:

- Bottom suction or rear suction installation
- External static pressure setting using:
  - Airflow automatic adjustment setting
  - User interface
- Air volume when thermostat control is OFF
- Time to clean air filter
- Thermostat sensor selection
- Thermostat differential changeover (if remote sensor is used)
- Differential for automatic changeover
- Auto-restart after power failure
- T1/T2 input setting

#### Setting: Bottom suction or rear suction installation

This setting must correspond with the installation type: rear suction (default) or bottom suction.

If you have the installation with...	Then <sup>(1)</sup>		
	M	SW	—
Rear suction	13(23)	11	01
Bottom suction			02

#### Setting: External static pressure



##### INFORMATION

- The fan speed of the indoor unit is preset to ensure the standard external static pressure.
- To set a higher or lower external static pressure, reset the initial setting with the user interface.

Settings for external static pressure can be achieved in 2 ways:

- Using the airflow automatic adjustment function
- Using the user interface

#### To set external static pressure by airflow automatic adjustment function

<sup>(1)</sup> Field settings are defined as follows:

- **M**: Mode number – **First number**: for group of units – **Number between brackets**: for individual unit
- **SW**: Setting number
- **—**: Value number
- **■**: Default



**NOTICE**

- Do NOT adjust the dampers during the fan only operation for airflow automatic adjustment.
- For the external static pressure higher than 100 Pa, do NOT use airflow automatic adjustment function.
- If the ventilation paths have been changed, perform the airflow automatic adjustment again.

- Test run MUST be done with a dry coil, run the unit for 2 hours with fan only to dry the coil.
- Check if the power supply wiring, duct, air filter are properly attached. If the closing damper is installed in the unit, make sure it is open.
- If there is more than one air inlet and outlet, adjust the dampers so that the airflow rate of each air inlet and outlet is conform with the designed airflow rate.

**1** Operate the unit in **fan only mode** prior to using the airflow automatic adjustment function.

**2** **Stop** the air conditioning unit.

**3** **Set the value** number “—” to 03 for **M** 11(21) and **SW** 7.

**4** **Start** the air conditioning unit.

**Result:** The operation lamp lights up and the unit starts the fan operation for airflow automatic adjustment.

**5** After airflow automatic adjustment is finished (air conditioning unit will stop) check if the value number “—” is set to 02. If there is no change, perform the setting again.

Setting content:	Then <sup>(1)</sup>		
	M	SW	—
Airflow adjustment is OFF	11(21)	7	01
Completion of automatic airflow adjustment			02
Start of automatic airflow adjustment			03

**To set external static pressure by the user interface**

Check the indoor unit setting: the value number “—” must be set to 01 for **M** 11(21) and **SW** 7.

- 1** Change the value number “—” according to the external static pressure of the duct to be connected as in table below.

<sup>(1)</sup> Field settings are defined as follows:

- **M**: Mode number – **First number**: for group of units – **Number between brackets**: for individual unit
- **SW**: Setting number
- —: Value number
- : Default

M	SW	—	External static pressure (Pa) <sup>(1)</sup>
13(23)	6	01	—
		02	50
		03	60
		04	70
		05	80
		06	90
		07	100
		08	110
		09	120
		10	130
		11	140
		12	150
		13	160
		14	180
		15	200

### Setting: Air volume when thermostat control is OFF

This setting must correspond with the needs of the user. It determines the fan speed of the indoor unit during thermostat OFF condition.

- 1 If you have set the fan to operate, set the air volume speed:

If you want...		Then <sup>(1)</sup>		
		M	SW	—
During thermostat OFF at cooling operation	LL <sup>(2)</sup>	12 (22)	6	01
	Setup volume <sup>(2)</sup>			02
	OFF <sup>(a)</sup>			03
	Monitoring 1 <sup>(2)</sup>			04
	Monitoring 2 <sup>(2)</sup>			05
During thermostat OFF at heating operation	LL <sup>(2)</sup>	12 (22)	3	01
	Setup volume <sup>(2)</sup>			02
	OFF <sup>(a)</sup>			03
	Monitoring 1 <sup>(2)</sup>			04
	Monitoring 2 <sup>(2)</sup>			05

<sup>(1)</sup> Field settings are defined as follows:

- **M**: Mode number – **First number**: for group of units – **Number between brackets**: for individual unit
- **SW**: Setting number
- **—**: Value number
- **■**: Default

<sup>(2)</sup> Fan speed:

- **LL**: Low fan speed (set during thermostat OFF)
- **L**: Low fan speed (set by the user interface)
- **Setup volume**: The fan speed corresponds to the speed the user has set (low, medium, high) using the fan speed button on the user interface.
- **Monitoring 1, 2**: The fan is OFF, but runs for a short time every 6 minutes to detect the room temperature by **LL** (Monitoring 1) or by **L** (Monitoring 2).

<sup>(a)</sup> Only use in combination with optional remote sensor or when setting **M** 10 (20), **SW** 2, — 03 is used.

### Setting: Time to clean air filter

This setting must correspond with the air contamination in the room. It determines the interval at which "Time to clean filter" notification is displayed on the user interface.

If you want an interval of... (air contamination)	Then <sup>(1)</sup>		
	M	SW	—
±2500 h (light)	10 (20)	0	01
±1250 h (heavy)			02
Notification ON		3	01
Notification OFF			02

### Setting: Thermostat sensor selection

This setting must correspond with how/if the remote controller thermostat sensor is used.

When the remote controller thermostat sensor is...	Then <sup>(1)</sup>		
	M	SW	—
Used in combination with indoor unit thermistor	10 (20)	2	01
Not used (indoor unit thermistor only)			02
Used exclusively			03

### Setting: Thermostat differential changeover (if remote sensor is used)

If the system contains a remote sensor, set the increase/decrease increments.

If you want to change increments to...	Then <sup>(1)</sup>		
	M	SW	—
1°C	12 (22)	2	01
0.5°C			02

### Setting: Differential for automatic changeover

Set temperature difference between cooling setpoint and heating setpoint in automatic mode (availability depends on the system type). Differential is cooling setpoint minus heating setpoint.

<sup>(1)</sup> Field settings are defined as follows:

- **M**: Mode number – **First number**: for group of units – **Number between brackets**: for individual unit
- **SW**: Setting number
- —: Value number
- : Default

If you want to set...	Then <sup>(1)</sup>			Example
	M	SW	—	
0°C	12 (22)	4	01	cooling 24°C/heating 24°C
1°C			02	cooling 24°C/heating 23°C
2°C			03	cooling 24°C/heating 22°C
3°C			04	cooling 24°C/heating 21°C
4°C			05	cooling 24°C/heating 20°C
5°C			06	cooling 24°C/heating 19°C
6°C			07	cooling 24°C/heating 18°C
7°C			08	cooling 24°C/heating 17°C

**Setting: Auto-restart after power failure**

Depending on the needs of the user, you may disable/enable the automatic restart after a power failure.

If you want auto-restart after power failure...	Then <sup>(1)</sup>		
	M	SW	—
Disabled	12 (22)	5	01
Enabled			02

**Setting: T1/T2 input setting**



**WARNING**

In case of R32 refrigerant, terminal connections T1/T2 are for fire alarm input ONLY. Fire alarm has a higher priority than R32 safety and shuts the entire system down.

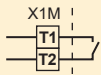

**a** Fire alarm input signal (potential free contact)

Remote control is available by transmission the external input to the terminals T1 and T2 on the terminal block for the user interface and the transmission wiring.

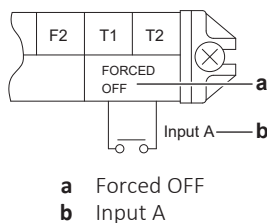

Wiring requirements	
Wiring specification	Sheathed vinyl cord or 2-core cable
Wiring size	0.75~1.25 mm <sup>2</sup>
Wiring length	Maximum 100 m
External contact specification	Contact that can make and break the min. load of DC15 V · 1 mA

<sup>(1)</sup> Field settings are defined as follows:

- **M**: Mode number – **First number**: for group of units – **Number between brackets**: for individual unit
- **SW**: Setting number
- **—**: Value number
- **■**: Default

This setting must correspond with the needs of the user.

If you want to set...	Then <sup>(1)</sup>		
	M	SW	—
Forced OFF	12 (22)	1	01
ON/OFF Operation			02
Emergency (recommended for alarm operation)			03
Forced OFF - multi tenant			04
Interlocking setting A			05
Interlocking setting B			06

<sup>(1)</sup> Field settings are defined as follows:

- **M**: Mode number – **First number**: for group of units – **Number between brackets**: for individual unit
- **SW**: Setting number
- —: Value number
- : Default

## 21 Hand-over to the user

Once the test run is finished and the unit operates properly, please make sure the following is clear for the user:

- Make sure that the user has the printed documentation and ask him/her to keep it for future reference. Inform the user that he can find the complete documentation at the URL mentioned earlier in this manual.
- Explain the user how to properly operate the system and what to do in case of problems.
- Show the user what to do for the maintenance of the unit.

## 22 Troubleshooting

### 22.1 Solving problems based on error codes

If the unit runs into a problem, the user interface displays an error code. It is important to understand the problem and to take measures before resetting an error code. This should be done by a licensed installer or by your local dealer.

This chapter gives you an overview of most possible error codes and their descriptions as they appear on the user interface.



#### INFORMATION

See the service manual for:

- The complete list of error codes
- A more detailed troubleshooting guideline for each error

#### 22.1.1 Error codes: Overview

In case other error codes appear, contact your dealer.

Code	Description
<i>RD-11</i>	The R32 sensor has detected a refrigerant leak
<i>RD/CH</i>	Safety system error (leak detection)
<i>CH-01</i>	R32 sensor malfunction
<i>CH-02</i>	R32 sensor end of lifetime
<i>CH-05</i>	6 months before the R32 sensor end of lifetime
<i>R1</i>	Malfunction of indoor unit PCB
<i>R3</i>	Drain level control system abnormality
<i>R4</i>	Malfunction of freezing protection
<i>R5</i>	High pressure control in heating, freeze-up protection control in cooling
<i>R6</i>	Malfunction of fan motor
<i>R7</i>	Malfunction of swing flap motor
<i>R8</i>	Malfunction of power supply or AC input overcurrent
<i>R9</i>	Malfunction of electronic expansion valve
<i>RF</i>	Malfunction of a humidifier system
<i>RH</i>	Malfunction of dust collector of air cleaner
<i>RJ</i>	Malfunction of capacity setting (Indoor unit PCB)
<i>C1</i>	Failure of transmission (between indoor unit PCB and sub PCB)
<i>C4</i>	Malfunction of liquid pipe thermistor for heat exchanger
<i>C5</i>	Malfunction of gas pipe thermistor for heat exchanger
<i>C6</i>	Malfunction of gas pipe thermistor for heat exchanger
<i>C9</i>	Malfunction of suction air thermistor
<i>CR</i>	Malfunction of discharge air thermistor

Code	Description
EJ	Room temperature thermistor in remote controller abnormality



## 23 Disposal

**NOTICE**

Do NOT try to dismantle the system yourself: dismantling of the system, treatment of the refrigerant, oil and other parts **MUST** comply with applicable legislation. Units **MUST** be treated at a specialised treatment facility for reuse, recycling and recovery.

















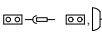

## 24 Technical data

- A **subset** of the latest technical data is available on the regional Daikin website (publicly accessible).
- The **full set** of latest technical data is available on the Daikin Business Portal (authentication required).

### 24.1 Wiring diagram

#### 24.1.1 Unified wiring diagram legend

For applied parts and numbering, refer to the wiring diagram on the unit. Part numbering is by Arabic numbers in ascending order for each part and is represented in the overview below by "\*" in the part code.

Symbol	Meaning	Symbol	Meaning
	Circuit breaker		Protective earth
			
			
	Connection		Protective earth (screw)
	Connector		Rectifier
	Earth		Relay connector
	Field wiring		Short-circuit connector
	Fuse		Terminal
	Indoor unit		Terminal strip
	Outdoor unit		Wire clamp
	Residual current device		

Symbol	Colour	Symbol	Colour
BLK	Black	ORG	Orange
BLU	Blue	PNK	Pink
BRN	Brown	PRP, PPL	Purple
GRN	Green	RED	Red
GRY	Grey	WHT	White
SKY BLU	Sky blue	YLW	Yellow

Symbol	Meaning
A*P	Printed circuit board
BS*	Pushbutton ON/OFF, operation switch
BZ, H*O	Buzzer
C*	Capacitor

Symbol	Meaning
AC*, CN*, E*, HA*, HE*, HL*, HN*, HR*, MR*_A, MR*_B, S*, U, V, W, X*A, K*R_*, NE	Connection, connector
D*, V*D	Diode
DB*	Diode bridge
DS*	DIP switch
E*H	Heater
FU*, F*U, (for characteristics, refer to PCB inside your unit)	Fuse
FG*	Connector (frame ground)
H*	Harness
H*P, LED*, V*L	Pilot lamp, light emitting diode
HAP	Light emitting diode (service monitor green)
HIGH VOLTAGE	High voltage
IES	Intelligent eye sensor
IPM*	Intelligent power module
K*R, KCR, KFR, KHuR, K*M	Magnetic relay
L	Live
L*	Coil
L*R	Reactor
M*	Stepper motor
M*C	Compressor motor
M*F	Fan motor
M*P	Drain pump motor
M*S	Swing motor
MR*, MRCW*, MRM*, MRN*	Magnetic relay
N	Neutral
n=*, N=*	Number of passes through ferrite core
PAM	Pulse-amplitude modulation
PCB*	Printed circuit board
PM*	Power module
PS	Switching power supply
PTC*	PTC thermistor
Q*	Insulated gate bipolar transistor (IGBT)
Q*C	Circuit breaker
Q*DI, KLM	Earth leak circuit breaker
Q*L	Overload protector

Symbol	Meaning
Q*M	Thermo switch
Q*R	Residual current device
R*	Resistor
R*T	Thermistor
RC	Receiver
S*C	Limit switch
S*L	Float switch
S*NG	Refrigerant leak detector
S*NPH	Pressure sensor (high)
S*NPL	Pressure sensor (low)
S*PH, HPS*	Pressure switch (high)
S*PL	Pressure switch (low)
S*T	Thermostat
S*RH	Humidity sensor
S*W, SW*	Operation switch
SA*, F1S	Surge arrester
SR*, WLU	Signal receiver
SS*	Selector switch
SHEET METAL	Terminal strip fixed plate
T*R	Transformer
TC, TRC	Transmitter
V*, R*V	Varistor
V*R	Diode bridge, Insulated-gate bipolar transistor (IGBT) power module
WRC	Wireless remote controller
X*	Terminal
X*M	Terminal strip (block)
Y*E	Electronic expansion valve coil
Y*R, Y*S	Reversing solenoid valve coil
Z*C	Ferrite core
ZF, Z*F	Noise filter

## 25 Glossary

**Dealer**

Sales distributor for the product.

**Authorised installer**

Technical skilled person who is qualified to install the product.

**User**

Person who is owner of the product and/or operates the product.

**Applicable legislation**

All international, European, national and local directives, laws, regulations and/or codes that are relevant and applicable for a certain product or domain.

**Service company**

Qualified company which can perform or coordinate the required service to the product.

**Installation manual**

Instruction manual specified for a certain product or application, explaining how to install, configure and maintain it.

**Operation manual**

Instruction manual specified for a certain product or application, explaining how to operate it.

**Maintenance instructions**

Instruction manual specified for a certain product or application, which explains (if relevant) how to install, configure, operate and/or maintain the product or application.

**Accessories**

Labels, manuals, information sheets and equipment that are delivered with the product and that need to be installed according to the instructions in the accompanying documentation.

**Optional equipment**

Equipment made or approved by Daikin that can be combined with the product according to the instructions in the accompanying documentation.

**Field supply**

Equipment NOT made by Daikin that can be combined with the product according to the instructions in the accompanying documentation.





ERC