

VS-900
Vital Signs Monitor
Operator's Manual



© Copyright 2013-2016 Shenzhen Mindray Bio-Medical Electronics Co., Ltd. All rights reserved.

Release date: April 2016.
Revision: 7.0

Intellectual Property Statement

SHENZHEN MINDRAY BIO-MEDICAL ELECTRONICS CO., LTD. (hereinafter called Mindray) owns the intellectual property rights to this Mindray product and this manual. This manual may refer to information protected by copyrights or patents and does not convey any license under the patent rights of Mindray, nor the rights of others.

Mindray intends to maintain the contents of this manual as confidential information. Disclosure of the information in this manual in any manner whatsoever without the written permission of Mindray is strictly forbidden.

Release, amendment, reproduction, distribution, rental, adaption and translation of this manual in any manner whatsoever without the written permission of Mindray is strictly forbidden.

 **mindray** , **MINDRAY**, and **MINDRAY** are the registered trademarks or trademarks owned by Mindray in China and other countries. All other trademarks that appear in this manual are used only for editorial purposes without the intention of improperly using them. They are the property of their respective owners.

Responsibility on the Manufacturer Party

Contents of this manual are subject to changes without prior notice.

All information contained in this manual is believed to be correct. Mindray shall not be liable for errors contained herein nor for incidental or consequential damages in connection with the furnishing, performance, or use of this manual.

Mindray is responsible for the effects on safety, reliability and performance of this product, only if:

- all installation operations, expansions, changes, modifications and repairs of this product are conducted by Mindray authorized personnel;
- the electrical installation of the relevant room complies with the applicable national and local requirements;
- the product is used in accordance with the instructions for use.



WARNING

- **This equipment must be operated by skilled/trained clinical professionals.**
 - **It is important for the hospital or organization that employs this equipment to carry out a reasonable service/maintenance plan. Neglect of this may result in machine breakdown or personal injury.**
-
-

Warranty

THIS WARRANTY IS EXCLUSIVE AND IS IN LIEU OF ALL OTHER WARRANTIES, EXPRESSED OR IMPLIED, INCLUDING WARRANTIES OF MERCHANTABILITY OR FITNESS FOR ANY PARTICULAR PURPOSE.

Exemptions

Mindray's obligation or liability under this warranty does not include any transportation or other charges or liability for direct, indirect or consequential damages or delay resulting from the improper use or application of the product or the use of parts or accessories not approved by Mindray or repairs by people other than Mindray authorized personnel.

This warranty shall not extend to

- Malfunction or damage caused by improper use or man-made failure.
- Malfunction or damage caused by unstable or out-of-range power input.
- Malfunction or damage caused by force majeure such as fire and earthquake.
- Malfunction or damage caused by improper operation or repair by unqualified or unauthorized service people.
- Malfunction of the instrument or part whose serial number is not legible enough.
- Others not caused by instrument or part itself.

Company Contact

Manufacturer:	Shenzhen Mindray Bio-Medical Electronics Co., Ltd.
Address	Mindray Building, Keji 12th Road South, Hi-tech industrial park, Nanshan, Shenzhen 518057, P.R.China
Website	www.mindray.com
E-mail Address:	service@mindray.com.cn
Tel:	+86 755 81888998
Fax:	+86 755 26582680
EC-Representative:	Shanghai International Holding Corp. GmbH (Europe)
Address:	Eiffestraße 80, 20537 Hamburg, Germany
Tel:	0049-40-2513175
Fax:	0049-40-255726

Preface

Manual Purpose

This manual contains the instructions necessary to operate the product safely and in accordance with its function and intended use. Observance of this manual is a prerequisite for proper product performance and correct operation and ensures patient and operator safety.

This manual is based on the maximum configuration and therefore some contents may not apply to your product. If you have any question, please contact us.

This manual is an integral part of the product. It should always be kept close to the equipment so that it can be obtained conveniently when needed.

Intended Audience

This manual is geared for clinical professionals who are expected to have corresponding working knowledge of medical procedures, practices and terminology as required for monitoring of patients.

Illustrations

All illustrations in this manual serve as examples only. They may not necessarily reflect the setup or data displayed on your equipment.

Conventions

- ***Italic text*** is used in this manual to quote the referenced chapters or sections.
- [] is used to enclose screen texts.
- → is used to indicate operational procedures.

Contents

1 Safety	1-1
1.1 Safety Information.....	1-1
1.1.1 Warnings.....	1-1
1.1.2 Cautions.....	1-3
1.1.3 Notes.....	1-4
1.2 Equipment Symbols.....	1-5
2 The Basics	2-1
2.1 Intended Use.....	2-1
2.2 Applied Parts.....	2-1
2.3 Main unit.....	2-2
2.3.1 Front View.....	2-2
2.3.2 Side View.....	2-4
2.3.3 Rear View.....	2-5
2.3.4 Bottom View.....	2-6
2.4 Main Screen.....	2-7
2.5 Menu.....	2-10
2.6 Operating Modes.....	2-10
2.6.1 Monitor Mode.....	2-10
2.6.2 Spot Check Mode.....	2-11
2.6.3 Standby Mode.....	2-11
2.6.4 Demo Mode.....	2-12
3 Basic Operations	3-1
3.1 Installation.....	3-1
3.1.1 Unpacking and Checking.....	3-2
3.1.2 Environmental Requirements.....	3-2
3.2 General Operation.....	3-3
3.2.1 Connection to AC Power.....	3-3
3.2.2 Using a Battery.....	3-3
3.2.3 Connecting Accessories.....	3-4
3.3 Turning On/Off Power.....	3-4
3.3.1 Check before Power On.....	3-4
3.3.2 Turning Power On.....	3-4
3.3.3 Turning off the Monitor.....	3-5
3.4 Using Key, Knob, Touchscreen.....	3-6
3.4.1 Using Keys.....	3-6
3.4.2 Using the Knob.....	3-6
3.4.3 Using the Touchscreen.....	3-6
3.5 Changing General Settings.....	3-6
3.5.1 Setting up a Monitor.....	3-7
3.5.2 Changing Language.....	3-7
3.5.3 Configuring the Timeout of Clinician ID.....	3-7
3.5.4 Showing/Hiding Patient Name.....	3-7
3.5.5 Adjusting Alarm Volume.....	3-7

3.5.6 Adjusting Key Volume	3-8
3.5.7 Adjusting the Screen Brightness	3-8
3.5.8 Setting Screen	3-8
3.5.9 Configuring the Timeout of Measured Value.....	3-8
3.5.10 Configuring Measurement Colors	3-9
3.5.11 Setting the Date and Time.....	3-9
3.5.12 Configuring Unit	3-9
3.5.13 Configuring Printout	3-9
3.5.14 Selecting a Central Monitoring System	3-9
3.5.15 Clearing the Selected CMS at Startup.....	3-9
4 Patient Data Management.....	4-1
4.1 Admitting a Patient	4-1
4.1.1 Admitting a Patient by the Admit Patient Hardkey	4-1
4.1.2 Admitting a Patient by Barcode Scanner	4-2
4.1.3 Admitting a Patient from [Patient List].....	4-4
4.2 Manually Input Patient Data.....	4-5
4.3 Manually Save Patient Data	4-6
4.4 Reviewing Patient Data	4-7
4.4.1 Spot Check Trends	4-7
4.4.2 Continuous Trends.....	4-8
4.4.3 Graphic Trends.....	4-9
4.5 Transferring Data from the Monitor to USB Drive	4-10
5 Managing Configurations	5-1
5.1 Overview.....	5-1
5.2 Accessing [Manage Configuration] Menu.....	5-1
5.2.1 Setting Default Configuration	5-2
5.3 Saving Current Settings.....	5-2
5.4 Deleting a Configuration	5-2
5.5 Transferring a Configuration	5-3
5.6 Loading a Configuration	5-3
5.7 Restoring the Latest Configuration Automatically	5-4
6 Alarms	6-1
6.1 Alarm Categories	6-1
6.2 Alarm Levels.....	6-2
6.3 Alarm Indicators.....	6-2
6.3.1 Alarm Lamp	6-2
6.3.2 Audible Alarm Tones	6-3
6.3.3 Alarm Messages.....	6-3
6.3.4 Flashing Numerics.....	6-4
6.3.5 Alarm Status Symbols.....	6-4
6.4 Setting Alarms	6-4
6.5 Selecting Alarm Properties	6-5
6.5.1 Changing the Alarm Volume.....	6-5
6.5.2 Setting the Minimum Alarm Volume	6-5
6.5.3 Setting the Interval between Alarm Sounds	6-5
6.5.4 Adjusting Alarm Limits Automatically.....	6-6

6.6 Pausing Alarms	6-8
6.7 Switching Off Alarm Sound	6-8
6.8 Resetting Alarms	6-8
6.9 Setting the Reminder Tone	6-9
6.10 Latching Alarms	6-10
6.11 Actions for Alarm Occurrence	6-10
6.12 Nurse Call	6-11
7 Monitoring SpO₂	7-1
7.1 Overview	7-1
7.2 Safety	7-2
7.3 Identifying SpO ₂ Module	7-2
7.4 Applying the Sensor	7-3
7.5 Changing SpO ₂ Settings	7-3
7.5.1 Accessing SpO ₂ Menu	7-3
7.5.2 Adjusting the Desat Alarm	7-3
7.5.3 Setting SpO ₂ Sensitivity	7-4
7.5.4 Changing Averaging Time	7-4
7.5.5 Monitoring SpO ₂ and NIBP Simultaneously	7-4
7.5.6 Sat-Seconds Alarm Management	7-4
7.5.7 Changing the Speed of Pleth Wave	7-6
7.5.8 Setting the Alarm Level for SpO ₂ Sensor Off Alarm	7-6
7.6 Measurement Limitations	7-6
7.7 Masimo Information	7-7
7.8 Nellcor Information	7-7
8 Monitoring PR	8-1
8.1 Overview	8-1
8.2 PR Source	8-1
8.3 Pulse Tone	8-1
9 Monitoring NIBP	9-1
9.1 Overview	9-1
9.2 Safety	9-2
9.3 Measurement Limitations	9-3
9.4 NIBP Measurement Mode	9-3
9.5 Measuring NIBP	9-4
9.5.1 Preparing the Patient	9-4
9.5.2 Preparation to Measure NIBP	9-4
9.5.3 Starting NIBP measurement	9-5
9.5.4 Stopping NIBP Measurement	9-5
9.5.5 Correcting the Measurement if Limb is not at Heart Level	9-5
9.6 Understanding the NIBP Numerics	9-6
9.7 Setting NIBP	9-6
9.7.1 Setting Interval	9-6
9.7.2 Setting the Initial Cuff Inflation Pressure	9-6
9.7.3 Setting NIBP End Tone	9-7
9.7.4 Switching On/Off Measurement on Clock	9-7
9.7.5 Configuring a Custom Program	9-7

9.7.6 Setting NIBP Alarm Properties	9-8
9.7.7 Setting the Pressure Unit.....	9-8
9.8 Assisting Venous Puncture.....	9-9
10 Monitoring Temp	10-1
10.1 Monitoring Temp with SmarTemp™ Module	10-1
10.1.1 Setting Temp.....	10-2
10.1.2 Measuring Temp.....	10-2
10.1.3 Disinfecting Temperature Probe	10-4
10.2 Monitoring Temp with THP79JU Infrared Ear Thermometer	10-5
10.2.1 Measuring Temperature.....	10-5
10.2.2 Understanding the Numerics.....	10-8
10.2.3 Troubleshooting.....	10-9
10.2.4 Cleaning and Disinfecting the Ear Thermometer	10-9
10.3 Monitoring Temp with Genius™ 2 Tympanic Thermometer.....	10-9
10.3.1 Safety Information.....	10-9
10.3.2 Thermometer Buttons.....	10-10
10.3.3 Equivalence Mode Temperature	10-10
10.3.4 Taking an Temperature	10-11
10.3.5 Temperature Display.....	10-12
10.3.6 Troubleshooting.....	10-12
10.3.7 Cleaning and Disinfecting the Tympanic Thermometer.....	10-12
11 Monitoring CO₂	11-1
11.1 Overview	11-1
11.2 Safety	11-1
11.3 Measurement Limitations.....	11-1
11.4 CO ₂ Display	11-2
11.5 Measuring CO ₂	11-2
11.6 Automatic CO ₂ Module Zeroing	11-4
11.7 Changing CO ₂ Settings.....	11-4
11.7.1 Changing CO ₂ Alarm Settings.....	11-4
11.7.2 Setting the Apnea Alarm Delay.....	11-4
11.7.3 Setting the CO ₂ Waveform.....	11-4
11.7.4 Entering the Standby Mode.....	11-5
11.7.5 Setting the Auto Standby	11-5
11.7.6 Setting Humidity Compensation.....	11-5
11.7.7 Setting Gas Compensation	11-6
11.7.8 Automatic Barometric Pressure.....	11-6
11.7.9 Calibrating the CO ₂ Module.....	11-6
12 Clinical Scoring	12-1
12.1 Overview	12-1
12.1.1 MEWS (Modified Early Warning Score).....	12-1
12.1.2 NEWS (National Early Warning Score).....	12-1
12.1.3 Customizable Scoring	12-2
12.2 Entering the Calculation Screen	12-2
12.2.1 Scoring Screen	12-2
12.2.2 Score Tile	12-3

12.3 Calculating a Score	12-3
12.4 Clinical Scoring Screen	12-3
12.4.1 Score Tile in the Main Screen	12-3
12.4.2 Scoring Screen	12-4
12.5 Obtaining the Total Score	12-5
12.6 Managing Scorings.....	12-7
12.6.1 Importing the Scoring	12-7
12.6.2 Selecting Default Scoring.....	12-7
12.6.3 Deleting the Scoring.....	12-7
12.6.4 Loading a Scoring	12-7
13 Recording.....	13-1
13.1 Using a Recorder	13-1
13.2 Loading Paper	13-1
13.3 Setting the Recorder	13-2
13.4 Starting and Stopping Recordings.....	13-2
13.5 Reports.....	13-3
13.5.1 Real-time Recording.....	13-3
13.5.2 Graphic Trend Recording	13-3
13.5.3 Continuous Trends Recording.....	13-3
13.5.4 Spot Check Trends Recording	13-4
13.6 Removing Paper Jam	13-4
13.7 Cleaning the Recorder Printhead.....	13-4
14 Network.....	14-1
14.1 Network Connection.....	14-1
14.2 Network Type and Settings	14-1
14.2.1 Wireless Network	14-2
14.2.2 WLAN Test	14-2
14.3 Setting Data Send Method.....	14-3
14.3.1 ADT Communication Setup.....	14-3
14.3.2 EMR Communication Setup.....	14-3
14.3.3 NTP Server Setup	14-3
14.3.4 Realtime Date Send Interval (for HL7 only).....	14-4
14.3.5 Alarm Server Setup (for HL7 only)	14-4
14.4 Connecting the monitor to the CMS	14-4
14.4.1 Setting the CMS.....	14-5
14.4.2 Selecting a CMS	14-5
14.4.3 Clearing the Selected CMS at Startup.....	14-5
14.5 Certificates Maintenance	14-5
14.6 Setting the Multicast Parameters.....	14-6
14.7 DIAP Communication Setup	14-6
15 Battery.....	15-1
15.1 Overview	15-1
15.2 Charging a Battery	15-2
15.3 Replacing a Battery.....	15-2
15.4 Battery Guidelines	15-2
15.5 Battery Maintenance	15-3

15.5.1 Conditioning a Battery.....	15-3
15.5.2 Checking a Battery	15-3
15.6 Recycling a Battery	15-4
16 Care and Maintenance	16-1
16.1 Cleaning and Disinfection	16-1
16.1.1 Cleaning	16-2
16.1.2 Disinfecting.....	16-3
16.2 General Inspection	16-3
16.3 Maintenance and Testing Schedule.....	16-3
16.4 Checking Monitor Information.....	16-5
16.5 NIBP Test	16-6
16.5.1 NIBP Leakage Test.....	16-6
16.5.2 NIBP Accuracy Test	16-7
16.6 CO ₂ Test	16-8
16.6.1 CO ₂ Leakage Test.....	16-8
16.6.2 CO ₂ Accuracy Test	16-8
16.6.3 Calibrating CO ₂	16-9
16.7 Calibrating the Touchscreen	16-10
16.8 Formatting the Storage Card.....	16-10
16.9 Modifying Password.....	16-10
17 Accessories.....	17-1
17.1 SpO ₂ Accessories	17-1
17.2 NIBP Accessories.....	17-3
17.3 Temp Accessories	17-4
17.3.1 SmarTemp™ Accessories	17-4
17.3.2 THP79JU Ear Thermometer Accessories.....	17-5
17.3.3 Genius™ 2 Tympanic Thermometer Accessories.....	17-5
17.4 CO ₂ Accessories.....	17-5
A Product Specifications	A-1
A.1 Classifications	A-1
A.2 Environmental Specifications.....	A-1
A.3 Power Supply Specifications.....	A-2
A.4 Physical Specifications	A-3
A.5 Hardware Specifications.....	A-3
A.6 Measurement Specifications.....	A-4
B EMC and Radio Regulatory Compliance	B-1
B.1 EMC.....	B-1
B.2 Radio Regulatory Compliance.....	B-6
C Default Configurations	C-1
C.1 Parameter Configuration.....	C-1
C.2 General configuration	C-5
C.3 User Maintenance Items.....	C-6
D Alarm Messages	D-1

D.1 Physiological Alarm Messages D-1
D.2 Technical Alarm Messages D-1

E Electrical Safety Inspection E-1

E.1 Power Cord Plug E-1
E.2 Device Enclosure and Accessories E-2
E.3 Device Labeling E-2
E.4 Protective Earth Resistance E-2
E.5 Earth Leakage Test E-3
E.6 Patient Leakage Current E-3
E.7 Mains on Applied Part Leakage E-4

F Symbols and Abbreviations F-1

F.1 Symbols F-1
F.2 Abbreviations F-3

FOR YOUR NOTES

1 Safety

1.1 Safety Information



WARNING

- Indicates a potential hazard situation or unsafe practice that, if not avoided, could result in death or serious injury.
-
-



CAUTION

- Indicates a potential hazard or unsafe practice that, if not avoided, could result in minor personal injury or product/property damage.
-
-

NOTE

- Provides application tips or other useful information to ensure that you get the most from your product.
-
-

1.1.1 Warnings



WARNING

- This equipment is used for single patient at a time.
 - Before putting the system into operation, the operator must verify that the equipment, connecting cables and accessories are in correct working order and operating condition.
 - To avoid risk of electric shock, this equipment must only be connected to a supply mains with protective earth. If the installation does not provide for a protective earth conductor, disconnect it from the power line and operate it on battery power, if possible.
 - Ensure that the patient monitor is supplied with continuous electric power during work. Sudden power failure leads to the loss of patient data.
 - To avoid explosion hazard, do not use the equipment in the presence of oxygen –rich atmospheres, flammable anesthetics, or other flammable agents (such as gasoline).
-
-

-
- **Do not open the equipment housings. All servicing and future upgrades must be carried out by the personnel trained and authorized by our company only.**
 - **Do not come into contact with patients during defibrillation. Otherwise serious injury or death could result.**
 - **Do not touch the equipment's metal parts or connectors when in contact with the patient; otherwise patient injury may result.**
 - **Do not rely exclusively on the audible alarm system for patient monitoring. Adjustment of alarm volume to a low level or off may result in a hazard to the patient. Remember that alarm settings should be customized according to different patient situations and always keeping the patient under close surveillance is the most reliable way for safe patient monitoring.**
 - **The physiological data and alarm messages displayed on the equipment are for reference only and cannot be directly used for diagnostic interpretation and replace the competent judgment of a clinician.**
 - **To avoid inadvertent disconnection, route all cables in a way to prevent a stumbling hazard. Wrap and secure excess cabling to reduce risk of entanglement or strangulation by patients or personnel.**
 - **When disposing of the packaging material, be sure to observe the applicable waste control regulations and keep it out of children's reach.**
 - **When no battery is installed, make sure that the power supply is continuous. A power interruption will result in patient data loss.**
 - **Put the equipment in a location where you can easily see the screen, access the operating controls, and disconnect the equipment from AC power.**
 - **The equipment uses a mains plug as isolation means to the mains power supply. Please do not position the equipment in a place difficult to operate the mains plug.**
 - **The equipment is not intended to be used within the magnetic resonance (MR) environment.**
-

1.1.2 Cautions



CAUTION

- **Use only parts and accessories specified in this manual.**
 - **Remove the battery before shipping the monitor or if it will not be used for an extended period of time.**
 - **Carefully route patient cabling to reduce the possibility of patient entanglement or strangulation.**
 - **Disposable accessories are not designed to be reused. Reuse may cause a risk of contamination and affect the measurement accuracy.**
 - **At the end of its service life, the equipment, as well as its accessories, must be disposed of in compliance with the guidelines regulating the disposal of such products. If you have any questions concerning disposal of the equipment, please contact Mindray.**
 - **Magnetic and electrical fields are capable of interfering with the proper performance of the equipment. For this reason, make sure that all external devices operated in the vicinity of the equipment comply with the relevant EMC requirements. Mobile phone, X-ray equipment or MRI devices are a possible source of interference as they may emit higher levels of electromagnetic radiation.**
 - **Before connecting the equipment to the power line, check that the voltage and frequency ratings of the power line are the same as those indicated on the equipment's label or in this manual.**
 - **Always install or carry the equipment properly to avoid damage caused by drop, impact, strong vibration or other mechanical force.**
 - **If you spill liquid on the equipment or accessories, contact us or your service personnel.**
-



























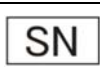

1.1.3 Notes



NOTE

- **Put the equipment in a location where you can easily view and operate the equipment. Keep this manual in the vicinity of the equipment so that it can be obtained conveniently when needed.**
 - **The software was developed in compliance with IEC60601-1. The possibility of hazards arising from software errors is minimized.**
 - **This manual describes all features and options. Your equipment may not have all of them.**
 - **During normal use, the operator is expected to face the front of the equipment.**
 - **The equipment uses a mains plug as a means of isolation to the mains power supply. Do not position the equipment in a place difficult to access the mains plug.**
 - **Only the central monitoring system with a software version 06.08.00 or greater, or the eGateway with a software version 5.0 or greater, supports VS-900 monitor.**
-

1.2 Equipment Symbols

Some symbols may not appear on your equipment.

	General warning sign		ON/OFF for a part of equipment
	Alternating current		Battery indicator
	Alarm Reset		NIBP Start/Stop key
	ALARM PAUSED		Graphical recorder
	Admit patient		Insertion Direction
	DEFIBRILLATION –PROOF TYPE CF APPLIED PART		Input/Output
	DEFIBRILLATION-PROOF TYPE BF APPLIED PART		Equipotentiality
	USB connector		MANUFACTURER
	Serial number		DATE OF MANUFACTURE
	AUTHORISED REPRESENTATIVE IN THE EUROPEAN COMMUNITY		Protection against fluid ingress
	CATALOGUE NUMBER		Humidity limitation
	Temperature limit		Atmospheric pressure limitation
	Interference may occur in the vicinity of equipment marked with this symbol		Refer to instruction manual/booklet
	Gas outlet		Gas sample inlet

	<p>Network connector</p>
	<p>The product bears CE mark indicating its conformity with the provisions of the Council Directive 93/42/EEC concerning medical devices and fulfils the essential requirements of Annex I of this directive. Note: The product complies with the Council Directive 2011/65/EU.</p>
	<p>The following definition of the WEEE label applies to EU member states only. This symbol indicates that this product should not be treated as household waste. By ensuring that this product is disposed of correctly, you will help prevent bringing potential negative consequences to the environment and human health. For more detailed information with regard to returning and recycling this product, please consult the distributor from whom you purchased it. * For system products, this label may be attached to the main unit only.</p>

2 The Basics

2.1 Intended Use

The Monitor is intended for monitoring physiologic parameters, including SpO₂, PR, NIBP, TEMP, and CO₂ on adult, pediatric, and neonatal patients in healthcare facilities by clinical physicians or appropriate medical staff under the direction of physicians.



WARNING

- **This equipment is intended for use only by clinical professionals or under their guidance. It must only be used by persons who have received adequate training in its use. Anyone unauthorized or untrained must not perform any operation on it.**
-

2.2 Applied Parts

The applied parts of the monitor include followings:

- SpO₂ sensor and cable
- NIBP tubing and cuff
- Temp probes and cable
- CO₂ sample line

2.3 Main unit

2.3.1 Front View

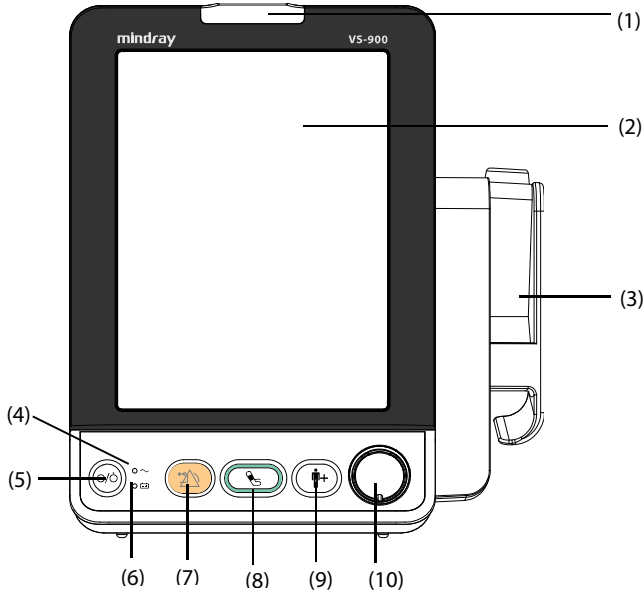

(1) Alarm indicator

When a physiological alarm or a technical alarm occurs, this indicator will flash as defined below.

- ◆ High priority alarm: the lamp quickly flashes red.
- ◆ Medium priority alarm: the lamp slowly flashes yellow.
- ◆ Low priority alarm: the lamp is yellow without flashing.

(2) Display screen

(3) Temperature module and base

The monitor can be configured with any one of the following modules.

- ◆ SmarTemp™ module: measures predictive temperature.
- ◆ THP79JU module: measures ear temperature.
- ◆ Genius™ 2 module: measures tympanic temperature.

The temperature module varies in appearance. The above figure shows the main unit with the SmarTemp™ module.

(4) AC power indicator

- ◆ On: indicates that the monitor is connected to the AC power.
- ◆ Off: indicates that the monitor is not connected to the AC power.

(5) Power ON/OFF switch

- ◆ Press this key to turn the monitor on.
- ◆ If no parameter is being measured, press this key to enter Standby mode.
- ◆ When the monitor is on, press and hold this key for above 2 seconds to turn the monitor off.

An indicator is built in this switch. It turns on when the monitor is on and turns off when the monitor is off.

(6) Battery indicator

- ◆ On: indicates that the battery is installed and AC power is connected.
- ◆ Off: indicates that the battery is not installed.
- ◆ Flash: indicates that the monitor is powered by battery.

(7) Alarm Reset key

- ◆ Press this key to disable the audio of present alarms.
- ◆ Press and hold this key for more than 2 seconds to pause or restore alarms.

(8) NIBP Start/Stop key

Press to start or stop NIBP measurements.

(9) Admit patient key

- ◆ Press this key to admit a new patient.
- ◆ Press this key to return to the main screen.

(10) Knob

- ◆ Rotate the knob clockwise or counterclockwise to move the cursor.
- ◆ Press the knob to select one item, such as accessing a menu or confirming the selection.

2.3.2 Side View

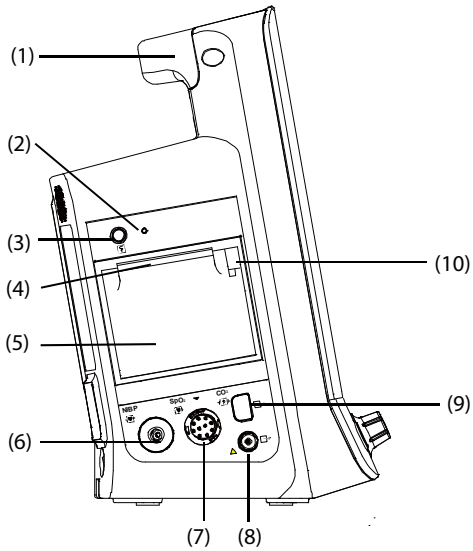

- (1) Handle
- (2) Recorder indicator
- (3) Start/stop recording key
- (4) Paper outlet
- (5) Recorder door
- (6) Connector for NIBP cuff
- (7) Connector for SpO₂ cable
- (8) CO₂ gas outlet
- (9) CO₂ sample line connector
- (10) Recorder latch

2.3.3 Rear View

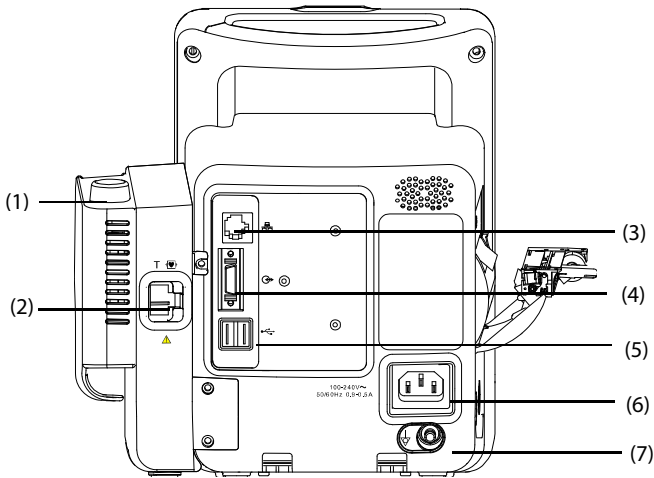

(1) Temperature probe well

The temperature module varies in appearance. The above figure shows the main unit with the SmarTemp™ module.

(2) Connector for temperature probe

The temperature module varies in appearance. The above figure shows the main unit with the SmarTemp™ module.

(3) Network connector: It is a standard RJ45 connector used to communicate with external devices, such as central monitoring system, Gateway, or upgrade the system.

(4) Multi-function connector: connects to the hospital's nurse call system, or connects external devices through DIAP protocol.

(5) USB connector: connects to barcode scanner or USB disk.

(6) AC power input

(7) Equipotential grounding terminal

When the equipment and other devices are to be used together, their equipotential grounding terminals should be connected together to eliminate the potential difference between them.

2.3.4 Bottom View

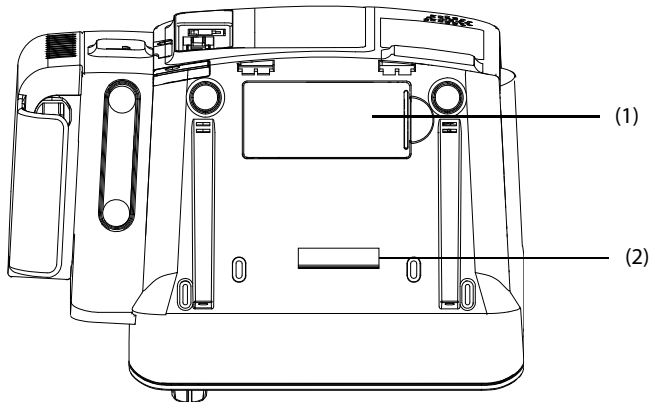

- (1) Battery compartment door
- (2) Hole for installing a support

2.4 Main Screen

There are three display modes of main screen. They are all parameter screen, trend screen and NIBP list screen.

■ All Parameter Screen

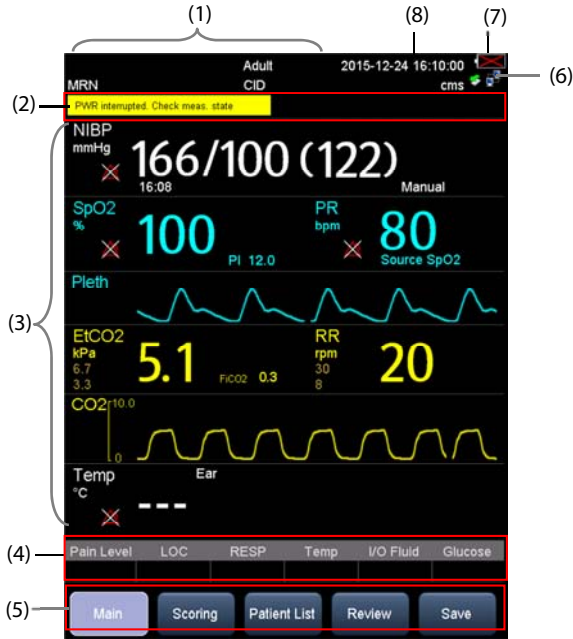

■ Trend Screen

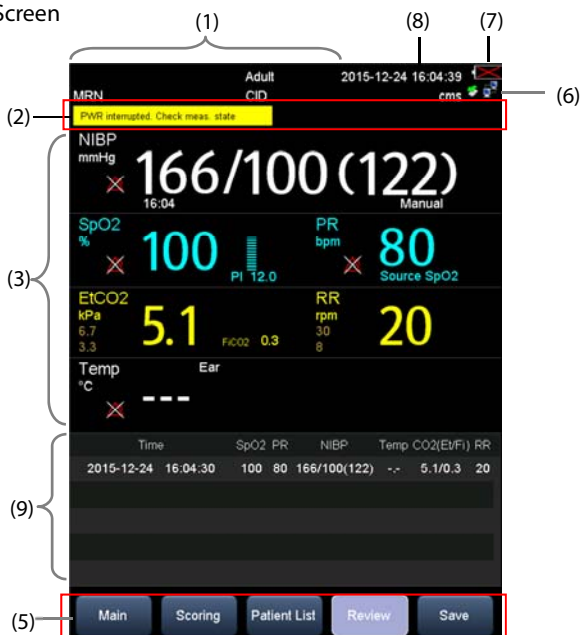

■ NIBP List Screen

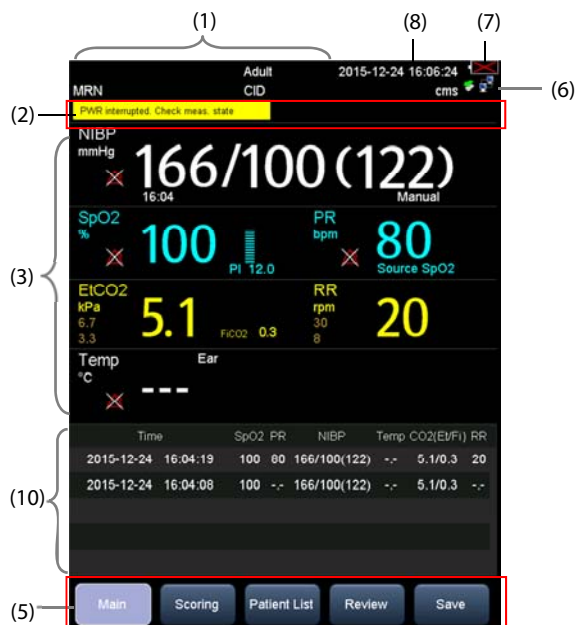

(1) Patient Information/System Message Area

This area normally shows patient information, such as patient medical record number, patient name, patient category, room, bed number, clinician ID.

When a system related message is presented, the second line of this area will display the system prompt message for 30 seconds. The patient information there will be covered temporarily.

(2) Alarm Information Area

There are three sections in this area: The left side of this area shows the technical alarm message or prompt message; the middle area shows the physiological alarm message; and the right side of this area shows the alarm symbol.



indicates alarms are paused.



indicates alarms are reset.



indicates alarm sounds are turned off.

(3) Parameter and waveform area: displays parameters and waveforms.

(4) Manual input area: manually input physiological related value. This area does not display by default. Refer to **4.2 Manually Input Patient Data** for additional information.

(5) Menu QuickKeys

- ◆ Main: Accesses the **[Main]** screen to configure the monitor, or quickly returns to the main screen.
- ◆ Scoring: Accesses the screen to evaluate a patient's condition. Refer to **12 Clinical Scoring**.
- ◆ Patient List: Accesses the **[Local Patient List]** and **[ADT Database]** screen to admit a patient stored in the monitor or ADT database. Refer to **4.1.3 Admitting a Patient from [Patient List]**.
- ◆ Review: Displays the spot check trends, continuous trends and graphic trends. Refer to **4.4 Reviewing Patient Data**.
- ◆ Save: Accesses the **[Results]** screen to manually save patient data. Refer to **4.3 Manually Save Patient Data**.

(6) Network and USB connection area

Indicate the connection of network or USB to this monitor.



indicates monitor is connected to a wire network successfully.



indicates the wireless function is working.



indicates monitor has failed to connect a wire network.



indicates the wireless function is not working.



indicates a U disk is inserted.

- (7) Battery status: indicates the status of the battery. For details, refer to **15 Battery**.
- (8) System time
- (9) Tabular trend area. This area displays only in Trend screen mode.
- (10) NIBP list area. This area displays only in NIBP List screen mode.

2.5 Menu

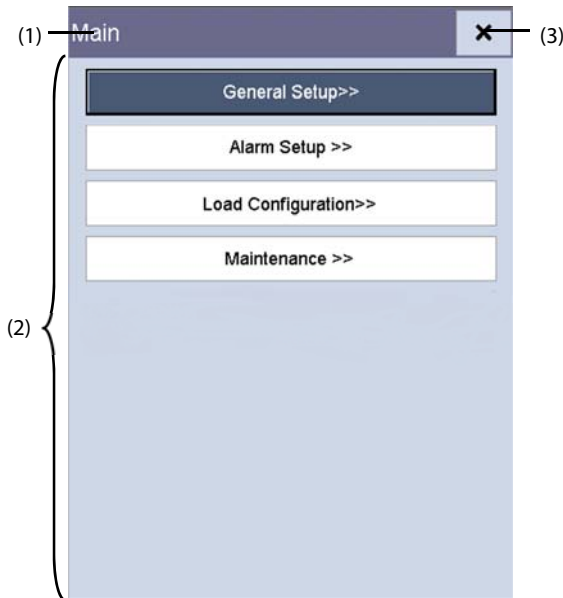

A menu in this monitor is usually composed of:

- (1) Heading: gives a sum-up for the current menu.
- (2) Main body: displays options, buttons, prompt messages, etc. A menu button followed with ">>" enlarges a secondary window to reveal more options or information.
- (3) : select to exit the current menu.

2.6 Operating Modes

2.6.1 Monitor Mode

The monitor will automatically enter monitor mode after power on. Monitor mode is a

common mode for monitoring patient vital signs.

NOTE

-
- **In Monitor mode, physiological and technical alarms, and prompt messages are supported.**
-

2.6.2 Spot Check Mode

The spot mode is intended for on-spot measurement in a short period. When spot mode is ON, the message area on the top of screen will display [**Spot Check**].

To enter Spot Check mode, select [**Main**]→[**Maintenance>>**]→[**User Settings>>**]→Enter required password→Set [**Spot Check**] to [**On**].

NOTE

-
- **In Spot Check mode, technical alarms and prompt messages are supported, but no physiological alarms.**
-

Monitor Mode vs. Spot Check Mode

The Monitor mode and Spot Check modes have all the features in common except the following:

Functions	Monitor Mode	Spot Check Mode
Configure and use Sat-Seconds (Nellcor)	Yes	No
Access [Alarm Setup] tab	Yes	No
Access [Continuous Trends] tab	Yes	No
Access [Graphic Trends] tab	Yes	No
Connect to the central monitoring system	Yes	No
Measure CO ₂	Yes	No

2.6.3 Standby Mode

In standby mode, the monitoring for current patient is over, but the monitor still powers on.

If no parameter is being measured, you can press the power switch to enter Standby mode. Then a warning pops up. Select [**Yes**] to enter the Standby mode.

When the monitor is powered by a battery, it will automatically enter the Standby mode when the following conditions are satisfied:

- No key operation within 10 minutes.
- No unacknowledged alarms.

To exit Standby mode, you can take any one of the following ways:

- Press the any hardkey on the panel.
- Rotate the knob.
- Connect SpO₂ sensor, and let the monitor receive SpO₂ signal for more than 5 seconds.
- Remove the temperature probe from the probe well.

NOTE

- **If the monitor enters and then exits Standby mode during patient monitoring, you must re-admit the patient for the monitoring.**
-

2.6.4 Demo Mode

Demo mode is password protected, and it is used for demonstration purpose only.

To enter Demo mode:

1. Select [**Main**]→[**Maintenance>>**].
2. Select [**Demo>>**]→Enter required password→Select [**Ok**].

To exit Demo mode:

1. Select [**Main**]→[**Maintenance>>**].
2. Select [**Exit Demo**].



- **The Demo mode is for demonstration purpose only. To avoid that the simulated data are mistaken for the monitored patient's data, you must not change into Demo mode during monitoring. Otherwise, improper patient monitoring and delayed treatment could result.**
-
-

3 Basic Operations

3.1 Installation



- **The equipment shall be installed by personnel authorized by us.**
 - **Do not open the equipment housings. All servicing and future upgrades must be carried out by the personnel trained and authorized by our company only.**
 - **The software copyright of the equipment is solely owned by us. No organization or individual shall resort to juggling, copying, or exchanging it or to any other infringement on it in any form or by any means without due permission.**
 - **Devices connected to the equipment must meet the requirements of the applicable IEC standards (e.g. IEC 60950 safety standards for information technology equipment and IEC 60601-1 safety standards for medical electrical equipment). The system configuration must meet the requirements of the IEC 60601-1 medical electrical systems standard. Any personnel who connect devices to the equipment's signal input/output port is responsible for providing evidence that the safety certification of the devices has been performed in accordance to the IEC 60601-1. If you have any question, please contact us.**
 - **If it is not evident from the equipment specifications whether a particular combination with other devices is hazardous, for example, due to summation of leakage currents, please consult the manufacturers or else an expert in the field, to ensure the necessary safety of patients and all devices concerned will not be impaired by the proposed combination.**
-
-

3.1.1 Unpacking and Checking

Before unpacking, examine the packing case carefully for signs of damage. If any damage is detected, contact the carrier or us.

If the packing case is intact, open the package and remove the equipment and accessories carefully. Check all materials against the packing list and check for any mechanical damage. Contact us in case of any problem.



WARNING

- **When disposing of the packaging material, be sure to observe the applicable waste control regulations and keep it out of children's reach.**
 - **The equipment might be contaminated during storage and transport. Before use, please verify whether the packages are intact, especially the packages of single use accessories. In case of any damage, do not apply it to patients.**
-

NOTE

- **Save the packing case and packaging material as they can be used if the equipment must be reshipped.**
-

3.1.2 Environmental Requirements

The equipment is suitable for use within the patient environment.

The operating environment of the equipment must meet the requirements specified in this manual.

The environment where the equipment is used shall be reasonably free from noises, vibration, dust, corrosive, flammable and explosive substances. If the equipment is installed in a cabinet, sufficient space in front and behind shall be left for convenient operation, maintenance and repair. Moreover, to maintain good ventilation, the equipment shall be at least 2 inches (5 cm) away from around the cabinet.

When the equipment is moved from one place to another, condensation may occur as a result of temperature or humidity difference. In this case, never start the system before the condensation disappears.



WARNING

- **Make sure that the operating environment of the equipment meets the specific requirements. Otherwise unexpected consequences, e.g. damage to the equipment, could result.**
-

NOTE

- **The equipment uses a mains plug as a means of isolation to the mains power supply. Do not position the equipment in a place difficult to access the mains plug.**
-

3.2 General Operation

Read this operator's manual carefully before the use of this monitor. Familiarize yourself with the equipment's function and operation, and observe the warnings and cautions included in the manual.

3.2.1 Connection to AC Power

This monitor can be powered by AC power or battery. Connect the power cord to the AC input on the back of the monitor, and connect the other end of the power cord to the power outlet.



WARNING

- **Always use the accompanying power cord with the monitor.**
 - **Where the integrity of the external protective conductor in the installation or its arrangement is in doubt, the equipment shall be operated from the battery.**
-

3.2.2 Using a Battery

This monitor can be equipped with rechargeable Lithium-ion battery. If a battery is installed, the monitor system will automatically switch to battery for power supply if AC power is interrupted.

Installing a Battery

Battery compartment cover is at the bottom of monitor. Refer to **15.3 Replacing a Battery** for additional information of battery installation.

NOTE

- **When a battery has been stored for a long time, or the battery is depleted, recharge the battery at once. Otherwise, the low battery may not support to power up the monitor if the AC power is unavailable.**
-

Charging a Battery

The battery is charged whenever the monitor is connected to an AC power source regardless of whether the monitor is currently on or not.

When the battery is charging, the battery indicator is On. The battery charge icon on the

screen dynamically displays the charging status when the monitor is powered on.

3.2.3 Connecting Accessories

Insert the hose of NIBP cuff into the cuff connector on the side of monitor; insert the SpO₂ cable into the SpO₂ cable connector on the side of monitor; insert the temperature probe cable into the TEMP probe connector on the back of monitor.

3.3 Turning On/Off Power

3.3.1 Check before Power On

It is recommended to check the followings before power on the monitor:

- **Environment**
If other electric devices, such as electrosurgical unit, ultrasound, X-ray machine, are around the monitor, power off those devices if the measurement is interfered.
- **Power Supply**
Check that power supply specification is met and the power cord is securely connected if mains power is used. Use only power socket that is properly grounded.
Check that a battery is installed and fully charged if battery is used.
- **Connecting Accessories**
Verify that the connection of all accessories to monitor is secured.

3.3.2 Turning Power On

Once the monitor is installed, you can get ready for measurement.

1. Check the monitor for any mechanic damage, and make sure that all external cables, plug-ins and accessories are properly connected.
2. Check the power supply specification is met if mains power is used. Only use a power outlet that is properly grounded.
3. Plug the power cord into the AC power source. If you run the monitor on battery power, ensure that the battery is sufficiently charged.
4. Press the power on/off switch on the monitor's front.

The monitor will perform alarm system self-test during startup. After pressing the power on/off button, the system sounds a beep, and the alarm lamp simultaneously turns yellow, then red, and then turns off, with the start-up screen being shown. Then the start-up screen disappears. The alarm system self-test succeeds. The monitor enters the normal monitoring screen.

For further testing of individual measurement alarms, perform the measurement on yourself (for example SpO₂ or CO₂) or use a simulator. Adjust alarm limits and check that appropriate alarm behavior is observed.

 **WARNING**

- **Do not use the monitor on a patient if you suspect it is not working properly, or if it is mechanically damaged. Contact your service personnel or us.**
 - **Check that visual and auditory alarm signals are presented correctly when the equipment is powered on. Do not use the equipment for any monitoring procedure on a patient if you suspect it is not working properly, or if it is mechanically damaged. Contact your service personnel or Mindray.**
-
-

NOTE

- **Carefully check if the system performs the self-test as described above. Contact your service personnel or us if the self-test is abnormal.**
-

3.3.3 Turning off the Monitor

Before turning off the monitor:

1. Confirm that the monitoring is finished.
2. Disconnect patient cables and sensors from the patient.
3. Make sure to save or clear the patient monitoring data as required.

Press and hold the power on/off switch for above 2 seconds to turn off monitor.



 **CAUTION**

- **Although not recommended, you can press and hold the power on/off switch for 10 seconds to forcibly shut down the monitor when it could not be shut down normally or under some special situations. This may cause data loss of the monitor.**
 - **The monitor restores the latest configuration if restarts within 60 seconds after the power failure. And it will restore the default configuration rather than the latest configuration if restarts 120 seconds later after the power failure. The monitor may load either the latest configuration or the default configuration if restarts from 60-120 seconds after the power failure.**
 - **Power failure may cause data damage on SD card. It is recommended to turn off the monitor according to the normal procedures. Do not directly unplug the power cord, unless there is a charged battery installed, or remove the battery before shutting down the monitor.**
-

3.4 Using Key, Knob, Touchscreen

3.4.1 Using Keys

The monitor has three types of keys:

- **Softkey:** A softkey is a graphic key on the screen, giving you fast access to certain menus or functions. The monitor has two types of softkeys:
 - ◆ **Parameter keys:** Each parameter area or waveform area can be seen as a softkey. You can enter a parameter setup menu by selecting its corresponding parameter area or waveform area.
 - ◆ **QuickKeys:** QuickKeys are configurable graphical keys, located at the bottom of the main screen.
- **Hardkeys:** A hardkey is a physical key on a monitoring device, such as the Alarm Reset hardkey  and admit patient hardkey  on the front panel.
- **Pop-Up Keys:** Pop-up keys are task-related menu keys that appear automatically on the monitor screen when required. For example, the confirm pop-up key appears only when you need to confirm a change.

3.4.2 Using the Knob

Using the knob on the front panel of the monitor can do the following operations:

- Rotate the knob clockwise or anti-clockwise to move the cursor.
- Press the knob to select one item, such as accessing a menu or confirming the selection

3.4.3 Using the Touchscreen

Select screen items by pressing them directly on the monitor's screen. You can enable or disable touchscreen operation by pressing and holding the **[Main]** QuickKey for 3 seconds.

A padlock symbol  on the **[Main]** QuickKey is displayed if touchscreen operation is disabled.

When the touchscreen is locked, powering off the monitor and restarting it will automatically unlock the touchscreen.

3.5 Changing General Settings

This section covers only general settings such as language, brightness, date and time, etc. Measurement settings and other settings can be referred to the respective sections.

3.5.1 Setting up a Monitor

To install a monitor or change the monitor's location, you need to set it as follows:

1. Select **[Main]**→**[Maintenance >>]**→**[User Settings >>]**→ Enter the required password→ Select **[Ok]** and then access **[User Settings]** menu.
2. Set up **[Monitor Name]**, **[Department]** and **[Bed No.]**.

You can set **[Changing Bed No.]** to:

- **[Unprotected]**: enables you to change Bed No. from the **[Patient Demographics]** menu.
- **[Protected]**: prevents you from changing Bed No. from the **[Patient Demographics]** menu.

3.5.2 Changing Language

1. Select **[Main]**→**[Maintenance >>]**→**[User Settings >>]**→ Enter the required password Select **[Ok]** to access **[User Settings]** menu.
2. Select **[Language]** and then select the desired language.
3. Restart the monitor.

3.5.3 Configuring the Timeout of Clinician ID

You can configure the retention time of a clinician ID each time it is entered.

1. Select **[Main]**→**[Maintenance >>]**→**[User Settings >>]**→ Enter the required password→ Select **[Ok]** and then access **[User Settings]** menu.
2. Select **[Clinician ID Time out]** and then set the time.

3.5.4 Showing/Hiding Patient Name

You can show or hide the current patient name in the main screen. To do so, follow this procedure:

1. Select **[Main]**→**[Maintenance >>]**→**[User Settings >>]**→ Enter the required password→ Select **[Ok]** and then access **[User Settings]** menu.
2. Select **[Patient Demographics]**.
3. Set **[Display Patient Name]** to **[Yes]** or **[No]**.
 - ◆ **[Yes]**: the patient's name display in the main screen.
 - ◆ **[No]**: the patient's name does not display in the main screen.

3.5.5 Adjusting Alarm Volume

1. Select **[Main]**→**[General Setup>>]**.

2. Select [**Alarm Volume**] and then select the appropriate volume: X-10, in which X is the minimum volume, depending on the set minimum alarm volume (refer to **6.5.2 Setting the Minimum Alarm Volume**), and 10 the maximum volume.

The alarm tone is switched off when the volume is set to **[0]**.

3.5.6 Adjusting Key Volume

The monitor can provide a tone according to the settings in key volume when you press the knob or hard key, or touch the screen.

1. Select [**Main**]→[**General Setup>>**].
2. Select [**Key Volume**] and then select the appropriate volume: 0-10, in which 0 means off, and 10 the maximum volume.

3.5.7 Adjusting the Screen Brightness

If the monitor operates on a battery power, you can set a less bright screen to prolong the operating time of the battery. When the monitor enters Standby mode, the screen will change to the least brightness automatically.

1. Select [**Main**]→[**General Setup>>**].
2. Select [**Brightness**] and select the appropriate setting for the screen brightness. 10 is the brightest, and 1 is the least bright.

3.5.8 Setting Screen

1. Select [**Main**]→[**General Setup>>**].
2. Select [**Display Setup**] and set the main screen to different layout: All Parameters display, Trend display or NIBP List display.
 - ◆ All Parameters display includes parameter area, waveform area, but no trend.
 - ◆ Trend display includes parameter area, tabular trends, but no waveform area.
 - ◆ NIBP List display includes parameter area, NIBP list, but no waveform area.

3.5.9 Configuring the Timeout of Measured Value

1. Select [**Main**]→[**General Setup>>**].
2. Select [**Parameter Time Out**] to set the retention time for the digital value of current NIBP and temperature measurement displayed on the screen.

The options are 5 min, 10 min, 15 min, and 30 min and off. When [**Off**] is selected, the digital value of current NIBP and temperature measurement will always display on the screen until the new measured value replace it.

3.5.10 Configuring Measurement Colors

You can set the desired color for the parameters.

Select **[Main]**→**[General Setup>>]**→ **[Parameter Color Setup>>]** and then the **[Color Setup]** menu pops up.

3.5.11 Setting the Date and Time

1. Select **[Main]**→**[General Setup>>]**→**[System Time>>]**.
2. Set **[Date]** and **[Time]**.
3. Select **[Date Format]** and toggle between **[yyyy-mm-dd]**, **[mm-dd-yyyy]** and **[dd-mm-yyyy]**.
4. Select **[Time Format]** and toggle between **[24h]** and **[12h]**.



CAUTION

- **Changing date and time affects the storage of trends and events and may cause data missing.**
-

3.5.12 Configuring Unit

To enter the **[Unit Setup]** menu, select **[Main]**→**[General Setup>>]**→**[Unit Setup>>]**.

3.5.13 Configuring Printout

You can select the items to be printed on the strip. By default, all items are selected.

To enter the **[Print Setup]** menu, select **[Main]**→**[General Setup>>]**→**[Print Setup>>]** and then pops up.

FOR YOUR NOTES

4 Patient Data Management

4.1 Admitting a Patient

The monitor displays physiological data and stores them in the trends as soon as a patient is connected. This allows you to monitor a patient that is not admitted yet. However, it is recommended that you fully admit a patient so that you can clearly identify your patient, on recordings, reports and networking devices.

NOTE

- **If the monitor enters and then exits Standby mode during patient monitoring, you must re-admit the patient for the monitoring.**
-

4.1.1 Admitting a Patient by the Admit Patient Hardkey

1. Press the Admit Patient hardkey  to access **[Patient Demographics]** menu.

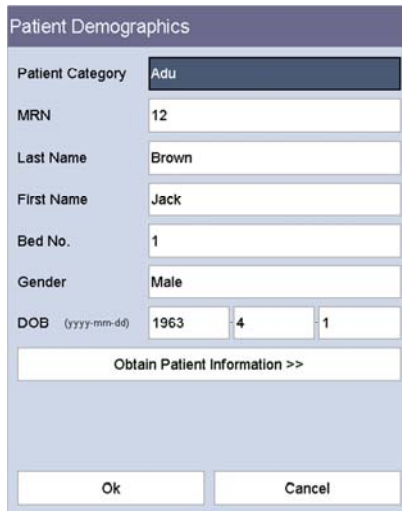

Patient Demographics	
Patient Category	Adu
MRN	12
Last Name	Brown
First Name	Jack
Bed No.	1
Gender	Male
DOB (yyyy-mm-dd)	1963 4 1
Obtain Patient Information >>	
Ok	Cancel

2. Enter the demographic details.
If the monitor is connected to ADT database through Gateway, when you input patient MRN, the patient information in the same MRN stored in ADT database will automatically synchronize to patient demographics of the monitor.
3. Select **[Ok]** key.

You can self-define the **[Patient Demographics]** menu.

1. Select **[Main]**→**[Maintenance >>]**→**[User Settings >>]**→enter the required password→select **[Ok]** to access **[User Settings]** menu.
2. Select **[Patient Demographics>>]**.
3. Select the desired items in **[Patient Demographics Setup]** menu.
 - ◆ **[Required Information]**: the items that must be entered or selected when you send the data to the eGateway.
 - ◆ **[Optional Information]**: the optional information in admitting a patient. You can also customize four options as optional information.
4. Select **✕** to save the configuration and exit the menu.

NOTE

- In **[User Settings]**→**[Patient Demographics>>]**→**[Patient Demographics Setup]** menu, the mark **'*** is before the required input item. Only all the items are entered, the patient's demographics can be sent to the eGateway.
 - If a clinician ID is entered, but no operation on the monitor for a certain time, the monitor will clear up the ID. Refer to **3.5.3 Configuring the Timeout of Clinician ID**.
-

4.1.2 Admitting a Patient by Barcode Scanner

The monitor provides the ability to admit a patient through linear or two-dimension barcode scanner.

NOTE

- If the patient demographics is obtained from barcode scanner, the patient demographics cannot be changed.
-

4.1.2.1 With Linear (1D) Barcode Scanner

To admit a patient with a 1D barcode scanner, follow this procedure:

1. Connect the barcode scanner to the USB connector on the monitor.
2. Aim the barcode scanner to the barcode.
3. Select **[Ok]** key on the **[Patient Demographics]** menu to admit the patient.

4.1.2.2 With Two-Dimension (2D) Barcode Scanner

Configuring the Scanner

When the scanner is first used in your hospital, you need to clear and re-establish the data format for the scanner before admit a patient.

1. Connect the barcode scanner to the USB connector on the monitor.
2. Aim the scanner at the following barcode to clear the previous data format.



Clear All Data Formats

3. Aim the scanner at the 2D image which contains your hospital's barcode data format. Contact the scanner manufacturer for obtaining this image.

Setting the Monitor

After you have set up the data format for the 2D scanner, follow this procedure to set up the monitor:

1. Select **[Main]**→**[Maintenance >>]**→**[User Settings >>]**→enter the required password→select **[Ok]** to access **[User Settings]** menu.
2. Select **[Scanner Setup>>]**→**[2D Barcode Setup>>]**. The setup screen displays.
3. Establish the relationship between the monitor data and barcode data for selectable patient demographics. For example, the monitor has an option of **[Adult]** for patient category. In your hospital barcode, the text may read as **[Adu]**. You need to input **[Adu]** for the field **[Adult]** to establish the relationship. The following aspects need to establish the relationship:
 - ◆ Patient Category
 - ◆ Gender
 - ◆ Month
4. Select **✕** to save the configuration and exit the **[2D Barcode Setup]** menu.
5. Select the desired pop-up menu if you scan the patient barcode.
 - ◆ **[Patient Demographics]**: the **[Patient Demographics]** menu displays.
 - ◆ **[ADT Database]**: the **[ADT Database]** tab displays.

NOTE

-
- **If there is existing open menu or window, the **[Patient Demographics]** menu or **[ADT Database]** tab will not pop up.**
-

5. Select **✕** to save the configuration and exit the menu.

Admitting a Patient

To admit a patient, follow this procedure:

1. Connect the barcode scanner to the USB connector on the monitor.

2. Aim the scanner at the clinician barcode and press the scan button at the barcode scanner. The clinician ID will populate the **[Clinician ID]** field in the **[Patient Demographics]** menu.
3. Aim the scanner at the patient barcode and press the scan button on the barcode scanner. The pop-up menu that opens depends on if **[Patient Demographics]** or **[ADT Database]** is selected at the **[Scanner Setup>>]** menu.
4. Select **[Ok]** to admit the patient.

4.1.3 Admitting a Patient from [Patient List]

Admit a Patient from [Local Patient List].

1. Press **[Patient List]** QuickKey, and then **[Local Patient List]** screen displays.
2. Select the page key (for example ) , and then use up or down arrow beside the key to turn to another page, or select **[Scroll]** key and then use up or down arrow beside the key to select the desired patient.
3. Select **[Admit]** to access **[Patient Demographics]** menu.
4. Select **[Ok]**. If necessary, you can modify patient information and then select **[Ok]**.

In **[Local Patient List]**, you also can:

- Select **[Add New]**, and then **[Patient Demographics]** menu displays. Input patient information and then select **[Ok]** to admit the patient.
- Select **[Delete]** to remove currently selected patient from the monitor.
- Select **[Delete All]** to remove all the patients from the monitor.

NOTE

-
- **When a patient's demographics is deleted, all his patient data in the monitor will be deleted at the same time.**
 - **You cannot delete the currently monitoring patient.**
-

Admitting a Patient from [ADT Database]

When the monitor is connected to ADT database through Gateway, the monitor can obtain patient information from ADT database.

1. Access the **[ADT Database]** screen by either way.
 - ◆ Select **[Patient List]** QuickKey→**[ADT Database]** tab.
 - ◆ Aim the 2D barcode scanner at the patient barcode. Refer to **4.1.2.2 With Two-Dimension (2D) Barcode Scanner** for scanner and monitor configuration.
2. Select **[ADT Database]**, and then ADT database screen displays.
3. Search a patient.

- ◆ Input [**Department**] name, and then the system will search the patient within the department.
 - ◆ Input [**MRN**], and then the system will search the patient according to the input medical record number.
 - ◆ Input [**Last Name**] and/or [**First Name**], and the system will search patient upon the name.
4. Select the page key (for example, ) , and then use up or down arrow beside the key to turn to another page, or select [**Scroll**] key and then use up or down arrow beside the key to select the desired patient.
 5. Select [**Admit**] to access [**Patient Demographics**] menu.
 6. Select [**Ok**]. If necessary, you can modify patient information and then select [**Ok**].

4.2 Manually Input Patient Data

You can choose whether to display the manual input area on the screen and configure the items to be displayed in the manual input area:

1. Select [**Main**]→[**Maintenance >>**]→[**User Settings >>**]→enter the required password→Select [**Ok**] to access [**User Settings**] menu.
2. Select [**Manual Inputs>>**].
3. In the [**Manual Inputs Setup**] menu, you can
 - ◆ Configure the items to be displayed in the manual input area.
 - ◆ Select [**Manual Input Area**] and toggle between [**On**] and [**Off**] to display or hide the manual input area.

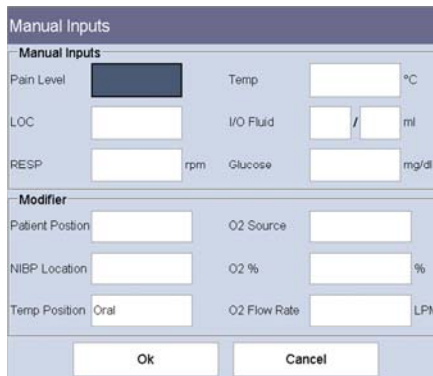

4. Select  to save the configuration and exit the menu.

The following picture shows the manual input area which is located at the bottom of the screen if displayed.

Pain Level	LOC	RESP	Temp	I/O Fluid	Glucose
1	Conscious	21 rpm	38.0 °C	78/65 ml	2.22 mg/dl

After the manual input area is selected, the **[Manual Inputs]** menu pops up. The displayed items correspond to the settings in **[Manual Inputs Setup]**.

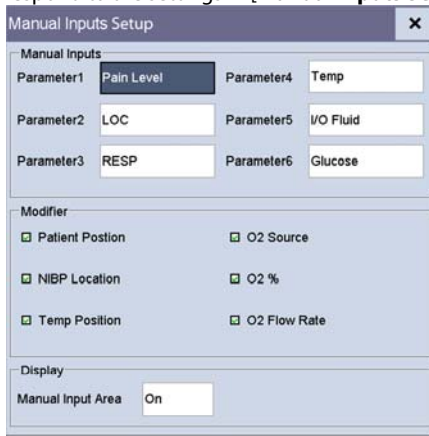

4.3 Manually Save Patient Data

Select **[Save]** QuickKey to save the demographics, scoring data, measurements and manual input of the current patient.

You can configure the data processing mode for the manually saved data.

1. Select **[Main]**→**[Maintenance >>]**→**[User Settings >>]**→enter the required password→select **[Ok]** to access **[User Settings]** menu.
2. Select **[“Save” Button Options>>]**.
3. In **[“Save” Button Setup]** menu, select the followings:
 - ◆ **[Automatically Send On Manual Save]**: the data will be saved locally and meanwhile sent to the external devices when the **[Save]** QuickKey is selected and confirmed, and/or
 - ◆ **[Automatically Record On Manual Save]**: the data will be saved locally and meanwhile printed by recorder when the **[Save]** QuickKey is selected and confirmed.
 - ◆ **[Clear Clinician ID at Saving]**: the data saves locally and the monitor clears the clinician ID when the **[Save]** Quickkey is selected.
 - ◆ **[Open ‘Results’ Menu at Saving]**: the data saves locally and the **[Results]** menu displays when the **[Save]** QuickKey is selected. You can edit patient demographics and manual input data at **[Results]** menu.
 - ◆ **[Discharge Patient at Spot Check Saving]**: the data saves locally and the monitor discharges the current patient when the **[Save]** QuickKey is selected.
4. Select **X** to save the configuration and exit the menu.

4.4 Reviewing Patient Data

Select **[Review]** QuickKey, and you can review the trends.

In Monitor mode, you can view:

- Spot check trends
- Continuous trends
- Graphic trends

In Spot Check mode, you can view only spot check trends.

4.4.1 Spot Check Trends



Select the **[Spot Check Trends]** tab to access the Spot Check Trends screen.

The screenshot shows the 'Spot Check Trends' interface. At the top, there are three tabs: 'Spot Check Trends' (selected), 'Continuous Trends', and 'Graphic Trends'. Below the tabs are input fields for 'MRN' (containing 'All') and 'Filter' (containing 'All'). A table displays patient data with columns: MRN, Time, SpO2, PR, NIBP, Temp, CO2(Et /Fi), and RR. The first row shows a patient with MRN '55' and a yellow highlight on the 'PR' value '80'. Below the table is a status bar with icons and text: 'Pat. Info. Incomplete', 'Send Successful', 'Saved to Device Only', and 'Send Failure'. At the bottom, there is a page indicator '1/1', an 'Edit' button, and three buttons: 'Delete', 'Print', and 'Send'. Callouts (1) through (4) point to the table, the button area, the data status bar, and the parameter value triggering alarm, respectively.

MRN	Time	SpO2	PR	NIBP	Temp	CO2(Et /Fi)	RR
55	2016-04-12 10:28:21	98	80	166/100 (122)	37.6	38/2	20
Unknown	2016-04-12 09:42:14	100	80	166/100 (122)	37.6	38/2	20
Unknown	2016-04-12 09:42:11	100	80	166/100 (122)	37.6	38/2	20
Unknown	2016-04-11 21:23:29	100	80	166/100 (122)	37.6	38/2	20
Unknown	2016-04-11 21:22:41	100	80	166/100 (122)	37.6	38/2	20

- (1) Tabular trend
- (2) Button area
- (3) Data status
- (4) Parameter value triggering alarm

In this tab, you can:





- Select **[MRN]** or **[Name]** and then select the desired patient.
- Select **[Filter]** to select parameter trends you want to review.
- Select the page key (for example  1/1 ) and then use up or down arrow beside the key to turn the page.
- Select **[Edit]** to edit patient demographics or manual input data of selected patient.
- Select **[Delete]** to delete the trend data of selected patient.

- Select **[Print]** to print the trend data of selected patient.
- Select **[Send]** to transmit the selected patient's trend data to the EMR through an eGateway.

NOTE

- **The trend data can only be sent out when the monitor is connected to Electronic Medical Record system (EMR).**

In the spot check tabular trends:

- Parameter value triggering high level alarm has a red background; parameter value triggering medium or low level alarm has a yellow background.
- The required patient demographics that is not fully filled displays as 
- Patient data successfully sent to the EMR displays as 
- Patient data that failed to transmit to the EMR displays as 
- Patient data that is cached on the device but not transmitted displays as 

4.4.2 Continuous Trends

Select **[Continuous Trends]** tab to access the Continuous Trends screen.





The screenshot shows a window titled "Continuous Trends" with three tabs: "Spot Check Trends", "Continuous Trends" (selected), and "Graphic Trends". The window contains a table with columns: MRN, Time, SpO2, PR, NIBP, and Temp. The table lists multiple rows of patient data. A red box highlights the bottom control bar containing a home icon, a "1/2" indicator, a down arrow, a "Print" button, and a "Delete All" button. Brackets and numbers (1), (2), and (3) are used to identify specific features: (1) points to the table area, (2) points to the control bar, and (3) points to a specific row in the table where the SpO2 value is 90 and the PR value is 49, both highlighted in yellow.

MRN	Time	SpO2	PR	NIBP	Temp
Unknown	2013-11-07 16:00:00	98	49	150/80(93) 15.59	38.0 15.57
test	2013-11-07 14:00:00	90	60	--/--/--	--
test	2013-11-07 12:00:00	90	60	--/--/--	41.0 10.02
test	2013-11-07 10:00:00	--	--	--/--/--	40.0 09.59
Unknown	2013-05-11 22:00:00	100	80	--/--/--	38.0 21.59
Unknown	2013-05-11 20:00:00	100	80	--/--/--	38.0 19.59
Unknown	2013-05-11 18:00:00	100	80	--/--/--	38.0 17.59
Unknown	2013-05-11 16:00:00	100	80	--/--/--	38.0 15.59
Unknown	2013-05-11 14:00:00	100	80	--/--/--	38.0 13.59
Unknown	2013-05-11 12:00:00	100	80	--/--/--	38.0 11.59
Unknown	2013-05-11 10:00:00	100	80	--/--/--	38.0 09.59

- (1) Tabular trend (2) Button area (3) Parameter value triggering alarm

In this tab, you can:

- Select **[MRN]** or **[Name]** to select the desired patient.
- Select **[Interval]** to set the interval for the data to be displayed.
- Select the page key (for example  1/1 ) , and then use up or down arrow beside the key to turn the page.
- Select **[Print]** to print the trend data of selected patient.
- Select **[Delete All]** to delete the trend data of selected patient.

Parameter value triggering high level alarm has a red background; parameter value triggering medium or low level alarm has a yellow background.

4.4.3 Graphic Trends

Select **[Graphic Trends]** tab to access the Graphic Trends screen. The Graphic Trend screen displays the current patient's physiological trend.

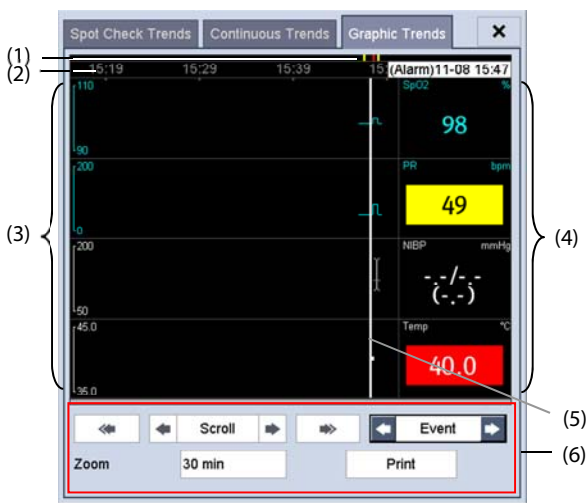







- | | | |
|---------------------|----------------|------------------|
| (1) Event mark area | (2) Time scale | (3) Graphic area |
| (4) Parameter area | (5) Cursor | (6) Button area |

A timestamp indicating your current position is displayed above the parameter area. The parameter value corresponding to the cursor time appears in the parameter area. The measurement value that triggered a high level alarm has red background. The measurement that triggered the medium/low level alarm has a yellow background.

Events are marked with colors in the event mark area. Red represents a high level alarm event. Yellow represents a medium/low level alarm event.

In the Graphic Trends screen, you can:

- Select [**Zoom**] to set the time length of the trend displayed on the screen.
- Select [**Scroll**] and control  or  key to move the cursor. Select  or  to move the cursor to the previous or next page.
- Select [**Event**] and control  or  key to quickly locate the event.
- Select [**Print**] to print the selected patient's graphic trend data currently on the screen.

NOTE

- **Pausing or switching off alarms will not be recorded as events. The time of these operations will not be recorded in the system log.**
 - **A total loss of power has no impact on the saved events.**
 - **Events recorded earlier might be overwritten by later ones if the storage memory reaches capacity.**
-

4.5 Transferring Data from the Monitor to USB Drive

1. Insert a USB drive to the USB connector on the monitor.
2. Select [**Main**]→[**Maintenance >>**]→[**User Settings >>**]→enter the required password→select [**Ok**] to access [**User Settings**] menu.
3. Select [**Transfer Data to USB**].
4. Select [**Period**] and select your desired time.
5. Select [**Transfer Data**].



CAUTION

- **The USB drive you use may have write-protect function. In this case, please make sure the USB drive for data transfer is in read/write mode.**
 - **Do not remove the storage medium during data transfer process. Otherwise, data files may be damaged.**
 - **The normal monitoring function will be affected during data export. Do not perform any monitoring activity during data export.**
-

5 Managing Configurations

5.1 Overview

When performing continuous monitoring on a patient, the clinical professional often needs to adjust the monitor's settings according to the patient's condition. The collection of all these settings is called a configuration. Allowing you to configure the monitor more efficiently, the monitor offers different sets of configuration to suit different patient categories and departments. You can change some settings from a certain set of configuration and then save the changed configuration as a user configuration.



WARNING

- **The configuration management function is password protected. The configuration management tasks must be performed by clinical professionals.**
-

The system configuration items can be classified as:

- **Parameter configuration items**
These items relate to parameters, e.g. alarm switch, alarm limits.
- **Conventional configuration items**
These items define how the monitor works, e.g., display setup, print and alarm settings.
- **User maintenance items**
These items relate to user maintenance settings, e.g., unit setup, time format.

For the important configuration items and their default values and user maintenance items, see **Appendix C Default Configurations**.

5.2 Accessing [Manage Configuration] Menu

1. Select **[Main]** → **[Maintenance >>]** → **[User Settings >>]**. Enter the required password and then select **[Ok]**.
2. Select **[Manage Configuration >>]**.

5.2.1 Setting Default Configuration

The monitor will load the pre-set default configuration in the following cases.

- The monitor is restarted after being switched off for above 120 seconds.
- A patient is admitted.
- A patient is discharged.
- Patient category is changed.

The default configuration may come from the latest configuration, the factory default configuration or the user configuration.

To set the default configuration:

1. Select [**Select Default Config >>**] in the [**Manage Configuration**] menu.
2. Select [**Load Latest Config**] or [**Load Specified Config**] in [**Select Default Config**] menu.

When you select [**Load Specified Config**], the configuration (adult, pediatric or neonate) to be restored is subject to the patient category. This configuration can be either factory configuration or saved user configuration. Take adult as an example, select [**Default Adult Config**] and toggle between [**Defaults**] and user configuration(s).

NOTE

- **When the equipment starts, it shows what configuration is restored at the prompt information area for about 30 seconds.**
-

5.3 Saving Current Settings

Current settings can be saved as user configuration. Up to 3 user configurations can be saved.

To save current settings:

1. Select [**Save Current Settings As >>**] in the [**Manage Configuration**] menu.
2. In the popup dialog box, enter the configuration name and then select [**Ok**].

5.4 Deleting a Configuration

1. Select [**Delete Config >>**] in the [**Manage Configuration**] menu. The popup menu shows the existing user configurations on the monitor. Selecting [**Config on USB drive >>**] will show the existing user configurations on the USB drive.
2. Select the user configurations you want to delete and then select [**Delete**].
3. Select [**Yes**] in the popup.

5.5 Transferring a Configuration

When installing several monitors with identical user configuration it is not necessary to set each unit separately. A USB drive may be used to transfer the configuration from monitor to monitor.

To export the current monitor's configuration:

1. Insert a USB disk to the monitor's external device connector.
2. Select [**Export Config >>**] in the [**Manage Configuration**] menu.
3. In the [**Export Config**] menu, select the configurations and the user maintenance settings to be exported. Then select the [**Export**] button.

To import the configuration on the USB drive to the monitor:

1. Connect the USB Drive to the monitor's external device connector.
2. Select [**Import Config >>**] in the [**Manage Configuration**] menu.
3. In the [**Import Config**] menu, select the configurations and the user maintenance settings to be imported. Then select the [**Import**] button. A status message will report completion of the transfer.

5.6 Loading a Configuration

You may make changes to some settings during operation. However, these changes or the pre-selected configuration may not be appropriate for the newly admitted patient. Therefore, the monitor allows you to load a desired configuration so as to ensure that all the settings are appropriate for your patient.

To load a configuration:

1. Select [**Load Configuration >>**] from the main menu. The popup menu shows the existing configurations on the monitor. Selecting [**Config on USB drive >>**] will show the existing configurations on the USB drive.
2. Select a desired configuration.
3. Select [**Load**] to load this configuration.

The current configuration is shown at the top of the [**Load Configuration**] menu.

5.7 Restoring the Latest Configuration Automatically

During operation, you may make changes to some settings. However, these changes may not be saved as user configuration. To prevent the changes from losing in case of a sudden power failure, the equipment stores the configuration in real time. The saved configuration is the latest configuration.

The monitor restore the latest configuration if restarts within 60 seconds after the power failure. And it will restore the default configuration rather than the latest configuration if restarts 120 seconds later after the power failure. The monitor may load either the latest configuration or the default configuration if restarts from 60-120 seconds after the power failure.

6 Alarms

Alarms, triggered by a vital sign that appears abnormal or by technical problems of the monitor, are indicated to the user by visual and audible alarm indications.



WARNING

- **A potential hazard can exist if different alarm presets are used for the same or similar equipment in any single area, e.g. an intensive care unit or cardiac operating room.**
 - **If your equipment is connected to a CMS, remote suspension, inhibition, silence and reset of monitor alarms via the CMS may cause a potential hazard. For details, refer to the CMS's instructions for use.**
-
-

6.1 Alarm Categories

By nature, the equipment's alarms can be classified into two categories: physiological alarms and technical alarms.

1. Physiological alarms

Physiological alarms, also called patient status alarms, are triggered by a monitored parameter value that violates set alarm limits or an abnormal patient condition. The physiological alarms occur only in Monitor mode.

2. Technical alarms

Technical alarms, also called system status alarms, are triggered by a device malfunction or a patient data distortion due to improper operation or mechanical problems.

Apart from the physiological and technical alarm messages, the monitor shows some messages telling the system status or patient status. System related messages are displayed in system message area; parameter related messages are displayed in respective parameter message area.

6.2 Alarm Levels

By severity, the equipment's alarms can be classified into three categories: high level, medium level and low level.

	Physiological Alarms	Technical Alarms
High level	Indicate that your patient is in a life threatening situation and an emergency treatment is demanded.	Indicate a severe device malfunction or an improper operation, which could make it possible that the monitor cannot detect critical patient status and thus threaten the patient's life.
Medium level	Indicate that your patient's vital signs appear abnormal and an immediate treatment is required.	Indicate a device malfunction or an improper operation, which may not threaten the patient's life but may compromise the monitoring of vital physiological parameters.
Low level	Indicate that you patient's vital signs appear abnormal and an immediate treatment may be required.	Indicate a device malfunction or an improper operation, which may compromise a certain monitoring function but will not threaten the patient's life.

6.3 Alarm Indicators

When an alarm occurs, the equipment will indicate it to the user through visual or audible alarm indications.

- Alarm lamp
- Audible alarm tones
- Alarm message
- Flashing numeric

6.3.1 Alarm Lamp

If a technical alarm or physiological alarm occurs, the alarm lamp will flash. The color and flashing frequency match the alarm level as follows:

- High level alarms: the lamp quickly flashes red.
- Medium level alarms: the lamp slowly flashes yellow.
- Low level alarms the lamp lights yellow without flashing.

NOTE

-
- **When multiple alarms of different levels occur simultaneously, the monitor will select the alarm of the highest level and give visual alarm indications accordingly.**
-

6.3.2 Audible Alarm Tones

The monitor uses different alarm tone patterns to match the alarm priority.

The alarm tone is distinct from keystroke tone and pulse tone in frequency.

The alarm tones identify the alarm levels as follows:

- High level alarms: triple+double beeps+triple+double beep.
- Medium level alarms: triple beep.
- Low level alarms: single beep.

The interval of alarm tone is configurable. Refer to **6.5.3 Setting the Interval between Alarm Sounds**.

NOTE

- **When multiple alarms of different levels occur simultaneously, the monitor will select the alarm of the highest level, give alarm sounds accordingly. Multiple alarm messages scroll on the screen.**
-

6.3.3 Alarm Messages

When an alarm occurs, an alarm message will appear in the technical or physiological alarm area.

The alarm message has different background color which matches the alarm level.

- High level alarms: red
- Medium level alarms: yellow
- Low level alarms: yellow

For physiological alarms, the asterisk symbols (*) before the alarm message match the alarm level as follows:

- High level alarms: ***
- Medium level alarms: **
- Low level alarms: *

When there are multiple messages, the messages will be displayed circularly.

NOTE



- **Some physiological alarms, such as the Desat alarm, are exclusive. They have identical alarm tones and alarm lights as normal high level physiological alarms, but their alarm messages are displayed exclusively. When an exclusive physiological alarm and a normal high level physiological alarm are triggered simultaneously, only the exclusive physiological alarm message is displayed.**
-

6.3.4 Flashing numerics

If an alarm triggered by an alarm limit violation occurs, the numeric of the measurement in alarm will flash every second, and the corresponding alarm limit will also flash at the same frequency indicating the high or low alarm limit is violated.

6.3.5 Alarm Status Symbols

Apart from the aforementioned alarm indicators, the equipment still uses the following symbols telling the alarm status:

-  indicates alarms are paused.
-  indicates alarms are reset.
-  indicates the alarm sound is turned off.

6.4 Setting Alarms

You can set the switch, limit and level of physiological alarms.

Select **[Main]**→**[Alarm Setup >>]**, and then access the **[Alarm Setup]** screen.



Parameter	On/Off	High	Low	Level
SpO2	On	100	90	Med
Desat	On		80	High
NIBP-Sys	On	160	90	Med
NIBP-Dia	On	90	50	Med
NIBP-Mean	On	110	60	Med
Temp	On	38.0	35.0	Med
PR	On	120	50	Med

Auto Set Restore Defaults

- **[Auto Set]**: The monitor will create new alarm limits based on the measured values.
- **[Restore Defaults]**: The restored defaults depend on the settings in **[Select Default Config]** screen. If the latest configuration is set as the default configuration, then the factory configuration will be loaded for the alarm settings; if specified configuration is set as the default configuration, then the specified configuration will be loaded for the alarm settings. Refer to **5.2.1 Setting Default Configuration**.



WARNING

- **Make sure that the alarm limits settings are appropriate for your patient before monitoring.**
 - **Setting alarm limits to extreme values may cause the alarm system to become ineffective. For example, High oxygen levels may predispose a premature infant to retrolental fibroplasia. If this is a consideration do NOT set the high alarm limit to 100%, which is equivalent to switching the alarm off.**
-
-

6.5 Selecting Alarm Properties

6.5.1 Changing the Alarm Volume

Select [Main]→[General Setup >>]→[Alarm Volume].

The alarm volume range is between X to 10. X is the minimum volume, which depends on the setting of minimum alarm volume (Refer to **6.5.2 Setting the Minimum Alarm Volume**), and 10 is the maximum volume.

When alarm volume is set to 0, the alarm sound is turned off and a  symbol appears on the screen.

6.5.2 Setting the Minimum Alarm Volume

1. Select [Main]→[Maintenance >>]→[User Settings >>]→Enter the required password→Select [Ok] to access [User Settings] menu.
2. Select [Alarm Setup >>] to access [Alarm Setup] menu.
3. Select [Minimum Alarm Volume] and then select the appropriate settings.

The minimum alarm volume refers to the minimum value you can set for the alarm volume, which is not affected by user or factory default configurations.

6.5.3 Setting the Interval between Alarm Sounds

1. Select [Main]→[Maintenance >>]→[User Settings >>]→Enter the required password→Select [Ok] to access [User Settings] menu.
2. Select [Alarm Setup >>] to access [Alarm Setup] menu.
3. Select [High Alarm Interval (s)], [Med Alarm Interval (s)] and [Low Alarm Interval (s)] in turn and then select the appropriate settings.



WARNING

- **When the alarm sound is switched off, the equipment will give no audible alarm tones even if a new alarm occurs. Therefore the user should be very careful about whether to switch off the alarm sound or not.**
- **Do not rely exclusively on the audible alarm system for patient monitoring. Adjustment of alarm volume to a low level may result in a hazard to the patient. Always keep the patient under close surveillance.**

6.5.4 Adjusting Alarm Limits Automatically

The monitor can automatically adjust alarm limits according to the measured vital signs, using the auto limits function. When auto limits are selected, the monitor calculates safe auto limits based on the latest measured values.

To get accurate auto alarm limits, you need to collect a set of measured vital signs as a baseline. Then, in the main menu, select **[Main]**→**[Alarm Setup>>]**→**[Auto Set]** →Select **[Ok]** in the pop-up window. The monitor will create new alarm limits based on the measured values.

Before applying these automatically created alarm limits, confirm if they are appropriate for your patient. If not, you can adjust them manually.

The monitor calculates the auto limits based on the following rules.

Parameter	Low alarm Limit		High alarm Limit		Auto-set alarm limit Range
	Adult/ Pediatric	Neonate	Adult/ Pediatric	Neonate	
SpO ₂	Same as the default alarm limit	Same as the default alarm limit	Same as the default alarm limit	Same as the default alarm limit	Same as the measurement range
PR	(PR×0.8) or 40 bpm, whichever is greater	(PR-30) or 90 bpm, whichever is greater	(PR×1.25) or 240 bpm, whichever is smaller	(PR+40) or 200 bpm, whichever is smaller	Adult/Pediatric: 35 to 240 bpm Neonate: 55 to 225 bpm
NIBP-S	(SYS×0.68) + 10mmHg	(SYS-15) or 45mmHg, whichever is greater	(SYS×0.86) + 38mmHg	(SYS + 15) or 105mmHg, whichever is smaller	Adult: 45 to 270 mmHg Pediatric: 45 to 185 mmHg Neonate: 35 to 115 mmHg

Parameter	Low alarm Limit		High alarm Limit		Auto-set alarm limit Range
	Adult/ Pediatric	Neonate	Adult/ Pediatric	Neonate	
NIBP-D	(Dia×0.68)+ 6mmHg	(Dia-15) or 20mmHg, whichever is greater	(Dia×0.86)+ 32mmHg	(Dia+15) or 80mmHg, whichever is smaller	Adult: 25 to 225 mmHg Pediatric: 25 to 150 mmHg Neonate: 20 to 90 mmHg
NIBP-M	(Mean×0.68)+ 8mmHg	(Mean-15) or 35mmHg, whichever is greater	(Mean×0.86) +35mmHg	(Mean+15) or 95mmHg, whichever is smaller	Adult: 30 to 245 mmHg Pediatric: 30 to 180 mmHg Neonate: 25 to 105 mmHg
Temp	(T-0.5)°C	(T-0.5) °C	(T+0.5) °C	(T+0.5)°C	Same as the measurement range
EtCO ₂	0 to 32: remains the same	0 to 32: remains the same	0 to 32: remains the same	0 to 32: remains the same	Same as the measurement range
	33 to 35: 29	33 to 35: 29	33 to 35: 41	33 to 35: 41	Same as the measurement range
	36 to 45: (EtCO ₂ - 6)	36 to 45: (EtCO ₂ - 6)	36 to 45: (EtCO ₂ + 6)	36 to 45: (EtCO ₂ + 6)	Same as the measurement range
	46 to 48: 39	46 to 48: 39	46 to 48: 51	46 to 48: 51	Same as the measurement range
	>48: remains the same	>48: remains the same	>48: remains the same	>48: remains the same	Same as the measurement range
FICO ₂	None	None	Same as the default alarm limit	Same as the default alarm limit	Same as the measurement range

6.6 Pausing Alarms

You can temporarily disable alarm indicators by pressing and holding  hardkey on the panel for above 2 seconds.

When alarms are paused,

- The alarms pause symbol  and the remaining alarm pause time is displayed in Alarm Information area.
- For physiological alarms, no alarm indication is shown. New physiological alarm will not be presented.
- For technical alarms, alarm sounds are paused, but alarm lamps and alarm messages remain presented.

The default alarm pause time is 2 minutes. When the alarm pause time expires, or the low battery alarm occurs, the alarm paused status is automatically deactivated. You can also cancel the alarm paused status by pressing and holding the  hardkey for more than 2 seconds.

6.7 Switching Off Alarm Sound

When alarm volume is set to 0, the alarm sound is turned off. In audio alarm off status,

- The Audio Off symbol  is displayed.
- Audio indication of all alarms is suspended.

You can cancel the alarm sound off status by setting alarm volume to a value from 1 to 10.



WARNING

- **Pausing or switching off alarms may result in a hazard to the patient. Please be very careful.**
-
-

6.8 Resetting Alarms

By pressing the  hardkey, you can reset the alarm system to acknowledging the on-going alarms and enable the alarm system to respond to a subsequent alarm condition.

For physiological alarms, except the NIBP-related alarms, when the alarm system is reset:

- The alarm sound is silenced.
- A ✓ appears before the alarm message, indicating that the alarm is acknowledged.

- The icon  appears in the alarm symbol area.
- The parameter numeric and alarm limits still flash.

The indication of alarm lamp for the physiological alarm depends on the alarm light setting.

- When [**Alarm Light on Alarm Reset**] is set to [**On**], the alarm lamp remains flashing.
- When [**Alarm Light on Alarm Reset**] is set to [**Off**], the alarm lamp stops flashing.

To set [**Alarm Light on Alarm Reset**]:

1. Select [**Main**]→ [**Maintenance >>**]→ [**User Settings >>**]→ enter the required password → Select [**Ok**] to access [**User Settings**] menu.
2. Select [**Alarm Setup >>**] to enter the [**Alarm Setup**] menu.
3. Select [**Alarm Light on Alarm Reset**], and toggle between [**On**] and [**Off**].

The default setting for [**Alarm Light on Alarm Reset**] is [**On**].

Technical alarms give different alarm indicators when the alarm system is reset:

- For some technical alarms, including the NIBP-related alarms, a ✓ appears before the alarm message and  appears in the alarm symbol area, indicating that the alarm is acknowledged. The indication of the alarm lamp depends on the alarm light setting.
- Some technical alarms are changed to the prompt messages.
- Some technical alarms are cleared. The monitor gives no alarm indications.

For details about the indications of technical alarms when the alarm system is reset, refer to **D.2 Technical Alarm Messages**.

6.9 Setting the Reminder Tone

In audio off status, the monitor can issue a periodical reminder tone. The interval of the reminder tone is 1 minute. You can switch on or off the reminder tone.

1. Select [**Main**]→ [**Maintenance >>**]→ [**User Settings >>**]→ Enter required password→ Select [**Ok**] and then access [**User Settings**] menu.
2. Select [**Alarm Setup >>**] to access [**Alarm Setup**] menu.
3. Set [**Reminder Tone**] to [**On**] or [**Off**].

6.10 Latching Alarms

The latching setting for physiological alarms defines how alarm indicators behave when you do not acknowledge them.

- If an alarm is latched, alarm indications remain presented even though alarm conditions end, except that:
 - ◆ The parameter reading and violated alarm limit stop flashing.
 - ◆ The time when the alarm is last triggered is displayed behind the alarm message.
- If an alarm is not latched, the alarm indications disappear as soon as the alarm conditions end.

To latch a physiological alarm,

1. Select **[Main]**→**[Maintenance >>]**→**[User Settings >>]**→Enter required password→Select **[Ok]** and then access **[User Settings]** menu.
2. Select **[Alarm Setup >>]**.
3. Set **[Alarm Latch]** to **[High only]**, **[High&Med]**, **[All]** or **[Off]**.
 - ◆ **[High only]**: only high priority alarms are latched;
 - ◆ **[Hi&Med]**: both high priority alarms and mediate priority alarms are latched;
 - ◆ **[All]**: all alarms are latched; and
 - ◆ **[Off]**: no alarm will be latched.

Only the unacknowledged physiological alarm can be latched. The latched alarms will be cleared when the monitor enters alarm reset state.

NOTE

- **Changing of alarm priority may affect the latching status of corresponding alarm. Please determine if you need to reset the latching status for the specific alarm when you have changed its alarm priority.**
-

6.11 Actions for Alarm Occurrence

When an alarm occurs, observe the following steps and take proper actions:

1. Check the patient's condition.
2. Confirm the alarming parameter or alarm category.
3. Identify the source of the alarm.
4. Take proper action to eliminate the alarm condition.
5. Make sure the alarm condition is corrected.

For details about how to deal with specific alarms, refer to **Chapter D Alarm Messages**.

6.12 Nurse Call

The monitor also provides a multi-function connector to output nurse call signals when a user-defined alarm occurs. To obtain a nurse call signal, use the nurse call cable (*P/N: 009-003116-00*) we supply to connect the hospital nurse call system to the multi-function connector of the monitor and then follow this procedure:

1. Select [**Main**]→[**Maintenance >>**]→[**User Settings >>**]→Enter required password→Select [**Ok**] and then access [**User Settings**] menu.
2. Select [**Nurse Call >>**] to access the [**Nurse Call >>**] menu.
3. Select [**Signal Type**] and toggle between [**Pulse**] and [**Continuous**].
 - ◆ [**Pulse**]: the nurse call signal is pulse signal and each pulse lasts 1 second. When multiple alarms occur simultaneously, only one pulse signal is outputted. If an alarm occurs but the previous one is not cleared yet, a new pulse signal will also be outputted.
 - ◆ [**Continuous**]: the nurse call signal lasts until the alarm ends, i.e. the duration of a nurse call signal equals to that of the alarm condition.
4. Select [**Contact Type**] and toggle between [**Normally Open**] and [**Normally Closed**].
 - ◆ [**Normally Open**]: Select if your hospital's nurse call relay contact is normally open.
 - ◆ [**Normally Closed**]: Select if your hospital's nurse call relay contact is normally closed.
5. Select [**Alarm Level**] and set the alarm level for nurse call-triggering alarms.
6. Select [**Alarm Category**] and then select the category to which the nurse call-triggering alarms belong.

Alarm conditions are indicated to nurses only when:

1. The nurse call system is enabled
2. An alarm that meets your preset requirements occurs, and
3. The monitor is not in the alarm paused or silence status.

If no setting is selected from [**Alarm Level**] or [**Alarm Category**], no nurse call signal will be triggered whatever alarms occur.



WARNING

- **To obtain the nurse call signal, use the nurse call cable (PN: 009-003116-00) we supply. Otherwise the nurse call function will not work and the monitor may be damaged**
 - **Do not rely exclusively on the nurse call system for alarm notification. Remember that the most reliable alarm notification combines audible and visual alarm indications with the patient's clinical condition.**
-
-

FOR YOUR NOTES

7 Monitoring SpO₂

7.1 Overview

SpO₂ monitoring is a non-invasive technique used to measure the amount of oxygenated haemoglobin and pulse rate by measuring the absorption of selected wavelengths of light. The light generated in the probe passes through the tissue and is converted into electrical signals by the photodetector in the probe. The SpO₂ module processes the electrical signal and displays a waveform and digital values for SpO₂ and pulse rate.

This device is calibrated to display functional oxygen saturation. It provides following measurements.

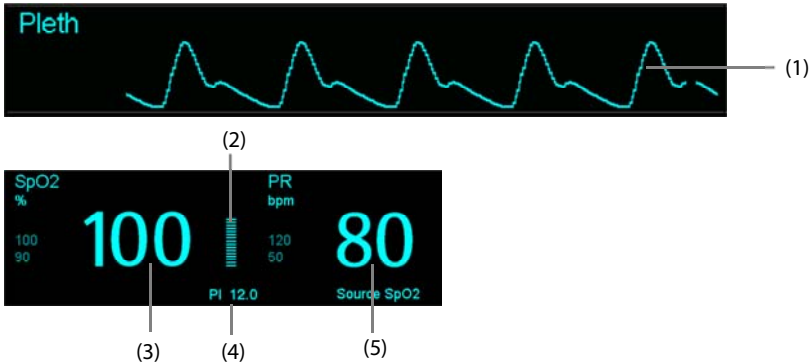

- (1) Pleth waveform (Pleth): visual indication of patient's pulse. The waveform is not normalized.
 - (2) Perfusion indicator: the pulsatile portion of the measured signal caused by arterial pulsation.
 - (3) Oxygen saturation of arterial blood (SpO₂): percentage of oxygenated hemoglobin in relation to the sum of oxyhemoglobin and deoxyhemoglobin.
 - (4) Perfusion index (PI): gives the numerical value for the pulsatile portion of the measured signal caused by arterial pulsation. PI is an indicator of the pulsatile strength. You can also use it to assess the quality of SpO₂ measurement.
 - ◆ Above 1 is optimal.
 - ◆ between 0.3 and 1 is acceptable.
 - ◆ Below 0.3 indicates low perfusion. When PI is below 0.3, a question mark (?) is displayed to the right of the SpO₂ value, indicating that the SpO₂ value may be inaccurate. Reposition the SpO₂ sensor or find a better site. If low perfusion persists, choose another method to measure oxygen saturation if possible.
- PI is available for Mindray SpO₂ module and Masimo SpO₂ module. For Mindray SpO₂ module, PI value can be displayed under the PR value in larger characters if [PI Zoom] is enabled.
- (5) Pulse rate (derived from pleth wave): detected pulsations per minute.

NOTE

- If the message "SpO₂ Low Perf." or "SpO₂ Weak Pulse" displays, check sensor application, re-apply or remove the sensor if necessary, to obtain a better signal.
 - A function tester or SpO₂ simulator can be used to verify the sensor functions.
 - A functional tester or SpO₂ simulator cannot be used to assess the accuracy of a SpO₂ module or a SpO₂ sensor.
 - A functional tester or SpO₂ simulator can be used to determine the pulse rate accuracy.
-

7.2 Safety



- Use only SpO₂ sensors specified in this manual. Follow the SpO₂ sensor's instructions for use and adhere to all warnings and cautions.
 - When a trend toward patient deoxygenation is indicated, blood samples should be analyzed by a laboratory co-oximeter to completely understand the patient's condition.
 - Do not use SpO₂ sensors during magnetic resonance imaging (MRI). Induced current could potentially cause burns. The sensor may affect the MRI image, and the MRI unit may affect the accuracy of the oximetry measurements.
 - Prolonged continuous monitoring may increase the risk of undesirable changes in skin characteristics, such as irritation, reddening, blistering or burns. Inspect the sensor site every two hours and move the sensor if the skin quality changes. Change the application site every four hours. For neonates, or patients with poor peripheral blood circulation or sensitive skin, inspect the sensor site more frequently.
-

7.3 Identifying SpO₂ Module

To identify which SpO₂ module is incorporated into your monitor, see the company logo located at the side panel. The color of the cable connector matches the company as shown below:

- Mindray SpO₂ module: a blue connector without logo.
- Masimo SpO₂ module: a purple connector with a logo of Masimo SET.
- Nellcor SpO₂ module: a grey connector with a logo of Nellcor.

The connectors for these three SpO₂ sensors are mutually exclusive.

7.4 Applying the Sensor

**WARNING**

- **If the sensor is too tight because the application site is too large or becomes too large due to edema, excessive pressure for prolonged periods may result in venous congestion distal from the application site, leading to interstitial edema and tissue ischemia.**
-

NOTE

- **Place the SpO₂ sensor so that the light source is against the application site.**
 - **Check if the sensor is in normal condition before monitoring. Do not use the SpO₂ sensor if the package or the sensor is found damaged.**
 - **Do not apply the sensor on a limb with an intravenous infusion or arterial catheter in place.**
-

1. Select an appropriate sensor according to the module type, patient category and weight.
2. Clean the application site. For example, remove colored nail polish.
3. Apply the sensor to the patient.
4. Select an appropriate adapter cable according to the connector type and plug this cable into the SpO₂ connector.
5. Connect the sensor cable to the adapter cable.

7.5 Changing SpO₂ Settings

7.5.1 Accessing SpO₂ Menu

By selecting the SpO₂ parameter or waveform area, you can access the [SpO₂ Setup] menu.

7.5.2 Adjusting the Desat Alarm

The Desat alarm is a high level alarm notifying you of potentially life threatening drops in oxygen saturation.

Select [**Alarm Setup >>**] from the [SpO₂ Setup] menu. From the pop-up menu, you can set low alarm limit and alarm switch for [Desat]. When the SpO₂ value is below the Desat alarm limit and Desat alarm switch is set to [ON], the message [SpO₂ Desat] is displayed.

7.5.3 Setting SpO₂ Sensitivity

For Mindray SpO₂ module, you can set **[Sensitivity]** to **[High]**, **[Med]** or **[Low]** in the **[SpO₂ Setup]** menu; for Masimo SpO₂ module, you can set **[Sensitivity]** to **[Maximum]** or **[Normal]** in the **[SpO₂ Setup]** menu.

When the sensitivity is set to **[High]** or **[Maximum]**, the equipment is more sensitive to minor signals. When monitoring critically ill patients whose pulsations are very weak, it is strongly recommended that the sensitivity is set to **[High]** or **[Maximum]**. When monitoring neonatal or non-critically ill patients who tend to move a lot, noise or invalid signals may be caused. In this case, it is recommended that the sensitivity is set to **[Low]** or **[Normal]** so that the interference caused by motion can be filtered and therefore the measurement stability can be ensured.

7.5.4 Changing Averaging Time

The SpO₂ value displayed on the monitor screen is the average of data collected within a specific time. The shorter the averaging time is, the quicker the equipment responds to changes in the patient's oxygen saturation level. Contrarily, the longer the averaging time is, the slower the equipment responds to changes in the patient's oxygen saturation level, but the measurement accuracy will be improved. For critically ill patients, selecting shorter averaging time will help understanding the patient's state.

To set the averaging time:

- For Mindray SpO₂ module, select **[Sensitivity]** in the **[SpO₂ Setup]** menu and then toggle between **[High]**, **[Med]** and **[Low]**, which respectively correspond to 7 s, 9 s and 11 s.
- For Masimo SpO₂ module, select **[Averaging]** in the **[SpO₂ Setup]** menu and then toggle between **[2-4 s]**, **[4-6 s]**, **[8 s]**, **[10 s]**, **[12 s]**, **[14 s]** and **[16 s]**.

7.5.5 Monitoring SpO₂ and NIBP Simultaneously

When monitoring SpO₂ and NIBP on the same limb simultaneously, you can switch **[NIBP Simultaneous]** on in the **[SpO₂ Setup]** menu to lock the SpO₂ alarm status until the NIBP measurement ends. If you switch **[NIBP Simultaneous]** off, low perfusion caused by NIBP measurement may lead to inaccurate SpO₂ readings and therefore cause false physiological alarms.

7.5.6 Sat-Seconds Alarm Management

With traditional alarm management, high and low alarm limits are set for monitoring oxygen saturation. During monitoring, as soon as an alarm limit is violated, an audible alarm immediately sounds. When the patient % SpO₂ fluctuates near an alarm limit, the alarm sounds each time the limit is violated. Such frequent alarm can be distracting. Nellcor's Sat-Seconds alarm management technique is used to reduce these nuisance alarms.

The Sat-Seconds feature is available with the Nellcor SpO₂ module to decrease the likelihood of false alarms caused by motion artifacts. To set the Sat-Seconds limit, select **[Sat-Seconds]** in the **[SpO₂ Setup]** menu and then select the appropriate setting.

With Sat-Seconds alarm management, high and low alarm limits are set in the same way as traditional alarm management. A Sat-Seconds limit is also set. The Sat-Seconds limit controls the amount of time that SpO₂ saturation may be outside the set limits before an alarm sounds. The method of calculation is as follows: the number of percentage points that the SpO₂ saturation falls outside the alarm limit is multiplied by the number of seconds that it remains outside the limit. This can be stated as the equation:

$$\text{Sat-Seconds} = \text{Points} \times \text{Seconds}$$

Only when the Sat-Seconds limit is reached, the monitor gives a Sat-Seconds alarm. For example, the figure below demonstrates the alarm response time with a Sat-Seconds limit set at 50 and a low SpO₂ limit set at 90%. In this example, the patient % SpO₂ drops to 88% (2 points) and remains there for 2 seconds. Then it drops to 86% (4 points) and remains there for 3 seconds, and then to 84% (6 points) for 6 seconds. The resulting Sat-Seconds are:

% SpO ₂	Seconds	Sat-Seconds
2x	2 =	4
4x	3 =	12
6x	6 =	36
Total Sat-Seconds=		52

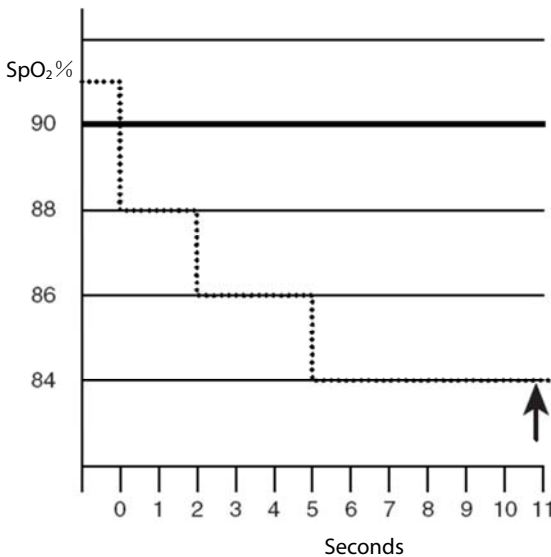

After approximately 10.9 seconds, a Sat-Second alarm would sound, because the limit of 50 Sat-Seconds would have been exceeded.

Saturation levels may fluctuate rather than remaining steady for a period of several seconds. Often, the patient % SpO₂ may fluctuate above and below an alarm limit, re-entering the non-alarm range several times. During such fluctuation, the monitor integrates the number of %SpO₂ points, both positive and negative, until either the Sat-Seconds limit is reached, or the patient%SpO₂ re-enters the non-alarm range and remains there.

7.5.7 Changing the Speed of Pleth Wave

In the [**SpO₂ Setup**] menu, select [**Sweep**] and then select the appropriate setting. The faster the waveform sweeps, the wider the waveform is.

7.5.8 Setting the Alarm Level for SpO₂ Sensor Off Alarm

In the [**SpO₂ Setup**] menu, select [**SpO₂ Sensor Off Lev.**] and then select the appropriate setting.

7.6 Measurement Limitations

If you doubt the measured SpO₂, check patient vital signs first. Then check the equipment and SpO₂ sensor. The following factors may influence the accuracy of measurement:

- Ambient light
- Physical movement (patient and imposed motion)
- Diagnostic testing
- Low perfusion
- Electromagnetic interference, such as MRI environment
- Electrosurgical units
- Dysfunctional haemoglobin, such as carboxyhemoglobin (COHb) and methemoglobin (MetHb)
- Presence of certain dyes, such as methylene and indigo carmine
- Inappropriate positioning of the SpO₂ sensor, or use of incorrect SpO₂ sensor
- Drop of arterial blood flow to immeasurable level caused by shock, anemia, low temperature or vasoconstrictor.

7.7 Masimo Information



- Masimo Patents

This device is covered under one or more the following U.S.A. patents: 5,758,644, 6,011,986, 6,699,194, 7,215,986, 7,254,433, 7,530,955 and other applicable patents listed at: www.masimo.com/patents.htm.

- No Implied License

Possession or purchase of this device does not convey any express or implied license to use the device with unauthorized sensors or cables which would, alone, or in combination with this device, fall within the scope of one or more of the patents relating to this device.

7.8 Nellcor Information



- Nellcor Patents

This device may be covered by one or more of the following US patents and foreign equivalents: 5,485,847, 5,676,141, 5,743,263, 6,035,223, 6,226,539, 6,411,833, 6,463,310, 6,591,123, 6,708,049, 7,016,715, 7,039,538, 7,120,479, 7,120,480, 7,142,142, 7,162,288, 7,190,985, 7,194,293, 7,209,774, 7,212,847, 7,400,919.

- No Implied License

Possession or purchase of this device does not convey any express or implied license to use the device with unauthorized replacement parts which would, alone, or in combination with this device, fall within the scope of one or more of the patents relating to this device.

FOR YOUR NOTES

8 Monitoring PR

8.1 Overview

The pulse numeric counts the arterial pulsations that result from the mechanical activity of the heart. The pulse value can be from SpO₂ or NIBP. The PR parameter area displays its source.



- (1) PR high limit
- (2) PR low limit
- (3) Pulse rate (PR): detected pulsations per minute.
- (4) PR Source

NOTE

- **A function tester or SpO₂ simulator can be used to determine the pulse rate accuracy.**
-

8.2 PR Source

The current pulse source is displayed in the PR parameter area. The pulse rate is:

- stored in the monitor's database and reviewed in the graphic/tabular trends.
- sent via the network to the central monitoring system, if available.

8.3 Pulse Tone

You can change the pulse tone volume by adjusting [**Beat Volume**] in the [**SpO₂ Setup**] menu. When a valid SpO₂ value exists, the system will adjust the pitch tone of pulse according to the SpO₂ value.

FOR YOUR NOTES

9 Monitoring NIBP

9.1 Overview

The monitor uses the oscillometric method for measuring the non-invasive blood pressure (NIBP). This measurement can be used for adults, pediatrics and neonates.

Automatic non-invasive blood pressure monitoring uses the oscillometric method of measurement. To understand how this method works, we'll compare it to the auscultative method.

With auscultation, the clinician listens to the blood pressure and determines the systolic and diastolic pressures. The mean pressure can then be calculated with reference to these pressures as long as the arterial pressure curve is normal.

Since the monitor cannot hear the blood pressure, it measures cuff pressure oscillation amplitudes. Oscillations are caused by blood pressure pulses against the cuff. The oscillation with the greatest amplitude is the mean pressure. This is the most accurate parameter measured by the oscillometric method. Once the mean pressure is determined, the systolic and diastolic pressures are calculated with reference to the mean.

Simply stated, auscultation measures systolic and diastolic pressures and the mean pressure is calculated. The oscillometric method measures the mean pressure and determines the systolic and diastolic pressures.

As specified by IEC80601-2-30 NIBP measurement can be performed during electro-surgery and discharge of defibrillator.

NIBP diagnostic significance must be decided by the doctor who performs the measurement.

NOTE

-
- **Blood pressure measurements determined with this device are equivalent to those obtained by a trained observer using the cuff/stethoscope auscultatory method or an intra-arterial blood pressure measurement device, within the limits prescribed by the American National Standard, Manual, electronic, or automated sphygmomanometers.**
-

9.2 Safety

WARNING

- **During NIBP measuring, the inflated cuff will apply pressure on the application site. The clinician shall determine if NIBP measuring is suitable for the patient.**
 - **Be sure to select the correct patient category setting for your patient before measurement. Do not apply the higher adult settings for pediatric or neonatal patients. Otherwise it may present a safety hazard.**
 - **Do not measure NIBP on patients with sickle-cell disease or any condition where skin damage has occurred or is expected.**
 - **Use clinical judgement to determine whether to perform frequent unattended blood pressure measurements on patients with severe blood clotting disorders because of the risk of hematoma in the limb fitted with the cuff.**
 - **Do not use the NIBP cuff on a limb with an intravenous infusion or arterial catheter in place. This could cause tissue damage around the catheter when the infusion is slowed or blocked during cuff inflation.**
 - **NIBP measurements can be affected by the measurement site, the position of the patient, patient movement, or the patient's physiologic condition. If the NIBP measurement seems out of range or inaccurate, determine the patient's vital signs by alternative means and then verify that the monitor is working correctly.**
 - **Make sure the air hose connecting the NIBP cuff and the monitor is not blocked, twisted, or tangled.**
 - **Do not apply the cuff on the arm on the side of a mastectomy.**
 - **Continuous cuff pressure due to connection tubing kinking may cause blood flow interference and resulting harmful injury to the patient.**
 - **Devices that exert pressure on tissue have been associated with purpura, ischemia, and neuropathy. Inspect the application site regularly to ensure skin quality and inspect the extremity of the cuffed limb for normal color, warmth and sensitivity. If the skin quality changes, or if the extremity circulation is being affected, move the cuff to another site or stop the blood pressure measurements immediately. Check more frequently when making automatic or STAT measurements. Auto NIBP measurements with one and two minute intervals are not recommended for extended periods of time.**
-

9.3 Measurement Limitations

Measurements are impossible with heart rate extremes of less than 40 bpm or greater than 240bpm, or if the patient is on a heart-lung machine.

The measurement may be inaccurate or impossible:

- If arterial pressure pulses are hard to detect
- In the presence of excessive and continuous patient movement such as shivering or convulsions
- During certain cardiac arrhythmias
- For pregnant or pre-eclamptic patients
- Rapid blood pressure changes
- Severe shock or hypothermia that reduces blood flow to the peripheries
- Obesity, where a thick layer of fat surrounding a limb dampens the oscillations coming from the artery

9.4 NIBP Measurement Mode

There are the following modes of measuring NIBP:

- Manual: measurement on demand.
- Auto: continually repeated measurements at set intervals.
- STAT: continually rapid series of measurements over a five minute period, then return to the previous mode.
- Program: continually automatic measurement at set durations and intervals.

To set NIBP measurement mode, select NIBP parameter area to access **[NIBP Setup]** menu:

- Select **[Interval]** to select manual mode or auto NIBP measurement interval.
- Select **[NIBP STAT]** to start a continuous NIBP measurement.

9.5 Measuring NIBP

9.5.1 Preparing the Patient

In order to minimize NIBP measurement errors, whenever possible check that the patient:

- Is comfortably seated
- Has legs uncrossed
- Has feet flat on the floor
- Has back and arm supported, and
- The middle of the cuff at the level of the right atrium of the heart.

NOTE

- **It is recommended that the patient relax as much as possible before the NIBP measurement is performed and that the patient does not talk during measurement.**
 - **It is recommended that the patient sit still for 5 min before the first measurement is taken.**
 - **The operator should not touch the cuff and tubing during the NIBP measurement.**
-

9.5.2 Preparation to Measure NIBP

- 1 Power on the monitor.
2. Verify that the patient category is correct. If not, select the  hardkey → [Patient Demographics]→[Patient Category] and set the patient category to [Adult], [Pediatric] or [Neonatal].
3. Connect the NIBP hose to the monitor.
4. Select the appropriate sized cuff by referring to the limb circumference marked on the cuff.

The width of the cuff should be 40% (50% for neonates) of the limb circumference, or 2/3 of the upper arm's length. The inflatable part of the cuff should be long enough to encircle at least 50% to 80% of the limb.

5. Apply the cuff to an upper arm or thigh of the patient and make sure the Φ marking on the cuff matches the artery location. Do not wrap the cuff too tightly around the limb. It may cause discoloration, and ischemia of the extremities. Make sure that the cuff edge falls within the marked range. If it does not, use a cuff that fits better.
6. Connect the cuff to the air tubing and make sure that the bladder inside the cover is not folded and twisted. Air must pass unrestricted through the tubing.

 **WARNING**

- **Sustained cuff pressure due to a kinked hose may interfere with blood flow and could lead to patient injury.**
-

NOTE

- **The use of the equipment is restricted to one patient at a time.**
-

9.5.3 Starting NIBP measurement

Start NIBP measurement by one of the following ways:

- Press the  hardkey on the monitor's front panel
- Access [NIBP Setup] menu, and then select [Start NIBP] key to start a manual, programmed or automatic NIBP measurement with preset interval.
- Access [NIBP Setup] menu, and then select [NIBP STAT] to start a continuous NIBP measurement.

 **WARNING**

- **Continuous non-invasive blood pressure measurements may cause purpura, ischemia and neuropathy in the limb with the cuff. Inspect the application site regularly to ensure skin quality and inspect the extremity of the cuffed limb for normal color, warmth and sensitivity. If any abnormality occurs, move the cuff to another site or stop the blood pressure measurements immediately.**
-

9.5.4 Stopping NIBP Measurement

- Press the  hardkey on the monitor's front panel to stop a manual NIBP measurement, or a continuous NIBP measurement.
- Access [NIBP Setup] menu and then select [Stop All] to stop all the NIBP measurement, including manual, continuous, and auto NIBP measurement.

9.5.5 Correcting the Measurement if Limb is not at Heart Level

The cuff should be applied to a limb at the same level as the patient's heart. If the limb is not at the heart level, to the displayed value:

- Add 0.75 mmHg (0.10 kPa) for each centimetre higher, or
- Deduct 0.75 mmHg (0.10 kPa) for each centimeter lower.

9.6 Understanding the NIBP Numerics

The NIBP display shows numerics only as below. Your display may be configured to look slightly different.

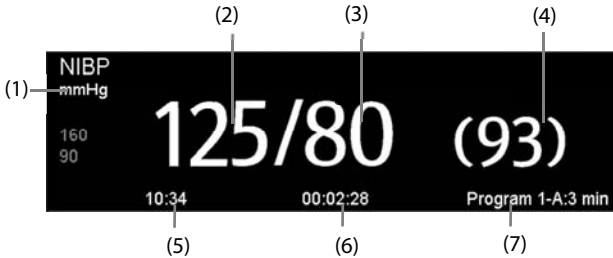

- (1) Unit of pressure: mmHg or kPa
- (2) Systolic pressure
- (3) Diastolic pressure
- (4) Mean pressure obtained after the measurement and cuff pressure obtained during the measurement
- (5) Time of last measurement
- (6) Time remaining to next measurement
- (7) Measurement mode

9.7 Setting NIBP

Select NIBP parameter area to access the **[NIBP Setup]** menu.

9.7.1 Setting Interval

In **[NIBP Setup]** menu, you can select **[Interval]** and set to:

- **[Manual]**: NIBP measurement is started manually.
- **[1 min], [2 min], [2.5 min], [3 min], [5 min], [10 min], [15 min], [20 min], [30 min], [1 h], [1.5 h], [2 h]**: The monitor automatically measures NIBP based on the specified time interval.
- **[Program 1]** and **[Program 2]**: The monitor automatically measures NIBP based on a program configured by user.

9.7.2 Setting the Initial Cuff Inflation Pressure

You can set the initial cuff inflation pressure manually. In the **[NIBP Setup]** menu, select **[Initial Pressure]** and then select the appropriate setting.

The initial inflation pressure range is as follows:

Patient Category	Range (mmHg)	Default (mmHg)
Adult	80 - 280	160
Pediatric	80 - 210	140
Neonate	60 - 140	90

NOTE

- For known hypertensive patients, you need to set initial cuff pressure to a higher value to reduce the measurement time.
-

9.7.3 Setting NIBP End Tone

The monitor can issue a reminder tone at the completion of NIBP measurement. The NIBP End Tone is off by default. You can switch it on by accessing the **[NIBP Setup]** menu.

9.7.4 Switching On/Off Measurement on Clock

In auto measuring mode, if the clock is enabled, the NIBP automatic measurement interval will be synchronized with the real time clock.

For example, if **[Clock]** is set to **[On]**, and **[Interval]** is set to **[20min]**, and then you start an NIBP auto measurement at 14: 03, the next measurement will be taken at 14: 20, and the following measurement time will be 14:40, 15:00 and so on.

9.7.5 Configuring a Custom Program

In **[NIBP Setup]** menu, you can select **[Custom Program>>]** and configure the duration of automatic measurement cycle, and the time interval between two NIBP measurement. You can define two programs, respectively program 1 and program 2. Each program can at most include five cycles: A, B, C, D, and E. In each cycle, the **[Duration]** and **[Interval]** can be set individually.

You shall start the programmed NIBP measurement manually, and then the monitor will automatically perform the measurement based on the cycle and interval you have defined.

When the programmed NIBP measurement is in use, the NIBP parameter area displays as follows:

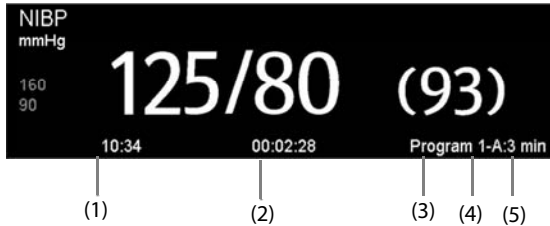

- (1) Time of last measurement
- (2) Time remaining to next measurement
- (3) Program name
- (4) Cycle name
- (5) NIBP measurement Interval

9.7.6 Setting NIBP Alarm Properties

Select [**Alarm Setup**>>] from [**NIBP Setup**] menu. You can set the alarm properties for this parameter in the popup menu.

9.7.7 Setting the Pressure Unit

1. Select [**Main**]→[**General Setup** >>]→[**Unit Setup** >>].
2. In the popup menu, select [**Pressure**] and toggle between [**mmHg**] and [**kPa**].

9.8 Assisting Venous Puncture

You can use the NIBP cuff to cause sub-diastolic pressure to block the venous blood vessel and therefore help venous puncture.

1. Select [**VeniPuncture >>**] from the [**NIBP Setup**] menu. In the popup menu, verify that the [**Cuff Press.**] value is appropriate. Change it if necessary.
2. Select [**VeniPuncture**] key.
3. Puncture vein and draw blood sample.
4. When the puncture is complete, select [**VeniPuncture**] key, or press the  hardkey on the monitor's front panel to deflate the cuff. The cuff deflates automatically after a set time if you do not deflate it.

During puncture, the NIBP display shows the real-time inflation pressure of the cuff, destination inflation pressure, and the remaining time in venous puncture mode.

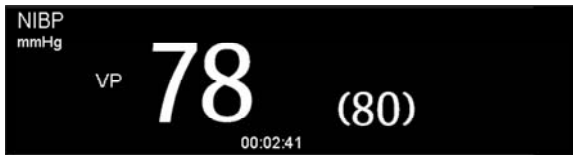

FOR YOUR NOTES

10 Monitoring Temp

The monitor can measure temperature with any one of the following temperature modules:

- SmarTemp™ module
- THP79JU ear thermometer
- Covidien Genius™ 2 tympanic tethered thermometer

10.1 Monitoring Temp with SmarTemp™ Module

The SmarTemp™ Temp module is intended for monitoring oral, axillary and rectal temperature of adult and pediatric patients and axillary temperature of neonatal patients.

Temperature can be measured in either Predictive mode or Monitor mode. The default is Predictive mode.



WARNING

- **Do not take oral temperature on the infant (0-3 years).**
 - **Do not take rectal temperature on the neonate (0-28 days).**
 - **Use only the specified temperature probe and probe cover. Using other probe or probe cover, or not using probe cover may cause damage to the monitor or failure to meet the declared specifications in this manual.**
 - **The temperature probe cover is disposable. Re-use of probe cover may result in patient cross-contamination.**
 - **Use disposable probe covers for temperature measurement. Failure to use a probe cover can cause inaccurate temperature readings, and patient cross-contamination.**
 - **Check the disposable probe cover for damage before using. Never use any probe cover for temperature measurement in case of damage or contamination.**
 - **Be careful to avoid damaging the temperature probe. Place the temperature probe in the probe well if not in use.**
 - **Prior to taking a temperature, instruct the patient not to bite down on the probe, as patient injury and damage to the probe may result.**
 - **In the rectal mode, incorrect probe placement may result in bowel perforation.**
 - **Wash hands after temperature is taken. This will significantly reduce the risk of cross contamination and nosocomial contamination.**
 - **Ensure that probe covers are disposed of according to local regulations or hospital's requirements.**
 - **Accuracy verification of the temperature module is required every two years or**
-



WARNING

according to your hospital's policy. Please contact our Customer Service if accuracy verification is needed.

NOTE

-
- **Patient actions may interfere with oral temperature readings. Ingesting hot or cold liquids, eating food, chewing gum, brushing teeth, smoking, or performing strenuous activities may affect temperature readings for up to 20 minutes after the activity has ended.**
 - **In the axillary mode, the probe shall directly contact with patient's skin. Measuring through patient's clothes or long-term exposure of patient's armpit to the air may result in inaccurate temperature reading.**
 - **Choose appropriate probe according to patient type and measurement site. Using the incorrect probe may cause patient's discomfort and inaccurate measurements.**
 - **Improper use of probe may also cause patient's discomfort and inaccurate measurements.**
-

10.1.1 Setting Temp

Select Temp parameter area to access [**Temp Setup**] menu. You can set:

- Temp type: [**Predictive**] or [**Monitor**].
- Temperature measurement site: the measurement site is related to the probe type. When using oral/axillary probe, you can select the site [**Oral**] and [**Axillary**]; when using rectal probe, you can select [**Rectal**].

You can select the temperature type and measurement site only when the probe is in the probe well.

10.1.2 Measuring Temp

10.1.2.3 Selecting Measuring Site

The temperature module can be configured with 2 types of temperature probe:

- oral/axillary probe (blue), and
- rectal probe (red)

The blue oral/axillary probe shall only be used with blue probe well, while the red rectal probe shall only be used with red well.

Be sure to select correct probe according to the measurement site.

- Oral/Axillary probe: This type of probe is intended for taking oral or axillary temperature of adult and pediatric patients, or axillary temperature of neonatal patient.
- Rectal probe: This type of probe is intended for taking rectal temperature of adult and pediatric patient.

When oral/axillary probe is used, the measurement site will automatically be set to **[Oral]**. You can change the site in **[Temp Setup]** menu.

10.1.2.4 Taking a Temperature in Predictive Mode

1. Verify that the probe is placed in the probe well.
2. Verify that the temperature measurement type and site are correct.
3. Unplug the probe from the probe well and insert it into a cover in the probe cover pack. Press the probe handle down firmly until the cover engages with the probe.
The temperature module starts to warm up when the probe is taken out. The message "Temp Warming Up" displays in Temp parameter area. The warming up time is about 2 seconds in room temperature. The monitor issues two beeps and provides the message "Temp Prediction Ready" on the screen when warm-up is complete. Then you can place the probe at measurement site.
4. Place the probe at measurement site and wait till the measurement stabilizes. When the dynamic symbol  appears, it indicates that the monitor starts to take the measurement.
 - ◆ When taking an oral temperature, apply the probe under the patient's tongue from either side of the mouth. Verify that the probe reaches the rear sublingual pocket. Have the patient close his/her lips to hold the probe. Hold the probe in place. Make sure that the probe contacts with the patient's oral tissue throughout the measurement.
 - ◆ When taking an axillary temperature, lift the patient's arm to expose the entire armpit. Apply the probe as high as possible in the armpit. Check that the probe tip is completely surrounded by the axillary tissue. Lower the patient's arm so that it is tightly placed at the patient side. Keep the patient's arm and the probe in place throughout the measurement.
 - ◆ When taking a rectal temperature, separate patient's buttocks with one hand, and the probe 1.5 cm inside the rectum with the other hand. For pediatric patient, depth of insertion shall be less. Tilt the probe so that it always contacts with patient's tissue. Lubricant can be used in rectal mode.

The monitor will give a beep as the temperature measurement is complete. The temperature reading displays continuously until the probe is taken out from the probe well.

5. Withdraw the probe. Press firmly the ejection button on the top of the probe to eject the probe cover. Replace the probe into the probe well.

In Predictive mode, the monitor automatically enters Monitor mode in the following cases:

- Accurate temperature is not reached.
- Neither measurement is taken nor is the probe replaced in the probe well in 60 seconds after the probe is withdrawn from the well.

The temperature type automatically changes to Predictive mode when the probe returns to the probe well.

NOTE

- **In Predictive mode, temperature probe shall be placed to the measurement site as soon as probe warmup is complete; otherwise, inaccurate temperature reading may result.**
 - **In Predictive mode, if the probe has a high temperature due to the environmental temperature or other causes, cool the probe and then measure the patient's temperature.**
-

10.1.2.5 Taking a Temperature in Monitor Mode

To measure a temperature in the Monitor mode,

1. Verify that the probe is placed in the probe well.
2. Verify that the temperature measurement type and site are correct.
3. Unplug the probe from the probe well and insert it into a cover in the probe cover pack. Press the probe handle down firmly until the cover engages with the probe.
4. Place the probe to the measurement site and then start measuring. Refer to Step 4 in **10.1.2.4 Taking a Temperature in Predictive Mode** for how to place a probe.
5. Withdraw the probe. Press firmly the ejection button on the top of the probe to eject the probe cover. Replace the probe into the probe well.

NOTE

- **In Monitor mode, record the measured value prior to taking away the probe from measurement site. The monitor will automatically stop measuring temperature after 10 minutes from the start of the measurement.**
-

10.1.3 Disinfecting Temperature Probe

The recommended disinfectants include: ethanol 70%, isopropanol 70%, glutaraldehyde-type 2% liquid disinfectants.

To disinfect the temperature probe:

1. Disconnect the temperature probe from Temp connector.

2. Disinfect the probe with a soft cloth dampened with the recommended disinfectant.
3. Wipe off all the remaining disinfectants from the probe with a soft cloth dampen with water.
4. Dry the probe in a cool place.

**WARNING**

-
- **Perform the decontamination or cleaning process with the monitor powered down and power cord removed.**
 - **The used soft cloth shall be properly disposed of.**
-

10.2 Monitoring Temp with THP79JU Infrared Ear Thermometer

The THP79JU infrared ear thermometer measures an ear temperature and transfers it to the monitor. The monitor displays and stores the transferred temperature measurement.

Read the ear thermometer manufacturer's instructions for use before attempting to configure, use, troubleshoot, or maintain the thermometer.

**WARNING**

-
- **No alarm is provided for the ear temperature measurement.**
-

**CAUTION**

-
- **Do not submerge the thermometer probe into liquids or expose it to direct moisture.**
 - **The ear thermometer may not function properly if dropped or damaged. When transporting the monitor by hand, properly secure the thermometer cable to keep the cable from dragging and to avoid thermometer dropping.**
-

10.2.1 Measuring Temperature

10.2.1.1 Connecting the Thermometer to the Monitor

**CAUTION**

-
- **Improper plug connection may damage the ear thermometer.**
-

To connect the ear thermometer to the monitor:

1. With the arrow-marked side of the plug face up, insert the plug into the ear thermometer connector.

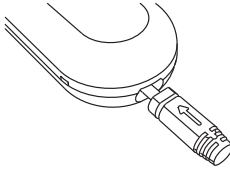

2. Lock the plug by turning the plug.
3. Place the ear thermometer on the dock.

10.2.1.2 Installing a Probe Cover Package

To install the probe cover package into the temperature dock:

1. Remove the ear thermometer from the dock.
2. Remove the probe cover loader by pressing the button on the right side of the dock and moving the loader forwards.

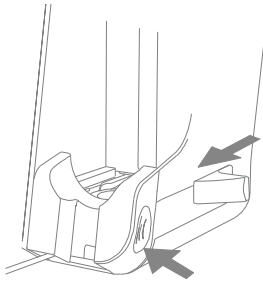

3. Rotate the loader cap counterclockwise, and then lift the cap.

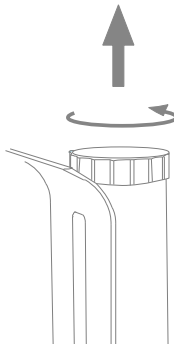

4. Place the probe cover package on the loader, and take away the slip to let the probe covers fall into the loader.

NOTE

- **It is recommended to quickly take away the slip to prevent the probe covers from turning over in the loader.**
-

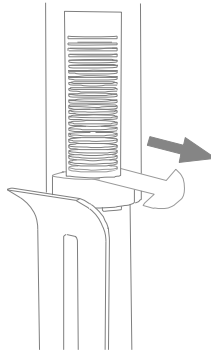

5. Push down the cap. Make sure that the cap is aligned with the notch on the loader. Then turn clockwise to lock the cap.
6. Push back the loader into the dock.
7. Replace the ear thermometer to the dock.

10.2.1.3 Taking an Ear Temperature



WARNING

- **Do not reuse the probe cover. Always use a new, undamaged and clean probe cover for a measurement.**
 - **Use only the specified probe cover.**
-

To take an ear measurement and transfer it to the monitor:

1. Power on the monitor.
2. Remove the ear thermometer from the dock.
3. Slide the lever to the end. A probe cover comes out when sliding the lever.
4. Release the lever.
5. Firmly press the probe tip into the probe cover until you hear a click.

6. Press "ON/MEM" button on the thermometer. When the thermometer is ready for measuring, the  icon continuously displays on the thermometer LCD and two beeps sound.
7. Gently pull the patient ear back to straighten the ear canal and position the probe into the ear canal towards the membrane of the eardrum.
8. Press the black "Scan" button on the back of the thermometer for 1 second until you hear a long beep sound. Then you can read the temperature measurement from the thermometer and the monitor.
9. When you finish measuring, push up the probe cover ejector, and remove the used probe cover.
10. Replace the thermometer to the dock.

When the monitor receives a measurement, the monitor displays and stores the measurement.

10.2.2 Understanding the Numerics

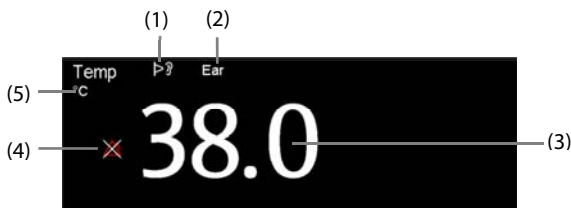

- (1) Thermometer On: The ear thermometer is turned on and connected to the monitor.
- (2) Measurement site
- (3) Temperature reading
- (4) Alarm off
- (5) Unit of measure: °C or °F

10.2.3 Troubleshooting

Message	Cause	Solution
Therm. battery low	The ear thermometer battery is low.	Replace the battery.
Therm. is not ready	A measurement is taken before the ear thermometer stabilizes.	Take a measurement until all the icons stop flashing.
Ambient temp changes fast	The environment temperature changes fast.	Use the thermometer in an environment of stable temperature.
Ambient temp out of range	The environmental temperature is out the range of 10°C to 40°C (50°F to 104°F).	Keep the thermometer from operating for at least 30 minutes at a room temperature of 10°C to 40°C (50°F to 104°F).
Therm. parameter error	The ear thermometer is not functioning properly.	Unload the thermometer battery, wait for one minute, and then repower the thermometer. If the message reappears, contact us for service.
Therm. software error		
Therm. hardware error1		
Therm. hardware error2		

10.2.4 Cleaning and Disinfecting the Ear Thermometer

Refer to the THP79JU Infrared Ear Thermometer instructions for use for cleaning and disinfection information.

10.3 Monitoring Temp with Genius™ 2 Tympanic Tethered Thermometer

The Genius™ 2 tympanic tethered thermometer is a fast, accurate, and convenient clinical instrument for measuring patient temperatures. The Genius™ 2 thermometer is an ear canal thermometer with measurement site equivalence modes including oral, core, and rectal equivalent temperatures.

The thermometer is powered by the monitor.

10.3.1 Safety Information



WARNING





- No alarm is provided for the temperature measurement.



CAUTION

- Used probe covers must be treated as infectious biological waste and disposed of in accordance with current medical practices and local regulations.

10.3.2 Thermometer Buttons

Button	Name	Functions
	Eject button	Press the eject button to eject the probe cover from the probe.
	°C/°F button	When a temperature is in the display, you may press and hold the °C/°F button to toggle between degrees Celsius and degrees Fahrenheit.
	Timer button	Press and hold the timer button to enter the timer mode. Press again to start the timer.
	Scan button	When the thermometer is on, press the scan button to initiate a temperature measurement. When the thermometer is off, press the scan button to turn on the device.

10.3.3 Equivalence Mode Temperature

The thermometer can measure the ear temperature and acquire the equivalence temperature.

A patient's temperature at the site of mouth, rectum, or core would be slightly different from the ear temperature. The thermometer compensates for the average difference in temperature at each of these sites by adjusting the displayed temperature.

A checker/calibrator is available for this device. The device should be checked if it is dropped or if it is stored at less than -25°C or above 55°C.

NOTE

- Only the authorized personnel can adjust the data for Genius 2 thermometer equivalence modes.

Equivalence Mode	Description
Oral	The temperature is adjusted to display an oral temperature equivalent. Oral Mode = Ear Mode + 0.60°C (33.08°F)
Core	The temperature is adjusted to display a core temperature equivalent. Core Mode = Ear Mode + 1.04°C (33.87°F)
Rectal	The temperature is adjusted to display a rectal temperature equivalent. Rectal Mode = Ear Mode + 1.04°C (34.08°F)

10.3.4 Taking a Temperature

To take a temperature, follow this procedure:

1. When the monitor starts, remove the thermometer from the dock.
2. Inspect the probe tip and make sure that the probe tip is clean. If it is soiled, clean it with a lens wipe or lint free swab.
3. Press the scan button to verify functionality and mode selection on the LCD screen.
4. Install a probe cover by firmly inserting the probe tip into a probe cover. Make sure that the probe cover is fully seated.
5. Place the probe in the ear canal.
6. Once positioned lightly in the ear canal, press and release the scan button.
7. Remove the probe from the ear as soon as the triple beep is heard. The temperature and probe eject icon display on the LCD screen.
8. Press the eject button to eject the probe cover.
9. Replace the thermometer to the base.

NOTE

-
- **Always wait at least two minutes before taking another measurement in the same ear.**
 - **Do not configure the thermometer during the start-up of the monitor. Otherwise, the thermometer data may conflict with the data that displays on the monitor.**
-

10.3.5 Temperature Display

Display on Monitor



- (1) Thermometer On: The thermometer is turned on and connected to the monitor.
- (2) Site
- (3) Temperature reading
- (4) Alarm off
- (5) Unit of measure: °C or °F

10.3.6 Troubleshooting

Message	Cause	Solution
Temp comm abnormal	The communication between the monitor and thermometer is abnormal.	Eject and re-install the probe cover. And then measure the temperature again.

10.3.7 Cleaning and Disinfecting the Tympanic Thermometer

Refer to the Genius 2 Tympanic Thermometer instructions for use for cleaning and disinfection information.

11 Monitoring CO₂

11.1 Overview

CO₂ monitoring is a continuous, non-invasive technique for determining the concentration of CO₂ in the patient's airway by measuring the absorption of infrared (IR) light of specific wavelengths. CO₂ has its own absorption characteristic and the amount of light passing the gas probe depends on the concentration of the measured CO₂. When a specific band of IR light passes through respiratory gas samples, some of IR light will be absorbed by the CO₂ molecules. The amount of IR light transmitted after it has been passed through the respiratory gas sample is measured with a photodetector. From the amount of IR light measured, the concentration of CO₂ is calculated.

The CO₂ measurement is to monitor the patient's respiratory status.

CO₂ monitoring is intended for adult, pediatric and neonatal patients.

11.2 Safety



WARNING

- **Remove the airway sampling line from the patient's airway while nebulized medications are being delivered.**
 - **Leakage in the breathing or sampling system may cause the displayed EtCO₂ values to be significantly low. Always make sure that all components are securely connected.**
 - **EtCO₂ values measured from the CO₂ module may differ from those of from the blood gas analysis.**
 - **Route all tubing away from the patient's throat to avoid strangulation.**
 - **Inspect the airway for a tight connection and make proper settings before attaching it to the patient.**
 - **Squeezing or bending the sampling line during the CO₂ measurement may cause inaccurate CO₂ reading or no reading.**
-

11.3 Measurement Limitations

The following factors may influence the measurement accuracy:

- Leaks or internal venting of sampled gas
 - Mechanical shock
 - Cyclic pressure up to 10 kPa (100 cmH₂O)
 - Other sources of interference, if any
-

Measurement accuracy may be affected by the breath rate and inspiration/expiration ratio (I: E ratio) as follow:

- EtCO₂ value is within specification for breath rate ≤ 60 bpm and I/E ratio ≤ 1:1;
- EtCO₂ value is within specification for breath rate ≤ 30 bpm and I/E ratio ≤ 2:1.

Measurement accuracy is unspecified for breath rate larger than 60 bpm.

11.4 CO₂ Display

The CO₂ parameter and waveform areas provide FiCO₂ measurement, EtCO₂ measurement, awRR measurement, and a CO₂ waveform.

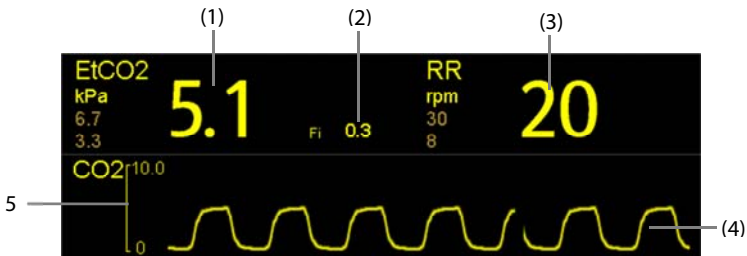

- (1) End tidal CO₂ (EtCO₂)
- (2) Fraction of inspired CO₂ (FiCO₂)
- (3) Airway respiration rate (RR)
- (4) CO₂ waveform
- (5) Scale

11.5 Measuring CO₂

CAUTION

- **Eliminate the exhausted gas before performing the measurement.**
 - **Connect an exhaust tube to the gas outlet connector of the monitor to vent the calibration gases to a scavenging system.**
 - **Check that the alarm limit settings are appropriate before taking measurement.**
-

To measure CO₂, follow this procedure:

1. Select the appropriate sampling line according to the patient category.
2. Connect the sampling line to the gas sampling port of the mini water trap by clockwise turning.

3. Plug the mini water trap to the CO₂ sampling line connector on the monitor.

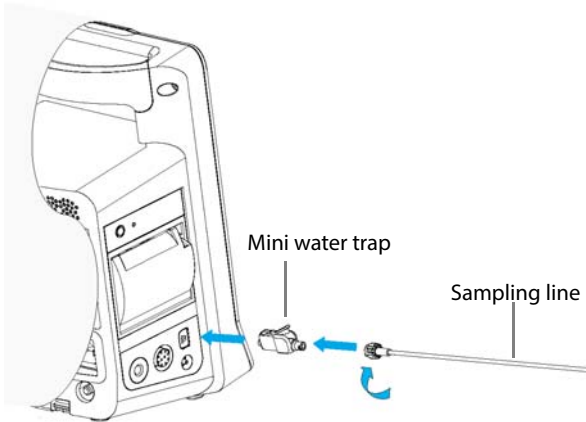

4. Connect the other end of the sampling line to the patient.



5. Connect the CO₂ gas outlet to the scavenging system with an exhaust tube.

CO₂ can be measured after the start-up is complete.

 **CAUTION**

- **The DRYLINE PRIME mini water trap is automatically blocked when its service life is reached. Replace the DRYLINE PRIME mini water trap if the alarm “CO₂: Change Watertrap” occurs.**
 - **The water trap has a filter preventing bacterium, water and secretions from entering the module. Extended use could destroy the filter in water trap and fail to stop the bacterium, water and secretions entering the module, result in damaging the gas module and having infection risk.**
-

NOTE

- To extend the lifetime of the mini water trap and module, disconnect the mini water trap from the module and set the operating mode to Standby mode when CO₂ monitoring is not required.
-

11.6 Automatic CO₂ Module Zeroing

The CO₂ module performs zero calibration automatically when needed.

NOTE

- The CO₂ module temporarily stops measuring during zeroing.
-

11.7 Changing CO₂ Settings

11.7.1 Changing CO₂ Alarm Settings

To change the CO₂ alarm settings, follow this procedure:

1. Select the CO₂ numeric area or waveform area to enter the [CO₂ Setup] menu.
2. Select [Alarm Setup>>].
3. Set the following alarm properties:
 - ◆ Switch on or switch off the alarms.
 - ◆ Adjust the alarm limits and alarm priority.

11.7.2 Setting the Apnea Alarm Delay

The monitor will alarm if the patient has stopped breathing for longer than the preset Apnea time.

To set the Apnea delay time, follow this procedure:

1. Select the CO₂ numeric area or waveform area to enter the [CO₂ Setup] menu.
2. Select [Apnea Delay] and then select the appropriate setting.

11.7.3 Setting the CO₂ Waveform

To set the CO₂ waveform, follow this procedure:

1. Select the CO₂ numeric area or waveform area to enter the [CO₂ Setup] menu.
2. Set [Wave Type], [Sweep] and [Scale] of the CO₂ waveform.

- ◆ Select [**Wave Type**] and toggle between [**Draw**] and [**Fill**].
 - [**Draw**]: The CO₂ wave is displayed as a curved line.
 - [**Fill**]: The CO₂ wave is displayed as a filled area.
- ◆ Select [**Sweep**] and then select the appropriate setting. The faster the wave sweeps, the wider the wave is.
- ◆ Select [**Scale**] and then change the size of the CO₂ waveform.

11.7.4 Entering the Standby Mode

You can set the CO₂ module to one of the following modes according to the module status:

- Select [**Measure**] mode when you use the CO₂ module for monitoring.
- Select [**Standby**] mode when you does not use the CO₂ module to prolong the service life of the CO₂ module.

The default operating mode is [**Measure**]. If you are not using the CO₂ module, you can proceed as follows to enter the Standby mode:

1. Select the CO₂ numeric area or waveform area to enter the [**CO2 Setup**] menu.
2. Set [**Operating Mode**] to [**Standby**].

11.7.5 Setting the Auto Standby

The monitor enters the standby mode automatically after the configured period of time if no breath is detected since the last detected breath.

To set the auto standby, follow this procedure:

1. Select the CO₂ parameter area or waveform area to enter the [**CO2 Setup**] menu.
2. Set [**Auto Standby**].

11.7.6 Setting Humidity Compensation

The CO₂ module is configured to compensate CO₂ readings for either Body Temperature and Pressure, Saturated Gas (BTPS), to account for humidity in the patient's breath, or Ambient Temperature and Pressure, Dry Gas (ATPD).

- ATPD: $P_{CO_2} (mmHg) = CO_2 (vol\ %) \times P_{amb} / 100$
- BTPS: $P_{CO_2} (mmHg) = CO_2 (vol\ %) \times (P_{amb} - 47) / 100$

Where, P_{CO_2} = partial pressure, $vol\ %$ = CO₂ concentration, P_{amb} = ambient pressure, and unit is mmHg.

To set the humidity compensation, follow this procedure:

1. Select the CO₂ numeric area or waveform area to enter the [**CO2 Setup**] menu.

2. Set [BTPS Compensation] to [On] or [Off].

11.7.7 Setting Gas Compensation

The presence of interfering gas affects the CO₂ measurement. To get the best possible measuring result, it is needed to set the gas compensation. The configured concentration of the interfering gas should be in accordance with its actual proportion.



WARNING

- **Make sure to use the appropriate compensations. Inappropriate compensations may cause inaccurate measurement values and result in misdiagnosis.**
-

To set the gas compensation, follow this procedure:

1. Select the CO₂ numeric area or waveform area to enter the [CO₂ Setup] menu.
2. Set the O₂, N₂O and AA compensation according to the actual amount of the respective gas in the ventilation gas mixture.

11.7.8 Automatic Barometric Pressure

The CO₂ module has the function of automatic barometric pressure compensation.

11.7.9 Calibrating the CO₂ Module

A calibration should be performed once a year or when the readings go far beyond the range. For details, refer to **16.6.3 Calibrating CO₂**.

12 Clinical Scoring

12.1 Overview

The Clinical Scoring function helps a clinician quickly determine the severity of illness of a patient based on a calculated score, so that the clinician can take necessary measures according to the indication provided by the Clinical Scoring function.

The monitor supports the following scorings:

- MEWS (Modified Early Warning Score)
- NEWS (National Early Warning Score)
- Customizable Score



WARNING

- **The Clinical Score is intended to be used only by healthcare professionals and to be serviced by trained personnel.**
 - **The scores and clinical responses in the clinical scores are for reference and cannot be used alone for diagnostic interpretation.**
 - **Both MEWS and NEWS are not applicable to pregnant woman, COPD (Chronic Obstructive Pulmonary Disease) patients and those under 16 years old.**
-

12.1.1 MEWS (Modified Early Warning Score)

The MEWS calculates a total score and provides a clinical response based on the following five parameters:

- ◆ Pulse Rate
- ◆ Systolic NIBP
- ◆ Respiration Rate
- ◆ Temperature
- ◆ AVPU (Alert, Reacting to Voice, Reacting to Pain, and Unresponsive)

This scoring is only applicable to adult.

12.1.2 NEWS (National Early Warning Score)

The NEWS calculates a total score and provides a clinical response based on the following seven parameters:

- ◆ Respiration Rate
- ◆ SpO₂
- ◆ Supplemental Oxygen

- ◆ Temperature
- ◆ Systolic NIBP
- ◆ Pulse Rate
- ◆ AVPU

This scoring is only applicable to adult.

12.1.3 Customizable Scoring

The customizable scoring can provides a clinical response based on the selected multiple parameters or single parameter.

- ◆ Multiple parameter scoring; calculate a total score and provide a clinical response based on the multiple parameters which are defined.
- ◆ Individual parameter scoring (IPS); provide a clinical response whenever any individual parameter value is out of range.

The available parameters in customizable scoring include:

- ◆ Respiration Rate
- ◆ SpO₂
- ◆ Supplemental Oxygen
- ◆ Temperature
- ◆ Systolic NIBP
- ◆ Pulse Rate
- ◆ Level of Consciousness (either AVPU or GCS)
- ◆ Blood Sugar
- ◆ Urine Output
- ◆ Catheter
- ◆ Pain Score
- ◆ Pain
- ◆ Inspired O₂%
- ◆ Airway
- ◆ Three customizable parameters

The applicable patient category can be defined with the Mindray Clinical Scoring Config Tool. Refer to ***Clinical Scoring Config Instruction for Use*** (P/N: 046-007126-00) for customizable scorings.

12.2 Entering the Calculation Screen

You can calculate a score in the scoring screen or in the score tile.

12.2.1 Scoring Screen

Select [**Scoring**] QuickKey to access the Scoring screen.

12.2.2 Score Tile

The score tile is located in the main screen. By default, the scoring tile is not displayed. The scoring tile will activate when you select a default scoring or load a scoring.

12.3 Calculating a Score

To calculate a score, follow this procedure:

1. Select the default scoring or load a scoring for the applicable patient category. Refer to **12.6.2 Selecting Default Scoring** or **12.6.4 Loading a Scoring**.
2. Obtain the value of all parameters, and then total score will be automatically calculated. Refer to **12.5 Obtaining the Total Score**.
3. If necessary, record the scoring data. Refer to **12.4 Clinical Scoring Screen**.

12.4 Clinical Scoring Screen

12.4.1 Score Tile in the Main Screen

The MEWS, NEWS and multi-parameter score tile display as following:

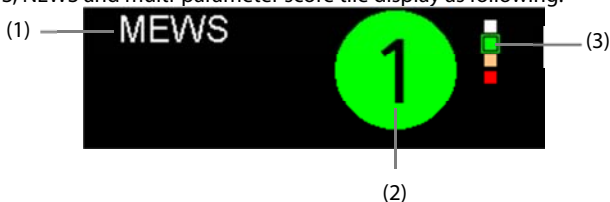

- (1) Name for clinical score
- (2) Total score: the background color indicates the current score level.
- (3) Score level indicator

It indicates that the warning level increases from top to bottom. The current level is enclosed in the square frame.

The IPS score tile displays as following:



- (1) Name for clinical score

(2) Score Status

- ◆ Red : indicates that at least one parameter is out of the defined range.
- ◆ White : indicates that all the parameters are within the normal range.

12.4.2 Scoring Screen

The MEWS, NEWS or multi-parameter score screen display as following:

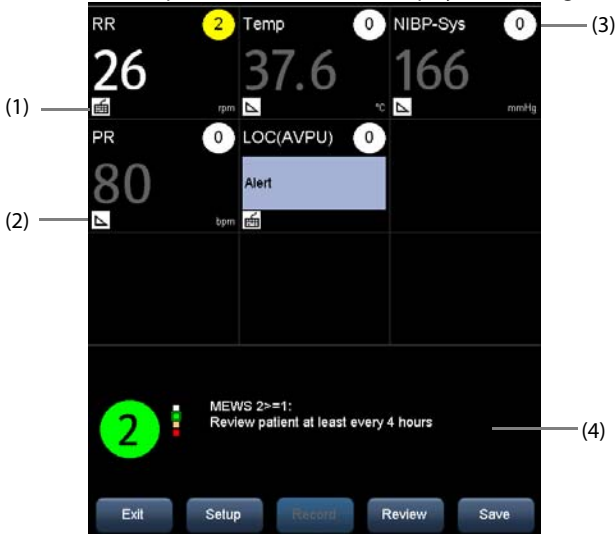

- (1) Icon for manual input
You need to manually input the parameter.
- (2) Icon for real-time monitoring
The parameter value is from the monitor.
- (3) Score for single parameter
- (4) Recommended clinical response

The IPS score screen displays as following:

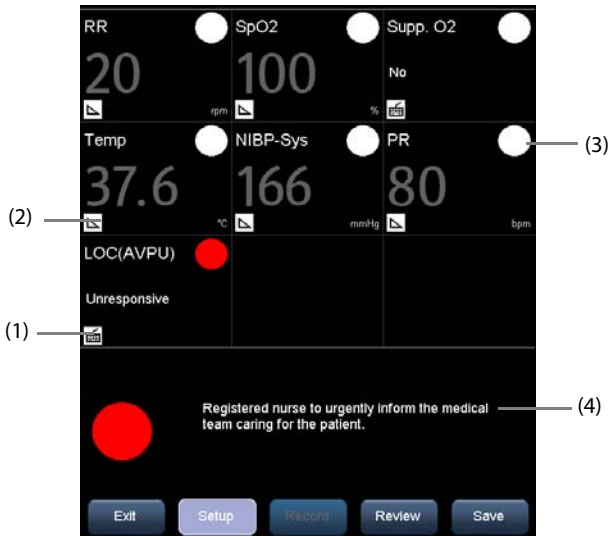

- (1) Icon for manual input
You need to manually input the parameter.
- (2) Icon for real-time monitoring
The parameter value is from the monitor
- (3) Score status for single parameter
 - ◆ Red : indicates that the parameter is out of the defined range.
 - ◆ White : indicates that the parameter is within the normal range.
- (4) Recommended clinical response

In the above screens, you can:

- Select **[Review]** to open the patient review screen. Refer to **4.4 Reviewing Patient Data** for details.
- Select **[Record]** to print the current patient scoring data with a recorder.
- Select **[Save]** to save the scoring data in the **[Results]** screen. Refer to **4.3 Manually Save Patient Data**.
- Select **[Exit]** to go to the main screen.

12.5 Obtaining the Total Score

The IPS only calculates the parameter status. The IPS does not have total score.

For other scorings, the total score will automatically be calculated when each required

parameter tile has a value. To calculate a score, follow this procedure:

1. Start monitoring parameters. Their values are automatically obtained.
2. Manually input the values for the parameters that are not monitored.

NOTE

- **If the value is measured by the monitor, the value displays in grey. You cannot manually input the value.**
- **When you are in the scoring screen, if an alarm for the monitoring parameter occurs, the alarm indicators still can be seen in the monitor display.**

The parameter input range is as follows:

Parameter	Range
Pulse Rate	20 bpm -300 bpm
Systolic NIBP	40 mmHg -270 mmHg (Adult) 40 mmHg -200 mmHg (Pediatric) 40 mmHg -135 mmHg (Neonate)
Respiration Rate	0-150 rpm
Temperature	0.1°C – 50.0°C (32.1°F – 122.0°F)
Level of Consciousness	AVPU: Alert, Reacting to Voice, Reacting to Pain, Unresponsive GCS: 1-15
Supplemental Oxygen	Yes, No
SpO2	0% – 100%
Urine Output	0 -300 ml/h (0 – 10 ml/h/kg)
Catheter	Yes, No
Blood Sugar	1.0 mg/dl -720.0 mg/dl (0.06 mmol/L -40.00 mmol/L)
Pain Score	0-10
Pain	None, Mild, Moderate, Severe
Inspired O2%	21% -100%
Airway	Clear, Obstruction
Customizable parameter	The input range depends on the decimal point. The decimal point is customizable in Mindray Clinical Scoring Config Tool. 0 – 9999 (decimal point as 1) 0.0 – 999.9 (decimal point as 0.1) 0.00 – 99.99 (decimal point as 0.01)

12.6 Managing Scorings

12.6.1 Importing the Scoring

You can import MEWS, NEWS and customized scorings into the monitor. Up to five scoring protocols can be imported into the monitor.

1. Connect the USB drive to the USB connector on the monitor.
2. Select **[Main]** → **[Maintenance>>]** → **[User Settings>>]** → Enter the required password → **[Manage Scoring>>]** → **[Import Scoring>>]**.
3. In the **[Import Scoring]** menu, select the scorings to be imported. Then select **[Import]**. A status message will report completion of the import.

NOTE

- **To load the customized scoring protocols to the USB drive, refer to *Clinical Scoring Config Instruction for Use (P/N: 046-007126-00)*.**
-

12.6.2 Selecting Default Scoring

The monitor does not provide default scoring. To select a default scoring:

1. Select **[Main]** → **[Maintenance>>]** → **[User Settings>>]** → Enter the required password → **[Manage Scoring>>]** → **[Select Default Scoring>>]**.
2. Set the default scoring for the applicable patient category.

After the default scoring is set, when a patient category is changed, the monitor will automatically use the default scoring.

12.6.3 Deleting the Scoring

To delete the scoring:

1. Select **[Main]** → **[Maintenance>>]** → **[User Settings>>]** → Enter the required password → **[Manage Scoring>>]** → **[Delete Scoring>>]**.
2. In the **[Delete Scoring]** menu, select the scoring to be deleted.
3. Select **[Delete]**.

12.6.4 Loading a Scoring

The default scoring may not be appropriately for the new patient. You can load a scoring so as that the scoring is appropriate for your patient.

To load a scoring:

1. Select **[Scoring]** → **[Setup]** → **[Load Scoring>>]**.
2. Select the desired scoring to be loaded.
3. Select **[Load Scoring]**.

FOR YOUR NOTES

13 Recording

13.1 Using a Recorder

The thermal recorder records patient information, parameters numerics (measured value and manual input value), SpO₂ waveforms (if configured), and so on.

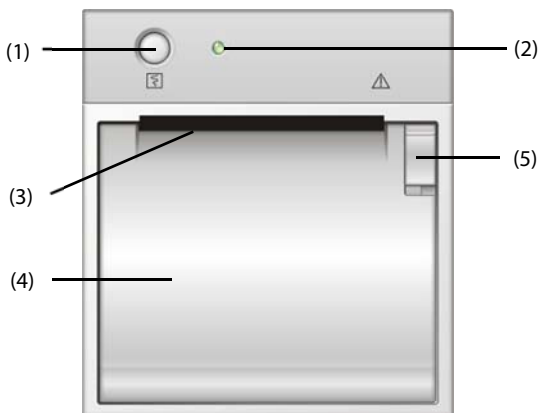

- (1) Start/Stop key: press to start a recording or stop the current recording.
- (2) Indicator
 - ◆ On: when the recorder works properly.
 - ◆ Off: when the monitor is switched off.
 - ◆ Flash: when an error occurred to the recorder, e.g. the recorder runs out of paper.
- (3) Paper outlet
- (4) Recorder door
- (5) Latch

13.2 Loading Paper

1. Press the latch at the upper right of the recorder door to open the door.
2. Insert a new roll into the compartment as shown below.
3. Close the recorder door.
4. Check if paper is loaded correctly and the paper end is feeding from the top.

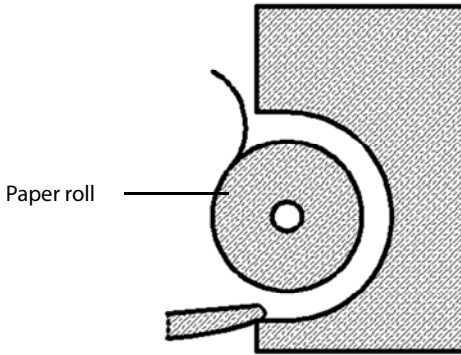

 **CAUTION**

- **Use only specified thermal paper. Otherwise, it may cause damage to the recorder's printhead, the recorder may be unable to print, or poor print quality may result.**
 - **Never pull the recorder paper with force when a recording is in process. Otherwise, it may cause damage to the recorder.**
 - **Do not leave the recorder door open unless you are replacing the recorder paper or removing a fault.**
-

13.3 Setting the Recorder

Select **[Main]**→**[General Setup >>]**→**[Print Setup >>]** to access the **[Print Setup]** menu and select the items as you want.

13.4 Starting and Stopping Recordings

To manually start a recording, you can either:

- Press  hardkey on the recorder.
- Select **[Record]** key in graphic or tabular trend.

The monitor will automatically start recording when the **[Save]** QuickKey is selected to save the manual input patient data if **[Automatically Record on Manual Save]** is enabled from the **[User Settings>>]** menu.

To manually stop the current recording, you select  hardkey.

Recordings stop automatically when:

- A recording is completed.

- The recorder runs out of paper.
- When the recorder has an alarm condition.

When a recording is stopped, the following markers will be added:

- Automatically stopped recording: print two columns of '*' at the end of the printout.
- Manually or abnormally stopped recording: print one column of '*' at the end of the printout.

13.5 Reports

13.5.1 Real-time Recording

Real-time recording strip includes recording time, parameter values displayed on the screen, as well as SpO₂ waveform, patient information and manual inputs as configured in the **[Print Setup]** menu.

13.5.2 Graphic Trend Recording

Graphic trend strip includes patient information, recording time, and graphic trends of all the parameters on the screen.

In graphic trends strip,

- The mark "A" is shown on the event time.
- The mark "?" indicates system time changes.
- NIBP measurement taken in Spot mode shows as .
- The predictive temperature and PR (from NIBP) measurement show as "■".

13.5.3 Continuous Trends Recording

The continuous trend recording strip show a tabular which includes patient information, recording time, measured value, the saving time for each measurement, and NIBP and Temp complete time.

To print the continuous trends,

1. Choose one patient, and then select **[Record]** in the **[Continuous Trends]** screen.
2. Set the start and end time for the recording.
3. Select **[Record]** to start recording.

13.5.4 Spot Check Trends Recording

The spot check trends strip includes patient information, recording time, measured value and measurement complete time. When **[Filter]** is set to **[Manually Saved]** or **[All]**, the manual input data can be recorded.

To print the spot check trends,

1. Select the patient and filter.
2. Select **[Record]**.

If several patients are selected, the recorder will print the data in sequence. Data from different patients are separated by vertical dashes.

13.6 Removing Paper Jam

If the recorder works incorrectly or produces unusual sound, check if there is a paper jam. If a paper jam is detected, follow this procedure to remove it:

1. Open the recorder door.
2. Take out the paper and tear off the draped part.
3. Reload the paper and close the recorder door.

13.7 Cleaning the Recorder Printhead

If the recorder has been used for a long time, deposits of paper debris may collect on the printhead compromising the print quality and shortening the lifetime of the roller. Follow this procedure to clean the printhead:

1. Take measures against the static electricity such as Disposable Wrist Strap for the work.
2. Open the recorder door and take out the paper.
3. Gently wipe around the printhead using cotton swabs dampened with alcohol.
4. After the alcohol has completely been dried, reload the paper and close the recorder door.



CAUTION

- **Do not use anything that may destroy the thermal element.**
 - **Do not add unnecessary force to the thermal head.**
-

14 Network

14.1 Network Connection

The monitor can be connected to the central station through the network.

- The monitor transmits waveforms and numerics of parameters (Temp, SpO₂, NIBP, CO₂), related alarms and alarm settings, patient information, and operating mode to the central station. The waveforms, numerics, alarms, alarm settings, patient information, and operating mode displayed on central station are consistent with the monitor.
- The central station transmits alarm settings, parameter settings, patient information and operating mode settings (enter or exit the Standby mode) to the monitor. The alarm settings, parameter settings, patients' information and operating mode settings of the monitor are consistent with central station.

The monitor can be connected to the ADT system and the EMR system through the eGateway.

- The monitor transmits the query command message to the ADT system. When the ADT system receives the query command message, the ADT system will transmit the patients' information to the monitor.
- The monitor transmits numerics of Temp, SpO₂, NIBP, CO₂, related alarms and alarm settings, patient information, operating mode, and historical data, including trends and events, to the EMR. When the EMR receives the data, the EMR will send a success message to the monitor.



CAUTION

- **Disconnecting from the network may result in data loss, including parameter waveforms and measurements, alarm events, trends and patient data, or cause functional failure. In the case of network disconnection, check the patient and solve the network problem as soon as possible.**
-

14.2 Network Type and Settings

The equipment supports both wired and wireless network. To set the network type,

1. Select **[Main]**→**[Maintenance >>]**→**[User Settings >>]**→Enter the required password→Select **[Ok]**.
2. Select **[Network Setup>>]**→**[Monitor Network Setup >>]**.

In the Monitor Network Setup menu, you can:

- Set **[Network Type]** to **[LAN]** or **[WLAN]**.
- Set **[Address Type]** to **[DHCP]** or **[Manual]**.
 - ◆ If **[Address Type]** is set to **[DHCP]**, the monitor can automatically acquire network parameters.
 - ◆ If **[Address Type]** is set to **[Manual]**, you need to manually input the monitor IP address, subnet mask and gateway address.

14.2.1 Wireless Network

The patient monitors can be connected to a wireless network via a built-in Wi-Fi module. To set the wireless network:

1. Select **[Main]**→**[Maintenance>>]**→**[User Settings >>]**→enter the required password→Select **[Ok]**→**[Network Setup >>]**→**[Monitor Network Setup >>]**.
2. Set the **[Network Type]** to **[WLAN]**.
3. Select **[WLAN Setup >>]** to access the WLAN setup menu.
4. Configure the **[Network Name (SSID)]**, **[Security]** and **[Password]**.
5. Click **[OK]** to confirm the setting.

14.2.2 WLAN Test

To test the availability of the wireless network, follow this procedure:

1. Select **[WLAN Test >>]** in the **[Network Setup]** menu.
2. Enter the **[IP Address]** of wireless AP in the **[WLAN Test >>]** menu.
3. Click **[Connection Test]**.

The Wi-Fi device used in the monitor is in compliance with IEEE 802.11a/b/g/n.

You should not change the patient monitor's IP address randomly. If you want to know details about IP address setup, contact the technical personnel in charge of the CMS.

NOTE

- **The design, installation, reconstruction and maintenance of the wireless network's distribution shall be performed by authorized service personnel of our company.**
 - **The existence of obstacles (such as wall) will exert impact on data transferring or even cause network interruption.**
 - **An access point (AP) supports a maximum of 16 monitors through wireless network.**
 - **Keep network authentication information (e.g, password) safe to protect the**
-

network from being accessed by unauthorized users.

- **The total throughput of all the wireless devices connected to the wireless network should be less than the effective transmitting capability of the wireless network. The throughput capacity of a single VS-900 is 700 kbps.**
 - **Do not connect non-approved devices to the wireless network.**
 - **Where the monitor is located, the signal strength of other Wi-Fi devices on the same channel should be no greater than -85 dBm.**
 - **Where the monitor is located, the signal strength of other Wi-Fi devices on adjacent channels should be no greater than -50 dBm.**
 - **The recommended distance between the patient monitor and other non-Wi-Fi wireless devices, including wireless devices at the frequency of 2.4GHz (e.g. cellular mobile communication networks, microwave ovens, interphones, cordless phones and electro-surgical units) is no less than 20 cm.**
-

14.3 Setting Data Send Method

You can choose to send the monitor data to hospital system through eGateway or HL7 protocol.

1. Select **[Main]**→**[Maintenance >>]**→**[User Settings >>]**→Enter the required password→Select **[Ok]**→**[Network>>]**.
2. Set **[Data Send Method]** to **[eGateway Send]** or **[HL7 Direct Send]**.

14.3.1 ADT Communication Setup

1. Select **[Main]**→**[Maintenance >>]**→**[User Settings >>]**→Enter the required password→Select **[Ok]**→**[Network >>]**→**[ADT Communication>>]**.
2. Set IP address and port, and switch on/off ADT query.
3. Select **[Ok]** to exit the menu.

14.3.2 EMR Communication Setup

1. Select **[Main]**→**[Maintenance >>]**→**[User Settings >>]**→Enter the required password→Select **[Ok]**→**[Network>>]**→**[EMR Communication >>]**.
2. Set the IP address and port.
3. Select **[Ok]** to exit the menu.

14.3.3 NTP Server Setup

1. Select **[Main]**→**[Maintenance >>]**→**[User Settings >>]**→Enter the required password→Select **[Ok]** to access User Settings menu.

2. Select [**Network>>**]→[**NTP Setup>>**].
3. Select [**NTP Setup>>**] to enter the NTP Setup menu. Set the following properties:
 - ◆ Set IP address and port.
 - ◆ Set the interval.
 - ◆ Set the time zone.
 - ◆ Switch on/off the daylight saving time.
4. Select [**Ok**] to exit the menu.

To manually start one time synchronization with the NTP server, follow this procedure:

1. Select [**Main**]→[**Maintenance >>**]→[**User Settings >>**]→Enter the required password→Select [**Ok**] to access User Settings menu.
2. Select [**Network>>**]→[**NTP Setup>>**]→[**Manual**].

14.3.4 Realtime Date Send Interval (for HL7 only)

The monitor will send out the monitored parameter data at the set intervals.

1. Select [**Main**]→[**Maintenance >>**]→[**User Settings >>**]→Enter the required password→Select [**Ok**] to access User Settings Menu.
2. Select [**Network>>**]→[**EMR Communication>>**].
3. Set [**Real Data Send**] to an appropriate setting.

14.3.5 Alarm Server Setup (for HL7 only)

1. Select [**Main**]→[**Maintenance >>**]→[**User Settings >>**]→Enter the required password→Select [**Ok**] to access User Settings menu.
2. Select [**Network>>**]→[**Alarm Server Setup**].
3. Set the IP address and port.
4. Select [**Ok**] to exit the menu.

14.4 Connecting the monitor to the CMS

To connect the monitor to the CMS, proceed as follows:

1. Select [**Main**]→[**Maintenance >>**]→[**User Settings >>**]→enter the required password→Select [**Ok**]→[**Network >>**]→[**Monitor Network Setup >>**].
2. Set [**Network Type**] and [**Address Type**].
3. Input the monitor IP address, subnet mask and gateway address if the [**Address Type**] is set to [**Manual**]
4. Connect the monitor to the CMS through either of the following methods:

- ◆ Admit the monitor on the CMS. Refer to the *Hypervisor VI Operator's Manual (PN: 300B-20-47610)* for details of admitting a monitor.
- ◆ Setting the CMS (refer to section **14.4.1 Setting the CMS** for details), and then selecting a CMS (refer to section **14.4.2 Selecting a CMS** for details).

14.4.1 Setting the CMS

You can configure up to 30 central stations (CMS) for your monitor. To set the CMSs,

1. Select [**Main**]→[**Maintenance>>**]→[**User Settings >>**]→enter the required password→Select [**Ok**]→[**Network>>**].
2. Set [**Select CMS**] to [**On**].
3. Select [**Central Station Setup >>**].
4. Set CMS names and corresponding IP addresses.

14.4.2 Selecting a CMS

If [**Select CMS**] is enabled, you can select the CMS for the current monitoring.

To select the CMS, select the prompt message area at the bottom of the screen. Then the selected CMS name will display.

If the CMS you select does not have a name, this area displays "???".

14.4.3 Clearing the Selected CMS at Startup

You can clear the selected CMS each time the monitor restarts after being powered off for more than 2 minutes.

To clear the selected CMS,

1. Select [**Main**]→[**Maintenance>>**]→[**User Settings >>**]→enter the required password→Select [**Ok**]→[**Network>>**].
2. Set [**Clear CMS IP at startup**] to [**On**]

The selected CMS will not be cleared when only one CMS is configured, or the monitor is restarted within 2 minutes.

This function is switched off by default.

14.5 Certificates Maintenance

You can import or delete the monitor's certificates.

1. Select [**Main Menu**]→[**Maintenance>>**]→[**User Maintenance>>**]→enter the required password→[**Network >>**]→[**Certificates Maintenance >>**].

2. Select [**Import certificates >>**] or [**Delete certificates >>**].

14.6 Setting the Multicast Parameters

Whether the equipment is presented by broadcast or multicast is defined before the equipment leaves the factory. If [**Multicast**] is selected, you need to set the multicast parameters.

To do so,

1. Select [**Main**]→[**Maintenance>>**]→[**User Settings >>**]→enter the required password→Select [**Ok**]→[**Network >>**]→[**Multicast Setup >>**].
2. Set [**Multicast Addr**] and [**TTL**].

14.7 DIAP Communication Setup

1. Select [**Main**]→[**Maintenance >>**]→[**User Settings >>**]→Enter the required password→Select [**Ok**] to access user settings menu.
2. Select [**DIAP Communication>>**] to access [**DIAP Communication Setup**] menu.
3. Set up the baud rate.
4. Select [**Ok**] to exit the menu.

15 Battery

15.1 Overview

The monitor is designed to operate from battery power when AC power supply is not available. In case of power failure, the equipment will automatically run power from internal battery. So we recommend you always install a fully charged battery in the equipment.

Where the integrity of the external protective conductor in the installation or its arrangement is in doubt, the equipment shall be operated from the battery.







CAUTION

- **Remove the battery before transporting the equipment or if the equipment will not be used for a long time.**
-

NOTE

- **It is recommended to always install a fully charged battery in the monitor to ensure normal monitoring in case of accidental power failure.**
-

The on-screen battery symbol indicate the battery status as follows:

-  Indicates that battery works correctly. The solid portion represents the current charge level of the battery in proportion to its maximum charge level.
-  Indicates that the battery has low charge level and needs to be charged.
-  Indicates that the battery is almost depleted and need to be charged immediately. Otherwise, the monitor will shut down automatically.
-  Indicates that no battery is installed.

The capacity of the battery is limited. When the battery is low, the technical alarm area displays [**Low Battery**], the alarm lamp flashes, and monitor produces alarm sound.

If the battery is deplete, the battery symbol on the screen starts to flash, the technical alarm area displays [**Battery Depleted**], the alarm lamp flashes, and monitor produces alarm sound. At this moment, connect the equipment to AC mains to run the equipment and charge the battery. Otherwise the equipment will shut down.

15.2 Charging a Battery

The battery is charged whenever the monitor is connected to an AC power source regardless of whether or not the monitor is currently on. When battery is charging, the AC power indicator and battery indicator are both On. The battery status symbol on the monitor screen displays  when the charging is complete.

15.3 Replacing a Battery

1. Power off the monitor.
2. Open the battery compartment door.
3. Push aside the latch fixing the battery to be replaced and remove the battery.
4. Place a new battery into the slot with its contact point inward.
5. Close the battery compartment door.

15.4 Battery Guidelines

Life expectancy of a battery depends on how frequent and how long it is used. For a properly maintained and stored lithium ion battery, its life expectancy is about 3 years. For more aggressive use models, life expectancy can be less. We recommend replacing lithium ion batteries every 3 years.

To get the most out of the battery, observe the following guidelines:

- The battery performance test must be performed once a year, before monitor repairs, or whenever the battery is suspected as being the source of the problems.
- Condition the batteries once when they are used or stored for three months, or when their run time becomes noticeably shorter.
- Take out the battery before the monitor is transported or will not be used for more than 3 months.
- Remove the battery from the monitor if it is not being used regularly. (Leaving the battery in a monitor that is not in regular use will shorten the life of the battery).
- The shelf life of a Lithium Ion battery is about 6 months when the battery is stored with the battery power being 50% of the total power. In 6 months the battery power must be depleted before the Lithium Ion battery is fully charged. Then run the monitor on this fully charged battery. When its battery power becomes 50% of the total power, take out the battery from the monitor and store it.
- When storing batteries, make sure that the battery terminals do not come into contact with metallic objects. If batteries are stored for an extended period of time, they should be placed in a cool place with a partial charge of 40% to 60% capacity. Storing batteries at high temperature for an extended period of time

will significantly shorten the life expectancy of a battery. Do not store the battery at a temperature beyond -20°C- 60°C.



WARNING

- **Keep the battery out of children's reach.**
 - **Use only specified batteries.**
 - **If the battery shows signs of damage or signs of leakage, replace it immediately. Do not use a faulty battery in the monitor.**
-
-

15.5 Battery Maintenance

15.5.1 Conditioning a Battery

A battery should be conditioned before it is used for the first time. A battery conditioning cycle is one uninterrupted charge of the battery, followed by an uninterrupted battery discharge and charge. Batteries should be conditioned regularly to maintain their useful life.

To condition a battery, follow this procedure:

1. Disconnect the monitor from the patient and stop all monitoring or measuring.
2. Insert the battery in need of conditioning into the battery slot of the monitor.
3. Connect the monitor to AC power. Allow the battery to be charged uninterrupted till the battery is full and the battery indicator is off.
4. Remove AC power and allow the monitor to run from the battery until it shuts off.
5. Again connect the monitor to AC power. Allow the battery to be charged uninterrupted till the battery is full and the battery indicator is off.

NOTE

- **The actual battery capacity will decrease over time with use of batteries. For old batteries, the full capacity battery symbol does not indicate the capacity and operating time of this battery can still fulfill battery specifications in the operator's manual. Please replace the battery if its operating time is significantly lower than the specified time.**
-

15.5.2 Checking a Battery

The performance of a rechargeable battery may deteriorate over time. The battery performance test must be performed once a year, before monitor repairs, or whenever the battery is suspected as being the source of the problems.

To check the performance of a battery, follow this procedure:

1. Disconnect the monitor from the patient and stop all monitoring or measuring.
-

2. Install the battery.
3. Connect the monitor to AC power. Allow the battery to be charged uninterrupted till the battery is full and the battery indicator is off.
4. Remove AC power and allow the monitor to run from the battery until it shuts off.

The operating time of a battery reflects their performance directly. If the operating time of a battery is noticeably shorter than that stated in the specifications, contact your service personnel.

NOTE

- **The battery might be damaged or malfunctioned if its operating time is too short after being fully charged. The operating time depends on the configuration and operation. For example, measuring NIBP more frequently will also shorten the operating time.**
 - **When a battery has visual signs of damage, or no longer holds a charge, it should be replaced. Remove the old battery from the monitor and recycle it properly.**
-

15.6 Recycling a Battery

When a battery has visual signs of damage, or no longer holds a charge, it should be replaced. Remove the old battery from the monitor and recycle it properly. To dispose of the batteries, follow local laws for proper disposal.



WARNING

- **Do not disassemble batteries, or dispose of them in fire, or cause them to short circuit. They may ignite, explode, leak or heat up, causing personal injury.**
-
-

16 Care and Maintenance

The monitor should be maintained and cleaned on a regular basis. This chapter describes the basic cleaning, disinfection and test method.

WARNING

- **Failure of the responsible individual, hospital or institution employing this equipment to implement a satisfactory maintenance schedule may cause undue equipment failure and possible health hazards.**
 - **The safety checks or maintenance involving any disassembly of the equipment should be performed by professional servicing personnel. Otherwise, undue equipment failure and possible health hazards could result.**
 - **If you discover a problem with any of the equipment, contact your service personnel or us.**
 - **The responsible hospital or institution shall carry out all cleaning and disinfection procedure specified in this chapter.**
 - **Do not open the equipment housings. All servicing and future upgrades must be carried out by the personnel trained and authorized by our company only.**
 - **No modification of this equipment is allowed.**
 - **The service personnel must be properly qualified and thoroughly familiar with the operation of the equipment.**
-

16.1 Cleaning and Disinfection

In this chapter we only describe cleaning and disinfection of the main unit. For the cleaning and disinfection of other reusable accessories, refer to instructions for use of corresponding accessories.

Keep you equipment and accessories clean. To avoid damage to the equipment, follow these rules:

- Always dilute according the manufacturer's instructions or use lowest possible concentration.
- Do not immerse part of the equipment into liquid.
- Do not pour liquid onto the equipment or accessories.
- Do not allow liquid to enter the case.
- Never use abrasive materials (such as steel wool or silver polish), or erosive cleaners (such as acetone or acetone-based cleaners).

 **WARNING**

- **Be sure to shut down the system and disconnect all power cables from the outlets before cleaning the equipment.**
 - **Use only the substances approved by us and methods listed in this chapter to clean or disinfect your equipment. Warranty does not cover damage caused by unapproved substances or methods.**
 - **We make no claims regarding the efficacy of the listed chemicals or methods as a means for controlling infection. For the method to control infection, consult your hospital's Infection Control Officer or Epidemiologist.**
-
-

 **CAUTION**

- **If you spill liquid on the equipment or accessories, contact us or your service personnel.**
-

16.1.1 Cleaning

Your equipment should be cleaned on a regular basis. If there is heavy pollution or lots of dust and sand in your place, the equipment should be cleaned more frequently. Before cleaning the equipment, consult your hospital's regulations for cleaning the equipment.

Recommended cleaning agents are:

- sodium hypochlorite bleach (diluted)
- Hydrogen peroxide (3%)
- Ethanol (70%)
- Isopropanol (70%)

To clean your equipment, follow these rules:

1. Shut down the monitor and disconnect it from the power line.
2. Clean the display screen using a soft, clean cloth dampened with a glass cleaner.
3. Clean the exterior surface of the equipment using a soft cloth dampened with the cleaner.
4. Wipe off all the cleaning solution with a dry cloth after cleaning if necessary.
5. Dry your equipment in a ventilated, cool place.

16.1.2 Disinfecting

Disinfection may cause damage to the equipment and is therefore not recommended for this monitor unless otherwise indicated in your hospital's servicing schedule. Cleaning equipment before disinfecting is recommended.

The recommended disinfectants include: ethanol 70%, isopropanol 70%, Perform® classic concentrate OXY.

16.2 General Inspection

Before every first use, after your equipment has been used for 6 to 12 months, or whenever your equipment is repaired or upgraded, a thorough inspection should be performed by qualified service personnel to ensure the reliability.

Follow these guidelines when inspecting the equipment:

- Make sure that the environment and power supply meet the requirements.
- Inspect the equipment and its accessories for mechanical damage.
- Inspect all power cords for damage, and make sure that their insulation is in good condition.
- Make sure that only specified accessories are applied.
- Inspect if the alarm system functions correctly.
- Make sure that the recorder functions correctly and the recorder paper meets the requirements.
- Make sure that the battery meets the performance requirements.
- Make sure that the monitor is in good working condition.

In case of any damage or abnormality, do not use the equipment. Contact the hospital's biomedical engineers or your service personnel immediately.

16.3 Maintenance and Testing Schedule

The following maintenance and tests, except for visual inspection, power on test, touchscreen calibration, and battery check, shall be carried out by the service personnel only. Contact your service personnel if any maintenance is required. Make sure to clean and disinfect the equipment before any test and maintenance.



CAUTION

- **Care should be taken to change the settings in [User Settings >>] and [Factory Maintenance >>] menus to avoid data loss.**
 - **Service personnel should acquaint themselves with the test tools and make sure that test tools and cables are applicable.**
-

Check/Maintenance Item		Recommended Frequency
Preventive Maintenance		
Visual inspection		When first installed or after reinstalled.
NIBP Tests	Pressure check	<ol style="list-style-type: none"> If the user suspects that the measurement is incorrect. Following any repairs or replacement of the module. At least once a year
	Leakage Test	
CO ₂ Test	Leakage test	
	Performance test	
	Calibration	
Performance Test		
SpO ₂ Test		<ol style="list-style-type: none"> If the user suspects that the measurement is incorrect. Following any repairs or replacement of the module. At least once every two years for SpO₂ and Temp, and at least once a year for NIBP and CO₂.
NIBP test	Pressure check	
	Leakage test	
Temp test		
CO ₂ test and calibration	Leakage test	
	Performance test	
	Calibration	
Nurse Call Relay Performance Test		If user suspects that the nurse call or analog output does not work well.
Electrical safety tests		
Electrical safety tests		At least once every two years, or as required.
Other tests		
Power on test		<ol style="list-style-type: none"> When first installed or after reinstalled. Following any maintenance or the replacement of any main unit parts.
Touchscreen Calibration		<ol style="list-style-type: none"> When the touchscreen appears abnormal. After the touchscreen is replaced.
Recorder check		Following any repair or replacement of the recorder.
Battery check	Functionality test	<ol style="list-style-type: none"> When first installed. Whenever a battery is replaced.
	Performance test	Once a year or if the battery run time reduced significantly.

16.4 Checking Monitor Information

Select **[Main]**→**[Maintenance >>]**→**[Monitor Information>>]**, you can view

- system software version
- copyright information
- system configuration by selecting **[Monitor Configuration>>]**, or;
- status information, such as start time, self-test error, and so on by selecting **[Monitor Log>>]**



You can print out the log information for the convenience of troubleshooting. Select **[Recorder]** from the **[Monitor Log]** menu to do recording. The information will not be saved after system shutdown.

16.5 NIBP Test

16.5.1 NIBP Leakage Test

The NIBP leakage test checks the integrity of the system and of the valve. It is required at least once a year or when you doubt the measured NIBP. If the test failed, corresponding prompt messages will be given. If no message is displayed, it means no leakage is detected.

Tools required:

- An adult cuff
- An air tubing
- A correct sized cylinder

Follow this procedure to perform the leakage test:

1. In the **[Patient Demographics]** menu, set **[Patient Category]** to **[Adult]**.
2. Connect the cuff to the NIBP cuff connector on the monitor.
3. Wrap the cuff around the cylinder as shown below.

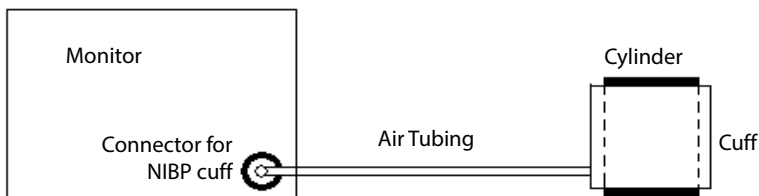

4. Select **[Main]**→**[Maintenance >>]**→**[User Settings>>]**→Enter required password→**[Module Maintenance >>]**→**[NIBP Leakage Test]**. The message **[Leakage Testing...]** is displayed in the NIBP parameter area.

After about 20 seconds, the monitor will automatically deflate. This means the test is completed. If the message **[NIBP Pneumatic Leak]** is displayed, it indicates that the NIBP airway may have leakages. Check the tubing and connections for leakages. If you ensure that the tubing and connections are all correct, perform a leakage test again. If the problem persists, contact your service personnel.

NOTE

-
- **The leakage test is intended for use to simply determine whether there are leakages in the NIBP airway.**
-

16.5.2 NIBP Accuracy Test

The NIBP accuracy test is required at least once a year or when you doubt the measured NIBP.

Tools required:

- T-shape connector
- Tubing
- Balloon pump
- Metal Vessel (volume 500 ± 25 ml)
- Reference manometer (calibrated with accuracy equal to or better than 0.75 mmHg)

Follow this procedure to perform the accuracy test:

1. Connect the equipment as shown.

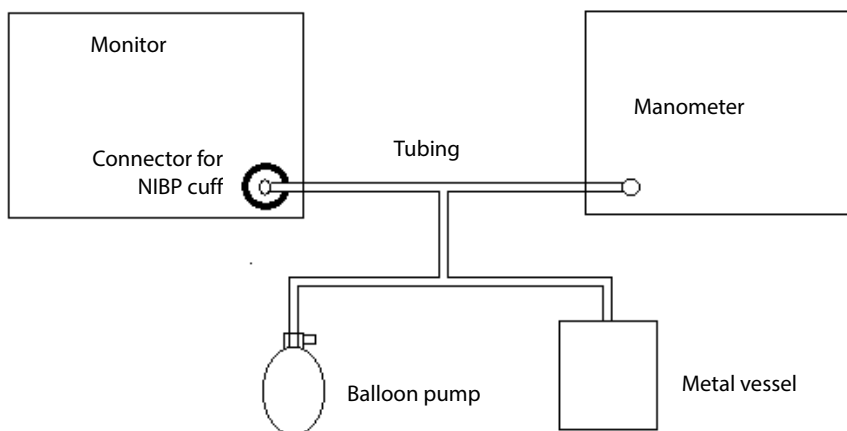

2. Before inflation, check that the reading of the manometer should be 0. If not, open the valve of the balloon pump to let the whole airway open to the atmosphere. Close the valve of the balloon pump after the reading is 0.
3. Select **[Main]** → **[Maintenance >>]** → **[User Settings>>]** → Enter required password → **[Module Maintenance >>]** → **[NIBP Accuracy Test]**. The message **[Accuracy Testing...]** is displayed in the NIBP parameter area.
4. Check the manometer values and the monitor reading. Both should be 0mmHg.
5. Raise the pressure in the metal vessel to 50 mmHg with the balloon pump. Then wait for 10 seconds until the measured values become stable.
6. Compare the manometer values with the displayed values. The difference between the manometer and displayed values should be within ± 3 mmHg.
7. Raise the pressure in the metal vessel to 200 mmHg with the balloon pump. Then wait for 10 seconds until the measured values become stable. Repeat step 6.

If the difference between the manometer and displayed values is greater than 3 mmHg, contact your service personnel.

16.6 CO₂ Test

16.6.1 CO₂ Leakage Test

For low flow rate CO₂ module, leakage test is needed every year or when you suspect the measurement.

Follow this procedure to perform the test:

1. Wait until CO₂ warmup is finished and then use your hand or other objects to completely block the gas inlet of the mini water trap.

The alarm message [**CO₂ FilterLine Occluded**] is displayed on the screen after certain time.

2. Block the gas inlet for another 30 seconds.

If the alarm message does not disappear, it indicates that the module does not leak.

16.6.2 CO₂ Accuracy Test

For the CO₂ module, accuracy test is needed every year or when you suspect the measurement.

Tools required:

- A steel gas cylinder with $5\pm 0.03\%$ CO₂ and balance gas N₂ (P/N 0075-00-0033-01)
- T-shape connector
- Tubing

Follow this procedure to perform the test:

1. Wait until the CO₂ module warmup is finished, and check the airway for leakage and perform a leakage test as well to make sure the airway has no leakage.
2. Select [**Main**]→[**Maintenance >>**]→[**User Settings >>**]→enter the required password→[**Module Maintenance >>**]→[**Calibrate CO₂>>**]→[**Calibrate**].
3. Connect the test system as follows:

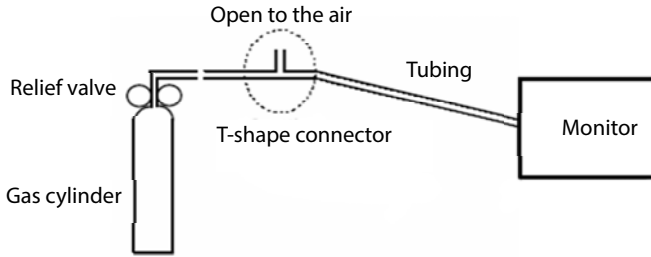

5. Open the relief valve to vent standard CO₂ and make sure that there is an excess gas flow through the T-shape connector to air.
6. Check the realtime CO₂ value is within 5.0±0.3% in the **[Calibrate CO₂]** menu.

16.6.3 Calibrating CO₂

For the CO₂ module, a calibration is needed every year or when the measured values have a great deviation. Calibration for the CO₂ module can be performed only when the module enters the full accuracy mode.



WARNING

- **Connect an exhaust tube to the gas outlet connector of the monitor to remove the calibration gases to a scavenging system.**
-

Tools required:

- A steel gas cylinder with 5±0.03% CO₂ and balance gas N₂ (P/N 0075-00-0033-01)
- T-shape connector
- Tubing

Follow this procedure to perform a calibration:

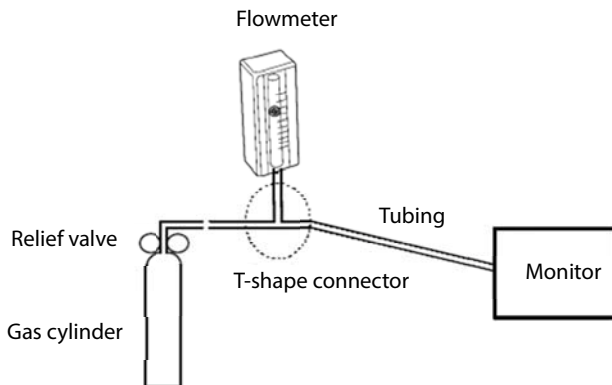

1. Make sure that the CO₂ module has been warmed up or started up.
2. Check the airway for leakage and perform a leakage test as well to make sure the airway has no leakage.
3. Select **[Main]**→**[Maintenance >>]**→**[User Settings >>]**→ enter the required password→**[Module Maintenance >>]**→**[Calibrate CO₂ >>]**→**[Zero]**.
4. After the zero calibration is finished successfully, connect the equipment as follows:



5. Turn on and adjust the relief valve to make the flowmeter reads within 10-50ml/min and keeps stable as well.
6. In the [**Calibrate CO₂**] menu, enter the vented CO₂ concentration in the [**CO₂**] field.
7. In the [**Calibrate CO₂**] menu, the measured CO₂ concentration is displayed. After the measured CO₂ concentration becomes stable, select [**Calibrate**] to calibrate the CO₂ module.

If the calibration is finished successfully, the message [**Calibration Completed!**] is displayed in the [**Calibrate CO₂**] menu. If the calibration failed, the message [**Calibration Failed!**] is displayed. In this case, perform another calibration.

16.7 Calibrating the Touchscreen

1. Select [**Main**]→[**Maintenance>>**]→[**Calibrate Touchscreen**]. The  symbol will appear at different positions of the screen.
2. Select, in turn the central point of the  symbol. After the calibration is completed, the message [**Screen Calibration Completed!**] is displayed.
3. Select [**Ok**] to confirm the completion of the calibration.

16.8 Formatting the Storage Card

The monitor is configured with an SD card for saving data. To format the storage card:

1. Select [**Main**]→[**Maintenance >>**]→[**User Settings >>**]→Enter the required password→Select [**Ok**] to access the [**User Settings**] menu.
2. Select [**Format Storage Card**], and then select [**Ok**] in the pop-up dialog.

16.9 Modifying Password

1. Select [**Main**]→[**Maintenance >>**]→[**User Settings >>**]→Enter the required password→Select [**Ok**] to access the [**User Settings**] menu.

2. Select [**Modify Password>>**].
3. Enter new password and then select [**Ok**].

FOR YOUR NOTES

17 Accessories



WARNING

- Use accessories specified in this chapter. Using other accessories may cause damage to the equipment or not meet the claimed specifications.
- Single-use accessories are not designed to be reused. Reuse may cause a risk of contamination and affect the measurement accuracy.
- Check the accessories and their packages for any sign of damage. Do not use them if any damage is detected.
- The disposable accessories shall be disposed of according to hospital's regulations.
- The accessory material that contacts the patients or other staff has undertaken the bio-compatibility test and is verified to be in compliance with ISO 10993-1.
- Use the accessories before the expiry date if their expiry date is indicated.
- For details about the accessories, refer to the instructions for use provided with the accessory.

17.1 SpO₂ Accessories

Extension Cable

Module type	Remarks	Part No.
Mindray SpO ₂ Module	7 pins, 2.5 m	0010-20-42710
	7 pins, 1.2 m	040-001443-00
Masimo SpO ₂ Module	8 pins, 2.1 m	040-000332-00
Nellcor SpO ₂ Module	8 pins, 2.5 m	0010-20-42712

SpO₂ Sensors

Mindray SpO ₂ module			
Type	Model	Patient Category	Part No.
Disposable	MAX-AI	Adult (>30Kg)	0010-10-12202
	MAX-PI	Pediatric (10 to 50Kg)	0010-10-12203
	MAX-II	Infant (3 to 20Kg)	0010-10-12204
	MAX-NI	Neonate (<3Kg), Adult (>40Kg))	0010-10-12205

Mindray SpO₂ module			
Type	Model	Patient Category	Part No.
	520A	Adult (non-adhesive)	520A-30-64101
	520P	Pediatric (non-adhesive)	520P-30-64201
	520I	Infant (non-adhesive)	520I-30-64301
	520N	Neonate (non-adhesive)	520N-30-64401
Reusable	DS-100A	Adult (Finger)	9000-10-05161
	OXI-P/I	Pediatric, infant	9000-10-07308
	OXI-A/N	Adult, neonate	9000-10-07336
	ES-3212-9	Adult, Neonate (Ear)	0010-10-12392
	518B	Neonate (Foot)	518B-30-72107
	518C	Neonate (Foot)	040-000330-00
	512E	Adult (Finger)	512E-30-90390
	512F	Adult (Finger, split)	512F-30-28263
	512F	Adult (Finger, integrated)	115-012807-00
	512G	Pediatric (Finger)	512G-30-90607
512H	512H-30-79061		

Masimo SpO₂ module			
Type	Model	Patient Category	Part No.
Disposable	LNCS NeoPt-L	Pediatric, neonate	0010-10-42626
	LNCS Neo-L	Neonate	0010-10-42627
	LNCS Pdtx	Pediatric	0010-10-42629
	LNCS Adtx	Adult	0010-10-42630
	LNCS NeoPt	Neonate (<1 kg)	040-000295-00
	LNCS Neo	Adult and pediatric (>40 Kg), neonate(<3 Kg)	040-000296-00
	LNCS Inf	Pediatric and neonate (3 to 20 Kg)	040-000297-00
Reusable	LNCS DCI	Adult (Finger)	0010-10-42600
	LNCS DCIP	Pediatric (Finger)	0010-10-42634
	LNCS YI	Adult, pediatric, neonate (Finger)	0010-10-43016

Nellcor SpO₂ Module			
Type	Model	Patient Category	Part No.
Disposable	MAX-AI	Adult (>30Kg)	0010-10-12202
	MAX-PI	Pediatric (10 to 50Kg)	0010-10-12203
	MAX-II	Infant (3 to 20Kg)	0010-10-12204
	MAX-NI	Neonate (<3Kg), Adult (>40Kg)	0010-10-12205
Reusable	DS-100A	Adult	9000-10-05161
	OXI-P/I	Pediatric, infant	9000-10-07308
	OXI-A/N	Adult, neonate	9000-10-07336
	D-YS	Adult, Pediatric, infant, neonate	0010-10-12476

Wavelength emitted by the sensors is between 600 nm and 1000 nm.

The maximum photic output consumption of the sensor is less than 18 mW.

The information about the wavelength range and maximum photic output consumption can be especially useful to clinicians (for example, when photodynamic therapy is performed).

17.2 NIBP Accessories

Tubing

Type	Patient Category	Part No.
Reusable	Adult, pediatric, infant	6200-30-09688
	Neonate	6200-30-11560

Reusable Cuff

Model	Patient Category	Measurement Site	Limb Circumference (cm)	Part No.
CM1200	Small Infant	Arm	7 to 13	115-002480-00
CM1201	Infant		10 to 19	0010-30-12157
CM1202	Pediatric		18 to 26	0010-30-12158
CM1203	Adult		24 to 35	0010-30-12159
CM1204	Large adult		33 to 47	0010-30-12160
CM1205	Adult	Thigh	44 to 66	0010-30-12161
CM1300	Small infant	Arm	7 to 13	040-000968-00

Model	Patient Category	Measurement Site	Limb Circumference (cm)	Part No.
CM1301	Infant		10 to 19	040-000973-00
CM1302	Pediatric		18 to 26	040-000978-00
CM1303	Adult		24 to 35	040-000983-00
CM1304	Large adult		33 to 47	040-000988-00
CM1305	Adult	Thigh	46 to 66	040-000993-00

Disposable Cuff

Model	Patient Category	Measurement Site	Limb Circumference (cm)	Part No.
CM1500A	Neonate	Arm	3.1 to 5.7	001B-30-70692
CM1500B			4.3 to 8.0	001B-30-70693
CM1500C			5.8 to 10.9	001B-30-70694
CM1500D			7.1 to 13.1	001B-30-70695
CM1500E			8 to 15	001B-30-70681
CM1501	Infant		10 to 19	001B-30-70697
CM1502	Pediatric		18 to 26	001B-30-70698
CM1503	Adult		24 to 35	001B-30-70699
CM1504	Large adult		33 to 47	001B-30-70700
CM1505	Adult	Thigh	46 to 66	001B-30-70701

17.3 Temp Accessories

17.3.1 SmarTemp™ Accessories

Probe Well

Type	Description	Part No.
Reusable	Blue, oral /axillary	M09A-20-62062
	Red, Rectal	M09A-20-62062-51

Temp Probes

Type	Patient Category	Measurement Site	Part No.
Reusable	Adult, Pediatric, Neonate	Oral/ Axillary	6006-30-39598
	Adult, Pediatric	Rectal	6006-30-39599

Probe Cover

Type	Patient Category	Description	Part No.
Disposable	Adult, Pediatric, Neonate	Cover, 20 pcs/pack	M09A-20-62124
	Adult, Pediatric, Neonate	Cover, 200 pcs/pack	M09A-30-62126
	Adult, Pediatric, Neonate	Cover, 2000 pcs/pack	M09A-30-62128

17.3.2 THP79JU Ear Thermometer Accessories

Ear Thermometer

Type	Description	Part No.
Reusable	Infrared ear thermometer	100-000102-00

Probe Cover

Type	Patient Category	Description	Part No.
Disposable	Adult, Pediatric, Neonate	Cover, 200 pcs/pack	100-000103-00

17.3.3 Genius™ 2 Tympanic Thermometer Accessories

Tympanic Thermometer

Type	Description	Part No.
Reusable	Tethered tympanic thermometer	100-000198-00

Probe Cover

Type	Patient Category	Description	Part No.
Disposable	Adult, Pediatric, Neonate	Cover, 96 pcs/case	100-000200-00

17.4 CO₂ Accessories

Water Trap

Type	Description	Part No.
Disposable	DRYLINE™ PRIME Watertrap mini	100-000151-00

Sampling Line

Type	Model	Description	Patient Category	Part No.
Disposable	DRYLINE™ PRIME	Gas sampling line with airway adapter	Adult, Pediatric	100-000138-00
		Gas sampling line with airway adapter	Neonate	100-000139-00
		Nasal gas sampling line	Adult	100-000142-00
		Nasal gas sampling line	Pediatric	100-000143-00
		Nasal gas sampling line	Neonate	100-000144-00
	DRYLINE™ PRIME+	Gas sampling line with airway adapter	Adult, Pediatric	100-000140-00
		Gas sampling line with airway adapter	Neonate	100-000141-00
		Nasal gas sampling line	Adult	100-000145-00
		Nasal gas sampling line	Pediatric	100-000146-00
		Nasal gas sampling line	Neonate	100-000147-00

A Product Specifications

A.1 Classifications

The equipment is classified, according to IEC60601-1:

Type of protection against electrical shock	CLASS I EQUIPMENT, equipment energized from an external and internal electrical power source.
Degree of protection against electrical shock	DEFIBRILLATION-PROOF TYPE CF AAPPLIED PART for SpO ₂ , NIBP, and TEMP DEFIBRILLATION-PROOF TYPE BF AAPPLIED PART for CO ₂
Mode of operation	Continuous
Degree of protection against harmful ingress of water	IPX1 (Protection against vertically falling water drops)
degree of safety of application in the presence of a FLAMMABLE ANAESTHETIC MIXTURE WITH AIR or WITH OXYGEN OR NITROUS OXIDE	EQUIPMENT not suitable for use in the presence of a FLAMMABLE ANAESTHETIC MIXTURE WITH AIR or WITH OXYGEN OR NITROUS OXIDE
Degree of mobility	Portable

A.2 Environmental Specifications

Main Unit

Item	Operating conditions	Storage conditions
Temperature	0 to 40 °C	-20 to 60 °C
Relative humidity (non-condensing)	15% to 95%	10% to 95%
Barometric	57.0 to 107.4 kPa	16.0 to 107.4 kPa

SmarTemp™ Temperature Module

Item	Operating conditions	Storage conditions
Temperature	5 °C to 40 °C	-20 °C to 60 °C
Relative humidity (non-condensing)	15% to 95%	10% to 95%
Barometric	57.0 kPa to 107.4 kPa	16.0 kPa to 107.4 kPa

Genius™ 2 Temperature Module

Item	Operating conditions	Storage conditions
Temperature	16°C to 33 °C (60.8°F to 91.4 °F)	-25 to 55°C (-13°F to 131°F)
Relative humidity (non-condensing)	10% to 95%	up to 95%



- The equipment may not meet the performance specifications if stored or used outside the specified temperature and humidity ranges.
-

NOTE

- The environmental specifications of unspecified parameters are the same as those of the main unit.
-

A.3 Power Supply Specifications

AC Power

Line voltage	100 to 240 VAC ~ ($\pm 10\%$)
Current	0.9 to 0.5A
Frequency	50/60 Hz ($\pm 3\text{Hz}$)
Fuse	T2AL-250V

Battery

Battery (Standard)	
Battery Type	LI13I001A, Chargeable Lithium-Ion
Voltage	11.1 VDC
Capacity	2600 mAh
Run time	At least 3 hours when powered by a new fully-charged battery at 25°C $\pm 5^\circ\text{C}$ with SpO ₂ cable connected, and auto NIBP measurements at an interval of 15 minutes.
Charge time	Monitor power off: less than 3 hours to 90%; less than 4 hours to 100%. Monitor power on: less than 6 hours to 90%; less than 7.5 hours to 100%.

Shutdown delay	At least 20 minutes (after a low battery alarm first occurs)
Battery (Optional)	
Battery Type	LI23S002A, Chargeable Lithium-Ion
Voltage	11.1 VDC
Capacity	4500 mAh
Run time	At least 8 hours when powered by a new fully-charged battery at 25°C ± 5°C with SpO ₂ cable connected, and auto NIBP measurements at an interval of 15 minutes.
Charge time	Monitor power off: less than 5.5 hours to 90%; less than 6.5 hours to 100%. Monitor power on: less than 10.5 hours to 90%; less than 11.5 hours to 100%.
Shutdown delay	At least 20 minutes (after a low battery alarm first occurs)

A.4 Physical Specifications

Size	178mm × 150mm × 260mm
Weight	≤2.5 kg (with SpO ₂ module, NIBP module, recorder module and a battery)

A.5 Hardware Specifications

A.5.1 Display

Screen type	Color TFT LCD
Screen Size (diagonal)	8.4"
Resolution	800×600 pixels

A.5.2 Recorder

Method	Thermal dot array
Paper speed	25 mm/s
Number of waveform channels	1

A.5.3 LEDs

Alarm lamp	1 (two color coded: yellow and red)
Power on LED	1 (green)

AC power LED	1 (green)
Battery LED	1 (green)

A.5.4 Audio Indicator

Speaker	Give alarm tones (45 to 85 dB), key tones, pulse tone; power-on self-check tone, support PITCH TONE and multi-level tone modulation; alarm tones comply with IEC 60601-1-8.
---------	---

A.5.5 Monitor Interface Specifications

Power	1 AC power input connector
Wired network	1 RJ45 connector
USB	2 standard connectors, USB 2.0
Equipotential Grounding Terminal	1
Multi-Functions Connector	1 MINI-D RIBBON connector

A.5.6 Outputs

Nurse Call Signal	
Amplitude	High level: >3V, providing a maximum of 3 mA output current Low level: <0.5 V, receiving a maximum of 5 mA input current
Rising and falling time	≤ 1 ms
Alarm output (Network connector)	
Alarm delay time from monitor to remote equipment	The alarm delay time from the monitor to remote equipment is ≤2 seconds, measured at the monitor's signal output connector.

A.5.7 Data Storage

Trends	5000 groups
--------	-------------

A.5.8 Wireless Network

Standards	MSD45N Wireless Module: IEEE 802.11a/b/g/n, support Wi-Fi
-----------	---

A.6 Measurement Specifications

A.6.1 SpO₂

Alarm limit	Range (%)	Step (%)
SpO ₂ High	(low limit + 2) to 100	1
SpO ₂ Low	Mindray, Masimo: Desat to (high limit – 2) Nellcor: Desat or 20 (whichever is greater) to (high limit – 2)	
Desat	0 to (high limit – 2)	

Mindray SpO₂ Module

Standards	Meet standards of ISO 80601-2-61		
*Measurement accuracy verification: The SpO ₂ accuracy has been verified in human experiments by comparing with arterial blood sample reference measured with a CO-oximeter. Pulse oximeter measurements are statistically distributed and about two-thirds of the measurements are expected to come within the specified accuracy range compared to CO-oximeter measurements.			
SpO ₂ Measurement range	0 to 100%		
PI measurement range	0.05% to 20%		
SpO ₂ Resolution	1%		
Accuracy	70 to 100%: ±2% (measured without motion in adult/pediatric mode) 70 to 100%: ±3% (measured without motion in neonate mode) 0% to 69%: Not specified.		
*Studies were performed to validate the accuracy of Pulse Oximeter with neonatal SpO ₂ sensors by contrast with a CO-Oximeter. Some neonates aged from 1 day to 30 days with a gestation age of 22 weeks to full term were involved in this study. The statistical analysis of data of this study shows the accuracy (Arms) is within the stated accuracy specification. Please see the following table.			
Sensor type	Totally neonates	Data	Arms
518B	97 (51 male & 46 female)	200 pairs	2.38%
520N	122 (65 male & 57 female)	200 pairs	2.88%
The Pulse Oximeter with neonatal SpO ₂ sensors was also validated on adult subjects.			
Refreshing rate	1 s		
Response time	≤ 30 s (PI > 0.3, no disturbance, SpO ₂ value sudden change within 70% - 100%)		

Masimo SpO₂ Module

Standards	Meet standards of ISO 80601-2-61
SpO ₂ Measurement range	1 to 100%

PI measurement range	0.02% to 20%
SpO ₂ Resolution	1%
Accuracy ¹	70 to 100%: ±2% (measured without motion in adult/pediatric mode) 70 to 100%: ±3% (measured without motion in neonate mode) 70 to 100%: ±3% (measured with motion) 1% to 69%: Not specified.
Refreshing rate	1 s
Response time	≤ 20 s (PR 75 bpm, average time 8 s, SpO ₂ value rises from 60% to 95%)
SpO ₂ averaging time	2-4 s, 4-6 s, 8 s, 10 s, 12 s, 14 s, 16 s
Low perfusion conditions	Pulse amplitude: >0.02% Light penetration: >5%
Low perfusion SpO ₂ accuracy ²	±2%
<p>¹ The Masimo pulse oximeter with sensors have been validated for no motion accuracy in human blood studies on healthy adult volunteers in induced hypoxia studies in the range of 70% to 100% SpO₂ against a laboratory co-oximeter and ECG monitor. This variation equals plus or minus one standard deviation. Plus or minus one standard deviation encompasses 68% of the population. One percent was added to the accuracies for neonatal sensors to account for accuracy variation due to properties of fetal hemoglobin.</p> <p>The Masimo pulse oximeter with sensors has been validated for motion accuracy in human blood studies on healthy adult volunteers in induced hypoxia studies while performing rubbing and tapping motions at 2 to 4 Hz. At an amplitude of 1 to 2 cm and non-repetitive motion between 1 to 5 Hz. At an amplitude of 2 to 3 cm in induced hypoxia studies in the range of 70% to 100% SpO₂ against a laboratory co-oximeter and ECG monitor. This variation equals plus or minus one standard deviation. Plus or minus one standard deviation encompasses 68% of the population.</p> <p>² The Masimo pulse oximeter has been validated for low perfusion accuracy in bench top testing against a Biotek Index 2 simulator and Masimo's simulator with signal strengths of greater than 0.02% and a % transmission of greater than 5% for saturations ranging from 70 to 100%. This variation equals plus or minus one standard deviation. Plus or minus one standard deviation encompasses 68% of the population.</p>	

Nellcor SpO₂ Module

Standards	Meet standards of ISO 80601-2-61
Measurement range	0 to 100%
Resolution	1%
Accuracy	70 to 100%: ±2% (adult/pediatric) 70 to 100%: ±3% (neonate)

	0% to 69%: Not specified.
Refreshing rate	1 s
Response time	≤ 30 s (PI > 0.3, no disturbance, SpO ₂ value sudden change within 70% - 100%)
* When the SpO ₂ sensor is applied for neonatal patients as indicated, the specified accuracy range is increased by ±1%, to compensate for the theoretical effect on oximeter measurements of fetal hemoglobin in neonatal blood.	

Information of the Test Subjects of the Clinical Study Report

Skin color	Gender	Number	Age (years)	Health
Black	Male	1	28.2±9.19	Healthy
	Female	1		
Yellow	Male	3		
	Female	9		

A.6.2 PR

Module	PR High Limit	PR Low Limit	Step (bpm)
Mindray SpO ₂ Module	(low limit +2) to 254	20 to (high limit-2)	1
Masimo SpO ₂ Module	(low limit +2) to 240	25 to (high limit-2)	
Nellcor SpO ₂ Module	(low limit +2) to 300	20 to (high limit-2)	
NIBP Module	(low limit +2) to 240	40 to (high limit-2)	

PR from Mindray SpO₂ Module

Measurement range	20 to 254 bpm
Resolution	1 bpm
Response time	≤ 30 s (PI > 0.3, no disturbance, PR value sudden change within 25 – 250 bpm)
Accuracy	±3 bpm (without motion)
Refreshing rate	1 s

PR from Masimo SpO₂ Module

Measurement range	25 to 240 bpm
Resolution	1 bpm

Response time	≤ 20 s (PR value sudden change within 25 – 240 bpm)
Accuracy	±3 bpm (without motion) ±5 bpm (with motion)
Refreshing rate	1 s

PR from Nellcor SpO₂ Module

Measurement range	20 to 300 bpm
Resolution	1 bpm
Response time	≤ 30 s (PI > 0.3, no disturbance, PR value sudden change within 25 – 250 bpm)
Accuracy	20 to 250 bpm: ±3 bpm 251 to 300 bpm, not specified
Refreshing rate	1 s

PR from NIBP Module

Measurement range	40 to 240 bpm
Resolution	1 bpm
Accuracy	±3bpm or ±3%, whichever is greater

A.6.3 NIBP

Standards	Meet standards of IEC 80601-2-30, ISO 81060-2			
Technique	Oscillometry			
Mode of operation	Manual, Auto, STAT and Program			
Auto mode repetition intervals	1, 2, 2.5, 3, 5, 10, 15, 20, 30, 60, 90 or 120 min			
STAT mode cycle time	5 min			
Max measurement time	Adult, pediatric:	180 s		
	Neonate:	90 s		
Heart rate range	40 to 240 bpm			
Measurement ranges (mmHg)		Adult	Pediatric	Neonate
	Systolic:	40 to 270	40 to 200	40 to 135
	Diastolic:	10 to 210	10 to 150	10 to 100
	Mean:	20 to 230	20 to 165	20 to 110

Accuracy	Max mean error: ± 5 mmHg Max standard deviation: 8 mmHg	
Static pressure measurement range	0mmHg to 300mmHg	
Static pressure measurement accuracy	± 3 mmHg	
Resolution	1 mmHg	
Initial cuff inflation pressure range (mmHg)	Adult:	80 to 280
	Pediatric:	80 to 210
	Neonate:	60 to 140
Default initial cuff inflation pressure (mmHg)	Adult:	160
	Pediatric:	140
	Neonate:	90
Software overpressure protection	Adult:	297 \pm 3 mmHg
	Pediatric:	240 \pm 3 mmHg
	Neonate:	147 \pm 3 mmHg
Hardware overpressure protection	Adult:	≤ 330 mmHg
	Pediatric:	≤ 330 mmHg
	Neonate:	≤ 165 mmHg
Alarm limit	Range (mmHg)	Step (mmHg)
Sys High	Adult: (low limit+5) to 270 Pediatric: (low limit+5) to 200 Neonate: (low limit+5) to 135	5
Sys Low	40 to (high limit-5)	
Mean High	Adult: (low limit+5) to 230 Pediatric: (low limit+5) to 165 Neonate: (low limit+5) to 110	
Mean Low	20 to (high limit-5)	
Dia High	Adult: (low limit+5) to 210 Pediatric: (low limit+5) to 150 Neonate: (low limit+5) to 100	
Dia Low	10 to (high limit-5)	

* Measurement accuracy verification: In adult and pediatric modes, the blood pressure measurements measured with this device are in compliance with the American National Standard for Electronic or Automated Sphygmomanometers (ANSI/AAMI SP10) in terms of mean error and standard deviation by comparing with intra-arterial or auscultatory measurements (depending on the configuration) in a typical patient population. For auscultatory reference, the 5th Korotkoff sound was used to determine the diastolic

pressure.

In neonatal mode, the blood pressure measurements measured with this device are in compliance with the American National Standard for Electronic or Automated Sphygmomanometers (ANSI/AAMI SP10) in terms of mean error and standard deviation by comparing with intra-arterial measurements (depending on the configuration) in a typical patient population.

A.6.4 Temp

SmarTemp™ Temperature Module

Standards	Meets standards of ISO 80601-2-56	
Technique	Thermal resistance (use thermistor to measure temperature)	
Operating mode	Adjusted mode (predictive mode) Direct mode (monitor mode)	
Measurement range	Monitor mode: 25°C to 44°C (77°F to 111.2°F) Predictive mode: 35°C to 43°C (95°F to 109.4°F)	
Accuracy (Monitor mode)	25°C to 32°C (not include 32°C): ± 0.2°C 32°C to 44°C (include 32°C): ± 0.1°C or 77°F to 89.6°F (not include 89.6°F): ± 0.4°F 89.6°F to 111.2°F (include 89.6°F): ± 0.2°F	
Resolution	± 0.1°C or ± 0.2°F	
Minimum measurement time for accurate readings	Monitor mode: < 60 s Predictive mode: < 20 s (typical test: < 12s)	
Alarm limit	Range	Step
Temp High	(low limit +1)°C to 44°C (low limit +1.8)°F to 111.2°F	0.1°C 0.2°F
Temp Low	25°C to (high limit -1) °C 77°F to (high limit -1.8)°F	

Statistical Results of Clinical Investigation Data

	Clinical BIAS (Δcb)	Limits of Agreement (LA)	Clinical Repeatability (σr)
Oral	0.02	0.33	0.1
Axilla	0.06	0.38	0.13
Rectum	-0.05	0.48	0.14

CO ₂ resolution	1 mmHg	
Sample flow rate	50 ml/min	
Sample flow rate tolerance	15% or 15 ml/min, whichever is greater.	
Start-up time	< 90 s	
Response time	5 s @ 50ml/min	
Rise time	< 200 ms @ 50ml/min	
awRR measurement range	0 to 150 rpm	
awRR measurement precision	<60 bpm: ±1 60 to 150 bpm: ±2	
awRR resolution	1 rpm	
Effect of interference gases on CO₂ measurement		
Gas	Concentration (%)	Quantitative effect*
N ₂ O	≤ 60	±1 mmHg
Hal	≤ 4	
Sev	≤ 5	
Iso	≤ 5	
Enf	≤ 5	
Des	≤ 15	±2 mmHg
<p>*: means an extra error should be added in case of gas interference when CO₂ measurements are performed between 0 to 40mmHg. Inaccuracy specifications are affected by the breath rate and I:E change. The end-tidal gas reading is within specification for breath rate below 15BPM and I:E ratio smaller than 1:1 relative to the gas readings without breath.</p>		
Alarm limit	Range	Step
EtCO ₂ High	(low limit + 2) to 99 mmHg	1 mmHg
EtCO ₂ Low	1 to (high limit - 2) mmHg	
FICO ₂ High	1 to 99 mmHg	
awRR High	Adult, pediatric: (low limit + 2) to 100 rpm Neonate: (low limit + 2) to 150 rpm	1 rpm
awRR Low	0 to (high limit - 2) rpm	

B EMC and Radio Regulatory Compliance

B.1 EMC

The device meets the requirements of IEC 60601-1-2.

NOTE

- **Using accessories, transducers and cables other than those specified may result in increased electromagnetic emission or decreased electromagnetic immunity of the patient monitoring equipment.**
 - **The device or its components should not be used adjacent to or stacked with other equipment. If adjacent or stacked use is necessary, the device or its components should be observed to verify normal operation in the configuration in which it will be used.**
 - **The device needs special precautions regarding EMC and needs to be installed and put into service according to the EMC information provided below.**
 - **Other devices may interfere with this device even though they meet the requirements of CISPR.**
 - **When the inputted signal is below the minimum amplitude provided in technical specifications, erroneous measurements could result.**
 - **Portable and mobile communication equipment may affect the performance of this monitor.**
 - **Other devices that have RF transmitter or source may affect this device (e.g. cell phones, PADS, PCs with wireless function).**
-

Guidance and Declaration - Electromagnetic Emissions		
The device is intended for use in the electromagnetic environment specified below. The customer or the user of the device should assure that it is used in such an environment.		
Emission tests	Compliance	Electromagnetic environment - guidance
Radio frequency (RF) emissions CISPR 11	Group 1	The device uses RF energy only for its internal function. Therefore, its RF emissions are very low and are not likely to cause any interference in nearby electronic equipment.
RF emissions CISPR 11	Class A	The device is suitable for use in all establishments other than domestic and those directly connected to the public low-voltage power supply network that supplies buildings used for domestic purposes
Harmonic emissions IEC61000-3-2	Class A	
Voltage Fluctuations/Flicker Emissions IEC 61000-3-3	Complies	



WARNING

- **This device is intended for use by healthcare professionals only. This equipment/ system may cause radio interference or may disrupt the operation of nearby equipment. It may be necessary to take mitigation measures, such as re-orienting or relocating the [ME EQUIPMENT or ME SYSTEM] or shielding the location.**

If the system is operated within the electromagnetic environment listed in Table **Guidance and Declaration —Electromagnetic Immunity**, the system will remain safe and provide the following essential performance,

- Operating mode
- Accuracy
- Function
- Accessories identification
- Data stored
- Alarm
- Detect for connection

Guidance and Declaration - Electromagnetic Immunity			
The device is intended for use in the electromagnetic environment specified below. The customer or the user of the device should assure that it is used in such an environment.			
Immunity test	IEC60601 test level	Compliance level	Electromagnetic environment - guidance
Electrostatic discharge (ESD) IEC 61000-4-2	±6 kV contact ±8 kV air	±6 kV contact ±8 kV air	Floors should be wood, concrete or ceramic tile. If floors are covered with synthetic material, the relative humidity should be at least 30%.
Electrical fast transient/burst IEC 61000-4-4	±2 kV for power supply lines ±1 kV for input/output lines	±2 kV for power supply lines ±1 kV for input/output lines	Mains power quality should be that of a typical commercial or hospital environment.
Surge IEC 61000-4-5	±1 kV line(s) to line(s) ±2 kV line(s) to earth	±1 kV line(s) to line(s) ±2 kV line(s) to earth	
Voltage dips, short interruptions and voltage variations on power supply input lines IEC 61000-4-11	<5 % U_T (>95 % dip in U_T) for 0.5 cycle 40 % U_T (60 % dip in U_T) for 5 cycles 70 % U_T (30 % dip in U_T) for 25 cycles <5 % U_T (>95 % dip in U_T) for 5 s	<5 % U_T (>95 % dip in U_T) for 0.5 cycle 40 % U_T (60 % dip in U_T) for 5 cycles 70 % U_T (30 % dip in U_T) for 25 cycles <5 % U_T (>95 % dip in U_T) for 5 s	Mains power quality should be that of a typical commercial or hospital environment. If the user of our product requires continued operation during power mains interruptions, it is recommended that our product be powered from an uninterruptible power supply or a battery.
Power frequency (50/60 HZ) magnetic field IEC 61000-4-8	3 A/m	3 A/m	Power frequency magnetic fields should be at levels characteristic of a typical location in a typical commercial or hospital environment.
Note: U_T is the AC mains voltage prior to application of the test level.			

Guidance and Declaration - Electromagnetic Immunity

The device is intended for use in the specified electromagnetic environment. The customer or the user of the device should assure that it is used in such an environment as described below.

Immunity test	IEC60601 test level	Compliance level	Electromagnetic environment - guidance
Conducted RF IEC61000-4-6	3 Vrms 150 kHz to 80 MHz	3Vrms	Portable and mobile RF communications equipment should be used no closer to any part of the system, including cables, than the recommended separation distance calculated from the equation appropriate for the frequency of the transmitter. Recommended separation distances: $d = 1.2\sqrt{P}$
Radiated RF IEC61000-4-3	3V/m 80MHz to 2.5GHz	3V/m	Recommended separation distances: 80 MHz~800 MHz $d = 1.2\sqrt{P}$ 800MHz-2.5GHz $d = 2.3\sqrt{P}$ Where, P is the maximum output power rating of the transmitter in watts (W) according to the transmitter manufacturer and d is the recommended separation distance in meters (m). ^b Field strengths from fixed RF transmitters, as determined by an electromagnetic site survey ^a , should be less than the compliance level in each frequency range ^b . Interference may occur in the vicinity of equipment marked with the following symbol: 

Note 1: At 80 MHz to 800 MHz, the separation distance for the higher frequency range applies.

Note 2: These guidelines may not apply in all situations. Electromagnetic propagation is affected by absorption and reflection from structures, objects and people.

Note 3: The device that intentionally receives RF electromagnetic energy at the **exclusion band** (2395.825MHz-2487.645MHz) is exempt from the ESSENTIAL PERFORMANCE requirements, but remains safe.

^a Field strengths from fixed transmitters, such as base stations for radio (cellular/cordless)

telephones and land mobile radios, amateur radio, AM and FM radio broadcast and TV broadcast cannot be predicted theoretically with accuracy. To assess the electromagnetic environment due to fixed RF transmitters, an electromagnetic site survey should be considered. If the measured field strength in the location in which the [ME EQUIPMENT or ME SYSTEM] is used exceeds the applicable RF compliance level above, the [ME EQUIPMENT or ME SYSTEM] should be observed to verify normal operation. If abnormal performance is observed, additional measures may be necessary, such as re-orienting or relocating the [ME EQUIPMENT or ME SYSTEM].

b Over the frequency range 150 kHz to 80 MHz, field strengths should be less than 3V/m.



WARNING

- **The device is configured with a wireless network connector to receive wireless signal. Other devices may interfere with this device even though they meet the requirements of CISPR.**

Recommended separation distances between portable and mobile RF communications equipment and the device

The device is intended for use in an electromagnetic environment in which radiated RF disturbances are controlled. The customer or the user of the device can help prevent electromagnetic interference by maintaining a minimum distance between portable and mobile RF communications equipment (transmitters) and the device as recommended below, according to the maximum output power of the communications equipment.

Rated maximum output power of transmitter (W)	Separation distance in meters (m) according to frequency of the transmitter		
	150 kHz ~ 80 MHz $d = 1.2\sqrt{P}$	80 MHz ~ 800 MHz $d = 1.2\sqrt{P}$	800 MHz ~ 2.5 GHz $d = 2.3\sqrt{P}$
0.01	0.12	0.12	0.23
0.1	0.38	0.38	0.73
1	1.20	1.20	2.30
10	3.80	3.80	7.30
100	12.00	12.00	23.00

For transmitters rated at a maximum output power not listed above, the recommended separation distance *d* in metres (m) can be estimated using the equation applicable to the frequency of the transmitter, where *P* is the maximum output power rating of the transmitter in watts (W) according to the transmitter manufacturer.

Note 1: At 80 MHz and 800 MHz, the separation distance for the higher frequency range applies.

Note 2: These guidelines may not apply in all situations. Electromagnetic propagation is affected by absorption and reflection from structures, objects and people.

B.2 Radio Regulatory Compliance

RF parameters (For MSD45N Wireless Module)

Item	IEEE 802.11b/g/n	IEEE 802.11a/n
Operating Frequency Band (MHz)	2412~2472	5180~5240 5260~5320 5500~5700
Modulation	802.11b: DSSS (DBPSK/DQPSK/CCK) 802.11g/n: OFDM (BPSK/QPSK/16QAM/64QAM)	OFDM (BPSK/QPSK/16QAM/64QAM)
Transmitter Output Power (dBm)	<20 (Average) <30 (Peak)	<20 (Average) <30 (Peak)



The radio module MSD45N is complied with the essential requirements and other relevant provisions of Directive 1999/5/EC (Radio Equipment and Telecommunications Terminal Equipment Directive).

The device, including the MSD45N wireless module, complies with part 15 of the FCC Rules. Operation is subject to the condition that this device does not cause harmful interference.

Operation of this equipment requires the prior coordination with a frequency coordinator designated by the FCC for the Wireless Medical Telemetry Service.

This device complies with Canadian ICES-001. Cet appareil ISM est conforme a la norme NMB-001 du Canada.

The device, including the MSD45N wireless module, FCC and Industry Canada Radio Compliance: This device complies with Part 15 of the FCC Rules and RSS-210 of Industry Canada. Operation is subject to the following two conditions: (1) this device may not cause harmful interference, and (2) this device must accept any interference received, including interference that may cause undesired operation. Any changes or modifications to this equipment not expressly approved by Mindray may cause harmful radio frequency interference and void your authority to operate this equipment.

The maximum antenna gain permitted complies with the e.i.r.p. limits as stated in RSS-210.

The maximum antenna gain permitted complies with the e.i.r.p. limits specified for

point-to-point operation, as stated in RSS-210.



WARNING

-
- **Keep a distance of at least 20cm away from the monitor when Wi-Fi function is in use.**
-

FOR YOUR NOTES

C Default Configurations

This chapter lists some of the most important factory default settings in configuration management. You cannot change the factory default configuration itself. However, you can make changes to the settings from the factory default configuration and then save the changed configuration as a user configuration.

C.1 Parameter Configuration

C.1.1 NIBP

Name		Default	Saved at Power Failure	Affected by Defaults
Alarm On/Off		On	Yes	Yes
Alarm Priority		Med	Yes	Yes
Interval		Manual	Yes	Yes
Clock		On	Yes	Yes
NIBP End Tone		0	Yes	Yes
Program		Program 1	Yes	Yes
Cuff Press. in VeniPuncture (mmHg)	Adult	80	Yes	Yes
	Pediatric	60		
	Neonate	40		
Initial Pressure	Adult	160	Yes	No
	Pediatric	140		
	Neonate	90		
NIBP-Sys High (mmHg)	Adult	160	Yes	Yes
	Pediatric	120		
	Neonate	90		
NIBP-Sys Low (mmHg)	Adult	90	Yes	Yes
	Pediatric	70		
	Neonate	40		
NIBP-Mean High (mmHg)	Adult	110	Yes	Yes
	Pediatric	90		
	Neonate	70		
NIBP-Mean	Adult	60	Yes	Yes

Name		Default	Saved at Power Failure	Affected by Defaults
Low (mmHg)	Pediatric	50		
	Neonate	25		
NIBP-Dia High (mmHg)	Adult	90	Yes	Yes
	Pediatric	70		
	Neonate	60		
NIBP-Dia Low (mmHg)	Adult	50	Yes	Yes
	Pediatric	40		
	Neonate	20		

C.1.2 SpO₂

Name	Default Config	Saved at Power Failure	Affected by Defaults
Alarm On/Off	On	Yes	Yes
Alarm Priority	Med		
SpO ₂ High	Adult/pediatric:100 Neonate: 95		
SpO ₂ Low	90		
Desat Low	80		
Sat-Seconds (Nellcor)	0s		
NIBP Simultaneous	Off		
Sweep	25 mm/sec		
Beat Volume	2		
SpO ₂ Sensor Off Lev.	Monitor mode: Low Spot Check mode: Off	Yes	No
Sensitivity (Mindray)	Med	Yes	Yes
Sensitivity (Masimo)	Normal		
Averaging (Masimo)	8 s		

C.1.3 PR

Name		Default Config	Saved at Power Failure	Affected by Defaults
Alarm On/Off		On	Yes	Yes
Alarm Priority		Med		
PR High	Adult	120		
	Pediatric	160		
	Neonate	200		
PR Low	Adult	50		
	Pediatric	75		
	Neonate	100		
PR Source		SpO ₂		
Beat Volume		2		

C.1.4 Temp

Configured with SmartTemp™ Module

Name		Default Config	Saved at Power Failure	Affected by Defaults
Alarm On/Off		Off	Yes	Yes
Alarm Priority		Med	Yes	Yes
Temp High		38.0	Yes	Yes
Temp Low		35.0	Yes	Yes
Temp Type		Predictive	No	No
Temp Position	Oral/Axillary probe: Oral for adult and pediatric Axillary for neonate		No	No
	Rectal probe: Rectal			

Configured with Genius™ 2 Module

Name		Default Config	Saved at Power Failure	Affected by Defaults
Temp Position		Ear	Yes	No

Temp unit	°C	Yes	No
-----------	----	-----	----

C.1.5 CO₂

Name	Default Config	Saved at Power Failure	Affected by Defaults
Parameter-RR			
Alarm On/Off	On	Yes	Yes
Alarm Priority	Med		
RR High	30		
RR Low	8		
Parameter-EtCO ₂			
Alarm On/Off	On	Yes	Yes
Alarm Priority	Med		
EtCO ₂ High	50		
EtCO ₂ Low	25		
Parameter-FiO ₂			
Alarm On/Off	On	Yes	Yes
Alarm Priority	Med		
FiCO ₂ High	4		
Apnea Delay	20 s	Yes	Yes
Operating Mode	Measure	Yes	No
BTPS Compensate	Off	Yes	Yes
Scale	50		
Sweep	6.25 mm/s		
Wave Type	Draw		
O ₂ Compensate	21		
N ₂ O Compensate	0		
AA Compensate	0		
Auto Standby	60 min		

C.2 General configuration

C.2.1 Alarm

Name	Default Config	Saved at Power Failure	Affected by Defaults
Latching Alarm	Off	Yes	No
Minimum Alarm Volume	2		
High Alarm Interval (s)	10s		
Med Alarm Interval (s)	20s		
Low Alarm Interval (s)	20s		
Reminder Tone	On		
Alarm Light on Alarm Reset	On		

C.2.2 Review

Name	Default Config	Saved at Power Failure	Affected by Defaults
Spot Check Trends	Name/MRN button	MRN	No
	Option for Name/MRN button	All	
	Filter	All	
Continuous Trends	Name/MRN button	MRN	
	Option for Name/MRN button	Current patient	
	Interval	30s	
Graphic Trends	Zoom	6 h	

C.2.3 Record

Name	Default Config	Saved at Power Failure	Affected by Defaults
SpO ₂ wave	Selected	Yes	No
Manual Inputs	Selected		

C.2.4 Others

Name	Default Config	Saved at Power Failure	Affected by Defaults
Brightness	5	Yes	Yes
Alarm Volume	2		
Key Volume	2		
Display Setup	All Parameters		
Parameter Time Out	15min		
Height	cm	Yes	No
Weight	kg		
Pressure	mmHg		
Temp	°C		
Glucose	mg/dl		
I/O Fluid	ml		
Date	Current date	/	/
Time	Current time	/	/
Date Format	yyyy-mm-dd	Yes	No
Time Format	24h	Yes	No

C.3 User Maintenance Items

Name	Default Config	Saved at Power Failure	Affected by Defaults
Spot Check	Off	Yes	No
SpO ₂ Tone	Mode 1		
Clinician ID Time Out	10 min		
Language	English		
Network Type	LAN		
Select CMS	On		
Clear CMS IP at Startup	Off		
Data Send Method	HL7 Direct Send		

D Alarm Messages

This chapter lists only the most important physiological and technical alarm messages. Some messages appearing on your monitor may not be included. In the “Solution” column, corresponding solutions are given instructing you to troubleshoot problems. If the problem persists, contact your service personnel.

D.1 Physiological Alarm Messages

Alarm Message	Alarm Priority	Cause	Solution
XX Too High	Med*	XX value exceeds the upper alarm limit.	Check the patient's condition and check if the patient category and alarm limit settings are correct.
XX Too Low	Med*	XX value is lower than the lower alarm limit.	
SpO ₂ Desat	High	The SpO ₂ value has fallen below the desaturation alarm limit.	Check the patient's condition and check if the alarm limit settings are correct.
No Pulse	High	The pulse signal was so weak that the monitor cannot perform pulse analysis.	Check the patient's condition, SpO ₂ sensor and measurement site.
Apnea	High	The patient stops breathing, or the respiration signal was so weak that the monitor cannot perform respiration analysis.	Check the patient's condition, module and patient connections.

“*” means the alarm level is user-adjustable.

XX represents a measurement or parameter label, such as NIBP, PR, etc.

D.2 Technical Alarm Messages

D.2.1 NIBP Module Alarm Messages

Alarm Message	Clearable? (Yes/No)	Alarm Level	Cause	Solution
NIBP-Sys Limit Err	No	Low	The alarm limit of the parameter is changed inadvertently.	Contact your service personnel.
NIBP-Dia Limit Err	No	Low		
NIBP-Mean Limit Err	No	Low		

Alarm Message	Clearable? (Yes/No)	Alarm Level	Cause	Solution
NIBP-Sys Over Upper Limit	Yes	Low	The measured pressure is greater than the specified NIBP measurement upper limit.	Check the patient's condition and keep the patient relaxed and still. If the error remains, contact Mindray or your service personnel.
NIBP-Dia Over Upper Limit	Yes	Low		
NIBP-Mean Over Upper Limit	Yes	Low		
NIBP-Sys Over Lower Limit	Yes	Low	The measured pressure is lower than the specified NIBP measurement lower limit.	Check the patient's condition and keep the patient relaxed and still. If the error remains, contact Mindray or your service personnel.
NIBP-Dia Over Lower Limit	Yes	Low		
NIBP-Mean Over Lower Limit	Yes	Low		
NIBP SelfTest Err	Yes	High	SelfTest Failed. The cause may be the transducer or A/D sampling error.	Restart the monitor and retry. If the error remains, contact your service personnel.
NIBP Init Err	Yes	Low	An error occurred to the NIBP module, or there is a problem with the communications between the module and the monitor.	Restart the monitor. If the error remains, contact our service personnel.
NIBP Comm Err	Yes	High	An error occurred to the NIBP module, or there is a problem with the communications between the module and the monitor.	Restart the monitor. If the error remains, contact our service personnel.
NIBP Loose Cuff	Yes	Low	The NIBP cuff is not properly connected, or there is a leak in the airway.	Check the patient's condition and verify patient type. Replace with an appropriate cuff and connect it correctly. If the problem still exists, contact your service personnel.

Alarm Message	Clearable? (Yes/No)	Alarm Level	Cause	Solution
NIBP Air Pressure Err	Yes	Low	An error occurred to the air pressure.	Check the air pressure. Restart the monitor and retry. If the error remains, contact your service personnel.
NIBP Weak Signal	Yes	Low	The patient's pulse is weak or the cuff is loose.	Check the patient's condition and change the cuff application site. If the error persists, replace the cuff.
NIBP Overrange	Yes	Low	The measured NIBP value is not within the specified range.	Contact your service personnel.
NIBP Excessive Motion	Yes	Low	Patient's arm moves too much.	Check the patient's condition and reduce the patient motion.
NIBP Cuff Overpress.	Yes	Low	The NIBP airway may be occluded.	Check the airway and measure again.
NIBP Signal Saturated	Yes	Low	The NIBP signal is saturated.	Check the patient's condition and reduce the patient motion or other sources.
NIBP Air Leak	Yes	Low	The NIBP airway may leak air.	The NIBP cuff is not properly connected, or there is a leak in the airway.
NIBP Equip Err	Yes	High	System error; or pump, A/D sampling or pressure transducer error; or pointer error during software running.	Check the patient's condition and NIBP connections, or replace the cuff.
NIBP Timeout	Yes	Low	Time is out. In Adult/Pediatric mode, the measurement time is over 120 seconds; in neonate mode, the time is over 90 seconds.	

Alarm Message	Clearable? (Yes/No)	Alarm Level	Cause	Solution
NIBP Cuff Type Wrong	Yes	Low	The cuff type applied mismatches the patient category.	Verify the patient category and replace the cuff.
NIBP Illegally Reset	Yes	Low	An illegal reset occurred during NIBP measurement.	Check if the airway is occluded.
VeniPuncture timeout	Yes	Low	System deflates the cuff after a certain time.	/

D.2.2 SpO₂ Alarm Messages

Alarm Message	Clearable? (Yes/No)	Alarm Level	Cause	Solution
SpO ₂ Sensor Off (Mindray, Masimo, Nellcor)	Yes	Low*(Monitor mode) Off*(Spot Check mode)	The SpO ₂ sensor has become detached from the patient or the module, or there is a fault with the SpO ₂ sensor, or an unspecified SpO ₂ sensor has been used.	Check the sensor application site and the sensor type, and make sure if the sensor is damaged. Reconnect the sensor or use a new sensor.
SpO ₂ Sensor Fault (Mindray, Masimo)	No	Low		
SpO ₂ No Sensor (Mindray, Masimo, Nellcor)	Yes	Low		
SpO ₂ Unknown Sensor (Masimo)	No	Low		
SpO ₂ Too Much Light (Mindray, Masimo)	No	Low	There is too much light on the SpO ₂ sensor.	Move the sensor to a place with lower level of ambient light or cover the sensor to minimize the ambient light.
SpO ₂ No Pulse (Mindray, Nellcor)	No	Low	SpO ₂ sensor failed to obtain pulse signal.	Move the sensor to a site with better perfusion.

SpO ₂ Comm Stop (Mindray, Masimo, Nellcor)	No	High	An error occurred to the SpO ₂ module, or there is a problem with the communications between the module and the monitor.	Restart the monitor. If the error remains, contact your service personnel.
SpO ₂ Comm Abnormal (Mindray, Masimo, Nellcor)	Yes	High		
SpO ₂ Init Err	Yes	High		
SpO ₂ Board Fault (Masimo)	No	Low	There is a problem with the SpO ₂ measurement board.	Do not use the module and contact your service personnel.
SpO ₂ Low Signal (Masimo)	No	Low	The SpO ₂ signal is too low or too weak.	Adjust the sensor application site.
SpO ₂ Weak Signal (Nellcor)	No	Low		
SpO ₂ Interference (Masimo)	No	Low	The SpO ₂ signal has been interfered.	Check for any possible sources of signal noise around the sensor and check the patient for great motion.
SpO ₂ Comm Err (Mindray, Masimo, Nellcor)	Yes	High	An error occurred to the SpO ₂ module, or there is a problem with the communications between the module and the monitor.	Restart the monitor. If the error remains, contact our service personnel.
SpO ₂ Limit Err (Mindray, Masimo, Nellcor)	No	Low	The alarm limit of SpO ₂ is changed inadvertently.	Contact your service personnel.
PR Limit Err (Mindray, Masimo, Nellcor)	No	Low	The alarm limit of PR is changed inadvertently.	Contact your service personnel.

PR Overrange (Mindray, Masimo, Nellcor)	No	Low	The measured PR value exceeds the measurement range.	Contact your service personnel.
--	----	-----	--	---------------------------------

“*” means the alarm level is user-adjustable.

D.2.3 Temperature Alarm Messages

Alarm Message	Clearable? (Yes/No)	Alarm Level	Cause	Solution
Temp Init Err	Yes	High	An error occurred to the Temp module, or there is a problem with the communications between the module and the monitor, or Temp calibration error.	Restart the monitor. If the error remains, contact your service personnel.
Temp Comm Err	No	High	An error occurred to the Temp module, or there is a problem with the communications between the module and the monitor.	Restart the monitor. If the error remains, contact our service personnel.
Temp Alarm Limit Err	No	High	The alarm limit of Temp is changed inadvertently.	Contact your service personnel.
Warmup Timed Out	Yes	Med	The initial probe temperature in measurement is too high.	Cool the probe and retry.
Warming Resistor Err	No	Med	The thermal resistor on the temperature probe has an error (Can not work properly).	Replace temperature probe.
Ambient Temp Overrange	Yes	Med	The environmental temperature is out the range of the monitor's measurement.	Change an environment and retry.
Temp Voltage Err	Yes	Med	The voltage is too high or too low.	Check the power supply.

Temp Prediction Err	Yes	Low	The measuring operation is improper.	Retry to measure.
Temp SelfTest Err	No	High	An error occurs during Temp module initialization.	Replace the module.
Temp Over High Limit	No	High	The patient's temperature is too high, or an error occurs.	Reduce the patient's temperature, or replace the module.
Temp Over Low Limit	No	High	The patient's temperature is too low, or an error occurs.	Raise the patient's temperature, or replace the module.
Temp No Probe	Yes	Med	The probe is disconnected.	Reconnect the probe.
Temp Probe Misplaced	Yes	Med	The temperature probe is not well placed, or not inserted into probe well.	1 Check if the probe well is installed. 2 Properly re-insert the probe into probe well.
Temp Measuring Timeout	Yes	Med	The measuring time is over 5 minutes in Monitor mode.	Return the sensor to the probe well, and take a temperature again.

D.2.4 CO₂ Alarm Messages

Alarm Message	Clearable? (Yes/No)	Alarm Level	Cause	Solution
CO ₂ Comm Err	No	High	An error occurred to the CO ₂ module, or there is a problem with the communications between the module and the monitor.	Restart the monitor. If the error remains, contact our service personnel.
CO ₂ Comm Abnormal	No	High		
CO ₂ Comm Stop	No	High		
CO ₂ Init Err	No	High		
CO ₂ SelfTest Err	No	High	An error occurs during CO ₂ module initialization.	Replace the module.

CO ₂ Sensor High Temp	No	Low	Ambient temperature is too high or there is a module failure.	Lower the operating temperature. If the alarm persists, the CO ₂ module may fail. Contact your service personnel.
CO ₂ Zero Failed	No	Low	The zeroing failed.	Check the CO ₂ connections. If the alarm persists, contact your service personnel.
CO ₂ No Filterline	Yes	Low	The sample line is off or disconnected.	Make sure that the sample line is connected.
CO ₂ FilterLine Occluded	No	Low	The airway or water trap is occluded.	Check the airway and remove the occlusion.
XX Overrange	No	Low	The measured parameter or measurement XX value is not within the specified range.	Contact your service personnel.

XX represents a measurement or parameter label.

D.2.5 Recorder Alarm Messages

Alarm Message	Clearable? (Yes/No)	Alarm Level	Cause	Solution
Recorder Init Error	Yes	Low	An error occurred to the module, or there is a problem with the communication between the module and the monitor.	Restart the monitor. If the problem still exists, contact your service personnel.
Recorder selftest Error	Yes	Low		
Recorder Unavailable	Yes	Low		
Recorder Comm Error	Yes	Low		
Recorder Vlt High	No	Low	There is a problem with the system power supply. Restart the monitor.	If the message is prompted for several times, contact your service personnel.
Recorder Vlt Low	No	Low		
Recorder Head Hot	No	Low	The recorder has been working for too long time.	Stop the recording and resume the recording till the recorder's print head cools down.

Alarm Message	Clearable? (Yes/No)	Alarm Level	Cause	Solution
Rec Head Wrong Pos.	Yes	Low	The thermal head of the recorder is in wrong position.	Restore the control lever of the recorder to its previous position.
Recorder out of paper	Yes	Low	The recorder paper is used up.	Replace with a new paper roll.

D.2.6 Power Alarm Messages

Alarm Message	Clearable? (Yes/No)	Alarm Level	Cause	Solution
12V Too High	No	High	There is a problem with the system power supply.	Restart the monitor. If the problem still exists, contact your service personnel.
12V Too Low	No	High		
5V Too High	No	High		
5V Too Low	No	High		
3.3V Too High	No	High		
3.3V Too Low	No	High		
Battery Too Low	No	Med	The battery charge is too low.	Connect the monitor to an AC power source and allow the batteries to charge immediately.
Battery Depleted	No	High	The battery charge is almost depleted.	
Power Board Comm Err	No	High	No data from power module has been received for 5 seconds.	Restart the monitor. If the problem still exists, contact your service personnel.
RT Clock Need Reset	No	Low	Button cell problem	Reset the system time and restart the monitor. If the problem still exists, contact your service personnel.
PWR interrupted. Check meas. State.	Yes	Low	Power supply to the monitor was interrupted.	Check the measurements when the monitor restarts. If the problem still exists, contact your service personnel or Mindray.

D.2.7 System Alarm Messages

Alarm Message	Clearable? (Yes/No)	Alarm Level	Cause	Solution
No CMS	Yes	Low	The monitor is disconnected from the CMS.	Check network connection.

E Electrical Safety Inspection

The following electrical safety tests are recommended as part of a comprehensive preventive maintenance program. They are a proven means of detecting abnormalities that, if undetected, could prove dangerous to either the patient or the operator. Additional tests may be required according to local regulations.

All tests can be performed using commercially available safety analyzer test equipment. These procedures assume the use of a 601PROXL International Safety Analyzer or equivalent safety analyzer. Other popular testers complying with IEC 60601-1 used in Europe such as Fluke, Metron, or Gerb may require modifications to the procedure. Follow the instructions of the analyzer manufacturer.

The electrical safety inspection should be periodically performed every two years. The safety analyzer also proves to be an excellent troubleshooting tool to detect abnormalities of line voltage and grounding, as well as total current loads.

E.1 Power Cord Plug

E.1.1 The Power Plug

Test Item		Acceptance Criteria
The power plug	The power plug pins	No broken or bent pin. No discolored pins.
	The plug body	No physical damage to the plug body.
	The strain relief	No physical damage to the strain relief. No plug warmth for device in use.
	The power plug	No loose connections.
The power cord		No physical damage to the cord. No deterioration to the cord.
		For devices with detachable power cords, inspect the connection at the device.
		For devices with non-detachable power cords, inspect the strain relief at the device.

E.2 Device Enclosure and Accessories

E.2.1 Visual Inspection

Test Item	Acceptance Criteria
The enclosure and accessories	No physical damage to the enclosure and accessories.
	No physical damage to meters, switches, connectors, etc.
	No residue of fluid spillage (e.g., water, coffee, chemicals, etc.).
	No loose or missing parts (e.g., knobs, dials, terminals, etc.).

E.2.2 Contextual Inspection

Test Item	Acceptance Criteria
The enclosure and accessories	No unusual noises (e.g., a rattle inside the case).
	No unusual smells (e.g., burning or smoky smells, particularly from ventilation holes).
	No taped notes that may suggest device deficiencies or operator concerns.

E.3 Device Labeling

Check the labels provided by the manufacturer or the healthcare facility are present and legible.

- Main unit label
- Integrated warning labels

E.4 Protective Earth Resistance

1. Plug the probes of the analyzer into the device's protective earth terminal and protective earth terminal of the AC power cord.
2. Test the earth resistance with a current of 25 A.
3. Verify the resistance is less than limits.

LIMITS

ALL COUNTRIES R = 0.2 Ω Maximum

E.5 Earth Leakage Test

Run an Earth Leakage test on the device being tested before performing any other leakage tests.

The following outlet conditions apply when performing the Earth Leakage test:

- normal polarity (Normal Condition),
- reverse polarity (Normal Condition),
- normal polarity with open neutral (Single Fault Condition),
- reverse polarity with open neutral (Single Fault Condition)

LIMITS

For UL60601-1,

- ◆ 300 μA in Normal Condition
- ◆ 1000 μA in Single Fault Condition

For IEC60601-1,

- ◆ 500 μA in Normal Condition
- ◆ 1000 μA in Single Fault Condition

E.6 Patient Leakage Current

Patient leakage currents are measured between a selected applied part and mains earth. All measurements have a true RMS only

The following outlet conditions apply when performing the Patient Leakage Current test.

- normal polarity (Normal Condition);
- reverse polarity (Normal Condition),
- normal polarity with open neutral (Single Fault Condition);
- reverse polarity with open neutral (Single Fault Condition).
- normal polarity with open earth (Single Fault Condition);
- reverse polarity with open earth (Single Fault Condition).

LIMITS

For CF  applied parts

- ◆ 10 μA in Normal Condition
- ◆ 50 μA in Single Fault Condition

For BF  applied parts

- ◆ 100 μ A in Normal Condition
- ◆ 500 μ A in Single Fault Condition

E.7 Mains on Applied Part Leakage

The Mains on Applied Part test applies a test voltage, which is 110% of the mains voltage, through a limiting resistance, to selected applied part terminals. Current measurements are then taken between the selected applied part and earth. Measurements are taken with the test voltage (110% of mains) to applied parts in the normal and reverse polarity conditions

The following outlet conditions apply when performing the Mains on Applied Part test.

- Normal Polarity;
- Reversed Polarity

LIMITS

- For CF  applied parts: 50 μ A
- For BF  applied parts: 5000 μ A

NOTE

-
- **Make sure the safety analyzer is authorized comply with requirement of IEC 60601-1.**
 - **Follow the instructions of the analyzer manufacturer.**
-

F Symbols and Abbreviations

F.1 Symbols

μA	microampere
μV	microvolt
μs	Microsecond
A	ampere
Ah	ampere hour
bpm	beat per minute
bps	bit per second
$^{\circ}\text{C}$	centigrade
cm	centimeter
dB	decibel
DS	dyne second
$^{\circ}\text{F}$	fahrenheit
g	gram
GHz	gigahertz
h	hour
Hz	hertz
in	inch
k	kilo
kg	kilogram
kPa	kilopascal
L	litre
lb	pound
m	meter
mAh	milliampere hour
Mb	mega byte
mg	milligram
min	minute
ml	milliliter
mm	millimeter

mmHg	millimeters of mercury
ms	millisecond
mV	millivolt
mW	milliwatt
M Ω	megaohm
nm	nanometer
rpm	breaths per minute
s	second
V	volt
VA	volt ampere
Ω	ohm
W	watt
—	minus
-	negative
%	percent
/	per; divide; or
~	to
+	plus
=	equal to
<	less than
>	greater than
\leq	less than or equal to
\geq	greater than or equal to
\pm	plus or minus
\times	multiply
©	copyright

F.2 Abbreviations

AAMI	Association for Advancement of Medical Instrumentation
AC	alternating current
ADT	Admit/Discharge/Transfer
Adu	adult
AVPU	Alert, Reacting to Voice, Reacting to Pain, and Unresponsive
CE	Conformité Européenne
CISPR	International Special Committee on Radio Interference
CMOS	complementary metal oxide semiconductor
CMS	central monitoring system
COPD	Chronic Obstructive Pulmonary Disease
DC	direct current
Dia	diastolic
DPI	dot per inch
EEC	European Economic Community
EMC	electromagnetic compatibility
EMI	electromagnetic interference
EMR	Electronic Medical Record
GCS	Glasgow Coma Scale
ID	identification
IEC	International Electrotechnical Commission
ISO	International organization for standardization
IEEE	Institute of Electrical and Electronic Engineers
IP	internet protocol
IPS	Individual Parameter Score
LED	light emitting diode
MDD	Medical Device Directive
MetHb	methemoglobin
MEWS	Modified Early Warning Score
MRI	magnetic resonance imaging
N/A	not applied
Neo	neonate
NEWS	National Early Warning Score

NIBP	noninvasive blood pressure
NIBP-D	NIBP-diastolic pressure
NIBP-M	NIBP-mean pressure
NIBP-S	NIBP-systolic pressure
P	power
PD	photodetector
Ped	pediatric
Pleth	plethysmogram
PR	pulse rate
RAM	random access memory
ROM	read-only memory
SpO ₂	arterial oxygen saturation from pulse oximetry
TD	temperature difference
TEMP	temperature

