

Vertex Standard

VX-456

UHF CBRS TRANSCEIVER

OPERATING MANUAL

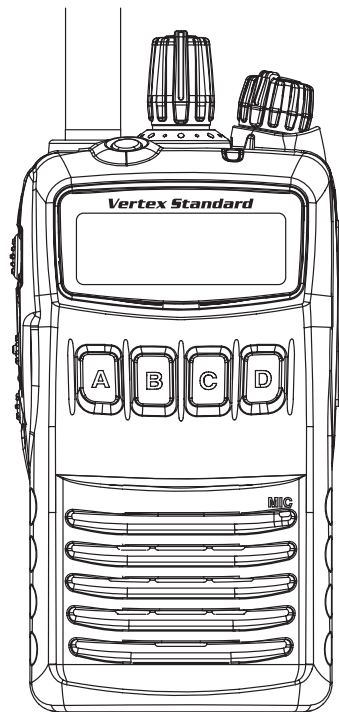

CONTENTS

Introduction.....	1	Operation	14
Important Information Concerning UHF CB Radio.....	2	Preliminary Steps	14
Features.....	4	Operation Quick Start	14
Warning! RF Exposure Requirements.....	6	ARTS™	17
Controls & Connectors.....	8	Advanced Operation.....	18
LCD Icons & Indicators	9	Field Programming Mode	24
Before You Begin	10	User Set Mode.....	25
Battery Pack Installation and Removal	10	Optional Accessories	30
Low Battery Indication	10	Specifications	32
Battery Charging	10	Vertex Standard Products Limited Warranty & Liability.....	36
Belt Clip Installation and Removal.....	12		
MIC/SP CAP Installation	13		

CONGRATULATIONS!

You now have at your fingertips a valuable communications tool—a Vertex Standard two-way radio! Rugged, reliable and easy to use, your Vertex Standard radio will keep you in constant touch with your colleagues for years to come, with negligible maintenance down-time. Please take a few minutes to read this manual carefully. The information presented here will allow you to derive maximum performance from your radio, in case questions arise later on.

We're glad you joined the Vertex Standard team. Call on us anytime, because communications is our business. Let us help you get your message across.

Notice!: There are no owner-serviceable parts inside the radio. All service jobs must be referred to an authorized Vertex Standard Service Representative. Consult your Authorized Vertex Standard Dealer for installation of optional accessories.

INTRODUCTION

The **VX-456** is meet the varied commercial radio needs of Australian industry. The compact case combines die-cast chassis with the clean, tough poly-carbonate resin front panel. Its shockproof versatility will allow you to operate the radio in the toughest environment.

The **VX-456** allows to 80-channel capacity which can be programmed with an 8-character Alpha-Numeric Tag.

Important channel frequency data is stored in EEPROM and flash memory on the CPU, allows the user to change the receiving frequency while the **VX-456** is in the Field programming mode.

The pages which follow will detail the many advanced features provided in the **VX-456** transceiver. After reading this manual, you may wish to consult with your Network Administrator regarding precise details of the configuration of this equipment for use in your application.

IMPORTANT INFORMATION CONCERNING UHF CB RADIO

The use of the Citizen Band Radio Service is licensed in Australia by the ACMA radio communications (Citizens Band Radio Stations) class licence and in New Zealand by the Ministry of Economic Development New Zealand (MED). A General user radio licence for Citizens Band Radio and operation is subject to conditions contained in those licences.

The class licence for users and equipment operating in the CB/PRS 477 MHz band has been amended.

This radio meets the new 80 channel standard.

In simple terms the same amount of spectrum is available; however, radio transceivers can now operate in a narrower bandwidth and hence use less spectrum.

These radios are generally referred to as narrowband or 12.5 kHz radios. By using 12.5 kHz channel spacing instead of 25 kHz, the 40 channels originally allocated can now be expanded to 80 channels thereby doubling the channel capacity and relieving congestion in the UHF CB/PRS band.

Original 40 channel wideband radios will continue to operate on the original 40 channels, however they will not be able to converse on the newer channels 41 - 80.

The newer narrowband radios will be able to converse with all older 40 channel wideband radios on all channels 1 to 40 as well as the newer channels allocated from 41 to 80.

The mixing of narrowband and wideband radios in the same spectrum can cause some possible operating issues of interference and varying levels of received volume.

Possible Issues

When a new narrowband radio receives a transmission from an older wideband radio the speech may sound loud and distorted - simply adjust your radio volume for best performance.

When an older wideband radio receives a signal from a new narrowband radio, the speech may sound quiet - simply adjust your radio volume for best performance.

IMPORTANT INFORMATION CONCERNING UHF CB RADIO

Depending on how close your receiving radio is to another transmitting radio, there can be interference from the transmitting radio if it is using a channel adjacent to the channel you are listening to.

Simply try going up or down a few channels from the currently selected channel.

The above situations are not a fault of the radio but a symptom of operating wideband and narrowband radios in the same bandwidth.

This possible interference will decrease over time as the population of wideband radios ages and decreases.

Further information and updates are available from the Australian communications and media Authority (ACMA) at www.acma.gov.au and the Ministry of Economic Development (MED), radio spectrum management at: www.rsm.govt.nz

Emergency Channels

The ACMA has allocated channels 5/35 for emergency use only. Channel 5 is the primary simplex Emergency channel. Where a channel 5 repeater is available, you should select Duplex on CH 5.

Note: Channel 35 is the input channel for the channel 5 repeater therefore channel 35 should also not be used for anything other than emergency transmissions.

Telemetry Channels

ACMA regulations have allocated channels 22 and 23 for telemetry only applications and have prohibited the transmission of speech on these channels. Consequently your radio has a transmit inhibit applied to channels 22 and 23.

In the event additional telemetry/telecommand channels are approved by the ACMA, these channels shall be added to those currently listed where voice transmission is inhibited. Currently transmissions on channels 61, 62 and 63 are also inhibited and these channels are reserved for future allocation.

FEATURES

Microprocessor Controlled Frequency Synthesiser: Allows user programmable control of scanning, channel memories and selected feature options.

Voice Encryption: The Voice Encryption feature protect the privacy of your communication from other groups.

Programmable Scan Function: Scans the selected UHF CB channels with both Group and Open Scan functions available.

Priority Channel: User programmable Priority Channel feature allows your working channel to be instantly recalled at the press of a programmable key.

High Contrast Liquid Crystal Display: Large LCD (Liquid Crystal Display) provides a visual indication of the selected channel and all selected functions at a glance.

Field Programming Mode: Allows the user to change the receiving frequency and Wide/Narrow receiver filter of the memory channel by the simple operation from the keypad.

User Menu Mode: Allows the user to define or configure various settings of the radio by the simple operation from the keypad.

In-Built CTCSS & DCS: User selectable Continuous Tone Coded Squelch System and Digital Coded Squelch system option provides silent channel operation on individual channels.

TOT (Time Out Timer): This radio has a built-in time-out timer that automatically limits transmissions to a maximum of 3 minutes of continuous operation.

This feature is required by the ACMA to prevent accidental blocking of the frequency should your PTT switch become jammed or be otherwise pressed accidentally. The time-out period can be changed to a shorter time by your dealer.

IP57 Water Resistance: This radio is designed to meet the IP57 Water Resistance specification. The IP57 protected against the effects of immersion in water up to 1 m depth for 30 minutes.

Note: Water resistance of the transceiver (IP57: 1 meter / 30 minutes) is assured only when the following conditions:

- Battery pack is attached to the transceiver;
- Antenna is connected to the antenna jack;
- and MIC/SP cap is installed in the MIC/SP jack.

⚠ WARNING! RF EXPOSURE REQUIREMENTS ⚠

This radio generates RF electromagnetic energy during transmit mode. To ensure that your exposure to RF electromagnetic energy, always adhere to the following guidelines:

- This radio is **NOT** approved for use by the general population in an uncontrolled exposure environment. This radio is restricted to occupational use, work related operations only where the radio operator must have the knowledge to control his or her RF exposure conditions.
- When transmitting, hold the radio in a vertical position with its microphone 2 inches (5 cm) away from your mouth and keep the antenna at least 2 inches (5 cm) away from your head and body.
- The radio must be used with a maximum operating duty cycle not exceeding 50%, in typical Push-to-Talk configurations.
- **DO NOT** transmit for more than 50% of total radio use time (50% duty cycle).
- To keep the Body Worn configuration with the Vertex Standard CLIP-20 belt-clip, reduce the maximum operating duty cycle still more.

The radio is transmitting when the red LED on the top of the radio is illuminated. You can cause the radio to transmit by pressing the P-T-T button.

- When operate the radio with the Vertex Standard CLIP-20 belt-clip, make the transmission time as short as possible, to keep the Body Worn configuration.
- Always use Vertex Standard authorized accessories.

The information listed above provides the user with the information needed to make him or her aware of RF exposure.

 **WARNING! RF EXPOSURE REQUIREMENTS** 

○ **Electromagnetic Interference/Compatibility**

During transmissions, this radio generates RF energy that can possibly cause interference with other devices or systems. To avoid such interference, turn off the radio in areas where signs are posted to do so.

Do not operate the transmitter in areas that are sensitive to electromagnetic radiation such as hospitals, health care facilities, aircraft, and blasting sites.

CONTROL & CONNECTOR

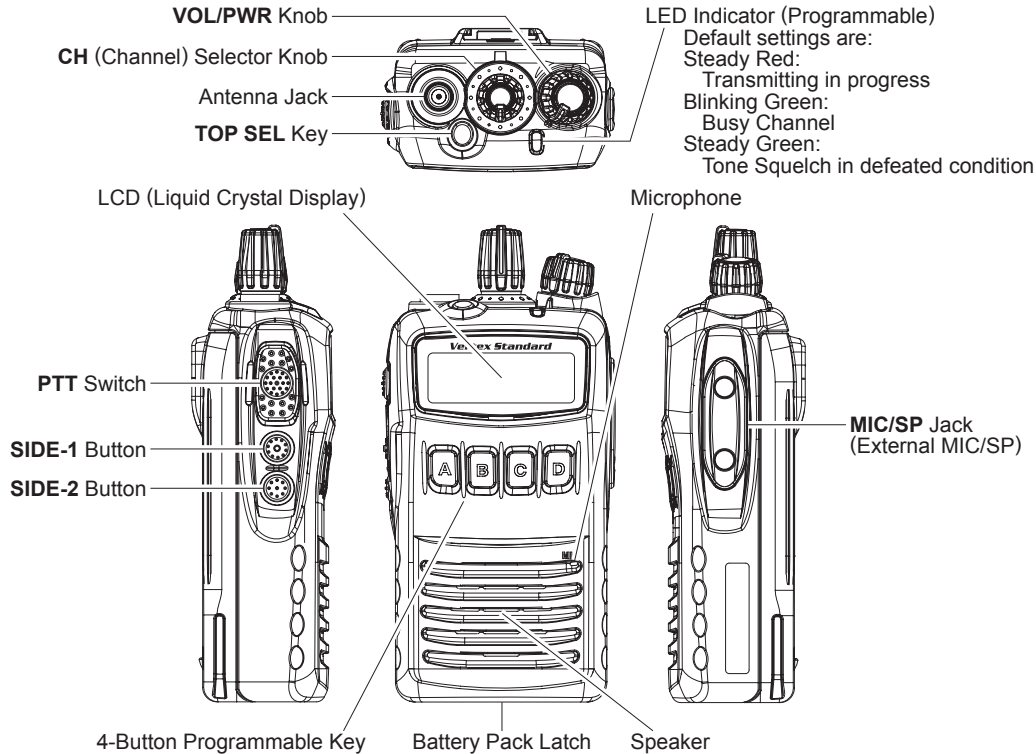

LCD ICONS & INDICATORS

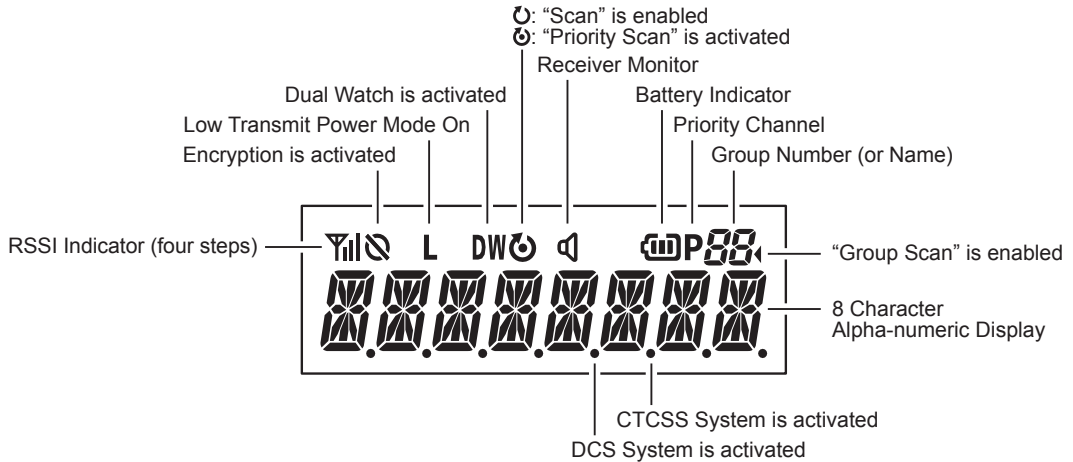

BEFORE YOU BEGIN

Battery Pack Installation and Removal

- ❑ To install the battery pack, align the battery pack to the radio with an offset about 1/2 inch from the top edge of battery compartment, then slide the battery pack upward until it locks in place with a “Click.”

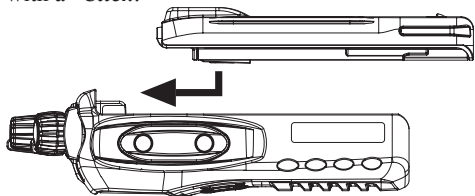

- ❑ To remove the battery, turn the radio off and remove any protective cases. Slide the Battery Pack Latch on the bottom of the radio toward the front panel while sliding the battery down about 1/2 inch. Then lift the battery out from the radio.

 **Do not attempt to open any of the rechargeable Lithium-Ion packs, as they could explode if accidentally short-circuited.**

Low Battery Indication

As the battery discharges during use, the voltage gradually becomes lower. When the battery voltage becomes to low, substitute a freshly charged battery and recharge the depleted pack. The LED indicator on the top of the radio will blink red when the battery voltage is low.

 **CAUTION** 

Danger of explosion if battery is replaced with an incorrect battery. Replace only with the same or equivalent type.

Battery Charging

- ❑ Remove the Spacer Plate from the nest of the optional **CD-58** Desktop Charger, if the Battery Spacer is installed.
- ❑ Insert the DC plug from the optional **PA-55H** AC Adapter into the DC jack on the rear panel of the optional **CD-58** Desktop Charger, and then connect the **PA-55H** AC Adapter to the AC line outlet.
- ❑ Insert the battery pack into the **CD-58** Desktop Charger while aligning the slots of the battery pack with the guides in the nest of the **CD-58**;

BEFORE YOU BEGIN

refer to the following illustration for details on proper positioning of the battery pack. If charging with the transceiver attached, turn the transceiver off. The antenna jack should be at the left side when viewing the charger from the front.

- ❑ If the battery pack is inserted correctly, the LED indicator will glow red. A fully-discharged battery pack will charge completely in approximately 2.5 hours.
- ❑ When charging is completed, the LED indicator will change to green.
- ❑ Disconnect the battery pack from the **CD-58 Desktop Charger** and unplug the **PA-55H AC Adapter** from the AC line outlet.



- 1) Always use the Vertex Standard FNB-V134LI-UNI Lithium-Ion Battery Pack.*
- 2) Battery Pack shall not be exposed to excessive heat such as sunshine, fire, or the like.*
- 3) Risk of explosion if battery is replaced by an incorrect type. Dispose of used batteries according to the instructions*
- 4) Perform the battery charging where the ambient temperature range +5 °C to +35 °C. Charge out of this range could cause damage to the battery pack.*
- 5) Use only the Vertex Standard PA-55H AC Adapter.*

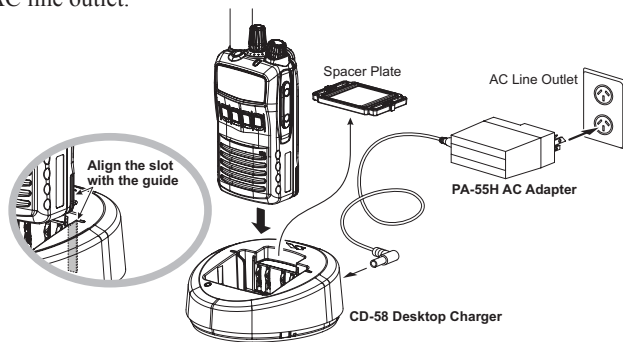

BEFORE YOU BEGIN

Belt Clip Installation and Removal

- ❑ To install the Belt Clip: align the Belt Clip to the groove of the Battery pack, then press the Belt Clip downward until it locks in place with a “Click.”
- ❑ To remove the Belt Clip: use a flat head screw driver to press the Belt Clip Tab away from the battery pack to unlock the Belt Clip, then slide the Belt Clip upward to remove it.

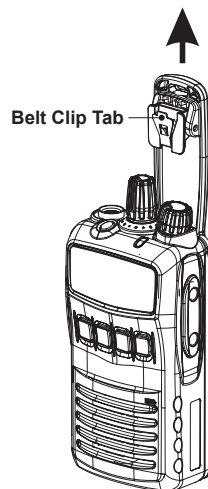
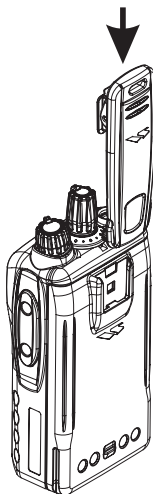

BEFORE YOU BEGIN

MIC/SP CAP Installation

Install the **MIC/SP** cap with the supplied screws.

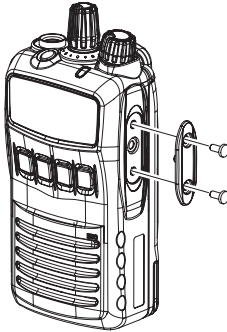

- Use only the supplied screws when install the **MIC/SP** cap.
- This radio does not keep the water resistance (IP57: 1 meter / 30 minutes) when the **MIC/SP** cap is not installed in the **MIC/SP** jack.

OPERATION

Preliminary Steps

- ❑ Install a charged battery pack onto the transceiver, as described previously.
- ❑ Screw the supplied antenna onto the Antenna jack.

Never attempt to operate this transceiver without an antenna connected.

- ❑ If you have a Speaker/Microphone, we recommend that it not be connected until you are familiar with the basic operation of the **VX-456**.

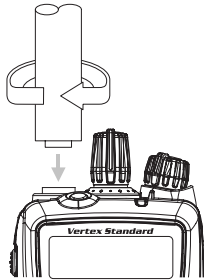

Operation Quick Start

- ❑ Turn the top panel's **VOL/PWR** knob clockwise to turn the radio on.

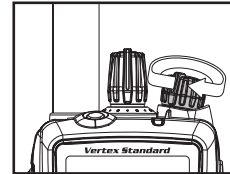

- ❑ Turn the top panel's **CH** selector knob to choose the desired operating channel. The channel number will appear on the LCD.

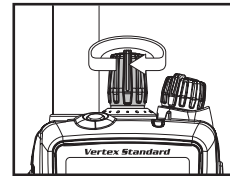

- ❑ If you want to select the operating channel from a different Channel Group, press the [**D**] key repeatedly to select the Channel Group you want before selecting the operating channel. A Group number will appear on the LCD whenever the Programmable key is pressed.

IMPORTANT NOTE

Water resistance of the transceiver (IP57: 1 meter / 30 minutes) is assured only when the following conditions:

- ❑ Battery pack is attached to the transceiver;
- ❑ Antenna is connected to the antenna jack;
- ❑ and **MIC/SP** cap is installed in the **MIC/SP** jack.

OPERATION

- ❑ Rotate the **VOL/PWR** knob to set the volume level. If no signal is present, press and hold in the [**SIDE-1**] button (under the **PTT** switch) more than 2 seconds; background noise will now be heard, and you may use this to set the **VOL/PWR** knob for the desired audio level. Press and hold the [**SIDE-1**] button more than 2 seconds (or press the [**SIDE-1**] button *twice*) to quiet the noise and resume normal (quiet) monitoring.

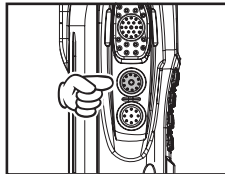
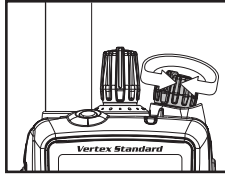

- ❑ When you are in a dark environment, press the (Orange) [**TOP SEL**] key to illuminate the display and ([**A**] to [**D**]) keypad for five seconds.

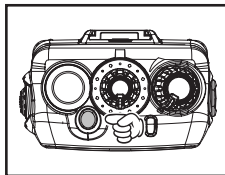

- ❑ To transmit, monitor the channel and make sure it is clear. Press and hold the **PTT** switch. Speak into the microphone area of the front panel grille in a normal voice level. To return to the Receive mode, release the **PTT** switch.

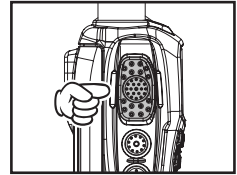

The **VX-456** has a Time-Out Timer which limits the length of each transmission to 3 minutes. It prevent prolonged transmissions.

- ❑ Press (or press and hold) the one of the [**A**], [**B**], [**C**], or [**D**] key to activate the pre-programmed functions. See the next section for details regarding the available features.

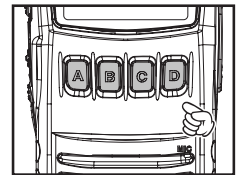

OPERATION

- ❑ If a Speaker/Microphone is available, remove the plastic cap and its two mounting screws from the right side of the transceiver, then align the connector of the Speaker/Microphone on the transceiver body; secure the connector pin using the screws supplied with the Speaker/Microphone. Hold the speaker grille up next to your ear while receiving. To transmit, press the **PTT** switch on the Speaker/Microphone, just as you would on the main transceiver's body, and speak into the microphone on a normal voice level.

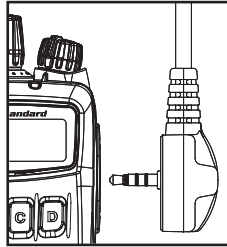

- ❑ If the BCLO (Busy Channel Lockout) feature has been programmed on the channel, the radio will not transmit when a carrier is present. Instead, the radio will generate short beep three times. Release the **PTT** switch and wait for the channel to be clear of activity.
- ❑ If the BTLO (Busy Tone Lockout) feature has been programmed on the channel, the radio can transmit only when there is no carrier being received or when the carrier being received includes the correct tone (CTCSS tone or DCS code) on the channel.

Note 1): Save the original plastic cap and its mounting screws. They should be reinstalled when not using the Speaker/Microphone.

2) When you press the PTT switch on the Speaker/Microphone, it disables the internal microphone, and vice versa.

OPERATION

NOTE

- The selected channel is kept even when the transceiver is turned off.
- The “CH-05” and “CH-35” channels are used for the Emergency, and the 5-Tone Sequential System is not available on these channels. The 5-Tone Sequential System comes to be usable via CE144 Programming Software.
- The “CH-22” and “CH-23” channels are used for telemetry and telecommand applications, so the voice communications are not available on these channels.
- The 5-Tone Sequential System is restricted the transmission for two time in a minute. If you try to transmit over three times, a beeper will sound and does not transmit the 5-Tone Sequential code.
- You may customize the key function of the **VX-456** via the CE144 Programming Software.

ARTSTM

(AUTO RANGE TRANSPOND SYSTEM)

This system is designed to inform you when you and another ARTSTM-equipped station are within communication range.

In a channel enabling the ARTSTM operation, when the radio receives an incoming ARTSTM signal, a short beep will sound, and “**IN SERV**” (“In Service”) will be indicated on the display for 2 seconds. If you move out of range for more than two minutes, your radio senses that no signal has been received; a short triple-beep will sound, and “**OUT SERV**” (“Out of Service”) will be displayed on the display for 2 seconds. If you subsequently move back into communication range, as soon as the other station transmits, a short beep will sound and “**IN SERV**” will be indicated again on the display for 2 seconds.

ADVANCED OPERATION

Programmable Key Functions

The **VX-456** has seven Programmable Keys consisting of **[TOP SEL]**, **[SIDE-1]**, **[SIDE-2]**, **[A]**, **[B]**, **[C]**, **[D]**. Furthermore, each programmable key can be assigned two functions.

The assigned functions are listed below, and their functions are explained beginning after next page.

The Programmable key functions can be customized, via programming by your Vertex Standard dealer if desired, to meet your communications/network requirements.

	PRESS KEY	PRESS & HOLD KEY
[TOP SEL]	Lamp	Set Mode Entry
[SIDE 1]	Monitor	Squelch Off
[SIDE 2]	Low Power	Lock
[A]	Scan	Scan Set
[B]	Scan Mode Select	Priority Channel Set
[C]	CTCSS/DCS Set	---
[D]	Group Up	Encryption

ADVANCED OPERATION

LAMP

(Press the [TOP SEL] key)

Press the [TOP SEL] key to illuminate the display and ([A] to [D]) keypad for five seconds.

SET MODE ENTRY

(Press and hold the [TOP SEL] key)

Press and hold the [TOP SEL] key to enter the User Menu Mode. See page 25 for details of the User Menu Mode.

MONITOR

(Press the [SIDE-1] key)

Press the [SIDE-1] key to disable the Signaling Squelch (CTCSS, DCS, 5-Tone Signaling, or DTMF Pager). Press the [SIDE-1] key again to resume normal (quiet) the Signaling Squelch action.

When the Signaling Squelch is disabled, the “

SQL OFF

(Press and hold the [SIDE-1] key)

Press and hold the [SIDE-1] key to disable both the Noise and Signaling Squelch (CTCSS, DCS, 5-Tone Signaling, or DTMF Pager) systems. Press and hold the [SIDE-1] key again to resume normal (quiet) operation of the Noise and Signaling Squelch system.

When the Signaling Squelch is disabled, the “

LOW POWER

(Press the [SIDE-2] key)

Press the [SIDE-2] key to set the radio's transmitter to the “Low Power” mode, thus extending battery life. Press the [SIDE-2] key again to return to “High Power” operation when in difficult terrain.

When the radio's transmitter is set to “Low Power” mode, the “L” icon will be indicated on the display.

ADVANCED OPERATION

LOCK

(Press and hold the **SIDE-2** key)

Press and hold the [**SIDE-2**] key to lock the **CH** selector knob, Programmable Keys, and **PTT** switch. In the Lock mode, the display will show “-**LOCK**-” when you rotate the **CH** selector knob or touch the Programmable Keys or **PTT** switch (Of course, you may cancel the Lock mode by pressing and holding the [**SIDE-2**] key).

SCAN

(Press the [**A**] key)

The Scanning feature is used to monitor multiple channels programmed into the transceiver. While scanning, the radio will check each channel for the presence of a signal, and will stop on a channel if a signal is present.

- To activate scanning, press the [**A**] key.
The scanner will search the channels, looking for active ones; it will pause each time it finds a channel on which someone is speaking.
- To stop scanning, press the [**A**] key again.
Operation will revert to the channel to which the **CH** selector knob is set.

SCAN SET

(Press and hold the [**A**] key)

Scan Set feature allows the user to arrange a custom scan.

Press and hold the [**A**] key to delete/restore the current channel to/from your scanning list.

- When you delete a stored channel, “**SCN SKIP**” will appear on the display for one second after you press the [**A**] key; the “**U**” icon will, in turn disappear.
- When you restore a channel, “**SCN SET**” will appear on the display for one second after you press the [**A**] key, and the “**U**” icon will now appear.

ADVANCED OPERATION

SCAN MODE SELECT

(Press the **[B]** key)

Press the **[B]** key to select the scan mode. Press the **[B]** key repeatedly to select the desired Scan Mode.

- ❑ **Open Scan** (“**SCMD OPN**” will appear on the display)

The scanner will search the all “flagged” channels, looking for active ones. When receive the signal, the scanner will halt and resume according to the programmed resume time.

When press the **PTT** switch in the Open Scan mode, transmission is inhibited while scanner is activated, or disable the scanner while scanner is paused.

- ❑ **Group Scan** (“**SCMD GRP**” will appear on the display)

The scanner will search the all “flagged” channels and priority channel, looking for active ones. When receive the signal, the scanner will halt and resume according to the programmed resume time.

When press the **PTT** switch in the Group Scan mode, the radio transmit on the Priority Chan-

nel while the scanner is activated, or the radio transmit on the Busy Channel while the scanner is paused.

- ❑ **Priority Scan** (“**SCMD PRI**” will appear on the display)

The scanner will search the all “flagged” channels and priority channel, looking for active ones. When receive the signal, the scanner will halt and resume according to the programmed resume time.

In the Priority Scan mode, press the **PTT** switch to disable the scanner.

PRIORITY CHANNEL SET

(Press and hold the **[B]** key)

Press and hold the **[B]** key to assign/remove the current channel to/from Priority Channel “flag”. The Priority Channel “flag” sets individually to the Group Scan and Priority Scan modes.

When you assign a “flag”, a small “**P**” icon will appear at the upper right corner of the display.

When you remove a “flag”, a small “**P**” will disappear from the display.

ADVANCED OPERATION

CTCSS/DCS SET

(Press the [C] key)

Press the [C] key to enable selection of the CTCSS/DCS system.

The CTCSS/DCS system superimposes a continuous, subaudible tone (for CTCSS system) or digital code (for DCS system) on your transmitted audio. When decoded at the other station, the CTCSS/DCS signal triggers their squelch to open and receive your transmission. To use the CTCSS/DCS system, both stations must be select the same tone or code.

1. Press the [C] key to display the current CTCSS/DCS system.
2. Press the [SIDE-2] key to select the desired CTCSS/DCS mode.
3. Rotate the **CH** selector knob (or press the [A]/[B] key) to select the desired subaudible tone (for CTCSS system) or digital code (for DCS system).

You may cancel the new setting by pressing the [C] key.

4. Press the [D] key to activates the CTCSS/DCS system.

To disable the CTCSS/DCS system, select the “OFF” in step 3 above.

The “decimal point” will be appeared on the display to indicate the CTCSS/DCS system is activated.



DCS System is activated

CTCSS System is activated

Note: The “CH-05” and “CH-35” channels are used for Emergency Channel. The CTCSS/DCS system is not available on these channels.

ADVANCED OPERATION

GROUP UP

(Press the [D] key)

Press the [D] key to switch to a higher Memory Channel Group.

Once the desired Group is reached, rotate the **CH** selector knob to select the desired channel within the selected Group.

ENCRYPTION

(Press and hold the [D] key)

Press and hold the [D] key to toggle the Encryption feature “on” and “off” independently on each channel. The Encryption feature protect the privacy of your communication.

When the Encryption feature is activated, the “

Note: The “CH-05” and “CH-35” channels are used for Emergency Channel. The Encryption feature is not available on these channels.

FIELD PROGRAMMING MODE

The **VX-456**'s Memory Channel allows the user to change the receiving frequency while the **VX-456** is in the Field Programming mode.

1. Turn the radio "off".
2. Press and hold in the (orange) [**TOP SEL**] key while turning the radio on. Release the [**TOP SEL**] key after "**FIELDPRG**" appeared. The radio enters the Field Programming mode.
3. Rotate the **CH** selector knob (or press the [**A**]/[**B**] key) to select the Memory Channel which you wish to change the frequency.
4. Press the [**D**] key briefly. The memory channel number will blink.

If you wish to disable the current channel (leave from Memory Channel list), rotate the **CH** selector knob (or press the [**A**]/[**B**] key) to change the blinking memory channel number to the blinking "**NONEXIST**" notation, then skip to step 8.

Note: The memory channel "1" can not set to "disabled".

5. Press the [**D**] key briefly, then rotate the **CH** selector knob (or press the [**A**]/[**B**] key) to select the desired bandwidth between "**SEP W5**"

(Wide: 25 kHz/step) or "**SEP N2**" (Narrow: 12.5 kHz/step).

6. Press the [**D**] key briefly, and then rotate the **CH** selector knob (or press the [**A**]/[**B**] key) to select the 10 MHz and 1 MHz digits of the receiving frequency.
7. Press the [**D**] key briefly, and then rotate the **CH** selector knob (or press the [**A**]/[**B**] key) to set the 100 kHz and 10 kHz digits of the receiving frequency. The 1 kHz digit and 500 Hz determine in the bandwidth which is set by step 5.
8. Press the [**D**] key to save the new frequency.
9. If you wish to change other memory channel, repeat steps 3 through 8 above.
10. After completing your programming, turn the radio off by rotating the **VOL/PWR** knob counter clockwise to save the new settings.

USER MENU MODE

The **VX-456** includes a User Menu Mode which allows the user to define or configure various settings, such as Beep On/Off, Display Backlight On/Off, Squelch Threshold Level, etc. The possible settings are listed at the right, and their functions are explained beginning after next page. For further details, contact your Vertex Standard Dealer.

To activate the User Menu Mode:

1. Press and hold the [**TOP SEL**] key to enter the User Menu Mode.
2. Press the [**A**] / [**B**] key to select the setting you need to adjust.
3. Use the [**SIDE-1**]/[**SIDE-2**] key to adjust your setting.

You may cancel the selection by pressing the [**C**] key. The display indicates “**-CANCEL-**” briefly, then exits to normal operation.

4. After completing your selection and adjustment, press the [**D**] key to save the new setting and the display indicates “**-SET-**” briefly, then exit to normal operation.

DISPLAY	DESCRIPTION
SQL	Sets the Squelch threshold level.
BEEP	Enables/Disables the keypad beeper.
BELL	Enables/Disables the bell function.
LIGHT	Enables/Disables the LCD Indicator and the display backlight.
KEY	Enables/Disables the Programmable Keys by the Key Lock function.
DIAL	Enables/Disables the CH selector knob by the Key Lock function.
PTT	Enables/Disables the PTT switch by the Key Lock function.
SCAN	Set the SCAN status.
DW	Enables/Disables the Dual Watch feature.
AF	Set the audio volume level.
TXSV	Enables/Disables the Transmit Battery Saver.
ENCR	Enables/Disables the Encryption feature.
L-OUT	Selects the Channel Lock-out feature.
SCN-T	Sets the Scan resume time.
DUTY	Selects the Duty function of the 5-Tone Paging Decoder.
ROGER	Enables/Disables the Roger beeper.

USER MENU MODE

SQL

Function: Sets the Squelch threshold level.

Available Values: -15 to +15

Default: 00

BEEP

Function: Enables/Disables the keypad beeper.

Available Values: ON / OFF

Default: ON

BELL

Function: Enables/Disables Bell function.

Available Values: ON / OFF

Default: ON

When the Bell function is enabled, a “bell” alert sounds when call is coming in, during CTCSS/DCS operation.

LIGHT

Function: Enables/Disables the LCD Indicator and the display backlight.

Available Values: ON / OFF

Default: ON

KEY

Function: Enables/Disables the Programmable Keys ([**TOP SEL**], [**SIDE-1**], [**SIDE-2**], [**A**], [**B**], [**C**], [**D**]) by the Key Lock function.

Available Values: FRE (OFF) / LCK (ON)

Default: LCK (ON)

DIAL

Function: Enables/Disables the **CH** selector knob by the Key Lock function.

Available Values: FRE (OFF) / LCK (ON)

Default: LCK (ON)

PTT

Function: Enables/Disables the **PTT** switch by the Key Lock function.

Available Values: FRE (OFF) / LCK (ON)

Default: LCK (ON)

USER MENU MODE

SCAN

Function: Set the Scan Status.

Available Values: OFF / ON / GRP / FM

Default: OFF

OFF: Stop the Scan

ON: Starts the Scan

GRP: Starts the LMR Group Scan which search all “flagged” channels on the LMR Group.

FM: Start the Follow-Me Scan that search all “flagged” channels and Scan Start channel.

DW

Function: Enables/Disables the Dual Watch feature.

Available Values: ON / OFF

Default: OFF

The Dual Watch feature is similar to the Priority Scan, except that only two channels are monitored: current operating channel and priority channel.

AF

Function: Set the audio volume level.

Available Values: 000 to 255

Default: 000

When set this item, you can not adjust the audio volume level by the **VOL/PWR** knob, and the audio volume level is fixed until turn the radio on next.

TXSV

Function: Enables/Disables the Transmit Battery Saver.

Available Values: ON / OFF

Default: ON

The Transmit Battery Saver helps extend battery life by reducing transmit power when a very strong signal from an apparently nearby station is being received. Under some circumstances, though, your hand-held radio may not be heard well at the other end of the communication path, and high power may be necessary at all times.

USER MENU MODE

ENCR

Function: Enables/Disables the Encryption feature.

Available Values: ON / OFF

Default: OFF

L-OUT

Function: Selects the Channel Lock-out feature.

Available Values:

DEF (Default): Determined in the dealer setting.

OFF: Disable the Lock-out feature.

BC (BCLO): Activates the BCLO (Busy Channel Lock-out) feature.
The radio inhibits transmission while there is a carrier present.

BT (BTLO): Activates the BTLO (Busy Tone Lock-out) feature.
The radio inhibits transmission while there is carrier present only when there is a invalid tone or no tone present.

Default: DEF

SCN-T

Function: Sets the Scan resume time.

Available Values:

DEF (Default): Determined in the dealer setting.

5S (5 sec.): The Scanner will resume after 5 seconds when a signal disappears.

10S (10 sec.): The Scanner will resume after 10 seconds when a signal disappears.

15S (15 sec.): The Scanner will resume after 15 seconds when a signal disappears.

P5 (Pause): The scanner stops for 5 seconds, then the Scanner resume regardless of the signal receiving.

Default: DEF

DUTY

Function: Selects the Duty function of the 5-Tone Paging Decoder.

Available Values:

DEF (Default): Determined in the dealer setting.

ON: You will always hear (depending on the sub-audio signaling) all traffic on the 5-Tone paging channel.

Default: DEF

USER MENU MODE

ROGER

Function: Enables/Disables the Roger beeper which emit the beep when release the **PTT** switch.

Available Values: ON / OFF

Default: OFF

OPTIONAL ACCESSORIES

FNB-V134LI-UNI	7.4V, 2300 mAh Li-Ion Battery Pack
CD-58	Desktop Charger
PA-55H	AC Adapter
MH-360S	Compact Speaker Microphone
MH-450S	Speaker Microphone
MH-45B4B	Noise Cancelling Speaker Microphone
MH-66A4B	Submersible Speaker Microphone
MH-81A4B	Over-the-head VOX Compatible Headset
LCC-450	Leather Case
DVS-8	Voice Storage Unit
DVS-9	Man Down Alert with Digital Voice Storage Unit
CLIP-20	Belt Clip
ATU-16F	Antenna
CN-2A	Antenna Adapter
CSS450	Channel Selector Stopper
CE144	PC Programming Software
FIF-12	USB Programming Interface
CT-106	Connection Cable for FIF-12
CT-27	Radio to Radio Cloning Cable

Availability of accessories may vary; some accessories are supplied standard per local requirements, others may be unavailable in some regions. Check with your Vertex Standard Dealer for changes to this list.

NOTE

SPECIFICATIONS

General

Frequency range:	476.4250 - 477.4125 MHz: UHF CBRS Band 450 - 520 MHz: RX Only
Channel/Group:	80 CH / 2 Group
Power Supply Voltage:	7.4 V DC \pm 10%
Current Consumption:	1.8 A (5 W TX)
Channel Spacing:	12.5 kHz: UHF CBRS Band 12.5 / 25 kHz: RX Only Band
PLL Steps:	5 / 6.25 kHz
Battery Life (5-5-90 duty):	18 hours (w/saver) / 15.6 hours (w/ FNB-V113LI 2300 mAh) 9.2 hours (w/saver) / 8.3 hours (w/ FNB-V112LI 1170 mAh)
IP Rating:	IP57
Operating Temperature Range:	-30 °C to +60 °C
Charging Temperature Range:	0 °C to +45 °C
Frequency Stability:	\pm 2.5ppm
RF Input-Output:	50 Ohms
Dimension (H x W x D):	109 x 58.5 x 34 mm (w/FNB-V112LI) 109 x 58.5 x 43 mm (w/FNB-V113LI)
Weight (Approx.):	296 g (w/FNB-V112LI, Antenna, Belt Clip) 340 g (w/FNB-V113LI, Antenna, Belt Clip)

SPECIFICATIONS

Receiver

Circuit Type:	Double Conversion Super-heterodyne
Sensitivity (12dB SINAD):	0.32 μ V
Adjacent Channel Selectivity:	70/65 dB (W/N)
Hum and Noise:	45/40 dB (W/N)
Intermodulation:	70/65 dB (W/N)
Spurious Image Rejection:	70 dB
Audio output:	700 mW (intemal @ 16 Ohms 5% THD) 500 mW (extemal @ 4 Ohms 5% THD)

Transmitter

Output Power:	5 / 2.5 / 1 / 0.25 W
Modulation:	11K0F3E
Maximum Deviation:	\pm 2.5 kHz
Conducted Spurious Emissions:	70 dB below carrier
FM Hum & Noise:	40 dB
Audio Distortion:	< 3% @ 1kHz

Specifications subject to change without notice or obligation.

SPECIFICATIONS

VX-456 CHANNEL LIST

CHANNEL	FREQUENCY (MHz)		CHANNEL	FREQUENCY (MHz)		CHANNEL	FREQUENCY (MHz)		CHANNEL	FREQUENCY (MHz)	
	RX	TX		RX	TX		RX	TX		RX	TX
CB-01D	476.4250	477.1750	CB-17S	476.8250	---	CB-41D	476.4375	477.1875	CB-57S	476.8375	---
CB-01S	476.4250		CB-18S	476.8500	---	CB-41S	476.4375		CB-58S	476.8625	
CB-02D	476.4500	477.2000	CB-19S	476.8750	---	CB-42D	476.4625	477.2125	CB-59S	476.8875	
CB-02S	476.4500		CB-20S	476.9000	---	CB-42S	476.4625		CB-60S	476.9125	
CB-03D	476.4750	477.2250	CB-21S	476.9250	---	CB-43D	476.4875	477.2375	---	---	
CB-03S	476.4750		CB-22S	476.9500	---	CB-43S	476.4875		---	---	
CB-04D	476.5000	477.2500	CB-23S	476.9750	---	CB-44D	476.5125	477.2625	---	---	
CB-04S	476.5000		CB-24S	477.0000	---	CB-44S	476.5125		CB-64S	477.0125	
CB-05D	476.5250	477.2750	CB-25S	477.0250	---	CB-45D	476.5375	477.2875	CB-65S	477.0375	
CB-05S	476.5250		CB-26S	477.0500	---	CB-45S	476.5375		CB-66S	477.0625	
CB-06D	476.5500	477.3000	CB-27S	477.0750	---	CB-46D	476.5625	477.3125	CB-67S	477.0875	
CB-06S	476.5500		CB-28S	477.1000	---	CB-46S	476.5625		CB-68S	477.1125	
CB-07D	476.5750	477.3250	CB-29S	477.1250	---	CB-47D	476.5875	477.3375	CB-69S	477.1375	
CB-07S	476.5750		CB-30S	477.1500	---	CB-47S	476.5875		CB-70S	477.1625	
CB-08D	476.6000	477.3500	CB-31S	477.1750	---	CB-48D	476.6125	477.3625	CB-71S	477.1875	
CB-08S	476.6000		CB-32S	477.2000	---	CB-48S	476.6125		CB-72S	477.2125	
CB-09S	476.6250		CB-33S	477.2250	---	CB-49S	476.6375		CB-73S	477.2375	
CB-10S	476.6500		CB-34S	477.2500	---	CB-50S	476.6625		CB-74S	477.2625	
CB-11S	476.6750		CB-35S	477.2750	---	CB-51S	476.6875		CB-75S	477.2875	
CB-12S	476.7000		CB-36S	477.3000	---	CB-52S	476.7125		CB-76S	477.3125	
CB-13S	476.7250		CB-37S	477.3250	---	CB-53S	476.7375		CB-77S	477.3375	
CB-14S	476.7500		CB-38S	477.3500	---	CB-54S	476.7625		CB-78S	477.3625	
CB-15S	476.7750		CB-39S	477.3750	---	CB-55S	476.7875		CB-79S	477.3875	
CB-16S	476.8000		CB-40S	477.4000	---	CB-56S	476.8125		CB-80S	477.4125	

SPECIFICATIONS

CTCSS TONE FREQUENCY (Hz)

CT OFF	CT 94.8	CT 136.5	CT 177.3	CT 218.1
CT 67.0	CT 97.4	CT 141.3	CT 179.9	CT 225.7
CT 69.3	CT 100.0	CT 146.2	CT 183.5	CT 229.1
CT 71.9	CT 103.5	CT 151.4	CT 186.2	CT 233.6
CT 74.4	CT 107.2	CT 156.7	CT 189.9	CT 241.8
CT 77.0	CT 110.9	CT 159.8	CT 192.8	CT 250.3
CT 79.7	CT 114.8	CT 162.2	CT 196.6	CT 254.1
CT 82.5	CT 118.8	CT 165.5	CT 199.5	----
CT 85.4	CT 123.0	CT 167.9	CT 203.5	----
CT 88.5	CT 127.3	CT 171.3	CT 206.5	----
CT 91.5	CT 131.8	CT 173.8	CT 210.7	----

DCS CODE

DCS OFF	DCS 131	DCS 251	DCS 411	DCS 546
DCS 023	DCS 132	DCS 252	DCS 412	DCS 565
DCS 025	DCS 134	DCS 255	DCS 413	DCS 606
DCS 026	DCS 143	DCS 261	DCS 423	DCS 612
DCS 031	DCS 145	DCS 263	DCS 431	DCS 624
DCS 032	DCS 152	DCS 265	DCS 432	DCS 627
DCS 036	DCS 155	DCS 266	DCS 435	DCS 631
DCS 043	DCS 156	DCS 271	DCS 445	DCS 632
DCS 047	DCS 162	DCS 274	DCS 446	DCS 654
DCS 051	DCS 165	DCS 306	DCS 452	DCS 662
DCS 053	DCS 172	DCS 311	DCS 454	DCS 664
DCS 054	DCS 174	DCS 315	DCS 455	DCS 703
DCS 065	DCS 205	DCS 325	DCS 462	DCS 712
DCS 071	DCS 212	DCS 331	DCS 464	DCS 723
DCS 072	DCS 223	DCS 332	DCS 465	DCS 731
DCS 073	DCS 225	DCS 343	DCS 466	DCS 732
DCS 074	DCS 226	DCS 346	DCS 503	DCS 734
DCS 114	DCS 243	DCS 351	DCS 506	DCS 743
DCS 115	DCS 244	DCS 356	DCS 516	DCS 754
DCS 116	DCS 245	DCS 364	DCS 523	----
DCS 122	DCS 246	DCS 365	DCS 526	----
DCS 125	DCS 250	DCS 371	DCS 532	----

VERTEX STANDARD PRODUCTS LIMITED WARRANTY & LIABILITY

I. What This Warranty Covers And For How Long:

Motorola Solutions Australia warrants the Vertex Standard TWO-WAY RADIO Products listed below (“Product”) against defects in material and workmanship under normal use and service for a period of time from the date of purchase as scheduled below:

Vertex Standard TWO-WAY RADIO Mobile and Portable Units.....	Three (3) Years
Accessories (including battery, antenna, charger, belt clip etc.).....	One (1) Year

Motorola Solutions Australia, at its option, will at no charge either repair the Product (with new or reconditioned parts), replace it (with a new or reconditioned Product), or refund the purchase price of the Product during the WARRANTY PERIOD provided it is returned in accordance with the terms of this warranty. Replaced parts or boards are warranted for the balance of the original applicable WARRANTY PERIOD. All replaced parts of Product shall become the property of Motorola Solutions Australia. This express limited warranty is extended by Motorola Solutions Australia to the original end user purchaser only and is not assignable or transferable to any other party. This is the complete warranty for the Product manufactured by Motorola Solutions Australia.

Motorola Solutions Australia assumes no obligations or liability for additions or modifications to this warranty unless made in writing and signed by an officer of Motorola Solutions Australia, or made in a separate agreement between Motorola Solutions Australia and the original end user purchaser.

Motorola Solutions Australia does not warrant the installation, maintenance or service of the Product. Motorola Solutions Australia cannot be responsible in any way for any ancillary equipment not furnished by Motorola Solutions Australia which is attached to or used in connection with the Product, or for operation of the Product with any ancillary equipment, and all such equipment is expressly excluded from this warranty. Because each system which may use the Product is unique, Motorola Solutions Australia disclaims liability for range, coverage, or operation of the system as a whole under this warranty.

VERTEX STANDARD PRODUCTS LIMITED WARRANTY & LIABILITY

II. General Provisions:

This warranty sets forth the full extent of Motorola Solutions Australia's responsibilities regarding the Product. Repair, replacement or refund of the purchase price of the Product, at Motorola Solutions Australia's option, is the end user purchaser's sole exclusive remedy.

THIS WARRANTY IS GIVEN IN LIEU OF ALL OTHER EXPRESS WARRANTIES. IMPLIED WARRANTIES, INCLUDING WITHOUT LIMITATION, IMPLIED WARRANTIES OF MERCHANTABILITY AND FITNESS FOR A PARTICULAR PURPOSE, ARE LIMITED TO THE DURATION OF THIS LIMITED WARRANTY. IN NO EVENT SHALL MOTOROLA SOLUTIONS AUSTRALIA BE LIABLE FOR DAMAGES IN EXCESS OF THE PURCHASE PRICE OF THE PRODUCT, FOR ANY LOSS OF USE, LOSS OF TIME, INCONVENIENCE, COMMERCIAL LOSS, LOST PROFITS OR SAVINGS OR OTHER INCIDENTAL, SPECIAL OR CONSEQUENTIAL DAMAGES ARISING OUT OF THE USE OR INABILITY TO USE SUCH PRODUCT, TO THE FULL EXTENT SUCH MAY BE DISCLAIMED BY LAW.

III. What This Warranty Does Not Cover:

- A) Defects or damage resulting from use of the Product in other than its normal and customary manner.
- B) Defects or damage occurring from misuse, abuse, accident, corrosion, fire, liquid intrusion, or neglect.
- C) Defects or damage from improper or unauthorized testing, operation, maintenance, service, repair, installation, alteration, modification, or adjustment.
- D) Breakage or damage to antennas unless caused directly by defects in material or workmanship.
- E) Product that has not been operated in accordance with the procedures described in the operating instructions.
- F) Product that has been subjected to unauthorized modifications, tampering, disassembly, use of non-genuine accessories or batteries or repairs (including the addition to the Product of non-Motorola Solutions Australia supplied equipment if not authorized by Motorola Solutions Australia) which adversely affect performance of the Product or interfere with Motorola Solutions Australia's normal warranty inspection and testing of the Product to verify any warranty claim.
- G) Product which has had the serial number removed or made illegible.
- H) Product that has its seal(s) on non-user serviceable components or modules broken.
- I) Freight costs to the repair depot.
- J) Product that has been subjected to illegal or unauthorized alteration of the software/firmware in the Product.
- K) Scratches or other cosmetic damage to the Product surfaces that does not affect the operation of the Product.

VERTEX STANDARD PRODUCTS LIMITED WARRANTY & LIABILITY

L) Normal and customary wear and tear.

M) Memory modules not programmed by Motorola Solutions Australia's Aftermarket Products Group.

N) Warranty claims not made within the Warranty Period.

IV. Patent And Software Provisions:

Motorola Solutions Australia will have no liability with respect to any claim of patent infringement which is based upon the combination of the Product or parts furnished hereunder with software, apparatus or devices not furnished by Motorola Solutions Australia, nor will Motorola Solutions Australia have any liability for the use of ancillary equipment or software not furnished by Motorola Solutions Australia which is attached to or used in connection with the Product. The foregoing states the entire liability of Motorola Solutions Australia with respect to infringement of patents by the Product or any parts thereof. Laws in Australia and other countries preserve for Motorola Solutions Australia certain exclusive rights for copyrighted Motorola Solutions Australia software such as the exclusive rights to reproduce in copies and distribute copies of such Motorola Solutions Australia software. Motorola Solutions Australia software may be used in only the Product in which the software was originally embodied and such software in such Product may not be replaced, copied, distributed, modified in any way, or used to produce any derivative thereof. No other use including, without limitation, alteration, modification, reproduction, distribution, or reverse engineering of such Product software or exercise of rights in such Product software is permitted. No license is granted by implication, estoppel or otherwise under Motorola Solutions Australia patent rights or copyrights.

V. How To Get Warranty Service:

You must provide proof of purchase (bearing the date of purchase and Product item serial number) in order to receive warranty service and, also, deliver or send the Product item, transportation and insurance prepaid, to an authorized warranty service location. Warranty service will be provided by Motorola Solutions Australia through one of its authorized warranty service locations. If you first contact the company which sold you the Product (e.g., dealer or communication service provider), it can facilitate your obtaining warranty service, repair service and technical support.

VERTEX STANDARD PRODUCTS LIMITED WARRANTY & LIABILITY

VI. For Australia Only:

This warranty is given by Motorola Solutions Australia Pty Limited (ABN 16 004 742 312) of Tally Ho Business Park, 10 Wesley Court, Burwood East, Victoria (“Motorola Solutions Australia”).

Our goods come with guarantees that cannot be excluded under the Australia Consumer Law. You are entitled to a replacement or refund for a major failure and compensation for any other reasonably foreseeable loss or damage. You are also entitled to have the goods repaired or replaced if the goods fail to be of acceptable quality and the failure does not amount to a major failure.

Motorola Solutions Australia’s limited warranty below is in addition to any rights and remedies you may have under the Australian Consumer Law. If you have any queries, please call Motorola Solutions Australia at 1800 356 254. You may also visit our website: <http://www.vertexstandard.com.au>, and http://www.motorola.com/Business/XA-EN/Pages/Contact_Us#support_tab for the most updated warranty terms.

VII. Further Assistance From Motorola Solutions Australia:

You may also contact the Customer Help Desk through the following web address: <http://www.vertexstandard.com.au>.

NOTE



Vertex Standard LMR, Inc.

Printed in China



Copyright 2013
Vertex Standard LMR, Inc.
All rights reserved.

No portion of this manual
may be reproduced
without the permission of
Vertex Standard LMR, Inc.