

WÄRTSILÄ **Engines**

WÄRTSILÄ 34SG
ENGINE TECHNOLOGY

ENERGY
ENVIRONMENT
ECONOMY

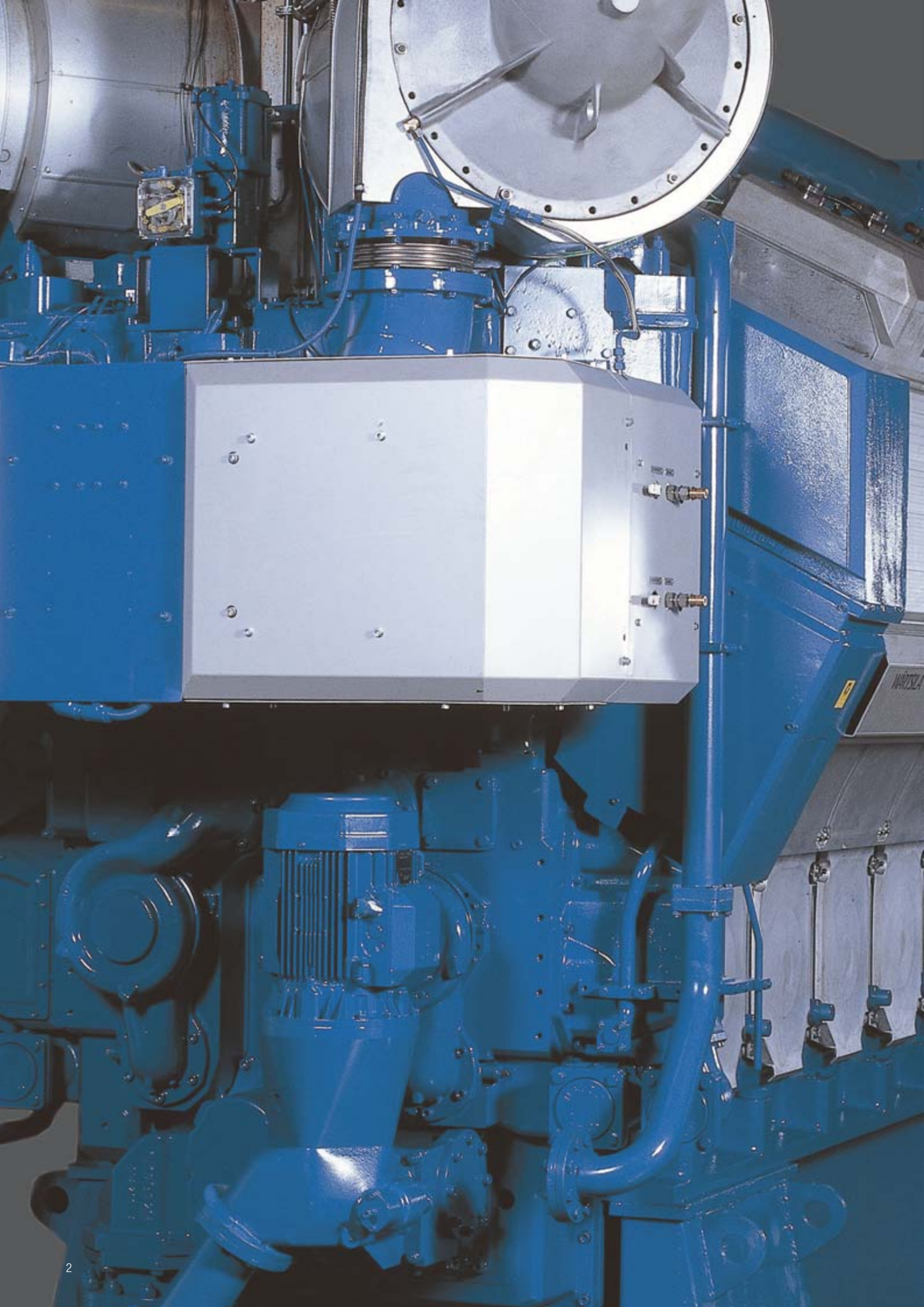





ENGINE TECHNOLOGY

This is a brief guide to the technical features and performance of the Wärtsilä 34SG engine.

DESIGN PHILOSOPHY	4
THE LEAN-BURN CONCEPT	6
LOW EMISSIONS	6
GAS ADMISSION SYSTEM	7
GAS SUPPLY SYSTEM	7
PRECHAMBER	8
IGNITION SYSTEM	8
AIR-FUEL RATIO	8
WASTE GATE	9
STARTING SYSTEM	9
COOLING SYSTEM.....	9
LUBRICATING OIL SYSTEM	9
PISTON.....	10
PISTON RING SET.....	10
CYLINDER HEAD	10
CONNECTING ROD AND BIG-END BEARINGS	10
ENGINE BLOCK	11
CRANKSHAFT AND BEARINGS	11
CYLINDER LINER AND ANTI-POLISHING RING	12
TURBOCHARGING SYSTEM	12
MULTIDUCT.....	12
AUTOMATION SYSTEM.....	12
EASY MAINTENANCE.....	14
MAIN TECHNICAL DATA	15



In 1992, Wärtsilä started the development of lean-burn, spark-ignited Otto gas engines. The first WÄRTSILÄ® 34SG engine was released in 1995 and now the product range of lean-burn gas engines has been expanded by introducing the new Wärtsilä 34SG. These engines take the power output of the Wärtsilä 34SG series up to 9 MW.

The Wärtsilä 34SG is a four-stroke, spark-ignited gas engine that works according to the Otto process and the lean-burn principle. The engine has ported gas admission and a prechamber with a spark plug for ignition.

The engine runs at 720 or 750 rpm for 60 or 50 Hz applications and produces 8700 and 9000 kW of mechanical power, respectively. The efficiency of the Wärtsilä 34SG is the highest of any spark-ignited gas engines today. The natural gas fuelled, lean-burn, medium-speed engine is a reliable, high-efficiency and low-pollution power source for baseload, intermediate peaking and cogeneration plants.

DESIGN PHILOSOPHY

The Wärtsilä 34SG was developed in response to the market need for bigger gas engines. Its design principles are based on the well-proven technology of the Wärtsilä 18V34SG version but with substantial improvements. The Wärtsilä 34SG lean-burn gas engine utilizes the frame of the Wärtsilä 32 diesel/heavy fuel engine with its advanced integrated lube oil and cooling water channels. The bore is 340 mm and it utilizes the power potential of the engine block to the full.

The Wärtsilä 34SG meets current and future requirements for overall cost of ownership. It is designed for flexible manufacturing methods and long maintenance-free operating periods. The engine is fully equipped with all essential ancillaries and a thoroughly planned interface to external systems.

The Wärtsilä 34SG combines high efficiency with low emissions. This is achieved applying state-of-the-art technology with features including:

- use of a lean gas mixture for clean combustion
- individual combustion control and monitoring, providing even load on all cylinders
- stable combustion, ensured by a high-energy ignition system and pre-combustion chamber
- self-learning and self-adjustable functions in the control system
- efficient heat recovery design
- minimal consumables.



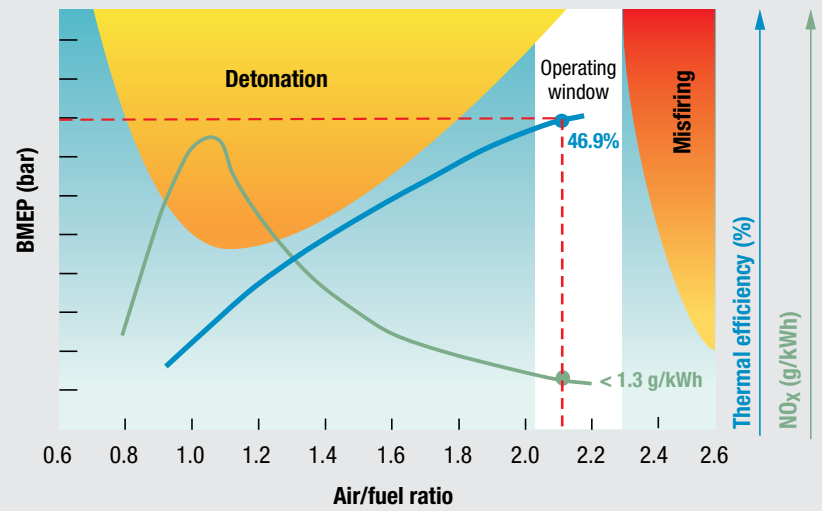

THE LEAN-BURN CONCEPT

In a lean-burn gas engine, the mixture of air and gas in the cylinder is lean, i.e. more air is present in the cylinder than is needed for complete combustion. With leaner combustion, the peak temperature is reduced and less NO_x is produced. Higher output can be reached while avoiding knocking and the efficiency is increased as well, although a too lean mixture will cause misfiring (Fig.1).

Ignition of the lean air-fuel mixture is initiated with a spark plug located in the prechamber (Fig.2), giving a high-energy ignition source for the main fuel charge in the cylinder. To obtain the best efficiency and lowest emissions, every cylinder is individually controlled to ensure operation at the correct air-fuel ratio and with the correct timing of the ignition.

Stable and well-controlled combustion also contributes to less mechanical and thermal load on engine components. The specially developed Engine Control System is designed to control the combustion process in each cylinder, and to keep the engine within the operating window, by optimizing the efficiency and emissions level of each cylinder under all conditions.

LOW EMISSIONS

The main parameters governing the rate of NO_x formation in internal combustion engines are peak temperature and residence time. The temperature is reduced by the combustion chamber air-fuel ratios: the higher the air-fuel ratio the lower the temperature and consequently the lower the NO_x emissions.

In the Wärtsilä 34SG engine, the air-fuel ratio is very high and is uniform throughout the cylinder, due to premixing of the fuel and

air before introduction into the cylinders. Maximum temperatures and subsequent NO_x formation are therefore low, since the same specific heat quantity released by combustion is used to heat up a larger mass of air. Benefiting from this unique feature of the lean-burn principle, the NO_x emissions from the Wärtsilä 34SG are extremely low, and comply with the most stringent existing NO_x legislation.

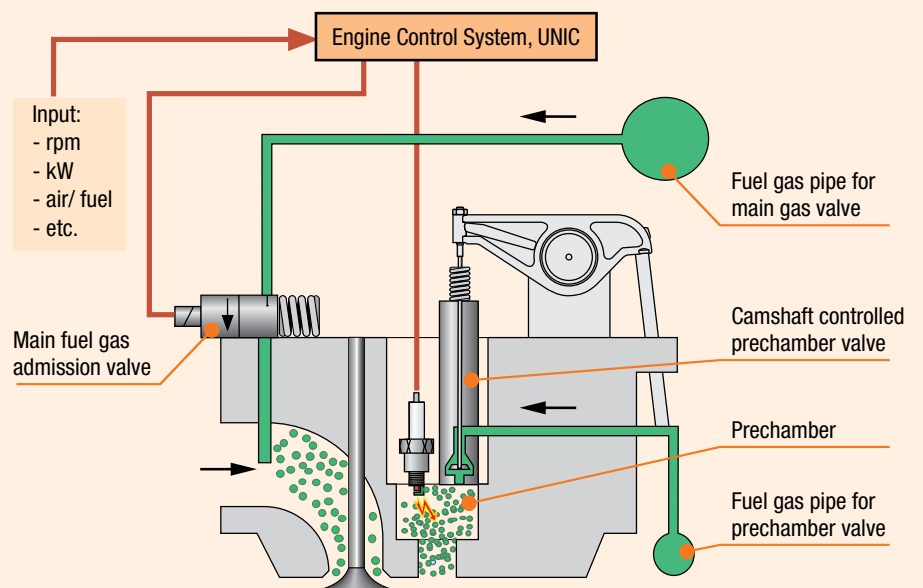

Fig. 2



efficiency at the lowest emission levels. The ported gas admission concept gives:

- high efficiency
- good load response
- lower thermal loading of engine components
- no risk of backfire to the air inlet manifold.

GAS SUPPLY SYSTEM

Before the natural gas is supplied to the engine it passes through a gas-regulating unit, including filter, pressure regulators, shut off valves and ventilating valves. The external pressure regulator regulates the gas pressure to the correct value under different loads; however, the maximum pressure needed is not more than 4.5 bar(a) under full load.

In the engine, the gas is supplied through common pipes running along the engine, continuing with individual feed pipes to each main gas admission valve located on each cylinder head. There are two common pipes per bank, one for the main and one for the prechamber gas supply. A filter is placed before every gas admission valve to prevent particles from entering the valve.

GAS ADMISSION SYSTEM

The Wärtsilä 34SG engine fully controls the combustion process in each cylinder. The “brain” for controlling the combustion process and the whole engine is the Engine Control System.

The gas admission valves located immediately upstream of the inlet valve are electronically actuated and controlled to feed the correct amount of gas to each cylinder.

Since the gas valve is timed independently of the inlet valve, the cylinder can be scavenged without risk of the gas escaping directly from the inlet to the exhaust. Various parameters like engine load, speed and cylinder exhaust temperatures are monitored and work as inputs to the Engine Control System. With this arrangement, each cylinder always works within the operating window for the best

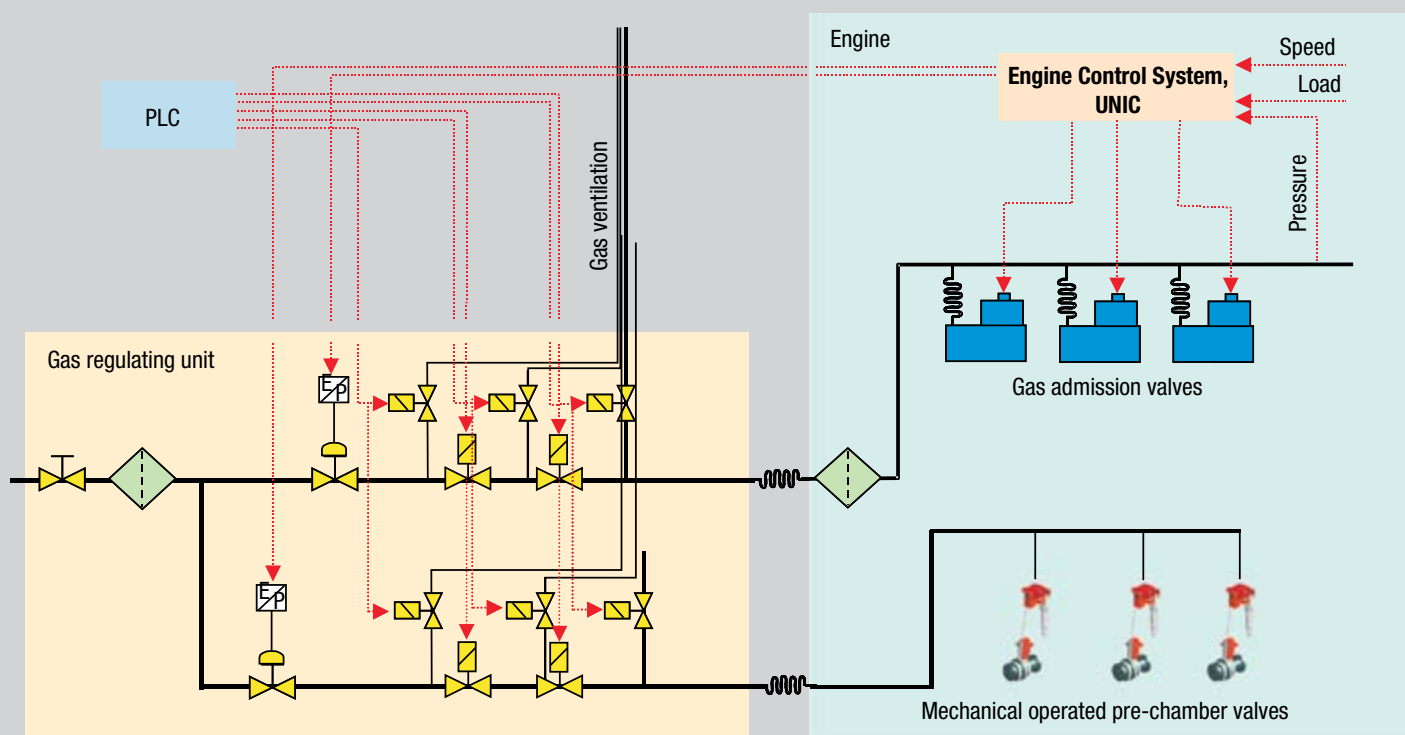

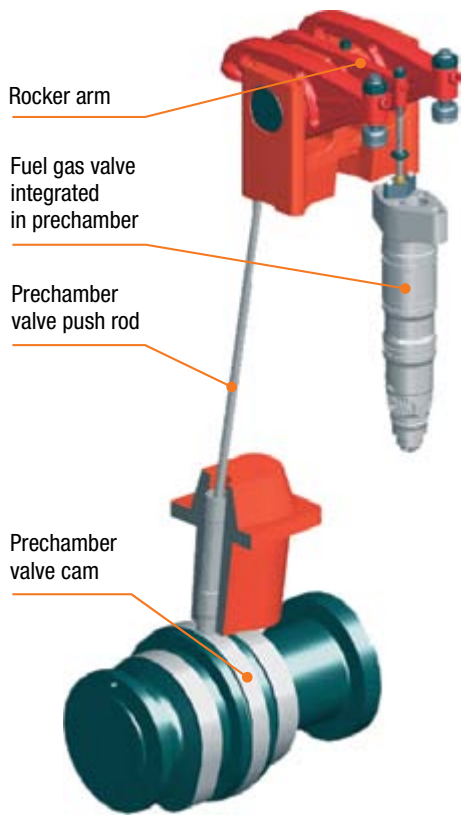

PRECHAMBER

The prechamber is the ignition source for the main fuel charge and is one of the essential components of a lean-burn spark-ignited gas engine.

The prechamber should be as small as possible to give low NO_x values, but big enough to give rapid and reliable combustion. Some of the design parameters considered are:

- shape and size
- mixing of air and fuel
- gas velocities and turbulence at the spark plug
- cooling of the prechamber and the spark plug
- choice of material.

The prechamber of the Wärtsilä 34SG is already optimized at the design stage using advanced three-dimensional, computerized fluid dynamics. In practice, the results can be seen as:

- reliable and powerful ignition
- high combustion efficiency and stability
- extended spark plug life
- very low NO_x levels.

Gas is admitted to the prechamber through a mechanical, camshaft-driven valve. This solution has proved to be extremely reliable and gives an excellent mixture into the prechamber.



Waste gate.

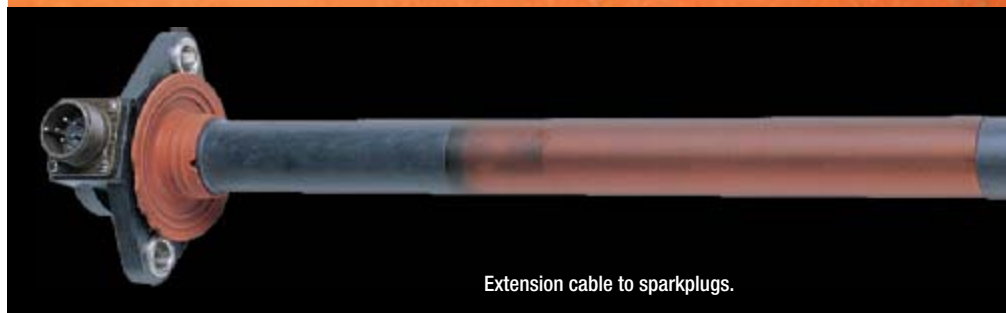

Extension cable to sparkplugs.

IGNITION SYSTEM

The Wärtsilä 34SG ignition system is tailor-made for the engine type and integrated in the Engine Control System. The ignition module communicates with the main control module, which determines the global ignition timing. The ignition module controls the cylinder-specific ignition timing based on the combustion quality. The cylinder-specific control ensures the optimum combustion in every cylinder with respect to reliability and efficiency.

The ignition coil is located in the cylinder cover and is integrated in the spark plug extension. The coil-on-plug design ensures a reliable solution with a minimum of joints between the spark plug and the ignition coil.

The spark plug has been especially developed for long lifetime and to withstand the high cylinder pressure and temperature related to the high engine output.

AIR-FUEL RATIO

To always ensure correct performance of the engine, it is essential to have the correct air-fuel ratio under all types of conditions. The Wärtsilä 34SG uses an exhaust gas wastegate valve to adjust the air-fuel ratio. Part of the exhaust gases bypasses the turbocharger through the waste-gate valve. This valve adjusts the air-fuel ratio to the correct value regardless of varying site conditions under any load.



WASTE GATE

A waste gate is installed next to turbocharger turbine to provide optimal charge air pressure and turbine speed.

STARTING SYSTEM

The Wärtsilä 34SG engine is provided with pneumatic starting valves in the cylinder heads of one bank. The valves are operated by air from a distributor at the end of the camshaft. A starting limiter valve prevents the engine from starting if the turning gear is engaged.

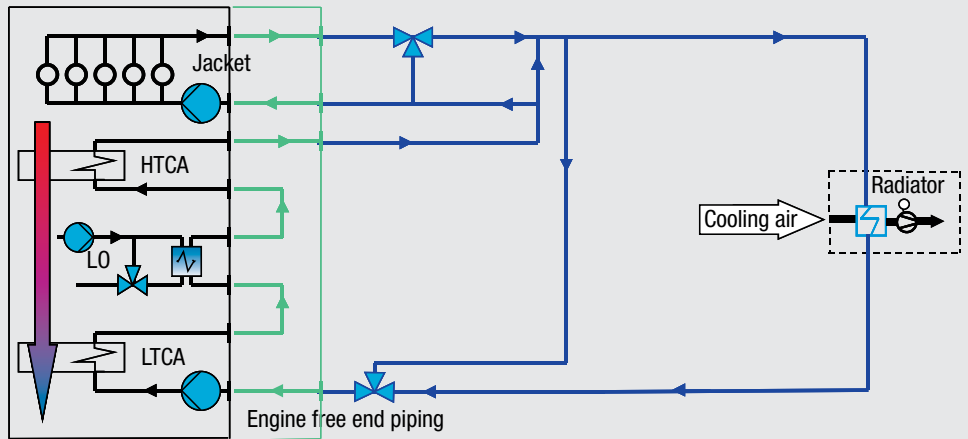

COOLING SYSTEM

The Wärtsilä 34SG engine is designed with a Wärtsilä open-interface cooling system for optimal cooling and heat recovery. The system has four cooling circuits: the cylinder cooling circuit (Jacket), the charge air low-temperature (LTCA) and high-temperature (HTCA) cooling circuits, and the circuit for the lube oil cooler (LO) built on the engine.

The LTCA cooling circuit and Jacket cooling circuit have water pumps integrated in the cover module at the free end of the engine. The LO circuit has its own thermostatic valve built on the engine. The water temperature into the LTCA cooler and the water temperature out from the Jacket cooling circuit are controlled by external thermostatic valves.

The default cooling system is a single-circuit radiator cooling system where the cooling circuits on the engine are connected in series. For heat recovery applications each cooler can be individually connected to an external cooling system. The open interface allows full freedom in cooling and heat recovery system design.

LUBRICATING OIL SYSTEM

The Wärtsilä 34SG is equipped with a wet oil sump, an engine-driven main pump, electrically driven pre-lubricating pump, cooler, full flow filter and centrifugal filter. The pumps, pressure regulation valves and safety valves are integrated into one module fitted at the free end of the engine. Filter, cooler and thermostatic valves make up another module.

The lube oil filtration is based on an automatic back-flushing filter requiring a minimum of maintenance. The filter elements are made of a seamless sleeve fabric with high temperature resistance. A centrifugal filter is mounted in the back-flushing line, acting as an indicator for excessive dirt in the lube oil. The engine uses a pre-lubricating system before starting to avoid wear of engine parts. For running in, provision has been made for mounting special running-in filters in front of each main bearing.

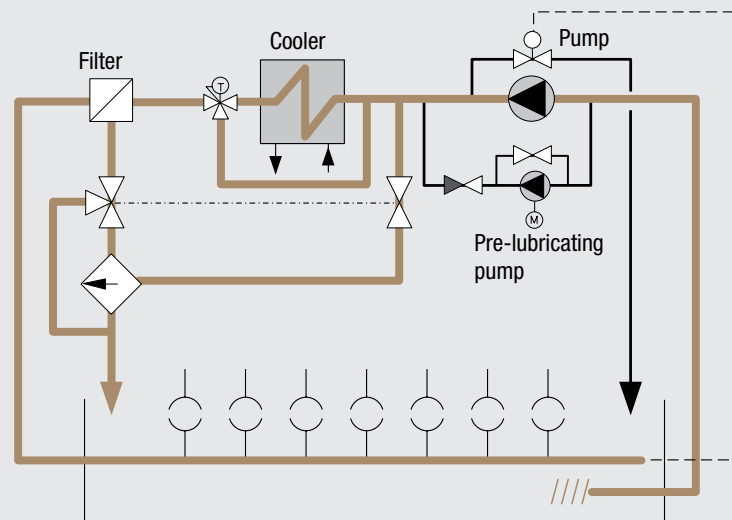



PISTON

Pistons are of the low-friction, composite type with forged steel top and aluminium skirt. The design itself is tailored for an engine of this size and includes a number of innovative approaches. Long lifetime is obtained through the use of Wärtsilä's patented skirt-lubrication system, a piston crown cooled by "cocktail-shaker" cooling, induction hardened piston ring grooves and the low-friction piston ring.

PISTON RING SET

The two compression rings and the oil control ring are located in the piston crown. This three-ring concept has proved its efficiency in all Wärtsilä engines. In a three-pack, every ring is dimensioned and profiled for the task it must perform. Most of the frictional loss in a reciprocating combustion engine originates from the piston rings. A three-ring pack is thus optimal with respect to both function and efficiency.

CYLINDER HEAD

Wärtsilä successfully employs four-screw cylinder head technology. At high cylinder pressure it has proved its superiority, especially when liner roundness and dynamic behaviour are considered. In addition to easier maintenance and reliability, it provides freedom to employ the most efficient air inlet and exhaust outlet channel port configuration.

A distributed water flow pattern is used for proper cooling of the exhaust valves, cylinder head flame plate and the prechamber. This minimizes thermal stress levels and guarantees a sufficiently low exhaust valve temperature. Both inlet and exhaust valves are fitted with

rotators for even thermal and mechanical loading.

CONNECTING ROD AND BIG-END BEARINGS

The connecting rod is designed for optimum bearing performance. It is a three-piece design, in which combustion forces are distributed over a maximum bearing area and relative movements between mating surfaces are minimized. Piston overhaul is possible without touching the big-end bearing and the big-end bearing can be inspected without removing the piston.



The three-piece design also reduces the height required for piston overhauling. The big-end bearing housing is hydraulically tightened, resulting in a distortion-free bore for the corrosion-resistant precision bearing. The three-piece connecting rod design allows variation of the compression ratio to suit gases with different knocking resistance.

ENGINE BLOCK

Nodular cast iron is the natural choice for engine blocks today due to its strength and stiffness properties. The Wärtsilä 34SG makes optimum use of modern foundry technology

to integrate most oil and water channels. The result is a virtually pipe-free engine with a clean outer exterior. The engine has an underslung crankshaft, which imparts very high stiffness to the engine block, providing excellent conditions for main bearing performance. The engine block has large crankcase doors allowing easy maintenance.

CRANKSHAFT AND BEARINGS

The latest advance in combustion development requires a crank gear that can operate reliably at high cylinder pressures. The crankshaft

must be robust and the specific bearing loads maintained at acceptable levels. Careful optimization of crankthrow dimensions and fillets achieve this.

The specific bearing loads are conservative, and the cylinder spacing, which is important for the overall length of the engine, is minimized. In addition to low bearing loads, the other crucial factor for safe bearing operation is oil film thickness. Ample oil film thickness in the main bearings is ensured by optimal balancing of rotational masses and, in the big-end bearing, by ungrooved bearing surfaces in the critical areas.



CYLINDER LINER AND ANTI-POLISHING RING

The cylinder liner and piston designs are based on Wärtsilä's extensive expertise in tribology and wear resistance acquired over many years of pioneering work in heavy-duty diesel engine design. An integral feature is the anti-polishing ring, which reduces lube oil consumption and wear. The bore-cooled collar design of the liner ensures minimum deformation and efficient cooling. Each cylinder liner is equipped with two temperature sensors for continuous monitoring of piston and cylinder liner behaviour.

TURBOCHARGING SYSTEM

Every Wärtsilä 34SG is equipped with the Spex turbocharging system. The system is designed for minimum flow losses on both the exhaust and air sides. The interface between the engine and turbocharger is streamlined to avoid all the adaptation pieces and piping

frequently used in the past. The Wärtsilä 34SG engine uses high-efficiency turbochargers with inboard plain bearings, and the engine lube oil is used for the turbocharger.

MULTIDUCT

The multiduct replaces a number of individual components in traditional engine designs. These include:

- air transfer from the air receiver to the cylinder head
- exhaust transfer to the exhaust system
- cooling water outlet after the cylinder head
- cooling water return channel from the engine
- gas fuel mixing into the combustion air.
- Additional functions are:
- introduction of an initial swirl to the inlet air for optimal part-load combustion
- insulation / cooling of the exhaust transfer duct
- support for the exhaust system and its insulation.

AUTOMATION

All engine functions are controlled by the engine control system, a microprocessor-based distributed control system mounted on the engine. The various electronic modules are dedicated and optimized for certain functions and they communicate with each other via a CAN databus.

The engine control system offers the following advantages:

- Easy maintenance and high reliability due to point-to-point cabling, high quality cables and rugged mounting of engine electronics
- Easy interfacing with external systems via a databus
- Reduced cabling on and around the engine
- High flexibility and easy customizing
- Digitized signals – free from electromagnetic disturbance
- Built-in diagnostics for easy trouble-shooting.

MAIN CONTROL MODULE

The core of the engine control system is the main control module. This is responsible for



ensuring the engine's reliable operation and for keeping the engine at optimum performance in all operating conditions such as varying ambient temperature and gas quality. The main control module reads the information sent by all the other modules. Using this information it adjusts the engine's speed and load control by determining reference values for the main gas admission, air-fuel ratio and ignition timing. The main control module automatically controls the start and stop sequences of the engine and the safety system. The module also communicates with the plant control system (PLC).

CYLINDER CONTROL MODULE

Each cylinder control module monitors and controls three cylinders. The cylinder control module controls the cylinder-specific air-fuel ratio by adjusting the gas admission individually for each cylinder.

The cylinder control module measures the knock intensity, i.e. uncontrolled combustion in the cylinder, information on which is used to adjust the cylinder specific ignition timing and gas admission.



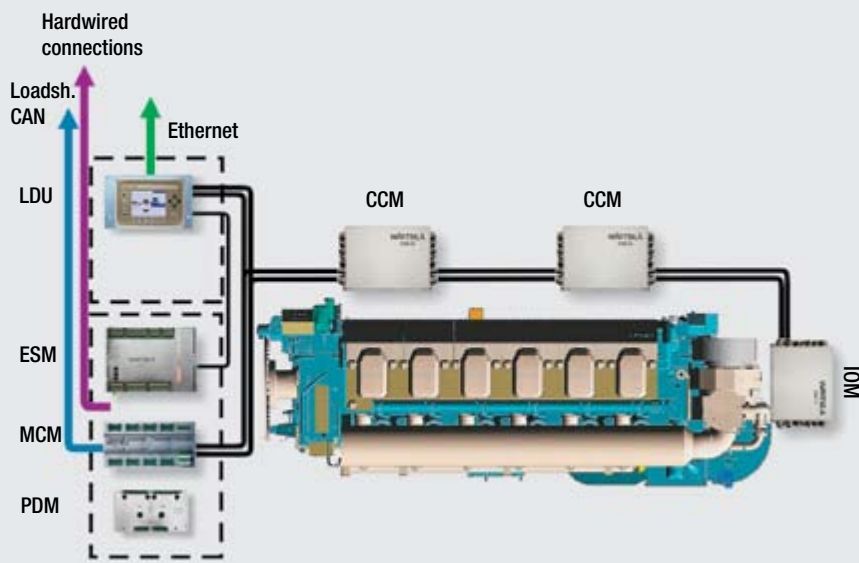

UNIC C3

MONITORING MODULES

Monitoring modules are located close to groups of sensors, which reduces cabling on the engine. The monitored signals are transmitted to the main control module and

used for the engine control and safety system. The monitored values are also transferred to the operator interface on the external control system.

EASY MAINTENANCE

The service life of Wärtsilä 34SG engine components and the time between overhauls are very long due to the purity of the gas. The design incorporates efficient and easy maintenance. In combination with the long intervals between overhauls, the hours spent on maintenance are reduced to a minimum. There is greater accessibility to all the components because the number of pipes is minimized and the components are ergonomically designed.

For ease of maintenance, the engine block has large openings to the crankcase and camshaft. All bolts requiring high tension are hydraulically tightened. Hydraulics is extensively used for many other operations as well. Since the main bearing caps are relatively heavy, each bearing cap is equipped with a permanently fitted hydraulic jack for easy manoeuvring of the cap. During delivery test runs, a running-in filter is installed to prevent the bearings from being scratched by any particles left in the oil system.

- The multiduct arrangement allows the cylinder head to be lifted without having to remove gas pipes or water pipes. The slide-



WÄRTSILÄ 34SG MAIN TECHNICAL DATA

Power production

Cylinder bore	340 mm
Piston stroke	400 mm
Speed	720 / 750 rpm
Mean effective pressure	20.0 / 19.8 bar
Piston speed	9.6 / 10 m/s
Natural gas specification for nominal load	
Lower heating value	≥ 28 MJ/m ³ _N

Technical data 50 Hz/750 rpm	Unit			
Power, electrical	kW	4343	7744	9730
Heat rate	kJ/kWh	7843	7819	7779
Electrical efficiency	%	45.9	46.0	46.3

Technical data 60 Hz/720 rpm	Unit			
Power, electrical	kW	4169	7434	9341
Heat rate	kJ/kWh	7843	7819	7779
Electrical efficiency	%	45.9	46.0	46.3

Dimensions and dry weight of generating set				
Length	mm	10400	11300	12890
Width	mm	2780	3300	3300
Height	mm	3840	4240	4440
Weight	tonne	77	120	130

Heat rate and electrical efficiency at generator terminals, including engine driven pumps, ISO 3046 conditions and gas LHV > 28 MJ/m³_N. Tolerance 5%. Power factor 0.8. Gas Methane Number > 80. Nm³ defined at NTP (273.15 K and 101.3 kPa).

in connections allow lifting of the cylinder head without the need to remove oil or air pipes.

- The water pumps are easy to replace thanks to the cassette design principle and water channel arrangement in the pump cover at the free end of the engine.
- A rigid and tight but easily removable insulating box surrounds the exhaust system.
- Easy access to the piping system is obtained by removing the insulating panels.
- The camshaft is built of identical cylinder segments bolted to intermediate bearing pieces.
- A wide range of special tools and measuring equipment specifically designed to facilitate service work are also available.
- Access to and maintenance of the spark plug and prechamber gas valve in the prechamber is easy. The prechamber does not need to be removed. For spark plug replacement, the valve cover does not need to be removed.
- Use of electrically controlled gas admission valves means few mechanical parts and less need for periodic adjustments.
- The three-piece connecting rod allows inspection of the big-end bearing without removal of the piston, and piston overhaul without dismantling the big-end bearing.

Mechanical drive

Cylinder bore	340 mm
Piston stroke	400 mm
Speed	720 / 750 rpm
Mean effective pressure	20.0 / 19.8 bar
Piston speed	9.6 / 10 m/s
Natural gas specification for nominal load	
Lower heating value	≥ 28 MJ/m ³ _N

Technical data	750 rpm			
Shaft power	kW	4050	7200	9000
Shaft power	hp	5431	9655	12069
Heat rate	kJ/kWh	7724	7724	7724
Shaft efficiency	%	46.6	46.6	46.6

Dimensions and dry weight				
Length	mm	6844	7803	8925
Width	mm	2366	3619	3670
Height	mm	3437	4100	4404
Weight	tonne	46.1	70.8	78.3

Heat rate and efficiency at shaft, including engine driven pumps, ISO 3046 conditions and gas LHV > 28 MJ/m³_N. Tolerance 5%. Gas Methane Number > 80. Nm³ defined at NTP (273.15 K and 101.3 kPa).

Wärtsilä is a global leader in complete lifecycle power solutions for the marine and energy markets. By emphasising technological innovation and total efficiency, Wärtsilä maximises the environmental and economic performance of the vessels and power plants of its customers. Wärtsilä is listed on the NASDAQ OMX Helsinki, Finland.

WÄRTSILÄ® is a registered trademark. Copyright © 2011 Wärtsilä Corporation.

ENERGY
ENVIRONMENT
ECONOMY

WARTSILA.COM

