

**WADE  
 SPECIFICATION DRAINAGE PRODUCTS**

**310 CLOSET CARRIERS  
 WATER CLOSET CARRIER  
 ASSEMBLIES**

Consists of carrier fitting and faceplate assembly with neoprene gasket, 11-in. plastic coupling/test cap and hardware

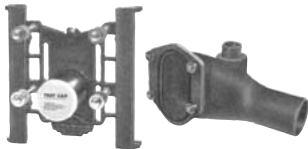

**310-NL ASSEMBLIES**

Used when horizontal waste is above the floor



**330-NL ASSEMBLIES**

Used when single fixtures on common stack or in battery installations when horizontal waste is below the floor



**340-NL ASSEMBLIES**

Used with 310 series when horizontal waste is above floor and fixture may be placed on vertical stack.



**340-ANL ASSEMBLIES**

Used with 310 series when horizontal waste is above floor and on both sides of vertical stack.

**350/370 CLOSET  
 CARRIERS  
 VERTICAL WATER CLOSET  
 CARRIER ASSEMBLIES**

Complete; body, faceplate and hardware

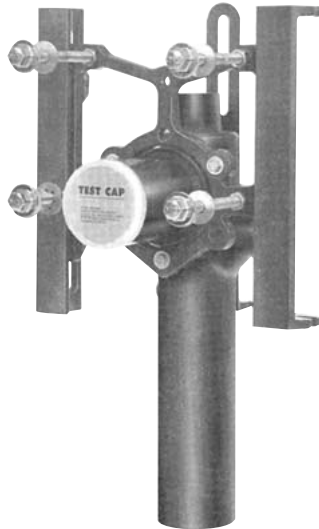

**350 Series  
 350-N2**



**370 Series (Old 360 Series)  
 371-R**

**380 RESIDENTIAL CLOSET  
 CARRIERS**

For wood construction, with adapter for PVC piping.

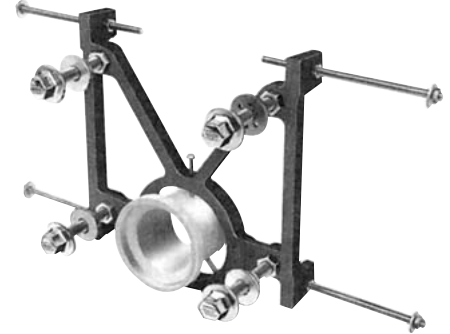

**380**

**410 WALL CARRIER  
 ASSEMBLIES**

Closet carrier with adjustable coupling and 4" waste connection.



**410  
 Siphon Jet Position**

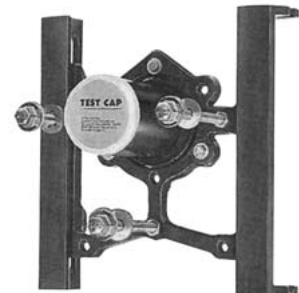

**410  
 Blow Out Position**

**WADE**  
**SPECIFICATION DRAINAGE PRODUCTS**

**400, 420, 440**  
**COMPLETE ASSEMBLIES**



**400, 420 Wall Carriers**

**400**  
Universal hanger plate carrier for urinals, lavatories, drinking fountains and water coolers.

**420**  
Hanger plate carrier, drilled per order, for fixtures the 400 universal carrier will not accommodate.



**440 Fixture Carriers**

**440**  
Carrier with three uprights, support studs for wall 6" thick and hanger plates for bi-level drinking fountains.

**461, 462, 471, 472**  
**COMPLETE ASSEMBLIES**

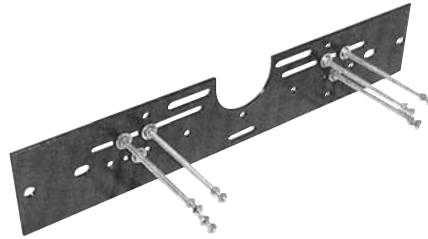

**461, 471**

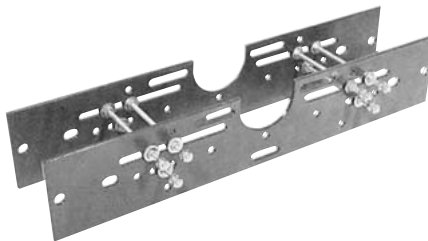

**462, 472**

**Universal Plate Carrier for Lavs, Urinals and Drinking Fountains**—Wall supported for wall 5" thick.

**Note:** 1-plate carriers use hanger furnished with fixture.

**640 ASSEMBLY LESS BODY**  
Service sink carrier with 4" coupling and uprights.



**640 M36**

**510, 510 COMPLETE**  
**ASSEMBLIES**



**510**

Single lavatory carrier with white A.R.E. cast iron exposed arms.



**520, 07**

Single concealed arm lavatory carrier with non-slip locking devices. For lavatories with back for wall up to 6" thick.

**WADE**  
**SPECIFICATION DRAINAGE PRODUCTS**

**1100 Series WITH ADJUSTABLE STRAINERS**

Cast iron or galvanized floor drain with flange, integral reversible clamping collar, seepage openings and nickel bronze or ductile iron strainer. Bottom outlets in push-on (TY), spigot (NH) or inside caulk (IC).

**Note: Primer tap (1/2") furnished standard on all bodies.**



**1100TY, STD5**



**1100TY, AX6**



**1100NH, D6**



**1100NH, F6**



**1100NH, G6**



**1100NH, H4X12**



**1100NH, DT7**



**1100NH, ER7**



**1100NH, K6**

**WADE**  
**SPECIFICATION DRAINAGE PRODUCTS**

**1120 SERIES with INTEGRAL TRAP**

Cast iron or galvanized floor drain with integral trap, spigot (NH) side outlet, integral reversible clamping collar, seepage openings and nickel bronze strainer.

**NOTE: Primer Tap (1/2") Furnished Standard.**

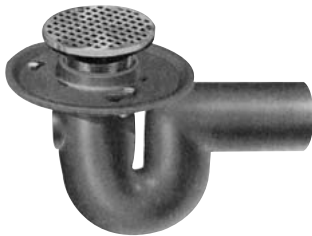

**1120NH, STD5**

**1120CO SERIES with INTEGRAL TRAP AND CLEANOUT**

Cast iron or galvanized floor drain with integral trap, spigot (NH) side outlet, floor-level cleanout, integral reversible clamping collar, seepage openings and nickel bronze strainer.

**NOTE: Primer Tap (1/2") Furnished Standard.**



**1120CO, NH, STD5**

**1200 SHALLOW DRAIN with 12" TOP**

Cast Iron Body with Ductile Iron or Galvanized Loose Set Tractor Grate.

**Primer Tap 1/2"-in standard.**



**1200TY**

**1300TD SERIES with 9" TOP**

**(Grate Supported by Bucket) Primer Tap 1/2-in standard.**



**1300TD, TY**

**1310 SERIES with 9" TOP**

**(With flange and loose-set grate)** Cast iron floor drain assembly with integral clamping collar and seepage openings, loose-set ductile iron, galvanized or nickel bronze grate with bottom outlets in (TY) TY-SEAL, (NH) Spigot or (IC) Inside Caulk.

**Primer tap 1/2-in standard.**



**1310, TY**

**1200 DEEP SUMP DRAIN with 12" TOP**

Cast Iron Body with Ductile Iron or Galvanized Loose Set Tractor Grate.

**Primer Tap 1/2"-in standard.**



**1210TY**

**1370 SERIES with 9" TOP AND 6' CLEANOUT**

Cast iron floor drain assembly with integral p-trap, spigot (NH) side outlet, flange, integral clamping collar, seepage openings, floor-level cleanout and loose-set tractor grate.

**Primer Tap 1/2-in standard.**



**1370**

**1300SS STAINLESS STEEL with 9" TOP**

300 Series stainless steel body with secured grate. Bottom outlets are butt-weld (BW), inside caulk (IC), threaded (IPS) and spigot (NH)



**1300SS**

**1640 SERIES with 9" TOP**

Medium duty floor drain with ductile iron top with bottom outlets in TY-SEAL and NH.



**1640**

**WADE  
 SPECIFICATION DRAINAGE PRODUCTS**

**1760**

Cast iron rectangular floor drain with flange, push-on (TY) outlet and nickel bronze top.



**1760**

**1790 FLOOR/SHOWER**

90° threaded side outlet cast iron drain with integral clamping collar, 1-in. grate ledge and secured nickel bronze angle grate.



**1790**

**2300 SERIES FLOOR DRAINS  
 with 12" X 12" TOP**

Cast iron or Galvanized shallow floor drain with flange, integral clamping collar and square loose-set or hinged ductile iron grate or Nickel Bronze veneer.

**Primer tap 1/2"-in standard.**



**2300**

**2350 DEEP SUMP with  
 9" X 9" TOP**

with cast iron or galvanized body, flashing flange and square loose-set grate of ductile iron or secured nickel bronze veneer; push-on (TY), spigot (NH) or inside caulk (IC) outlets.

**Primer tap 1/2-in standard.**



**2350**

**2400 BRONZE TRAP PRIMER**

with VACUUM BREAKER—Female thread (T) or copper sweat (S) 1/2-in. outlets in (3) bronze.



**2400T**



**2400S**



**2400MF**

**VALVE, 2400MF  
 DISTRIBUTION UNIT**

Bronze, with four outlets and two plugs, 1/2-in. copper seat connection; for multiple trap primer hookups.

**2902 TRENCH DRAIN  
 (12" X 24")**

Special duty 12 x 24-in. ductile iron drain grate with steel angle iron frame; (1) nickel bronze or (39) all galvanized available. **Note:** Type A=grate only, Type D=grate and frame units for assembly end-to-end.

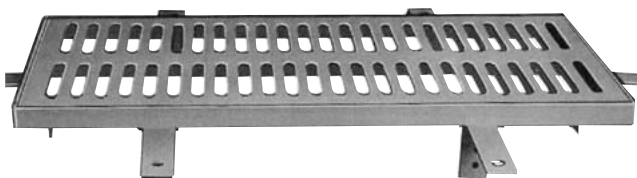

**2902, 2908**

**2908 TRENCH DRAIN  
 (8" X 24")**

Special duty 8 x 24-in. ductile iron drain grate with steel angle iron frame; (1) nickel bronze or (39) all galvanized available. **Note:** Type A=grate only, Type D=grate and frame units for assembly end-to-end.

**2920 TRENCH DRAIN**

Multiple section cast iron or galvanized trench drain with special duty ductile iron, galvanized, or nickel bronze veneer grate. Outlets inside caulk (IC) only. Order outlet units by pipe size; order extension unit separately to meet trench drain length requirements. Extensions fit any size outlet. Outlets shipped with two end pieces installed.



**2920 (OUTLET)  
 (12" x 24" Grate)**



**2920 (EXTENSION)  
 (12" x 12" Grate)**

**WADE**  
**SPECIFICATION DRAINAGE PRODUCTS**

**3000 SERIES ROOF DRAIN ASSEMBLIES WITH 10" DOME**

Large (16" Dia.) cast iron body with flange and flashing ring with gravel stop, (PD) polypropylene dome strainer on 2"-6" sizes; cast iron dome strainer on 8" and 10" sizes.



**3000**  
**2"-6"**

**3100 (2"-6") SERIES DECK DRAIN ASSEMBLY 12 X 12 SQUARE TOP**

Heel proof cast iron deck drain with flashing ring integral with gravel stop and square promenade top with ductile iron grate or nickel.



**3100**

**3220A ROOF DRAIN**

Threaded 90° side outlet cast iron or galvanized roof drain with flashing ring and polypropylene or optional cast iron mushroom dome.



**3220A**

**5100 GREASE INTERCEPTORS**

Fabricated steel grease interceptors with acid resisting coating inside and outside, removable baffles, gasketed cover and threaded inlet and outlet.

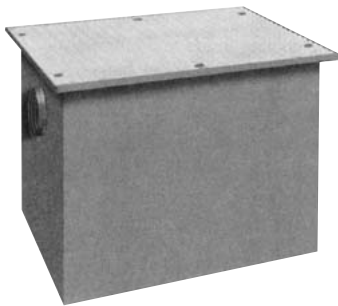

**5100**

**5100LR (Low Rough) GREASE INTERCEPTORS**

Fabricated steel grease interceptors with acid resisting coating inside and outside, removable baffles, gasketed cover and threaded inlet and outlet. The lower profile allows installation in confined spaces.

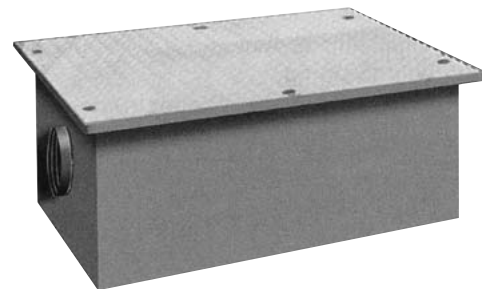

**5100LR**

**5100 COMPLETE ASSEMBLIES**

	Cat. No.	Pipe Size	GPM	Capacity lbs	UPC No. 670610	Wt.
Interceptor	5104, A	.2	4	8	.377856	40
	5107, A	.2	7	14	.377863	43
	5110, A	.2	10	20	.377870	55
	5115, A	.2	15	30	.377887	71
	5120, A	.2	20	40	.377894	80
	5125, A	.3	25	50	.377900	103
	5135, A	.3	35	70	.377917	120
	5150, A	.4	50	100	.377924	148

All units are PDI approved

**5100LR COMPLETE ASSEMBLIES**

	Cat. No.	Pipe Size	GPM	Capacity lbs	UPC No. 670610	Wt.
Interceptor	5115LR, A	.2	10	30	.373643	80
	5120LR, A	.2	15	40	.373636	127
	5135LR, A	.3	35	70	.373469	170
	5150LR, A	.3	50	100	.373681	220

**WADE  
 SPECIFICATION DRAINAGE PRODUCTS**

**5400 LARGE CAPACITY OIL INTERCEPTORS**

Fabricated steel oil interceptors with anti-skid gasketed cover, removable baffles, acid resisting coating inside and outside and threaded inlet and outlet.



**5400**

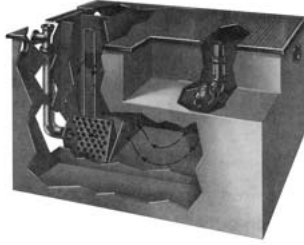

**5500**

**5400 COMPLETE ASSEMBLIES**

	Cat. No.	Pipe Size	GPM	Capacity lbs	UPC No. 670610	Wt.
Interceptor	5400-25	2	25	45	374022	306
	5400-35	3	35	64	374039	399
	5400-50	3	50	75	374046	531
	5400-75	4	75	150	374053	710
	5400-100	4	100	172	374060	941
	5400-150	4	150	210	374077	1235
	5400-200	4	200	285	374084	1524
	5400-250	4	250	397	374091	1654
	5400-300	6	300	487	374107	1887
	5400-350	6	350	525	374114	2014
	5400-400	6	400	598	374121	2261
	5400-450	6	450	630	374138	2350
	5400-500	6	500	735	374145	2510

**5740 SOLIDS INTERCEPTOR**

Cast iron with cleanout, stainless steel sediment bucket with handle, internal deep seal p-trap and gas tight cover; 2-in. outlets, 12-1/2 in. tall. (63) A.R.E. coated inside and out.

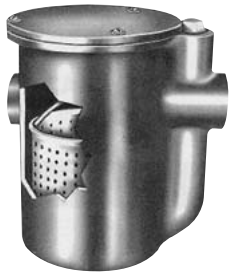

**5740**

**5750SO HAIR & SOLIDS INTERCEPTOR**

Side outlet hair and solids interceptor with removable stainless steel screen basket strainer; 1-1/2 IPS by 1-1/2 Slip joint, 6-1/2 in. tall.

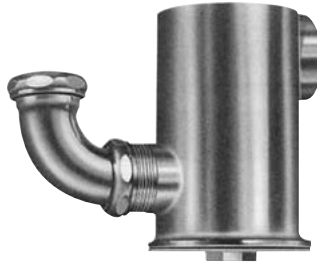

**5750SO**

**6000 SERIES FLOOR CLEANOUTS**

Cast iron floor cleanout with threaded adjustable housing, flanged ferrule and plastic plug and round secured nickel bronze top. ANSI Load Class (Standard Top) Light Duty (Under 2,000 lbs)



**6000**

**8300S SERIES ACCESS COVERS**

Square scoriated nickel bronze cover and frame, screw secured with or without hinged access cover.

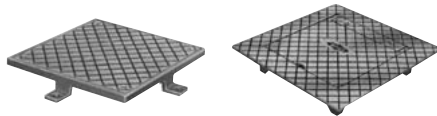

**8300S**

**8300SH**

**8480S ACCESS COVER**

Square smooth-finish stainless steel 7-in. square access cover with NB frame. Also available in Stainless Steel.



**8480S**

**8480R ACCESS COVER**

Round smooth (85) stainless steel access cover with vandal proof 1/4-20 x 3-1/2 center screw.

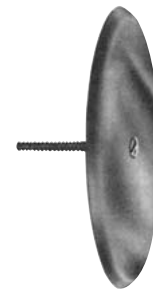

**8480R**

**WADE  
 SPECIFICATION DRAINAGE PRODUCTS**

**8600 WALL HYDRANTS  
 NON-FREEZE**

3/4" Non-freeze with bronze casing, straight inlet connections, anti-siphon backflow preventer



**8600**

**8600 COMPLETE ASSEMBLIES**

	Cat. No. & Wall Thickness, In.	Wall Thickness, In.	UPC No. 670610
Hydrants	<b>8600, L4, 3/4</b>	4	225003
	<b>8600, L6, 3/4</b>	6	225027
	<b>8600, L8, 3/4</b>	8	225034
	<b>8600, L10, 3/4</b>	10	225041
	<b>8600, L12, 3/4</b>	12	225058
	<b>8600, L14, 3/4</b>	14	225065
	<b>8600, L16, 3/4</b>	16	225072
	<b>8600, L18, 3/4</b>	18	225089
	<b>8600, L20, 3/4</b>	20	225102
	<b>8600, L22, 3/4</b>	22	225119
	<b>8600, L24, 3/4</b>	24	225126

**9140 FLOOR SINK**

Cast iron 12 x 12-in. square floor sink, 8-in. sump, with A.R.E. interior, aluminum dome strainer and nickel bronze top; (6) 1/2-in. trap primer tap, (15) half-grate, (16) 3/4-grate or (64) A.R.E. tops are available.



**8606-HC (Hot & Cold)  
 WALL HYDRANT**

3/4-inch multi-temperature wall hydrant with bronze casing, hot and cold water straight inlet connections and box with hinged locking lid. (Vacuum breaker box is 2-in deeper than standard.)

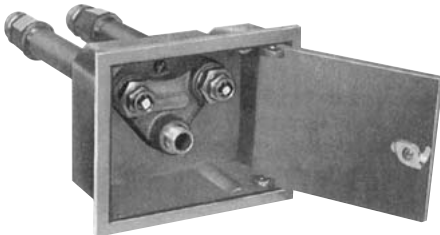

**8606HC**

**8606HC COMPLETE ASSEMBLIES  
 Wall Hydrant With (89) Vacuum Breaker**

	Cat. No. Size & Features	Wall Thickness, In.	UPC No. 670610
Hydrants	<b>8606HC, L4, 3/4</b>	4	332145
	<b>8606HC, L6, 3/4</b>	6	332152
	<b>8606HC, L8, 3/4</b>	8	332169
	<b>8606HC, L10, 3/4</b>	10	332176
	<b>8606HC, L12, 3/4</b>	12	332183
	<b>8606HC, L14, 3/4</b>	14	332190
	<b>8606HC, L16, 3/4</b>	16	332206
	<b>8606HC, L18, 3/4</b>	18	332213
	<b>8606HC, L20, 3/4</b>	20	332220
	<b>8606HC, L24, 3/4</b>	24	332237

	Cat. No. Size & Features	Wall Thickness, In.	UPC No. 670610
Hydrants	<b>8606HC, L4+2, 3/4, 89</b>	6	332244
	<b>8606HC, L6+2, 3/4, 89</b>	8	332251
	<b>8606HC, L8+2, 3/4, 89</b>	10	332268
	<b>8606HC, L10+2, 3/4, 89</b>	12	332275
	<b>8606HC, L12+2, 3/4, 89</b>	14	332282
	<b>8606HC, L14+2, 3/4, 89</b>	16	332299
	<b>8606HC, L16+2, 3/4, 89</b>	18	332305
	<b>8606HC, L18+2, 3/4, 89</b>	20	332312
	<b>8606HC, L20+2, 3/4, 89</b>	22	332329
	<b>8606HC, L24+2, 3/4, 89</b>	26	332336

**LAKESIDE CARRIES A COMPLETE LINE OF WADE  
 HYDRANT REPAIR KITS**