

Wairiri Light

Planning Guide

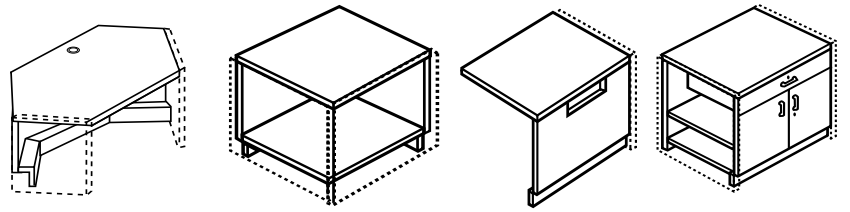

J A S P E R
L I B R A R Y
F U R N I T U R E

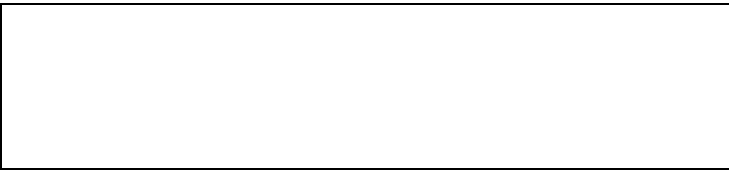

Wainwright Planning Guide

TABLE OF CONTENTS

- Warranty1
- Environmental Mission Statement.....2
- Ordering Information3
- Circulation Desk Specifications.....4
- Circulation Desk Modules..... 5-8
- End Panels9
- Intermediate Panels9
- Kneespace Panels9
- Swinging Gates9
- Stationary and Mobile Boxes10
- Keyboard Trays.....10
- Center Drawers10
- Transaction Ledges.....11
- Index11

WARRANTY

Community warrants to the original purchaser that each piece of furniture will be free from defects in workmanship given normal use for five years. Casters are warranted to be free from defects in materials and workmanship for a period of five years. Community will, at its option, repair or replace any defective merchandise within the terms of the warranty. This warranty does not apply to damage resulting from accident, alteration, or misuse.

Environmental Mission Statement

COMMUNITY has been an environmentally conscious organization for more than 75 years. Founded in 1929 in a Southern Indiana area settled by skilled German woodcrafters, Community began as a manufacturer of durable, well-crafted chairs. Through the years, as we have grown and expanded our product lines to include office furniture casegoods, tables, and lounge seating products, this heritage and respect for the environment continues. Building a product that will last and not require disposal in a landfill is our focus. Community is committed to “reduce, reuse and recycle” and to the conservation of our environment and its natural resources, as well as the encouragement of our suppliers and customers to do the same. A goal of a “Green Partnership” (supplier, manufacturer and customer) is essential for the long-term protection, preservation and sustainability of our environment for future generations. Our Mission is to continually maximize the use of sustainable raw materials and to search for new materials and processes that will not negatively impact our environment.

LOCATION

Our Community manufacturing facilities in Southern Indiana and North Carolina are often located within 500 miles of your project location, allowing you possible LEED credits toward Green Building Certification. With our diverse manufacturing capabilities, “one-stop shopping” is attainable, allowing you to conserve our fossil fuels and reduce greenhouse gases.

PACKAGING

Community places an emphasis on the minimal use of disposable packaging, while still providing adequate protection of the finished product. Our corrugated packaging is 100% recyclable or reusable. The packaging we receive from our suppliers is also reused or recycled. We recycle more than one million pounds of cardboard annually.

COMPLIANCE

Community employees are trained in compliance with applicable Occupational Safety and Health Administration (OSHA) regulations to exceed all applicable Department of Environmental Management (DEM) and Environmental Protection Agency (EPA) regulations for air emissions, storm water and hazardous waste disposal. Our safety philosophy is a 360-degree circle of safety program which includes home, work and travel. Our manufacturing facilities use the DuPont Safety Training Observation Program (STOP) supervision program for workplace environmental accident prevention and awareness.

MANUFACTURING FACILITIES

All of our Community manufacturing facilities are geared toward eco-efficiency and are encouraged to continually improve and conserve. Wood not used in the direct manufacturing process is recycled for use in concealed reinforcement cleats and corner blocks. Additional scrap materials are burned in scrubber-equipped boilers to generate steam that is used in the manufacturing process to operate our dry kilns or to heat our manufacturing facility during the winter. This process reduces greenhouse gases, the use of fossil fuels, and the burden of waste placed in landfills. In addition to other energy savings techniques, our manufacturing facilities use high-efficiency lighting, make use of power factor capacitors, and encourage the reduction of energy consumption and water usage. Condensation pumps are used to aid in water savings as well as extending boiler life.

MANUFACTURING PROCESSES

Community manufacturing facilities utilize finish and assembly processes that best support the furniture requirements and applications. We continually test the latest equipment and materials available to reduce emissions while maintaining the best quality product possible. Finish lines utilize highly efficient spray guns and spray techniques to reduce waste material. Excess finish material, solvents and waste are recycled. Flat line ultraviolet-cured finishing systems enable the excess finish material to be recaptured, recycled, and reused with no post-cure byproducts. Many assembly processes use water-based glues that contain no hazardous ingredients.

TEXTILES

Many of our fabric options utilize 100% recycled content. A grouping of leather alternatives contain no toxic materials, plasticizers, heavy metals or formaldehyde and have a 100% biodegradable back cloth. Available panel fabric uses a biological nutrient for the soil if discarded. Components – cushion foam, batting and poly-cord – used in upholstered products are recyclable and contain various percentages of recycled content. Excess fabric and leathers not utilized in the upholstery process are supplied to recyclers and local charities for additional use.

WOOD

Wood is good! It is the most diverse, process friendly, and widely utilized natural resource in mankind’s history. No other natural resource can match the environmental advantages of wood. It is renewable, recyclable, and biodegradable. Utilizing the sun’s energy, trees grow and remove carbon dioxide from the air while giving off oxygen to benefit the entire planet. Harvesting mature trees in a sustainable forest allows the photosynthetic cycle to continue at full optimization. We are proud to use wood as our primary “Green” renewable material resource.

Surprisingly, much of the public has the impression that processing wood involves wasting natural resources and destroying the environment, when just the opposite is true! According to the U.S. Forest Service, each year the U.S. grows about 50 percent more trees than are cut for furniture manufacturing. In fact, since 1952 the amount of commercial hardwood forest stock has increased by 70 percent. The hardwood industry currently utilizes approximately 13 billion board feet of standing timber per year. Current statistics from the Forest Service indicate that there are more than 715 billion board feet of commercial-size timber available for harvest. The United Nation’s 2007 *State of the World’s Forests* report shows that the United States forests are getting larger each year. The United States practices sustainable forestry both in the softwood and hardwood industries.

MATERIAL OPTIONS

Alternative materials are available for consideration from Community. Solid wood and engineered wood options like Lyptus®, Plyboo®, reclaimed woods, agricultural and post-consumer waste fiber products, soy-based resin bio-composites, Forest Stewardship Council (FSC) certified wood – the list continues to grow – all allow possible LEED credits toward Green Building Certification. These options can be considered for specific applications based on their performance. We support sustainable forestry by purchasing wood products grown in sustainable forest programs.

Community’s goal is to provide value for our customers and to expand and improve our “Green Partnerships” through process, product and life cycle management.

Wainwright Ordering Information

1. MODEL NUMBER

2. STANDARD WOOD SPECIES: Oak, Maple

3. WOOD FINISH:

Oak

NOO Natural Oak

GOO Golden Oak

MOO Medium Oak

LCO Light Cherry

MCO Medium Cherry

MWO Medium Walnut

MMO Medium Mahogany

DMO Dark Mahogany

Maple

NMM Natural Maple

AMM Amber Maple

LCM Light Cherry

MCM Medium Cherry

MWM Medium Walnut

MMM Medium Mahogany

DMM Dark Mahogany

4. EDGE DETAILS: Edge A



Edge B



Edge C



Edge E



Edge I



5. DESK WORKSURFACE HEIGHTS: 29", 32" or 39"

6. LAMINATE SELECTION: Standard Wilsonart, Nevemar, Formica or Pionite

7. DECORATIVE STRIPE WITH APPLIQUES: Circle, diamond, square and triangle

- When ordering please specify shape, color and quantity. Please call for pricing.
- Must submit drawing showing placement and orientation of appliqué.

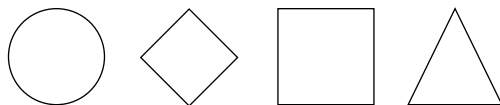

8. DESK LAYOUT must be submitted with each order.

Wainwright Circulation Desk Specifications

Wainwright desks are configured using the starter and adder concept where units share a common intermediate panel. All desk modules are available in 29", 32" or 39" heights.

TOPS Tops shall be 1 3/16"-thick, 45-pound density particle board core. Top surface to be laminated with a .050"-thick, high-pressure, plastic laminate sheet, bottom surface laminated with backing sheet not less than .020"-thick for balanced construction. All tops will be individually mounted in-between end, kneespace and intermediate panels by means of Z-bars and bolt assembly. Unit tops will receive solid hardwood internal bands. External bands are optional. Work surfaces 60" and longer will be fitted with "U"-shaped metal keel for added support. The metal keel will be mounted on the underside of the top.

END, KNEESPACE AND INTERMEDIATE PANELS The end, kneespace and intermediate panels shall be constructed from 1 3/16"-thick, 3-ply, 45-pound density particle board core with Grade "A" faces. The panel edges will be externally banded on all sides with 1/4" eased, external hardwood band. End panels are required on the ends of each desk assembly. Intermediate panels or kneespace panels are required between each unit. Each intermediate and kneespace panel will be bored and fitted with a PVC pass-through grommet for wire management. Both faces of the intermediate panels and the inside faces of the end panels will be bored for 32mm shelf adjustment, hinged doors, transaction ledges and drawer mountings for a truly modular system. The tops of the 29"-high and 32"-high end intermediate panels shall receive (2) brass inserts for the attachment of transaction ledge panels.

FRONT PANEL Front panels will be constructed from 3/4"-thick, 3-ply, 45-pound density particle board core with Grade "A" veneered faces. Grain direction will run vertically. A 3/4" deep x 4" high, recessed, laminated, black toe kick will be mounted to the front of the panel. Front panels will be joined to end- and mid-panels by means of Mod-eez® clips. The front panels shall attach to the work surfaces by means of cam locks.

DRAWERS Drawer fronts will be constructed from 3/4"-thick, 3-ply particle board core with Grade "A" select veneer faces, their edges banded with 1/4"-thick veneer. Drawer case(s) shall be constructed from 7/16"-thick veneer plywood, with the bottom constructed of 3/16". Case is a dovetail assembly. The full-extension, ball-bearing glides have a load rating of 100 pounds. All drawers come complete with pulls.

ADJUSTABLE SHELVES Shelves will be constructed from 3/4"-thick, 3-ply, veneered particle board core. Front edge shall be banded with 1/4" eased external band. Shelves shall be adjustable on 32mm centers.

CUPBOARD DOORS Hinged doors will be constructed from 3/4"-thick, 3-ply particle board core with Grade "A" faces. All edges shall be externally banded with solid hardwood. The doors fasten to the end and intermediate panels by means of 95-degree door hinges. All cupboard doors come complete with pulls.

CABINET DIMENSIONS All modules will be 29", 32" or 39" high x 30" deep.

TRANSACTION LEDGE TOP The transaction ledge shall be constructed of 1 1/8"-thick, 3-ply, 45-pound density particle board core with Grade "A" veneered faces. The top surfaces shall be laminated with high-pressure plastic laminate. The front and back edges will be internally banded with solid hardwood.

TRANSACTION LEDGE END AND INTERMEDIATE PANELS The transaction ledge end panel and intermediate panels shall be constructed from 1 1/4"-thick, 3-ply, 45-pound density particle board core with Grade "A" faces. The exposed panel edges will be externally banded on all sides with 1/4" eased external hardwood band. The panels shall attach to the desk end and intermediate panels by means of cam locks.

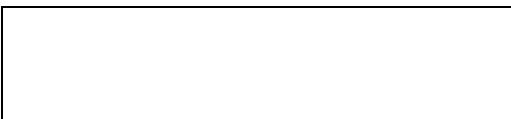

Wainwright Circulation Desk Modules

for specifications, please see page 4 • for ordering information, please see page 3

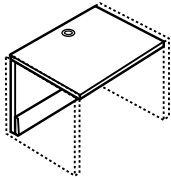
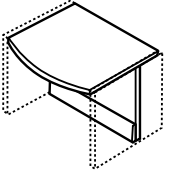
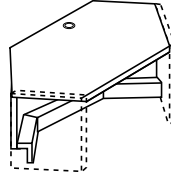
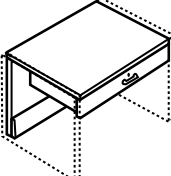
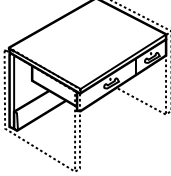
	Model	Size	Description	Weight	List Price		
					Oak	Maple	
	WA3036DE-29	30" D x 34" W x 29" H	Desk unit	200	\$ 977	\$ 1,129	
	WA3036DE-32	30" D x 34" W x 32" H	Desk unit	215	977	1,129	
	WA3036DE-39	30" D x 34" W x 39" H	Desk unit	230	977	1,129	
	WA3048DE-29	30" D x 46" W x 29" H	Desk unit	250	\$ 1,371	\$ 1,465	
	WA3048DE-32	30" D x 46" W x 32" H	Desk unit	265	1,371	1,465	
	WA3048DE-39	30" D x 46" W x 39" H	Desk unit	290	1,371	1,465	
	WA3060DE-29	30" D x 58" W x 29" H	Desk unit	320	\$ 1,833	\$ 2,071	
	WA3060DE-32	30" D x 58" W x 32" H	Desk unit	335	1,833	2,071	
	WA3060DE-39	30" D x 58" W x 39" H	Desk unit	350	1,833	2,071	
	WA3072DE-29	30" D x 70" W x 29" H	Desk unit	390	\$ 2,296	\$ 2,542	
	WA3072DE-32	30" D x 70" W x 32" H	Desk unit	405	2,296	2,542	
	WA3072DE-39	30" D x 70" W x 39" H	Desk unit	420	2,296	2,542	
		<i>*One grommet per seated position.</i>					
		WA3036-ADA-29	30" D x 36" W x 29" H	ADA desk module	200	\$ 1,124	\$ 1,270
		WA3036-ADA-32	30" D x 36" W x 32" H	ADA desk module	215	1,124	1,270
	WA90AEC-29	30" D x 34" W x 29" H	Angled extended corner unit	475	\$ 3,682	\$ 4,247	
	WA90AEC-32	30" D x 34" W x 32" H	Angled extended corner unit	495	3,682	4,247	
	WA90AEC-39	30" D x 34" W x 39" H	Angled extended corner unit	515	3,682	4,247	
	WA3036D-29	30" D x 34" W x 29" H	Single drawer unit	220	\$ 1,884	\$ 2,128	
	WA3036D-32	30" D x 34" W x 32" H	Single drawer unit	235	1,884	2,128	
	WA3036D-39	30" D x 34" W x 39" H	Single drawer unit	280	1,884	2,128	
	<i>Drawer Height = 6-7/8"</i>						
	WA3036K-29	30" D x 34" W x 29" H	Kneespace unit	250	\$ 1,970	\$ 2,227	
	WA3036K-32	30" D x 34" W x 32" H	Kneespace unit	265	1,970	2,227	
	WA3036K-39	30" D x 34" W x 39" H	Kneespace unit	280	1,970	2,227	

Wainwright Circulation Desk Modules

for specifications, please see page 4 • for ordering information, please see page 3

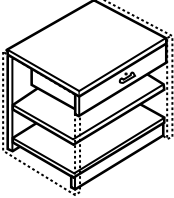
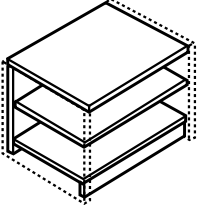
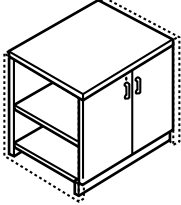
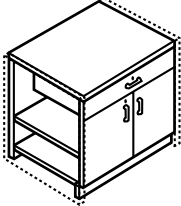
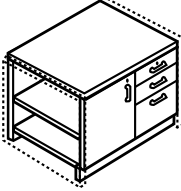
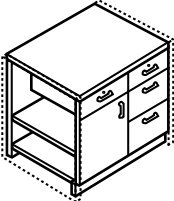
	Model	Size	Description	Weight	List Price	
					Oak	Maple
	WA3036DS-29	30" D x 34" W x 29" H	Single drawer w/shelf module	250	\$ 1,579	\$ 1,784
	WA3036DS-32	30" D x 34" W x 32" H	Single drawer w/shelf module	270	1,579	1,784
	WA3036DS-39	30" D x 34" W x 39" H	Single drawer w/shelf module	290	1,579	1,784
	WA3036OS-29	30" D x 34" W x 29" H	Open shelf module	235	\$ 1,244	\$ 1,406
	WA3036OS-32	30" D x 34" W x 32" H	Open shelf module	255	1,244	1,406
	WA3036OS-39	30" D x 34" W x 39" H	Open shelf module	275	1,244	1,406
	WA3036CS-29	30" D x 34" W x 29" H	Cupboard storage module – 2 door	235	\$ 1,624	\$ 1,835
	WA3036CS-32	30" D x 34" W x 32" H	Cupboard storage module – 2 door	250	1,624	1,835
	WA3036CS-39	30" D x 34" W x 39" H	Cupboard storage module – 2 door	265	1,624	1,835
	WA3036CD-29	30" D x 34" W x 29" H	Closed cupboard drawer unit	270	\$ 1,877	\$ 2,120
	WA3036CD-32	30" D x 34" W x 32" H	Closed cupboard drawer unit	285	1,877	2,120
	WA3036CD-39	30" D x 34" W x 39" H	Closed cupboard drawer unit	300	1,877	2,120
	WA3036CPBF-29	30" D x 34" W x 29" H	Cupboard pencil/box/file	280	\$ 2,697	\$ 3,047
	WA3036CBFF-32	30" D x 34" W x 32" H	Cupboard box/box file	280	\$ 2,697	\$ 3,047
	WA3036CBBFF-39	30" D x 34" W x 39" H	Cupboard box/box file/file	280	\$ 2,760	\$ 3,119



Wainwright Circulation Desk Modules

for specifications, please see page 4 • for ordering information, please see page 3

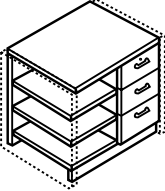
	Model	Size	Description	Weight	List Price	
					Oak	Maple
	WA3036CBFF-39	30" D x 34" W x 39" H	Cupboard box file/file	280	\$ 2,697	\$ 3,047
	WA3036CFF-32	30" D x 34" W x 32" H	Cupboard file/file	260	\$ 2,312	\$ 2,613
	WA3036OC-29	30" D x 34" W x 29" H	Open storage w/cupboard	250	\$ 1,566	\$ 1,754
	WA3036OC-32	30" D x 34" W x 32" H	Open storage w/cupboard	270	1,566	1,754
	WA3036OC-39	30" D x 34" W x 39" H	Open storage w/cupboard	290	1,566	1,754
	WA3036OCD-29	30" D x 34" W x 29" H	Open storage w/cupboard & box	260	\$ 1,820	\$ 2,056
	WA3036OCD-32	30" D x 34" W x 32" H	Open storage w/cupboard & box	280	1,820	2,056
	WA3036OCD-39	30" D x 34" W x 39" H	Open storage w/cupboard & box	300	1,820	2,056
	WA3036OBBB-29	30" D x 34" W x 29" H	Open storage w/cupboard & box/box/box	275	\$ 2,525	\$ 2,827
	WA3036OBBF-32	30" D x 34" W x 32" H	Open storage w/cupboard & box/box file	275	\$ 2,552	\$ 2,859
	WA3036OBFF-39	30" D x 34" W x 39" H	Open storage w/cupboard & box/file/file drawer	275	\$ 2,577	\$ 2,912

Wainwright Circulation Desk Modules

for specifications, please see page 4 • for ordering information, please see page 3

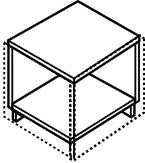
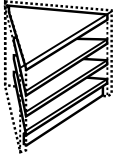
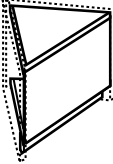
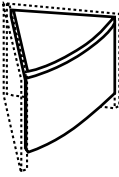
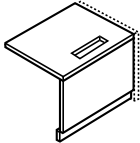
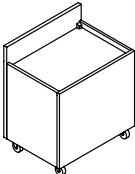
	Model	Size	Description	Weight	List Price	
					Oak	Maple
	WA90QC-29	30" D x 30" W x 29" H	Closed corner unit	175	\$ 1,468	\$ 1,646
	WA90QC-32	30" D x 30" W x 32" H	Closed corner unit	195	1,468	1,646
	WA90QC-39	30" D x 30" W x 39" H	Closed corner unit	210	1,468	1,646
<i>Ships assembled.</i>						
	WA900C-29	30" D x 30" W x 29" H	90° triangular corner module display	190	\$ 1,674	\$ 1,875
	WA900C-32	30" D x 30" W x 32" H	90° triangular corner module display	205	1,674	1,875
	WA900C-39	30" D x 30" W x 39" H	90° triangular corner module display	220	1,674	1,875
<i>Ships assembled.</i>						
	WA45TC-29	30" D x 23" W x 29" H	45° triangular corner module	140	\$ 1,485	\$ 1,678
	WA45TC-32	30" D x 23" W x 32" H	45° triangular corner module	155	1,485	1,678
	WA45TC-39	30" D x 23" W x 39" H	45° triangular corner module	170	1,485	1,678
	WA90TC-29	30" D x 30" W x 29" H	90° triangular corner module	175	\$ 1,564	\$ 1,766
	WA90TC-32	30" D x 30" W x 32" H	90° triangular corner module	190	1,564	1,766
	WA90TC-39	30" D x 30" W x 39" H	90° triangular corner module	205	1,564	1,766
<i>Ships assembled.</i>						
	WA45RC-29	30" D x 23" W x 29" H	45° triangular rounded module	140	\$ 1,743	\$ 1,952
	WA45RC-32	30" D x 23" W x 32" H	45° triangular rounded module	155	1,743	1,952
	WA45RC-39	30" D x 23" W x 39" H	45° triangular rounded module	170	1,743	1,952
	WA90RC-29	30" D x 30" W x 29" H	90° triangular rounded module	175	\$ 1,800	\$ 2,016
	WA90RC-32	30" D x 30" W x 32" H	90° triangular rounded module	190	1,800	2,016
	WA90RC-39	30" D x 30" W x 39" H	90° triangular rounded module	205	1,800	2,016
<i>Ships assembled.</i>						
	WA3036BRT-29	30" D x 34" W x 29" H	Book return top drop	170	\$ 1,036	\$ 1,170
	WA3036BRT-32	30" D x 34" W x 32" H	Book return top drop	190	1,036	1,170
	WA3036BRT-39	30" D x 34" W x 39" H	Book return top drop	210	1,036	1,170
	WA3036BRF-29	30" D x 34" W x 29" H	Book return front drop	170	\$ 1,036	\$ 1,170
	WA3036BRF-32	30" D x 34" W x 32" H	Book return front drop	190	1,036	1,170
	WA3036BRF-39	30" D x 34" W x 39" H	Book return front drop	210	1,036	1,170
	BDT-330-EH	22" D x 30" W x 27" H	Depressible Book Truck	110	\$ 1,615	
	BDT-330	22" D x 30" W x 33" H	Depressible Book Truck	125	1,708	
	-RB (Add suffix to order number)		Rubber Bumpers		316	
<i>Features a spring-supported top to soften the drop of the books and depress as the weight increases; comes with four 3" swivel casters.</i>						

Wainwright Desk Panels and Storage

for specifications, please see page 4 • for ordering information, please see page 3

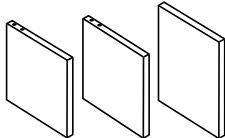
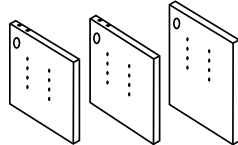
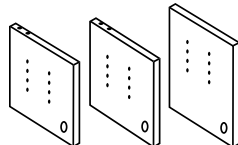
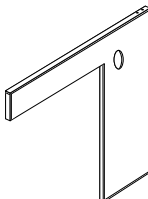
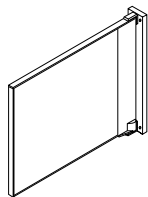
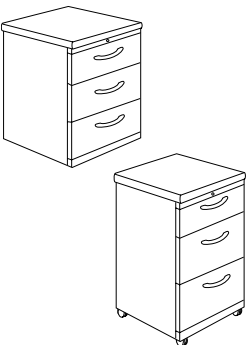
	Model	Size	Description	Weight	List Price	
					Oak	Maple
	WA29EPL	1-3/16" D x 30" W x 29" H	End panel, left	50	\$ 370	\$ 417
	WA29EPR	1-3/16" D x 30" W x 29" H	End panel, right	50	370	417
	WA32EPL	1-3/16" D x 30" W x 32" H	End panel, left	60	370	417
	WA32EPR	1-3/16" D x 30" W x 32" H	End panel, right	60	370	417
	WA39EPL	1-3/16" D x 30" W x 39" H	End panel, left	75	370	417
	WA39EPR	1-3/16" D x 30" W x 39" H	End panel, right	75	370	417
	WA29IP	1-3/16" D x 30" W x 29" H	Intermediate panel	50	\$ 376	\$ 425
	WA32IP	1-3/16" D x 30" W x 32" H	Intermediate panel	60	376	425
	WA39IP	1-3/16" D x 30" W x 39" H	Intermediate panel	75	376	425
	WA29DP	1-3/16" D x 30" W x 29" H	Display intermediate panel	50	\$ 376	\$ 425
	WA32DP	1-3/16" D x 30" W x 32" H	Display intermediate panel	60	376	425
	WA39DP	1-3/16" D x 30" W x 39" H	Display intermediate panel	75	376	425
			<i>For use on open display only.</i>			
	WA29KP	1-3/16" D x 30" W x 29" H	Kneespace panel	40	\$ 432	\$ 486
	WA32KP	1-3/16" D x 30" W x 32" H	Kneespace panel	50	432	486
	WA39KP	1-3/16" D x 30" W x 39" H	Kneespace panel	65	432	486
	WA29SG	1-3/16" D x 34" W x 29" H	Swinging gate	55	\$ 1,010	\$ 1,141
	WA32SG	1-3/16" D x 34" W x 32" H	Swinging gate	60	1,010	1,141
	WA39SG	1-3/16" D x 34" W x 39" H	Swinging gate	70	1,010	1,141
	WA-BBB29	27" D x 19" W x 27-3/4" H	Stationery box, box, box pedestal	100	\$ 924	\$ 1,044
	WA-BBF32	27" D x 19" W x 31-3/4" H	Stationery box, box, file pedestal	120	924	1,044
	WA-FF32	27" D x 19" W x 31-3/4" H	Stationery file, file pedestal	120	871	985
	WA-BFF39	27" D x 19" W x 37-3/4" H	Stationery box, file, file pedestal	140	924	1,044
	WA-M-BBB29	27" D x 19" W x 27-3/4" H	Mobile box, box, box pedestal	100	\$ 1,023	\$ 1,145
	WA-M-BBF32	27" D x 19" W x 31-3/4" H	Mobile box, box, file pedestal	120	1,023	1,145
	WA-M-FF32	27" D x 19" W x 31-3/4" H	Mobile file, file pedestal	120	970	1,088
	WA-M-BFF39	27" D x 19" W x 37-3/4" H	Mobile box, file, file pedestal	140	1,023	1,145

Wainwright Desk Accessories

for specifications, please see page 4 • for ordering information, please see page 3

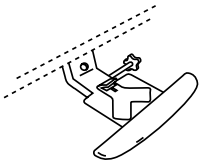
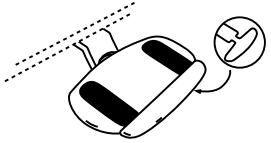
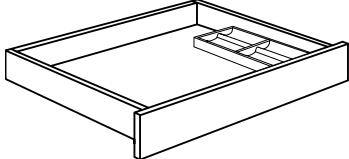
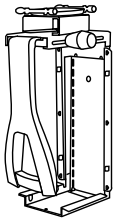

	Model	Size	Description	Weight	List Price	
					Oak	Maple
	AK1	10-1/2" D x 20-1/2" W x 3" H	Keyboard tray	4	\$ 351	\$ 351
	AK3	11" D x 23" W x 3" H	Keyboard tray	11	\$ 411	\$ 411
	WA-2032-PD	20" D x 32" W x 3" H	Pencil drawer	15	\$ 202	\$ 227
	WA-CPU	6-5/8" D x 17-1/2" H 9" W – Largest available 3" W – Smallest available	CPU Holder	10	\$ 304	\$ 304

There is a \$60.00 upcharge per each additional grommet.

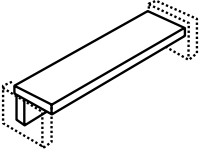
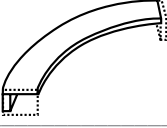

Wainwright Transaction Ledges

for specifications, please see page 4 • for ordering information, please see page 3

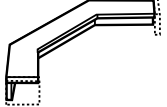
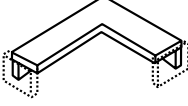
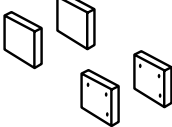
	Model	Size	Description	Weight	List Price	
					Oak	Maple
<i>NOTE: 7" height used with 32" worksurface; 10" height used with 29" worksurface.</i>						
	WASTL36	8" D x 34" W	Straight transaction ledge	30	\$ 273	\$ 298
	WASTL48	8" D x 46" W	Straight transaction ledge	40	402	453
	WASTL60	8" D x 58" W	Straight transaction ledge	50	530	598
	WASTL72	8" D x 70" W	Straight transaction ledge	60	659	745
	WA45CTL	8" D x 23" W	45° curved transaction ledge	45	\$ 680	\$ 767
	WA90CTL	8" D x 34" W	90° curved transaction ledge	45	773	873
	WA45TTL	8" D x 23" W	45° triangular transaction ledge	40	\$ 242	\$ 273
	WA90TTL	8" D x 34" W	90° triangular transaction ledge	40	273	308
	WA90AECTL	8" D x 34" W	Angled extended corner transaction ledge	75	\$ 1,340	\$ 1,514
	WAQTL	8" D x 30" W	Square corner transaction ledge	45	\$ 700	\$ 791
	WATLEP	1-3/16" D x 8-5/8" W	Transaction ledge end panel*	8	\$ 122	\$ 136
	WATLIP	1-3/16" D x 8-5/8" W	Transaction ledge intermediate panel*	8	122	136
<i>*End and intermediate panels MUST be ordered separately.</i>						

Index

AK1..... 10	WA3036CS-32..... 6	WA3036OS-32..... 6	WA39SP..... 9	WA90TC-29..... 8
AK3..... 10	WA3036CS-39..... 6	WA3036OS-39..... 6	WA45CTL..... 11	WA90TC-32..... 8
BDT-330..... 8	WA3036D-29..... 5	WA3036-ADA-29..... 5	WA45RC-29..... 8	WA90TC-39..... 8
BDT-330-EH..... 8	WA3036D-32..... 5	WA3036-ADA-32..... 5	WA45RC-32..... 8	WA90TTL..... 11
RB..... 8	WA3036D-39..... 5	WA3036-ADA-39..... 5	WA45RC-39..... 8	WAQTL..... 11
WA29EPL..... 9	WA3036DE-29..... 5	WA3048DE-29..... 5	WA45TC-29..... 8	WASTL36..... 11
WA29EPR..... 9	WA3036DE-32..... 5	WA3048DE-32..... 5	WA45TC-32..... 8	WASTL48..... 11
WA29IP..... 9	WA3036DE-39..... 5	WA3048DE-39..... 5	WA45TC-39..... 8	WASTL60..... 11
WA29KP..... 9	WA3036DS-29..... 6	WA3060DE-29..... 5	WA45TTL..... 11	WASTL72..... 11
WA29SG..... 9	WA3036DS-32..... 6	WA3060DE-32..... 5	WA90AEC-29..... 5	WATLEP..... 11
WA3036BRF-32..... 8	WA3036DS-39..... 6	WA3060DE-39..... 5	WA90AEC-32..... 5	WATLIP..... 11
WA3036BRF-39..... 8	WA3036K-29..... 5	WA3072DE-29..... 5	WA90AEC-39..... 5	WA-2032-PD..... 10
WA3036BRT-29..... 8	WA3036K-32..... 5	WA3072DE-32..... 5	WA90CTL..... 11	WA-BBB29..... 9
WA3036BRT-32..... 8	WA3036K-39..... 5	WA3072DE-39..... 5	WA90ECTL..... 11	WA-BBF32..... 9
WA3036BRT-39..... 8	WA30360BBB-32..... 7	WA32EPL..... 9	WA90OC-29..... 8	WA-BFF39..... 9
WA3036CBFF-32..... 6	WA30360BFF-39..... 7	WA32EPR..... 9	WA90OC-32..... 8	WA-CPU..... 10
WA3036CBFF-39..... 6	WA3036OC-29..... 7	WA32IP..... 9	WA90OC-39..... 8	WA-FF32..... 9
WA3036CBFF-39..... 6	WA3036OC-32..... 7	WA32KP..... 9	WA90QC-29..... 8	WA-M-BBB29..... 9
WA3036CD-29..... 6	WA3036OC-39..... 7	WA32SP..... 9	WA90QC-32..... 8	WA-M-BBF32..... 9
WA3036CD-32..... 6	WA3036OCD-29..... 7	WA39EPL..... 9	WA90QC-39..... 8	WA-M-BFF39..... 9
WA3036CD-39..... 6	WA3036OCD-32..... 7	WA39EPR..... 9	WA90RC-29..... 8	WA-M-FF32..... 9
WA3036CFF-32..... 7	WA3036OCD-39..... 7	WA39IP..... 9	WA90RC-32..... 8	
WA3036CS-29..... 6	WA3036OS-29..... 6	WA39KP..... 9	WA90RC-39..... 8	