

## Water Control and Measurement on the Farm<sup>1</sup>

A. R. ROBINSON and A. S. HUMPHERYS

*Agricultural Research Service, USDA  
Kimberly, Idaho*

Complete water control and measurement in farm distribution systems are essential requirements for an efficient irrigation system. Problems and hydraulic principles involved in the selection, design and operation of structures for accurate water control and measurement are presented in this chapter. For convenience, the chapter has been divided into two main categories, open channel and closed systems. Control and measurement structures and methods are discussed for each.

### 1. OPEN-CHANNEL SYSTEMS

An open channel is one in which the streamflow is not completely confined by solid boundaries but has a free surface subject to atmospheric pressure. It may be an open conduit or a pipe flowing partly full. In farm distribution systems, most open channels consist of lined or unlined earth ditches and flumes. In contrast to closed systems, open channels are constructed on a grade corresponding to that which the water surface is expected to assume.

#### A. Water Control

An efficient irrigation system requires that the operator have complete control of the water with ability to measure it at various points throughout the system. He must be able to apply water to the land in the quantities needed at nonerosive velocities and with a minimum of labor. Open-channel water control on the farm is achieved by using structures to control the water as it is conveyed from the main canal or lateral headgate, natural stream, or other source to its destination on the field. Structures may be required also to control the channel itself when unlined ditches are used. These water-control structures regulate water levels, dissipate excess energy, provide accurate distribution, and deliver water at the desired rate, without erosion, onto the field. Names of the various structures referred to in this chapter will be those in common use in the USA. In other countries, the same structure may be referred to by different names.

#### 1. FUNCTIONAL REQUIREMENTS AND PROBLEMS

Water flowing in a farm ditch is usually below the level required for field diversion. The water surface in the ditch must be raised to allow distribution from the ditch by gravity flow. High water application efficiency also requires

<sup>1</sup> Contribution from the Soil and Water Conserv. Res. Div., ARS, USDA.

discharge controls that accurately meter and control the flow of water onto the field with a minimum of erosion.

Irrigation water frequently contains sediment or other undesirable materials. Sediment in the water may be deposited in irrigation ditches, pipelines, and measuring structures. This necessitates frequent ditch cleaning and often results in inaccurate flow measurement. Trash in irrigation water may be a source of weed infestation on the farm; it also clogs smaller irrigation structures. Structures are needed to remove trash and excess sediment from the water.

Land slopes on irrigated farms are often greater than the gradient necessary to overcome friction losses in open channels. Thus, problems of grade control, energy dissipation, and maintaining uniform water distribution onto the field are encountered. On most irrigated farms, erosion-control and energy dissipating structures are needed to stabilize unlined ditches.

Structures that remain in place for more than one irrigation season are considered permanent. Those that are moved from place-to-place during each irrigation or installed for one season's use are considered temporary. Some temporary structures are required on most irrigated farms, but permanent structures normally permit better water control with less labor. The cost of farm irrigation structures can often be reduced by combining two or more structures wherever possible. For example, checks, drops, turnouts, divisors and measuring structures can be combined in various combinations as illustrated in Fig. 42-1.

Fig. 42-1. Combination irrigation structures may be built for measuring, checking, dividing, and dropping the stream.



Wooden structures have been used extensively in the USA during the past century but are being replaced more and more by concrete and metal. Structures made of the more durable materials are recommended for permanent installations. Many commercial concerns are now manufacturing precast concrete and modular or component type metal structures. These permanent type structures are very useful, efficient and well adapted for farmer installation. Effective water control on the farm may also be obtained by using improved plastic and rubber devices and structures.

## 2. WATER LEVEL CONTROL

Water level control structures are perhaps the most common and frequently used. Suggestions and guidelines for the design and installation of farm water

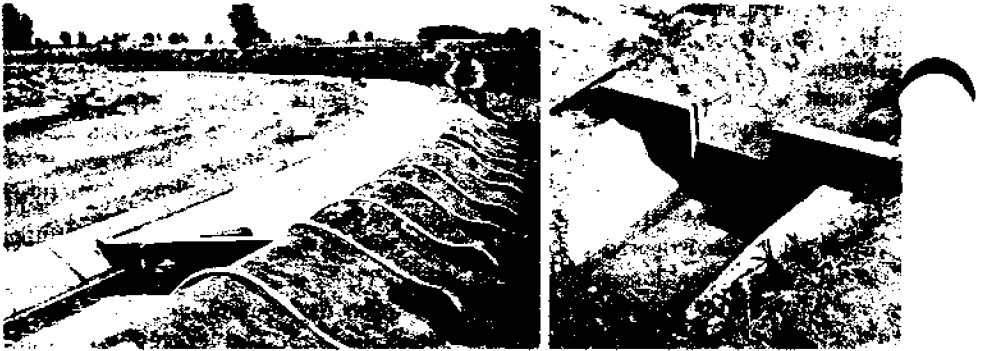

Fig. 42-2. Two types of check structures commonly used on the farm (left photo courtesy of Soil Conserv. Serv., USDA).

level control structures are given in various publications, (Code, 1961; Gilden and Woodward, 1952; Herpich and Manges, 1959; Jensen et al., 1954; and Robinson et al., 1963). Other references are also given by Israelsen and Hansen (1962).

a. **Checks.** A check is any structure installed in an open channel to raise the water level above its normal flow depth. A variety of checks are used in both lined and unlined ditches. They are usually fitted with grooves to receive checkboards or with metal slide gates which permit flow to bypass while maintaining the desired water level. Some commonly used permanent and portable check structures are shown in Fig. 42-2.

When a constant upstream water level is desired, an overflow type check is normally used. The flow over such a check may be estimated from the general equation

$$Q = C'Lh(2gh)^{1/2} = CLh^n \quad [42-1]$$

where

$Q$  = discharge,  $L^3/T$ ,

$C'$  = coefficient of discharge, dimensionless,

$C = C'(2g)^{1/2}$  = coefficient of discharge,  $L^{1/2}/T$ ,

$L$  = overflow crest length,  $L$ ,

$h$  = head or water depth above the crest measured upstream from the check,  $L$ , where  $L$  and  $T$  denote length and time in convenient dimensions.

The value of the exponent  $n$  for most overflow type checks is approximately 1.5. When the crest length  $L$  is large, variations in discharge result in relatively small changes in the upstream water level.

When the water level is to be controlled downstream from a structure, an orifice-type check is more desirable because of a more constant discharge. The discharge through an orifice may be determined from the general equation

$$Q = CA(2gh)^{1/2} \quad [42-2]$$

where  $C$  is coefficient of discharge, dimensionless,  $A$  is area of opening,  $L^2$ ,  $g$  is acceleration of gravity,  $L/T^2$ , and  $h$  is head causing flow,  $L$ . The coefficient of discharge  $C$  ranges from 0.6 to approximately 0.8, depending on the position of

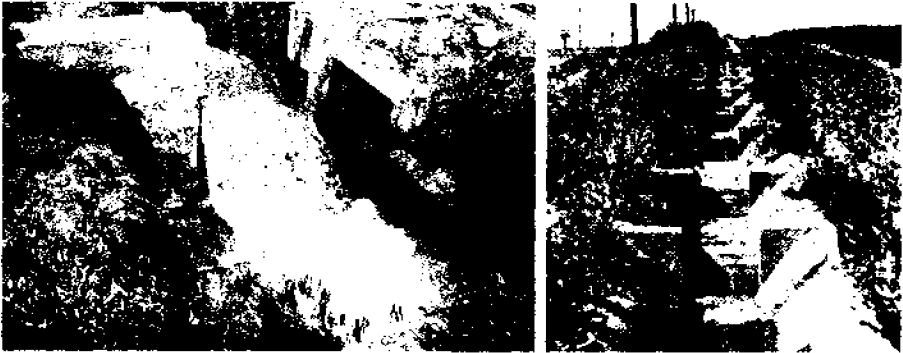

Fig. 42-3. Drop structures used for grade control and energy dissipation in a farm ditch (left photo courtesy of Soil Conserv. Serv., USDA).

the orifice relative to the sides and bottom of the structure and on the roundness of the orifice edge. For free discharge, the head  $h$  is the upstream water depth and is measured from the center of the opening. For submerged flow, the effective head is the difference between the upstream and downstream water surface levels. Because of its head-discharge relationship, an orifice-type check is not as well adapted for upstream water level control since fluctuations in quantity of flow result in relatively large upstream water level variations.

Commercial prefabricated checks for unlined ditches can be obtained with or without an apron on the downstream side. The apron is often omitted because of difficulty encountered when backfilling beneath it. If the apron is not part of the check, adequate erosion protection must be provided downstream by a stilling basin, riprap or a rigid apron.

**b. Drops.** Grade control structures are required to reduce erosive flow velocities in unlined ditches. In a steeply sloping channel, erosion control is accomplished by conveying water from one level to another in a stairstep manner (Fig. 42-3). Grade control structures are called drops when the water surface is lowered in a short horizontal distance. If the drop occurs over longer distances in a channel



Fig. 42-4. Drop structure combined with turnout; the blocks are used to shorten the length of the hydraulic jump.

permitting high velocities, the structure is generally referred to as a chute. Where water is to be diverted from the ditch or lateral to a field or another ditch at a lower level, a drop structure is often combined with a check or turnout (Fig. 42-4).

A primary consideration in the use of drops is to provide adequate downstream protection. The energy of the falling water must be dissipated to prevent undermining of the structure and erosion of the downstream channel. In most field ditches with maximum recommended drops limited to 30 to 60 cm (12 to 24 inches), rock riprap is used to protect the downstream banks from eddy currents and turbulence created in the drop. The apron is set below the downstream grade to form a stilling pool to cushion the falling water. Higher drops or large streams require more elaborate means for dissipating the stream energy and reducing its velocity. Drops in excess of 90 cm (3 ft) require special precautions such as cut-off walls to insure against erosion, uplift, and piping.

A variety of open-type drop structures are used and are constructed from various materials as previously mentioned. Enclosed drops made of concrete or corrugated steel pipe having short right angle elbows are also used (Fig. 42-5). These drops are particularly useful in small ditches and where a combined road crossing is needed. However, this drop is more easily plugged by trash, and riprap protection is needed both at the inlet and outlet.

A recent practice in some areas is that of constructing slipform lined ditches in steps of level sections with a drop at the end of each section. A check, placed just ahead of the drop, raises the water level for diversion to the field. This type of construction results in essentially a horizontal water surface in each level section for uniform distribution to the field. This practice will become more common with increased use of automatic irrigation control structures.

c. **Dams.** Portable irrigation dams are essentially checks used to raise the water level in the ditch for diversion. They have been used by the irrigation farmer for many years. Dams in common use are made of canvas, plastic, or butyl rubber. They are low in cost but require special care to prevent damage in order to extend their life beyond one season. Many dams are fitted with an adjustable dam stick or weir-type opening. The water level in the ditch is controlled by adjusting the water flow over the top or through the opening of the dam (Fig. 42-6). Portable dams usually have a higher labor requirement than improved permanent structures.

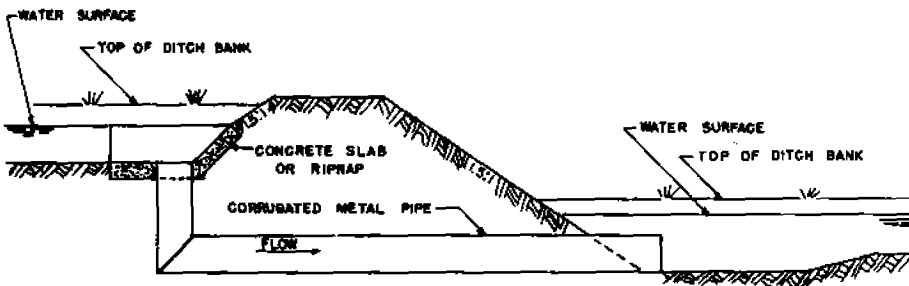

Fig. 42-5. Metal pipe drop structure; in some cases a scour hole may form at the downstream end which may be stabilized by riprap.

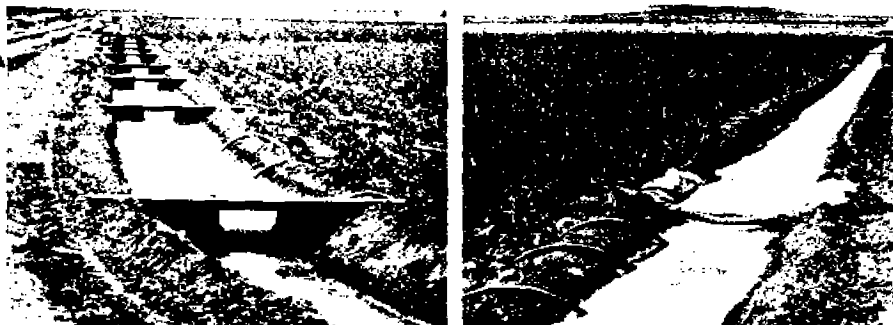

Fig. 42-6. Portable dams and siphon tubes for controlling the flow and delivery of water to the crops.

d. **Automated Structures.** Automatic water level control structures in canals and laterals have been used extensively in Southern Europe and North Africa for many years. Some of the most commonly used structures are described by Thomas (1960). Most of these controls are used to maintain a constant water level in the channel for diversions at turnouts and for water measurement.

Automated water level controls for irrigation on the farm are in the development stage and are currently used only to a very limited extent. Automation of farm water control structures may greatly improve the efficiency of surface irrigation and in particular can reduce the labor requirement considerably. Irrigation systems on many of the larger irrigated farms in the USA are expected to incorporate automatic controls extensively in the near future. At the present time, most automatic structures are of the check type which control the water level in a farm distribution ditch (Fig. 42-7) (Bondurant and Humpherys, 1962). After checking the water level to a raised position for a predetermined time, the automatic gate is released, allowing the water to flow to the next set. Individual furrows or border strips receiving the water must be well graded so they may be irrigated without the farmer's attention.

A timing or sensing device is required to trigger these automatic structures. The energy required to operate the structure itself is usually obtained from the flowing water. Automatic control structures vary from simple alarm-clock-timer

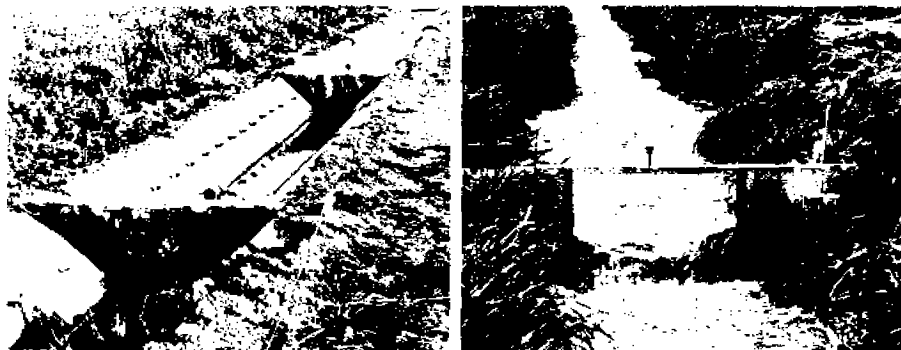

Fig. 42-7. Automatic water control structures for farm ditches.

released checks to elaborate radio and electronically controlled structures with program timers or moisture-sensing devices.

Structures can be classified as fully automatic or semiautomatic. Fully automatic structures usually use sensing devices located in the field or programmed timers to trigger their operation. Other structures are being developed which incorporate the timing means within the structure itself. A fully automatic gate will reset itself after the completion of one irrigation and be ready for the next. Most structures in use at the present time are semiautomatic and require manual resetting between irrigations. They are usually triggered by a mechanical timer.

### 3. DISCHARGE CONTROL

Discharge control devices are used extensively to control distribution of water from a farm ditch into border strips or furrows. However, discharge control frequently consists of dividing the total flow into two or more specific increments rather than controlling the discharge rate. The hydraulic characteristics of some commonly used devices have been determined in field and laboratory studies (Tovey and Myers, 1959).

a. **Turnouts.** A turnout structure may be an opening of fixed dimensions in the side of a ditch or one equipped with check boards, gates, or other devices to adjust the area of the opening. Typical examples of commercially available turnouts are shown in Fig. 42-8. If only a portion of the total flow is to be diverted through a given turnout, a more constant discharge is obtained by using an orifice-type device, such as a gated turnout, instead of an overflow or weir-type structure. When the turnout consists only of a fixed opening, flow regulation is achieved by controlling the water level in the ditch.

b. **Spiles.** Outlets placed in the side of a lined ditch or ditch bank to control the delivery of water to individual furrows or corrugations are called spiles. Individual spiles having adjustable gates are referred to as gated outlets. They are usually placed above the normal water level in a ditch or equalizing bay so the water must be checked before diversion takes place. One of the main advantages in using spiles or gated outlets is that once installed and adjusted, no further adjustment is made during the irrigation season. Thus, after they are installed, the labor requirement is lower than with siphons which must be reset each time or with gated surface pipe which must be moved between irrigation sets.

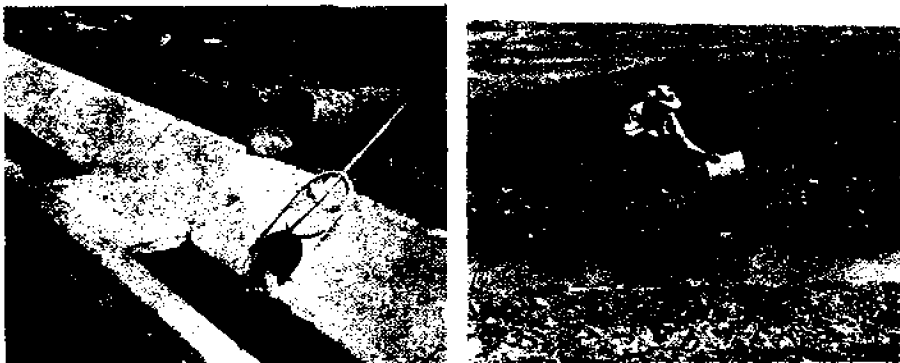

Fig. 42-8. Commonly used turnouts for farm irrigation ditches.

Irrigation with spiles is similar in principle to using gated surface pipe or lay-flat distribution tubing. Discharge from a pipe or tube is controlled by adjustable gates or outlets uniformly spaced along its length corresponding to the furrow or corrugation spacing.

c. **Siphons.** Siphon tubes are widely used to distribute water from the ditch onto a field (Fig. 42-2 and 42-6). They are available commercially in several diameters and lengths and are usually made from plastic or aluminum. They may be obtained in sizes that permit control of streams as small as 4 liters (approximately 1 gal)/min or as large as 56 liters (2 ft<sup>3</sup>)/sec. The larger sizes are usually used to flood border strips or check basins. The use of siphons is normally limited to fields having little cross slope in order to maintain a near-constant operating head on each tube. The discharge depends on tube diameter and length, number and degree of bends, and roughness in addition to the operating head. Siphon-tube discharge is given by the same general equation as that for an orifice, equation [42-2], in which the coefficient of discharge  $C$  has different values. The coefficient for siphons may be evaluated, if the entrance coefficient, the inside diameter of the tube, the roughness coefficient, and the tube length are known (US Department of Agriculture, 1962). With the tube size and head known, the discharge may be obtained from charts (Tovey and Myers, 1959; US Department of Agriculture, 1962). Siphons eliminate cutting the ditch bank, thus reducing labor and ditch maintenance, but they must be primed manually.

d. **Division Boxes.** It is often necessary to divide water from a farm lateral into two or more ditches for distribution to different parts of the farm or to other farms. This may be accomplished with a divisor at the ditch junctions. For accurate flow division, it is best to use measuring structures in each channel. However, if a divisor is used, it should have a long, straight approach channel so that the flow of water approaches it in parallel paths without cross currents. Care must also be taken that downstream conditions do not favor one side or the other. Flow divisions also may be made by dividing the flow as it falls over a control crest (Code, 1961; Thomas, 1960). If the flow is divided by the same user and accurate flow division is not required, two or more regular turnout structures may be used.

e. **Automatic Discharge Control.** Higher water application efficiency may theoretically be obtained if the flow in a furrow is reduced or cut back after the water has reached the end of the field. This technique is seldom employed in practice because of the time required to readjust the individual furrow streams and the difficulty in managing the surplus water which must be used downstream or wasted. Structures and systems are being developed to automatically reduce the flow of water to the furrow after a prescribed time interval (Garton, 1966).

Thomas (1960) describes some automatic discharge control devices used at farm turnouts where they also function as water measuring structures. Other devices and techniques are being developed to control discharge from the farm ditch or lateral onto the field or into another channel. A self-propelled traveling siphon has been used successfully where a large discharge is needed to flood irrigate borders. Self-operating, float-type turn out structures are being developed to control the discharge from a ditch onto the field.

Pneumatically operated and radio controlled valves are also being developed to control the discharge from turnout structures (Haise et al., 1965). These valves



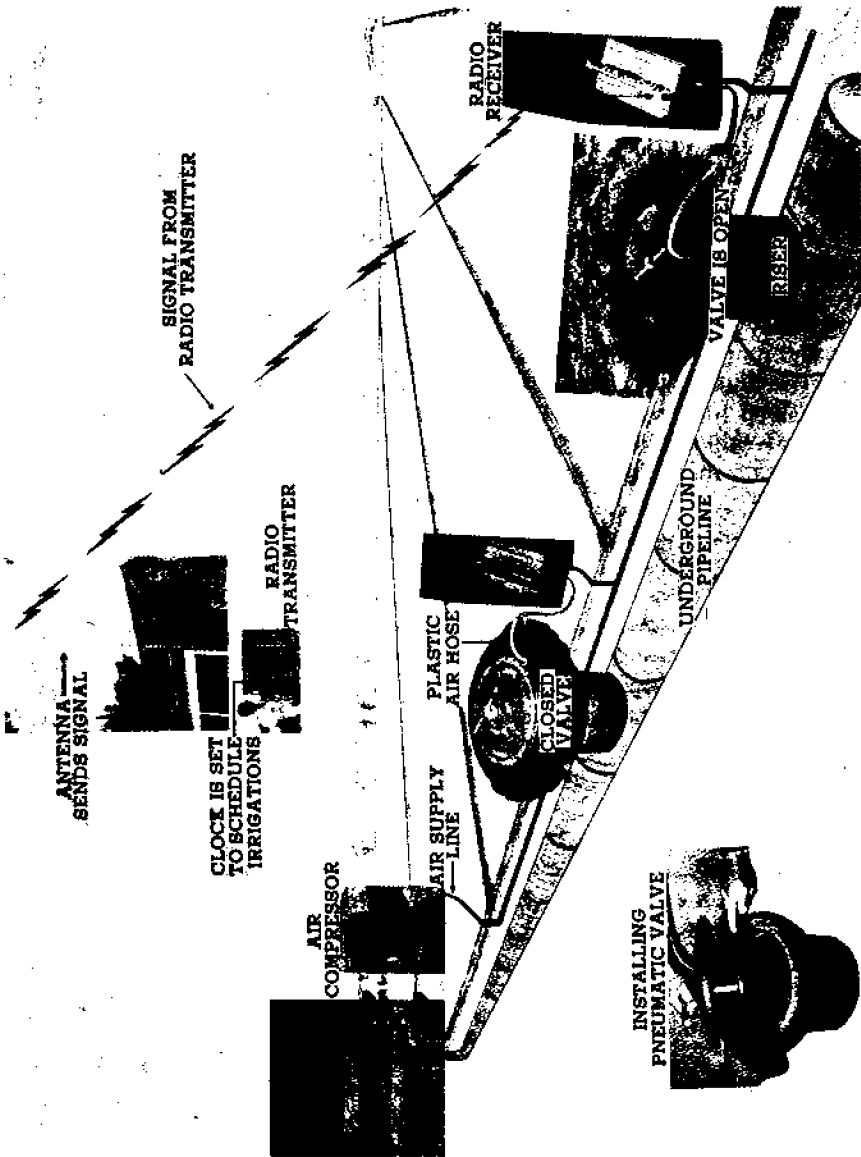

Fig. 42-9a. Radio-controlled pneumatic valves for pipeline distribution.

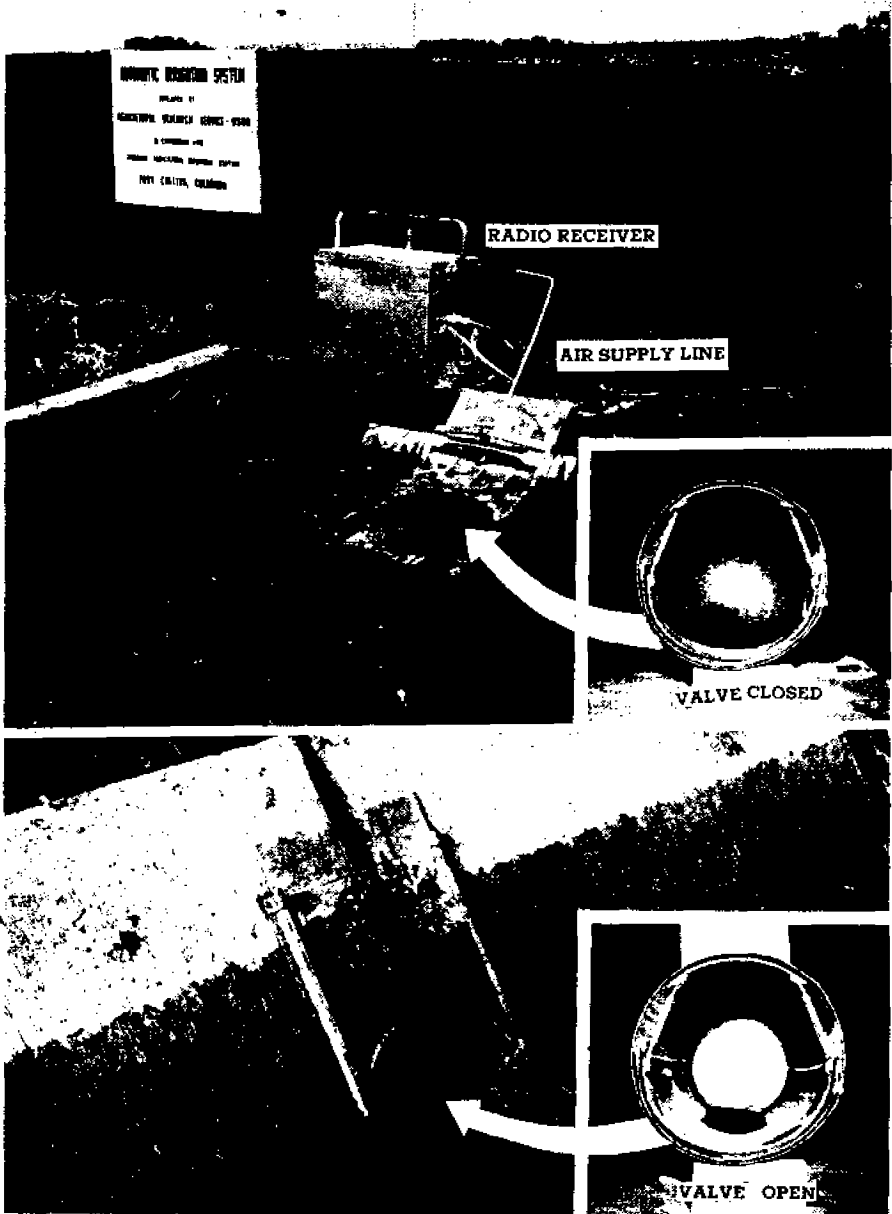

Fig. 42-9b. Radio-controlled pneumatic valves for farm ditch turnouts.

control the discharge from alfalfa-type valves on an underground pipeline system (Fig. 42-9a) or from turnouts in farm ditches (Fig. 42-9b). The pneumatic valve for pipeline distribution systems is essentially an inflatable O-ring which forms an annular seal when inflated between the alfalfa valve seat and valve lid. The lay-flat pneumatic valve for ditch systems is a flat, rectangular tube that inflates to form a closure within the underground portion of the turnout pipe. Inflating and

exhausting of air from the valves are remotely controlled by a signal transmitted by wire or by radio from a centrally located timing device.

#### 4. SEDIMENT, DEBRIS AND WEED SEED CONTROL

Trash, weed seed, and sediment in the flowing water present problems in irrigation systems. This is particularly true for sprinkler irrigation systems where nozzles become plugged with debris or become worn because of sediment in the water. The increased use of pipe, both underground and on the surface, demands that the water be relatively free of sediment. Sediment deposits can plug underground pipelines and partially fill surface pipe making it difficult to move. If gated pipe is used, the gates become plugged with debris and the flow is reduced.

Sediment can be troublesome in farm ditches and can necessitate frequent ditch cleaning. Weed seeds are scattered by flowing water and will germinate even after being in the water for long periods. A good weed seed screening device is an essential part of the weed control program on irrigated farms.

Trash racks are necessary at every pipe and underground crossing entrance to prevent entry of floating debris. In general, these are made of spaced steel bars, either round or flat. With this arrangement, however, it is possible to catch and remove only the largest material. The racks are generally slanted for easier cleaning and should be removable.

a. **Screens and Settling-Boxes.** Over the years, a number of devices and designs have been used for screening irrigation water. In some cases a desilting box and trash screen have been combined into one structure. An example of the latter is shown in a US Department of Agriculture Soil Conservation Service design given

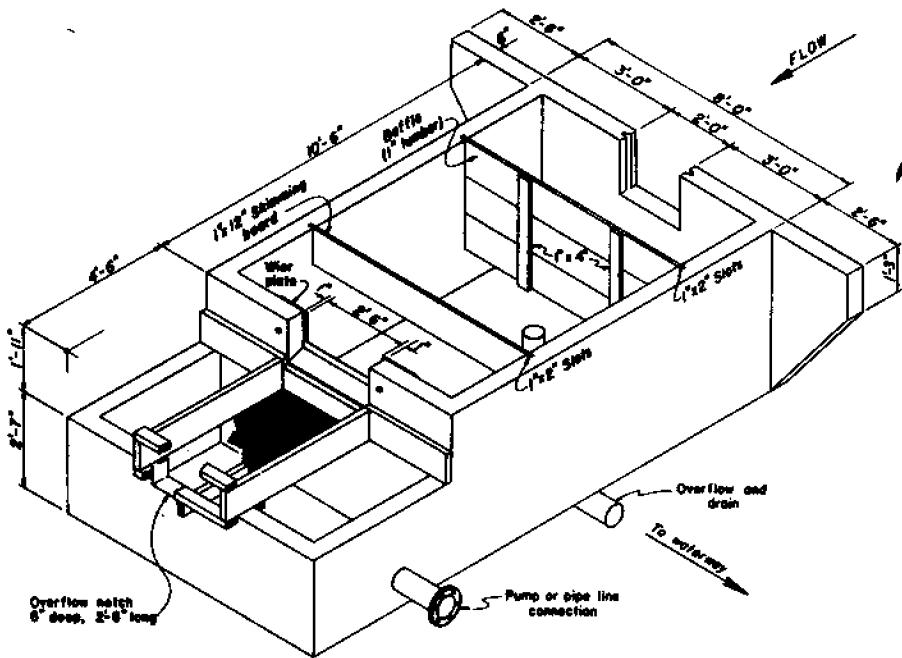

Fig. 42-10. Irrigation water desilting box and trash screen.



Fig. 42-11. Debris screen on an inlet structure to an underground pipeline.

in Fig. 42-10. In this design, provision is made for sediment trapping using a large box which decreases the velocity and, in turn, the transportability of the flow. Provisions are made for flushing this compartment. A second compartment is equipped with a weed screen. An outlet from this compartment discharges into the distribution system. The screen in this design is self cleaning as shown in Fig. 42-11. If desilting is not desired, only the lower section of the structure shown in Fig. 42-10 is needed.

Other types of screens and trash racks for irrigation ditches are described elsewhere (Bergstrom, 1961; Code, 1961; Coulthard et al., 1956). Some of these utilize paddle wheels to power the cleaning mechanism and for screen agitation. When only part of the flow is to be diverted, the screening problem is greatly simplified because a portion of the trash can be floated past the turnout.

**b. Sediment Traps.** Numerous schemes have been used for trapping sediment and silt in irrigation channels. If the sediment consists of silt or fine sand, the usual trapping method consists of increasing the flow area to reduce the velocity to the point where the material settles. An example of a structure with a settling basin was given in the previous section (Fig. 42-10).

When sediment is moving as a bed load of large sand and small gravel, the trapping problem becomes somewhat different. Settling basins will catch the material but frequency and difficulty of cleaning is increased. Numerous schemes and designs for sand traps which dynamically trap and remove the sediment by flowing water have been proposed (Parshall, 1952; Robinson, 1962; Uppal, 1951). The traps sometimes are constructed depressions or boxes in the bed of a canal covered with a grating and dependent on a transverse sluicing action to move the trapped load.

For small canals or channels, a vortex tube sand trap, as shown in Fig. 42-12, can be very effective in removing material  $> 0.5$  mm. Tests have shown that the following items are optimum for operation of the tube:

- 1) The Froude number of flow across the tube section should approximate 0.8.
- 2) The flow usually removed by the tube ranges from 5 to 15% of the total flow.
- 3) Tube shape is not particularly important, and a pipe with a portion of the circumference removed works very well. The width of opening should be about

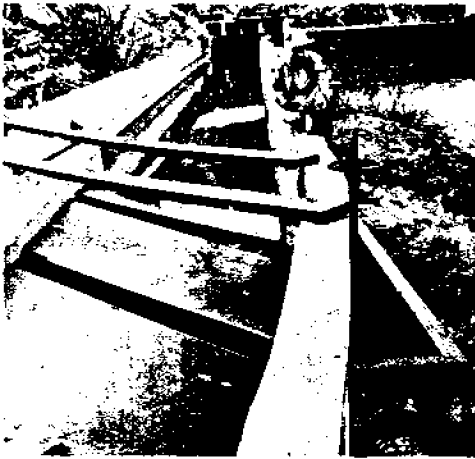

Fig. 42-12. Vortex tube sand trap used to remove sand and gravel from canals.

15 cm (0.5 ft), the length-to-opening-width ratio should not exceed 20, and the tube should be set at an angle of about  $45^\circ$ .

#### 5. ENERGY DISSIPATION

The dissipation of kinetic energy in flowing water to prevent excessive erosion is a problem frequently encountered by the engineer and the farmer in irrigated agriculture. In general, kinetic energy, i.e. energy due to the velocity of the flow, is dissipated either in the vertical or the horizontal direction or both. For vertical dissipation, a jet of water is diffused either vertically downward or upward. The energy is dissipated horizontally by channel resistance, form resistance, or by a hydraulic jump and the resulting increase in piezometric head. Figure 42-13, as presented by Smith (1957) and Fiala and Albertson (1963), shows the different methods of energy dissipation classified according to direction.

Dissipation of energy in the horizontal direction may result from surface roughness and drag on the boundary which causes the velocity to be reduced and the depth to be increased (Fig. 42-13a). In many instances, this principle is used to dissipate excess kinetic energy. However, since the roughness and drag are sometimes not great enough, the banks and bed of the channel become badly eroded. The use of boundary resistance alone requires such a long channel that some other means is usually employed.

The hydraulic jump is a very effective energy dissipator and is widely utilized for this purpose. The Froude number of flows in small canals which require energy dissipation normally lies in the range of 2 to 4. The energy loss resulting from a hydraulic jump in this Froude number range is usually only 10 to 20% of the energy involved. In contrast, hydraulic jumps resulting from high Froude numbers ( $Fr \geq 9.0$ ) may dissipate as much as 85% of the energy. For this reason, a chute, in conjunction with a stilling basin is frequently used to increase the velocity and resulting Froude number of flow.

The distance required to decrease the velocity and dissipate energy in the horizontal can be reduced appreciably, if blocks or sills are used in conjunction with the hydraulic jump as shown in Fig. 42-13b. Since the jump is unstable for variable flows and may move upstream or downstream depending on the dis-

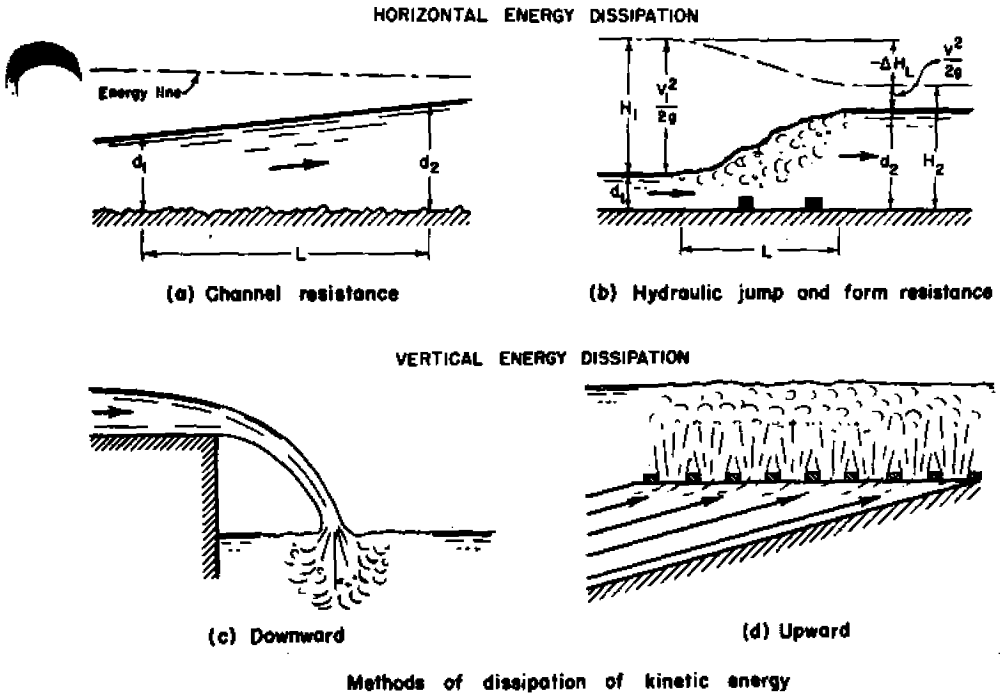

Fig. 42-13. Different methods for dissipation of kinetic energy (from Smith, 1957).

charge, sills or blocks help to stabilize the location. Figure 42-4 shows a standard drop structure where blocks and a sill control the jump.

The dissipation of energy in the vertical direction involves the diffusion of a jet into a pool of water. The jet may be traveling vertically downward as illustrated in Fig. 42-13c and in the common irrigation drop shown in Fig. 42-3. The drop may be equipped with an apron to force the horizontal dissipation of energy (Fig. 42-4) or have a stilling pool as shown in Fig. 42-13c. When a stilling pool is used, special provisions must be made to prevent scour such as maintaining a prescribed depth of water, lining, or armor plating the scour hole with graded riprap material (Smith, 1957). A cantilevered pipe outlet, such as a culvert, is another example of vertical energy dissipation.

A recent development for vertical energy dissipation is the manifold stilling basin (Fiala and Albertson, 1963) illustrated in Fig. 42-13d. Here the flow is upward and the kinetic energy of the jets is dissipated in the depth of tailwater. The manifold device has generally been used on fairly large canals where there is a high velocity inflow to be added to the stream.

**6. DESIGN CRITERIA**

The type and design of water-control structures depends on the type of irrigation system to which they belong. This in turn is determined by many factors such as soil characteristics, water source, crops grown, and climatic factors. In addition to fitting the irrigation system requirements, a structure must also satisfy hydraulic, structural and operational criteria.

A farm structure must be designed with sufficient capacity to maintain adequate freeboard in the ditch and to handle expected variations in the flow. Because of the head-discharge relationships, variations in discharge from a canal or lateral into the farm ditch or from the ditch onto the field will be minimized by using submerged pipe or orifice-type turnouts to control the discharge and overflow-type checks in the lateral or ditch to maintain a nearly constant water level above the turnout. This is particularly important when siphons are used, since large water level variations cause them to lose their prime.

Sufficient cutoff wall and apron length must be provided to prevent piping, erosion, and undermining of the structure. To avoid concentrating the flow in unlined ditches, the crest and apron width of a structure should be approximately the same as that of the ditch bottom. The apron of an energy dissipating structure should be below grade to provide a pool in which to dissipate energy. Energy dissipation structures such as the drop are frequently not entirely effective and create eddy currents, waves, and zones of high velocity flow. Protection of the earth channel against erosion as a result of these factors is usually accomplished using riprap as an armor-plating material. One of the best forms of bank and bed protection is graded, pit run gravels as opposed to commonly used large rocks or broken concrete. In order to take advantage of large riprap, it is necessary to add a graded material with sizes ranging from that of the bed and bank material up to the largest size of riprap.

Uplift, overturning, and sliding must be considered on larger structures. These factors, however, are usually not important with small structures in farm ditches.

In addition to adequate structural strength, the structures must be resistant to exposure. Concrete structures should contain reinforcing steel to strengthen them against the effects of temperature change and frost action. Soil and water chemical concentrations in certain areas are harmful to concrete and a special resistant cement may be required. Certain metal structures may also be subject to chemical attack.

Good control structures must be easy to operate and provide fingertip control. They must be versatile and able to meet changing irrigation water demands. These demands change throughout the season and also from year-to-year because of different cropping practices.

## **B. Water Measurement**

Many flow measurement devices and methods are in use throughout the world (Thomas, 1960). Progress in developing new methods and devices for measurement of flowing water have not kept pace with available instrumentation using electronic and nuclear techniques. Water measurement in open channels is usually only approximate. The need and demand for good, accurate, and adaptable devices are increasing. The expected accuracy of some methods now in use is no better than  $\pm 5$  to 10%, even under the best conditions.

### **1. METHODS AND PRINCIPLES**

Open-channel flow measurement includes all techniques, devices, and methods used to measure flows where a free water surface is involved. Open-channel flow may occur in closed conduits flowing partly full. In general, the flows are turbu-

lent and the boundary surfaces of the conduits are hydraulically rough. Flows heavily laden with sediment and debris occasionally occur. The flow conditions are usually nonsteady and may be nonuniform, resulting in very difficult measurement situations.

Devices and techniques for measurement can be classified as follows: (i) structures which control channel geometry, (ii) instruments which float on, or are immersed in, the flow field, and (iii) techniques which require measurement of the movement or concentration of dispersed material placed in the flow field.

The most universally used and accepted devices are those that control channel geometry. These usually employ the concept of critical depth where flow passes through a point of minimum specific energy within a defined cross section. This method of measurement includes the weirs, both sharp and broad crested, and suppressed or fully contracted. The weir may be the crest of a dam, diversion structure, or ditch check where there is a definite relation between depth and discharge. However, it is generally considered as a specially constructed device having a metal blade with sharp edge and carefully controlled approach conditions.

The measuring flume also employs an open channel constriction. Flumes are used throughout the world and are more commonly called Venturi flumes, standing wave flumes, critical depth flumes, or Parshall measuring flumes. In the USA, Parshall flumes are used in canals almost exclusively. In general, they operate as critical depth devices, but are capable of measurement under conditions where the flow does not go through critical depth. In this case the accuracy is not as great, but a measurement can be made. Rating sections, meter gates, and measuring gates are other examples of structures for flow measurement which control the channel geometry.

There are many devices which float on or are immersed in the flow field for the purpose of measurement such as current meters employing rotating wheels or propellers. The Dethridge meter, widely used in Australia, uses a rotating drum. Surface floats and floating screens are used to estimate the amount of flow. The displacement or drag on a body as a function of the velocity has been used. Examples include deflection vane meters (Robinson, 1963) and deflection wire-strain gauge devices (Sharp, 1964). These devices show promise in the development of new, improved instrumentation. Devices used to determine the velocity by measuring the velocity head include the pitot tube, static tube, and velocity head rods.

The movement, dispersion, and dilution of material in the flowing water can be related to discharge. The amount of dispersion or dilution is measured, using radiation detectors or fluorometric methods. The method using dyes is safe and results are promising from the standpoint of accuracy.

## 2. DEVICES

a. **Weirs.** The weir is probably the most common device used for water measurement in ditches. With proper installation and maintenance it gives accurate results (Parshall, 1950; US Bur. Reclam., 1953; US Dep. Agr., 1962). The rectangular weir, as shown in Fig. 42-14 is widely used and can be made of wood, steel or canvas with a steel blade. A weir of this type can also be used as a combination drop for the ditch. In the USA, weirs are usually in widths of 1, 1.5, 2, and 3 ft for which rating tables are available. A prescribed distance must



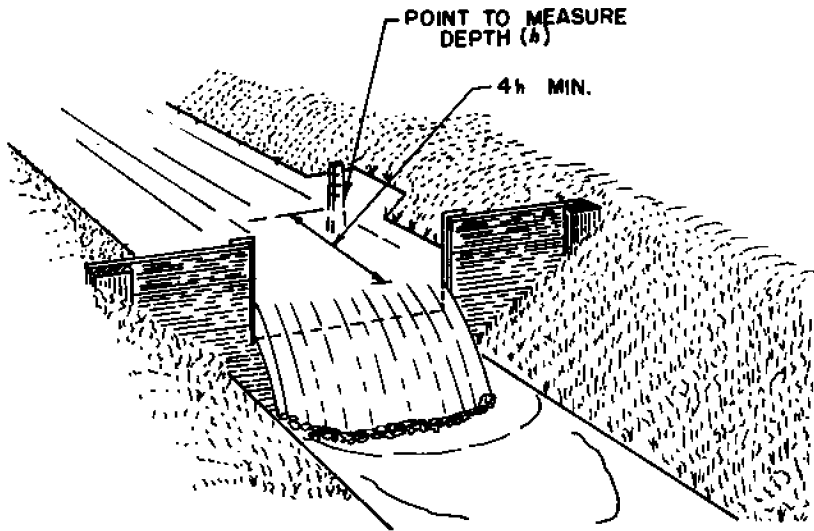

Fig. 42-14. Rectangular weir can be used as a combination measuring device and drop structure.

be maintained between the top of the weir blade and the bottom of the ditch and between the sides of the opening and the ditch banks. Only the depth of water over the weir crest, measured upstream from the weir, and a table are needed to determine the discharge. The depth is usually measured as indicated in Fig. 42-14 or can be made to one side of the weir on the bulkhead but at some distance from the opening. A graduated scale can be fastened at either location with its zero at the crest elevation so that a direct reading of depth can be made.

The 90° V-notch weir is shown in Fig. 42-15. It will measure low flows very accurately and will handle a large range of flows. The weir is easy to construct and install with the aid of a carpenter's square and level.

Another type of weir which has been widely used is the Cipolletti weir shown in Fig. 42-16. This type of weir combines some of the features of the rectangular and V-notch types. A combination headgate and measuring device using the Cipolletti weir is being used successfully in some areas. The height of weir blade in this case is controlled by a hand wheel and the head is measured by a stick held on the crest or a staff gauge mounted on the weir blade.

Any constructed barrier in an open channel over which flow takes place serves as a control and has a fixed relation between head and discharge, if upstream or downstream conditions do not interfere or change. The geometry of the barrier determines both the coefficient of discharge and the exponent in equation [42-1]. Values of the coefficient  $C$  and exponent  $n$  vary with the type of weir. For the rectangular weir where the width of flow section remains constant,  $n = 1.5$ . For other weirs where the nappe width and shape changes with depth, the exponent varies. For a triangular weir,  $n$  is 2.5, for a parabolic weir, 2.0, and for a Sutro weir, 1.0 (Rouse, 1950).

In all cases when using a weir, the blade should be fairly sharp on the upstream edge. The downstream water surface should be below the level of the blade, if

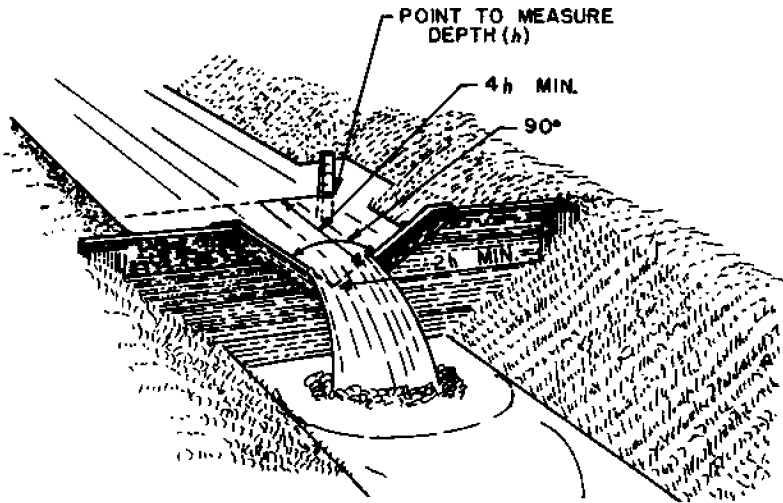

Fig. 42-15. V-notch weir is used for accurate measurement over a large range of flows.

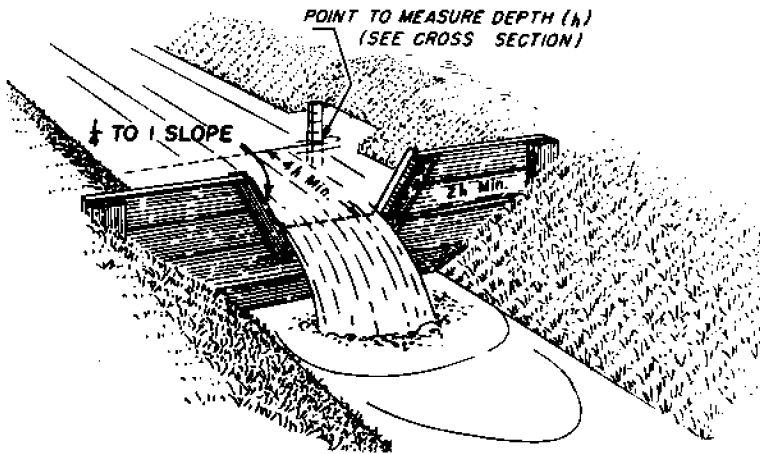

Fig. 42-16. Cipolletti or trapezoidal-notch weir.

a good measurement is to be obtained. It is necessary that a pond of water be formed upstream from the weir. With a properly installed weir, the accuracy of measurement should be  $\pm 2\%$ . However, because of deposition in the upstream pool, misalignment of weir blade, and inaccurate measurement of the head over the weir, discharge errors up to 10 to 15% are possible (Thomas, 1959). In general, this error is positive so that more flow is passing the weir than the measurement indicates.

b. **Flumes.** The Parshall flume, shown in Fig. 42-17, is widely used for measuring flows in ditches and canals. In contrast to the weir where there must be an appreciable drop between the upstream and downstream water surface, the Parshall flume will measure accurately when there is very little difference in

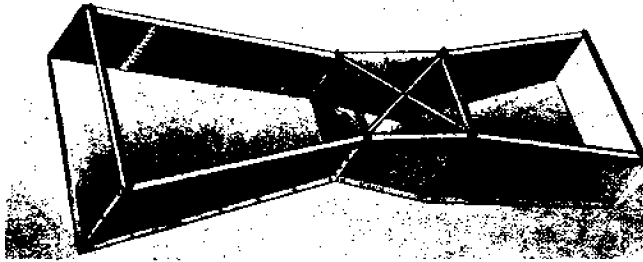

Fig. 42-17. Parshall measuring flumes are commercially available or can be constructed for a large range of discharges.

these levels. One advantage in using a flume is that less head loss is required. This is particularly important for canals on very flat slopes. The device is self cleaning so that it will not silt up as easily as a weir. It can be readily constructed of sheet metal or concrete. Plans and calibrations are available for widths ranging from 1 inch to 50 ft and for flows from 0.01 to 3300 ft<sup>3</sup>/sec (Parshall, 1950, 1953; Robinson, 1957).

The discharge equation for the Parshall measuring flume is

$$Q = Cbh^n \quad [42-3]$$

where  $b$  is throat width  $L$ , and  $h$  is depth of flow at specified locations  $L$ . Values for  $C$  and  $n$  given in Table 42-1 have been determined experimentally (Davis, 1963).

The accuracy of measurement when using a Parshall flume should be within  $\pm 3\%$ . However, errors in measurement due to faulty construction, installation, or operation can approach  $\pm 10\%$ . Probably the most common source of error is in using the free-flow discharge table when the flume is obviously operating under submergence. Errors of  $-25\%$  or more can be made in this case.

A different type of measuring flume has recently received renewed attention and has some advantages over the rectangular types. This is the trapezoidal flume which has side walls that are sloping rather than vertical. An advantage is that a much larger range of flows can be passed by the structure without backing up the water as much as with a rectangular flume. It will also give an accurate measurement with a smaller difference in the upstream and downstream

Table 42-1. Values of coefficient  $C$  and exponent  $n$  for Parshall measuring flumes

Flume size		
$b$	$C$	$n$
1 inch	4.06	1.55
2 inches	4.06	1.55
3 inches	3.97	1.547
6 inches	4.12	1.580
9 inches	4.09	1.530
1 ft to 8 ft	4.00	1.522b <sup>0.026</sup>
10 ft to 50 ft	$3.69 + \frac{2.50}{b}$	1.60

water surfaces. The general shape of the flume fits the common ditch shape better, particularly when used in a lined ditch with sloping side walls. Designs and ratings are available for flumes with different widths and side wall slopes (Robinson and Chamberlain, 1960; and Robinson, 1966).

Recording instruments are available for use on flumes for a continuous record of water depth. These are simple to install and are needed where the amount of flow in a ditch varies over short periods of time. When using a recorder, the record for all irrigations over a period of years can be maintained by simply filing the charts.

c. **Miscellaneous Devices.** Numerous other devices are used to measure water flow. Some of these are grouped and briefly described below.

1. **Current Meters.** Small meters are available which consist of a revolving wheel or propeller to measure the velocity of flowing water (US Bureau of Reclamation, 1953). Besides being used to measure flow in open channels they also can be used to measure the flow discharging from pipe. Current meter measurements are normally made only by those who are trained in this line of work. With practice and care, the accuracy can be within  $\pm 3\%$ .

Fig. 42-18. Vane meter for measuring flow where the discharge is given directly on the mounted scale.



2. **Vane Meters.** A measuring device recently developed and commercially available gives the amount of flow as a direct reading (Robinson, 1963). This device, shown in Fig. 42-18 consists of a vane suspended into the flow and mounted in a section of prescribed size and shape. Flowing water deflects the vane to various degrees depending on the velocity and depth of flow. The amount of flow is read directly from a scale opposite an indicator mounted on the meter. This device is still being improved and at the present time appears to measure within  $\pm 5\%$  accuracy.

3. **Orifices.** There are two general types of orifices which have found limited use in the measurement of irrigation water. These are orifices with fixed dimensions and those with adjustable openings. The discharge from orifices with a fixed opening is determined from the opening area and the depth of water above the center of the opening when the downstream water surface is below the opening. If the downstream water surface is above the opening, the head is the difference in elevation between the upstream and downstream water surfaces. Plans and calibration curves are available for various sizes of fixed orifices (US Bur. Reclam., 1953; US Dep. Agr., 1962). The discharge equation for an orifice is given by equation [42-2].

In certain irrigated sections, a combination headgate and measuring orifice is sometimes used. One design developed by the U. S. Bureau of Reclamation is

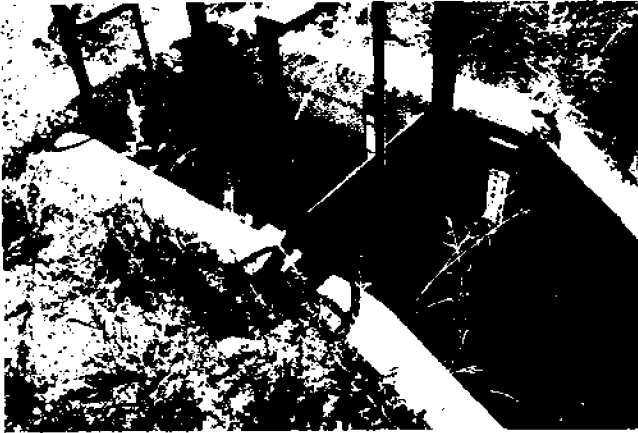

Fig. 42-19. The constant-head orifice utilizes two gates and a constant difference in head across the measuring gate.

called the constant-head orifice turnout (Fig. 42-19). This design utilizes two gates; one for amount of opening, and the other for adjustment of head. The operating procedure is to adjust the gates so that a constant difference in head of 0.2 ft is maintained across the upstream gate (US Bureau of Reclamation, 1953). Recently, tests have been made on the constant-head orifice to evaluate some of the problems encountered in the field (Kruse, 1965). The tests considered such factors as: shape of approach section, velocity of the canal flow, clogging by debris, sediment deposits, and accuracy of head difference determination with widely fluctuating water surfaces. The structure provided reasonably accurate measurement of discharge under most operating conditions. However, when the gate opening was obstructed with weeds, discharges were much less than indicated by the calibration curve. For large discharges, the staff gauges furnished erratic indications of the differential head on the orifice gate because of fluctuating water surfaces.

4. *Adjustable Gates.* Headgates are available that control and measure the amount of water being passed. Installation instructions and calibrations are available for a variety of sizes. Two measurements are necessary in finding the discharge: the amount of gate opening and the difference in head across the gate. With these two measurements, one may use tables or curves supplied by the manufacturer of the gate to find the discharge.

Another adjustable gate discussed in the previous section on weirs, utilizes a standard weir, usually of the Cipolletti type, which is mounted to slide up or down with the adjustment of a handwheel. The gate then becomes a combination turnout and measuring device. These have been used to a limited extent by the US Bureau of Reclamation.

5. *Commercial Meters.* A measuring device used with irrigation turnouts is shown in Fig. 42-20. This device utilizes a propeller connected to a dial which records the total amount and rate of flow. The meter can either be used in closed pipe systems or adapted for measurement in canals using a structure such as shown in Fig. 42-20.

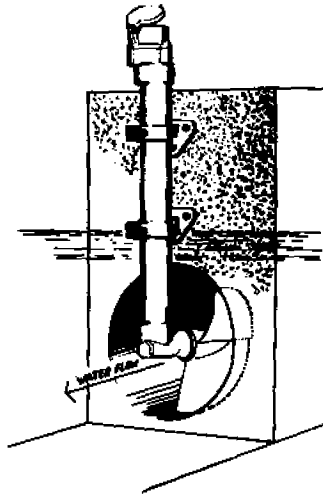

Fig. 42-20. Propeller-type meter which can be installed on the outlet of a farm turnout.

### 3. SOURCES OF ERROR IN MEASUREMENT

There are a number of sources of error in using weirs, flumes and other devices for flow measurement (Thomas, 1959). The most common sources are:

- 1) Faulty fabrication or construction
  - a) Standard dimensions not maintained
  - b) Assembly errors
- 2) Incorrect setting and improper maintenance
  - a) Transverse slope
  - b) Weir blade not vertical
  - c) Weir blade edge becoming rounded
- 3) Incorrect head reading
  - a) Error in gauge location and setting
  - b) Gate marks obliterated
  - c) Fluctuation in water surface making reading difficult
  - d) Ignoring submerged condition
- 4) Nonstandard approach conditions
  - a) Velocity of approach flow higher than specified
  - b) Existence of excessive turbulence and surges
  - c) Devices placed immediately below a bend
- 5) Nonstandard downstream conditions
  - a) Inadequate aeration of nappe
  - b) Excessive submergence
- 6) Others
  - a) Obstruction of device with debris
  - b) Weeds, moss and other vegetation growing in, near or on the device
  - c) Poor measurement of gate or orifice opening.

## II. CLOSED SYSTEMS

Closed systems are those in which irrigation water is conveyed and distributed with pipelines. They may be operated under high or low pressure. Most high-pressure systems are used for sprinkler irrigation. Special equipment is required for pipelines operating under high pressure. This is available only through commercial sources and is normally provided by the pipeline contractor. Therefore, the following section will be concerned primarily with control structures for low-pressure systems.

### A. Water Control

Irrigation pipeline systems provide an efficient means for conveying and distributing water on the farm. In these systems, water is usually conveyed by underground pipe from a well or other source to points on the farm where it is distributed into the field or into other pipeline laterals. Water distribution onto the field is made from valves, gates, gated surface pipe or lay-flat tubing attached to vertical risers from the pipeline. Because of the high initial cost, at present these systems are generally used with crops having a relatively high economic return or where water costs are high. Underground pipe distribution systems offer many advantages such as minimum seepage and evaporation losses, no loss of productive land occupied by ditches, good control of irrigation water, better weed control by elimination of ditch banks, ease of distribution on rough land, and minimum maintenance.

#### 1. PROBLEMS AND PRINCIPLES INVOLVED

Nonreinforced concrete pipe is used extensively in irrigation pipeline systems. However, steel, asbestos-cement, plastic, and vitrified clays are also used. The latter three types are often better adapted for certain soil and water conditions that are unfavorable to either concrete or steel. Concrete is generally not recommended for use in saline or alkali soils that have a high water table. Most systems normally operate at heads less than 5 m (approximately 15 ft). If the pressure head exceeds 6.5 m (20 ft), reinforced concrete, steel or other pressure pipe must be used. Because of past failures, concrete pipe 45 cm (18 inches) and larger in diameter on US Bureau of Reclamation systems, is reinforced. Mortared tongue and groove joints on concrete pipe have been extensively used in the past, but improved rubber gasket joints are preferred. These offer a more flexible, leak-proof joint with less flow resistance. Nonreinforced, monolithic, cast-in-place concrete pipe is also used extensively in some areas of the USA. This type is limited to maximum operating heads ranging from 3 to 4.5 m (10 to 15 ft) and is most competitive economically in the 60- to 120-cm diameter (24- to 48-inch) range. Since most low-pressure irrigation pipeline systems use nonreinforced concrete, the principal emphasis in the following discussion will be on this type.

The fundamental principles for the design, installation and operation of underground pipe irrigation systems have been established (Amer. Soc. Agr. Eng., 1964; Pillsbury, 1952; Portland Cement Association, 1952). A number of problems are encountered in the design and operation of the system. Proper installation

criteria must be followed to provide satisfactory performance with minimum maintenance. This includes following depth standards to protect pipe from traffic and frost action and adhering to bedding and alignment procedures. Unsteady flow caused by surging is often an operational problem encountered. The hydraulic gradient throughout the system must be controlled and maintained above minimum requirements. This is accomplished by providing stands and other control structures in the system. Concrete pipe is sensitive to stresses created by wetting, drying, differential drying of the shell, temperature changes, and water hammer. The system should be so operated as to minimize these stresses. Thermal contraction and expansion may be caused by soil, water and air temperature variations. Cold water should be turned into the line very slowly to allow the line to adjust gradually to the temperature change. Gates, valves, and covers should be kept closed when not in use to extend their life and to prevent cold air from entering the line. Sulfate fertilizer should not be applied in irrigation water through concrete pipelines. Other fertilizers may be applied, but special precautions are required for some (Pillsbury, 1952).

a. **Energy Loss.** Energy losses must be accurately determined in designing the system to maintain the hydraulic gradient at the desired field delivery elevation. These losses are classified as either friction or minor losses. In long lengths of pipe the major loss is due to friction; however, the principal loss in short lengths may be due to minor losses.

1. **Friction Loss.** Laminar flow is rarely encountered in irrigation pipelines. Under normal conditions the flow is turbulent, and the flow resistance depends on conduit roughness, velocity, viscosity and density of water, and on the length and cross section of the conduit. Conduit roughness becomes important in turbulent flow because the laminar boundary layer no longer covers the roughness elements on the inside surface of a rough pipe. When these elements project through the laminar sublayer the flow resistance increases.

A number of formulas have been developed to determine friction losses and velocity in pipes with turbulent flow. These relate loss of head to velocity with empirically determined coefficients. Of those used, the Darcy-Weisbach is the most rational and theoretically correct and includes the effects of temperature and viscosity variations. It is more accurate over a wider range of flows, pipe sizes and types than other formulas. The head loss in this form is expressed as

$$h_f = f(L/D)(V^2/2g) \quad [42-4]$$

where

$h_f$  = friction head loss,  $L$ ,

$f$  = friction factor,

$L$  = length of conduit,  $L$ ,

$D$  = inside diameter of conduit,  $L$ ,

$V$  = mean velocity of water in the pipe,  $L/T$ , and

$g$  = acceleration of gravity,  $L/T^2$ .

The friction factor is determined from graphs relating  $f$  to Reynolds number (King, 1954).

A further advantage of this formula is that it is dimensionally homogeneous and appears in the same form in metric units as in English units. The friction



coefficient  $f$  and Reynolds number are dimensionless and their numerical values are independent of the system used.

The Manning equation is used internationally for solving pipe flow problems. When used for pipe, the conventional form of the equation is modified by substituting  $D/4$  for the hydraulic radius. This form for pipes in English units is

$$V = (0.590/n) D^{2/3} S^{1/2} \quad [42-5]$$

In metric units it is expressed in the form

$$V = (0.397/n) D^{2/3} S^{1/2} \quad [42-6]$$

where  $n$  is the roughness coefficient and  $S$  is the friction slope. Other terms have the same notation as previously given. The same value of  $n$  may be used in both systems of units. Tabulated values of  $n$  for various pipes are given by King (1954).

Another widely used formula for solving pipe flow problems is the Hazen-Williams formula

$$V = 1.32 C_1 R^{0.63} S^{0.54} \quad [42-7]$$

where  $C_1$  is the Hazen-Williams discharge coefficient (Davis, 1952 and King, 1954) and  $R$  is the hydraulic radius which for pipes is  $D/4$ .

One of the most widely used formulas for computing flow in concrete irrigation pipelines is the Scobey formula

$$V = C_s H_f^{0.5} d_1^{0.625} \quad [42-8]$$

where

$C_s$  = Scobey's roughness coefficient which varies from 0.267 to 0.37 (Davis, 1952)

$H_f$  = loss of head/1,000 lineal feet of pipeline, and

$d_1$  = inside pipe diameter in inches.

The latter two equations are expressed in English units and are not dimensionally homogeneous. Therefore, the coefficients are not dimensionless and commonly used values of  $C_1$  and  $C_s$  are valid only when the formulas are used in the English system of units.

2. *Minor Losses.* Minor energy losses are due to entrance, bends, fittings, obstructions, contractions, and enlargements. These are expressed as

$$h = K(V^2/2g) \quad [42-9]$$

where  $h$  is the head loss and  $K$  is a loss coefficient determined experimentally for the type of bend or obstruction under consideration. The total minor loss is the sum of the individual losses. Loss coefficients for various conditions are presented in hydraulic handbooks (King, 1954).

In an underground pipe irrigation system, losses in risers and distributing hydrants must also be considered. Losses in gated surface pipe and lay-flat tubing must be included when these are used to distribute water from the hydrant.

b. *Flow Capacity.* The capacity of the system is determined by the pipe size and available grade or difference in head between the upper and lower end of the pipe. Assuring adequate capacity is very important, particularly in a gravity feed system. If the system is fed from a pump, the head may be increased to

provide sufficient capacity. However, to increase the capacity of a gravity feed system once it is installed is very difficult. If the available grade is insufficient to offset the energy losses in a system having the largest practical size pipe, it may be necessary to use a booster pump in the system design. A common standard is to design the system with the hydraulic gradient 30 to 60 cm (1 to 2 ft) above the ground surface at the discharging hydrant. To assure adequate capacity, care must be taken to maintain proper alignment, clean joints, and avoid any practice which would result in higher loss coefficients than were used in the design.

c. **Air Entrainment.** Air entrainment is often a problem in the operation of a pipeline system. Air may be entrained in the water at the pump, at a gravity inlet, or in an overflow stand. Air carried into the pipeline tends to collect in pockets at high points and breaks in grade, and reduces the carrying capacity of the pipe. Accumulations of entrained air cause surging and unsteady flow conditions and may contribute to the development of excessive pressures.

#### d. Hydraulic Transients.

1. **Surge.** Surge in a pipeline is usually caused by the sudden release of entrapped air from the line. High pressures are not usually encountered in surging. However, the sudden release of large volumes of air may start the process of shock wave generation when the two water surfaces collide. Minor flow fluctuations in the overflow of a pipe stand may initiate surging when amplified in passing through successive stands.

2. **Water Hammer.** Water hammer results from the sudden stopping of flow in the pipe. This may occur if a valve is closed too rapidly. When this occurs, the kinetic energy of the moving fluid is transformed into pressure energy, generating a pressure wave that oscillates back and forth in the pipe until damped. In actual operation, this is not usually a problem since most systems are fitted with slow-closing, screw-type valves. It is important for this reason, that slow-closing valves be used in the line.

### STRUCTURES

Special structures are used to provide the necessary water control and to alleviate some of the problems peculiar to this type system. Local conditions may dictate the type of metal used in the structures. Steel fittings may corrode in some waters, requiring the use of cast iron, bronze or brass.

a. **Inlet.** Water may enter a pipeline by gravity from a ditch or it may be pumped from a well or stream. Inlet structures are needed to protect the system from excessive pressures, to minimize air entrainment, and to develop the full flow capacity. They also may be designed to serve other functions of stands such as trapping trash and sediment or controlling flow into laterals.

1. **Pump Stands.** Pump stands are installed to receive water from a pump and convey it into the pipeline. They are open topped and usually larger in diameter than the pipeline. This allows the stand to act as a surge chamber and entrained air to escape because of a reduced water velocity. They are built high enough to develop the head needed and to provide sufficient freeboard without overflowing except when unusual pressures occur. A typical stand is shown in Fig. 42-21. If an unusually high stand is required, it is capped and a smaller diameter steel pipe is extended to the necessary height. A flexible coupling is put in the

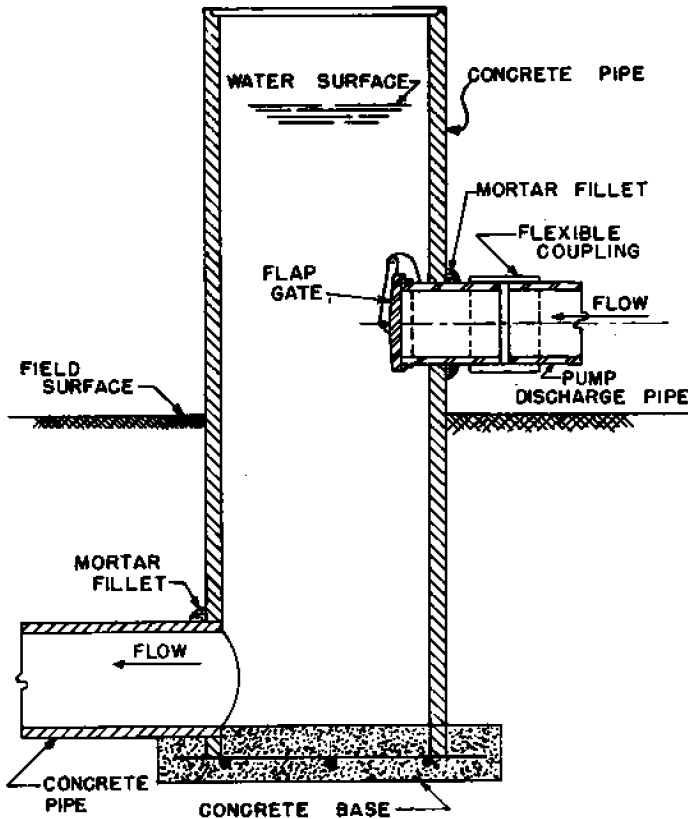

Fig. 42-21. Typical concrete pump stand: The flexible coupling is needed to absorb vibrations from the pump; the flap gate prevents backflow to the pump.

line between the pump and stand to isolate the stand and pipe system from pump vibration.

2. *Gravity Inlet.* When water enters the pipeline from an open ditch, structures such as those shown in Fig. 42-11 and 42-22 are used. They may be concrete block stands or constructed of concrete pipe sections set vertical. They should be equipped with a guard to keep trash out of the line and the top of the stand should be fitted with a cover to prevent accidents and wind-blown trash accumulation.

b. *Pressure and Flow Control.* Control structures are needed to maintain delivery water levels, to regulate the flow into branching lines, to limit pipe pressures, and to provide for the removal of entrained air.

1. *Gate Stands.* Gate stands are diversion structures to control the flow into laterals. They are also used to increase the pressure upstream, to prevent high pressures, and to act as air vents and surge chambers. The gates are often used to control pressures as required by upstream outlets. A single structure is often built to function as a gate stand and as an overflow stand as shown in Fig. 42-23.

2. *Overflow Stands.* These serve both as check and drop structures in addition to other functions of a stand. As a check, the stand regulates upstream pressures to maintain uniform flow from outlets or into laterals. As a drop, it limits the

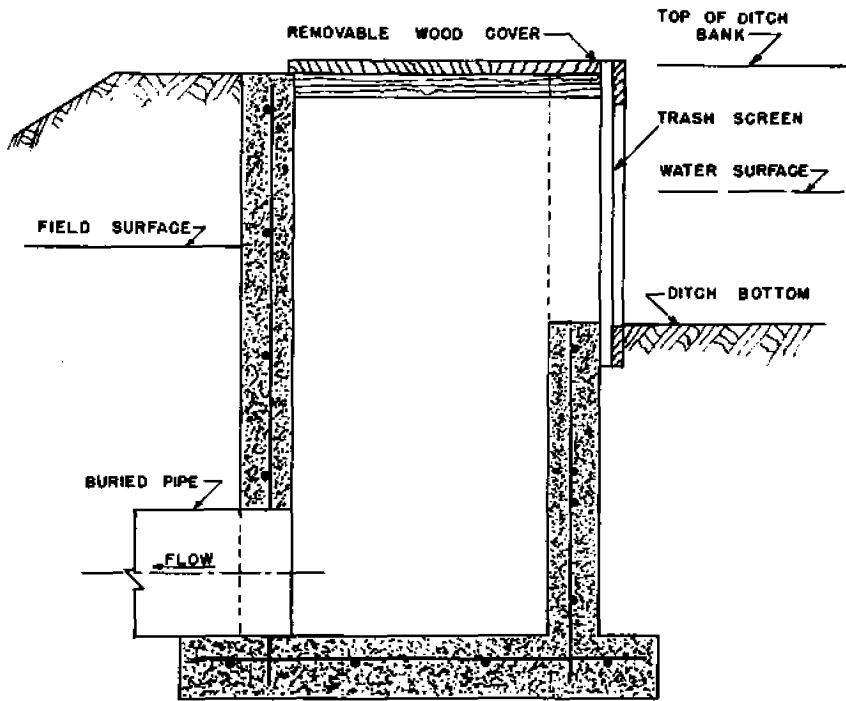

Fig. 42-22. An inlet stand for taking water by gravity from a ditch into an underground pipeline.

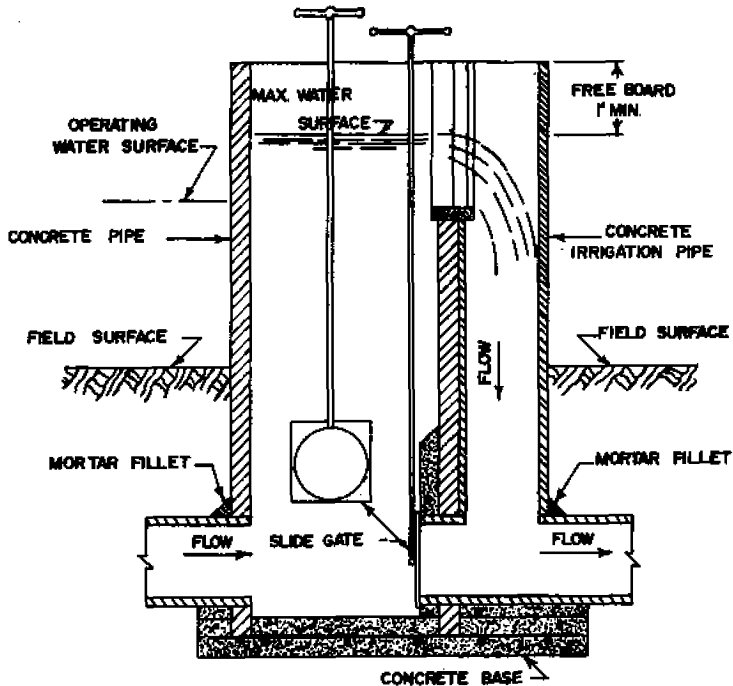

Fig. 42-23. Combination gate and overflow stand used for regulating upstream pressures and diverting water into other pipeline laterals.

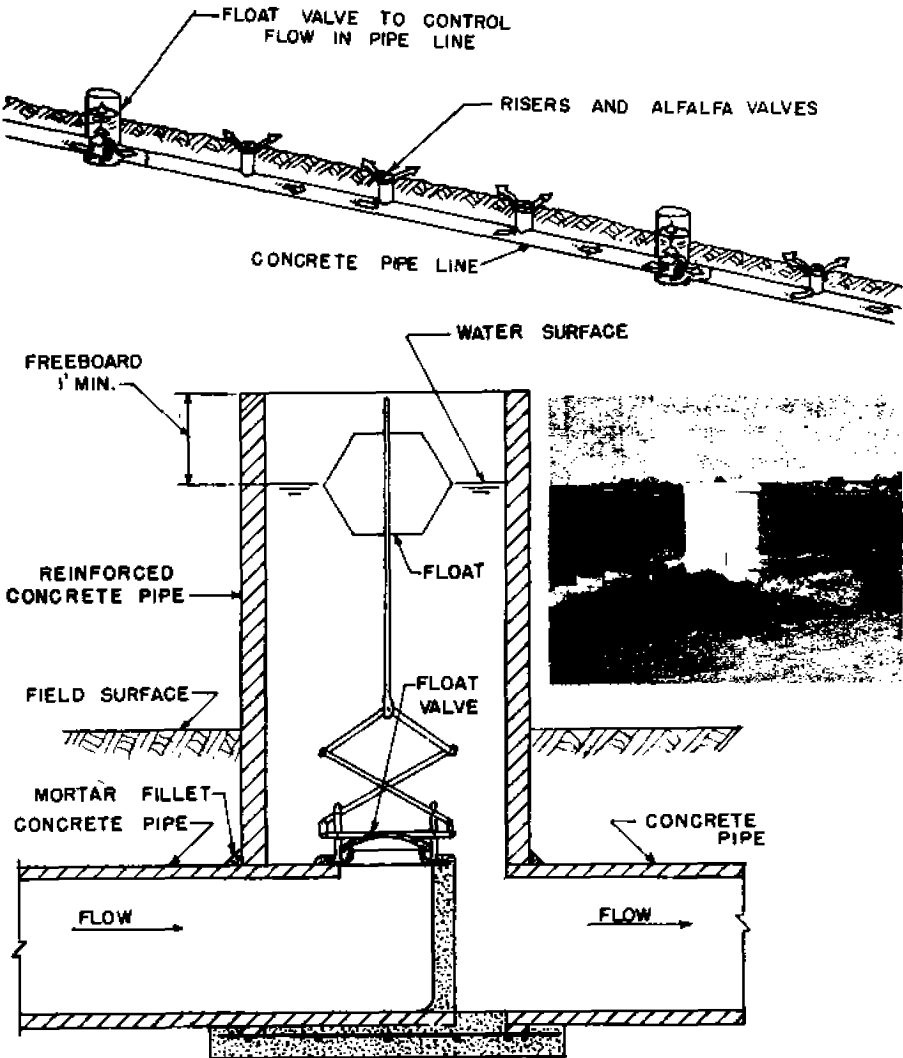

Fig. 42-24. Float valve stand; pressure and flow in the line are automatically regulated by the float valve.

excess head developed by the natural slope. It may be used with or without the side turnout shown in Fig. 42-23. It has the disadvantage that air is often entrained in the water as it spills from the overflow baffle. To minimize this, a gate is installed between the two chambers which is normally open. When pressure is needed for upstream diversion, the gate is closed sufficiently to bring the water level to the crest with only a small overflow. An overflow stand usually is not needed in areas of flat or very slight slopes.

3. *Float Valve Stands.* It is advantageous on steep slopes to install a semiclosed system with float valve stands as shown in Fig. 42-24. The float valves open when the downstream pressure falls to a predetermined level and admit into the

line only as much flow as can be released by the hydrants that are open. Thus, each valve automatically controls pressure in the reach of pipe downstream from it. When a pipeline is served directly from storage, float valves provide full control of the water from the lower end of the line. High overflow stands on steep slopes may be eliminated by using float valves. A semiclosed system is efficient, since surplus water is not wasted at the end of the line as it is sometimes done when overflow stands are used. Tables giving head loss for various size and types of valves at different openings are useful in selecting the proper valve (Pillsbury, 1952).

4. *Line Gate Valves.* Line gates in each lateral are sometimes substituted for gate stands. These valves are regular gate valves with special hubs that are mortared directly into the line. They permit operation from the ground rather than from the stand top. The present trend is toward increased use of line gate valves with adjacent small diameter, capped vent stands instead of large gate stands. Friction losses in wide, open gate valves are low and are often expressed as equivalent lengths of straight pipe (Pillsbury, 1952).

c. *Discharge Control.* Outlets are necessary to deliver water from the pipeline to the land surface or into some distributing device. They consist of risers built of vertical sections of pipe into which valves or gates are installed to control discharge.

1. *Valves.* Valves are used to distribute water directly into border strips, basins or ditches where relatively large flows are needed. Two general types are used in the USA, alfalfa valves and orchard valves. Alfalfa valves are normally grouted to the top of a pipe riser as shown in Fig. 42-25. This is referred to as an alfalfa valve hydrant. Orchard valves are smaller than alfalfa valves and are used where smaller flows are acceptable. They are usually installed inside the riser as shown in Fig. 42-26. Since water usually flows from an orchard valve with lower velocities, they are commonly used in place of alfalfa valves where erosion is a problem or where the pressure in the riser is extra high.

Portable hydrants and sheet metal stands may fit over the valves for water delivery into surface pipe or ditches. The hydrants are constructed so that the valves may be regulated with the hydrant in place. Gated surface pipe or tubing may be attached to the hydrant from which water is distributed to furrows or corrugations (Fig. 42-27). Sheet metal stands are sometimes fitted with multiple-connections so that one stand may serve several surface pipes individually or simultaneously.

Flow from alfalfa and orchard valves may be determined from equation [42-2] in which the normal value of the discharge coefficient  $C$  for alfalfa valves is 0.7 and for orchard valves 0.6. The head  $h$  represents the vertical distance between the water surface above the valve and the hydraulic grade line. The recommended height of the hydraulic gradient above the ground for minimum erosion is 30 cm (1 ft). If 15 cm (0.5 ft) of ponding over the valve is assumed, the head loss through the valve would be 15 cm (0.5 ft). Maximum recommended design capacities for different size valves have been tabulated (Pillsbury, 1952).

2. *Pot Hydrants.* There are several types of distributing hydrants, two of which are the alfalfa and orchard type where the water flows from the top of the riser. Another, used for furrow irrigation, consists of a riser pipe extending to the ground level with a larger pipe, called a pot, fitted over it as shown in Fig. 42-28.

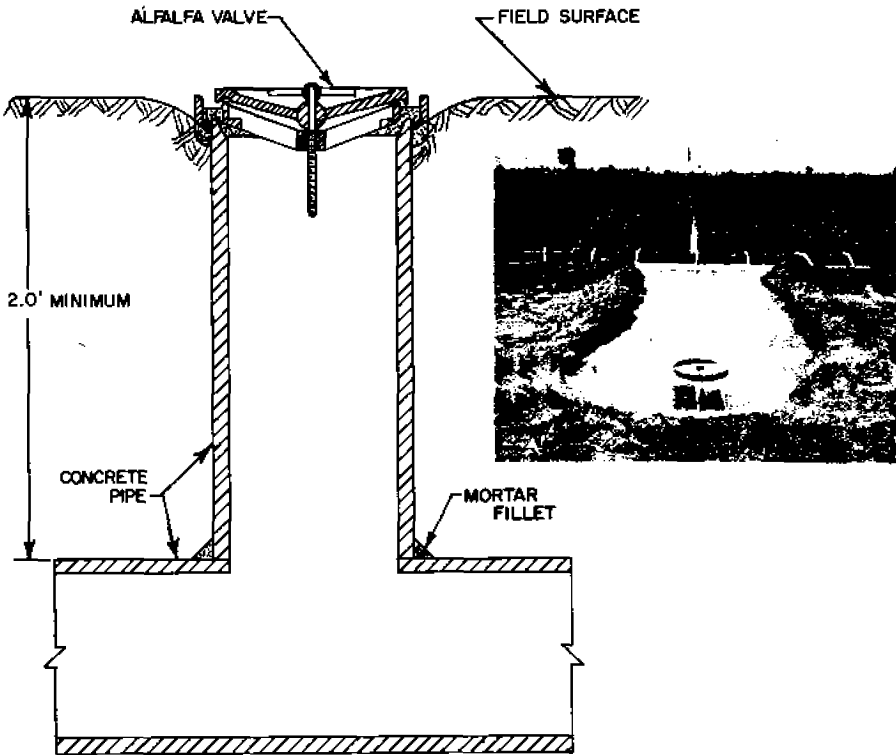
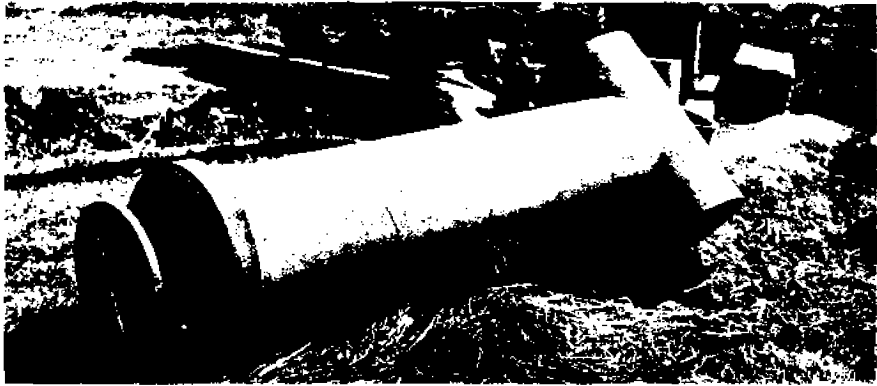

Fig. 42-25. Typical alfalfa-valve hydrant; the riser and valve assembly are sometimes cast to a short section of main pipeline to simplify installation.

The pot has openings fitted with slide gates through which water is distributed to the furrows. The slide gates are placed on the inside of the open pot to minimize erosion. The water level in the hydrant is regulated with an orchard valve. When line pressures are low enough, the valve in the riser may be omitted and the entire control made at the slide gates.

In installations where the hydraulic gradient is not more than 30 to 60 cm (1 to 2 ft) above the ground, the pot may be capped. In this case, the slide gates

Fig. 42-26. Orchard-valve hydrant showing the recommended installation of the valve in the riser.

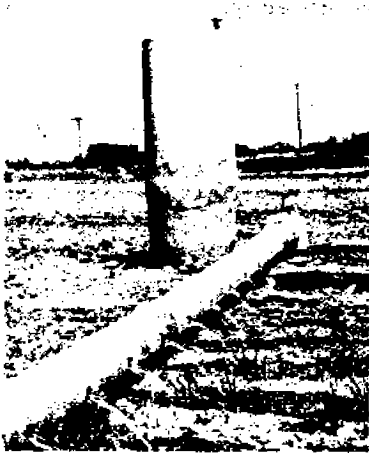
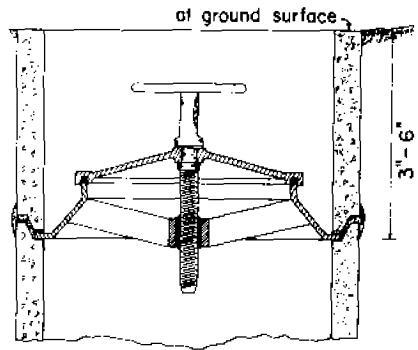

Fig. 42-27. Gated surface pipe and tubing attached to portable hydrants fitted over alfalfa or orchard valves. The flow to the furrows is adjusted from individual outlets in the pipe or tube.

are installed and operated from the outside of the riser. The flow is controlled by adjustment of line pressures and the gate.

Capped pot outlets have the advantage of not allowing leaves or debris to enter the riser to clog the slide gates. However, they provide less control of the flow, and erosion from the water jet is more severe. The slide gates are often replaced by special screw-type valves which cause less erosion. The use of capped pot outlets is usually limited to orchards and permanent crops where small flows are distributed into furrows.

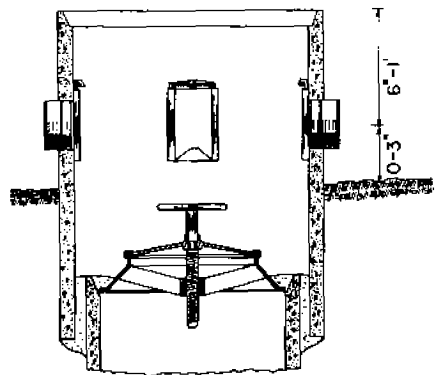

Fig. 42-28. Open-pot hydrant with orchard valve and slide-gate control.



With low line pressures, the pot is sometimes omitted and the slide gate put in the sides of the riser which may be left open or capped. Flow ratings and maximum recommended design capacities for slide gates have been determined (Pillsbury, 1952; Tovey and Myers, 1959).

3. *Surface Pipe Hydrant.* Several different types of hydrants are used to connect the pipelines to surface pipe or tubing. These are essentially variations of those mentioned previously in which the slide gates are replaced by nipples or connections for attachment of the surface pipe. Unless excess pressure is in the pipeline, the riser extends high enough to produce the required pressure in the surface pipe. If the pressure in the pipeline is more than required, the riser may be equipped with an orchard valve to prevent it from overflowing.

The height of an open hydrant should equal or exceed the head loss in the gated pipe or tubing plus freeboard. References are available which are helpful in determining head loss in surface pipe and tubing (Humpherys and Lauritzen, 1964; Pillsbury, 1952; Tovey and Myers, 1959). Discharge into the furrows is controlled by individual outlets along the pipe or tube.

#### d. Miscellaneous.

1. *Sand Traps.* Sand traps are usually built into the pipe inlet structures. Most of the suspended material may be removed by making the stand extra large in diameter to insure low water velocity and to provide a settling basin. The bottom of the stand is set some distance below the invert of the outlet pipes to provide space for sediment deposition.

Sediment collecting in the pipeline is minimized if a minimum velocity of 60 cm (2 ft)/sec and preferably 90 cm (3 ft)/sec is maintained. Sediment deposits in the pipeline reduce the capacity and eventually may plug the line. It is particularly important that sediment be removed from the water when surface pipe and tubes are used. Sediment deposition in this equipment makes it very difficult to move. The opportunity for sediment to settle out in surface pipe is usually greater since the velocities are lower.

The removal of sediment when water enters the pipeline from a ditch or canal was discussed in the previous section on open channels.

2. *Debris and Weed Screens.* Debris and weed screens should be provided at every gravity inlet. Much of the difficulty caused by this material will be eliminated if provision is made to remove it from the water before entering the pipe. A self-cleaning screen installed on a gravity inlet is shown in Fig. 42-10.

3. *Air Vents.* Vents are required on every pipeline to release air and to prevent high pressures. Vents are needed at all high points of a line, where the pipe slope increases sharply down grade, at sharp turns in the line, at the end of the line, and directly below any structure that entrains air in the flowing water. In addition to releasing air, open vents serve to release surges and prevent damage to the line when gates or valves are opened or closed. They also prevent pipe collapse from vacuum when the line is drained.

The cross-sectional area of the vent riser should be at least one-half the area of the pipeline. A typical installation is shown in Fig. 42-29. It is often recommended that the small vent pipe extend part way down into the larger riser. Air trapped in the space between absorbs pressure waves and the riser thus acts as a surge chamber. The area of the smaller vent pipe should not be less than one-sixtieth of the main line area and in no case less than 5 cm (2 inches) in diameter.

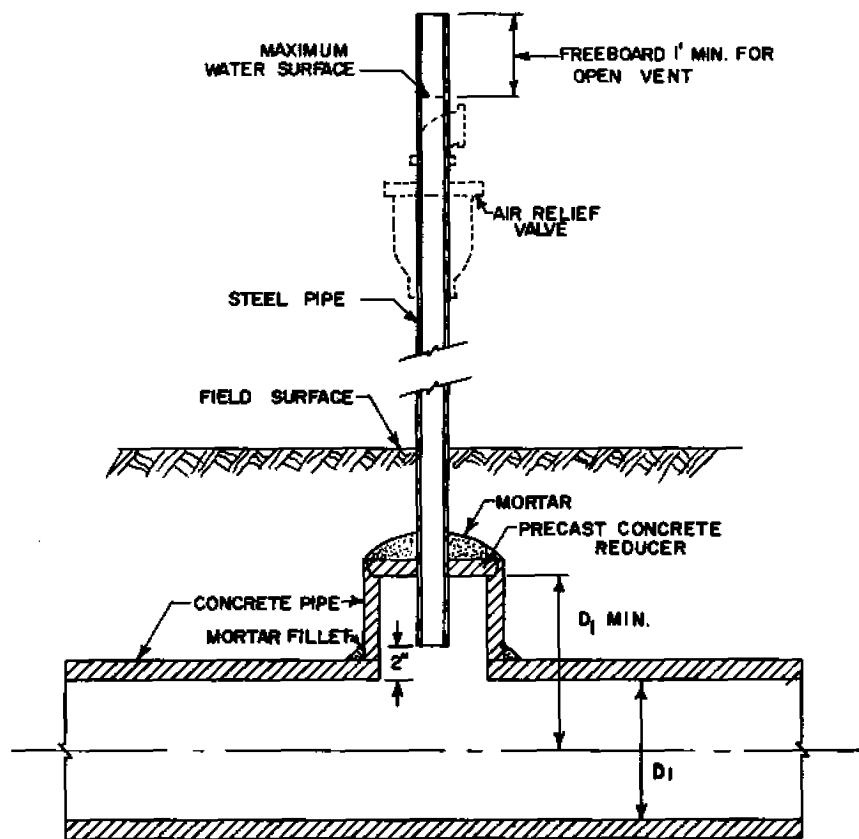

Fig. 42-29. Air vent for underground pipelines. The vent pipe is sometimes allowed to project into the riser to form an air pocket and surge chamber in the top of the riser.

All vents should extend at least 120 cm (4 ft) above the ground or as high as necessary to prevent overflow during normal operation. If an excessively high vent stand is required it may be advisable to install an air-relief valve to reduce the height as indicated in Fig. 42-29. These permit air to escape or enter but do not allow water to pass. They should not be located where it may be necessary to relieve momentary high pressure surges.

## B. Measurement

### 1. CLASSIFICATION AND PRINCIPLES INVOLVED

The measurement of flow in closed conduits can be more complicated than in open channels. It is a common practice to use one of the devices previously discussed for open channels to measure the flow from pipes after the water is discharged into a ditch or canal. One simplifying factor of measurement in closed systems is that the area of flow is generally a constant. There is also no free water surface involved.

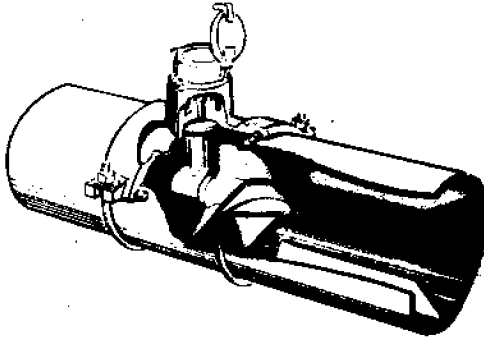

Fig. 42-30. Propeller-type meter for use in pipes.

In general, the devices and techniques available can be classified as those for open channels. The flow is usually contracted through an orifice of some type or a meter using a rotating wheel. There are a number of devices and methods available for pipes which give fairly accurate measurements.

## 2. DEVICES AND METHODS

a. **Commercial Meters.** Several types of meters, such as the ones shown in Fig. 42-20 and 42-30, give a direct measure of flow by a dial indicator. These vary in design from the disk type frequently used for small diameter lines to propeller types which are used for larger sizes. Some types are relatively easy to install in existing lines. All are subject to clogging if debris is carried in the flow.

b. **Tubes.** Another type of device available commercially for measuring discharge from pipes is the Cox (modified Hall) flow meter (Robinson, 1961). This utilizes a small diameter tube which is inserted across the discharge pipe as shown in Fig. 42-31. The small holes facing the flow are connected to a

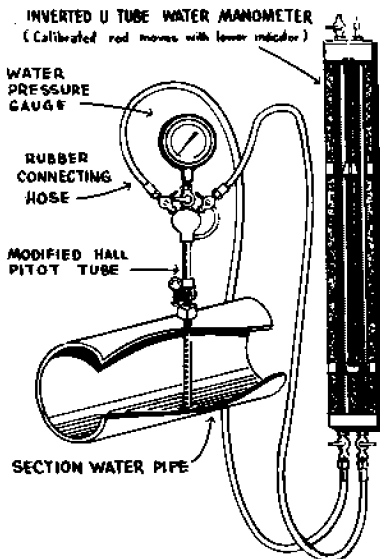

Fig. 42-31. Cox flow meter can be inserted into the pipe for flow measurement.

manifold. In addition, there are three holes, one on each side and one in the rear of the small tube, which are located so that they are at the center of the large pipe diameter. These are connected to a second manifold. Each manifold is then connected by tubing to a differential manometer. With the manometer reading and tables furnished by the manufacturer, the discharge can be determined. With proper care the discharge can be determined with an accuracy of about  $\pm 8\%$ .

### c. Miscellaneous Devices and Methods.

1. *Coordinate Method.* A simple method, although not too accurate, is to merely measure the distance out and down from the pipe outlet to some point on the issuing jet (US Dep. Agr., 1962). With these measurements, tables are available to estimate the amount of flowing water. The expected accuracy with this method would not be less than  $\pm 10\%$ .

2. *Current Meters.* Current meters similar to those used in open channels are available for measurement in pipes. The measurement is made by transversing the flow area at the discharge end of the pipe for an integrated measure of the velocity (Rohwer, 1942). Measurements have been made to an accuracy of  $\pm 3\%$ , but a wider deviation can generally be expected.

3. *End Orifices.* In many cases a plate with an orifice hole of smaller diameter than the pipe can be attached to the discharge end of the pipe and used as a measuring device (US Dep. Agr., 1962). If the orifice is installed carefully, an accuracy of about  $\pm 5\%$  can be expected.

## LITERATURE CITED

- American Society of Agricultural Engineers. 1964. ASAE standard S 261.3, design and installation of non-reinforced concrete irrigation pipe systems. Agr. Eng. Yearbook. p. 313-316.
- Bergstrom, Walter. 1961. Weed seed screens for irrigation systems. Pacific Northwest Coop. Agr. Ext. Serv. (Washington, Oregon, Idaho). Ext. Publ. Bull. 43. 7 p.
- Bondurant, J. A., and A. S. Humpherys. 1962. Surface irrigation through automatic control. Agr. Eng. 43(1):20, 21, 35.
- Code, W. E. 1961. Farm irrigation structures. Colorado St. Univ. Agr. Exp. Sta. Bull. 496-S. 60 p.
- Couthard, T. L., J. C. Wilcox, and H. O. Lacy. 1956. Screening irrigation water. Univ. British Columbia. Agr. Eng. Div. Bull. A.E. 6. 14 p.
- Davis, C. V. 1952. Handbook of applied hydraulics. 2nd ed. McGraw-Hill Book Co., New York. p. 1209-1214.
- Davis, Sydney. 1963. Unification of Parshall flume data. Amer. Soc. Civil Eng. Trans. 128(3):399-421.
- Fiala, G. R., and M. L. Albertson. 1963. Manifold stilling basins. Amer. Soc. Civil Eng. Trans. 128(1):428-462.
- Garton, J. E. 1966. Designing an automatic cut-back furrow irrigation system. Oklahoma Agr. Exp. Sta. Bull. B-651. 20 p.
- Gilden, R. O., and G. O. Woodward. 1952. Low cost irrigation structures. Univ. Wyoming. Agr. Ext. Serv. Circ. 122. 16 p.
- Haise, H. R., E. G. Kruse, and N. A. Dimick. 1965. Automation of surface irrigation systems. Agr. Res. Serv. US Dep. Agr. 21 p.
- Herpich, R. L., and H. L. Manges. 1959. Irrigation water control structures. Kansas St. Univ. Dep. Agr. Eng. Agr. Exp. St. Contribution No. 82. 12 p.
- Humpherys, A. S., and C. W. Lauritzen. 1964. Hydraulic and geometrical relationships of lay-flat irrigation tubing. US Dep. Agr. Tech. Bull. 1309. 38 p.

- Israelsen, O. W., and V. E. Hansen. 1962. Irrigation principles and practices. 3rd ed. John Wiley & Sons, Inc., New York. p. 313-330.
- Jensen, M. C., M. A. Hagood, and P. K. Fanning. 1954. Irrigation structures and methods for water control. Washington St. Univ. Agr. Ext. Serv. Bull. 491. 32 p.
- King, H. W. 1954. Handbook of hydraulics. 4th ed. McGraw-Hill Book Co., New York. p. 6-8, 11-12, 14-19.
- Kruse, E. G. Jan. 1965. The constant-head orifice farm turnout. Agr. Res. Serv. US Dep. Agr. Publ. ARS 41-93.
- Parshall, R. L. 1950. Measuring water in irrigation channels with Parshall flumes and small weirs. Soil Conserv. Serv. US Dep. Agr. Circ. 843. 62 p.
- Parshall, R. L. 1952. Model and prototype studies of sand traps. Amer. Soc. Civil Eng. Trans. 117:204-217.
- Parshall, R. L. 1953. Parshall flumes of large sizes. Colorado St. Univ. Agr. Exp. Sta. Ext. Serv. Bull. 426-A. 39 p.
- Pillsbury, A. F. 1952. Concrete pipe for irrigation. Univ. California Agr. Exp. Sta. Ext. Serv. Circ. 418. 51 p.
- Portland Cement Association. 1952. Irrigation with concrete pipe. Chicago. 55p.
- Robinson, A. R. 1957. Parshall flumes of small sizes. Colorado St. Univ. Agr. Exp. Sta. Tech. Bull. 61. 12 p.
- Robinson, A. R. 1961. Study of the Cox flowmeter. Colorado St. Univ. Civil Eng. Dep. Rep. CER 61ARR 5. 15 p.
- Robinson, A. R. 1962. Vortex tube sand trap. Amer. Soc. Civil Eng. Trans. 127(3):391-433.
- Robinson, A. R. 1963. Evaluation of the vane-type flow meter. Amer. Soc. Agr. Eng. J. 44(C7):374-375.
- Robinson, A. R., and A. R. Chamberlain. 1960. Trapezoidal measuring flumes for open channel flow measurement. Amer. Soc. Agr. Eng. Trans. 3(2):120-124, 128.
- Robinson, A. R., C. W. Lauritzen, D. C. Muckel, and J. T. Phelan. 1963. Distribution, control and measurement of irrigation water on the farm. US Dep. Agr. Misc. Publ. 929. 27 p.
- Robinson, A. R. 1966. Water measurement in small irrigation channels using trapezoidal flumes. Amer. Soc. Agr. Eng. Trans. 9(3):382-385, 388.
- Rohwer, Carl. 1942. The use of current meters in measuring pipe discharges. Colorado St. Univ. Agr. Exp. Sta. Tech. Bull. 29. 40 p.
- Rouse, H. 1950. Engineering hydraulics. John Wiley & Sons, New York.
- Sharp, B. B. 1964. Flow measurement with a suspension wire. Amer. Soc. Civil Eng., Proc. Pap. 3821. Vol. 90. No. HY2. p. 37-54.
- Smith, G. L. 1957. Scour and energy dissipation below culvert outlets. Colorado St. Univ. Civil Eng. Dep. Rep. CER 57CLS 16. 96 p.
- Thomas, C. W. 1959. Common errors in measurement of irrigation water. Amer. Soc. Civil Eng., Trans. 124:319-340.
- Thomas, C. W. 1960. World practices in water measurement at turnouts. Amer. Soc. Civil Eng., Proc. J. Irrig. Drainage Div. Pap. 2530. 86 (IR2):29-52.
- Tovey, Rhys, and V. I. Myers. 1959. Evaluation of some irrigation water control devices. Univ. Idaho. Agr. Exp. Sta. Bull. 319. 32 p.
- Uppal, H. L. 1951. Sediment excluders and extractors. Int. Ass. Hydraulic Res., Rep. 4th Mg. (Bombay, India). p. 261-316.
- US Bureau of Reclamation. 1953. Water measurement manual. US Gov. Printing Office. Washington, D.C. 271 p.
- US Dep. of Agriculture. 1962. Measurement of irrigation water. SCS Nat. Eng. Handbook. Sect. 15. Ch. 9. US Government Printing Office. Washington, D. C. 72 p.