

# Water Transmission Lines

- Transmission lines are long pipes with no withdrawals
  - Gravity main
  - Pumping main

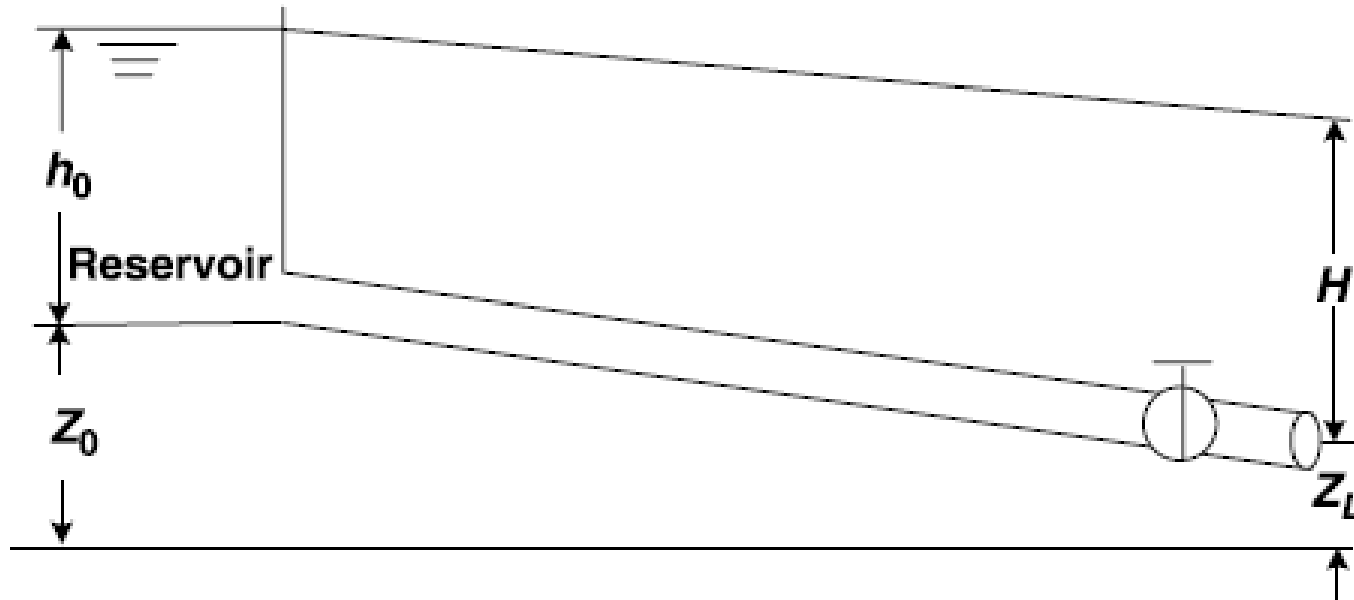

# Gravity main



$$h_0 + Z_0 - Z_L = H \text{ (Head loss + residual pressure)}$$



**AAiT**

Water Supply & Urban Drainage  
By Zerihun Alemayehu

# Pumping main

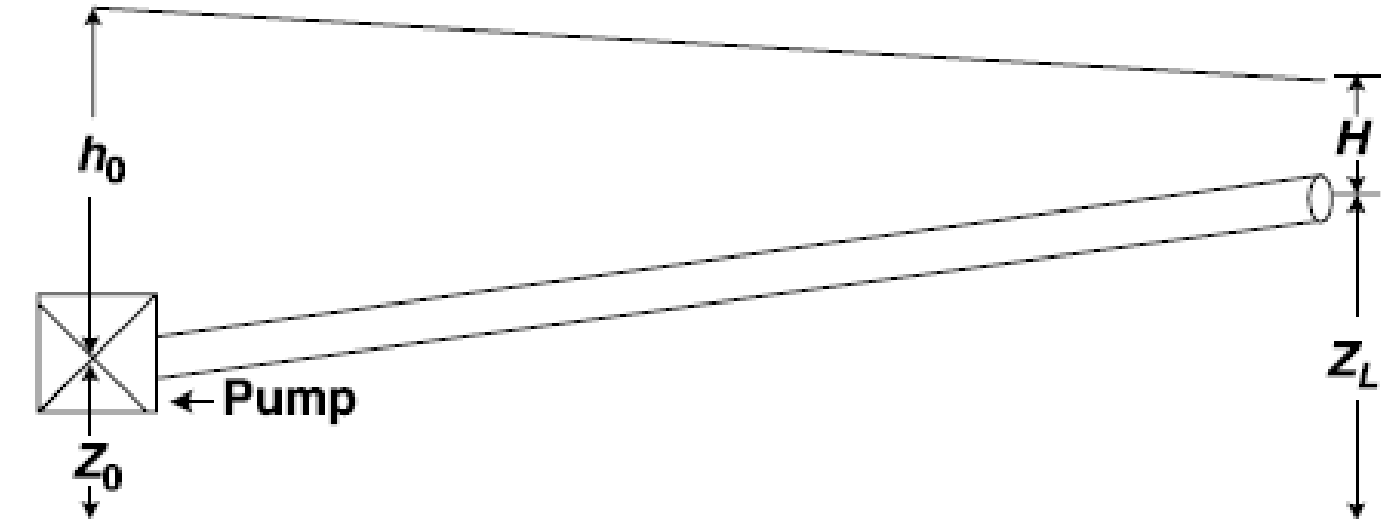

$$h_0 = H + Z_L - Z_0 + \text{Head loss}$$



# Layout of distribution systems

- **Pipe networks :**

- *Primary or arterial mains*

- from the **pumping stations** and from **storage facilities** to the various **districts** of the city.
- valved at intervals of not  $\leq 1.5$  km

- *Secondary lines or Sub-mains*

- run from one primary main to another
- located at spacings of 2-4 blocks

- *Small distribution mains or branches*

- Supply water to every consumer and to the fire hydrants



# Layout of distribution systems

- layout of distribution pipes generally follows the road pattern
- four types of pipe network layouts –
  - *dead end system or branch system,*
  - *gridiron system,*
  - *ring system, and*
  - *radial system.*



# Layout of distribution systems

- **Dead end system**

- solved easily
- Lesser number of shut-off valves
- Shorter pipe lengths and the easy to lay pipes
- cheap and simple and expanded easily
- dead ends → prevent circulation of water
- Problematic if a pipe is damaged

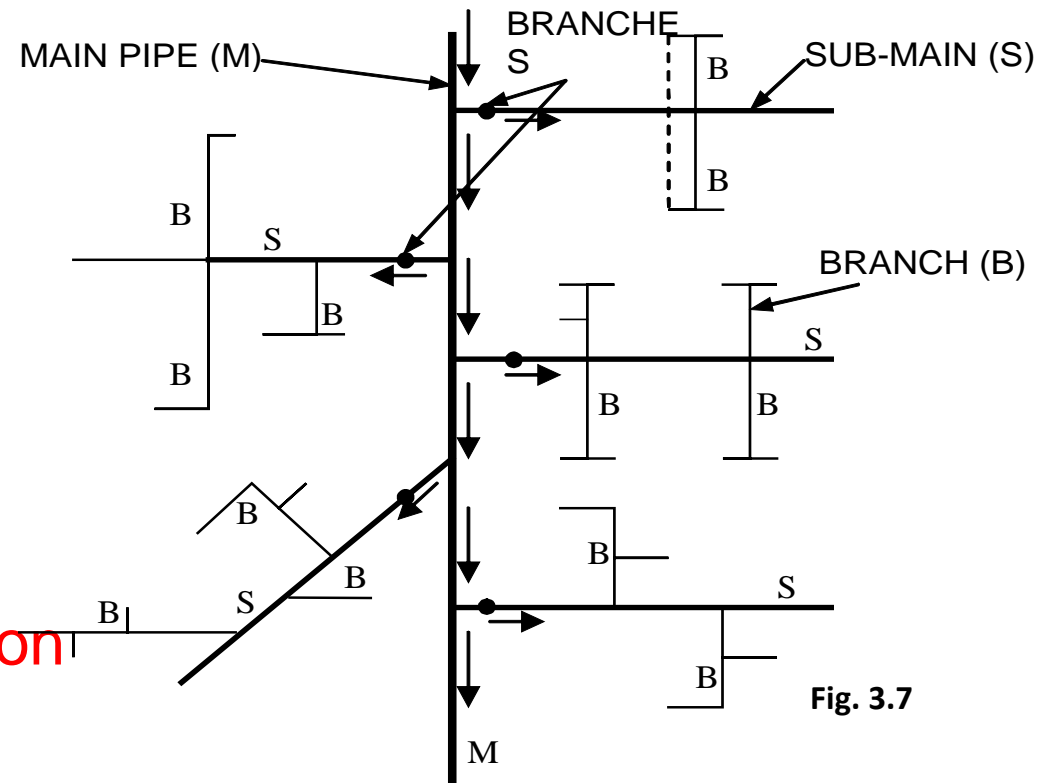

# Layout of distribution systems

- **Gridiron systems**

- Discharge, friction loss and pipe size is less
- Not problematic if a pipe is damaged
- No dead ends → allows circulation of water
- Good for fire fighting
- more pipelines and shut-off valves
- high cost of construction
- design is difficult and expensive

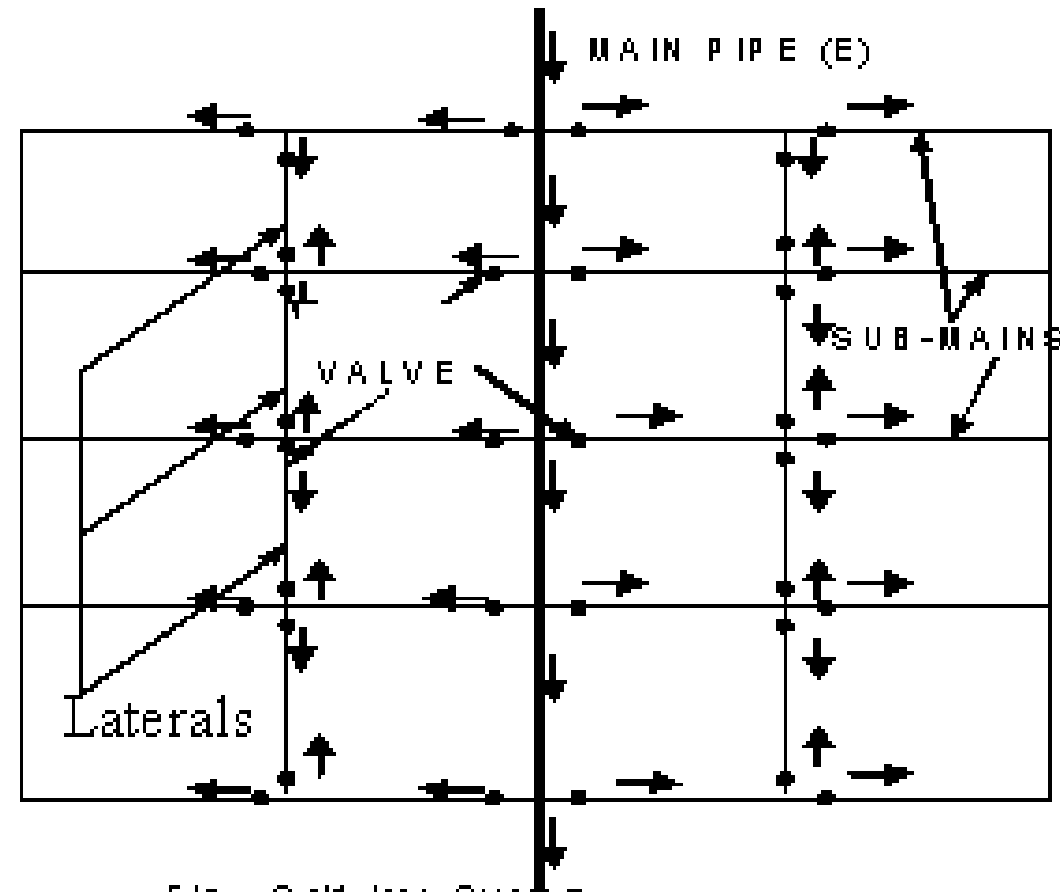

Fig. : Grid-Iron System



# Layout of distribution systems

- **Ring systems:**

- closed ring, circular or rectangular
- suitable for well-planned towns and cities
- Generally at high demand areas
- Not problematic if a pipe is damaged
- No dead ends → allows circulation of water
- Good for fire fighting
- more pipelines and shut-off valves
- high cost of construction
- design is difficult and expensive

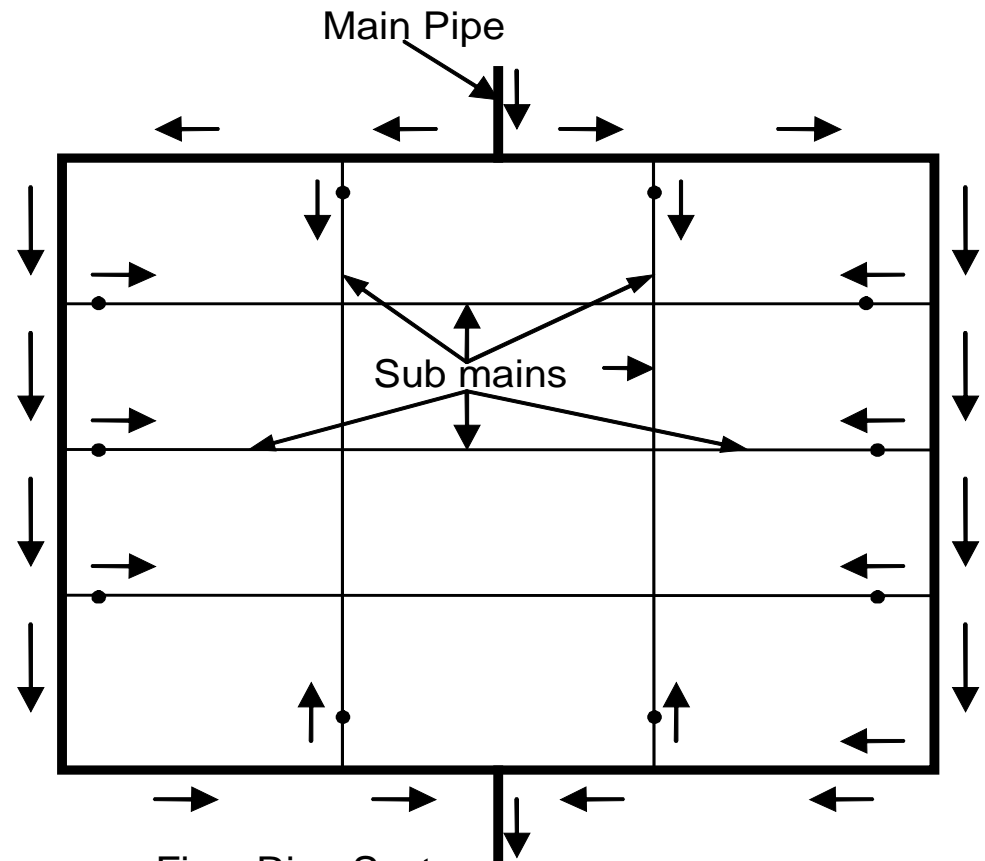

Fig. : Ring System





# Layout of distribution systems

- **Radial systems**

- For city or a town having a system of radial roads emerging from different centers
- distribution reservoirs at these centers
- From mains → pumped into the DRs placed at different centers and then to the service areas.
- ensures high pressure and efficient water distribution

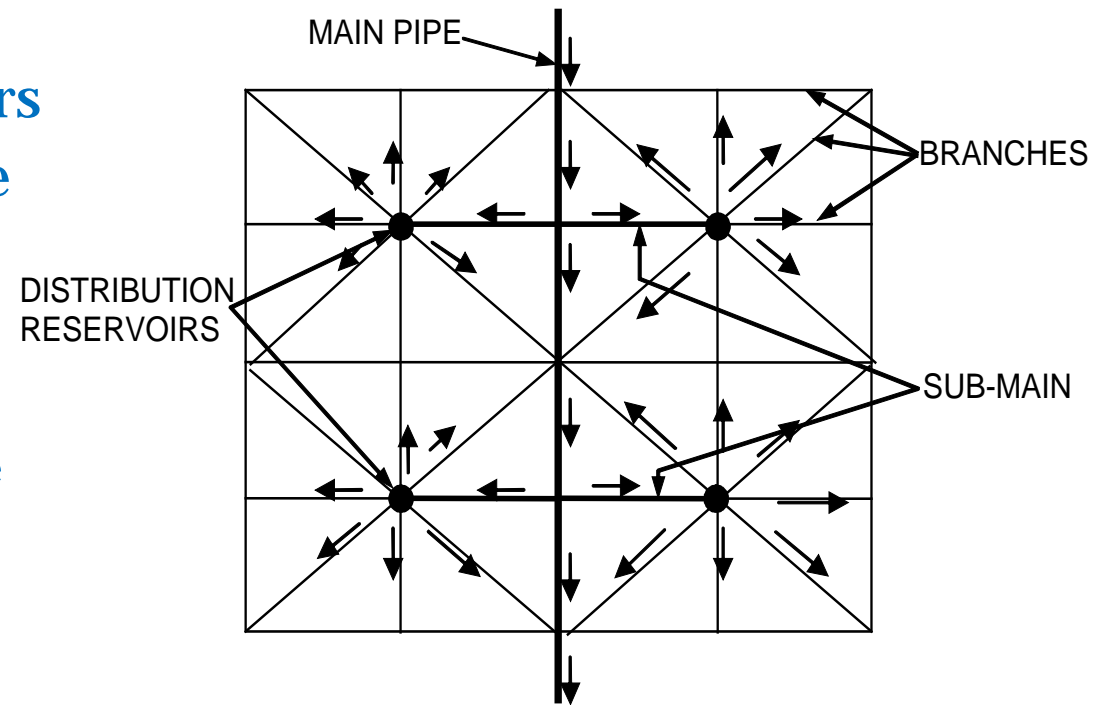

Fig. : Radial System



# Design of distribution systems

- **Design flow:** Max (*Peak hour demand or maximum day demand + Fire demand*)
- **Minimum main sizes:** generally: 150mm (6 in); high value districts: 200mm (8 in); major streets: 305mm (12 in); domestic flows only: 100mm (4 in); small communities: 50-75 mm
- **Velocity:** typical values – minimum = 0.6 - 1 m/s; maximum = 2.5 m/s
- **Pressure:** typical minimum value is 140 kPa (14 m) and maximum not to exceed 410 kPa (42 m). But mainly depends on **pressure ratings** of the pipes and appurtenances used and **regulatory requirements**



# Pressure zones

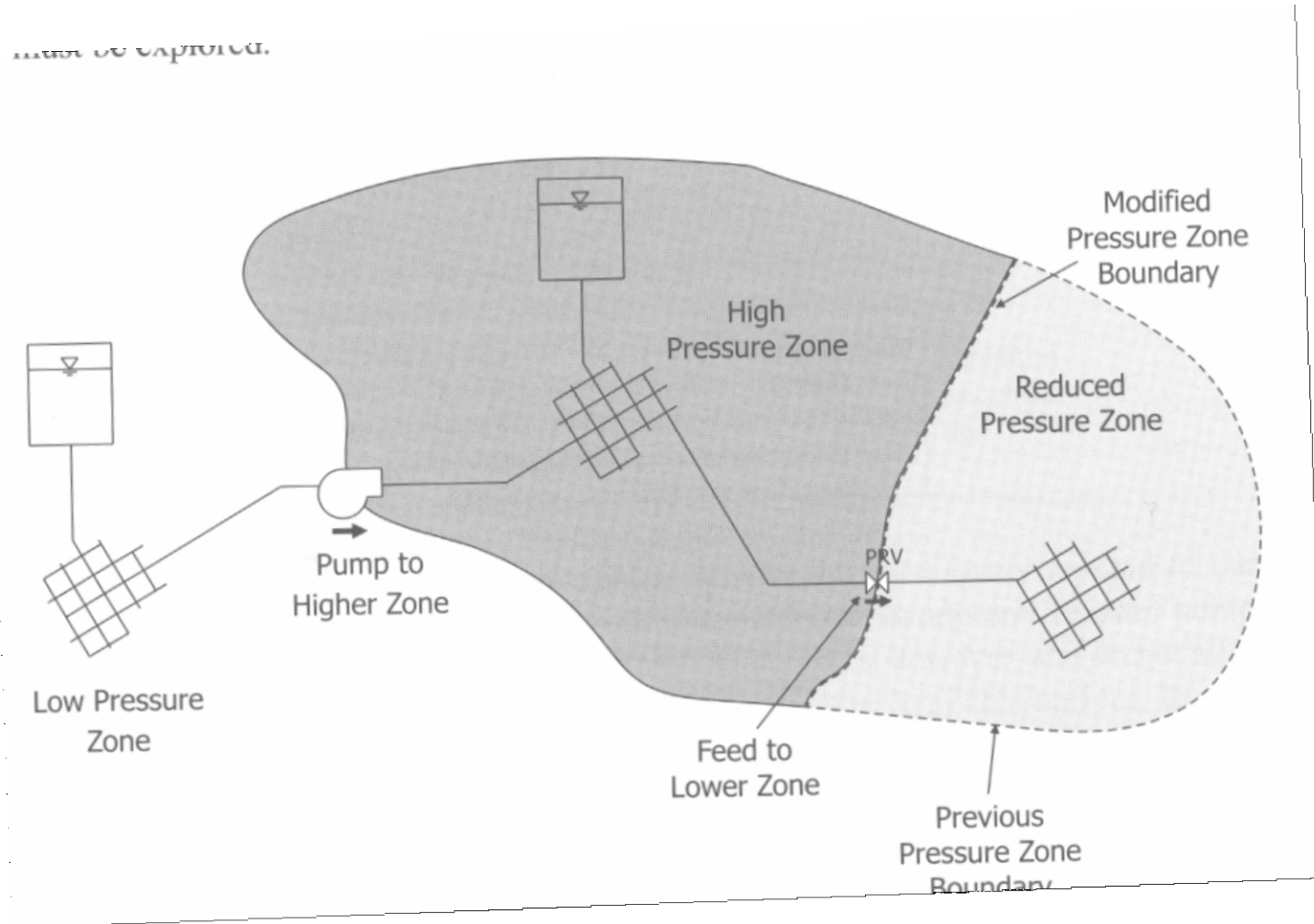

# Pipe Network Geometry

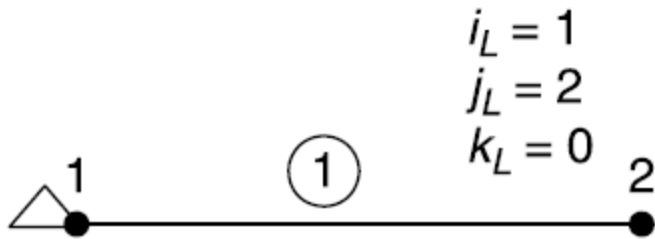

(a) Single pipe network

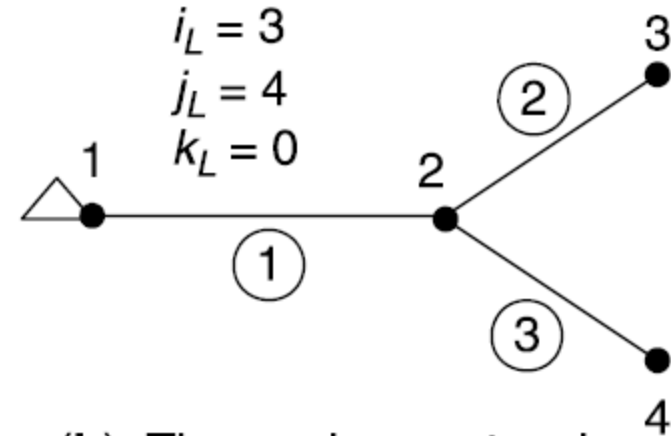

(b) Three pipes network

$i_L$  = no. of pipes

$j_L$  = no. of nodes

$k_L$  = no. of loops

$$i_L = j_L + k_L - 1$$



# Pipe Network Geometry

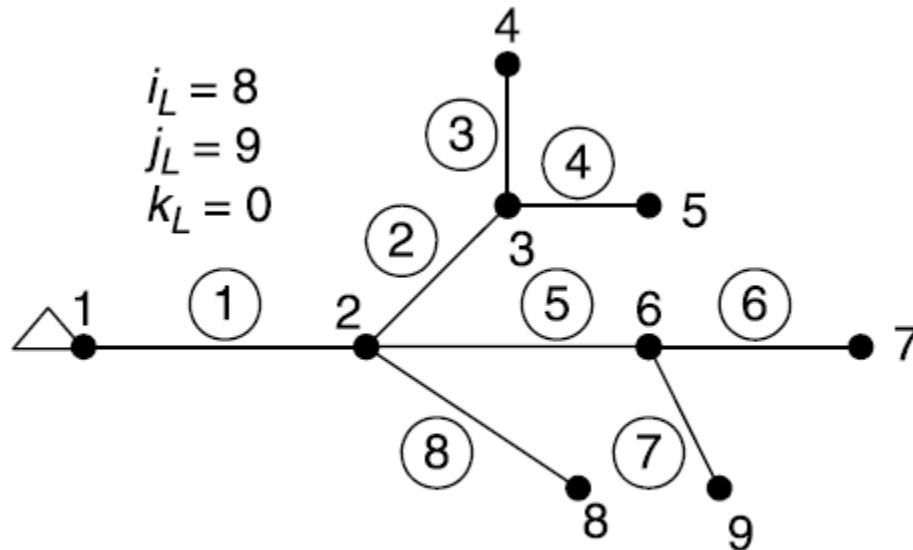

(c) Branched pipe network

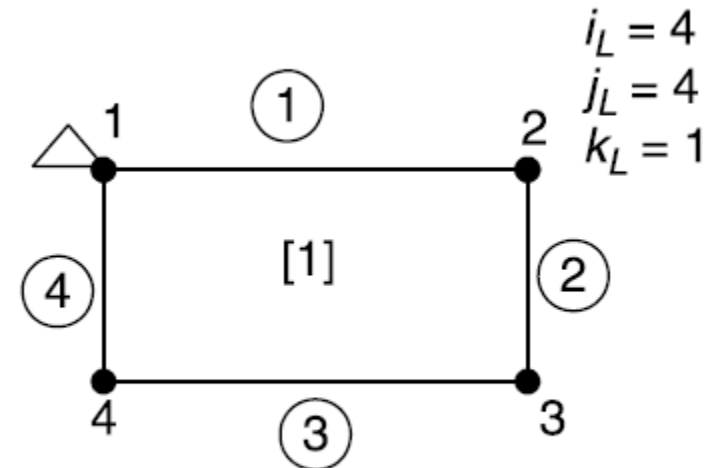

(d) Single looped network

$i_L$  = no. of pipes  
 $j_L$  = no. of nodes  
 $k_L$  = no. of loops

$$i_L = j_L + k_L - 1$$



# Pipe Network Geometry

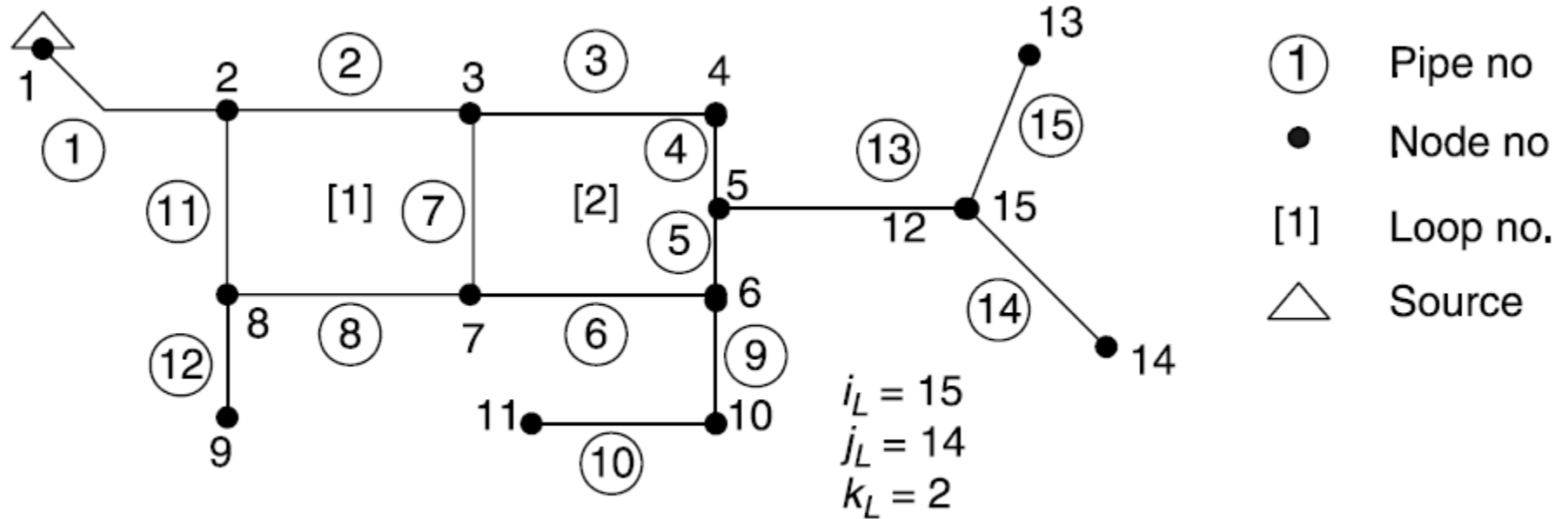

(e) Branched & looped network

$i_L$  = no. of pipes

$j_L$  = no. of nodes

$k_L$  = no. of loops

$$i_L = j_L + k_L - 1$$



**AAiT**

Water Supply & Urban Drainage  
By Zerihun Alemayehu

# Hydraulic analysis

- Includes determination of the following:

Discharges

Head loss

Pressure head



# Basic principles of pipe flow

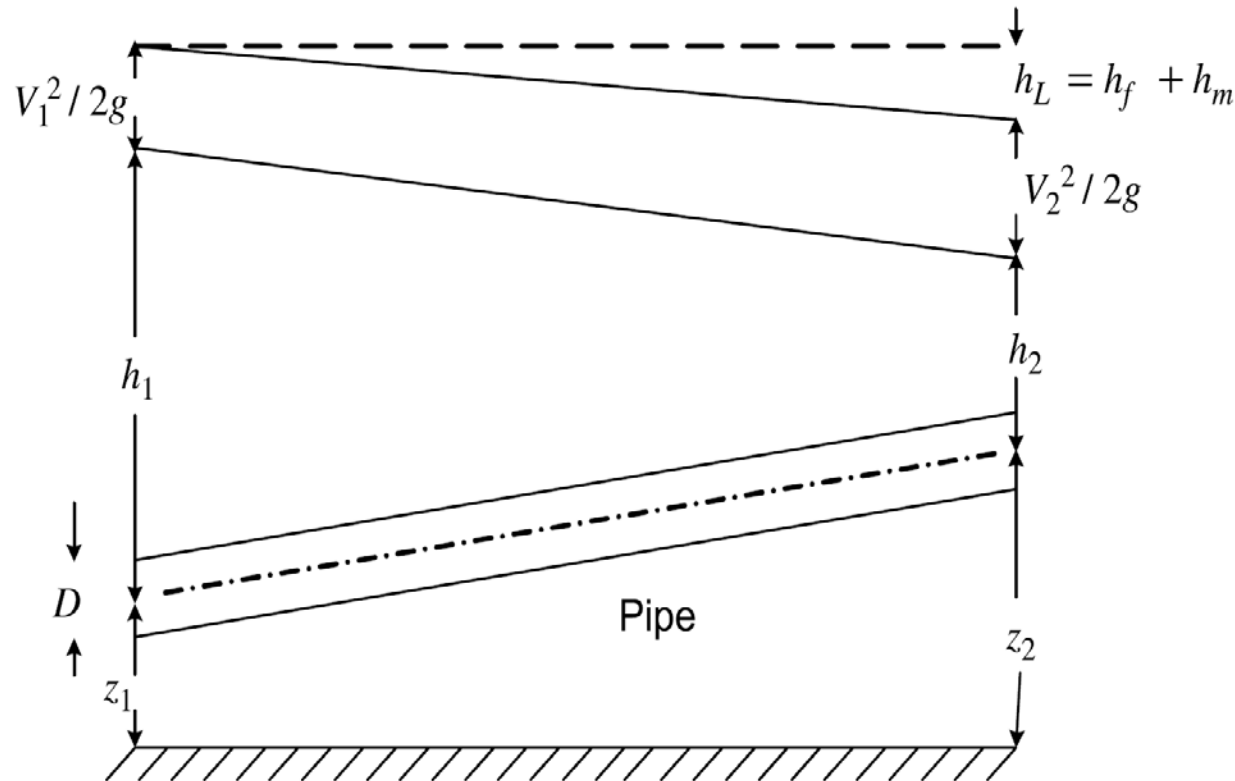

$$Q = \frac{\pi}{4} D^2 v$$

$$z_1 + h_1 + \frac{V_1^2}{2g} = z_2 + h_2 + \frac{V_2^2}{2g} + h_L, \quad h_L = h_f + h_m$$





# Friction Losses

Equation	Formula	Remarks
<b>Manning's</b>	$V = \frac{1}{n} R^{2/3} S^{1/2}$	commonly used for open channel flow.
<b>Chezy's (Kutter's)</b>	$V = C\sqrt{RS}$	Widely used in sanitary sewer design and analysis
<b>Hazen-Williams</b>	$V = 0.85CR^{0.63}S^{0.54}$	Commonly used in the design and analysis of pressure pipe systems
<b>Darcy-Weisbach</b>	$V = \sqrt{\frac{8g}{f}RS}$	Can be used for pressured pipe systems and open channel flows.



# Minor Losses

- Minor losses are due to bends, elbows, valves, enlargers, reducers...

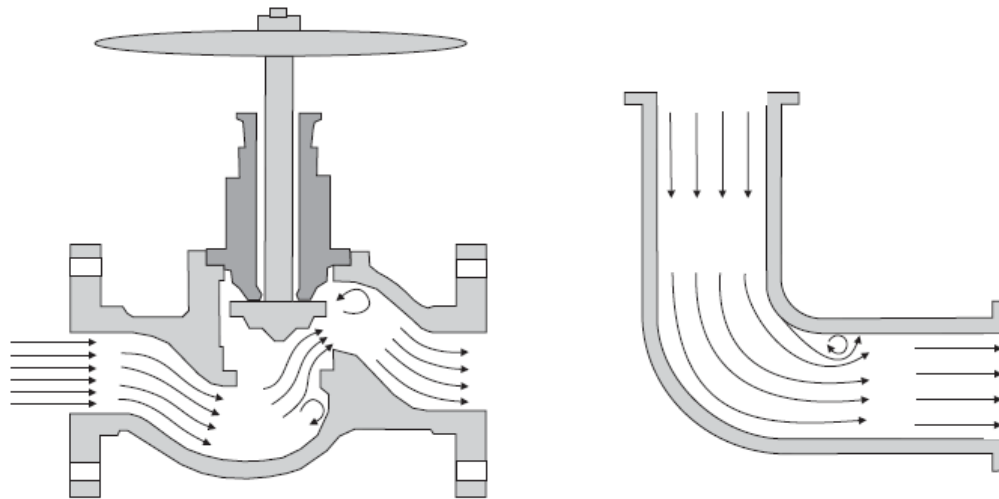

$$h_m = k_f \frac{V^2}{2g}$$



# Hydraulic Analysis of DS

- Hydraulic analysis methods
  - *Hardy cross method*
  - *Computer programs*
- The **Hazen-William** equation is widely used to determine the head loss in a pipe.

$$Q = 0.278CD^{2.63} \left( \frac{h_f}{L} \right)^{0.54} \quad h_f = 10.7 \left( \frac{Q}{C} \right)^{1.85} \left( \frac{L}{D^{4.87}} \right)$$



# Simple DS Design procedures

- Assign the *required demand* at each node
- Estimate the *discharge* flowing through the pipes
- Assume possible *pipe diameters*
- Calculate the *head loss* through the pipes
- Find the *residual pressure* at the end of the pipe.
- Compare this *terminal pressure* with the desired *minimum* and *maximum* pressures.
- If the required condition is not satisfied, then repeat steps (ii) through (vi) until the required conditions are met.

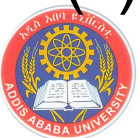

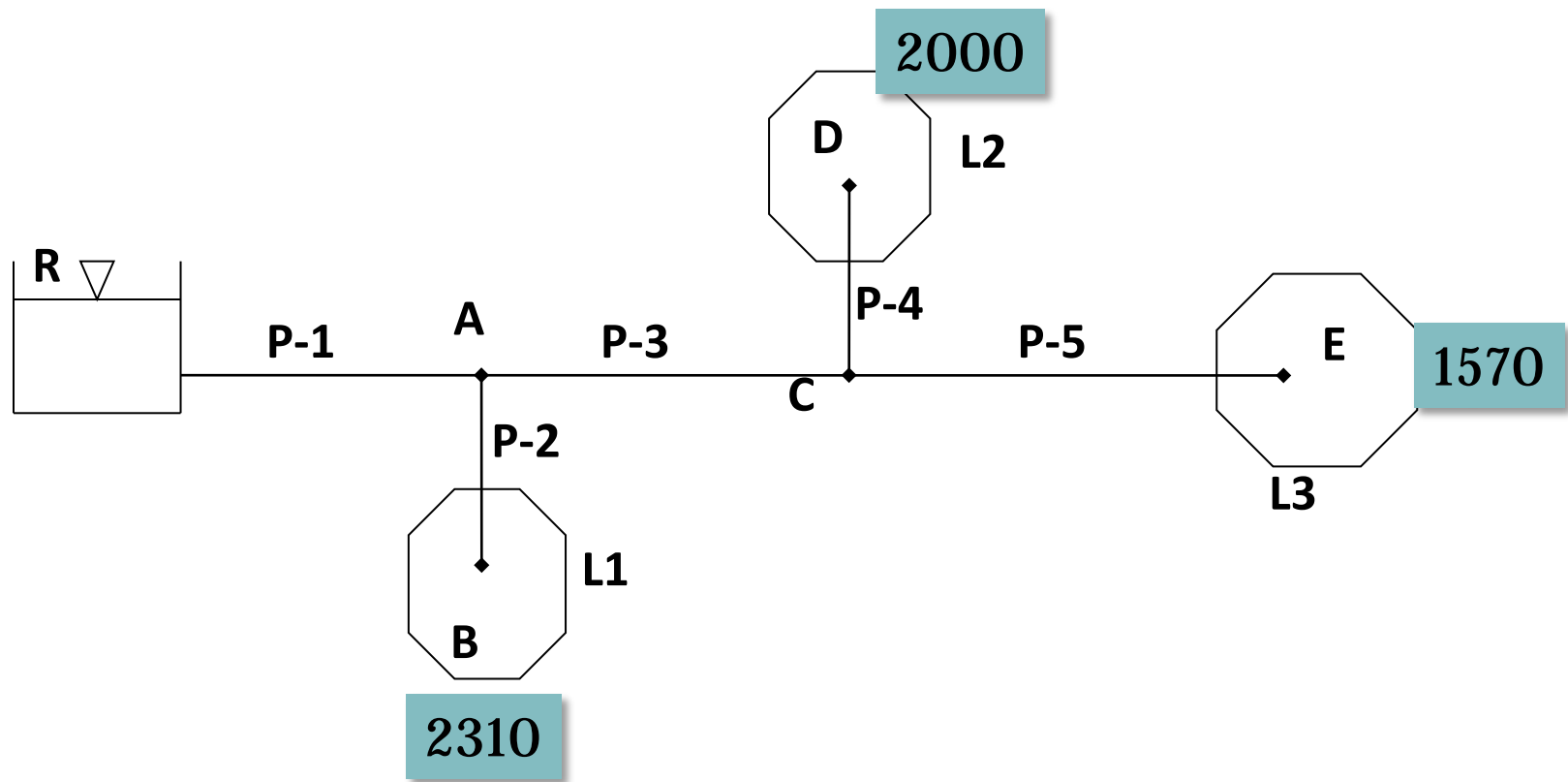

# Design procedures...

## Complex pipe Networks

- Hardy Cross Method can be used
- Assign the required demand at each node
- Assume the best distribution of flow that satisfies continuity by careful examination of the network.
  - The flow entering a node must be equal to the flow leaving the same node



# Design procedures...

- Calculate the head loss,  $h_f$ , in each pipe.
  - The algebraic sum of the heads around a closed loop must be zero.
  - For a loop, take head loss in the clockwise flows as positive and in the anti-clockwise flows as negative
- Calculate the correction factor for each loop by

$$\Delta Q = -\frac{\sum rQ_o|Q_o|^{n-1}}{\sum rn|Q_o|^{n-1}} = -\frac{\sum h_f}{n \sum \frac{h_f}{Q_o}}$$

Use  $n = 1.85$



# Example

Determine velocity and residual Pressure at the demand centers.

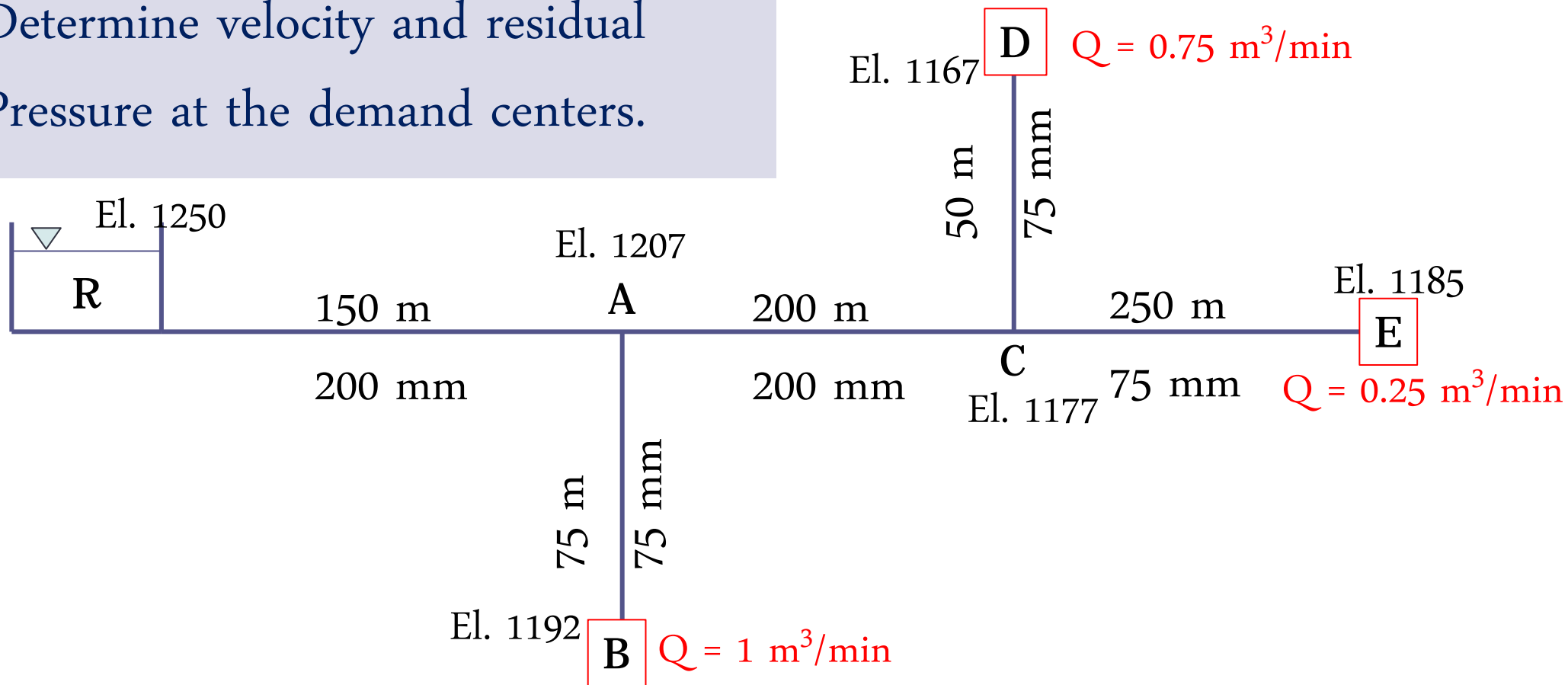



# Solution: Velocity Calculation

Velocity is calculated as

$$V = \frac{Q}{\pi \frac{d^2}{4}}$$

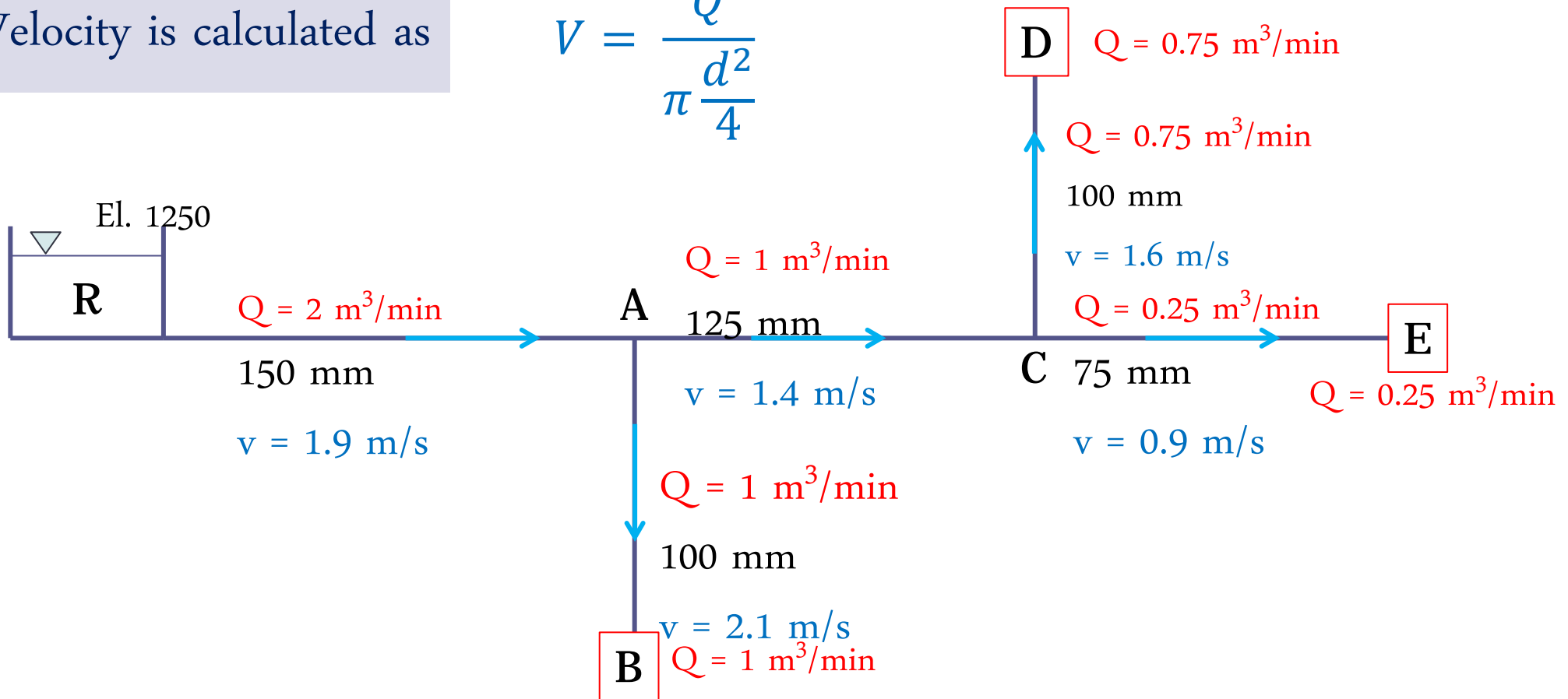

# Solution: Head loss calculation

Head loss is calculated as

$$h_l = 10.68 \frac{L}{D^{4.866}} \left( \frac{Q}{C} \right)^{1.85}$$

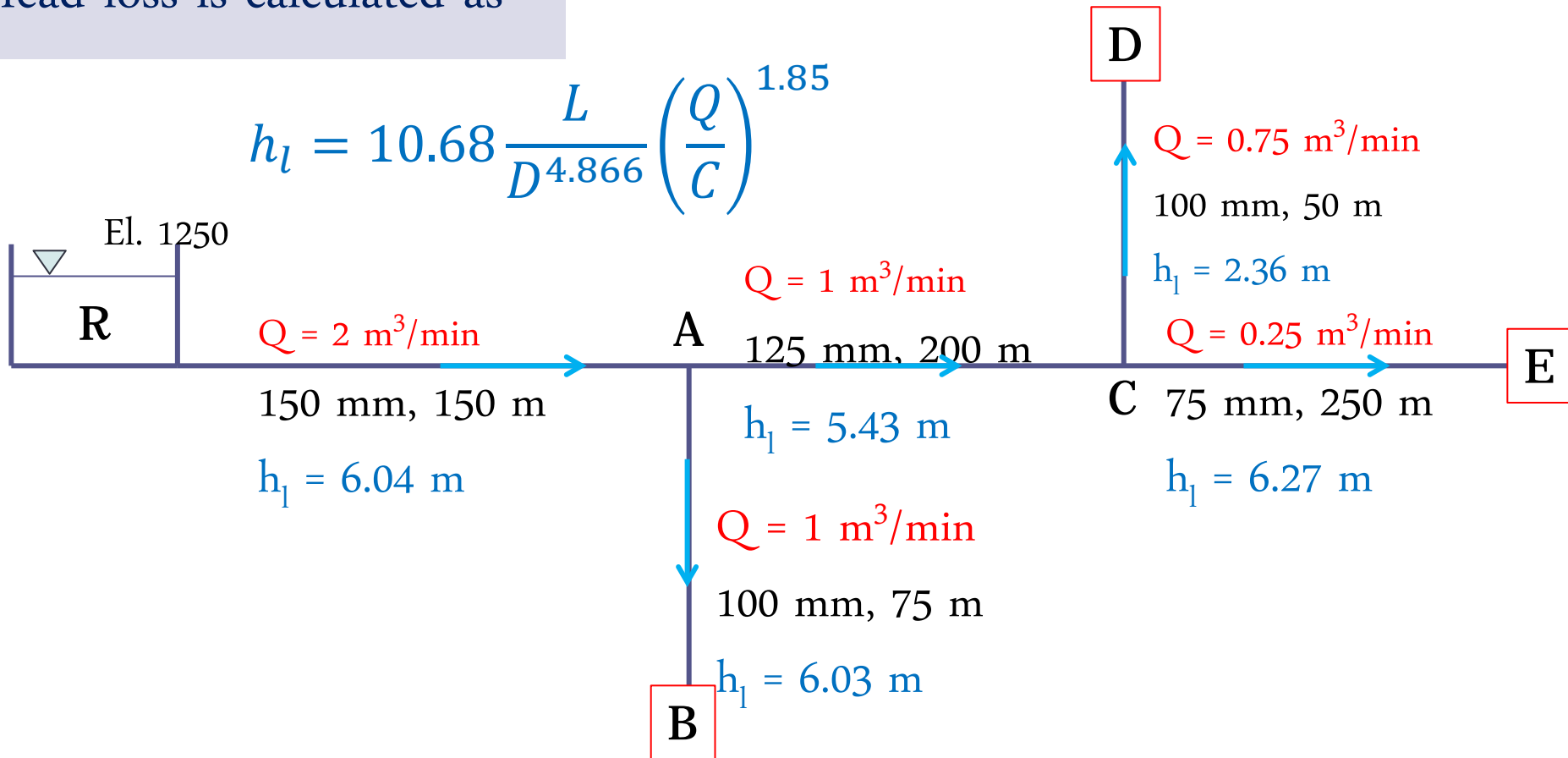

# Solution: Residual pressure calculation

Residual pressure is calculated as

$$h_{res} = \text{Elv. 1} - \text{Elv 2} - h_1$$

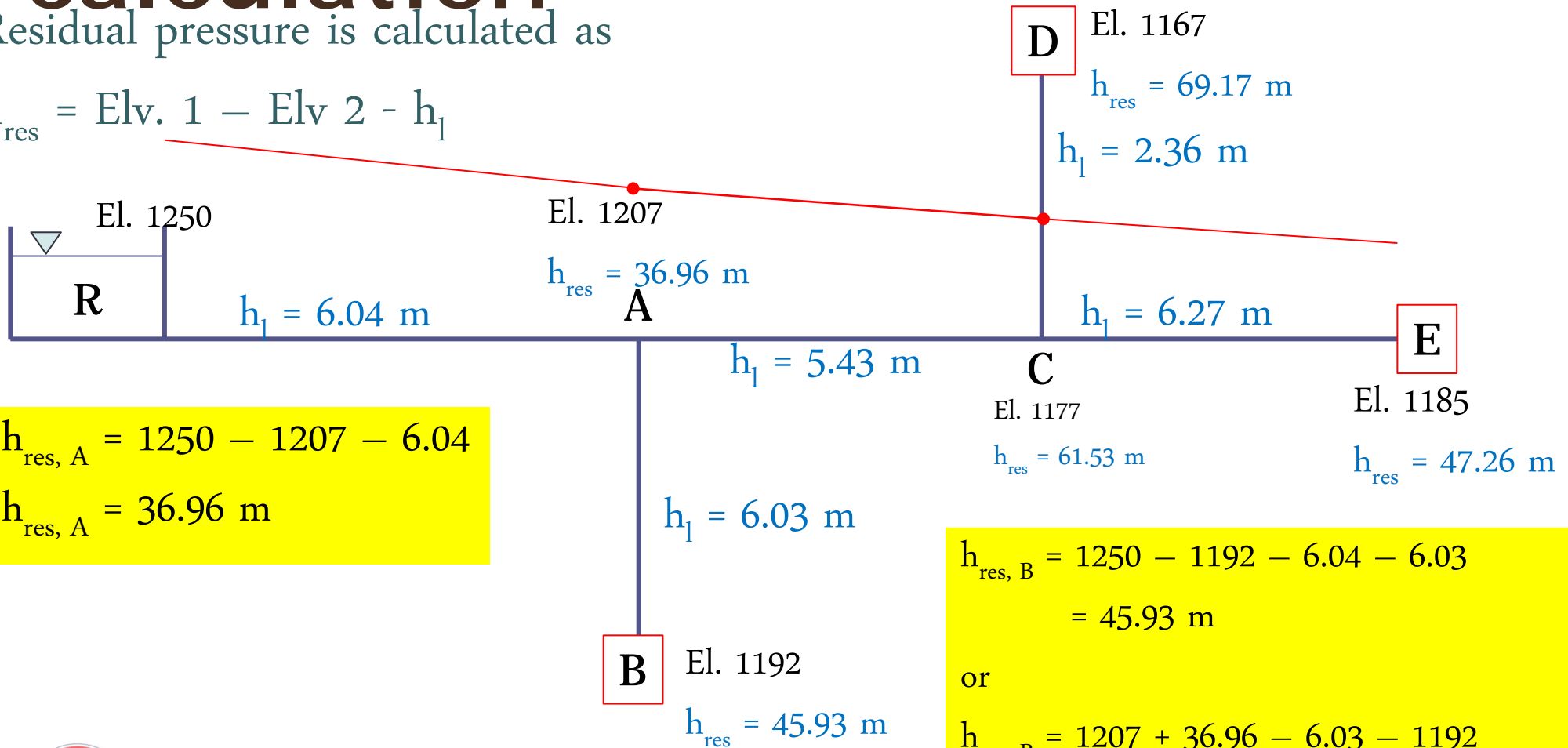

$$h_{res, A} = 1250 - 1207 - 6.04$$

$$h_{res, A} = 36.96 \text{ m}$$

$$h_{res, B} = 1250 - 1192 - 6.04 - 6.03$$

$$= 45.93 \text{ m}$$

or

$$h_{res, B} = 1207 + 36.96 - 6.03 - 1192$$

$$= 45.93 \text{ m}$$



# Reading assignment

- From your Hydraulics II course
  - Pipe network analysis
  - Hardy-cross method
  - Newton Raphson method
  - Linear Theory method
  - EPANET



# Example

Determine the discharge in each of the pipes using Hard-Cross Method

Pipe	Diameter, mm	Length, m
AB	300	1000
BC	200	2500
BD	300	3000
AD	400	3500
DC	200	600

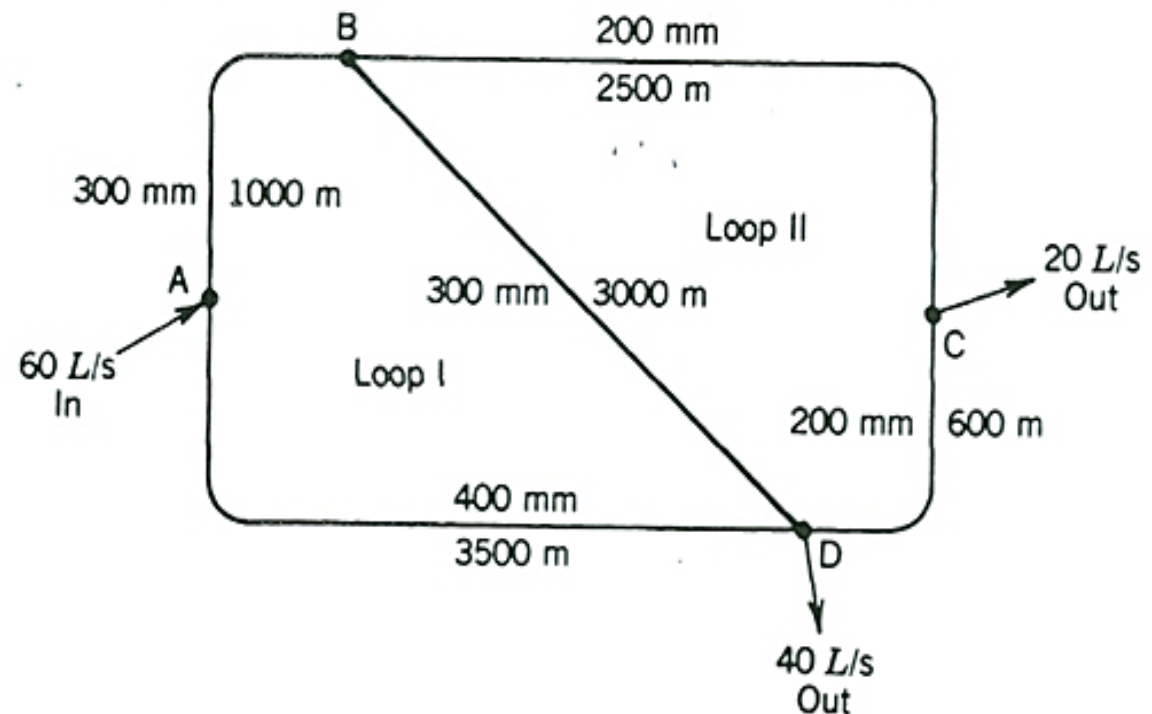

**AAiT**

Water Supply & Urban Drainage  
By Zerihun Alemayehu

# First Trial

Loop	Pipe	D, mm	L, m	Q, L/s	S, m/m	$h_L, m$	$h_L/Q$	Q + $\Delta Q$
I (first try)	AB	300	1000	35	0.0015	1.5	0.043	29
	BD	300	3000	10	0.00015	0.45	0.045	4
	AD	400	3500	-25	-0.0002	<u>-0.7</u>	<u>0.028</u>	-31
						1.25	0.116	
I: $\Delta Q_1 = -\frac{1.25}{1.85 \times 0.116} \approx -6 \text{ L/s}$								

Loop	Pipe	D, mm	L, m	Q, L/s	S, m/m	$h_L, m$	$h_L/Q$	Q + $\Delta Q$
II (first try)	BC	200	2500	25	0.0055	13.75	0.55	12
	CD	200	600	5	0.0003	0.18	0.036	-8
	BD	300	3000	-4	neglect	<u>neglect</u>	<u>neglect</u>	-17
						13.9	0.586	
II: $\Delta Q_1 = -\frac{13.9}{1.85 \times 0.586} \approx -13 \text{ L/s}$								



# Second Trial

Loop	Pipe	D, mm	L, m	Q, L/s	S, m/m	$h_L, m$	$h_L/Q$	Q + $\Delta Q$
I (second try)	AB	300	1000	29	0.001	1.00	0.034	24
	BD	300	3000	17	0.0004	1.20	0.071	12
	AD	400	3500	-31	-0.0003	<u>-1.05</u>	<u>0.034</u>	-36
						1.15	0.139	

$$\text{I: } \Delta Q_2 = -\frac{1.15}{1.85 \times 0.139} \approx -5 \text{ L/s}$$

Loop	Pipe	D, mm	L, m	Q, L/s	S, m/m	$h_L, m$	$h_L/Q$	Q + $\Delta Q$
II (second try)	BC	200	2500	12	0.0015	3.75	0.313	8
	CD	200	600	-8	-0.00075	-0.45	0.056	-12
	BD	300	3000	-12	-0.0002	<u>-0.60</u>	<u>0.050</u>	-16
						2.7	0.419	

$$\text{II: } \Delta Q_2 = -\frac{2.7}{1.85 \times 0.419} \approx -4 \text{ L/s}$$



# Third Trial

Loop	Pipe	D, mm	L, m	Q, L/s	S, m/m	$h_L, m$	$h_L/Q$	Q + $\Delta Q$
I (third try)	AB	300	1000	24	0.0007	0.7	0.029	23
	BD	300	3000	16	0.00034	1.02	0.064	15
	AD	400	3500	-36	-0.0004	<u>-1.4</u>	<u>0.039</u>	-37
						0.32	0.132	.

I:  $\Delta Q_3 = -\frac{0.32}{1.85 \times 0.132} \approx -1 \text{ L/s}$

Loop	Pipe	D, mm	L, m	Q, L/s	S, m/m	$h_L, m$	$h_L/Q$	Q + $\Delta Q$
II (third try)	BC	200	2500	8	0.0007	1.75	0.219	
	CD	200	600	-12	-0.0015	-0.9	0.075	
	BD	300	3000	-15	-0.0003	<u>-0.9</u>	<u>0.06</u>	
						-0.05	0.354	

II:  $\Delta Q_3 = \frac{-0.05}{1.85 \times 0.354} \approx 0.07 \text{ (negligible)}$





# Final Solution

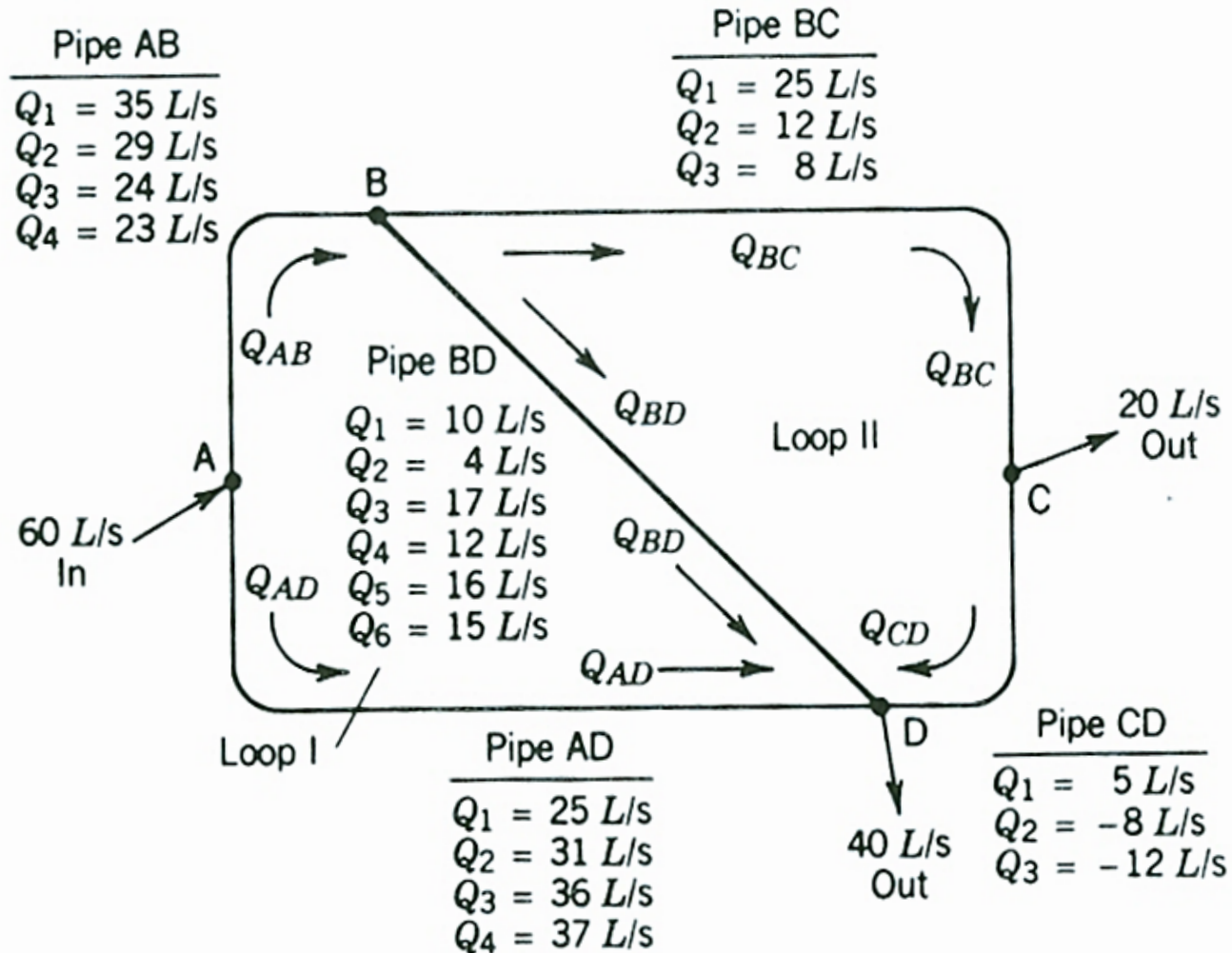

# Water Distribution Modeling

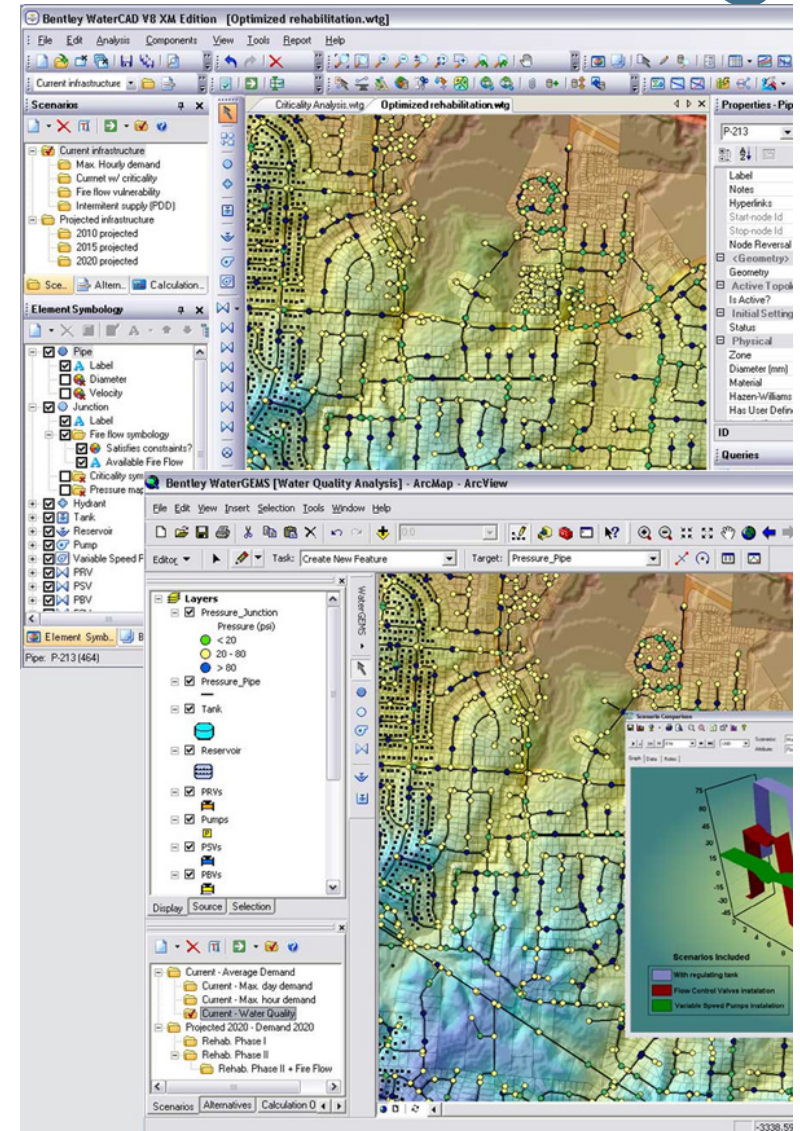
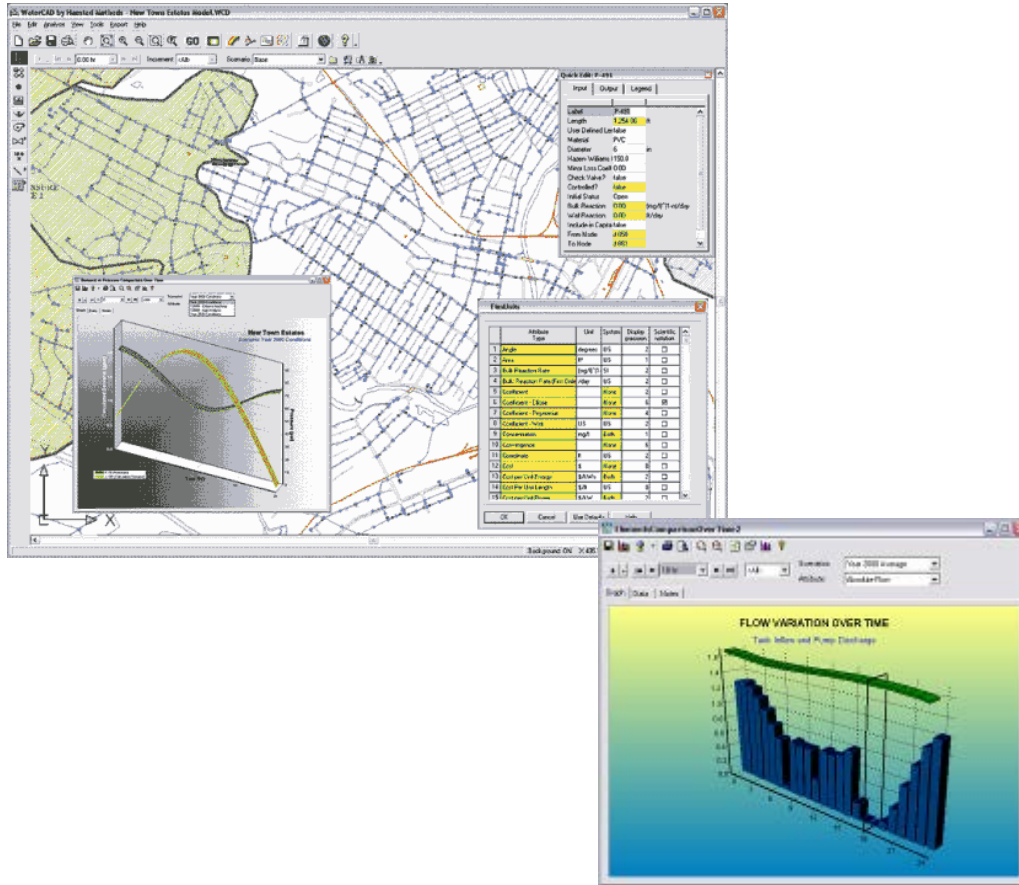

**AAiT**

Water Supply & Urban Drainage  
By Zerihun Alemayehu

# WDS Simulation

- *Simulation*: the process of imitating the behavior of one system through the functions of another.
- refers to the process of using a mathematical representation of the real system, called a *model*.



# WDS Simulation

- **Steady-State:** a snapshot in time and are used to determine the operating behavior of a system under static conditions.
- **Extended Period Simulation (EPS):** used to evaluate system performance over time



# Application of WDMs

- Long-range master planning, both new development and rehabilitation
- Fire protection studies
- Water quality investigations
- Energy management
- System design
- Daily operational uses including operator training, emergency response, and
- troubleshooting



# Model Representation

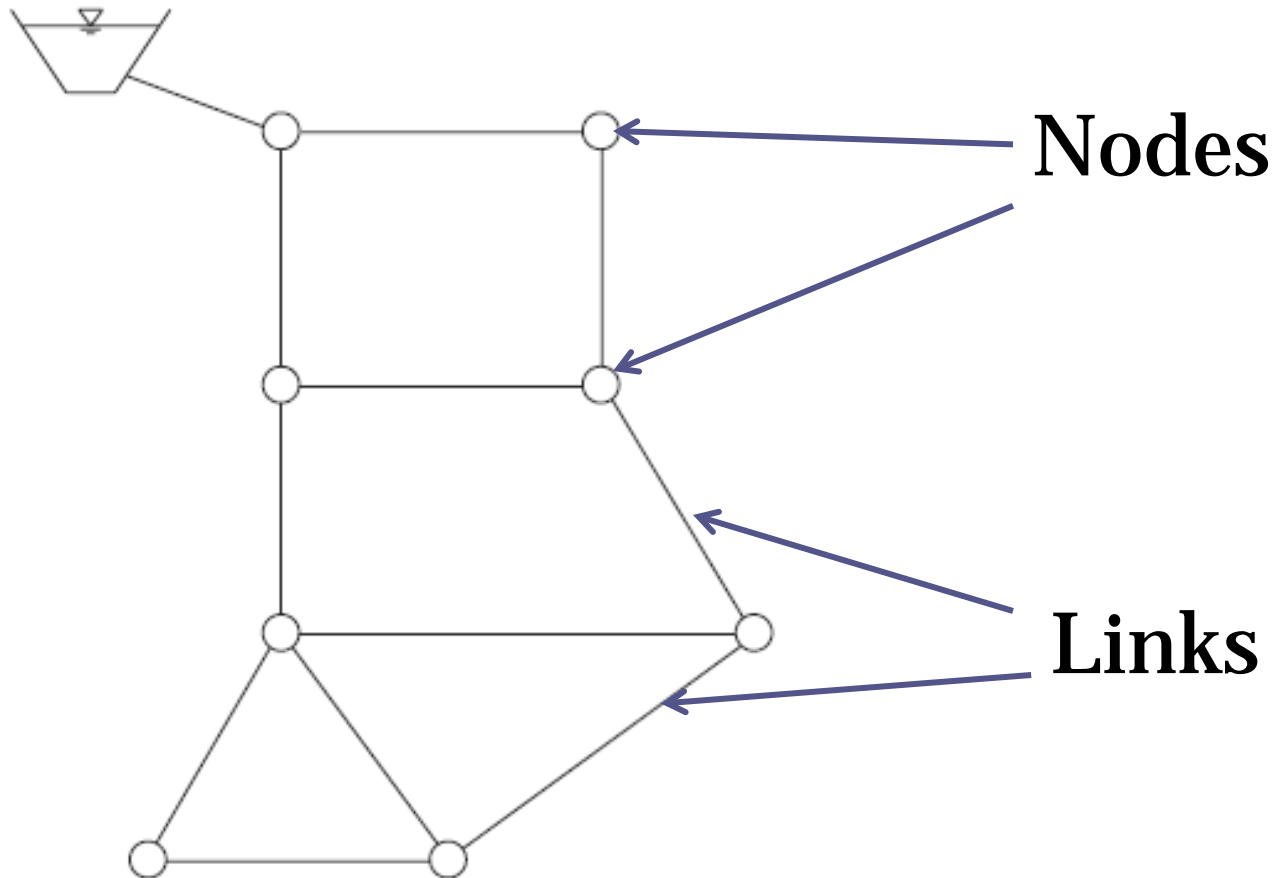

**AAiT**

Water Supply & Urban Drainage  
By Zerihun Alemayehu

# Network Elements

Element	Type	Primary Modeling Purpose
Reservoir	Node	Provides water to the system
Tank	Node	Stores excess water within the system and releases that water at times of high usage
Junction	Node	Removes (demand) or adds (inflow) water from/to the system
Pipe	Link	Conveys water from one node to another
Pump	Node or link	Raises the hydraulic grade to overcome elevation differences and friction losses
Control Valve	Node or link	Controls flow or pressure in the system based on specified criteria



# EPAnet steps

- Project setup

- View >

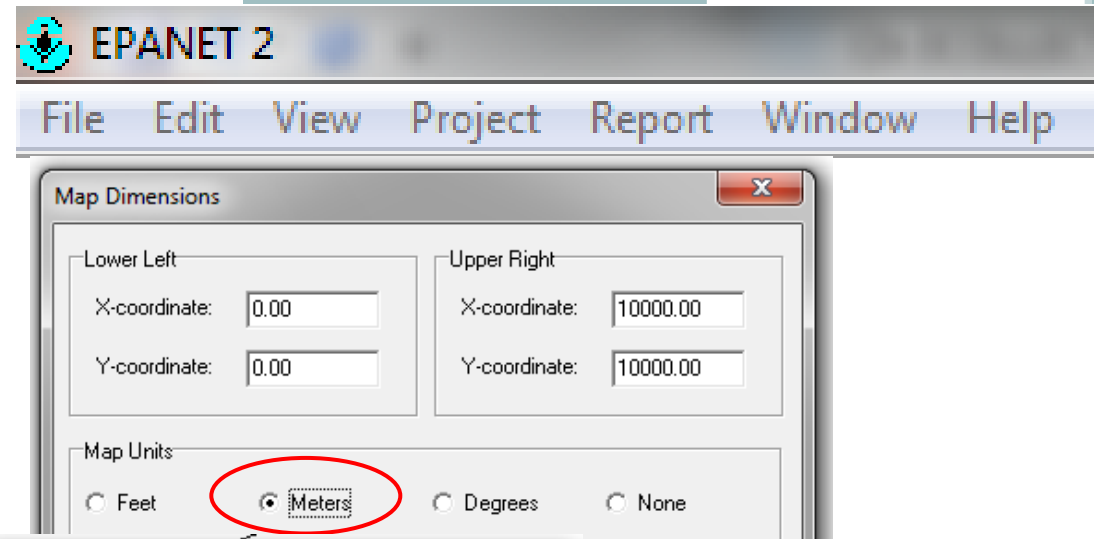
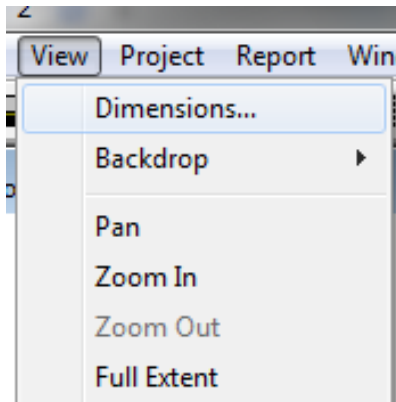

- Project >

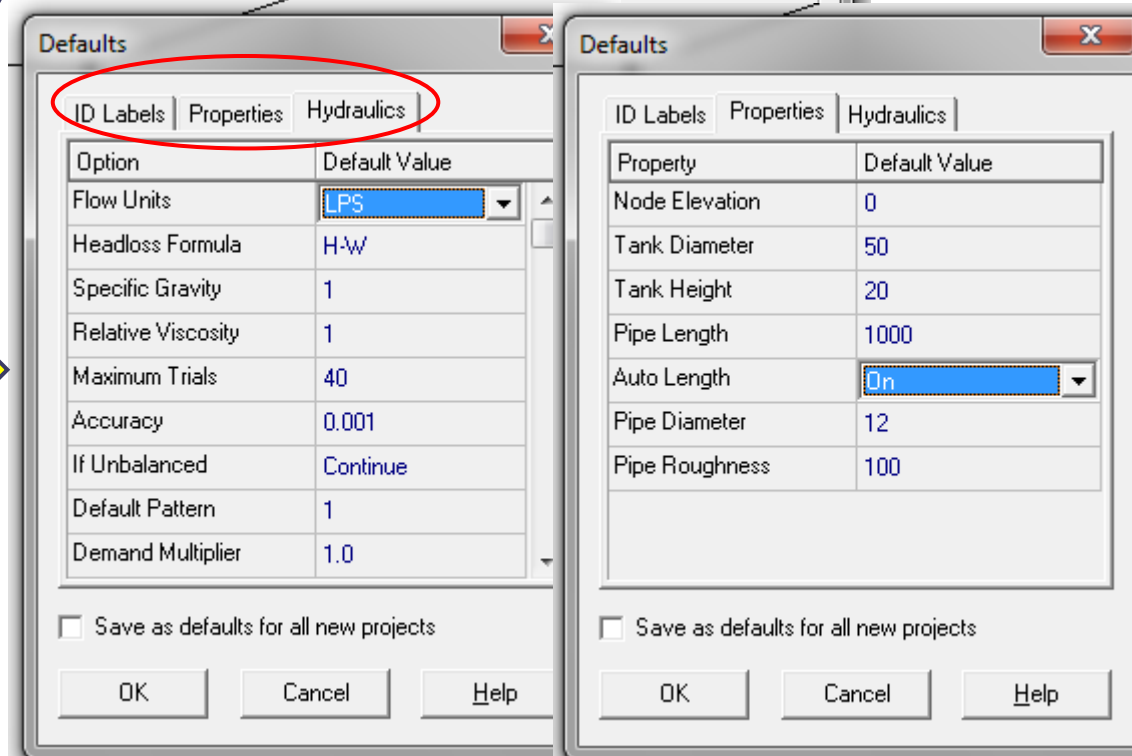
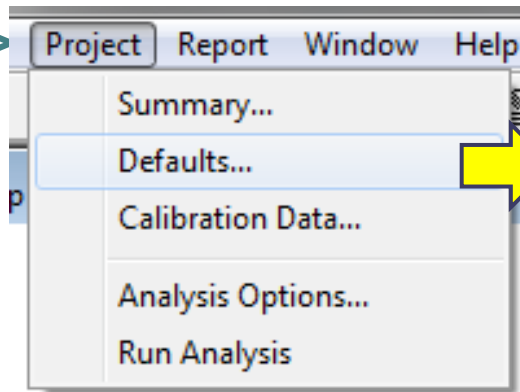



# EPAnet steps ...

- Model building
  - First construct nodes (Reservoirs, tanks, junctions)
  - Then connect links (pumps, pipes, valves)

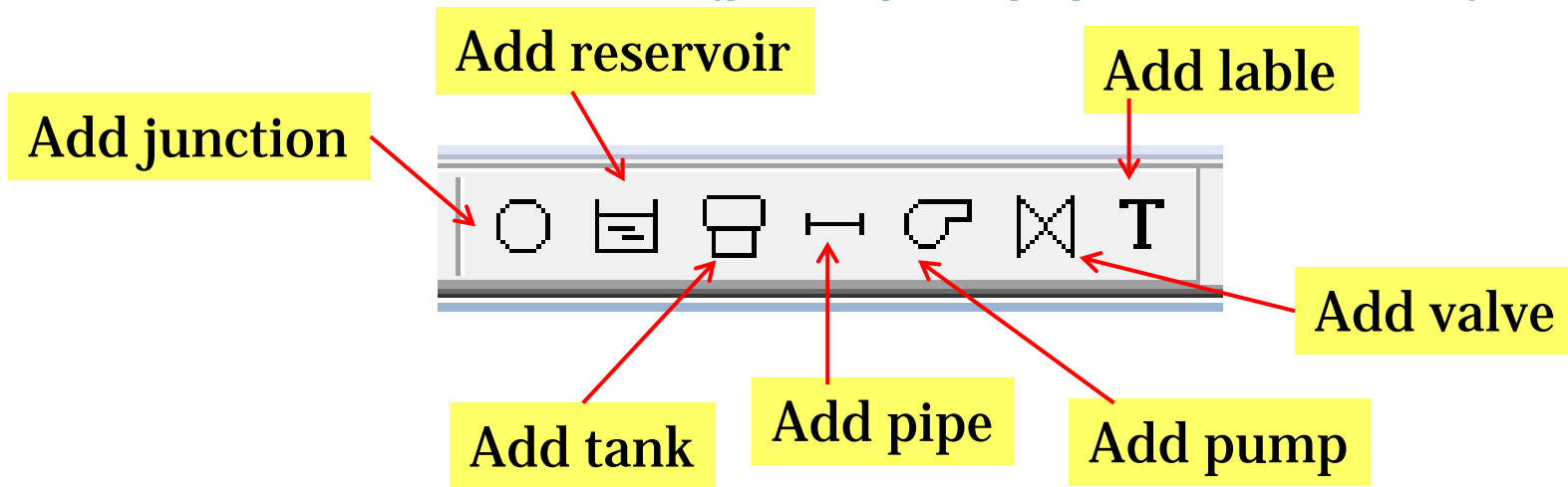

# EPAnet steps ...

- Input data
  - Double click element using selection tool

Selection tool

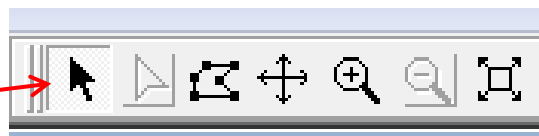

- Modify data in the property box

Property	Value
*Pipe ID	1
*Start Node	1
*End Node	2
Description	
Tag	
*Length	1000
*Diameter	12
*Roughness	100
Loss Coeff	0

Property	Value
*Tank ID	4
X-Coordinate	5722.22
Y-Coordinate	5825.40
Description	
Tag	
*Elevation	0
*Initial Level	10
*Minimum Level	0
*Maximum Level	0

Property	Value
*Reservoir ID	3
X-Coordinate	7198.41
Y-Coordinate	9206.35
Description	
Tag	
*Total Head	0
Head Pattern	
Initial Quality	
Source Quality	



# EPAnet steps ...

- Run the model

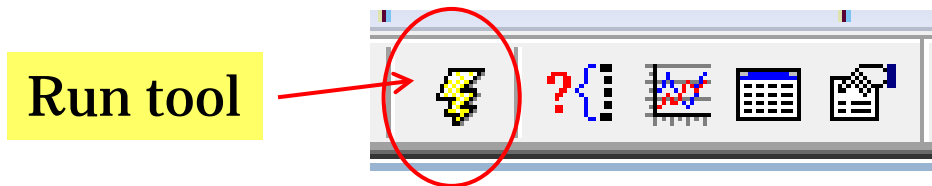

- View result

