

Owner's Guide

คู่มือผู้ใช้

사용자 안내서

用戶指南

使用者指南

دليل المالك

BOSE

WAVE® SOUNDTOUCH® SERIES IV

WIRELESS MUSIC SYSTEM

IMPORTANT SAFETY INSTRUCTIONS

Please read and keep all safety, security, and use instructions.

WARNING/CAUTION



Do not ingest battery, chemical burn hazard. The remote control supplied with this product contains a coin/button cell battery. If the coin/button cell battery is swallowed, it can cause severe internal burns in just in just 2 hours and can lead to death. Keep new and used batteries away from children. If the battery compartment does not close securely, stop using the remote control and keep it away from children. If you think batteries might have been swallowed or placed inside any part of the body, seek immediate medical attention. To avoid risk of explosion, fire or chemical burn, use caution in replacing the battery and replace only with an agency approved (e.g., UL) CR2032 or DL2032 3-volt lithium battery. Properly and promptly dispose of used batteries. Do not recharge, disassemble, heat above 212°F (100°C) or incinerate.

Important Safety Instructions

1. Read these instructions.
2. Keep these instructions.
3. Heed all warnings.
4. Follow all instructions.
5. Do not use this apparatus near water.
6. Clean only with a dry cloth.
7. Do not block any ventilation openings. Install in accordance with the manufacturer's instructions.
8. Do not install near any heat sources such as radiators, heat registers, stoves, or other apparatus (including amplifiers) that produce heat.
9. Protect the power cord from being walked on or pinched particularly at plugs, convenience receptacles, and the point where they exit from the apparatus.
10. Only use attachments/accessories specified by the manufacturer.
11. Unplug this apparatus during lightning storms or when unused for long periods of time.
12. Refer all servicing to qualified personnel. Servicing is required when the apparatus has been damaged in any way, such as power-supply cord or plug is damaged, liquid has been spilled or objects have fallen into the apparatus, the apparatus has been exposed to rain or moisture, does not operate normally, or has been dropped.

WARNINGS/CAUTIONS



This symbol means there is uninsulated, dangerous voltage within the product enclosure that may constitute a risk of electrical shock.



This symbol means there are important operating and maintenance instructions in this guide.



Contains small parts which may be a choking hazard. Not suitable for children under age 3.



This product contains magnetic material. Consult your physician on whether this might affect your implantable medical device.

- To reduce the risk of fire or electrical shock, do NOT expose this product to rain, liquids or moisture.
- Do NOT expose this product to dripping or splashing, and do not place objects filled with liquids, such as vases, on or near the product.
- Keep the product away from fire and heat sources. Do NOT place naked flame sources, such as lighted candles, on or near the product.
- Do NOT make unauthorized alterations to this product.
- Do NOT use in vehicles or boats.
- Where the mains plug or an appliance coupler is used as the disconnect device, the disconnect device shall remain readily operable.
- To avoid hazardous radiation exposure from the internal laser component, use the product only as specified in the instructions. The compact disc player should not be adjusted or repaired by anyone except properly qualified service personnel.
- To prevent electric shock, match the wide blade of the line cord plug to the wide slot of the AC (mains) receptacle. Insert fully.
- The Wave® SoundTouch® music system (the system and SoundTouch® pedestal combination, or the SoundTouch® pedestal itself) is not to be used with the under-cabinet/wall bracket available from Bose.

- Do NOT use the headphones at a high volume for any extended period.
 - To avoid hearing damage, use your headphones at a comfortable, moderate volume level.
 - Turn the volume down on your device before placing the headphones in/on your ears, then turn the volume up gradually until you reach a comfortable listening level.
- The product label is located on the bottom of the product.

Class 1 laser product

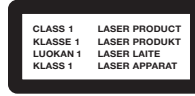

This CD player is classified as a CLASS 1 LASER PRODUCT according to EN / IEC 60825.



Please dispose of used batteries properly, following local regulations.
Do not incinerate.



This symbol means the product must not be discarded as household waste, and should be delivered to an appropriate collection facility for recycling. Proper disposal and recycling helps protect natural resources, human health and the environment. For more information on disposal and recycling of this product, contact your local municipality, disposal service, or the shop where you bought this product.

NOTE: This equipment has been tested and found to comply with the limits for a Class B digital device, pursuant to Part 15 of the FCC Rules. These limits are designed to provide reasonable protection against harmful interference in a residential installation. This equipment generates, uses, and can radiate radio frequency energy and, if not installed and used in accordance with the instructions, may cause harmful interference to radio communications. However, there is no guarantee that interference will not occur in a particular installation. If this equipment does cause harmful interference to radio or television reception, which can be determined by turning the equipment off and on, the user is encouraged to try to correct the interference by one or more of the following measures:

- Reorient or relocate the receiving antenna.
- Increase the separation between the equipment and receiver.
- Connect the equipment into an outlet on a circuit different from that to which the receiver is connected.
- Consult the dealer or an experienced radio/TV technician for help.

Changes or modifications not expressly approved by Bose Corporation could void the user's authority to operate this equipment.

This device complies with part 15 of the FCC Rules and with Industry Canada license-exempt RSS standard(s). Operation is subject to the following two conditions: (1) This device may not cause harmful interference, and (2) this device must accept any interference received, including interference that may cause undesired operation.

This device complies with FCC and Industry Canada radiation exposure limits set forth for general population. This transmitter must not be co-located or operating in conjunction with any other antenna or transmitter.

This device is for indoor use only to reduce the potential for harmful interference to other co-channel systems.

SoundTouch® pedestal: This equipment should be installed and operated with a minimum distance of 8 in. (20 cm) between this device and your body.

CAN ICES-3 (B)/NMB-3(B)

China Restriction of Hazardous Substances Table

Names and Contents of Toxic or Hazardous Substances or Elements						
Part Name	Toxic or Hazardous Substances and Elements					
	Lead (Pb)	Mercury (Hg)	Cadmium (Cd)	Hexavalent (Cr(VI))	Polybrominated Biphenyl (PBB)	Polybrominated diphenylether (PBDE)
PCBs	X	0	0	0	0	0
Metal Parts	X	0	0	0	0	0
Plastic Parts	0	0	0	0	0	0
Speakers	X	0	0	0	0	0
Cables	X	0	0	0	0	0

This table is prepared in accordance with the provisions of SJ/T 11364.

O: Indicates that this toxic or hazardous substance contained in all of the homogeneous materials for this part is below the limit requirement of GB/T 26572.

X: Indicates that this toxic or hazardous substance contained in at least one of the homogeneous materials used for this part is above the limit requirement of GB/T 26572.



Taiwan Restriction of Hazardous Substances Table

Equipment name: Bose® Wave®, Type designation: 417788-WMS						
Unit	Restricted substances and its chemical symbols					
	Lead (Pb)	Mercury (Hg)	Cadmium (Cd)	Hexavalent chromium (Cr+6)	Polybrominated biphenyls (PBB)	Polybrominated diphenyl ethers (PBDE)
PCBs	-	o	o	o	o	o
Metal Parts	-	o	o	o	o	o
Plastic Parts	o	o	o	o	o	o
Speakers	-	o	o	o	o	o
Cables	-	o	o	o	o	o

Note 1: "o" indicates that the percentage content of the restricted substance does not exceed the percentage of reference value of presence.

Note 2: The "-" indicates that the restricted substance corresponds to the exemption.

Security Information

 This product is capable of receiving automatic security updates from Bose. To receive automatic security updates, you must complete the product setup process in the SoundTouch App and connect the product to the Internet. **If you do not complete the setup process, you will be responsible for installing security updates that Bose makes available.**

Please complete and retain for your records

The serial and model numbers are located on the bottom panel.

Serial number: _____

Model number: _____

Please keep your receipt with your owner's guide. Now is a good time to register your Bose product. You can easily do this by going to <http://global.Bose.com/register>

Legal Information

License Disclosures

You can view the license disclosures that apply to the software packages included with your speaker through the SoundTouch® app or by using your product's IP address.

SoundTouch® app

1. From within the app, select ≡ > **Settings > About > Legal.**
2. Select the applicable license type.

IP address

1. Obtain your product's IP address using one of the following methods:
 - **SoundTouch® app:** From within the app, select ≡ > **Settings > About.** Select your speaker to view the IP address.
 - **Wireless router:** Refer to your router owner's guide for more information.
2. On a device connected to your wireless network, open a browser window.
3. Go to **<IP address>/licenses.pdf** to view the applicable license disclosures.

Date of Manufacture: The eighth digit in the serial number indicates the year of manufacture; "8" is 2008 or 2018.

China Importer: Bose Electronics (Shanghai) Company Limited, Part C, Plan 9, No. 353 North Riyang Road, China (Shanghai) Pilot Free Trade Zone

EU Importer: Bose Products B.V., Gorslaan 60, 1441 RG Purmerend, The Netherlands

Taiwan Importer: Bose Taiwan Branch, 9F-A1, No.10, Section 3, Minsheng East Road, Taipei City 104, Taiwan. Phone Number: +886-2-2514 7676

Mexico Importer: Bose de México, S. de R.L. de C.V., Paseo de las Palmas 405-204, Lomas de Chapultepec, 11000 México, D.F. Phone Number: +5255 (5202) 3545

Amazon, Kindle, Fire and all related logos are trademarks of Amazon, Inc. or its affiliates.

Apple, the Apple logo and iTunes are trademarks of Apple Inc., registered in the U.S. and other countries. App Store is a service mark of Apple Inc.

Android, Google Play, and the Google Play logo are trademarks of Google LLC.

The Bluetooth® word mark and logos are registered trademarks owned by Bluetooth SIG, Inc. and any use of such marks by Bose Corporation is under license.

This product contains the iHeartRadio service. iHeartRadio is a registered trademark of iHeartMedia, Inc.

This product is protected by certain intellectual property rights of Microsoft. Use or distribution of such technology outside of this product is prohibited without a license from Microsoft.

This product incorporates Spotify software which is subject to 3rd party licenses found here: www.spotify.com/connect/third-party-licenses

Spotify is a registered trademark of Spotify AB.

SoundTouch and the wireless note design are trademarks of Bose Corporation in the U.S. and other countries.

The distinctive design of the Wave music system is a registered trademark of Bose Corporation in the U.S. and other countries.

Wi-Fi is a registered trademark of Wi-Fi Alliance®.

Windows is a registered trademark of Microsoft Corporation in the United States and other countries.

Bose Corporation Headquarters: 1-877-230-5639

© 2018 Bose Corporation. No part of this work may be reproduced, modified, distributed, or otherwise used without prior written permission.

Initial Setup

What's in the carton..... 5
 Placement guidelines 5
 Connect the system to the pedestal 6
 Connect the system to power..... 6
 Set the clock..... 6

The SoundTouch® App

Download and install the SoundTouch® app 7
 Existing SoundTouch® users..... 7
 Add the system to an existing account..... 7
 Connect the system to a new network..... 7
 SoundTouch® Owner's Center 7

Preset Personalization

Personalize your presets 8
 Understand your presets 8
 Set a preset 8
 Play a preset 8

System Controls

Remote control 9
 Touch pad 10
 Power on the system 10
 Remote control..... 10
 Touch pad 10
 Standby mode..... 10
 Adjust the volume..... 10
 Mute the system..... 10
 Messages on the display 10

Bluetooth® Technology

Connect a mobile device..... 11
 Reconnect mobile device 11
 Connect using the remote control 11
 Connect using the *Bluetooth* feature on the
 paired device 11
 Clear the system's *Bluetooth*
 pairing list 11
 Use the SoundTouch® app..... 11

AM/FM Radio

Listen to AM or FM radio 12
 Tune to an AM/FM station..... 12
 Set AM/FM radio station presets..... 12
 Play an AM/FM radio station preset..... 12
 Improve FM reception..... 12

CDs

Play audio CDs..... 13
 Play MP3 CDs..... 14
 CD Play Modes..... 14

Alarms and Sleep Timer

Set the alarms 15
 View Alarm 1 and Alarm 2 settings 15
 Alarm messages 15
 Turn an alarm on or off 16
 Snooze an alarm..... 16
 Stop and reset a sounding alarm..... 16
 Reset a snoozed alarm for the next day 16
 Set the Sleep timer..... 16
 View the remaining sleep time 16
 Turn off the Sleep timer..... 16

Other Equipment Connections

System connections..... 17
 Connect to an audio device..... 18
 Connect to headphones..... 18
 Connect to an external antenna..... 19

System Personalization

The setup menu..... 20
 Change a system setting..... 20

Advanced Features

Disable Wi-Fi® capability 21
 Re-enable Wi-Fi capability 21
 Restart the SoundTouch® pedestal..... 21
 Reset the SoundTouch® pedestal..... 21

Care and Maintenance

Replace the remote control battery 22
 Clean the system 22
 Customer service 22
 Limited warranty 22
 Technical information 22

Troubleshooting

Common solutions..... 23

Alternate Setup

Set up your system using a computer 24
 Before you begin..... 24
 Computer setup 24

What's in the carton

Carefully unpack the carton and confirm that the following parts are included:

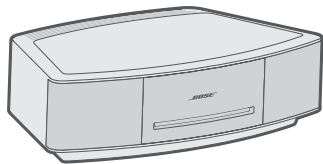

Wave® music system

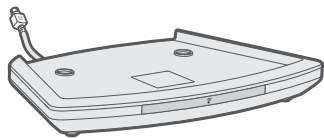

SoundTouch® pedestal



Remote control

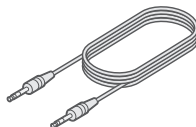

3.5 mm audio cable



Power cord

i May ship with multiple power cords. Use the power cord for your region.

Note: If part of the system is damaged, do not use it. Contact your authorized Bose dealer or Bose customer service. Visit global.Bose.com/Support/WSTIV for contact information.

Placement guidelines

To avoid interference, keep other wireless equipment 1 – 3 ft. (0.3 – 0.9 m) away from your system. Place your system outside and away from metal cabinets, and direct heat sources.

To enjoy maximum audio performance:

- Place the system across the room from your listening area.
- Place the system within two feet of a wall and avoid placing it directly in a corner.
- Place the system on a stable and level surface.
- Do NOT place your system on top of audio/video equipment (receivers, TVs, etc.), any other object that may generate heat or a metal surface. Heat generated by these items may result in poor system performance or interference with AM reception.
- Do NOT use the system in a damp location or any other place where moisture can get inside.
- Do NOT place any objects on top of your system.
- Make sure there is an AC (mains) outlet nearby.

Connect the system to the pedestal

The SoundTouch® pedestal provides the network connection for the Wave® music system.

- Carefully set your Wave® music system on top of the SoundTouch® pedestal:
 - Place the rear feet of the Wave® music system into the recesses on top of the SoundTouch® pedestal.
 - Make sure the Wave® music system sits flat and the side edges of both parts are aligned.

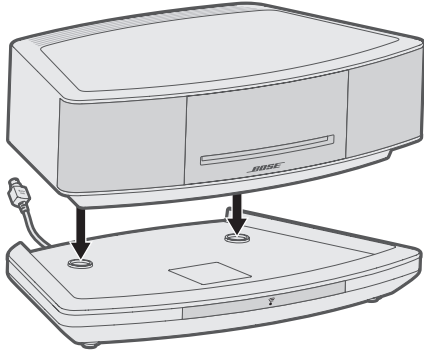

- Insert the SoundTouch® pedestal's cable into the **Bose link** connector.

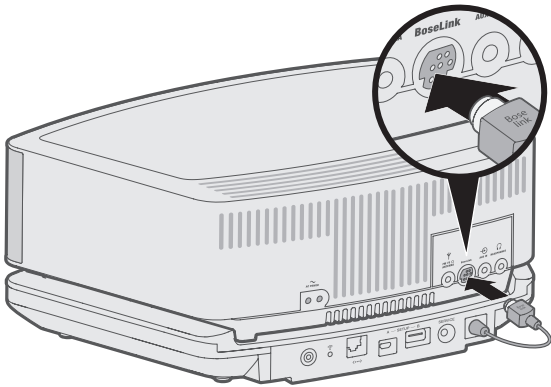

Connect the system to power

Before you set up the system on your network, connect the system to power.

- Insert the small end of the AC power cord into the **AC POWER** connector.
- Plug the power cord into an AC (mains) power outlet.

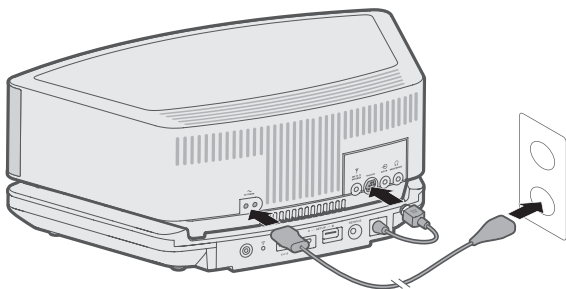

Set the clock

- Press and hold either **TIME -** or **TIME +** for one second.

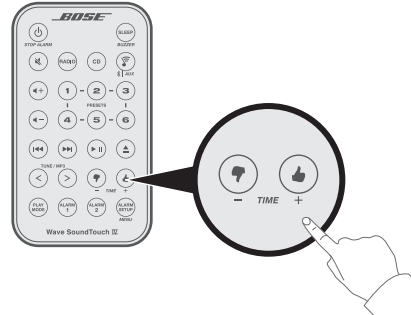

HOLD TO SET appears on the display.



- Release the selected **Time** button.
- CLOCK SET - appears on the display.



- Press **TIME -** to adjust the time backward or press **TIME +** to adjust the time forward.
- After five seconds, the system exits the clock setup mode.

Notes:

- The clock cannot be set in the SoundTouch® or Bluetooth® source.
- To change the clock display from 12-hour (AM/PM) time to 24-hour time, see "System Personalization" on page 20.
- If the system loses power due to a power outage or if unplugged, all system settings are permanently retained and the clock time is temporarily stored in backup memory (up to 48 hours).

The SoundTouch® app lets you set up and control SoundTouch® from your smartphone, tablet or computer. Using the app, your smart device acts as a remote for your system.

From the app, you can manage your SoundTouch® settings, add music services, explore local and global Internet radio stations, set and change presets, and stream music. New features are added periodically.

Note: If you have already set up SoundTouch® for another system, see "Add the system to an existing account."

Download and install the SoundTouch® app

On your smartphone or tablet, download the SoundTouch® app.



SoundTouch® app

- **Apple users:** download from the App Store
- **Android™ users:** download on the Google Play™ store
- **Amazon Kindle Fire users:** download from the Amazon Appstore for Android



Follow the instructions in the app to complete setup, including adding the system to your Wi-Fi network, creating a SoundTouch® account, adding a music library, and using music services.

For instructions on using a computer for setup, see page 24.

Tip: Once you set up the system on your home Wi-Fi network, you can control it from any smartphone or tablet on the same network. Download the SoundTouch® app on the smart device. You must use the same SoundTouch account for all devices connected to your system.

Existing SoundTouch® users

If you have already set up SoundTouch® on another speaker, you do not need to download the SoundTouch® app again.

Add the system to an existing account

From within the app, select  > **Settings** > **Add or Reconnect Speaker**.

The app guides you through setup.

Connect the system to a new network

If your network information changes, add your system to your new network. You can do this by putting your system into setup mode.

1. From within the app, select  > **Settings** > **Speaker Settings** and select your system.
2. Select **CONNECT SPEAKER**.

The app guides you through setup.

SoundTouch® Owner's Center

 global.bose.com/Support/WSTIV

This website provides access to the owner support center, which includes: owner's manuals, articles, tips, tutorials, a video library, and the owner community where you can post questions and answers.

Personalize your presets

You can personalize six presets to your favorite streaming music services, stations, playlists, artists, albums or songs from your music library. You can access your music, at any time, with a simple touch of a button on the remote control.

Understand your presets

- You can set presets from the app and the remote control.
- If the preset source is your iTunes or Windows Media Player music library, make sure the computer storing your music library is on and connected to the same network as the SoundTouch® system.
- You cannot set presets in *Bluetooth* mode or *AUX* mode.

Set a preset

1. Stream music to the system using the app.
2. While the music is playing, press and hold a preset on the remote control (two seconds).

The system emits a tone when the preset is set.

Play a preset

Once you personalize your presets, select a preset using the remote control or the app to play it.

1. Using the remote control, press and release  until **SOUNDTOUCH** appears on the display.
2. Press a preset.

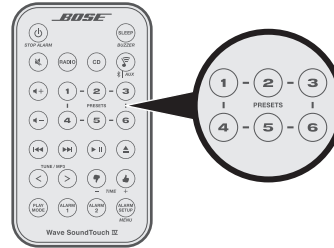

Music plays on the system. Information appears on the display, which may include song or station depending on the source.

Remote control

Use the remote control to select music sources connected to your system, use playback functions, adjust the system volume and navigate the setup menu (see page 20).

Note: Press-and-hold operations require holding the button down for two seconds.

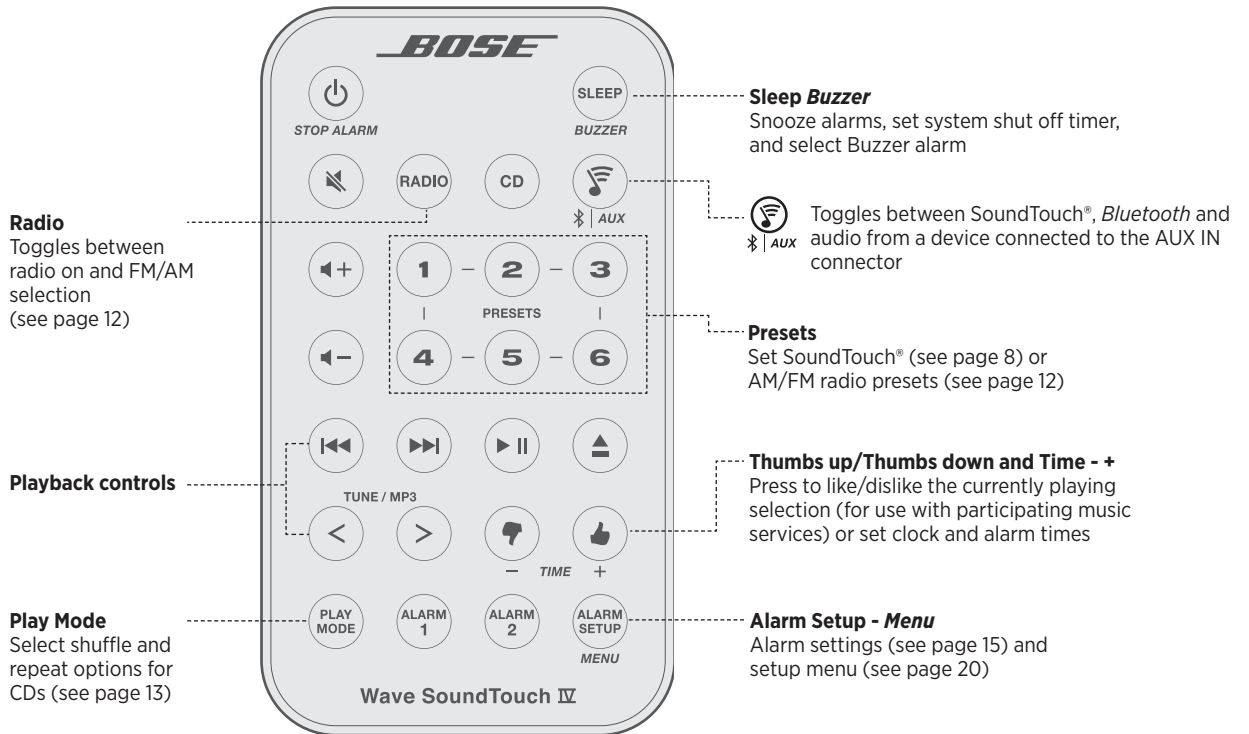

Touch pad

The system has a touch-sensitive control pad on the front, center area of the top panel.

Gently tapping the touch pad:

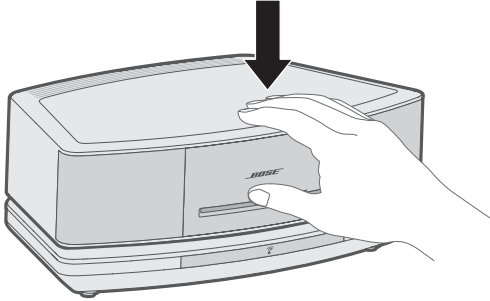

- Powers on or off the system.
- Snoozes an alarm (see page 16).
- Resets an alarm for the next day (see page 16).



Power on the system

There are two ways to power on the system:

Remote control

- Press  STOP ALARM.
- Press **RADIO**, **CD** or  to power on the system to the selected source.

Note: Selecting  AUX does not power on a cabled audio device. Make sure to power on the device first.

Touch pad

Tap the touch pad. The last source you listened to is active.



Standby mode

If the button is not pressed after 24 hours, the system switches to standby (off). If the 18-minute system standby timer is enabled, the system automatically switches to standby if no audio is played and no buttons are pressed for 18 minutes. For more information on the 18-minute system standby timer see "System Personalization" on page 20.

If the system is connected to your network when switching to standby, the connection is maintained.

Adjust the volume

On the remote control:

- Press  + to increase the volume.
- Press  - to decrease the volume.

VOLUME - 0 (silent) to **99** (loud) appears on the display to indicate the level.

When the system is off, the volume can only be adjusted between 10 and 75.

Mute the system

Press  to mute or unmute the audio.

Note: While muted, you can press  - to lower the volume before unmuting the system.

Messages on the display

Source indicators:
CD, FM, AM, or AUX

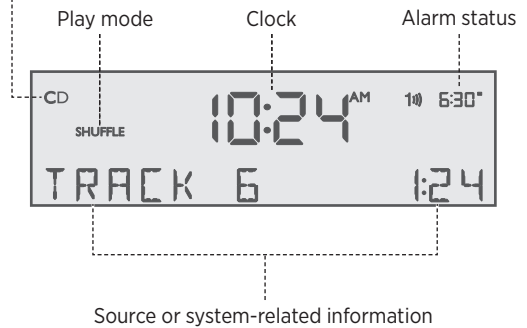

Connect a mobile device

Bluetooth wireless technology enables you to stream music from *Bluetooth* smartphones, tablets, computers or other audio devices to your SoundTouch® system.

Before you can stream music from a mobile device, you must connect the device with system.

1. On the remote control, press and release  *AUX* until “Ready to connect” appears on the display.

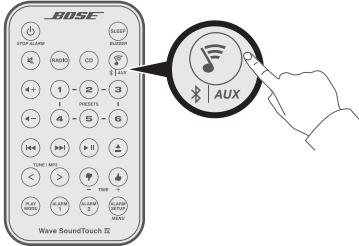

Tip: You can also press and hold  *AUX* for one second to connect a device.

2. On your mobile device, turn on the *Bluetooth* feature.

Tip: The *Bluetooth* feature is usually found in the Settings menu.

3. Select your Wave system from the device list.



Tip: Look for the name you entered for your Wave system in the SoundTouch® app. If you didn't name your Wave system, the default name appears.

Once connected, the system emits a tone.

Reconnect mobile device

You can stream audio from a mobile device to the system. If there are multiple paired devices within range, your system connects to the most recent paired device that streamed to it. It may take a minute or two for the paired device to connect. Your system's display indicates connection status.

Connect using the remote control

1. On the remote control, press and release  *AUX*, until a *Bluetooth* searching message appears on the display.

The system connects to the most recent paired device within range of your system. If that device is not within range, the system goes through its list of paired devices until it finds an available device.

2. On the device, play music.

Note: If a mobile device is connected to your system and you want to connect to a different mobile device, see “Connect a mobile device.”

Connect using the *Bluetooth* feature on the paired device

1. On the mobile device, turn on the *Bluetooth* feature.
2. Select your SoundTouch® system from the device list.

Your system powers on and emits a tone.

Clear the system's *Bluetooth* pairing list

When you connect a mobile device to the system, the connection is stored in the system's pairing list. You may need to clear the pairing list if you cannot connect to a device. Once you clear the list, you need to connect the device again.

On the remote control, press and hold  *AUX* (about 10 seconds) until a pairing list cleared message appears on the display.

The system is ready to connect to a device.

Use the SoundTouch® app

You can also clear the pairing list using the app.

1. From within the app, select  > **SETTINGS** > **Speaker Settings** and select your system.
2. Open the *Bluetooth* menu item and clear the pairing list.

Listen to AM or FM radio

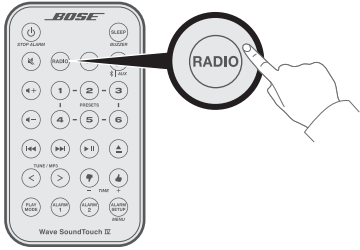

On the remote control, press **RADIO** to power on the system to the station last selected. Press and release **RADIO** to toggle between FM or AM radio.

When you select FM radio, Radio Data System (RDS) information for the current station appears. This is controlled by the RADIO TEXT setting in the setup menu. To disable RDS and view only the station frequency, change the RADIO TEXT setting to OFF (see "System Personalization" on page 20).

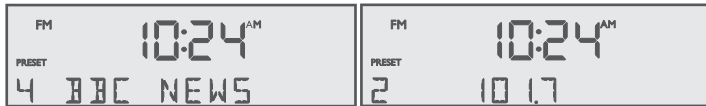

RDS ON (RADIO TEXT- ON)

RDS OFF (RADIO TEXT- OFF)

Tune to an AM/FM station

The station frequency appears in the center of the display while you are tuning.



Button	Function
⏪	Find a lower-frequency station with a strong signal.
⏩	Find a higher-frequency station with a strong signal.
TUNE / MP3 <	<ul style="list-style-type: none"> Manually tune to a lower frequency. Press and hold to rapidly lower the frequency.
TUNE / MP3 >	<ul style="list-style-type: none"> Manually tune to a higher frequency. Press and hold to rapidly increase the frequency.

Note: If AM reception is weak, rotate the system clockwise or counterclockwise to improve AM reception. If FM reception is weak, straighten the power cord as much as possible. To improve FM reception, you can install an external FM antenna (see page 19).

Set AM/FM radio station presets

You can store up to six AM and six FM radio stations for quick recall using the presets. Storing a preset replaces any station previously stored to that preset number.

1. Tune to the station you want to save as a preset.
2. Press and hold a preset until you hear a double tone.

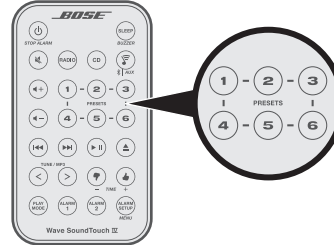

The preset number and station frequency appear on the display.

Play an AM/FM radio station preset

Press a preset on the remote control to tune to a previously stored FM or AM station.

Improve FM reception

Unwind and straighten the power cord to ensure the best FM radio reception. The power cord is used as an antenna.

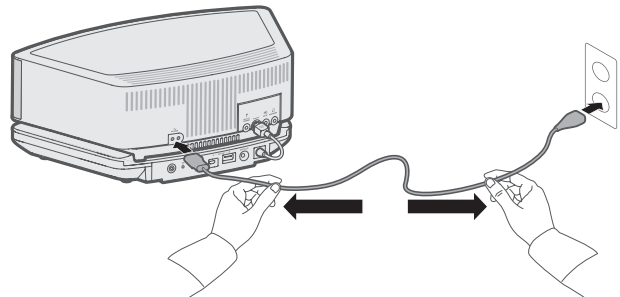

Play audio CDs

Insert the disc, label side up, into the CD slot below the display.

The disc player pulls the disc in and begins playing.

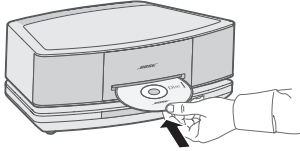

Note: On the remote, press **CD** if the CD source is not selected.

When a CD is playing, CD source information appears on the display:

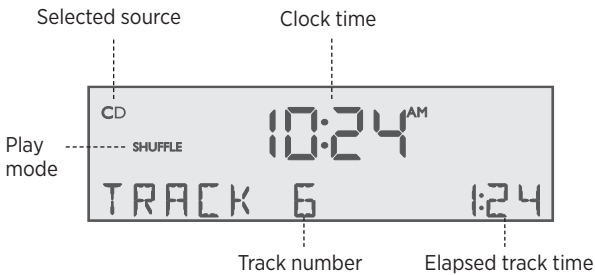

Button	Function
▶	Toggle between playing or pausing audio.
◀◀	<ul style="list-style-type: none"> Skip to the beginning of the current track. Press twice to skip to the beginning of the previous track.
▶▶	Skip to the next track.
TUNE / MP3 <	Press and hold to rewind through a track.
TUNE / MP3 >	Press and hold to fastforward through a track.
⏏	<ul style="list-style-type: none"> Stop a CD. Press again to eject a CD. Press and hold to eject a CD.

Notes:

- When you play a stopped CD it always resumes from the place it was stopped.
- If you eject a CD but do not remove it from the CD player slot within 10 seconds, the CD player pulls the CD back into the player and reloads it.

CAUTION: Do NOT insert mini CDs or non-circular CDs into the disc player. These discs may not play properly and could interfere with the system's ability to eject them.

Play MP3 CDs

The system can play MP3 music files recorded on CD-R and CD-RW discs.

Button	Function
⏮	<ul style="list-style-type: none"> Skip to the beginning of the current track. Press twice to skip to the beginning of the previous track.
⏭	Skip to the next track.
TUNE / MP3 <	Skip to the previous folder.
TUNE / MP3 >	Skip to the next folder.

When navigating an MP3 CD, folder number and track number appear on the display:



Folder number Track number

The Root level appears as folder number 00. Once the track begins playing, artist name, song title and elapsed track time appear on the display:



Artist name and song title Elapsed track time

Notes:

- Artist name and song title information appear on the display when available on music file CDs.
- The audio quality of MP3 CDs depends on factors such as the encoded bit rate, the sampling rate and the type of encoder used. The system supports MP3 CDs encoded at bit rates of 64kbps or higher, and sampling rates of 32kHz or higher. Bose recommends that a bit rate of at least 128kbps and a sampling rate of 44.1kHz or better be used.
- Playback quality of recorded CD-R and CD-RW discs depends on the CD recording process and software used to record the disc. An improperly recorded audio CD may cause the system to exhibit unexpected behavior.

CD Play Modes

Press and release **PLAY MODE** to select a play mode:

Mode	CD	MP3	Description
NORMAL PLAY	✓	✓	Plays tracks once in sequential order.
SHUFFLE DISC	✓	✓	Plays all tracks once in random order.
SHUFFLE RPT	✓		Repeats all tracks in a random order that changes each time the disc is repeated.
REPEAT DISC	✓	✓	Repeats the disc from the beginning after the last track is played.
REPEAT TRACK	✓	✓	Repeats the selected track continuously.
SHUFFLE FLDR		✓	Plays all tracks in the selected folder in random order (MP3 only).
SHUF RPT FDR		✓	Repeats all tracks in the selected folder in random order (MP3 only) that changes each time the folder is repeated.
SHUFF RPT CD		✓	Repeats all tracks on a disc in a random order that changes each time the disc is repeated.
REPEAT FOLDR		✓	Repeats all tracks in a folder in order (MP3 only).

Note: The play mode returns to NORMAL PLAY whenever a CD is inserted.

The system has two independent alarms: **ALARM 1** and **ALARM 2**.

Each alarm can be set for:

- Time
- Wake-up source: buzzer, radio, CD or SoundTouch®
- Volume



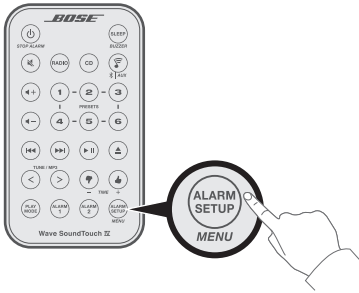

Set the alarms

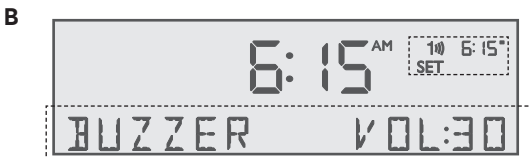
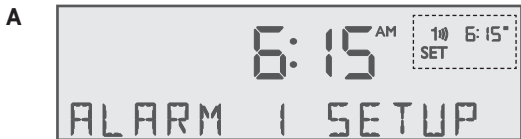

1. Press .



The alarm number and time flash (A), then Alarm 1 settings appear on the display (B).



2. Press  or  to set the alarm time.
- TIME TIME +
3. Select your wake-up source:
 - Press  to choose the buzzer (factory alarm setting).
 - Press **RADIO** to choose a radio station or radio preset.
 - Press **CD** to choose a track.
 - Press  to choose a SoundTouch® preset.
- When using SoundTouch®, you can only select a preset as a wake-up source.

4. Press  or  to adjust the volume level of a wake-up source.
5. Press  to enter the Alarm 2 setup mode.

Repeat Steps 2 - 4 to set up Alarm 2.

6. Press  again to exit the Alarm Setup mode.

The alarm time is set and appears on the display:



View Alarm 1 and Alarm 2 settings

1. Press  to activate the Alarm Setup mode and view Alarm 1 settings.
2. Press again to view Alarm 2 settings.
3. Press again to exit the Alarm Setup mode.

Alarm messages

When the alarm is set, alarm messages appear in the upper right-hand corner of the display.

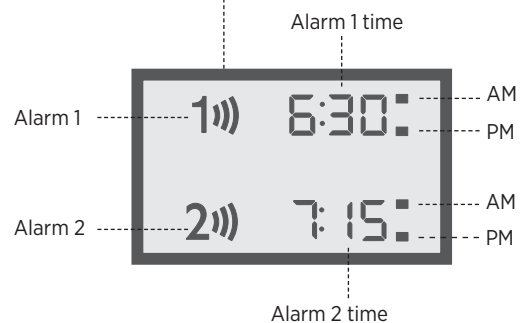

Turn an alarm on or off

Press **ALARM 1** and **ALARM 2** to turn the selected alarm on or off.

When an alarm is turned on, the alarm number and time appear in the upper right corner of the display.

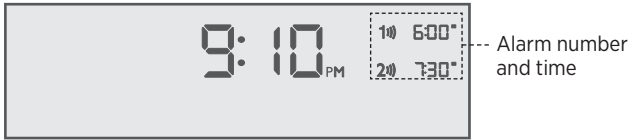

Snooze an alarm

Tap the touch pad or press **SLEEP BUZZER**.

SNOOZE appears for the duration of the selected snooze time and then the alarm sounds again.



The snooze time is set at the factory to 10 minutes. To change the snooze time, see "System Personalization" on page 20.

Stop and reset a sounding alarm

Press **STOP ALARM**.

Reset a snoozed alarm for the next day

After snoozing the alarm, place your hand on the touch pad again and hold it there for at least 2 seconds or press **STOP ALARM**.

STOP ALARM

Set the Sleep timer

The sleep timer sets the system to power off after a set period of time.

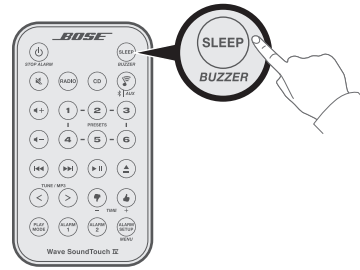

Press and release **SLEEP BUZZER** to set the sleep timer in 10 minute increments (10 - 90 minutes). The default factory setting is 30 minutes.

After 10 seconds, the system exits the sleep timer setup mode.

Note: If the system is powered off, pressing **SLEEP BUZZER** enters the sleep timer mode.

View the remaining sleep time

After setting the sleep timer, press **SLEEP BUZZER** to view the remaining sleep time.

Turn off the Sleep timer

Press and release **SLEEP BUZZER** until **SLEEP - OFF** appears on the display.

System connections

The connector panel provides connections for external equipment.

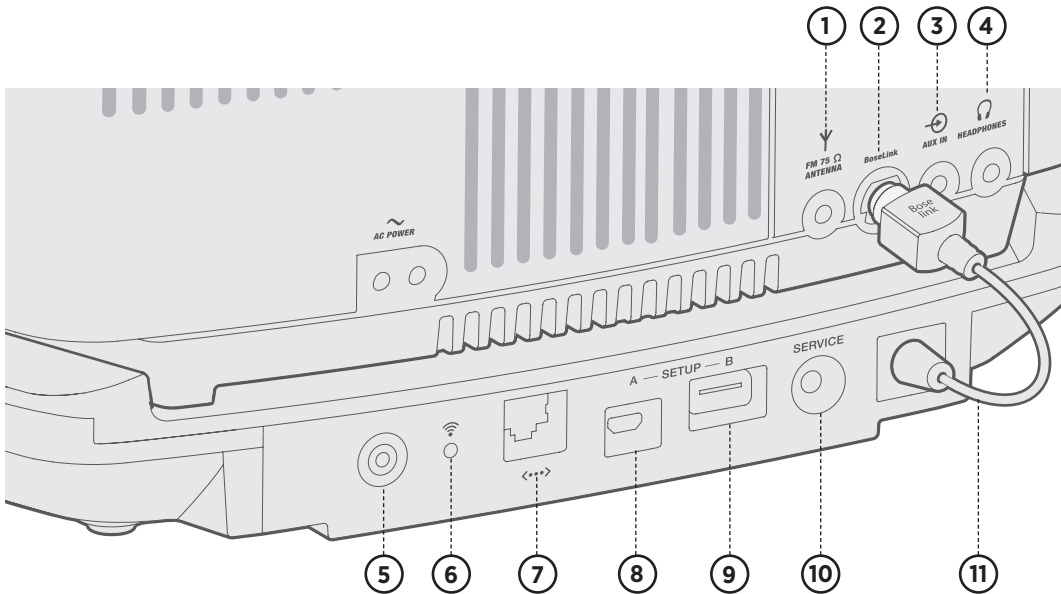

- 1 ANTENNA**
3.5 mm FM antenna (75 ohm) connector (see page 19).
- 2 BoseLink connector**
Input connector for the SoundTouch® pedestal.
- 3 AUX IN connector**
3.5 mm stereo input connector for external sources (see page 18).
- 4 HEADPHONES**
3.5 mm input connector for headphones (see page 18).
- 5 Control button**
Disables Wi-Fi, initiates setup mode or restarts the SoundTouch® pedestal (see page 21).
- 6 Wi-Fi indicator:**

 - **Blinking white** – Searching for Wi-Fi network
 - **Solid white (dim)** – Power-saving mode and connected to Wi-Fi network
 - **Solid white (bright)** – System is on and connected to Wi-Fi network
 - **Solid amber** – System is in setup mode
 - **Off** – Wi-Fi networking disabled or system is connected to Ethernet
- 7 Ethernet connector**
Used for a wired network connection.
- 8 SETUP A**
USB Micro-B connector for network setup using a computer.
- 9 SETUP B***
USB Standard A connector reserved for future use.
- 10 SERVICE connector**
Used for special service functions. Not for customer use.
- 11 SoundTouch® pedestal Bose link cable**
Plugs into the Bose link connector. It provides power and control signals to the SoundTouch® pedestal.

*The USB connectors are not designed to charge smartphones, tablets or similar devices.

Connect to an audio device

When using a TV, DVD player, computer, video game or other audio device, you can enhance your listening experience by playing the audio device through the system.

Connecting an audio device to the system requires one of the following cables:



3.5 mm audio cable

OR





3.5 mm to RCA cable

To obtain the correct cable, contact Bose customer service or visit a local electronics store.

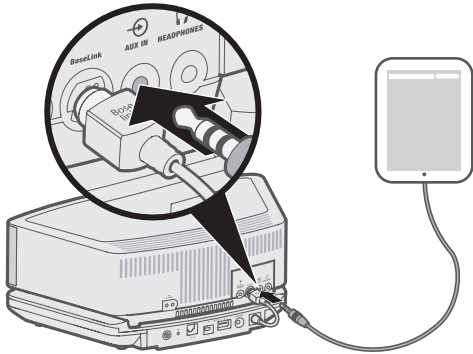
- Using a cable, connect your audio device to the **AUX IN** connector on the system's connector panel.



- On the remote control, press and release  until **AUX** appears on the display.
- Start playing music on the audio device.
- Press  or  to adjust the volume.

Note: If the volume level of the system cannot be adjusted high enough, increase the volume level of the connected audio device.

Connect to headphones

For private listening, insert your headphones into the headphone connector.

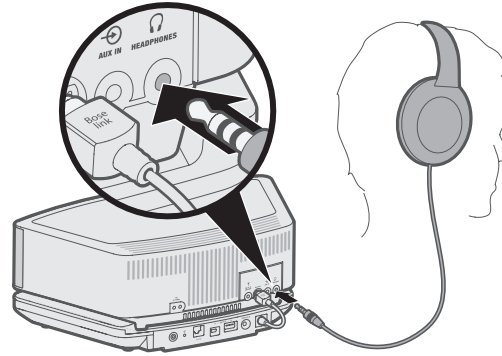

CAUTION: Long-term exposure to loud music may cause hearing damage. It is best to avoid extreme volume when using headphones, especially for extended periods.

Notes:

- The system speakers are muted when you plug in your headphones and unmuted when you disconnect the headphones. Because headphone volume levels may vary from speaker volume levels, lower the volume of the system before connecting or disconnecting headphones.
- If an alarm sounds while using headphones, it sounds through the system speakers.

Adjust the headphones' volume

Press  or  to adjust the volume of your headphones.

Connect to an external antenna

The system's power cord is used as an antenna for FM radio. If, after adjusting the position of the power cord, you still experience poor reception, you may need to install an external antenna. An external dipole antenna can be ordered through Bose Customer Service. Visit global.Bose.com/Support/WSTIV for contact information.

1. Insert the 3.5 mm plug of the FM antenna into the **FM ANTENNA** connector on the rear of the system.
2. Extend the ends of the antenna as far from the unit and other external equipment as possible to establish optimum reception

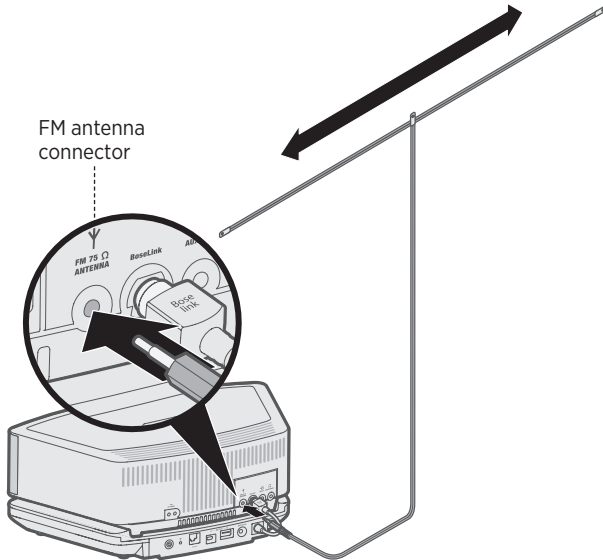





Note: Many FM radio stations transmit a vertically polarized signal as well as, or instead of, a horizontally polarized signal. If the horizontal antenna orientation does not provide good reception, try hanging the antenna in a vertical orientation.

The setup menu

Use the setup menu to customize system operation.

System setting	Menu item	Factory setting	Choices	Description
Snooze duration	SNOOZE-	10 MIN	10 MIN, 20 MIN, 30 MIN, 40 MIN, 50 MIN, 60 MIN	Determines the snooze time duration.
Radio Data System (RDS) information	RADIO TEXT-	ON	ON, OFF	Enables (ON) or disables (OFF) the system to display RDS information.
Continuous play	CONT PLAY-	NO	NO, AUX, FM, AM	Determines which source plays after a CD ends.
Bass level	BASS-	NORMAL	NORMAL, REDUCED	Adjusts the bass level.
Clock time format	TIME-	12 HOUR	12-HOUR, 24-HOUR	Sets the clock display for 12-hour (AM/PM) or 24-hour time.
Display high brightness level	BRIGHT HI-	10	8-15	Sets the display brightness level when the unit detects high ambient light conditions.
Display low brightness level	BRIGHT LO-	4	1-8	Sets the display brightness level when the unit detects low ambient light conditions.
Room code (Not applicable when using the SoundTouch® pedestal.)	ROOM-	B _ _ _ -	B _ _ _ -, C _ _ _ -, D _ _ _ -, E _ _ _ -, F _ _ _ -, G _ _ _ -, H _ _ _ -, I _ _ _ -, J _ _ _ -, K _ _ _ -, L _ _ _ -, M _ _ _ -, N _ _ _ -, O _ _ _ -	Sets the room code for the Wave® SoundTouch® music system when it is connected to a Bose link network. The dashes following the room letter indicate how the microswitches should be set on a Lifestyle® remote control.
Capacitive touch control	TOUCH PAD-	ON	ON, OFF	Enables (ON) or disables (OFF) the touch pad.
18-minute system standby timer	AUTO OFF-	YES	YES, NO	Enables (YES) or disables (NO) the 18-minute system standby timer (see page 10).
Factory reset	RESET ALL-	NO	NO, YES	Restores the system to factory settings.

Change a system setting

1. Press and hold  until **-SETUP MENU-** appears on the display.
2. Press  until the item you want to change appears on the display.
3. Press  or  to change the value or selection.
4. Press  to exit the setup menu or wait 10 seconds for the setup menu to close.

Disable Wi-Fi® capability

1. Press and hold the pedestal's **Control** button (8 - 10 seconds).
2. When the Wi-Fi indicator turns off, release the **Control** button.

Re-enable Wi-Fi capability

Power on the system using the remote control.

Restart the SoundTouch® pedestal

On the back of the SoundTouch® pedestal, press and hold the **Control** button for more than 10 seconds and then release it. After several seconds the pedestal should turn on again and reconnect with your network.

Note: Restart does not affect your SoundTouch® presets or your saved network credentials.

Reset the SoundTouch® pedestal

Factory reset clears all source, volume and network settings from the system and returns it to original factory settings.

Your SoundTouch® account and presets still exist but are not associated with the system unless you use the same account to set up the system again.

1. Make sure that the SoundTouch® pedestal cable is inserted into the Bose link connector.
2. Disconnect the system from power.
3. Press and hold the **Control** button on the back of the SoundTouch® pedestal.
4. While pressing and holding the **Control** button, reconnect power.
5. Hold the **Control** button for five seconds.
The system restarts.
6. Open the SoundTouch® app and add the system to your network (see page 7).

Replace the remote control battery

1. Place the remote face down on a flat surface.
2. Using your finger, push the tab lock to the side as shown and hold. Slide the battery compartment open.

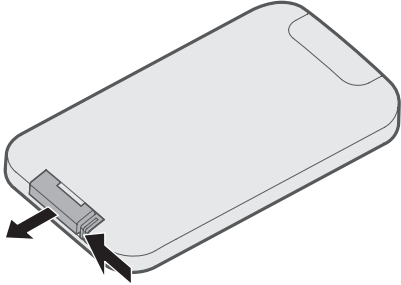

3. Remove the old battery and install the new one with the plus (+) symbol facing up.

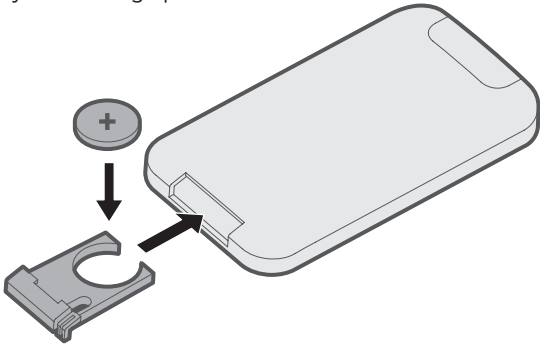

4. Gently slide the battery compartment closed. It locks automatically.

WARNING: Keep new and used batteries away from children. Do not ingest battery, chemical burn hazard. The remote control supplied with this product contains a coin/button cell battery. If the coin/button cell battery is swallowed it can cause severe internal burns in just two hours and can lead to death. If the battery compartment does not close securely, stop using the product and keep it away from children. If you think the battery may have been swallowed or placed inside any part of the body, seek immediate medical attention. The coin/button cell battery may explode or cause a fire or chemical burn if incorrectly replaced or mishandled. Do not recharge, disassemble, heat above 212°F (100°C), or incinerate. Replace only with an agency approved (ex. UL) CR2032 or DL2032 3-volt lithium battery. Dispose of used batteries promptly.

Clean the system

- Clean the surface of the system with a soft, dry cloth. You can also lightly vacuum the grille on the system.
- Do not use any sprays near the system. Do not use any solvents, chemicals or cleaning solutions containing alcohol, ammonia or abrasives.
- Do not allow liquids to spill into any openings.

Customer service

For additional help using the system, visit:
global.Bose.com/Support/WSTIV

Limited warranty

Your Bose® Wave® SoundTouch® music system is covered by a limited warranty. Visit our website at global.Bose.com/warranty for details of the limited warranty.

To register your product, visit global.Bose.com/register for instructions. Failure to register will not affect your limited warranty rights.

Technical information

AC power rating



220V-240V ~ 50/60Hz 60W max.

If you experience problems with your system:

- Connect your system to AC (mains) power.
- Secure all cables.
- Secure the SoundTouch® pedestal to the Bose link connector.
- Tap the touch pad on the top of the system or use the remote to power on the system.
- Move your system and mobile device away from possible interference (wireless routers, cordless phones, televisions, microwaves, etc.).
- Move your system within the recommended range of your wireless router or mobile device for proper operation.
- Reset the system: Unplug the power cord from the AC wall outlet for 10 seconds and then reconnect.

If you could not resolve your issue, see the table below to identify symptoms and solutions to common problems. If you are unable to resolve your issue, contact Bose customer service.

Common solutions

Problem	What to do
Cannot complete network setup	<ul style="list-style-type: none"> • Select correct network name and enter password. • Connect the device and SoundTouch® system to the same Wi-Fi network. • Place the system within range of the router. • Enable Wi-Fi on the device (mobile or computer) you are using for setup. • Select correct network name and enter password. • Close other open applications. • If using a computer for setup, check firewall settings to make sure that the SoundTouch® app and SoundTouch® Music Server are allowed programs. • Restart your mobile device, or computer and router. • Uninstall the app, reset the system and restart setup.
Cannot connect to network	<ul style="list-style-type: none"> • If your network information has changed or to connect your system to another network, see page 7. • Connect to the network using an Ethernet cable.
No sound	<ul style="list-style-type: none"> • Increase the volume. • Make sure the system is not muted. Press . • Eject and reload the CD. • Press and release  while viewing the display. Make sure you are listening to the correct source. • Make sure the SoundTouch® pedestal is connected to your Wi-Fi network. • Turn on the external source and increase the volume. • Disconnect headphones from the system (connecting headphones mutes the speakers). • Stop other audio or video streaming applications.

Problem	What to do
Cannot play Bluetooth audio	<ul style="list-style-type: none"> • Set up SoundTouch® first, and perform all system updates. • Connect a device (see page 11). • Clear your system's pairing list (see page 11). • Try pairing a different device. <p>On your mobile device:</p> <ul style="list-style-type: none"> • Disable and re-enable the <i>Bluetooth</i> feature. • Remove the system from the <i>Bluetooth</i> menu. Connect again. • Refer to your mobile device's documentation.
Poor sound quality	<p>If the bass is too heavy or low, adjust the bass level of the system using the setup menu (see page 20).</p>
Remote control is inconsistent or does not work	<ul style="list-style-type: none"> • Operate the remote control closer to the system. • Check that the remote control battery is installed with positive (+) polarity facing up. • Replace the remote control battery. • Check for interference from fluorescent room lighting, sunlight, or dust or dirt on lens. • Place the system in a different location.
AM reception is weak	<ul style="list-style-type: none"> • Turn the system slightly clockwise and then counter-clockwise to change the direction of the internal AM antenna. • Move the system farther from a TV, refrigerator, halogen lamps, dimmer switches or other electronic equipment that generates electrical noise. • If neither suggestion works, you may be in an area of weak AM signal coverage.
FM reception is weak	<p>Extend the power cord as much as possible. The power cord acts as an FM antenna (see page 12).</p>
CD does not play	<ul style="list-style-type: none"> • Press CD. The CD icon appears on the display. • Load the CD label-side up. • Make sure that the disc surface is clean. If not, try cleaning it. • Try another CD.

Set up your system using a computer

You can set up your system using a computer rather than a smartphone or tablet.

Before you begin

- Position your system next to your computer.
- Make sure your computer is on your Wi-Fi network.
- Obtain a USB A to USB Micro B cable (not provided).

Notes:

- A USB A to USB Micro B cable is commonly used for charging mobile devices. You can also purchase this part at your local electronics store. If you don't have this cable, contact Bose customer service to receive this part.
- The USB connector on the back of your system is for computer setup only. The USB connector is not designed to charge smartphones, tablets, similar devices or the system itself.

Computer setup

During setup, the app prompts you to temporarily connect the USB cable from the computer to your Wave® SoundTouch® music system. Do not connect the USB cable until the app instructs you to do so.

1. Plug the power cord into an AC (mains) power outlet.
2. On your computer, open a browser and go to:
global.Bose.com/Support/WSTIV
Tip: Use the computer where your music library is stored.
3. Download and run the SoundTouch® app.
The app guides you through setup.
4. After setup is complete, disconnect the USB cable from your computer and system. Move your system to its permanent location.



785180-0020

BOSE

©2018 Bose Corporation, The Mountain,
Framingham, MA 01701-9168 USA
AM785180-0020 Rev. 00