

---

# WAVEWORKS

Product Specifications	354
Configuration Options	356
Grommet Location Options	362
Guidelines/General Information	363
Drawer Specifications	363
Assembled	364
EZ Arrangements	364
Assembled Units	372

## PRODUCT SPECIFICATIONS

### WORKSURFACE

- Worksurfaces are sized on 6" increments for easy planning
- Laminate surfaces are 1 $\frac{1}{8}$ " or 1 $\frac{1}{2}$ " HPL (high pressure laminate) or 1 $\frac{1}{8}$ " TFL (thermally fused laminate), and feature a 3mm PVC rim or 6 veneer rim options
- Veneer surfaces are 1 $\frac{3}{8}$ " or 1 $\frac{1}{2}$ " plain sliced slipmatched cherry (Amber, Autumn, Mocha, Truffle) or maple veneer (Brighton, Caramel, Honey, Natural), plain sliced bookmatched walnut veneer (Clear Walnut, Cordovan, Judicial), quarter cut walnut veneer (Almond, Portobello, Sable), or quarter cut oak veneer (Sonoma). All veneer surfaces feature a 3mm wood rim or knife rim profile
- When specifying Clear Walnut, a clear coat finish, the natural wood characteristics of walnut veneer are visible. These characteristics include, but are not limited to, color and woodgrain variation.
- Refer to page 356 for rim profiles and colors
- Grain direction runs left-to-right unless otherwise noted
- Size modifications available at no upcharge; many WaveWorks component worksurfaces can be cut down in  $\frac{1}{8}$ " increments. See component sections for specific models

### FINISH APPLICATION

- All Veneer surfaces feature a semi-open pore matte finish

### CHASSIS CONSTRUCTION

- All joints are securely fastened by screws, L-brackets, dowels, and concealed fasteners to ensure maximum strength
- Adjustable leveling glides are standard on all casegoods
- End panels and support panels are 1 $\frac{1}{8}$ " thick, modesty panels are  $\frac{3}{4}$ " thick
- Laminate modesty panels have vertical grain direction unless otherwise noted
- Wood modesty panels have vertical grain direction unless otherwise noted
- Laminate with horizontal grain (example: Sable Horizontal 792H) will always have horizontal grain direction
- Back panels are fully finished unless otherwise noted

### SHELVES

- Shelves on open bookcases will be veneer, when ordering a veneer bookcase
- Doors on bookcases and above worksurface units come standard with touch latch
- Shelves are  $\frac{3}{4}$ " thick

### PEDESTALS

- Full, lower height or mobile options available

### DRAWERS

- Drawers feature 5-sided construction allowing for easy removal/replacement of drawer fronts
- Sides, back and front are  $\frac{1}{2}$ " thick woodgrain vinyl wrapped
- Drawer fronts are 3-ply construction with matched woodgrain
- For interior drawer dimensions, reference page 363

### DRAWER PULLS

- Available in 17 pull styles, refer to page 360 for pull styles and colors

### DRAWER SUSPENSION

- Box and file drawers are equipped with black, full extension, progressive action slides
- Precision steel ball bearings combined with sequence slide movement ensures long lasting operation
- All suspensions have a lifetime warranty

### FILING

- Drawers are equipped with black metal filing hardware that accommodates various filing requirements
- No-tool, easy installation allows for quick interchangeable filing capabilities
- Refer to page 363 for complete filing details

### CORD MANAGEMENT

- Round grommets, racetrack grommets and wire managers are optional on worksurfaces
- Round grommets optional on component end panels
- Half-moon grommet optional on component modesty panels
- Extended radius grommet optional on end panels of component pedestals
- Wire manager worksurfaces have a flexible PVC trough that allows cords and cables to be routed along the back edge and sides of worksurfaces
- Refer to page 361 for available grommet/wire manager colors
- Refer to page 362 for complete grommet locations and details
- Undersurface wire managers are available for additional cable management requirements; see pages 697 and 765 for options

### LOCKING

- Black and silver lock cores are available
- Key Random means lock cores/keys are randomly (1-5) picked and factory installed in unit
- Key Specific means you can pick any number (1-200) for black or silver lock core/key. Must specify the lock core model separately; not factory installed and will ship separately
- Specify a change key to remove and change lock cores
- To order key specific lock cores, change keys, and master keys, reference page 750

### TABLE BASES

- Bases are formed metal with a powder coat finish
- Mobile bases have locking casters, glides are standard on fixed height legs
- Refer to pages 663-696 for recommended base applications

### CONFERENCE TABLES, TRAINING TABLES AND PERIPHERAL ITEMS

- For matching conference tables, training tables and peripheral items, see the Tables Price List

### EZ ARRANGEMENT MODEL NUMBERS

- Specify quickly and accurately with National's EZ Arrangement models. In each series, the most popular options have been pre-selected for a complete L or U configuration. Just choose the left or right model number, add a finish and you're done

### HEIGHT ADJUSTABLE DESKS

- Wood, laminate/wood and laminate options
- Wood models are all wood; Laminate/Wood models are laminate tops with wood rim and wood chassis; laminate models are all laminate
- When in raised position, leg will be exposed
- Rim options are all Waveworks options
- Control pad can be moved to right-handed (RH) or left-handed (LH) by the customer
- Height adjustable customer range: 27 $\frac{3}{8}$ "-43 $\frac{3}{4}$ "
- Duty cycle: 2 minutes ON/18 minutes OFF
- Maximum load should not exceed 100 lbs. on the surface
- Power cord: Type A plug, max 10 A, 125 V; 78 $\frac{3}{4}$ " length
- Modesty panels are inset 1 $\frac{1}{8}$ " from edge of desk and 3 $\frac{3}{8}$ " from floor
- Modesty panel options full flush, full breakfront
- Overall dimensions of desk are undersized to allow for pinch points
- No pull or locking options

### DIMENSION KEY

D	Depth
W	Width
H	Height
A	Overhang: Approach Side
KW	Kneespace Width

**BUFFET CREDENZAS**

- Models with trashcan will have 2 drawers and 2 sets of double doors. Trashcan will be housed behind one set of the double doors
- The side where trashcan is located determines the handed side (trashcan on left is a left model)
- One 7 gallon trashcan per model is included
- Models with space to house a refrigerator will have 2 sets of double doors (no drawers). Refrigerator will be housed behind one of the double door sets with ventilation
- The side where refrigerator is located determines the handed side (refrigerator on left is a left model)
- Refrigerator is not included
- Overall opening for refrigerator in a 36" high model is 22½" wide x 28⅞" tall x 25¼" deep. Max refrigerator size is 21½" wide x 27⅞" tall x 21¼" deep
- Overall opening for refrigerator in a 41" high model is 22½" wide x 28⅞" tall x 25¼" deep. Max refrigerator size is 21½" wide x 32⅞" tall x 21¼" deep
- Only locking cabinet is the side with an adjustable shelf
- Buffet credenza with refrigerator access will not be covered under standard warranty if unit is placed where vent will be blocked. Nor will the unit be covered under standard warranty for excess moisture because the unit has been designed to prevent this possibility

**PULLOUT STORAGE**

- Pull-out storage units are finished on all sides and top. A top is recommended for a finished aesthetic
- Available for left and right-hand applications
- Includes one full-depth shelf on top, one fixed and 2 adjustable shelves and one coat hook
- Simplex power unit is standard
- 2 depths of 24" and 30" with 2 height options of 41" and 53"

**COMPONENTS**

- Component models will ship bulk packed when applicable

**LOCKERS**

- Lockers available in laminate options only
- Available for left and right applications
- One door lockers feature 2 fixed shelves and 2 coat hooks
- Two and three door lockers feature 2 coat hooks behind each door
- Pulls will be installed vertically. All Waveworks pull options available with the exception of Horizon
- No pull units will have a touch latch closure
- If using 1 locker by itself it MUST be attached to a wall
- If using more than 1 locker side by side they MUST be ganged together
- If using more than 1 locker back to back, a cluster of 4 lockers MUST be ordered and ganged both side to side and front to back
- Electronic locks available (see electronic locks details below)

**ELECTRONIC LOCKS**

- Locks ship separately and require field installation
- Available in black or silver
- No pull option on electronic locker models
- Lock is always installed vertically
- Electronic locks feature motorized locking engagement with manual knob
- Battery Life—3 Months usage on Surface Mount
- Micro-B USB port (Android cable) for emergency power jump and battery charging
- Charging available with wired USB charger or mobile USB power pack
- Keypad locks out for 15 minutes after 5 invalid attempts
- 3 USER MODES
  - Resident employee mode—the passcode will not expire and can be re-used
  - Multi-user mode—in resident employee mode, additional users can be added with each user separately identified for higher security applications (e.g. drug, evidence lockers)
  - Shared use mode—suitable for day lockers/hotel safe
- 2 METHODS OF USE
  - Keypad operation
  - Wesko eLock App (must be downloaded to a smartphone)
- Admin passcodes can be managed by keypad commands (via program mode) or with the Wesko App in Admin mode
- MUST contact Customer Service for administrative passcodes

# CONFIGURATION OPTIONS - WAVEWORKS

## RIM PROFILE OPTIONS

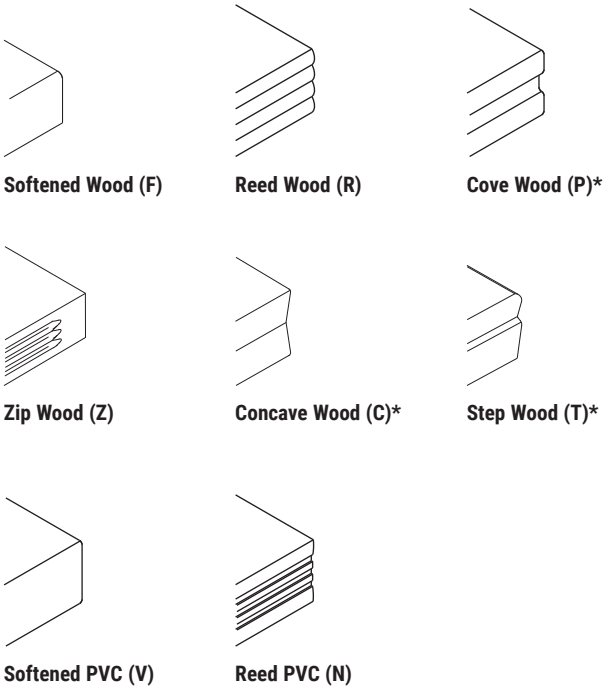

\*Not recommended with EW Clear Walnut and SM Sonoma

WAVEWORKS

### PVC REED RIM

AC2	Autumn 2
CL	Caramel
CW	Cordovan
DW	Judicial
HN2	Honey 2
MC	Amber
MH	Mocha
NM	Natural
TF	Truffle

### PVC SOFTENED RIM

AC2	Autumn 2
AD	Almond
BZ	Brazilwood
CI	Chai
CL	Caramel
CW	Cordovan
DW	Judicial
HN2	Honey 2
IM	Brighton
KN	Kona
MC	Amber
MH	Mocha
NM	Natural
PB	Portobello
PC	Porcini
PT	Portico
SK	Skyline
SM	Sonoma
TF	Truffle
WL	Willow
405	Designer White
419	Wallaby
425	Shadow
440	Cloud
457	Dapple
461	Graphite
462	Cinder
478	Platinum Grey
488	Frosty White
491	Designer White Linear
492	Cinder Linear
792	Sable
793	Acorn

### WOOD RIM

AC	Autumn
AD	Almond
CL	Caramel
CW	Cordovan
DW	Judicial
EW	Clear Walnut
HN	Honey
IM	Brighton
MC	Amber
MH	Mocha
NM	Natural
PB	Portobello
SM	Sonoma
TF	Truffle
792	Sable

### GALLERY LAMINATE

Grade 1 – 5% upcharge	
G1001	Citadel
G1011	Pepperdust
Grade 2 – 6% upcharge	
G1002	Planked Raw Oak
G1003	Evening Notte
G1004	Kirsche
G1005	Midnight Run
G1006	Sepia Walnut
G1007	Serotina
G1008	Timeless
G1009	White Nebbia
G1012	Phantom Ecru

See page 14 for Gallery program details and upcharges



Shaded model numbers are available on our "To You in 10 Days or Less" Quick Delivery program and will be delivered in 10 days or less.

**WORKSURFACE WIRE MANAGER COLORS**

403 Chamois	425 Shadow	462 Cinder
405 Designer White	440 Cloud	478 Platinum Grey
419 Wallaby	461 Graphite	485 Dark Chocolate

**WIRE MANAGER FILLER CAP COLORS**

403 Chamois	425 Shadow	462 Cinder
405 Designer White	440 Cloud	485 Dark Chocolate
419 Wallaby	461 Graphite	

NOTE: 478 not available. Recommended to use 440 Cloud for 478 Platinum Grey on filler caps.

WORKSURFACE FINISH/LAMINATE	WIRE MANAGER AND FILLER CAP COLOR RECOMMENDATIONS
<b>WOODGRAINS</b>	
AC2 Autumn 2	403 Chamois 419 Wallaby 485 Dark Chocolate
AD Almond	485 Dark Chocolate
BZ Brazilwood	403 Chamois 419 Wallaby
CI Chai	403 Chamois 419 Wallaby
CL Caramel	403 Chamois 419 Wallaby
CW Cordovan	485 Dark Chocolate
DW Judicial	485 Dark Chocolate
EW Clear Walnut	419 Wallaby 425 Shadow 485 Dark Chocolate
HN2 Honey 2	403 Chamois 419 Wallaby
IM Brighton	403 Chamois 405 Designer White 419 Wallaby
KN Kona	425 Shadow
MC Amber	403 Chamois 419 Wallaby 485 Dark Chocolate
MH Mocha	485 Dark Chocolate
NM Natural	403 Chamois 419 Wallaby
PB Portobello	425 Shadow 461 Graphite
PC Porcini	419 Wallaby 425 Shadow
PT Portico	461 Graphite 478 Platinum Grey
SK Skyline	485 Dark Chocolate
SM Sonoma	403 Chamois 419 Wallaby
TF Truffle	403 Chamois 425 Shadow 485 Dark Chocolate
WL Willow	419 Wallaby 425 Shadow
792 Sable	425 Shadow 485 Dark Chocolate
793 Acorn	419 Wallaby 425 Shadow 485 Dark Chocolate

WORKSURFACE FINISH/LAMINATE	WIRE MANAGER AND FILLER CAP COLOR RECOMMENDATIONS
<b>SOLID LAMINATES</b>	
405 Designer White	405 Designer White
419 Wallaby	419 Wallaby
425 Shadow	425 Shadow
440 Cloud	440 Cloud
457 Dapple	461 Graphite
461 Graphite	461 Graphite
462 Cinder	462 Cinder
478 Platinum Grey	478 Platinum Grey
488 Frosty White	405 Designer White
491 Designer White Linear	405 Designer White
492 Cinder Linear	462 Cinder

WORKSURFACE FINISH/LAMINATE	WIRE MANAGER AND FILLER CAP COLOR RECOMMENDATIONS
<b>PATTERN LAMINATES</b>	
814 White Tigris	440 Cloud 478 Platinum Grey
818 Crisp Linen	440 Cloud
819 Flax Gauze	403 Chamois 419 Wallaby
821 Elemental Concrete	440 Cloud 478 Platinum Grey
822 Smoke Quarstone	461 Graphite

WORKSURFACE LAMINATE	WIRE MANAGER AND FILLER CAP COLOR RECOMMENDATIONS
<b>GALLERY LAMINATE</b>	
G1001 Citadel	425 Shadow 461 Graphite 478 Platinum Grey
G1002 Planked Raw Oak	405 Designer White 419 Wallaby 440 Cloud
G1003 Evening Notte	425 Shadow 485 Dark Chocolate
G1004 Kirsche	403 Chamois 419 Wallaby 425 Shadow
G1005 Midnight Run	461 Graphite 462 Cinder
G1006 Sepia Walnut	485 Dark Chocolate
G1007 Serotina	425 Shadow
G1008 Timeless	485 Dark Chocolate 425 Shadow
G1009 White Nebbia	405 Designer White 440 Cloud
G1011 Pepperdust	425 Shadow 478 Platinum Grey
G1012 Phantom Ecu	419 Wallaby 440 Cloud 425 Shadow

## CONFIGURATION OPTIONS - WAVEWORKS

### WOOD FINISHES

AC	Autumn	MC	Amber
AD	Almond	MH	Mocha
CL	Caramel	NM	Natural
CW	Cordovan	PB	Portobello
DW	Judicial	SM	Sonoma
EW	Clear Walnut**	TF	Truffle
HN	Honey	792	Sable
IM	Brighton		

### LAMINATE WORKSURFACES

#### WOODGRAIN LAMINATE

AC2	Autumn 2
AD	Almond
BZ	Brazilwood
CI	Chai
CL	Caramel
CW	Cordovan
DW	Judicial
HN2	Honey 2
IM	Brighton
KN	Kona
MC	Amber
MH	Mocha
NM	Natural
PB	Portobello
PC	Porcini
PT	Portico*
SK	Skyline*
SM	Sonoma*
TF	Truffle
WL	Willow
792	Sable
793	Acorn**

### LAMINATE DRAWER/DOOR FRONTS & CHASSIS

#### WOODGRAIN LAMINATE

AC2	Autumn 2
AD	Almond
ADH	Almond Horizontal
BZ	Brazilwood
CI	Chai
CL	Caramel
CW	Cordovan
DW	Judicial
HN2	Honey 2
IM	Brighton
KN	Kona
MC	Amber
MH	Mocha
NM	Natural
PB	Portobello
PBH	Portobello Horizontal
PC	Porcini
PT	Portico*
PTH	Portico Horizontal*
SK	Skyline*
SKH	Skyline Horizontal*
SM	Sonoma
SMH	Sonoma Horizontal
TF	Truffle
WL	Willow
792	Sable
792H	Sable Horizontal
793	Acorn**

### WORKSURFACE/MODESTY

#### TYPE

M	Main
E	Extension
F	Filler

M = 0 Connecting Worksurface Flat Brackets  
 E = 2 Connecting Worksurface Flat Brackets  
 F = 4 Connecting Worksurface Flat Brackets

#### SOLID LAMINATE

405	Designer White
419	Wallaby
425	Shadow
440	Cloud
457	Dapple
461	Graphite
462	Cinder
478	Platinum Grey
488	Frosty White
491	Designer White Linear
492	Cinder Linear

#### PATTERN LAMINATE

814	White Tigris
818	Crisp Linen
819	Flax Gauze
821	Elemental Concrete
822	Smoke Quarstone

- Pattern laminates not available on TFL models
- CSL available; see page 14 for program details and upcharge
- CSL not available on TFL

#### GALLERY LAMINATE

Grade 1 – 5% upcharge	
G1001	Citadel
G1011	Pepperdust
Grade 2 – 6% upcharge	
G1002	Planked Raw Oak
G1003	Evening Notte
G1004	Kirsche
G1005	Midnight Run
G1006	Sepia Walnut
G1007	Serotina
G1008	Timeless
G1009	White Nebbia
G1012	Phantom Ecu

#### SOLID LAMINATE

405	Designer White
419	Wallaby
425	Shadow
440	Cloud
457	Dapple
461	Graphite
462	Cinder
478	Platinum Grey
488	Frosty White
491	Designer White Linear
491H	Designer White Linear Horizontal
492	Cinder Linear
492H	Cinder Linear Horizontal

#### GLASS DOOR ALUMINUM FRAME COLORS

462	Cinder
501	Platinum Metallic
503	Satin Nickel Metallic

\*Not available on laminate/wood models  
 \*\*Acorn is the laminate complement to Clear Walnut finish

#### GALLERY LAMINATE

Grade 1 – 5% upcharge	
G1001	Citadel
G1011	Pepperdust
Grade 2 – 6% upcharge	
G1002	Planked Raw Oak
G1003	Evening Notte
G1004	Kirsche
G1005	Midnight Run
G1006	Sepia Walnut
G1007	Serotina
G1008	Timeless
G1009	White Nebbia
G1012	Phantom Ecu

See page 14 for Gallery program details and upcharges

**RESIN COLORS**

Grade 1  
1677 Frosted

**SOLID SURFACE TOP  
OPTIONS**

**COLORS**

- 7101 Bisque (Grade A)
- 7201 Glacier White (Grade A)
- 7202 Canyon (Grade B)
- 7203 Designer White (Grade B)
- 7204 Silt (Grade B)
- 7301 Concrete (Grade C)
- 7302 Deep Night Sky (Grade C)
- 7303 Deep Nocturne (Grade C)

**LOCKING**

**KEY RANDOM**

- KRB Black
- KRS Silver

**KEY SPECIFIC**

- KS1B Black, 1 lock per unit
- KS1S Silver, 1 lock per unit
- KS2B Black, 2 locks per unit
- KS2S Silver, 2 locks per unit
- KS3B Black, 3 locks per unit
- KS3S Silver, 3 locks per unit
- KS4B Black, 4 locks per unit
- KS4S Silver, 4 locks per unit

Unit list price will be reduced by \$28 per lock when selecting Key Specific option. Must order specific lock cores separately (\$28 list each). See page 750 for Key Specific model numbers.

WAVEWORKS



Shaded model numbers are available on our "To You in 10 Days or Less" Quick Delivery program and will be delivered in 10 days or less.

# WAVEWORKS - CONFIGURATION OPTIONS

## PULL OPTIONS

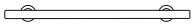

### Nantucket (6)

- 6MB Cinder
- 6CC Concrete
- 6IR Iron
- 6PL Platinum Metallic
- 6SN Satin Nickel Metallic  
(Boring Pattern 128mm)



### Malibu (7)

- 7MB Cinder
- 7CC Concrete
- 7IR Iron
- 7PL Platinum Metallic
- 7SN Satin Nickel Metallic  
(Boring Pattern 128mm)

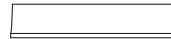

### Laguna (76)

- 76MB Cinder
- 76CC Concrete
- 76IR Iron
- 76PL Platinum Metallic
- 76SN Satin Nickel Metallic  
(Boring Pattern 128mm)



### Summit (70)

- 70MB Cinder
- 70CC Concrete
- 70IR Iron
- 70PL Platinum Metallic
- 70SN Satin Nickel Metallic  
(Boring Pattern 128mm)



### Spiral (71)

- 71MB Cinder
- 71CC Concrete
- 71IR Iron
- 71PL Platinum Metallic
- 71SN Satin Nickel Metallic  
(Boring Pattern 128mm)



### Balance (72)

- 72MB Cinder
- 72CC Concrete
- 72IR Iron
- 72PL Platinum Metallic
- 72SN Satin Nickel Metallic  
(Boring Pattern 128mm)



### Sweep (73)

- 73MB Cinder
- 73CC Concrete
- 73IR Iron
- 73PL Platinum Metallic
- 73SN Satin Nickel Metallic  
(Boring Pattern 128mm)



### Groove (74)

- 74MB Cinder
- 74CC Concrete
- 74IR Iron
- 74PL Platinum Metallic
- 74SN Satin Nickel Metallic  
(Boring Pattern 128mm)



### Beam (87)

- 87MB Cinder
- 87CC Concrete
- 87IR Iron
- 87PL Platinum Metallic
- 87SN Satin Nickel Metallic  
(Boring Pattern 128mm)



### Level (88)

- 88MB Cinder
- 88CC Concrete
- 88IR Iron
- 88PL Platinum Metallic
- 88SN Satin Nickel Metallic  
(Boring Pattern 128mm)



### Waterfall (89)

- 89MB Cinder
- 89CC Concrete
- 89IR Iron
- 89PL Platinum Metallic
- 89SN Satin Nickel Metallic  
(Boring Pattern 96mm)

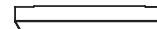

### Horizon (91)

- 91MB Cinder
- 91CC Concrete
- 91IR Iron
- 91PL Platinum Metallic
- 91SN Satin Nickel Metallic  
(Boring Pattern 96mm)

• Horizon pull is always flush to the top left of the door or drawer front



### Bar (3)

- 3MB Cinder
- 3CC Concrete
- 3IR Iron
- 3PL Platinum Metallic  
(Boring Pattern 32mm)



### Curved (83)

- 83MB Black
- 83CC Concrete
- 83IR Iron
- 83PL Platinum Metallic  
(Boring Pattern 128mm)



### Elongated (84)

- 84MB Black
- 84CC Concrete
- 84IR Iron
- 84PL Platinum Metallic  
(Boring Pattern 128mm)



### Keen (77)

- 77SN Satin Nickel  
(Boring Pattern 96mm)



### Leather Pull (93)

- 93EB Ebony
  - 93CH Chestnut
  - 93CA Camel
- (Boring Pattern 128mm)

**\$56 list upcharge per model**



Shaded model numbers are available on our "To You in 10 Days or Less" Quick Delivery program and will be delivered in 10 days or less.



**GROMMET OPTIONS**

If no grommet is desired, specify an X (No Grommet)

**Round Grommet, Nylon Plastic**

\$40 list for each grommet

- G1L Left
- G1R Right
- G1LR Left & Right
- G1C Center
- G1LC Left & Center
- G1RC Right & Center
- G1A Left, Right & Center

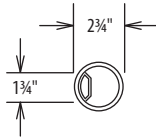

**Racetrack Grommet, Satin Nickel Metallic**

\$45 list for each grommet

- G11SNL Left
- G11SNR Right
- G11SNLR Left & Right
- G11SNC Center
- G11SNLC Left & Center
- G11SNRC Right & Center
- G11SNA Left, Right & Center

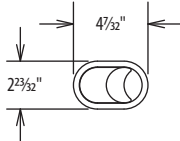

**Racetrack Grommet, Platinum Metallic**

\$45 list for each grommet

- G11PLL Left
- G11PLR Right
- G11PLLR Left & Right
- G11PLC Center
- G11PLLC Left & Center
- G11PLRC Right & Center
- G11PLA Left, Right & Center

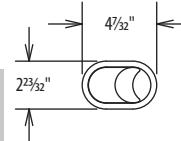

**Racetrack Grommet, Cinder**

\$45 list for each grommet

- G11MBL Left
- G11MBR Right
- G11MBLR Left & Right
- G11MBC Center
- G11MBLC Left & Center
- G11MBRC Right & Center
- G11MBA Left, Right & Center

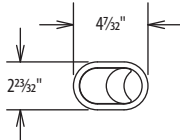

**PEDESTAL GROMMET**

If no grommet is desired, specify an X

- G22 Extended Radius (\$40 list)

**MODESTY GROMMET**

If no grommet is desired, specify an X

- G21 Half Moon (\$40 list)

**WORKSURFACE WIRE MANAGER**

If no wire manager is desired, specify an X (No Wire Manager)

Specify locations and color option  
Comes attached to worksurface  
\$50 list for each location

**Locations:**

- D1B Back \$50 list
- D1L Left \$50 list
- D1R Right \$50 list
- D1LR Left & Right \$100 list
- D1BL Back & Left \$100 list
- D1BR Back & Right \$100 list

**Sample Option Selections:**

- D1B425 Wire Manager on Back in Shadow, \$50 list
- D1BL403 Wire Manager on Back and Left in Chamois, \$100 list

**END PANEL GROMMET**

If no grommet is desired, specify an X

- G1EL Round, Black, Left (\$40 list)
- G1ER Round, Black, Right (\$40 list)

**ADJUSTABLE HEIGHT LEG PAINT**

- 462 Cinder
- 501 Platinum Metallic

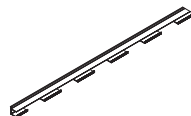

**Colors:**

- 403 Chamois
- 405 Designer White
- 419 Wallaby
- 425 Shadow
- 440 Cloud
- 461 Graphite
- 462 Cinder
- 478 Platinum Grey
- 485 Dark Chocolate

**Cutout Option for 1 Touch Pivoting Power Grommet**

\$40 list per cutout location

- CUT-G17L Left
- CUT-G17R Right
- CUT-G17LR Left & Right
- CUT-G17C Center
- CUT-G17LC Left & Center
- CUT-G17RC Right & Center
- CUT-G17A Left, Right & Center

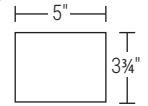

• Reference page 362 for cutout locations of CUT-G17

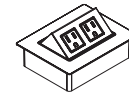

**NACG17AELPGB, NACG17AELPGS, and NACG17AELPGW (Sold Separately)**

• Reference page 757 for pricing and details

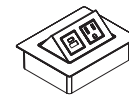

**NACG17BELPGB, NACG17BELPGS, and NACG17BELPGW (Sold Separately)**

• Reference page 757 for pricing and details

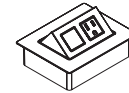

**NACG17CELPGB, NACG17CELPGS, and NACG17CELPGW (Sold Separately)**

• Reference page 757 for pricing and details

NOTE: Interlink IQ units are available in the Accessories section

**PULLOUT STORAGE ELECTRICAL GROMMET**

- G37PB Power Grommet \$108
- G37UB USB Grommet \$228

**PULLOUT STORAGE SPACER SPACER CUTOUT**

- CT1 Cutout, 1 Side \$40
- CT2 Cutout, 2 Sides \$40



Shaded model numbers are available on our "To You in 10 Days or Less" Quick Delivery program and will be delivered in 10 days or less.

**GROMMET LOCATION OPTIONS**

Grommets are available for factory installation in worksurfaces in predetermined locations as shown below. Simply specify the desired grommet style and location in the model number sequence. Refer to page 361 for options.

Round grommets are also available for field installation; see page 755.

- If specifying a grommet in the center location of a component worksurface, be sure there is clearance under the grommet opening so as not to conflict with undersurface components

**Worksurface grommet locations:**

Excluding the J-Desk and the corner unit, distance to the center of the grommet is the same for the G1 round grommet, G11 racetrack grommet or the CUT-G17 option.

Excluding the J-Desk and the corner unit, the same locations are available for the round or racetrack grommet and the cutout option.

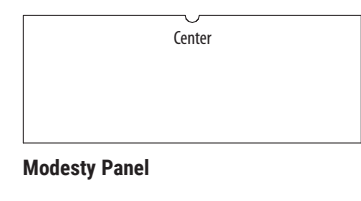
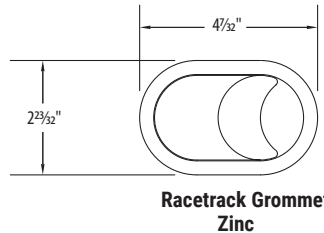
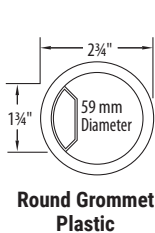
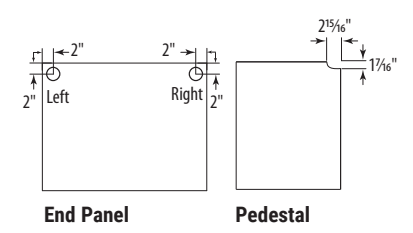
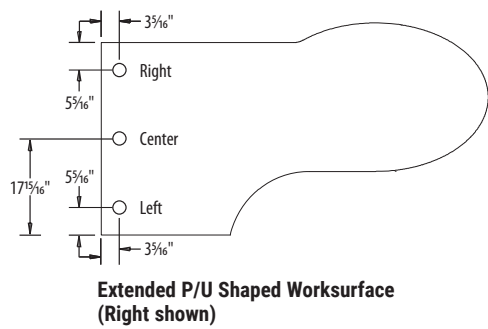
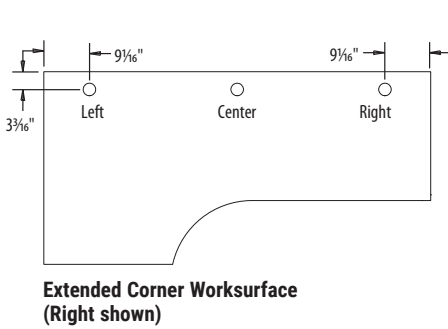
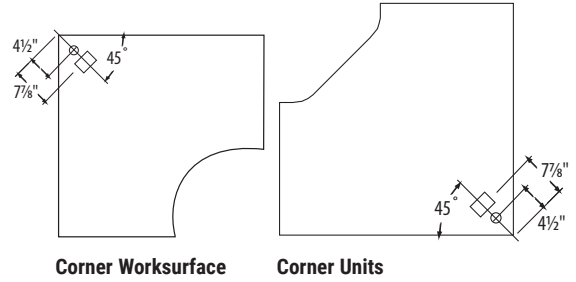
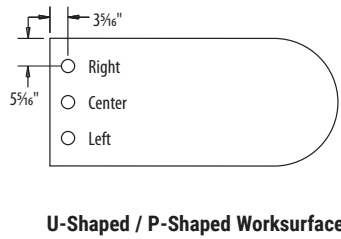
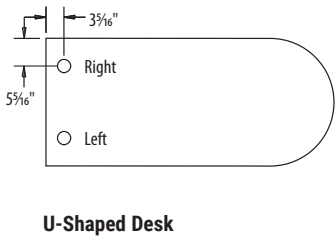
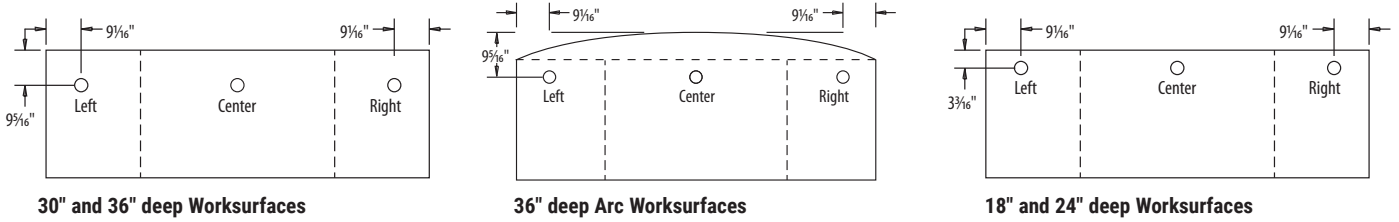

WAVEWORKS

**DRAWER SPECIFICATIONS**

DESCRIPTION	INTERIOR DIMENSIONS			FILING CAPABILITIES	
	DRAWER	INSIDE WIDTH	INSIDE DEPTH		INSIDE HEIGHT
Desk—Recessed Modesty Panel 36 x 72	Box	14 <sup>1</sup> / <sub>16</sub> "	17"	2 <sup>1</sup> / <sub>2</sub> "	Letter, legal, and EDP side-to-side filing Legal filing front-to-back
	File	14 <sup>1</sup> / <sub>16</sub> "	17"	9 <sup>3</sup> / <sub>8</sub> "	
Desk—Recessed Modesty Panel 30 x 66, 30 x 60	Box	11 <sup>1</sup> / <sub>16</sub> "	17"	2 <sup>1</sup> / <sub>2</sub> "	Letter filing front-to-back or side-to-side Legal and EDP filing side-to-side
	File	11 <sup>1</sup> / <sub>16</sub> "	17"	9 <sup>3</sup> / <sub>8</sub> "	
Single Pedestal Desk 36 x 72	Box	14 <sup>1</sup> / <sub>16</sub> "	17"	2 <sup>1</sup> / <sub>2</sub> "	Letter, legal, and EDP side-to-side filing Legal filing front-to-back
	File	14 <sup>1</sup> / <sub>16</sub> "	17"	9 <sup>3</sup> / <sub>8</sub> "	
Single Pedestal Desk 30 x 66	Box	11 <sup>1</sup> / <sub>16</sub> "	17"	2 <sup>1</sup> / <sub>2</sub> "	Letter filing front-to-back or side-to-side Legal and EDP filing side-to-side
	File	11 <sup>1</sup> / <sub>16</sub> "	17"	9 <sup>3</sup> / <sub>8</sub> "	
Executive Return 24 x 60, 24 x 48, 24 x 42	Box	11 <sup>1</sup> / <sub>16</sub> "	17"	2 <sup>1</sup> / <sub>2</sub> "	Letter filing front-to-back or side-to-side Legal and EDP filing side-to-side
	File	11 <sup>1</sup> / <sub>16</sub> "	17"	9 <sup>3</sup> / <sub>8</sub> "	
Credenzas 24 x 72	Box	14 <sup>1</sup> / <sub>16</sub> "	17"	2 <sup>1</sup> / <sub>2</sub> "	Letter, legal, and EDP side-to-side filing Legal filing front-to-back
	File	14 <sup>1</sup> / <sub>16</sub> "	17"	9 <sup>3</sup> / <sub>8</sub> "	
Credenzas 24 x 66, 24 x 60	Box	11 <sup>1</sup> / <sub>16</sub> "	17"	2 <sup>1</sup> / <sub>2</sub> "	Letter filing front-to-back or side-to-side Legal and EDP filing side-to-side
	File	11 <sup>1</sup> / <sub>16</sub> "	17"	9 <sup>3</sup> / <sub>8</sub> "	
Credenzas 24 x 72	Lateral File	32 <sup>1</sup> / <sub>16</sub> "	17"	9 <sup>3</sup> / <sub>8</sub> "	Letter, legal and EDP filing front-to-back or side-to-side
Single Pedestal Credenzas 24 x 72	Box	14 <sup>1</sup> / <sub>16</sub> "	17"	2 <sup>1</sup> / <sub>2</sub> "	Letter, legal, and EDP side-to-side filing Legal filing front-to-back
	File	14 <sup>1</sup> / <sub>16</sub> "	17"	9 <sup>3</sup> / <sub>8</sub> "	
Single Pedestal Credenzas 24 x 66, 24 x 60	Box	11 <sup>1</sup> / <sub>16</sub> "	17"	2 <sup>1</sup> / <sub>2</sub> "	Letter filing front-to-back or side-to-side Legal and EDP filing side-to-side
	File	11 <sup>1</sup> / <sub>16</sub> "	17"	9 <sup>3</sup> / <sub>8</sub> "	
Single Pedestal Credenzas 24 x 72	Lateral File	32 <sup>1</sup> / <sub>16</sub> "	17"	9 <sup>3</sup> / <sub>8</sub> "	Letter, legal and EDP filing front-to-back or side-to-side
Lateral File (23" depth) 36" width	Lateral File	32 <sup>1</sup> / <sub>16</sub> "	17"	9 <sup>3</sup> / <sub>8</sub> "	Letter, legal and EDP filing front-to-back or side-to-side
Lateral File (17" depth) 36" width	Lateral File	32 <sup>1</sup> / <sub>16</sub> "	12 <sup>1</sup> / <sub>32</sub> "	9 <sup>3</sup> / <sub>8</sub> "	Letter, legal and EDP filing front-to-back Letter filing side-to-side
Lateral File (23" depth) 30" width	Lateral File	26 <sup>1</sup> / <sub>16</sub> "	17"	9 <sup>3</sup> / <sub>8</sub> "	Letter, legal and EDP filing front-to-back or side-to-side
Lateral File (17" depth) 30" width	Lateral File	26 <sup>1</sup> / <sub>16</sub> "	12 <sup>1</sup> / <sub>32</sub> "	9 <sup>3</sup> / <sub>8</sub> "	Letter, legal and EDP filing front-to-back Letter filing side-to-side
Vertical Storage Cabinet 18 x 68	Box	14 <sup>1</sup> / <sub>16</sub> "	17"	2 <sup>1</sup> / <sub>2</sub> "	Letter, legal, and EDP side-to-side filing Legal filing front-to-back
	File	14 <sup>1</sup> / <sub>16</sub> "	17"	9 <sup>3</sup> / <sub>8</sub> "	
Component Pedestals 23 x 18, 29 x 18	Box	14 <sup>1</sup> / <sub>16</sub> "	17"	2 <sup>1</sup> / <sub>2</sub> "	Letter, legal, and EDP side-to-side filing Legal filing front-to-back
	File	14 <sup>1</sup> / <sub>16</sub> "	17"	9 <sup>3</sup> / <sub>8</sub> "	
Component Pedestal 17 x 18	Box	14 <sup>1</sup> / <sub>16</sub> "	12 <sup>1</sup> / <sub>32</sub> "	2 <sup>1</sup> / <sub>2</sub> "	Letter filing side-to-side Legal filing front-to-back
	File	14 <sup>1</sup> / <sub>16</sub> "	12 <sup>1</sup> / <sub>32</sub> "	9 <sup>3</sup> / <sub>8</sub> "	
Component Pedestals 23 x 15, 29 x 15	Box	11 <sup>1</sup> / <sub>16</sub> "	17"	2 <sup>1</sup> / <sub>2</sub> "	Letter filing front-to-back or side-to-side Legal and EDP filing side-to-side
	File	11 <sup>1</sup> / <sub>16</sub> "	17"	9 <sup>3</sup> / <sub>8</sub> "	
Component Pedestals 17 x 15	Box	11 <sup>1</sup> / <sub>16</sub> "	12 <sup>1</sup> / <sub>32</sub> "	2 <sup>1</sup> / <sub>2</sub> "	Letter filing front-to-back or side-to-side
	File	11 <sup>1</sup> / <sub>16</sub> "	12 <sup>1</sup> / <sub>32</sub> "	9 <sup>3</sup> / <sub>8</sub> "	
Mobile Pedestals 23 x 15	Box	11 <sup>1</sup> / <sub>16</sub> "	17"	2 <sup>1</sup> / <sub>2</sub> "	Letter filing front-to-back or side-to-side EDP and legal filing side-to-side
	File	11 <sup>1</sup> / <sub>16</sub> "	17"	9 <sup>3</sup> / <sub>8</sub> "	

- All file drawers will accommodate A4 and British fools cap filing
- Exterior dimension of legal width pedestal is 18". Letter width is 15"

# WAVEWORKS ASSEMBLED L ARRANGEMENTS

Specify quickly and accurately with National's EZ Arrangement models. In each series, the most popular options have been pre-selected for a complete L or U configuration. Just choose the left or right model number, add a finish and you're done.

### ARRANGEMENTS INCLUDE:

- Nantucket, Cinder pulls
- Softened Wood rim profile (wood models)
- Softened PVC, Cinder rim profile (laminated models)
- Random black lock cores
- Center grommet in return
- Must specify finish/laminate

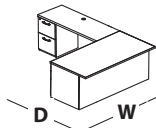
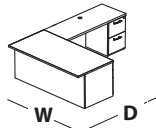
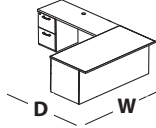
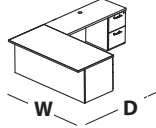
L-CONFIGURATIONS	MODEL NO./DESCRIPTION	LIST PRICE	L-CONFIGURATIONS	MODEL NO./DESCRIPTION	LIST PRICE		
<b>LEFT L-CONFIGURATION</b> <b>1 3/16" WOOD</b> 	WW8572LLFW	84% $\times$ 71 1/16"W	\$ 7225	<b>RIGHT L-CONFIGURATION</b> <b>1 3/16" WOOD</b> 	WW8572LRFW	84% $\times$ 71 1/16"W	\$ 7225
	consists of				consists of		
	WW3672DRFW1	Right Pedestal Desk	4283		WW3672DLFW1	Left Pedestal Desk	4283
	WW2448RLEFW2	Left Pedestal Return	2942		WW2448RREFW2	Right Pedestal Return	2942
	WW7972LLFW	78% $\times$ 71 1/16"W	\$ 7113		WW7972LRFW	78% $\times$ 71 1/16"W	\$ 7113
	consists of				consists of		
	WW3672DRFW1	Right Pedestal Desk	4283		WW3672DLFW1	Left Pedestal Desk	4283
	WW2442RLEFW2	Left Pedestal Return	2830		WW2442RREFW2	Right Pedestal Return	2830
	WW7966LLFW	78% $\times$ 66W	\$ 6958		WW7966LRFW	78% $\times$ 66W	\$ 6958
	consists of				consists of		
	WW3066DRFW1	Right Pedestal Desk	4016		WW3066DLFW1	Left Pedestal Desk	4016
	WW2448RLEFW2	Left Pedestal Return	2942		WW2448RREFW2	Right Pedestal Return	2942
WW7366LLFW	72% $\times$ 66W	\$ 6846	WW7366LRFW	72% $\times$ 66W	\$ 6846		
consists of			consists of				
WW3066DRFW1	Right Pedestal Desk	4016	WW3066DLFW1	Left Pedestal Desk	4016		
WW2442RLEFW2	Left Pedestal Return	2830	WW2442RREFW2	Right Pedestal Return	2830		
<b>LEFT L-CONFIGURATION</b> <b>1 3/16" HPL TOP</b> 	WW8572LLFL	84% $\times$ 71 1/16"W	\$ 4635	<b>RIGHT L-CONFIGURATION</b> <b>1 3/16" HPL TOP</b> 	WW8572LRFL	84% $\times$ 71 1/16"W	\$ 4635
	consists of				consists of		
	WW3672DRFL1	Right Pedestal Desk	2824		WW3672DLFL1	Left Pedestal Desk	2824
	WW2448RLEFL2	Left Pedestal Return	1811		WW2448RREFL2	Right Pedestal Return	1811
	WW7972LLFL	78% $\times$ 71 1/16"W	\$ 4560		WW7972LRFL	78% $\times$ 71 1/16"W	\$ 4560
	consists of				consists of		
	WW3672DRFL1	Right Pedestal Desk	2824		WW3672DLFL1	Left Pedestal Desk	2824
	WW2442RLEFL2	Left Pedestal Return	1736		WW2442RREFL2	Right Pedestal Return	1736
	WW7966LLFL	78% $\times$ 66W	\$ 4515		WW7966LRFL	78% $\times$ 66W	\$ 4515
	consists of				consists of		
	WW3066DRFL1	Right Pedestal Desk	2704		WW3066DLFL1	Left Pedestal Desk	2704
	WW2448RLEFL2	Left Pedestal Return	1811		WW2448RREFL2	Right Pedestal Return	1811
WW7366LLFL	72% $\times$ 66W	\$ 4440	WW7366LRFL	72% $\times$ 66W	\$ 4440		
consists of			consists of				
WW3066DRFL1	Right Pedestal Desk	2704	WW3066DLFL1	Left Pedestal Desk	2704		
WW2442RLEFL2	Left Pedestal Return	1736	WW2442RREFL2	Right Pedestal Return	1736		

## WAVEWORKS ASSEMBLED L ARRANGEMENTS

Specify quickly and accurately with National's EZ Arrangement models. In each series, the most popular options have been pre-selected for a complete L or U configuration. Just choose the left or right model number, add a finish and you're done.

### ARRANGEMENTS INCLUDE:

- Nantucket, Cinder pulls
- Softened PVC, Cinder rim profile (laminated models)
- Random black lock cores
- Center grommet in return
- Must specify finish/laminate

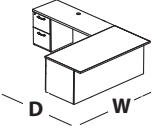
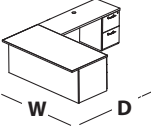
L-CONFIGURATIONS	MODEL NO./DESCRIPTION		LIST PRICE	L-CONFIGURATIONS	MODEL NO./DESCRIPTION		LIST PRICE
<b>LEFT L-CONFIGURATION 1½"</b> <b>TFL TOP</b> 	WW8572LLFLL	84½D x 71½W	\$ 3714	<b>RIGHT L-CONFIGURATION 1½"</b> <b>TFL TOP</b> 	WW8572LRFLL	84½D x 71½W	\$ 3714
	consists of				consists of		
	WW3672DRFLL1	Right Pedestal Desk	2258		WW3672DLFLL1	Left Pedestal Desk	2258
	WW2448RLEFLL2	Left Pedestal Return	1456		WW2448RREFLL2	Right Pedestal Return	1456
	WW7972LLFLL	78½D x 71½W	\$ 3658		WW7972LRFLL	78½D x 71½W	\$ 3658
	consists of				consists of		
	WW3672DRFLL1	Right Pedestal Desk	2258		WW3672DLFLL1	Left Pedestal Desk	2258
	WW2442RLEFLL2	Left Pedestal Return	1400		WW2442RREFLL2	Right Pedestal Return	1400
	WW7966LLFLL	78½D x 66W	\$ 3620		WW7966LRFLL	78½D x 66W	\$ 3620
	consists of				consists of		
WW3066DRFLL1	Right Pedestal Desk	2164	WW3066DLFLL1	Left Pedestal Desk	2164		
WW2448RLEFLL2	Left Pedestal Return	1456	WW2448RREFLL2	Right Pedestal Return	1456		
WW7366LLFLL	72½D x 66W	\$ 3564	WW7366LRFLL	72½D x 66W	\$ 3564		
consists of			consists of				
WW3066DRFLL1	Right Pedestal Desk	2164	WW3066DLFLL1	Left Pedestal Desk	2164		
WW2442RLEFLL2	Left Pedestal Return	1400	WW2442RREFLL2	Right Pedestal Return	1400		

# WAVEWORKS ASSEMBLED U ARRANGEMENTS

Specify quickly and accurately with National's EZ Arrangement models. In each series, the most popular options have been pre-selected for a complete L or U configuration. Just choose the left or right model number, add a finish and you're done.

### ARRANGEMENTS INCLUDE:

- Nantucket, Cinder pulls
- Softened Wood rim profile (wood models)
- Softened PVC, Cinder rim profile (lamine models)
- Random black lock cores
- Center grommet in bridge
- Left and right grommets in credenza
- Must specify finish/laminate

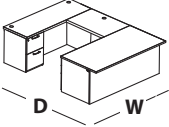
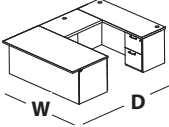
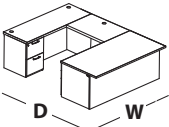
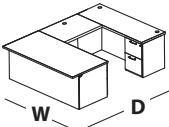
U-CONFIGURATIONS	MODEL NO./DESCRIPTION	LIST PRICE	U-CONFIGURATIONS	MODEL NO./DESCRIPTION	LIST PRICE		
<b>LEFT U-CONFIGURATION</b> <b>1 1/2" WOOD</b> 	WW10972ULFW	108 1/2D x 71 1/8W	\$ 9086	<b>RIGHT U-CONFIGURATION</b> <b>1 1/2" WOOD</b> 	WW10972URFW	108 1/2D x 71 1/8W	\$ 9086
	consists of				consists of		
	WW3672DRFW1	Right Pedestal Desk	4283		WW3672DLFW1	Left Pedestal Desk	4283
	WW2448BEFW	Bridge	1260		WW2448BEFW	Bridge	1260
	WW2472CLFW2	Left Pedestal Credenza	3543		WW2472CRFW2	Right Pedestal Credenza	3543
	WW10372ULFW	102 1/2D x 71 1/8W	\$ 9014		WW10372URFW	102 1/2D x 71 1/8W	\$ 9014
	consists of				consists of		
	WW3672DRFW1	Right Pedestal Desk	4283		WW3672DLFW1	Left Pedestal Desk	4283
	WW2442BEFW	Bridge	1188		WW2442BEFW	Bridge	1188
	WW2472CLFW2	Left Pedestal Credenza	3543		WW2472CRFW2	Right Pedestal Credenza	3543
WW10366ULFW	102 1/2D x 66W	\$ 8763	WW10366URFW	102 1/2D x 66W	\$ 8763		
consists of			consists of				
WW3066DRFW1	Right Pedestal Desk	4016	WW3066DLFW1	Left Pedestal Desk	4016		
WW2448BEFW	Bridge	1260	WW2448BEFW	Bridge	1260		
WW2466CLFW2	Left Pedestal Credenza	3487	WW2466CRFW2	Right Pedestal Credenza	3487		
WW9766ULFW	96 1/2D x 66W	\$ 8691	WW9766URFW	96 1/2D x 66W	\$ 8691		
consists of			consists of				
WW3066DRFW1	Right Pedestal Desk	4016	WW3066DLFW1	Left Pedestal Desk	4016		
WW2442BEFW	Bridge	1188	WW2442BEFW	Bridge	1188		
WW2466CLFW2	Left Pedestal Credenza	3487	WW2466CRFW2	Right Pedestal Credenza	3487		
<b>LEFT U-CONFIGURATION</b> <b>1 1/2" HPL TOP</b> 	WW10972ULFL	108 1/2D x 71 1/8W	\$ 6159	<b>RIGHT U-CONFIGURATION</b> <b>1 1/2" HPL TOP</b> 	WW10972URFL	108 1/2D x 71 1/8W	\$ 6159
	consists of				consists of		
	WW3672DRFL1	Right Pedestal Desk	2824		WW3672DLFL1	Left Pedestal Desk	2824
	WW2448BEFL	Bridge	781		WW2448BEFL	Bridge	781
	WW2472CLFL2	Left Pedestal Credenza	2554		WW2472CRFL2	Right Pedestal Credenza	2554
	WW10372ULFL	102 1/2D x 71 1/8W	\$ 6087		WW10372URFL	102 1/2D x 71 1/8W	\$ 6087
	consists of				consists of		
	WW3672DRFL1	Right Pedestal Desk	2824		WW3672DLFL1	Left Pedestal Desk	2824
	WW2442BEFL	Bridge	709		WW2442BEFL	Bridge	709
	WW2472CLFL2	Left Pedestal Credenza	2554		WW2472CRFL2	Right Pedestal Credenza	2554
WW10366ULFL	102 1/2D x 66W	\$ 5932	WW10366URFL	102 1/2D x 66W	\$ 5932		
consists of			consists of				
WW3066DRFL1	Right Pedestal Desk	2704	WW3066DLFL1	Left Pedestal Desk	2704		
WW2448BEFL	Bridge	781	WW2448BEFL	Bridge	781		
WW2466CLFL2	Left Pedestal Credenza	2447	WW2466CRFL2	Right Pedestal Credenza	2447		
WW9766ULFL	96 1/2D x 66W	\$ 5860	WW9766URFL	96 1/2D x 66W	\$ 5860		
consists of			consists of				
WW3066DRFL1	Right Pedestal Desk	2704	WW3066DLFL1	Left Pedestal Desk	2704		
WW2442BEFL	Bridge	709	WW2442BEFL	Bridge	709		
WW2466CLFL2	Left Pedestal Credenza	2447	WW2466CRFL2	Right Pedestal Credenza	2447		

# WAVEWORKS ASSEMBLED U ARRANGEMENTS

Specify quickly and accurately with National's EZ Arrangement models. In each series, the most popular options have been pre-selected for a complete L or U configuration. Just choose the left or right model number, add a finish and you're done.

## ARRANGEMENTS INCLUDE:

- Nantucket, Cinder pulls
- Softened PVC, Cinder rim profile (laminated models)
- Random black lock cores
- Center grommet in bridge
- Left and right grommets in credenza
- Must specify finish/laminate

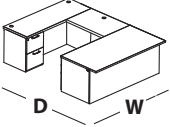
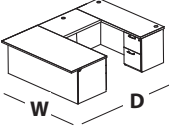
U-CONFIGURATIONS	MODEL NO./DESCRIPTION	LIST PRICE	U-CONFIGURATIONS	MODEL NO./DESCRIPTION	LIST PRICE	
<b>LEFT U-CONFIGURATION 1 1/2" TFL TOP</b> 	WW10972ULFLL 108 1/2 D x 71 1/8 W	\$ 4951	<b>RIGHT U-CONFIGURATION 1 1/2" TFL TOP</b> 	WW10972URFLL 108 1/2 D x 71 1/8 W	\$ 4951	
	consists of			consists of		
	WW3672DRFLL1 Right Pedestal Desk	2258		WW3672DLFLL1 Left Pedestal Desk	2258	
	WW2448BEFLL Bridge	633		WW2448BEFLL Bridge	633	
	WW2472CLFLL2 Left Pedestal Credenza	2060		WW2472CRFLL2 Right Pedestal Credenza	2060	
	WW10372ULFLL 102 1/2 D x 71 1/8 W	\$ 4895		WW10372URFLL 102 1/2 D x 71 1/8 W	\$ 4895	
	consists of			consists of		
	WW3672DRFLL1 Right Pedestal Desk	2258		WW3672DLFLL1 Left Pedestal Desk	2258	
	WW2442BEFLL Bridge	577		WW2442BEFLL Bridge	577	
	WW2472CLFLL2 Left Pedestal Credenza	2060		WW2472CRFLL2 Right Pedestal Credenza	2060	
	WW10366ULFLL 102 1/2 D x 66 W	\$ 4769		WW10366URFLL 102 1/2 D x 66 W	\$ 4769	
	consists of			consists of		
	WW3066DRFLL1 Right Pedestal Desk	2164		WW3066DLFLL1 Left Pedestal Desk	2164	
	WW2448BEFLL Bridge	633		WW2448BEFLL Bridge	633	
	WW2466CLFLL2 Left Pedestal Credenza	1972		WW2466CRFLL2 Right Pedestal Credenza	1972	
WW9766ULFLL 96 1/2 D x 66 W	\$ 4713	WW9766URFLL 96 1/2 D x 66 W	\$ 4713			
consists of		consists of				
WW3066DRFLL1 Right Pedestal Desk	2164	WW3066DLFLL1 Left Pedestal Desk	2164			
WW2442BEFLL Bridge	577	WW2442BEFLL Bridge	577			
WW2466CLFLL2 Left Pedestal Credenza	1972	WW2466CRFLL2 Right Pedestal Credenza	1972			

# WAVEWORKS METAL L ARRANGEMENTS

Specify quickly and accurately with National's EZ Arrangement models. In each series, the most popular options have been pre-selected for a complete L or U configuration. Just choose the left or right model number, add a finish and you're done.

## ARRANGEMENTS INCLUDE:

- Integrated pulls
- Softened Wood rim profile (wood models)
- Softened PVC, Cinder rim profile (laminated models)
- Random black lock cores
- Center grommet in return
- Must specify finish/laminate and paint

L-CONFIGURATIONS	MODEL NO./DESCRIPTION	LIST PRICE
<b>L-CONFIGURATION WOOD TOP/METAL CHASSIS (CAN BE CONFIGURED AS RIGHT OR LEFT HANDED)</b>	WW8572LFWM 84%D x 71 $\frac{1}{2}$ %W	\$ 4779
	consists of	
	WW3672WSSDW Worksurface	1423
	WW2448WSSVDW Worksurface	973
	WW3015PUBBFM B/B/F Pedestal	689
	WW2315PUFFM F/F Pedestal	623
	WW7227MPM Full Overlay Modesty	327
	WW3027EPM End Panel	344
	WW0827SRM Return Support Panel	118
	WW4827MPM Full Overlay Modesty	282
WW7972LFWM 78%D x 71 $\frac{1}{2}$ %W	\$ 4718	
consists of		
WW3672WSSDW Worksurface	1423	
WW2442WSSVDW Worksurface	932	
WW3015PUBBFM B/B/F Pedestal	689	
WW2315PUFFM F/F Pedestal	623	
WW7227MPM Full Overlay Modesty	327	
WW3027EPM End Panel	344	
WW0827SRM Return Support Panel	118	
WW4227MPM Full Overlay Modesty	262	

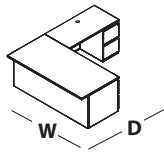

L-CONFIGURATIONS	MODEL NO./DESCRIPTION	LIST PRICE
<b>L-CONFIGURATION WOOD TOP/METAL CHASSIS (CAN BE CONFIGURED AS RIGHT OR LEFT HANDED)</b>	WW7966LFWM 78%D x 66W	\$ 4469
	consists of	
	WW3066WSSDW Worksurface	1130
	WW2448WSSVDW Worksurface	973
	WW3015PUBBFM B/B/F Pedestal	689
	WW2315PUFFM F/F Pedestal	623
	WW6627MPM Full Overlay Modesty	310
	WW3027EPM End Panel	344
	WW0827SRM Return Support Panel	118
	WW4827MPM Full Overlay Modesty	282
WW7366LFWM 72%D x 66W	\$ 4408	
consists of		
WW3066WSSDW Worksurface	1130	
WW2442WSSVDW Worksurface	932	
WW3015PUBBFM B/B/F Pedestal	689	
WW2315PUFFM F/F Pedestal	623	
WW6627MPM Full Overlay Modesty	310	
WW3027EPM End Panel	344	
WW0827SRM Return Support Panel	118	
WW4227MPM Full Overlay Modesty	262	

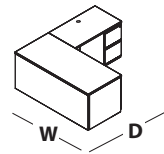

L-CONFIGURATION	MODEL NO./DESCRIPTION	LIST PRICE
<b>HPL TOP/METAL CHASSIS (CAN BE CONFIGURED AS RIGHT OR LEFT HANDED)</b>	WW8572LFLM 84%D x 71 $\frac{1}{2}$ %W	\$ 3812
	consists of	
	WW3672WSSDL Worksurface	967
	WW2448WSSVDL Worksurface	462
	WW3015PUBBFM B/B/F Pedestal	689
	WW2315PUFFM F/F Pedestal	623
	WW7227MPM Full Overlay Modesty	327
	WW3027EPM End Panel	344
	WW0827SRM Return Support Panel	118
	WW4827MPM Full Overlay Modesty	282
WW7972LFLM 78%D x 71 $\frac{1}{2}$ %W	\$ 3750	
consists of		
WW3672WSSDL Worksurface	967	
WW2442WSSVDL Worksurface	420	
WW3015PUBBFM B/B/F Pedestal	689	
WW2315PUFFM F/F Pedestal	623	
WW7227MPM Full Overlay Modesty	327	
WW3027EPM End Panel	344	
WW0827SRM Return Support Panel	118	
WW4227MPM Full Overlay Modesty	262	

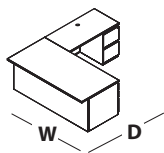

L-CONFIGURATION	MODEL NO./DESCRIPTION	LIST PRICE
<b>HPL TOP/METAL CHASSIS (CAN BE CONFIGURED AS RIGHT OR LEFT HANDED)</b>	WW7966LFLM 78%D x 66W	\$ 3486
	consists of	
	WW3066WSSDL Worksurface	658
	WW2448WSSVDL Worksurface	462
	WW3015PUBBFM B/B/F Pedestal	689
	WW2315PUFFM F/F Pedestal	623
	WW6627MPM Full Overlay Modesty	310
	WW3027EPM End Panel	344
	WW0827SRM Return Support Panel	118
	WW4827MPM Full Overlay Modesty	282
WW7366LFLM 72%D x 66W	\$ 3424	
consists of		
WW3066WSSDL Worksurface	658	
WW2442WSSVDL Worksurface	420	
WW3015PUBBFM B/B/F Pedestal	689	
WW2315PUFFM F/F Pedestal	623	
WW6627MPM Full Overlay Modesty	310	
WW3027EPM End Panel	344	
WW0827SRM Return Support Panel	118	
WW4227MPM Full Overlay Modesty	262	

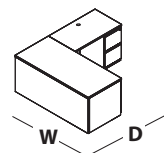

WAVEWORKS METAL EZ ARRANGEMENTS



# WAVEWORKS METAL L ARRANGEMENTS

Specify quickly and accurately with National's EZ Arrangement models. In each series, the most popular options have been pre-selected for a complete L or U configuration. Just choose the left or right model number, add a finish and you're done.

## ARRANGEMENTS INCLUDE:

- Integrated pulls
- Softened PVC, Cinder rim profile
- Random black lock cores
- Center grommet in return
- Must specify paint
- Must specify laminate

L-CONFIGURATIONS	MODEL NO./DESCRIPTION		LIST PRICE
<b>L-CONFIGURATION TFL TOP/ METAL CHASSIS (CAN BE CONFIGURED AS RIGHT OR LEFT HANDED)</b>	WW8572LFLLM	84%D x 71 <sup>1</sup> / <sub>6</sub> W	\$ 3536
	consists of		
	WW3672WSSDLL	Worksurface	774
	WW2448WSSVDLL	Worksurface	379
	WW3015PUBBFM	B/B/F Pedestal	689
	WW2315PUFFM	F/F Pedestal	623
	WW7227MPM	Full Overlay Modesty	327
	WW3027EPM	End Panel	344
	WW0827SRM	Return Support Panel	118
	WW4827MPM	Full Overlay Modesty	282
WW7972LFLLM	78%D x 71 <sup>1</sup> / <sub>6</sub> W	\$ 3480	
consists of			
WW3672WSSDLL	Worksurface	774	
WW2442WSSVDLL	Worksurface	343	
WW3015PUBBFM	B/B/F Pedestal	689	
WW2315PUFFM	F/F Pedestal	623	
WW7227MPM	Full Overlay Modesty	327	
WW3027EPM	End Panel	344	
WW0827SRM	Return Support Panel	118	
WW4227MPM	Full Overlay Modesty	262	

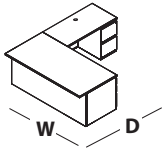

L-CONFIGURATIONS	MODEL NO./DESCRIPTION		LIST PRICE
<b>L-CONFIGURATION TFL TOP/ METAL CHASSIS (CAN BE CONFIGURED AS RIGHT OR LEFT HANDED)</b>	WW7966LFLLM	78%D x 66W	\$ 3271
	consists of		
	WW3066WSSDLL	Worksurface	526
	WW2448WSSVDLL	Worksurface	379
	WW3015PUBBFM	B/B/F Pedestal	689
	WW2315PUFFM	F/F Pedestal	623
	WW6627MPM	Full Overlay Modesty	310
	WW3027EPM	End Panel	344
	WW0827SRM	Return Support Panel	118
	WW4827MPM	Full Overlay Modesty	282
WW7366LFLLM	72%D x 66W	\$ 3215	
consists of			
WW3066WSSDLL	Worksurface	526	
WW2442WSSVDLL	Worksurface	343	
WW3015PUBBFM	B/B/F Pedestal	689	
WW2315PUFFM	F/F Pedestal	623	
WW6627MPM	Full Overlay Modesty	310	
WW3027EPM	End Panel	344	
WW0827SRM	Return Support Panel	118	
WW4227MPM	Full Overlay Modesty	262	

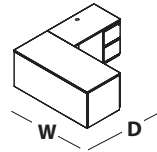

# WAVEWORKS METAL U ARRANGEMENTS

Specify quickly and accurately with National's EZ Arrangement models. In each series, the most popular options have been pre-selected for a complete L or U configuration. Just choose the left or right model number, add a finish and you're done.

## ARRANGEMENTS INCLUDE:

- Integrated pulls
- Softened Wood rim profile (wood models)
- Softened PVC, Cinder rim profile (laminated models)
- Random black lock cores
- Center grommet in bridge
- Left and right grommets in credenza
- Must specify finish/laminate and paint

U-CONFIGURATIONS	MODEL NO./DESCRIPTION	LIST PRICE
<b>U-CONFIGURATION WOOD TOP/METAL CHASSIS (CAN BE CONFIGURED AS RIGHT OR LEFT HANDED)</b>	WW10972UFWM 108½D x 71¼W	\$ 6654
	consists of	
	WW3672WSSDW Worksurface	1423
	WW2448WSSVDW Worksurface	973
	WW2472WSSDW Worksurface	1126
	WW3015PUBBFM B/B/F Pedestal	689
	WW2315PUFFM F/F Pedestal	623
	WW7227MPM Full Overlay Modesty	327
	WW7227MPM Full Overlay Modesty	327
	WW3027EPM End Panel	344
	WW0827SRM Return Support Panel	118
	WW0827SRM Return Support Panel	118
	WW2427EPM End Panel	304
	WW4827MPM Full Overlay Modesty	282

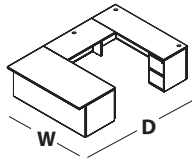

U-CONFIGURATIONS	MODEL NO./DESCRIPTION	LIST PRICE
<b>U-CONFIGURATION WOOD TOP/METAL CHASSIS (CAN BE CONFIGURED AS RIGHT OR LEFT HANDED)</b>	WW10366UFWM 102½D x 66W	\$ 6288
	consists of	
	WW3066WSSDW Worksurface	1130
	WW2448WSSVDW Worksurface	973
	WW2466WSSDW Worksurface	1087
	WW3015PUBBFM B/B/F Pedestal	689
	WW2315PUFFM F/F Pedestal	623
	WW6627MPM Full Overlay Modesty	310
	WW6627MPM Full Overlay Modesty	310
	WW3027EPM End Panel	344
	WW0827SRM Return Support Panel	118
	WW0827SRM Return Support Panel	118
	WW2427EPM End Panel	304
	WW4827MPM Full Overlay Modesty	282

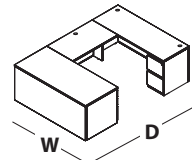

WW10372UFWM 102½D x 71¼W	\$ 6593
consists of	
WW3672WSSDW Worksurface	1423
WW2442WSSVDW Worksurface	932
WW2472WSSDW Worksurface	1126
WW3015PUBBFM B/B/F Pedestal	689
WW2315PUFFM F/F Pedestal	623
WW7227MPM Full Overlay Modesty	327
WW7227MPM Full Overlay Modesty	327
WW3027EPM End Panel	344
WW0827SRM Return Support Panel	118
WW0827SRM Return Support Panel	118
WW2427EPM End Panel	304
WW4227MPM Full Overlay Modesty	262

WW9766UFWM 96½D x 66W	\$ 6227
consists of	
WW3066WSSDW Worksurface	1130
WW2442WSSVDW Worksurface	932
WW2466WSSDW Worksurface	1087
WW3015PUBBFM B/B/F Pedestal	689
WW2315PUFFM F/F Pedestal	623
WW6627MPM Full Overlay Modesty	310
WW6627MPM Full Overlay Modesty	310
WW3027EPM End Panel	344
WW0827SRM Return Support Panel	118
WW0827SRM Return Support Panel	118
WW2427EPM End Panel	304
WW4227MPM Full Overlay Modesty	262

U-CONFIGURATION	MODEL NO./DESCRIPTION	LIST PRICE
<b>U-CONFIGURATION HPL TOP/METAL CHASSIS (CAN BE CONFIGURED AS RIGHT OR LEFT HANDED)</b>	WW10972UFLM 108½D x 71¼W	\$ 5241
	consists of	
	WW3672WSSDL Worksurface	967
	WW2448WSSVDL Worksurface	462
	WW2472WSSDL Worksurface	680
	WW3015PUBBFM B/B/F Pedestal	689
	WW2315PUFFM F/F Pedestal	623
	WW7227MPM Full Overlay Modesty	327
	WW7227MPM Full Overlay Modesty	327
	WW3027EPM End Panel	344
	WW0827SRM Return Support Panel	118
	WW0827SRM Return Support Panel	118
	WW2427EPM End Panel	304
	WW4827MPM Full Overlay Modesty	282

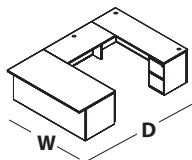

U-CONFIGURATIONS	MODEL NO./DESCRIPTION	LIST PRICE
<b>U-CONFIGURATION HPL TOP/METAL CHASSIS (CAN BE CONFIGURED AS RIGHT OR LEFT HANDED)</b>	WW10366UFLM 102½D x 66W	\$ 4854
	consists of	
	WW3066WSSDL Worksurface	658
	WW2448WSSVDL Worksurface	462
	WW2466WSSDL Worksurface	636
	WW3015PUBBFM B/B/F Pedestal	689
	WW2315PUFFM F/F Pedestal	623
	WW6627MPM Full Overlay Modesty	310
	WW6627MPM Full Overlay Modesty	310
	WW3027EPM End Panel	344
	WW0827SRM Return Support Panel	118
	WW0827SRM Return Support Panel	118
	WW2427EPM End Panel	304
	WW4827MPM Full Overlay Modesty	282

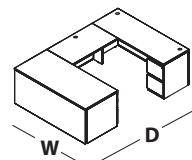

WW10372UFLM 102½D x 71¼W	\$ 5179
consists of	
WW3672WSSDL Worksurface	967
WW2442WSSVDL Worksurface	420
WW2472WSSDL Worksurface	680
WW3015PUBBFM B/B/F Pedestal	689
WW2315PUFFM F/F Pedestal	623
WW7227MPM Full Overlay Modesty	327
WW7227MPM Full Overlay Modesty	327
WW3027EPM End Panel	344
WW0827SRM Return Support Panel	118
WW0827SRM Return Support Panel	118
WW2427EPM End Panel	304
WW4227MPM Full Overlay Modesty	262

WW9766UFLM 96½D x 66W	\$ 4792
consists of	
WW3066WSSDL Worksurface	658
WW2442WSSVDL Worksurface	420
WW2466WSSDL Worksurface	636
WW3015PUBBFM B/B/F Pedestal	689
WW2315PUFFM F/F Pedestal	623
WW6627MPM Full Overlay Modesty	310
WW6627MPM Full Overlay Modesty	310
WW3027EPM End Panel	344
WW0827SRM Return Support Panel	118
WW0827SRM Return Support Panel	118
WW2427EPM End Panel	304
WW4227MPM Full Overlay Modesty	262

# WAVEWORKS METAL U ARRANGEMENTS

Specify quickly and accurately with National's EZ Arrangement models. In each series, the most popular options have been pre-selected for a complete L or U configuration. Just choose the left or right model number, add a finish and you're done.

## ARRANGEMENTS INCLUDE:

- Integrated pulls
- Softened PVC, Cinder rim profile (laminated models)
- Random black lock cores
- Center grommet in bridge
- Left and right grommets in credenza
- Must specify laminate and paint

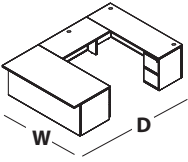
U-CONFIGURATIONS	MODEL NO./DESCRIPTION	LIST PRICE
<b>U-CONFIGURATION TFL TOP/ METAL CHASSIS (CAN BE CONFIGURED AS RIGHT OR LEFT HANDED)</b> 	WW10972UFLLM 108½D x 71⅞W	\$ 4845
	consists of	
	WW3672WSSDLL Worksurface	774
	WW2448WSSVDLL Worksurface	379
	WW2472WSSDLL Worksurface	560
	WW3015PUBBFM B/B/F Pedestal	689
	WW2315PUFFM F/F Pedestal	623
	WW7227MPM Full Overlay Modesty	327
	WW7227MPM Full Overlay Modesty	327
	WW3027EPM End Panel	344
	WW0827SRM Return Support Panel	118
	WW0827SRM Return Support Panel	118
	WW2427EPM End Panel	304
	WW4827MPM Full Overlay Modesty	282
	WW10372UFLLM 102½D x 71⅞W	\$ 4789
	consists of	
	WW3672WSSDLL Worksurface	774
WW2442WSSVDLL Worksurface	343	
WW2472WSSDLL Worksurface	560	
WW3015PUBBFM B/B/F Pedestal	689	
WW2315PUFFM F/F Pedestal	623	
WW7227MPM Full Overlay Modesty	327	
WW7227MPM Full Overlay Modesty	327	
WW3027EPM End Panel	344	
WW0827SRM Return Support Panel	118	
WW0827SRM Return Support Panel	118	
WW2427EPM End Panel	304	
WW4227MPM Full Overlay Modesty	262	

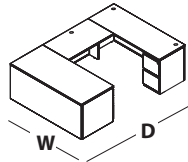
U-CONFIGURATIONS	MODEL NO./DESCRIPTION	LIST PRICE
<b>U-CONFIGURATION TFL TOP/ METAL CHASSIS (CAN BE CONFIGURED AS RIGHT OR LEFT HANDED)</b> 	WW10366UFLLM 102½D x 66W	\$ 4529
	consists of	
	WW3066WSSDLL Worksurface	526
	WW2448WSSVDLL Worksurface	379
	WW2466WSSDLL Worksurface	526
	WW3015PUBBFM B/B/F Pedestal	689
	WW2315PUFFM F/F Pedestal	623
	WW6627MPM Full Overlay Modesty	310
	WW6627MPM Full Overlay Modesty	310
	WW3027EPM End Panel	344
	WW0827SRM Return Support Panel	118
	WW0827SRM Return Support Panel	118
	WW2427EPM End Panel	304
	WW4827MPM Full Overlay Modesty	282
	WW9766UFLLM 96½D x 66W	\$ 4473
	consists of	
	WW3066WSSDLL Worksurface	526
WW2442WSSVDLL Worksurface	343	
WW2466WSSDLL Worksurface	526	
WW3015PUBBFM B/B/F Pedestal	689	
WW2315PUFFM F/F Pedestal	623	
WW6627MPM Full Overlay Modesty	310	
WW6627MPM Full Overlay Modesty	310	
WW3027EPM End Panel	344	
WW0827SRM Return Support Panel	118	
WW0827SRM Return Support Panel	118	
WW2427EPM End Panel	304	
WW4227MPM Full Overlay Modesty	262	

# WAVEWORKS

## PRODUCT SPECIFICATIONS

- Wood and laminate tops and chassis available; refer to page 358 for options
- Refer to pages 741-784 for accessories
- Refer to page 363 for filing capabilities
- Assembled units and component units are interchangeable
- Refer to page 362 for grommet locations and page 361 for grommet options and upcharge
- If specifying wood, you must specify the same finish for all options
- Center grommet location not available on desks

## TO ORDER, SPECIFY:

1. Model Number
2. Rim
3. PVC Rim Color (laminate models)
4. Pull
5. Grommet
6. Locking
7. Laminate Top Color (laminate/combo models)
8. Laminate Door/Drawer Color (laminate models)
9. Veneer Chassis Finish/Laminate Chassis Color

## SAMPLE MODEL NUMBERS:

WW3672DDFAW8 F 1PL G1L KRS AC  
 WW3672DDFAL8 VHN2 1PL G1L KRS HN2 461 HN2  
 WW3672DDFALW8 F 1PL G1L KRS 461 HN

- See pages 356-361 for all options available in WaveWorks

MODEL NO./DESCRIPTION	LIST PRICE	DIMENSIONS					CARTONED WEIGHT	CUBIC FEET
		D	W	H	A	KW		
<b>DOUBLE PEDESTAL DESK ARC TOP</b>								
<b>1½" TOP THICKNESS</b>								
WWN3684DDFAW8 Wood	\$ 7323	36½	83½	29½	6¾	47½	347 lbs.	65.8
WWN3684DDFALW8 Laminate/Wood	7323	36½	83½	29½	6¾	47½	347 lbs.	65.8
WWN3684DDFAL8 Laminate	4816	36½	83½	29½	6¾	47½	347 lbs.	65.8
<b>1½" TOP THICKNESS</b>								
WWN3672DDFAW8 Wood	\$ 6604	36½	71½	29½	6¾	35½	337 lbs.	52.3
WWN3672DDFALW8 Laminate/Wood	6604	36½	71½	29½	6¾	35½	337 lbs.	52.3
WWN3672DDFAL8 Laminate	4342	36½	71½	29½	6¾	35½	337 lbs.	52.3
<b>1½" TOP THICKNESS</b>								
WW3684DDFAW8 Wood	\$ 6724	36½	83½	28½	6¾	47½	347 lbs.	65.8
WW3684DDFALW8 Laminate/Wood	6724	36½	83½	28½	6¾	47½	347 lbs.	65.8
WW3684DDFAL8 Laminate	4420	36½	83½	28½	6¾	47½	347 lbs.	65.8
WW3684DDFALL8 TFL	3535	36½	83½	28½	6¾	47½	347 lbs.	65.8
<b>1½" TOP THICKNESS</b>								
WW3672DDFAW8 Wood	\$ 6004	36½	71½	28½	6¾	35½	317 lbs.	56.3
WW3672DDFALW8 Laminate/Wood	6004	36½	71½	28½	6¾	35½	317 lbs.	56.3
WW3672DDFAL8 Laminate	3947	36½	71½	28½	6¾	35½	317 lbs.	56.3
WW3672DDFALL8 TFL	3157	36½	71½	28½	6¾	35½	317 lbs.	56.3

- Arc top desk is 30" deep at ends
- Top overhangs 6" at center
- Random lock core (KRB, KRS) and specified lock core (KS2B, KS2S) available

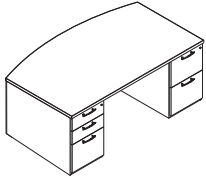

**PRODUCT SPECIFICATIONS**

- Wood and laminate tops and chassis available; refer to page 358 for options
- Refer to pages 741-784 for accessories
- Refer to page 363 for filing capabilities
- Assembled units and component units are interchangeable
- Refer to page 362 for grommet locations and page 361 for grommet options and upcharge
- If specifying wood, you must specify the same finish for all options
- Center grommet location not available on desks

**TO ORDER, SPECIFY:**

1. Model Number
2. Rim
3. PVC Rim Color (laminated models)
4. Pull
5. Grommet
6. Locking
7. Laminate Top Color (laminated/combo models)
8. Laminate Door/Drawer Color (laminated models)
9. Veneer Chassis Finish/Laminate Chassis Color

**SAMPLE MODEL NUMBERS:**

WWN3672DDFBW8 F 1PL G1L KRS AC  
 WWN3672DDFBAL8 VHN2 1PL G1L KRS HN2 461 HN2  
 WWN3672DDFBALW8 F 1PL G1L KRS 461 HN

- See pages 356-361 for all options available in WaveWorks

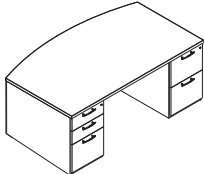
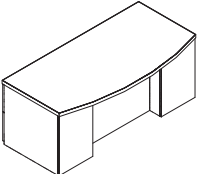
	MODEL NO./DESCRIPTION	LIST PRICE	DIMENSIONS				CARTONED WEIGHT	CUBIC FEET		
			D	W	H	A			KW	
<b>DOUBLE PEDESTAL DESK ARC TOP BREAKFRONT MODESTY</b>    	<b>1 1/8" TOP THICKNESS</b>									
	WWN3684DDFBW8	Wood	\$ 7543	36 1/16	83 1/16	29 3/8	6 3/16	47 3/16	347 lbs.	65.8
	WWN3684DDFBALW8	Laminate/Wood	7543	36 1/16	83 1/16	29 3/8	6 3/16	47 3/16	347 lbs.	65.8
	WWN3684DDFBAL8	Laminate	4962	36 1/16	83 1/16	29 3/8	6 3/16	47 3/16	347 lbs.	65.8
	WWN3672DDFBW8	Wood	\$ 6802	36 1/16	71 1/16	29 3/8	6 3/16	35 1/8	337 lbs.	52.3
	WWN3672DDFBALW8	Laminate/Wood	6802	36 1/16	71 1/16	29 3/8	6 3/16	35 1/8	337 lbs.	52.3
	WWN3672DDFBAL8	Laminate	4473	36 1/16	71 1/16	29 3/8	6 3/16	35 1/8	337 lbs.	52.3
	<b>1 1/8" TOP THICKNESS</b>									
	WW3684DDFBW8	Wood	\$ 6927	36 1/16	83 1/16	28 1/16	6 3/16	47 3/16	347 lbs.	65.8
	WW3684DDFBALW8	Laminate/Wood	6927	36 1/16	83 1/16	28 1/16	6 3/16	47 3/16	347 lbs.	65.8
	WW3684DDFBAL8	Laminate	4553	36 1/16	83 1/16	28 1/16	6 3/16	47 3/16	347 lbs.	65.8
	WW3684DDFBALL8	TFL	3539	36 1/16	83 1/16	28 1/8	6 3/16	47 3/16	347 lbs.	65.8
WW3672DDFBW8	Wood	\$ 6182	36 1/16	71 1/16	28 1/16	6 3/16	35 1/8	317 lbs.	56.3	
WW3672DDFBALW8	Laminate/Wood	6182	36 1/16	71 1/16	28 1/16	6 3/16	35 1/8	317 lbs.	56.3	
WW3672DDFBAL8	Laminate	4065	36 1/16	71 1/16	28 1/16	6 3/16	35 1/8	317 lbs.	56.3	
WW3672DDFBALL8	TFL	3156	36 1/16	71 1/16	28 1/8	6 3/16	35 1/8	317 lbs.	56.3	
<ul style="list-style-type: none"> <li>• Arc top desk is 30" deep at ends</li> <li>• Top overhangs 12" at center to the modesty panel</li> <li>• Random lock core (KRB, KRS) and specified lock core (KS2B, KS2S) available</li> </ul>										

**DOUBLE PEDESTAL DESK  
GLASS TOP**



WW3672DDFGW8	Wood	\$ 6549	36 1/16	71 1/16	29 3/8	35 1/8	—	275 lbs.	50.0
WW3672DDFGL8	Laminate	4307	36 1/16	71 1/16	29 3/8	35 1/8	—	275 lbs.	50.0
<ul style="list-style-type: none"> <li>• Grommet option not available</li> <li>• Clear 1/2" thick tempered glass top with pencil polished edge</li> <li>• Some assembly required; top ships unattached</li> <li>• Optional modesty panels in veneer or laminate and in full or 1/2 heights available, see page 546</li> <li>• Random lock core (KRB, KRS) and specified lock core (KS2B, KS2S) available</li> </ul>									

WAVEWORKS

ASSEMBLED

# WAVEWORKS

## PRODUCT SPECIFICATIONS

- Wood and laminate tops and chassis available; refer to page 358 for options
- Refer to pages 741-784 for accessories
- Refer to page 363 for filing capabilities
- Assembled units and component units are interchangeable
- Refer to page 362 for grommet locations and page 361 for grommet options and upcharge
- If specifying wood, you must specify the same finish for all options
- Center grommet location not available on desks

## TO ORDER, SPECIFY:

1. Model Number
2. Rim
3. PVC Rim Color (laminate models)
4. Pull
5. Grommet
6. Locking
7. Laminate Top Color (laminate/combo models)
8. Laminate Door/Drawer Color (laminate models)
9. Veneer Chassis Finish/ Laminate Chassis Color

## SAMPLE MODEL NUMBERS:

WW3672DDFW8 F 1PL G1L KRS AC  
 WW3672DDFL8 VHN2 1PL G1L KRS HN2 461 HN2  
 WW3672DDFL8 F 1PL G1L KRS 461 HN

• See pages 356-361 for all options available in WaveWorks

### DOUBLE PEDESTAL DESK RECESSED MODESTY

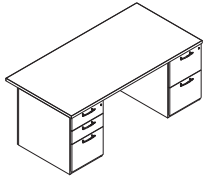

MODEL NO./DESCRIPTION	LIST PRICE	DIMENSIONS					CARTONED CUBIC	
		D	W	H	A	KW	WEIGHT	FEET
<b>1 1/2" TOP THICKNESS</b>								
WWN3684DDFW8 Wood	\$ 6103	36 1/16	83 1/16	29 3/8	6 3/16	47 3/16	347 lbs.	65.8
WWN3684DDFLW8 Laminate/Wood	6103	36 1/16	83 1/16	29 3/8	6 3/16	47 3/16	347 lbs.	65.8
WWN3684DDFL8 Laminate	3944	36 1/16	83 1/16	29 3/8	6 3/16	47 3/16	347 lbs.	65.8
<b>1 1/2" TOP THICKNESS</b>								
WWN3672DDFW8 Wood	\$ 5500	36 1/16	71 1/16	29 3/8	6 3/16	35 3/8	347 lbs.	52.3
WWN3672DDFLW8 Laminate/Wood	5500	36 1/16	71 1/16	29 3/8	6 3/16	35 3/8	347 lbs.	52.3
WWN3672DDFL8 Laminate	3556	36 1/16	71 1/16	29 3/8	6 3/16	35 3/8	347 lbs.	52.3
<b>1 1/2" TOP THICKNESS</b>								
WWN3066DDFW8 Wood	\$ 5279	30 1/16	66	29 3/8	6 3/16	35 3/8	277 lbs.	40.3
WWN3066DDFLW8 Laminate/Wood	5279	30 1/16	66	29 3/8	6 3/16	35 3/8	277 lbs.	40.3
WWN3066DDFL8 Laminate	3414	30 1/16	66	29 3/8	6 3/16	35 3/8	277 lbs.	40.3
<b>1 1/2" TOP THICKNESS</b>								
WWN3060DDFW8 Wood	\$ 5023	30 1/16	60	29 3/8	6 3/16	29 1/16	263 lbs.	36.7
WWN3060DDFLW8 Laminate/Wood	5023	30 1/16	60	29 3/8	6 3/16	29 1/16	263 lbs.	36.7
WWN3060DDFL8 Laminate	3289	30 1/16	60	29 3/8	6 3/16	29 1/16	263 lbs.	36.7
<b>1 1/2" TOP THICKNESS</b>								
WW3684DDFW8 Wood	\$ 5602	36 1/16	83 1/16	28 1/16	6 3/16	47 3/16	374 lbs.	65.8
WW3684DDFLW8 Laminate/Wood	5602	36 1/16	83 1/16	28 1/16	6 3/16	47 3/16	374 lbs.	65.8
WW3684DDFL8 Laminate	3620	36 1/16	83 1/16	28 1/16	6 3/16	47 3/16	374 lbs.	65.8
WW3684DDFLL8 TFL	2899	36 1/16	83 1/16	28 3/8	6 3/16	47 3/16	374 lbs.	65.8
<b>1 1/2" TOP THICKNESS</b>								
WW3672DDFW8 Wood	\$ 5001	36 1/16	71 1/16	28 1/16	6 3/16	35 3/8	361 lbs.	56.3
WW3672DDFLW8 Laminate/Wood	5001	36 1/16	71 1/16	28 1/16	6 3/16	35 3/8	361 lbs.	56.3
WW3672DDFL8 Laminate	3235	36 1/16	71 1/16	28 1/16	6 3/16	35 3/8	361 lbs.	56.3
WW3672DDFLL8 TFL	2586	36 1/16	71 1/16	28 3/8	6 3/16	35 3/8	361 lbs.	56.3
<b>1 1/2" TOP THICKNESS</b>								
WW3066DDFW8 Wood	\$ 4799	30 1/16	66	28 1/16	6 3/16	35 3/8	285 lbs.	44.4
WW3066DDFLW8 Laminate/Wood	4799	30 1/16	66	28 1/16	6 3/16	35 3/8	285 lbs.	44.4
WW3066DDFL8 Laminate	3104	30 1/16	66	28 1/16	6 3/16	35 3/8	285 lbs.	44.4
WW3066DDFLL8 TFL	2485	30 1/16	66	28 3/8	6 3/16	35 3/8	285 lbs.	44.4
<b>1 1/2" TOP THICKNESS</b>								
WW3060DDFW8 Wood	\$ 4569	30 1/16	60	28 1/16	6 3/16	29 1/16	261 lbs.	40.7
WW3060DDFLW8 Laminate/Wood	4569	30 1/16	60	28 1/16	6 3/16	29 1/16	261 lbs.	40.7
WW3060DDFL8 Laminate	2991	30 1/16	60	28 1/16	6 3/16	29 1/16	261 lbs.	40.7
WW3060DDFLL8 TFL	2391	30 1/16	60	28 3/8	6 3/16	29 1/16	261 lbs.	40.7

- 3672 desk has 30" deep pedestals
- 3066 and 3060 desks have 24" deep pedestals
- Random lock core (KRB, KRS) and specified lock core (KS2B, KS2S) available

**PRODUCT SPECIFICATIONS**

- Wood and laminate tops and chassis available; refer to page 358 for options
- Refer to pages 741-784 for accessories
- Refer to page 363 for filing capabilities
- Assembled units and component units are interchangeable
- Refer to page 362 for grommet locations and page 361 for grommet options and upcharge
- If specifying wood, you must specify the same finish for all options
- Center grommet location not available on desks

**TO ORDER, SPECIFY:**

1. Model Number
2. Rim
3. PVC Rim Color (laminated models)
4. Pull
5. Grommet
6. Locking
7. Laminate Top Color (laminated/combo models)
8. Laminate Door/Drawer Color (laminated models)
9. Veneer Chassis Finish/ Laminate Chassis Color

**SAMPLE MODEL NUMBERS:**

- WWN3672DDFBW8 F 1PL G1L KRS AC  
 WWN3672DDFBL8 VHN2 1PL G1L KRS HN2 461 HN2  
 WWN3672DDFBLW8 F 1PL G1L KRS 461 HN
- See pages 356-361 for all options available in WaveWorks

**DOUBLE PEDESTAL DESK  
BREAKFRONT MODESTY**

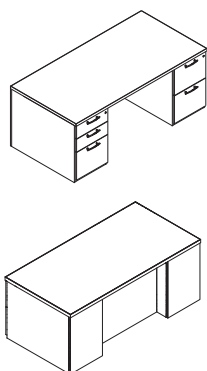

MODEL NO./DESCRIPTION		LIST PRICE	DIMENSIONS					CARTONED WEIGHT	CUBIC FEET
			D	W	H	A	KW		
<b>1 1/2" TOP THICKNESS</b>									
WWN3684DDFBW8	Wood	\$ 6283	36 1/16	83 1/16	29 3/8	6 3/16	47 3/16	374 lbs.	65.8
WWN3684DDFBLW8	Laminate/Wood	6283	36 1/16	83 1/16	29 3/8	6 3/16	47 3/16	374 lbs.	65.8
WWN3684DDFBL8	Laminate	4062	36 1/16	83 1/16	29 3/8	6 3/16	47 3/16	374 lbs.	65.8
<b>1 1/2" TOP THICKNESS</b>									
WWN3672DDFBW8	Wood	\$ 5665	36 1/16	71 1/16	29 3/8	6 3/16	35 3/8	347 lbs.	52.3
WWN3672DDFBLW8	Laminate/Wood	5665	36 1/16	71 1/16	29 3/8	6 3/16	35 3/8	347 lbs.	52.3
WWN3672DDFBL8	Laminate	3662	36 1/16	71 1/16	29 3/8	6 3/16	35 3/8	347 lbs.	52.3
<b>1 1/2" TOP THICKNESS</b>									
WWN3066DDFBW8	Wood	\$ 5436	30 1/16	66	29 3/8	6 3/16	35 3/8	277 lbs.	40.3
WWN3066DDFBLW8	Laminate/Wood	5436	30 1/16	66	29 3/8	6 3/16	35 3/8	277 lbs.	40.3
WWN3066DDFBL8	Laminate	3516	30 1/16	66	29 3/8	6 3/16	35 3/8	277 lbs.	40.3
<b>1 1/2" TOP THICKNESS</b>									
WWN3060DDFBW8	Wood	\$ 5174	30 1/16	60	29 3/8	6 3/16	29 1/16	263 lbs.	36.7
WWN3060DDFBLW8	Laminate/Wood	5174	30 1/16	60	29 3/8	6 3/16	29 1/16	263 lbs.	36.7
WWN3060DDFBL8	Laminate	3388	30 1/16	60	29 3/8	6 3/16	29 1/16	263 lbs.	36.7
<b>1 1/2" TOP THICKNESS</b>									
WW3684DDFBW8	Wood	\$ 5770	36 1/16	83 1/16	28 1/16	6 3/16	47 3/16	374 lbs.	65.8
WW3684DDFBLW8	Laminate/Wood	5770	36 1/16	83 1/16	28 1/16	6 3/16	47 3/16	374 lbs.	65.8
WW3684DDFBL8	Laminate	3729	36 1/16	83 1/16	28 1/16	6 3/16	47 3/16	374 lbs.	65.8
WW3684DDFBL8	TFL	2899	36 1/16	83 1/16	28 1/16	6 3/16	47 3/16	374 lbs.	65.8
<b>1 1/2" TOP THICKNESS</b>									
WW3672DDFBW8	Wood	\$ 5150	36 1/16	71 1/16	28 1/16	6 3/16	35 3/8	361 lbs.	56.3
WW3672DDFBLW8	Laminate/Wood	5150	36 1/16	71 1/16	28 1/16	6 3/16	35 3/8	361 lbs.	56.3
WW3672DDFBL8	Laminate	3330	36 1/16	71 1/16	28 1/16	6 3/16	35 3/8	361 lbs.	56.3
WW3672DDFBL8	TFL	2584	36 1/16	71 1/16	28 1/16	6 3/16	35 3/8	361 lbs.	56.3
<b>1 1/2" TOP THICKNESS</b>									
WW3066DDFBW8	Wood	\$ 4941	30 1/16	66	28 1/16	6 3/16	35 3/8	285 lbs.	44.4
WW3066DDFBLW8	Laminate/Wood	4941	30 1/16	66	28 1/16	6 3/16	35 3/8	285 lbs.	44.4
WW3066DDFBL8	Laminate	3198	30 1/16	66	28 1/16	6 3/16	35 3/8	285 lbs.	44.4
WW3066DDFBL8	TFL	2482	30 1/16	66	28 1/16	6 3/16	35 3/8	285 lbs.	44.4
<b>1 1/2" TOP THICKNESS</b>									
WW3060DDFBW8	Wood	\$ 4705	30 1/16	60	28 1/16	6 3/16	29 1/16	261 lbs.	40.7
WW3060DDFBLW8	Laminate/Wood	4705	30 1/16	60	28 1/16	6 3/16	29 1/16	261 lbs.	40.7
WW3060DDFBL8	Laminate	3079	30 1/16	60	28 1/16	6 3/16	29 1/16	261 lbs.	40.7
WW3060DDFBL8	TFL	2391	30 1/16	60	28 1/16	6 3/16	29 1/16	261 lbs.	40.7

- 3684 and 3672 desks have 35" deep pedestals
- 3066 and 3060 desks have 30" deep pedestals
- Random lock core (KRB, KRS) and specified lock core (KS2B, KS2S) available
- Modesty inset

# WAVEWORKS

## PRODUCT SPECIFICATIONS

- Wood and laminate tops and chassis available; refer to page 358 for options
- Refer to pages 741-784 for accessories
- Refer to page 363 for filing capabilities
- Assembled units and component units are interchangeable
- Refer to page 362 for grommet locations and page 361 for grommet options and upcharge
- If specifying wood, you must specify the same finish for all options
- Center grommet location not available on desks

## TO ORDER, SPECIFY:

1. Model Number
2. Rim
3. PVC Rim Color (laminated models)
4. Pull
5. Grommet
6. Locking
7. Laminate Top Color (laminated/combo models)
8. Laminate Door/Drawer Color (laminated models)
9. Veneer Chassis Finish/ Laminate Chassis Color

## SAMPLE MODEL NUMBERS:

WW3672DRFAW1 F 1PL G1L KRS AC  
 WW3672DRFAL1 VHN2 1PL G1L KRS HN2 461 HN2  
 WW3672DRFALW1 F 1PL G1L KRS 461 HN

- See pages 356-361 for all options available in WaveWorks

MODEL NO./DESCRIPTION	LIST PRICE	DIMENSIONS				KW	CARTONED WEIGHT	CUBIC FEET
		D	W	H	A			
<b>SINGLE PEDESTAL DESK ARC TOP</b>								
<b>1 1/16" TOP THICKNESS</b>								
<b>LEFT PEDESTAL DESK</b>								
<b>RIGHT PEDESTAL DESK</b>								
WWN3684DLFAW1	Wood	\$ 6402	36 1/16	83 1/16	29 3/8	6 3/16	64 1/16	374 lbs. 65.8
WWN3684DLFALW1	Lam/Wood	6402	36 1/16	83 1/16	29 3/8	6 3/16	64 1/16	374 lbs. 65.8
WWN3684DLFAL1	Laminate	4321	36 1/16	83 1/16	29 3/8	6 3/16	64 1/16	374 lbs. 65.8
WWN3672DLFAW1	Wood	\$ 5775	36 1/16	71 1/16	29 3/8	6 3/16	52 1/16	277 lbs. 52.0
WWN3672DLFALW1	Lam/Wood	5775	36 1/16	71 1/16	29 3/8	6 3/16	52 1/16	277 lbs. 52.0
WWN3672DLFAL1	Laminate	3895	36 1/16	71 1/16	29 3/8	6 3/16	52 1/16	277 lbs. 52.0
<b>1 1/16" TOP THICKNESS</b>								
<b>LEFT PEDESTAL DESK</b>								
<b>RIGHT PEDESTAL DESK</b>								
WW3684DLFAW1	Wood	\$ 5877	36 1/16	83 1/16	28 1/16	6 3/16	64 1/16	374 lbs. 65.8
WW3684DLFALW1	Lam/Wood	5877	36 1/16	83 1/16	28 1/16	6 3/16	64 1/16	374 lbs. 65.8
WW3684DLFAL1	Laminate	3966	36 1/16	83 1/16	28 1/16	6 3/16	64 1/16	374 lbs. 65.8
WW3684DLFALL1	TFL	3171	36 1/16	83 1/16	28 3/8	6 3/16	64 1/16	374 lbs. 65.8
WW3672DLFAW1	Wood	\$ 5248	36 1/16	71 1/16	28 1/16	6 3/16	52 1/16	267 lbs. 56.3
WW3672DLFALW1	Lam/Wood	5248	36 1/16	71 1/16	28 1/16	6 3/16	52 1/16	267 lbs. 56.3
WW3672DLFAL1	Laminate	3544	36 1/16	71 1/16	28 1/16	6 3/16	52 1/16	267 lbs. 56.3
WW3672DLFALL1	TFL	2835	36 1/16	71 1/16	28 3/8	6 3/16	52 1/16	267 lbs. 56.3

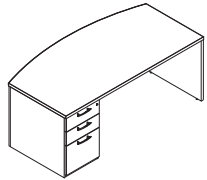

Left shown

- Arc top desk is 30" deep at ends
- Top overhangs 6" at center
- Random lock core (KRB, KRS) and specified lock core (KS1B, KS1S) available

WAVEWORKS

ASSEMBLED



**PRODUCT SPECIFICATIONS**

- Wood and laminate tops and chassis available; refer to page 358 for options
- Refer to pages 741-784 for accessories
- Refer to page 363 for filing capabilities
- Assembled units and component units are interchangeable
- Refer to page 362 for grommet locations and page 361 for grommet options and upcharge
- If specifying wood, you must specify the same finish for all options
- Center grommet location not available on desks

**TO ORDER, SPECIFY:**

1. Model Number
2. Rim
3. PVC Rim Color (laminated models)
4. Pull
5. Grommet
6. Locking
7. Laminate Top Color (laminated/combo models)
8. Laminate Door/Drawer Color (laminated models)
9. Veneer Chassis Finish/ Laminate Chassis Color

**SAMPLE MODEL NUMBERS:**

WWN3672DLFBAW1 F 1PL G1L KRS AC  
 WWN3672DLFBAL1 VHN2 1PL G1L KRS HN2 461 HN2  
 WWN3672DLFBALW1 F 1PL G1L KRS 461 HN

- See pages 356-361 for all options available in WaveWorks

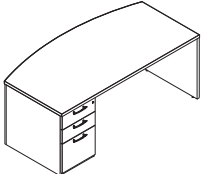
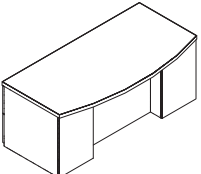
	MODEL NO./DESCRIPTION	LIST PRICE	DIMENSIONS				CARTONED WEIGHT	CUBIC FEET			
			D	W	H	A			KW		
 <p>Left shown</p>  <p>Left shown</p>	<b>1 1/2" TOP THICKNESS</b>										
	<b>LEFT PEDESTAL DESK</b>	<b>RIGHT PEDESTAL DESK</b>									
	WWN3684DLFBAW1	WWN3684DRFBAW1	Wood	\$ 6595	36 1/16	83 3/16	29 3/8	6 3/16	64 1/16	374 lbs.	65.8
	WWN3684DLFBALW1	WWN3684DRFBALW1	Lam/Wood	6595	36 1/16	83 3/16	29 3/8	6 3/16	64 1/16	374 lbs.	65.8
	WWN3684DLFBAL1	WWN3684DRFBAL1	Laminate	4452	36 1/16	83 3/16	29 3/8	6 3/16	64 1/16	374 lbs.	65.8
	WWN3672DLFBAW1	WWN3672DRFBAW1	Wood	\$ 5949	36 1/16	71 1/16	29 3/8	6 3/16	52 1/16	277 lbs.	52.0
	WWN3672DLFBALW1	WWN3672DRFBALW1	Lam/Wood	5949	36 1/16	71 1/16	29 3/8	6 3/16	52 1/16	277 lbs.	52.0
	WWN3672DLFBAL1	WWN3672DRFBAL1	Laminate	4012	36 1/16	71 1/16	29 3/8	6 3/16	52 1/16	277 lbs.	52.0
	<b>1 1/2" TOP THICKNESS</b>										
	<b>LEFT PEDESTAL DESK</b>	<b>RIGHT PEDESTAL DESK</b>									
	WW3684DLFBAW1	WW3684DRFBAW1	Wood	\$ 6054	36 1/16	83 3/16	28 1/16	6 3/16	64 1/16	374 lbs.	65.8
	WW3684DLFBALW1	WW3684DRFBALW1	Lam/Wood	6054	36 1/16	83 3/16	28 1/16	6 3/16	64 1/16	374 lbs.	65.8
WW3684DLFBAL1	WW3684DRFBAL1	Laminate	4087	36 1/16	83 3/16	28 1/16	6 3/16	64 1/16	374 lbs.	65.8	
WW3684DLFBALL1	WW3684DRFBALL1	TFL	3172	36 1/16	83 3/16	28 3/8	6 3/16	64 1/16	374 lbs.	65.8	
WW3672DLFBAW1	WW3672DRFBAW1	Wood	\$ 5409	36 1/16	71 1/16	28 1/16	6 3/16	52 1/16	267 lbs.	56.3	
WW3672DLFBALW1	WW3672DRFBALW1	Lam/Wood	5409	36 1/16	71 1/16	28 1/16	6 3/16	52 1/16	267 lbs.	56.3	
WW3672DLFBAL1	WW3672DRFBAL1	Laminate	3650	36 1/16	71 1/16	28 1/16	6 3/16	52 1/16	267 lbs.	56.3	
WW3672DLFBALL1	WW3672DRFBALL1	TFL	2835	36 1/16	71 1/16	28 3/8	6 3/16	52 1/16	267 lbs.	56.3	

- Arc top desk is 30" deep at ends
- Top overhangs 12" at center to the modesty panel
- Random lock core (KRB, KRS) and specified lock core (KS1B, KS1S) available
- Modesty inset
- Grain direction runs with the width of all laminate modesty panels that exceed 60"

WAVEWORKS

ASSEMBLED

# WAVEWORKS

## PRODUCT SPECIFICATIONS

- Wood and laminate tops and chassis available; refer to page 358 for options
- Refer to pages 741-784 for accessories
- Refer to page 363 for filing capabilities
- Assembled units and component units are interchangeable
- Refer to page 362 for grommet locations and page 361 for grommet options and upcharge
- If specifying wood, you must specify the same finish for all options
- Center grommet location not available on desks

## TO ORDER, SPECIFY:

1. Model Number
2. Rim
3. PVC Rim Color (laminated models)
4. Pull
5. Grommet
6. Locking
7. Laminate Top Color (laminated/combo models)
8. Laminate Door/Drawer Color (laminated models)
9. Veneer Chassis Finish/Laminate Chassis Color

## SAMPLE MODEL NUMBERS:

WW3672DRFW1 F 1PL G1L KRS AC  
 WW3672DRFL1 VHN2 1PL G1L KRS HN2 461 HN2  
 WW3672DRFLW1 F 1PL G1L KRS 461 HN

- See pages 356-361 for all options available in WaveWorks

### SINGLE PEDESTAL DESK RECESSED MODESTY

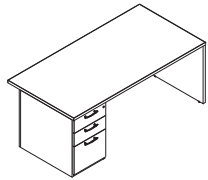

Left shown

MODEL NO./DESCRIPTION	LIST PRICE	DIMENSIONS					CARTONED CUBIC			
		D	W	H	A	KW	WEIGHT	FEET		
<b>1 1/8" TOP THICKNESS</b>										
<b>LEFT PEDESTAL DESK</b>			<b>RIGHT PEDESTAL DESK</b>							
WWN3684DLFW1	WWN3684DRFW1	Wood	\$ 5223	36 1/16	83 1/16	29 3/8	6 3/16	64 1/16	374 lbs.	65.8
WWN3684DLFLW1	WWN3684DRFLW1	Lam/Wood	5223	36 1/16	83 1/16	29 3/8	6 3/16	64 1/16	374 lbs.	65.8
WWN3684DLFL1	WWN3684DRFL1	Laminate	3446	36 1/16	83 1/16	29 3/8	6 3/16	64 1/16	374 lbs.	65.8
<hr/>										
WWN3672DLFW1	WWN3672DRFW1	Wood	\$ 4711	36 1/16	71 1/16	29 3/8	6 3/16	52 1/16	287 lbs.	52.3
WWN3672DLFLW1	WWN3672DRFLW1	Lam/Wood	4711	36 1/16	71 1/16	29 3/8	6 3/16	52 1/16	287 lbs.	52.3
WWN3672DLFL1	WWN3672DRFL1	Laminate	3105	36 1/16	71 1/16	29 3/8	6 3/16	52 1/16	287 lbs.	52.3
<hr/>										
WWN3066DLFW1	WWN3066DRFW1	Wood	\$ 4420	30 1/16	66	29 3/8	6 3/16	52 1/16	232 lbs.	40.3
WWN3066DLFLW1	WWN3066DRFLW1	Lam/Wood	4420	30 1/16	66	29 3/8	6 3/16	52 1/16	232 lbs.	40.3
WWN3066DLFL1	WWN3066DRFL1	Laminate	2974	30 1/16	66	29 3/8	6 3/16	52 1/16	232 lbs.	40.3
<hr/>										
<b>1 3/16" TOP THICKNESS</b>										
<b>LEFT PEDESTAL DESK</b>			<b>RIGHT PEDESTAL DESK</b>							
WW3684DLFW1	WW3684DRFW1	Wood	\$ 4798	36 1/16	83 1/16	28 1/16	6 3/16	64 1/16	374 lbs.	65.8
WW3684DLFLW1	WW3684DRFLW1	Lam/Wood	4798	36 1/16	83 1/16	28 1/16	6 3/16	64 1/16	374 lbs.	65.8
WW3684DLFL1	WW3684DRFL1	Laminate	3163	36 1/16	83 1/16	28 1/16	6 3/16	64 1/16	374 lbs.	65.8
WW3684DLFLL1	WW3684DRFLL1	TFL	2529	36 1/16	83 1/16	28 3/8	6 3/16	64 1/16	374 lbs.	65.8
<hr/>										
WW3672DLFW1	WW3672DRFW1	Wood	\$ 4283	36 1/16	71 1/16	28 1/16	6 3/16	52 1/16	311 lbs.	56.3
WW3672DLFLW1	WW3672DRFLW1	Lam/Wood	4283	36 1/16	71 1/16	28 1/16	6 3/16	52 1/16	311 lbs.	56.3
WW3672DLFL1	WW3672DRFL1	Laminate	2824	36 1/16	71 1/16	28 1/16	6 3/16	52 1/16	311 lbs.	56.3
WW3672DLFLL1	WW3672DRFLL1	TFL	2258	36 1/16	71 1/16	28 3/8	6 3/16	52 1/16	311 lbs.	56.3
<hr/>										
WW3066DLFW1	WW3066DRFW1	Wood	\$ 4016	30 1/16	66	28 1/16	6 3/16	52 1/16	245 lbs.	44.4
WW3066DLFLW1	WW3066DRFLW1	Lam/Wood	4016	30 1/16	66	28 1/16	6 3/16	52 1/16	245 lbs.	44.4
WW3066DLFL1	WW3066DRFL1	Laminate	2704	30 1/16	66	28 1/16	6 3/16	52 1/16	245 lbs.	44.4
WW3066DLFLL1	WW3066DRFLL1	TFL	2164	30 1/16	66	28 3/8	6 3/16	52 1/16	245 lbs.	44.4

- 3684 and 3672 desks have 30" deep pedestal
- 3066 desk has 24" deep pedestal
- Random lock core (KRB, KRS) and specified lock core (KS1B, KS1S) available
- Grain direction runs with the width of all laminate modesty panels that exceed 60"

**PRODUCT SPECIFICATIONS**

- Wood and laminate tops and chassis available; refer to page 358 for options
- Refer to pages 741-784 for accessories
- Refer to page 363 for filing capabilities
- Assembled units and component units are interchangeable
- Refer to page 362 for grommet locations and page 361 for grommet options and upcharge
- If specifying wood, you must specify the same finish for all options
- Center grommet location not available on desks

**TO ORDER, SPECIFY:**

1. Model Number
2. Rim
3. PVC Rim Color (laminate models)
4. Pull
5. Grommet
6. Locking
7. Laminate Top Color (laminate/combo models)
8. Laminate Door/Drawer Color (laminate models)
9. Veneer Chassis Finish/ Laminate Chassis Color

**SAMPLE MODEL NUMBERS:**

- WWN3672DRFBW1 F 1PL G1L KRS AC  
 WWN3672DRFBL1 VHN2 1PL G1L KRS HN2 461 HN2  
 WWN3672DRFBLW1 F 1PL G1L KRS 461 HN
- See pages 356-361 for all options available in WaveWorks

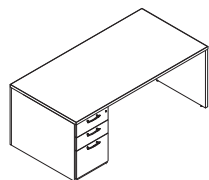
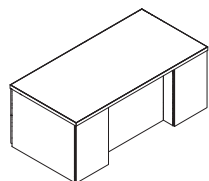
	MODEL NO./DESCRIPTION	LIST PRICE	DIMENSIONS				CARTONED WEIGHT	CUBIC FEET			
			D	W	H	A			KW		
<p><b>SINGLE PEDESTAL DESK BREAKFRONT MODESTY</b></p>  <p>Left shown</p>  <p>Left shown</p>	<b>1 1/2" TOP THICKNESS</b>										
		<b>LEFT PEDESTAL DESK</b>	<b>RIGHT PEDESTAL DESK</b>								
	WWN3684DLFBW1	WWN3684DRFBW1	Wood	\$ 5381	36 1/16	83 1/16	29 3/8	6 3/16	64 1/16	374 lbs.	65.8
	WWN3684DLFBLW1	WWN3684DRFBLW1	Lam/Wood	5381	36 1/16	83 1/16	29 3/8	6 3/16	64 1/16	374 lbs.	65.8
	WWN3684DLFBL1	WWN3684DRFBL1	Laminate	3550	36 1/16	83 1/16	29 3/8	6 3/16	64 1/16	374 lbs.	65.8
	WWN3672DLFBW1	WWN3672DRFBW1	Wood	\$ 4854	36 1/16	71 1/16	29 3/8	6 3/16	52 1/16	287 lbs.	52.3
	WWN3672DLFBLW1	WWN3672DRFBLW1	Lam/Wood	4854	36 1/16	71 1/16	29 3/8	6 3/16	52 1/16	287 lbs.	52.3
	WWN3672DLFBL1	WWN3672DRFBL1	Laminate	3202	36 1/16	71 1/16	29 3/8	6 3/16	52 1/16	287 lbs.	52.3
	WWN3066DLFBW1	WWN3066DRFBW1	Wood	\$ 4552	30 1/16	66	29 3/8	6 3/16	52 1/16	232 lbs.	40.3
	WWN3066DLFBLW1	WWN3066DRFBLW1	Lam/Wood	4552	30 1/16	66	29 3/8	6 3/16	52 1/16	232 lbs.	40.3
	WWN3066DLFBL1	WWN3066DRFBL1	Laminate	3061	30 1/16	66	29 3/8	6 3/16	52 1/16	232 lbs.	40.3
		<b>1 3/8" TOP THICKNESS</b>									
		<b>LEFT PEDESTAL DESK</b>	<b>RIGHT PEDESTAL DESK</b>								
WW3684DLFBW1		WW3684DRFBW1	Wood	\$ 4940	36 1/16	83 1/16	28 1/16	6 3/16	64 1/16	374 lbs.	65.8
WW3684DLFBLW1		WW3684DRFBLW1	Lam/Wood	4940	36 1/16	83 1/16	28 1/16	6 3/16	64 1/16	374 lbs.	65.8
WW3684DLFBL1		WW3684DRFBL1	Laminate	3258	36 1/16	83 1/16	28 1/16	6 3/16	64 1/16	374 lbs.	65.8
WW3684DLFBLL1		WW3684DRFBLL1	TFL	2529	36 1/16	83 1/16	28 3/8	6 3/16	64 1/16	374 lbs.	65.8
WW3672DLFBW1		WW3672DRFBW1	Wood	\$ 4411	36 1/16	71 1/16	28 1/16	6 3/16	52 1/16	311 lbs.	56.3
WW3672DLFBLW1		WW3672DRFBLW1	Lam/Wood	4411	36 1/16	71 1/16	28 1/16	6 3/16	52 1/16	311 lbs.	56.3
WW3672DLFBL1		WW3672DRFBL1	Laminate	2906	36 1/16	71 1/16	28 1/16	6 3/16	52 1/16	311 lbs.	56.3
WW3672DLFBLL1		WW3672DRFBLL1	TFL	2257	36 1/16	71 1/16	28 3/8	6 3/16	52 1/16	311 lbs.	56.3
WW3066DLFBW1		WW3066DRFBW1	Wood	\$ 4138	30 1/16	66	28 1/16	6 3/16	52 1/16	245 lbs.	44.4
WW3066DLFBLW1		WW3066DRFBLW1	Lam/Wood	4138	30 1/16	66	28 1/16	6 3/16	52 1/16	245 lbs.	44.4
WW3066DLFBL1		WW3066DRFBL1	Laminate	2785	30 1/16	66	28 1/16	6 3/16	52 1/16	245 lbs.	44.4
WW3066DLFBLL1		WW3066DRFBLL1	TFL	2164	30 1/16	66	28 3/8	6 3/16	52 1/16	245 lbs.	44.4

- 3684 and 3672 desks have 35" deep pedestal
- 3066 desk has 30" deep pedestal
- Random lock core (KRB, KRS) and specified lock core (KS1B, KS1S) available
- Modesty inset
- Grain direction runs with the width of all laminate modesty panels that exceed 60"

# WAVEWORKS

## PRODUCT SPECIFICATIONS

- Wood and laminate tops and chassis available; refer to page 358 for options
- Refer to page 362 for grommet locations and page 361 for grommet options and upcharge
- If specifying wood, you must specify the same finish for all options
- Center grommet location not available on desks

## TO ORDER, SPECIFY:

1. Model Number
2. Rim
3. PVC Rim Color (laminate models)
4. Grommet
5. Paint
6. Laminate Top Color (laminate models)
7. Laminate Chassis Color (laminate models)
8. Finish (wood models)

## SAMPLE MODEL NUMBERS:

WWN3084DSFA1W F G1L 462 AD  
 WWN3084DSFA1LW F G1R 462 440 MH  
 WWN3084DSFA1L VPB X 462 PB PB

- See pages 356-361 for all options available in WaveWorks

### ADJUSTABLE HEIGHT DESK SHELL FULL FLUSH MODESTY

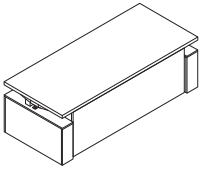

Approach view

MODEL NO./DESCRIPTION	LIST PRICE	DIMENSIONS					CARTONED WEIGHT	CUBIC FEET
		D	W	H	A	KW		
<b>1 1/16" TOP THICKNESS 36" DEPTH</b>								
WWN3684DSFA1W Wood	\$ 9179	36 1/16	83 3/16	27 1/16	-	-	lbs.	
WWN3684DSFA1LW Laminate/Wood	9179	36 1/16	83 3/16	27 1/16	-	-	lbs.	
WWN3684DSFA1L Laminate	7934	36 1/16	83 3/16	27 1/16	-	-	lbs.	
<hr/>								
WWN3678DSFA1W Wood	\$ 8936	36 1/16	77 3/16	27 1/16	-	-	lbs.	
WWN3678DSFA1LW Laminate/Wood	8936	36 1/16	77 3/16	27 1/16	-	-	lbs.	
WWN3678DSFA1L Laminate	7814	36 1/16	77 3/16	27 1/16	-	-	lbs.	
<hr/>								
WWN3672DSFA1W Wood	\$ 8693	36 1/16	71 3/16	27 1/16	-	-	lbs.	
WWN3672DSFA1LW Laminate/Wood	8693	36 1/16	71 3/16	27 1/16	-	-	lbs.	
WWN3672DSFA1L Laminate	7693	36 1/16	71 3/16	27 1/16	-	-	lbs.	
<hr/>								
<b>30" DEPTH</b>								
WWN3084DSFA1W Wood	\$ 8362	30 1/16	83 3/16	27 1/16	-	-	lbs.	
WWN3084DSFA1LW Laminate/Wood	8362	30 1/16	83 3/16	27 1/16	-	-	lbs.	
WWN3084DSFA1L Laminate	6731	30 1/16	83 3/16	27 1/16	-	-	lbs.	
<hr/>								
WWN3078DSFA1W Wood	\$ 8117	30 1/16	77 3/16	27 1/16	-	-	lbs.	
WWN3078DSFA1LW Laminate/Wood	8117	30 1/16	77 3/16	27 1/16	-	-	lbs.	
WWN3078DSFA1L Laminate	6614	30 1/16	77 3/16	27 1/16	-	-	lbs.	
<hr/>								
WWN3072DSFA1W Wood	\$ 7874	30 1/16	71 3/16	27 1/16	-	-	lbs.	
WWN3072DSFA1LW Laminate/Wood	7874	30 1/16	71 3/16	27 1/16	-	-	lbs.	
WWN3072DSFA1L Laminate	6493	30 1/16	71 3/16	27 1/16	-	-	lbs.	
<hr/>								
WWN3066DSFA1W Wood	\$ 7629	30 1/16	66	27 1/16	-	-	lbs.	
WWN3066DSFA1LW Laminate/Wood	7629	30 1/16	66	27 1/16	-	-	lbs.	
WWN3066DSFA1L Laminate	6374	30 1/16	66	27 1/16	-	-	lbs.	
<hr/>								
WWN3060DSFA1W Wood	\$ 7384	30 1/16	60	27 1/16	-	-	lbs.	
WWN3060DSFA1LW Laminate/Wood	7384	30 1/16	60	27 1/16	-	-	lbs.	
WWN3060DSFA1L Laminate	6255	30 1/16	60	27 1/16	-	-	lbs.	
<hr/>								
<b>24" DEPTH</b>								
WWN2454DSFA1W Wood	\$ 5905	24	54	27 1/16	-	-	lbs.	
WWN2454DSFA1LW Laminate/Wood	5905	24	54	27 1/16	-	-	lbs.	
WWN2454DSFA1L Laminate	5247	24	54	27 1/16	-	-	lbs.	
<hr/>								
WWN2448DSFA1W Wood	\$ 5798	24	48 1/16	27 1/16	-	-	lbs.	
WWN2448DSFA1LW Laminate/Wood	5798	24	48 1/16	27 1/16	-	-	lbs.	
WWN2448DSFA1L Laminate	5141	24	48 1/16	27 1/16	-	-	lbs.	

- Laminate/Wood combo units consist of a laminate worksurface and veneer shrouds and modesty
- Grain direction on shrouds is always vertical unless specifying a horizontal laminate
- Wire manager located on right side of desk; removeable panel allows for easy access
- Wire manager can be moved to opposite side in field if other side is preferred
- Any laminate modesty over 60" will be horizontal
- Control pad can be moved to RH or LH by the customer
- All models feature a 2 position memory
- Legs will be visible when the desk is in an upper position; specify paint color of Cinder or Platinum Metallic

**PRODUCT SPECIFICATIONS**

- Wood and laminate tops and chassis available; refer to page 358 for options
- Refer to page 362 for grommet locations and page 361 for grommet options and upcharge
- If specifying wood, you must specify the same finish for all options
- Center grommet location not available on desks

**TO ORDER, SPECIFY:**

1. Model Number
2. Rim
3. PVC Rim Color (laminated models)
4. Grommet
5. Paint
6. Laminate Top Color (laminated models)
7. Laminate Chassis Color (laminated models)
8. Finish (wood models)

**SAMPLE MODEL NUMBERS:**

WW3084DSFA1W F G1L 462 AD  
 WW3084DSFA1LW F G1R 462 440 MH  
 WW3084DSFA1L VPB X 462 PB PB

• See pages 356-361 for all options available in WaveWorks

**ADJUSTABLE HEIGHT  
 DESK SHELL  
 FULL FLUSH MODESTY  
 (CONTINUED)**

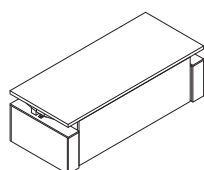

Approach view

MODEL NO./DESCRIPTION		LIST PRICE	DIMENSIONS				KW	CARTONED WEIGHT	CUBIC FEET
			D	W	H	A			
<b>1 1/2" TOP THICKNESS</b>									
<b>36" DEPTH</b>									
WW3684DSFA1W	Wood	\$ 9043	36 1/16	83 1/16	26 1/16	—	—	lbs.	
WW3684DSFA1LW	Laminate/Wood	9043	36 1/16	83 1/16	26 1/16	—	—	lbs.	
WW3684DSFA1L	Laminate	7794	36 1/16	83 1/16	26 1/16	—	—	lbs.	
<hr/>									
WW3678DSFA1W	Wood	\$ 8799	36 1/16	77 1/16	26 1/16	—	—	lbs.	
WW3678DSFA1LW	Laminate/Wood	8799	36 1/16	77 1/16	26 1/16	—	—	lbs.	
WW3678DSFA1L	Laminate	7678	36 1/16	77 1/16	26 1/16	—	—	lbs.	
<hr/>									
WW3672DSFA1W	Wood	\$ 8555	36 1/16	71 1/16	26 1/16	—	—	lbs.	
WW3672DSFA1LW	Laminate/Wood	8555	36 1/16	71 1/16	26 1/16	—	—	lbs.	
WW3672DSFA1L	Laminate	7557	36 1/16	71 1/16	26 1/16	—	—	lbs.	
<hr/>									
<b>30" DEPTH</b>									
WW3084DSFA1W	Wood	\$ 8224	30 1/16	83 1/16	26 1/16	—	—	lbs.	
WW3084DSFA1LW	Laminate/Wood	8224	30 1/16	83 1/16	26 1/16	—	—	lbs.	
WW3084DSFA1L	Laminate	6594	30 1/16	83 1/16	26 1/16	—	—	lbs.	
<hr/>									
WW3078DSFA1W	Wood	\$ 7980	30 1/16	77 1/16	26 1/16	—	—	lbs.	
WW3078DSFA1LW	Laminate/Wood	7980	30 1/16	77 1/16	26 1/16	—	—	lbs.	
WW3078DSFA1L	Laminate	6474	30 1/16	77 1/16	26 1/16	—	—	lbs.	
<hr/>									
WW3072DSFA1W	Wood	\$ 7736	30 1/16	71 1/16	26 1/16	—	—	lbs.	
WW3072DSFA1LW	Laminate/Wood	7736	30 1/16	71 1/16	26 1/16	—	—	lbs.	
WW3072DSFA1L	Laminate	6357	30 1/16	71 1/16	26 1/16	—	—	lbs.	
<hr/>									
WW3066DSFA1W	Wood	\$ 7492	30 1/16	66	26 1/16	—	—	lbs.	
WW3066DSFA1LW	Laminate/Wood	7492	30 1/16	66	26 1/16	—	—	lbs.	
WW3066DSFA1L	Laminate	6237	30 1/16	66	26 1/16	—	—	lbs.	
<hr/>									
WW3060DSFA1W	Wood	\$ 7247	30 1/16	60	26 1/16	—	—	lbs.	
WW3060DSFA1LW	Laminate/Wood	7247	30 1/16	60	26 1/16	—	—	lbs.	
WW3060DSFA1L	Laminate	6117	30 1/16	60	26 1/16	—	—	lbs.	
<hr/>									
<b>24" DEPTH</b>									
WW2454DSFA1W	Wood	\$ 5385	24	54	26 1/16	—	—	lbs.	
WW2454DSFA1LW	Laminate/Wood	5385	24	54	26 1/16	—	—	lbs.	
WW2454DSFA1L	Laminate	4867	24	54	26 1/16	—	—	lbs.	
<hr/>									
WW2448DSFA1W	Wood	\$ 5279	24	48 1/16	26 1/16	—	—	lbs.	
WW2448DSFA1LW	Laminate/Wood	5279	24	48 1/16	26 1/16	—	—	lbs.	
WW2448DSFA1L	Laminate	4759	24	48 1/16	26 1/16	—	—	lbs.	

- Laminate/Wood combo units consist of a laminate worksurface and veneer shrouds and modesty
- Grain direction on shrouds is always vertical unless specifying a horizontal laminate
- Wire manager located on right side of desk; removeable panel allows for easy access
- Wire manager can be moved to opposite side in field if other side is preferred
- Any laminate modesty over 60" will be horizontal
- Control pad can be moved to RH or LH by the customer
- All models feature a 2 position memory
- Legs will be visible when the desk is in an upper position; specify paint color of Cinder or Platinum Metallic
- SIN 33721

# WAVEWORKS

## PRODUCT SPECIFICATIONS

- Wood and laminate tops and chassis available; refer to page 358 for options
- Refer to page 362 for grommet locations and page 361 for grommet options and upcharge
- If specifying wood, you must specify the same finish for all options
- Center grommet location not available on desks

## TO ORDER, SPECIFY:

1. Model Number
2. Rim
3. PVC Rim Color (laminate models)
4. Grommet
5. Paint
6. Laminate Top Color (laminate models)
7. Laminate Chassis Color (laminate models)
8. Finish (wood models)

## SAMPLE MODEL NUMBERS:

WWN3084DSFBA1W F G1L 462 AD  
 WWN3084DSFBA1LW F G1R 462 440 MH  
 WWN3084DSFBA1L VPB X 462 PB PB

- See pages 356-361 for all options available in WaveWorks

### ADJUSTABLE HEIGHT DESK SHELL BREAKFRONT FULL MODESTY

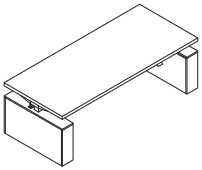

User side

MODEL NO./DESCRIPTION		LIST PRICE	DIMENSIONS					CARTONED CUBIC
			D	W	H	A	KW	WEIGHT FEET
<b>1 1/2" TOP THICKNESS 36" DEPTH</b>								
WWN3684DSFBA1W	Wood	\$ 9317	36 1/16	83 1/16	27 1/16	—	—	lbs.
WWN3684DSFBA1LW	Laminate/Wood	9317	36 1/16	83 1/16	27 1/16	—	—	lbs.
WWN3684DSFBA1L	Laminate	8069	36 1/16	83 1/16	27 1/16	—	—	lbs.
<hr/>								
WWN3678DSFBA1W	Wood	\$ 9073	36 1/16	77 1/16	27 1/16	—	—	lbs.
WWN3678DSFBA1LW	Laminate/Wood	9073	36 1/16	77 1/16	27 1/16	—	—	lbs.
WWN3678DSFBA1L	Laminate	7952	36 1/16	77 1/16	27 1/16	—	—	lbs.
<hr/>								
WWN3672DSFBA1W	Wood	\$ 8829	36 1/16	71 1/16	27 1/16	—	—	lbs.
WWN3672DSFBA1LW	Laminate/Wood	8829	36 1/16	71 1/16	27 1/16	—	—	lbs.
WWN3672DSFBA1L	Laminate	7832	36 1/16	71 1/16	27 1/16	—	—	lbs.
<hr/>								
<b>30" DEPTH</b>								
WWN3084DSFBA1W	Wood	\$ 8499	30 1/16	83 1/16	27 1/16	—	—	lbs.
WWN3084DSFBA1LW	Laminate/Wood	8499	30 1/16	83 1/16	27 1/16	—	—	lbs.
WWN3084DSFBA1L	Laminate	6868	30 1/16	83 1/16	27 1/16	—	—	lbs.
<hr/>								
WWN3078DSFBA1W	Wood	\$ 8254	30 1/16	77 1/16	27 1/16	—	—	lbs.
WWN3078DSFBA1LW	Laminate/Wood	8254	30 1/16	77 1/16	27 1/16	—	—	lbs.
WWN3078DSFBA1L	Laminate	6750	30 1/16	77 1/16	27 1/16	—	—	lbs.
<hr/>								
WWN3072DSFBA1W	Wood	\$ 8010	30 1/16	71 1/16	27 1/16	—	—	lbs.
WWN3072DSFBA1LW	Laminate/Wood	8010	30 1/16	71 1/16	27 1/16	—	—	lbs.
WWN3072DSFBA1L	Laminate	6630	30 1/16	71 1/16	27 1/16	—	—	lbs.
<hr/>								
WWN3066DSFBA1W	Wood	\$ 7767	30 1/16	66	27 1/16	—	—	lbs.
WWN3066DSFBA1LW	Laminate/Wood	7767	30 1/16	66	27 1/16	—	—	lbs.
WWN3066DSFBA1L	Laminate	6512	30 1/16	66	27 1/16	—	—	lbs.
<hr/>								
WWN3060DSFBA1W	Wood	\$ 7521	30 1/16	60	27 1/16	—	—	lbs.
WWN3060DSFBA1LW	Laminate/Wood	7521	30 1/16	60	27 1/16	—	—	lbs.
WWN3060DSFBA1L	Laminate	6391	30 1/16	60	27 1/16	—	—	lbs.

- Laminate/Wood combo units consist of a laminate worksurface and veneer shrouds and modesty
- Grain direction on shrouds is always vertical unless specifying a horizontal laminate
- Wire manager located on right side of desk; removeable panel allows for easy access
- Wire manager can be moved to opposite side in field if other side is preferred
- Any laminate modesty over 60" will be horizontal
- Control pad can be moved to RH or LH by the customer
- All models feature a 2 position memory
- Legs will be visible when the desk is in an upper position; specify paint color of Cinder or Platinum Metallic
- SIN 33721

**PRODUCT SPECIFICATIONS**

- Wood and laminate tops and chassis available; refer to page 358 for options
- Refer to page 362 for grommet locations and page 361 for grommet options and upcharge
- If specifying wood, you must specify the same finish for all options
- Center grommet location not available on desks

**TO ORDER, SPECIFY:**

1. Model Number
2. Rim
3. PVC Rim Color (laminated models)
4. Grommet
5. Paint
6. Laminate Top Color (laminated models)
7. Laminate Chassis Color (laminated models)
8. Finish (wood models)

**SAMPLE MODEL NUMBERS:**

WW3084DSFBA1W F G1L 462 AD  
 WW3084DSFBA1LW F G1R 462 440 MH  
 WW3084DSFBA1L VPB X 462 PB PB

• See pages 356-361 for all options available in WaveWorks

**ADJUSTABLE HEIGHT  
 DESK SHELL  
 BREAKFRONT FULL  
 MODESTY  
 (CONTINUED)**

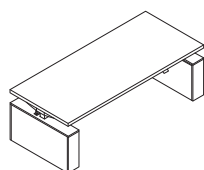

User side

MODEL NO./DESCRIPTION		LIST PRICE	DIMENSIONS				CARTONED CUBIC
			D	W	H	A	WEIGHT FEET
<b>1 1/16" TOP THICKNESS 36" DEPTH</b>							
WW3684DSFBA1W	Wood	\$ 9179	36 1/16	83 1/16	26 1/16	—	lbs.
WW3684DSFBA1LW	Laminate/Wood	9179	36 1/16	83 1/16	26 1/16	—	lbs.
WW3684DSFBA1L	Laminate	7934	36 1/16	83 1/16	26 1/16	—	lbs.
<hr/>							
WW3678DSFBA1W	Wood	\$ 8936	36 1/16	77 1/16	26 1/16	—	lbs.
WW3678DSFBA1LW	Laminate/Wood	8936	36 1/16	77 1/16	26 1/16	—	lbs.
WW3678DSFBA1L	Laminate	7814	36 1/16	77 1/16	26 1/16	—	lbs.
<hr/>							
WW3672DSFBA1W	Wood	\$ 8693	36 1/16	71 1/16	26 1/16	—	lbs.
WW3672DSFBA1LW	Laminate/Wood	8693	36 1/16	71 1/16	26 1/16	—	lbs.
WW3672DSFBA1L	Laminate	7693	36 1/16	71 1/16	26 1/16	—	lbs.
<hr/>							
<b>30" DEPTH</b>							
WW3084DSFBA1W	Wood	\$ 8362	30 1/16	83 1/16	26 1/16	—	lbs.
WW3084DSFBA1LW	Laminate/Wood	8362	30 1/16	83 1/16	26 1/16	—	lbs.
WW3084DSFBA1L	Laminate	6731	30 1/16	83 1/16	26 1/16	—	lbs.
<hr/>							
WW3078DSFBA1W	Wood	\$ 8117	30 1/16	77 1/16	26 1/16	—	lbs.
WW3078DSFBA1LW	Laminate/Wood	8117	30 1/16	77 1/16	26 1/16	—	lbs.
WW3078DSFBA1L	Laminate	6614	30 1/16	77 1/16	26 1/16	—	lbs.
<hr/>							
WW3072DSFBA1W	Wood	\$ 7874	30 1/16	71 1/16	26 1/16	—	lbs.
WW3072DSFBA1LW	Laminate/Wood	7874	30 1/16	71 1/16	26 1/16	—	lbs.
WW3072DSFBA1L	Laminate	6493	30 1/16	71 1/16	26 1/16	—	lbs.
<hr/>							
WW3066DSFBA1W	Wood	\$ 7629	30 1/16	66	26 1/16	—	lbs.
WW3066DSFBA1LW	Laminate/Wood	7629	30 1/16	66	26 1/16	—	lbs.
WW3066DSFBA1L	Laminate	6374	30 1/16	66	26 1/16	—	lbs.
<hr/>							
WW3060DSFBA1W	Wood	\$ 7384	30 1/16	60	26 1/16	—	lbs.
WW3060DSFBA1LW	Laminate/Wood	7384	30 1/16	60	26 1/16	—	lbs.
WW3060DSFBA1L	Laminate	6255	30 1/16	60	26 1/16	—	lbs.

- Laminate/Wood combo units consist of a laminate worksurface and veneer shrouds and modesty
- Grain direction on shrouds is always vertical unless specifying a horizontal laminate
- Wire manager located on right side of desk; removeable panel allows for easy access
- Wire manager can be moved to opposite side in field if other side is preferred
- Any laminate modesty over 60" will be horizontal
- Control pad can be moved to RH or LH by the customer
- All models feature a 2 position memory
- Legs will be visible when the desk is in an upper position; specify paint color of Cinder or Platinum Metallic
- SIN 33721

# WAVEWORKS

**TO ORDER, SPECIFY:**

1. Model Number

**SAMPLE MODEL NUMBERS:**

NAC05PCONB

• See pages 356-361 for all options available in WaveWorks

MODEL NO./DESCRIPTION	LIST PRICE	DIMENSIONS					CARTONED CUBIC	
		D	W	H	A	KW	WEIGHT	FEET
NAC05PCONB      Black	\$ 246	2½	5½	1	—	—	3 lbs.	0.1

**4 POSITION PROGRAMMABLE MEMORY CONTROL FOR ADJUSTABLE HEIGHT UNITS**



- Will allow 4 position programmable option and digital readout.
- To be specified when needing a 4 position memory control on any WaveWorks, Tessera, or Naviyd Height Adjustable Desk models, as these models have a 2 position memory control switch as standard

WAVEWORKS

ASSEMBLED



**PRODUCT SPECIFICATIONS**

- Wood and laminate tops and chassis available; refer to page 358 for options
- Refer to pages 741-784 for accessories
- Assembled units and component units are interchangeable
- Refer to page 362 for grommet locations and page 361 for grommet options and upcharge
- If specifying wood, you must specify the same finish for all options
- Center grommet location not available on desks

**TO ORDER, SPECIFY:**

1. Model Number
2. Rim
3. PVC Rim Color (laminated models)
4. Grommet
5. Laminate Top Color (laminated/combo models)
6. Laminate Door/Drawer Color (laminated models)
7. Veneer Chassis Finish/Laminated Chassis Color

**SAMPLE MODEL NUMBERS:**

- WWN3072DUW R G1L NL AC  
 WWN3072DUL VHN2 G1L AC2 AC2
- See pages 356-361 for all options available in WaveWorks

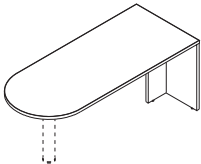
	MODEL NO./DESCRIPTION	LIST PRICE	DIMENSIONS					CARTONED WEIGHT	CUBIC FEET	
			D	W	H	A	KW			
<p><b>U-SHAPED DESK</b></p> 	<b>1 1/16" TOP THICKNESS</b>									
	WWN3672DUW	Wood	\$ 2894	36 1/16	71 1/16	29 3/8	—	—	145 lbs.	8.8
	WWN3672DULW	Laminated/Wood	2894	36 1/16	71 1/16	29 3/8	—	—	145 lbs.	8.8
	WWN3672DUL	Laminated	1717	36 1/16	71 1/16	29 3/8	—	—	145 lbs.	8.8
	WWN3072DUW	Wood	\$ 2735	30 3/16	71 1/16	29 3/8	—	—	130 lbs.	8.5
	WWN3072DULW	Laminated/Wood	2735	30 3/16	71 1/16	29 3/8	—	—	130 lbs.	8.5
	WWN3072DUL	Laminated	1450	30 3/16	71 1/16	29 3/8	—	—	130 lbs.	8.5
	WWN3066DUW	Wood	\$ 2578	30 3/16	66	29 3/8	—	—	100 lbs.	6.3
	WWN3066DULW	Laminated/Wood	2578	30 3/16	66	29 3/8	—	—	100 lbs.	6.3
	WWN3066DUL	Laminated	1186	30 3/16	66	29 3/8	—	—	100 lbs.	6.3

- Not recommended as a freestanding unit
- Support base must be ordered separately; see pages 669-672 for support base options
- Some assembly required

# WAVEWORKS

## PRODUCT SPECIFICATIONS

- Wood and laminate tops and chassis available; refer to page 358 for options
- Refer to pages 741-784 for accessories
- Assembled units and component units are interchangeable
- Refer to page 362 for grommet locations and page 361 for grommet options and upcharge
- If specifying wood, you must specify the same finish for all options
- Center grommet location not available on desks

## TO ORDER, SPECIFY:

1. Model Number
2. Rim
3. PVC Rim Color (laminate models)
4. Grommet
5. Laminate Top Color (laminate/combo models)
6. Laminate Door/Drawer Color (laminate models)
7. Veneer Chassis Finish/Laminate Chassis Color

## SAMPLE MODEL NUMBERS:

WW3072DUW R G1L NL AC  
 WW3072DUL VHN2 G1L AC2 AC2

- See pages 356-361 for all options available in WaveWorks

MODEL NO./DESCRIPTION	LIST PRICE	DIMENSIONS					CARTONED WEIGHT	CUBIC FEET
		D	W	H	A	KW		
<b>U-SHAPED DESK (CONTINUED)</b>								
<b>1 3/16" TOP THICKNESS</b>								
WW3672DUW Wood	\$ 2630	36 3/16	71 1/16	28 1/16	—	—	145 lbs.	8.8
WW3672DULW Laminate/Wood	2630	36 3/16	71 1/16	28 1/16	—	—	145 lbs.	8.8
WW3672DUL Laminate	1559	36 3/16	71 1/16	28 1/16	—	—	145 lbs.	8.8
WW3672DULL TFL	1246	36 3/16	71 1/16	28 7/8	—	—	145 lbs.	8.8
<hr/>								
WW3072DUW Wood	\$ 2487	30 3/16	71 1/16	28 1/16	—	—	130 lbs.	8.5
WW3072DULW Laminate/Wood	2487	30 3/16	71 1/16	28 1/16	—	—	130 lbs.	8.5
WW3072DUL Laminate	1318	30 3/16	71 1/16	28 1/16	—	—	130 lbs.	8.5
WW3072DULL TFL	1053	30 3/16	71 1/16	28 7/8	—	—	130 lbs.	8.5
<hr/>								
WW3066DUW Wood	\$ 2344	30 3/16	66	28 1/16	—	—	100 lbs.	6.3
WW3066DULW Laminate/Wood	2344	30 3/16	66	28 1/16	—	—	100 lbs.	6.3
WW3066DUL Laminate	1079	30 3/16	66	28 1/16	—	—	100 lbs.	6.3
WW3066DULL TFL	861	30 3/16	66	28 7/8	—	—	100 lbs.	6.3

### U-SHAPED DESK (CONTINUED)

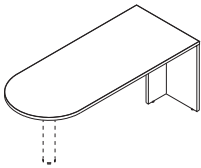

- Not recommended as a freestanding unit
- Support base must be ordered separately; see pages 669-672 for support base options
- Some assembly required

WAVEWORKS

ASSEMBLED

**PRODUCT SPECIFICATIONS**

- Wood and laminate tops and chassis available; refer to page 358 for options
- Refer to pages 741-784 for accessories
- Assembled units and component units are interchangeable
- Refer to page 362 for grommet locations and page 361 for grommet options and upcharge
- If specifying wood, you must specify the same finish for all options
- Center grommet location not available on desks

**TO ORDER, SPECIFY:**

1. Model Number
2. Rim
3. PVC Rim Color (laminated models)
4. Grommet
5. Laminate Top Color (laminated/combo models)
6. Laminate Door/Drawer Color (laminated models)
7. Veneer Chassis Finish/Laminated Chassis Color

**SAMPLE MODEL NUMBERS:**

- WWN3072DUFW R G1L NL AC  
 WWN3072DUFL VHN2 G1L AC2 AC2
- See pages 356-361 for all options available in WaveWorks

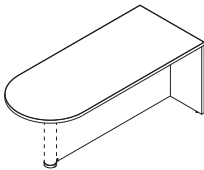
	MODEL NO./DESCRIPTION	LIST PRICE	DIMENSIONS					CARTONED WEIGHT	CUBIC FEET	
			D	W	H	A	KW			
<b>U-SHAPED DESK WITH MODESTY PANEL</b> 	<b>1 1/8" TOP THICKNESS</b>									
	WWN3672DUFW	Wood	\$ 3752	36 1/8	71 1/8	29 3/8	14 1/8	—	165 lbs.	8.9
	WWN3672DUFLW	Laminated/Wood	3752	36 1/8	71 1/8	29 3/8	14 1/8	—	165 lbs.	8.9
	WWN3672DUFL	Laminated	2241	36 1/8	71 1/8	29 3/8	14 1/8	—	165 lbs.	8.9
	WWN3072DUFW	Wood	\$ 3473	30 1/8	71 1/8	29 3/8	14 1/8	—	150 lbs.	8.6
	WWN3072DUFLW	Laminated/Wood	3473	30 1/8	71 1/8	29 3/8	14 1/8	—	150 lbs.	8.6
	WWN3072DUFL	Laminated	1977	30 1/8	71 1/8	29 3/8	14 1/8	—	150 lbs.	8.6
	WWN3066DUFW	Wood	\$ 3190	30 1/8	66	29 3/8	14 1/8	—	120 lbs.	6.5
	WWN3066DUFLW	Laminated/Wood	3190	30 1/8	66	29 3/8	14 1/8	—	120 lbs.	6.5
	WWN3066DUFL	Laminated	1715	30 1/8	66	29 3/8	14 1/8	—	120 lbs.	6.5

- Not recommended as a freestanding unit
- Support base must be ordered separately; see pages 669-672 for support base options
- Some assembly required

WAVEWORKS ASSEMBLED

# WAVEWORKS

## PRODUCT SPECIFICATIONS

- Wood and laminate tops and chassis available; refer to page 358 for options
- Refer to pages 741-784 for accessories
- Assembled units and component units are interchangeable
- Refer to page 362 for grommet locations and page 361 for grommet options and upcharge
- If specifying wood, you must specify the same finish for all options
- Center grommet location not available on desks

## TO ORDER, SPECIFY:

1. Model Number
2. Rim
3. PVC Rim Color (laminate models)
4. Grommet
5. Laminate Top Color (laminate/combo models)
6. Laminate Door/Drawer Color (laminate models)
7. Veneer Chassis Finish/Laminate Chassis Color

## SAMPLE MODEL NUMBERS:

WW3072DUFW R G1L NL AC  
 WW3072DUFL VHN2 G1L AC2 AC2

- See pages 356-361 for all options available in WaveWorks

MODEL NO./DESCRIPTION	LIST PRICE	DIMENSIONS					CARTONED WEIGHT	CUBIC FEET
		D	W	H	A	KW		
<b>U-SHAPED DESK WITH MODESTY PANEL (CONTINUED)</b>								
<b>1 3/16" TOP THICKNESS</b>								
WW3672DUFW Wood	\$ 3412	36 3/16	71 1/16	28 1/16	14 1/16	—	165 lbs.	8.9
WW3672DUFLW Laminate/Wood	3412	36 3/16	71 1/16	28 1/16	14 1/16	—	165 lbs.	8.9
WW3672DUFL Laminate	2038	36 3/16	71 1/16	28 1/16	14 1/16	—	165 lbs.	8.9
WW3672DUFL TFL	1629	36 3/16	71 1/16	28 7/8	14 1/16	—	165 lbs.	8.9
<hr/>								
WW3072DUFW Wood	\$ 3156	30 3/16	71 1/16	28 1/16	14 1/16	—	150 lbs.	8.6
WW3072DUFLW Laminate/Wood	3156	30 3/16	71 1/16	28 1/16	14 1/16	—	150 lbs.	8.6
WW3072DUFL Laminate	1794	30 3/16	71 1/16	28 1/16	14 1/16	—	150 lbs.	8.6
WW3072DUFL TFL	1436	30 3/16	71 1/16	28 7/8	14 1/16	—	150 lbs.	8.6
<hr/>								
WW3066DUFW Wood	\$ 2901	30 3/16	66	28 1/16	14 1/16	—	120 lbs.	6.5
WW3066DUFLW Laminate/Wood	2901	30 3/16	66	28 1/16	14 1/16	—	120 lbs.	6.5
WW3066DUFL Laminate	1558	30 3/16	66	28 1/16	14 1/16	—	120 lbs.	6.5
WW3066DUFL TFL	1246	30 3/16	66	28 7/8	14 1/16	—	120 lbs.	6.5

**U-SHAPED DESK WITH MODESTY PANEL (CONTINUED)**

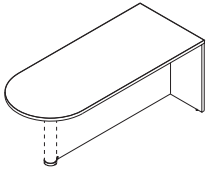

- Not recommended as a freestanding unit
- Support base must be ordered separately; see pages 669-672 for support base options
- Some assembly required

WAVEWORKS

ASSEMBLED

**PRODUCT SPECIFICATIONS**

- Wood and laminate tops and chassis available; refer to page 358 for options
- Refer to pages 741-784 for accessories
- Assembled units and component units are interchangeable
- Refer to page 362 for grommet locations and page 361 for grommet options and upcharge
- If specifying wood, you must specify the same finish for all options
- Center grommet location not available on P-shaped desks

**TO ORDER, SPECIFY:**

1. Model Number
2. Rim
3. PVC Rim Color (laminite models)
4. Laminate Top Color (laminite/combo models)
5. Laminate Door/Drawer Color (laminite models)
6. Veneer Chassis Finish/Laminite Chassis Color

**SAMPLE MODEL NUMBERS:**

- WW3072DPLW R AC  
 WW3072DPLL VHN2 AC2 AC2
- See pages 356-361 for all options available in WaveWorks

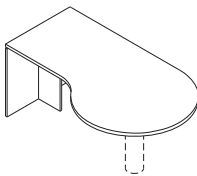
	MODEL NO./DESCRIPTION	LIST PRICE	DIMENSIONS				CARTONED CUBIC				
			D	W	H	A	KW	WEIGHT	FEET		
<b>P-SHAPED DESK</b> 	<b>1 1/16" TOP THICKNESS</b>										
	<b>LEFT P</b>	<b>RIGHT P</b>									
	WWN3072DPLW	WWN3072DPRW	Wood	\$ 3028	36 1/16	71 1/16	29 7/16	—	—	110 lbs.	6.9
	WWN3072DPLLW	WWN3072DPRLW	Laminite/Wood	3028	36 1/16	71 1/16	29 7/16	—	—	110 lbs.	6.9
	WWN3072DPLL	WWN3072DPRL	Laminite	1796	36 1/16	71 1/16	29 7/16	—	—	110 lbs.	6.9
	<b>1 1/16" TOP THICKNESS</b>										
	<b>LEFT P</b>	<b>RIGHT P</b>									
	WW3072DPLW	WW3072DPRW	Wood	\$ 2754	36 1/16	71 1/16	29 7/16	—	—	110 lbs.	6.9
	WW3072DPLLW	WW3072DPRLW	Laminite/Wood	2754	36 1/16	71 1/16	29 7/16	—	—	110 lbs.	6.9
WW3072DPLL	WW3072DPRL	Laminite	1632	36 1/16	71 1/16	29 7/16	—	—	110 lbs.	6.9	
WW3072DPLLL	WW3072DPRL	TFL	1308	36 1/16	71 1/16	29	—	—	110 lbs.	6.9	

- Not recommended as a freestanding unit
- Support base must be ordered separately; see pages 669-672 for support base options; some assembly required

WAVEWORKS

ASSEMBLED

# WAVEWORKS

## PRODUCT SPECIFICATIONS

- Wood and laminate tops and chassis available; refer to page 358 for options
- Refer to pages 741-784 for accessories
- Assembled units and component units are interchangeable
- Refer to page 362 for grommet locations and page 361 for grommet options and upcharge
- If specifying wood, you must specify the same finish for all options
- Center grommet location not available on P-shaped desks

## TO ORDER, SPECIFY:

1. Model Number
2. Rim
3. PVC Rim Color (laminate models)
4. Laminate Top Color (laminate/combo models)
5. Laminate Door/Drawer Color (laminate models)
6. Veneer Chassis Finish/Laminate Chassis Color

## SAMPLE MODEL NUMBERS:

WW3072DPLFW R AC  
 WW3072DPLFL VHN2 AC2 AC2

- See pages 356-361 for all options available in WaveWorks

MODEL NO./DESCRIPTION	LIST PRICE	DIMENSIONS					CARTONED WEIGHT	CUBIC FEET		
		D	W	H	A	KW				
<b>P-SHAPED DESK WITH MODESTY PANEL</b>										
<b>1 1/16" TOP THICKNESS WITH MODESTY</b>										
<b>LEFT P</b>			<b>RIGHT P</b>							
WWN3072DPLFW	WWN3072DPRFW	Wood	\$ 3760	36 1/16	71 1/16	29 7/16	14 1/16	—	130 lbs.	8.8
WWN3072DPLFLW	WWN3072DPRFLW	Laminate/Wood	3760	36 1/16	71 1/16	29 7/16	14 1/16	—	130 lbs.	8.8
WWN3072DPLFL	WWN3072DPRFL	Laminate	2268	36 1/16	71 1/16	29 7/16	14 1/16	—	130 lbs.	8.8
<b>1 3/16" TOP THICKNESS WITH MODESTY</b>										
<b>LEFT P</b>			<b>RIGHT P</b>							
WW3072DPLFW	WW3072DPRFW	Wood	\$ 3416	36 1/16	71 1/16	29 7/16	14 1/16	—	130 lbs.	8.8
WW3072DPLFLW	WW3072DPRFLW	Laminate/Wood	3416	36 1/16	71 1/16	29 7/16	14 1/16	—	130 lbs.	8.8
WW3072DPLFL	WW3072DPRFL	Laminate	2064	36 1/16	71 1/16	29 7/16	14 1/16	—	130 lbs.	8.8
WW3072DPLFLL	WW3072DPRFLL	TFL	1650	36 1/16	71 1/16	29	14 1/16	—	130 lbs.	8.8

### P-SHAPED DESK WITH MODESTY PANEL

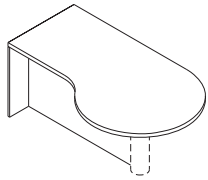

Left shown

- Not recommended as a freestanding unit
- Support base must be ordered separately; see pages 669-672 for support base options; some assembly required

WAVEWORKS

ASSEMBLED

**PRODUCT SPECIFICATIONS**

- Wood and laminate tops and chassis available; refer to page 358 for options
- Refer to pages 741-784 for accessories
- Assembled units and component units are interchangeable
- If specifying wood, you must specify the same finish for all options
- Only available grommet option on corner units is center location
- Refer to page 361 for grommet options and upcharge

**TO ORDER, SPECIFY:**

1. Model Number
2. Rim
3. PVC Rim Color (laminate models)
4. Grommet
5. Laminate Top Color (laminate/combo models)
6. Veneer Chassis Finish/Laminate Chassis Color

**SAMPLE MODEL NUMBERS:**

WW4242CFSW2	P	G11SNC	MC		
WW4242CFSL2	V	G11SNC	MC	440	MC
WW4242CFSLWL2	P	G11SNC	440	MC	440
WW4242CFSLW2	P	G11SNC	440	MC	

- See pages 356-361 for all options available in WaveWorks

**CORNER UNIT**

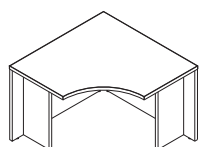

Grain direction runs diagonally

MODEL NO./DESCRIPTION	LIST PRICE	DIMENSIONS					CARTONED WEIGHT	CUBIC FEET
		D	W	H	A	KW		
<b>1 1/8" TOP THICKNESS</b>								
WWN4242CFSW2 Wood	\$ 3220	42 1/16	42 1/16	29 3/16	1/16	—	145 lbs.	50.4
WWN4242CFSLW2 Laminate/Wood	3220	42 1/16	42 1/16	29 3/16	1/16	—	145 lbs.	50.4
WWN4242CFSL2 Laminate	1956	42 1/16	42 1/16	29 3/16	1/16	—	145 lbs.	50.4
WWN4242CFSWL2 Wood/Laminate	2739	42 1/16	42 1/16	29 3/16	1/16	—	145 lbs.	50.4
WWN4242CFSLWL2 Laminate/Wood/Laminate	2739	42 1/16	42 1/16	29 3/16	1/16	—	145 lbs.	50.4
<b>1 1/8" TOP THICKNESS</b>								
WW4242CFSW2 Wood	\$ 2925	42 1/16	42 1/16	28 1/16	1/16	—	145 lbs.	50.4
WW4242CFSLW2 Laminate/Wood	2925	42 1/16	42 1/16	28 1/16	1/16	—	145 lbs.	50.4
WW4242CFSL2 Laminate	1780	42 1/16	42 1/16	28 1/16	1/16	—	145 lbs.	50.4
WW4242CFSL2 TFL	1425	42 1/16	42 1/16	28 1/16	1/16	—	145 lbs.	50.4
WW4242CFSWL2 Wood/Laminate	2488	42 1/16	42 1/16	28 1/16	1/16	—	145 lbs.	50.4
WW4242CFSLWL2 Laminate/Wood/Laminate	2488	42 1/16	42 1/16	28 1/16	1/16	—	145 lbs.	50.4
<ul style="list-style-type: none"> <li>• Must be connected to 24" deep worksurfaces</li> <li>• 42" corner unit has 25 1/2" on front edge</li> </ul>								
<b>1 1/8" TOP THICKNESS</b>								
WWN3636CFSW2 Wood	\$ 3013	36 1/16	36 1/16	29 3/16	1/16	—	125 lbs.	25.9
WWN3636CFSLW2 Laminate/Wood	3013	36 1/16	36 1/16	29 3/16	1/16	—	125 lbs.	25.9
WWN3636CFSL2 Laminate	1840	36 1/16	36 1/16	29 3/16	1/16	—	125 lbs.	25.9
WWN3636CFSWL2 Wood/Laminate	2562	36 1/16	36 1/16	29 3/16	1/16	—	125 lbs.	25.9
WWN3636CFSLWL2 Laminate/Wood/Laminate	2562	36 1/16	36 1/16	29 3/16	1/16	—	125 lbs.	25.9
<b>1 1/8" TOP THICKNESS</b>								
WW3636CFSW2 Wood	\$ 2739	36 1/16	36 1/16	28 1/16	1/16	—	125 lbs.	25.9
WW3636CFSLW2 Laminate/Wood	2739	36 1/16	36 1/16	28 1/16	1/16	—	125 lbs.	25.9
WW3636CFSL2 Laminate	1676	36 1/16	36 1/16	28 1/16	1/16	—	125 lbs.	25.9
WW3636CFSL2 TFL	1339	36 1/16	36 1/16	28 1/16	1/16	—	125 lbs.	25.9
WW3636CFSWL2 Wood/Laminate	2330	36 1/16	36 1/16	28 1/16	1/16	—	125 lbs.	25.9
WW3636CFSLWL2 Laminate/Wood/Laminate	2330	36 1/16	36 1/16	28 1/16	1/16	—	125 lbs.	25.9
<ul style="list-style-type: none"> <li>• Grain direction runs diagonally</li> <li>• Must be connected to 24" deep worksurfaces</li> <li>• 36" unit has 17" on front edge</li> <li>• Not intended to be used as freestanding unit</li> </ul>								

WAVEWORKS

ASSEMBLED





**PRODUCT SPECIFICATIONS**

- Wood and laminate tops and chassis available; refer to page 358 for options
- Refer to pages 741-784 for accessories
- Assembled units and component units are interchangeable
- If specifying wood, you must specify the same finish for all options
- Refer to page 361 for grommet options and upcharge
- See pages 401-405 for reception unit thought starters and examples
- Undersurface pedestals available; see pages 521-531
- Reception worksurfaces available in 1<sup>1</sup>/<sub>2</sub>" only

**TO ORDER, SPECIFY:**

1. Model Number
2. Rim
3. PVC Rim Color (laminate models)
4. Grommet
5. Locking
6. Laminate Top Color (laminate/combo models)
7. Laminate Door/Drawer Color (laminate models)
8. Veneer Chassis Finish/ Laminate Chassis Color

**SAMPLE MODEL NUMBER:**

WW2572DSTF3W RX CW  
 • See pages 356-361 for all options available in WaveWorks



Shaded model numbers are available on our "To You in 10 Days or Less" Quick Delivery program and will be delivered in 10 days or less.

**RECEPTION DESK  
MAIN SHELL**

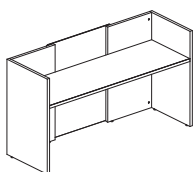

MODEL NO./DESCRIPTION		LIST PRICE	DIMENSIONS					CARTONED WEIGHT	CUBIC FEET
			D	W	H	A	KW		
WW2572DSTFW	Wood	\$ 6063	25	71 <sup>1</sup> / <sub>2</sub>	40 <sup>3</sup> / <sub>8</sub>	—	69 <sup>1</sup> / <sub>2</sub>	230 lbs.	52.0
WW2572DSTFLW	Laminate/Wood	6063	25	71 <sup>1</sup> / <sub>2</sub>	40 <sup>3</sup> / <sub>8</sub>	—	69 <sup>1</sup> / <sub>2</sub>	230 lbs.	52.0
WW2572DSTFL	Laminate	4910	25	71 <sup>1</sup> / <sub>2</sub>	40 <sup>3</sup> / <sub>8</sub>	—	69 <sup>1</sup> / <sub>2</sub>	230 lbs.	52.0
WW2572DSTFLL	TFL	3928	25	71 <sup>1</sup> / <sub>2</sub>	40 <sup>3</sup> / <sub>8</sub>	—	69 <sup>1</sup> / <sub>2</sub>	230 lbs.	52.0

- Frosted glass accent piece attached to approach side
- Do not specify pull option
- Center grommet location not available due to cords being visible through glass
- Unit is non-handed; can be used left or right to configure a U-station
- 23" deep undersurface pedestals can be ordered for storage; see pages 522-523
- Reception Counter Kits available; see pages 398-400 for additional information
- For tack board options, see pages 776-783
- When ordering a tack board, it is recommended to also order a reception counter kit for the best appearance

**RECEPTION DESK  
MAIN SHELL**

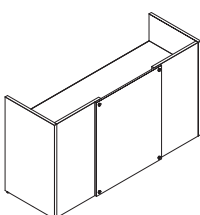

Approach view

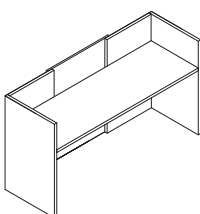

User view

MAIN SHELL			DIMENSIONS					CARTONED WEIGHT	CUBIC FEET
			D	W	H	A	KW		
QWW2572DSTF3W	Wood	\$ 4287	25	71 <sup>1</sup> / <sub>2</sub>	40 <sup>3</sup> / <sub>8</sub>	—	69 <sup>1</sup> / <sub>2</sub>	230 lbs.	52.0
WW2572DSTF3W	Wood	4287	25	71 <sup>1</sup> / <sub>2</sub>	40 <sup>3</sup> / <sub>8</sub>	—	69 <sup>1</sup> / <sub>2</sub>	230 lbs.	52.0
WW2572DSTF3L	Laminate	\$ 3117	25	71 <sup>1</sup> / <sub>2</sub>	40 <sup>3</sup> / <sub>8</sub>	—	69 <sup>1</sup> / <sub>2</sub>	230 lbs.	52.0
QWW2572DSTF3LL	TFL	2494	25	71 <sup>1</sup> / <sub>2</sub>	40 <sup>3</sup> / <sub>8</sub>	—	69 <sup>1</sup> / <sub>2</sub>	230 lbs.	52.0
WW2572DSTF3LL	TFL	2494	25	71 <sup>1</sup> / <sub>2</sub>	40 <sup>3</sup> / <sub>8</sub>	—	69 <sup>1</sup> / <sub>2</sub>	230 lbs.	52.0

- Wood worksurface/rim, wood front panel, wood chassis-no glass on unit
- Laminate worksurface/PVC rim, laminate front panel, laminate chassis-no glass on unit
- Do not specify pull option
- Unit is non-handed; can be used left or right to configure a U-station
- 23" deep undersurface pedestals can be ordered for storage; see pages 522-523
- Reception Counter Kits available; see pages 398-400 for additional information
- For tack board options, see pages 776-783
- When ordering a tack board, it is recommended to also order a reception counter kit for the best appearance

WAVEWORKS

ASSEMBLED

# WAVEWORKS

## PRODUCT SPECIFICATIONS

- Wood and laminate tops and chassis available; refer to page 358 for options
- Refer to pages 741-784 for accessories
- Assembled units and component units are interchangeable
- If specifying wood, you must specify the same finish for all options
- Refer to page 361 for grommet options and upcharge
- See pages 401-405 for reception unit thought starters and examples
- Undersurface pedestals available; see pages 521-531
- Reception worksurfaces available in 1<sup>1</sup>/<sub>2</sub>" only

## TO ORDER, SPECIFY:

1. Model Number
2. Rim
3. PVC Rim Color (laminated models)
4. Pull
5. Grommet
6. Locking
7. Laminate Top Color (laminated/combo models)
8. Laminate Door/Drawer Color (laminated models)
9. Veneer Chassis Finish/Laminate Chassis Color

## SAMPLE MODEL NUMBER:

WW2575DSTFLW F 72CC KRB AC

- See pages 356-361 for all options available in WaveWorks

**QD** Shaded model numbers are available on our "To You in 10 Days or Less" Quick Delivery program and will be delivered in 10 days or less.

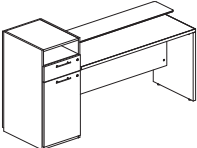
RECEPTION DESK ADA MAIN SHELL WITH VERTICAL TOWER	MODEL NO./DESCRIPTION		LIST PRICE	DIMENSIONS				CARTONED CUBIC			
	LEFT	RIGHT		D	W	H	A	KW	WEIGHT	FEET	
 Left shown	WW2575DSTFLW	WW2575DSTFRW	Wood	\$ 6546	26 <sup>1</sup> / <sub>16</sub>	74 <sup>1</sup> / <sub>16</sub>	29 <sup>3</sup> / <sub>16</sub>	8	54	230 lbs.	52.0
	WW2575DSTFLLW	WW2575DSTFRLW	Lam/Wood	6546	26 <sup>1</sup> / <sub>16</sub>	74 <sup>1</sup> / <sub>16</sub>	29 <sup>3</sup> / <sub>16</sub>	8	54	230 lbs.	52.0
	WW2575DSTFLL	WW2575DSTFRL	Laminate	5287	26 <sup>1</sup> / <sub>16</sub>	74 <sup>1</sup> / <sub>16</sub>	29 <sup>3</sup> / <sub>16</sub>	8	54	230 lbs.	52.0
	WW2575DSTFLLL	WW2575DSTFRLL	TFL	4228	26 <sup>1</sup> / <sub>16</sub>	74 <sup>1</sup> / <sub>16</sub>	29 <sup>3</sup> / <sub>16</sub>	8	54	230 lbs.	52.0
	<ul style="list-style-type: none"> <li>• Includes glass shelf on approach side</li> <li>• Grommet option not available</li> <li>• Kneespace depth is 15<sup>1</sup>/<sub>2</sub>"</li> <li>• Vertical tower has access door on approach side to access cords, 24" x 18" cornice tops available for tower; see page 484</li> <li>• Random lock core (KRB, KRS) and specified lock core (KS2B, KS2S) available</li> </ul>										
	<ul style="list-style-type: none"> <li>• In order to meet ADA standards from the approach side, specify an ADA compliant main shell and a reception return</li> <li>• Measurements of unit are compliant with the clearances outlined in the Americans with Disabilities Act guidelines for office furniture</li> <li>• In order to meet ADA standards from the user side, use the WW2866BSTF___, WW2866BSTF2___ or WW2563BSTF___ reception bridge</li> </ul>										

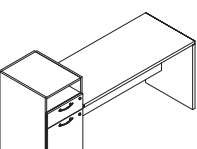
RECEPTION DESK ADA MAIN SHELL WITH VERTICAL TOWER	MODEL NO./DESCRIPTION		LIST PRICE	DIMENSIONS				CARTONED CUBIC			
	LEFT	RIGHT		D	W	H	A	KW	WEIGHT	FEET	
 Left shown	QWW2472DSTFLW	QWW2472DSTFRW	Wood	\$ 4855	24	72	29 <sup>3</sup> / <sub>16</sub>	8	54	230 lbs.	52.0
	WW2472DSTFLW	WW2472DSTFRW	Wood	4855	24	72	29 <sup>3</sup> / <sub>16</sub>	8	54	230 lbs.	52.0
	WW2472DSTFLLW	WW2472DSTFRLW	Lam/Wood	4855	24	72	29 <sup>3</sup> / <sub>16</sub>	8	54	230 lbs.	52.0
	WW2472DSTFLL	WW2472DSTFRL	Laminate	3584	24	72	29 <sup>3</sup> / <sub>16</sub>	8	54	230 lbs.	52.0
	QWW2472DSTFLLL	QWW2472DSTFRLL	TFL	2866	24	72	29 <sup>3</sup> / <sub>16</sub>	8	54	230 lbs.	52.0
	WW2472DSTFLLL	WW2472DSTFRLL	TFL	2866	24	72	29 <sup>3</sup> / <sub>16</sub>	8	54	230 lbs.	52.0
	<ul style="list-style-type: none"> <li>• No glass on unit</li> <li>• Reception Counter Kits available; see below</li> <li>• Grommet option not available</li> <li>• Kneespace depth is 15<sup>1</sup>/<sub>2</sub>"</li> <li>• Vertical tower has access door on approach side to access cords, 24" x 18" cornice tops available for tower; see page 484</li> <li>• Random lock core (KRB, KRS) and specified lock core (KS2B, KS2S) available</li> </ul>										
	<ul style="list-style-type: none"> <li>• Measurements of unit are compliant with the clearances outlined in the Americans with Disabilities Act guidelines for office furniture</li> <li>• In order to meet ADA standards from the approach side, specify an ADA compliant main shell and a reception return</li> <li>• In order to meet ADA standard from the user side, use the WW2866BSTF___, WW2866BSTF2___ or WW2563BSTF___ reception bridge</li> </ul>										

RECEPTION COUNTER KITS— ADA	MODEL NO./DESCRIPTION		LIST PRICE	DIMENSIONS				CARTONED CUBIC			
	LEFT	RIGHT		D	W	H	A	KW	WEIGHT	FEET	
	QWW1154TSW	Wood	\$ 933	11	54	1 <sup>1</sup> / <sub>2</sub>	—	—	42 lbs.	1.8	
	WW1154TSW	Wood	933	11	54	1 <sup>1</sup> / <sub>2</sub>	—	—	42 lbs.	1.8	
	WW1154TSLW	Laminate/Wood	933	11	54	1 <sup>1</sup> / <sub>2</sub>	—	—	42 lbs.	1.8	
	WW1154TSL	Laminate	905	11	54	1 <sup>1</sup> / <sub>2</sub>	—	—	42 lbs.	1.8	
	QWW1154TSLL	TFL	725	11	54	1 <sup>1</sup> / <sub>2</sub>	—	—	42 lbs.	1.8	
	WW1154TSLL	TFL	725	11	54	1 <sup>1</sup> / <sub>2</sub>	—	—	42 lbs.	1.8	
	<ul style="list-style-type: none"> <li>• For use with Reception Desk ADA Main Shell above</li> <li>• Unit includes stanchions to attach to the ADA Reception unit</li> </ul>										

**PRODUCT SPECIFICATIONS**

- Wood and laminate tops and chassis available; refer to page 358 for options
- Refer to pages 741-784 for accessories
- Assembled units and component units are interchangeable
- If specifying wood, you must specify the same finish for all options
- Refer to page 361 for grommet options and upcharge
- See pages 401-405 for reception unit thought starters and examples
- Undersurface pedestals available; see pages 521-531
- Reception worksurfaces available in 1 $\frac{1}{8}$ " only

**TO ORDER, SPECIFY:**

1. Model Number
2. Rim
3. PVC Rim Color (laminate models)
4. Grommet
5. Laminate Top Color (laminate/combo models)
6. Veneer Chassis Finish/Laminate Chassis Color

**SAMPLE MODEL NUMBERS:**

- WW2866BSTFW P G1C AC  
 WW2866BSTFL NMH G1C MH  
 WW2866BSTFLW F G1C 461 NH
- See pages 356-361 for all options available in WaveWorks

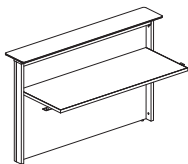
	MODEL NO./DESCRIPTION	LIST PRICE	DIMENSIONS				KW	CARTONED WEIGHT	CUBIC FEET
			D	W	H	A			
	WW2866BSTFW Wood	\$ 1430	28 $\frac{1}{16}$	66	42 $\frac{3}{4}$	—	66	260 lbs.	60.0
	WW2866BSTFLW Laminate/Wood	1430	28 $\frac{1}{16}$	66	42 $\frac{3}{4}$	—	66	260 lbs.	60.0
	WW2866BSTFL Laminate	986	28 $\frac{1}{16}$	66	42 $\frac{3}{4}$	—	66	260 lbs.	60.0
	WW2866BSTFLL TFL	790	28 $\frac{1}{16}$	66	42 $\frac{3}{4}$	—	66	260 lbs.	60.0
	WW2854BSTFW Wood	\$ 1230	28 $\frac{1}{16}$	54	42 $\frac{3}{4}$	—	54	243 lbs.	51.0
	WW2854BSTFLW Laminate/Wood	1230	28 $\frac{1}{16}$	54	42 $\frac{3}{4}$	—	54	243 lbs.	51.0
	WW2854BSTFL Laminate	750	28 $\frac{1}{16}$	54	42 $\frac{3}{4}$	—	54	243 lbs.	51.0
	WW2854BSTFLL TFL	601	28 $\frac{1}{16}$	54	42 $\frac{3}{4}$	—	54	243 lbs.	51.0

- Includes 11" deep clear glass reception counter and frosted glass accent piece attached to approach side
- Specify WW2866BSTF\_ reception bridge for ADA compliant user side
- When WW2866BSTFL is ordered with woodgrain laminate, laminate will run left-to-right on modesty panel
- Do not specify pull option
- Woodgrain on worksurfaces runs front-to-back
- For tack board options, see pages 776-783

**RECEPTION BRIDGE**

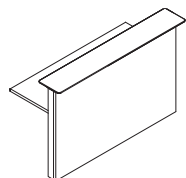

Approach view

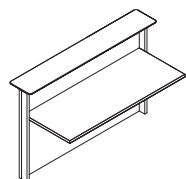

User view

WW2866BSTF2W Wood	\$ 1373	28 $\frac{1}{16}$	66	42 $\frac{3}{4}$	—	66	260 lbs.	60.0
WW2866BSTF2LW Laminate/Wood	1373	28 $\frac{1}{16}$	66	42 $\frac{3}{4}$	—	66	260 lbs.	60.0
WW2866BSTF2L Laminate	970	28 $\frac{1}{16}$	66	42 $\frac{3}{4}$	—	66	260 lbs.	60.0
WW2866BSTF2LL TFL	774	28 $\frac{1}{16}$	66	42 $\frac{3}{4}$	—	66	260 lbs.	60.0
WW2854BSTF2W Wood	\$ 1200	28 $\frac{1}{16}$	54	42 $\frac{3}{4}$	—	66	243 lbs.	51.0
WW2854BSTF2LW Laminate/Wood	1200	28 $\frac{1}{16}$	54	42 $\frac{3}{4}$	—	66	243 lbs.	51.0
WW2854BSTF2L Laminate	711	28 $\frac{1}{16}$	54	42 $\frac{3}{4}$	—	66	243 lbs.	51.0
WW2854BSTF2LL TFL	565	28 $\frac{1}{16}$	54	42 $\frac{3}{4}$	—	66	243 lbs.	51.0

- Includes 11" deep clear glass reception counter
- Specify WW2866BSTF\_ or WW2866BSTF2\_ reception bridge for ADA compliant user side
- When WW2866BSTF2L is ordered with woodgrain laminate, laminate will run left-to-right on modesty panel
- Do not specify pull option
- Grain direction runs front-to-back on worksurface
- For tack board options, see pages 776-783

WAVEWORKS

ASSEMBLED

# WAVEWORKS

## PRODUCT SPECIFICATIONS

- Wood and laminate tops and chassis available; refer to page 358 for options
- Refer to pages 741-784 for accessories
- Assembled units and component units are interchangeable
- If specifying wood, you must specify the same finish for all options
- Refer to page 361 for grommet options and upcharge
- See pages 401-405 for reception unit thought starters and examples
- Undersurface pedestals available; see pages 521-531
- Reception worksurfaces available in 1 $\frac{1}{8}$ " only

## TO ORDER, SPECIFY:

1. Model Number
2. Rim
3. PVC Rim Color (laminated models)
4. Grommet
5. Laminate Top Color (laminated/combo models)
6. Veneer Chassis Finish/Laminated Chassis Color

## SAMPLE MODEL NUMBERS:

WW2563BSTFW P G1C AC  
 WW2563BSTFL NMH G1C MH  
 WW2563BSTFLW F G1C 461 NH

- See pages 356-361 for all options available in WaveWorks

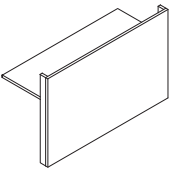
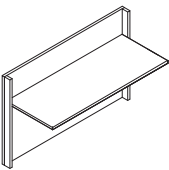

Shaded model numbers are available on our "To You in 10 Days or Less" Quick Delivery program and will be delivered in 10 days or less.

	MODEL NO./DESCRIPTION	LIST PRICE	DIMENSIONS					CARTONED CUBIC	
			D	W	H	A	KW	WEIGHT	FEET
<b>RECEPTION BRIDGE</b>  Approach view	QWW2563BSTFW Wood	\$ 1323	25 $\frac{1}{8}$ "	62 $\frac{1}{16}$ "	40 $\frac{3}{8}$ "	—	66	260 lbs.	60.0
	WW2563BSTFW Wood	1323	25 $\frac{1}{8}$ "	62 $\frac{1}{16}$ "	40 $\frac{3}{8}$ "	—	66	260 lbs.	60.0
	WW2563BSTFLW Laminate/Wood	1323	25 $\frac{1}{8}$ "	62 $\frac{1}{16}$ "	40 $\frac{3}{8}$ "	—	66	260 lbs.	60.0
	WW2563BSTFL Laminate	921	25 $\frac{1}{8}$ "	62 $\frac{1}{16}$ "	40 $\frac{3}{8}$ "	—	66	260 lbs.	60.0
	QWW2563BSTFLL TFL	734	25 $\frac{1}{8}$ "	62 $\frac{1}{16}$ "	40 $\frac{3}{8}$ "	—	66	260 lbs.	60.0
	WW2563BSTFLL TFL	734	25 $\frac{1}{8}$ "	62 $\frac{1}{16}$ "	40 $\frac{3}{8}$ "	—	66	260 lbs.	60.0
 User view	QWW2550BSTFW Wood	\$ 1148	25 $\frac{1}{8}$ "	50 $\frac{1}{16}$ "	40 $\frac{3}{8}$ "	—	66	243 lbs.	51.0
	WW2550BSTFW Wood	1148	25 $\frac{1}{8}$ "	50 $\frac{1}{16}$ "	40 $\frac{3}{8}$ "	—	66	243 lbs.	51.0
	WW2550BSTFLW Laminate/Wood	1148	25 $\frac{1}{8}$ "	50 $\frac{1}{16}$ "	40 $\frac{3}{8}$ "	—	66	243 lbs.	51.0
	WW2550BSTFL Laminate	658	25 $\frac{1}{8}$ "	50 $\frac{1}{16}$ "	40 $\frac{3}{8}$ "	—	66	243 lbs.	51.0
	QWW2550BSTFLL TFL	526	25 $\frac{1}{8}$ "	50 $\frac{1}{16}$ "	40 $\frac{3}{8}$ "	—	66	243 lbs.	51.0
	WW2550BSTFLL TFL	526	25 $\frac{1}{8}$ "	50 $\frac{1}{16}$ "	40 $\frac{3}{8}$ "	—	66	243 lbs.	51.0

- No glass on unit
- Reception Counter Kits available; see pages 398-400 for additional information
- Specify WW2563BSTF\_ reception bridge for ADA compliant user side
- When WW2563BSTFL is ordered with woodgrain laminate, laminate will run left-to-right on modesty panel
- Grain direction runs front-to-back on worksurface
- For tack board options, see pages 776-783
- When ordering a tack board, it is recommended to also order a reception counter kit for the best appearance

## RECEPTION RETURN

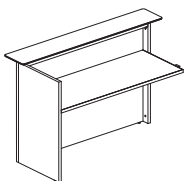

Left Shown

RECEPTION RETURN		LIST PRICE	DIMENSIONS					CARTONED CUBIC	
LEFT-SHELL	RIGHT-SHELL		D	W	H	A	KW	WEIGHT	FEET
WW2860RSTFLW	WW2860RSTFRW Wood	\$ 2190	27 $\frac{3}{4}$ "	60	42 $\frac{3}{8}$ "	—	59 $\frac{1}{4}$ "	175 lbs.	47.0
WW2860RSTFLLW	WW2860RSTFRLW Lam/Wood	2190	27 $\frac{3}{4}$ "	60	42 $\frac{3}{8}$ "	—	59 $\frac{1}{4}$ "	175 lbs.	47.0
WW2860RSTFLL	WW2860RSTFRL Laminate	2044	27 $\frac{3}{4}$ "	60	42 $\frac{3}{8}$ "	—	59 $\frac{1}{4}$ "	175 lbs.	47.0
WW2860RSTFLLL	WW2860RSTFRLL TFL	1637	27 $\frac{3}{4}$ "	60	42 $\frac{3}{8}$ "	—	59 $\frac{1}{4}$ "	175 lbs.	47.0

- Includes 11" deep clear glass reception counter and frosted glass accent piece attached to approach side
- Use with a main shell to make a reception L-station
- 23" deep undersurface pedestals can be ordered for storage; see pages 522-523
- Grain direction runs front-to-back on worksurface
- For tack board options, see pages 776-783

**PRODUCT SPECIFICATIONS**

- Wood and laminate tops and chassis available; refer to page 358 for options
- Refer to pages 741-784 for accessories
- Assembled units and component units are interchangeable
- If specifying wood, you must specify the same finish for all options
- Refer to page 361 for grommet options and upcharge
- See pages 401-405 for reception unit thought starters and examples
- Undersurface pedestals available; see pages 521-531
- Reception worksurfaces available in 1 7/8" only
- Counter kits shipped with appropriate hardware to attach to reception units
- Rim on all 4 sides of laminate and wood counter kits
- Refer to pages 401-402 for examples of how the counter kits can be used

**TO ORDER, SPECIFY:**

1. Model Number
2. Rim
3. PVC Rim Color (laminate models)
4. Grommet
5. Laminate Top Color (laminate/combo models)
6. Veneer Chassis Finish/Laminate Chassis Color

**SAMPLE MODEL NUMBERS:**

WW2860RSTFL2W P G1C AC  
 WW2860RSTFL2LW NMH G1C MH  
 WW2860RSTFL2L F G1C 461 NH

- See pages 356-361 for all options available in WaveWorks



Shaded model numbers are available on our "To You in 10 Days or Less" Quick Delivery program and will be delivered in 10 days or less.

MODEL NO./DESCRIPTION	LIST PRICE	DIMENSIONS				KW	CARTONED WEIGHT	CUBIC FEET
		D	W	H	A			
<b>RECEPTION RETURN</b>								
<b>LEFT-SHELL</b>								
<b>RIGHT-SHELL</b>								
WW2860RSTFL2W	2134	27 3/4	60	42 1/2	—	59 1/4	175 lbs.	47.0
WW2860RSTFL2LW	2134	27 3/4	60	42 1/2	—	59 1/4	175 lbs.	47.0
WW2860RSTFL2L	2004	27 3/4	60	42 1/2	—	59 1/4	175 lbs.	47.0
WW2860RSTFL2LL	1604	27 3/4	60	42 1/2	—	59 1/4	175 lbs.	47.0

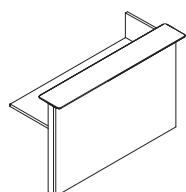

Approach view-left shown

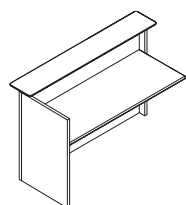

User view-left shown

- Includes 11" deep clear glass reception counter
- Use with a main shell to make a reception L-station
- 23" deep undersurface pedestals can be ordered for storage; see pages 522-523
- Grain direction runs front-to-back on worksurface
- For tack board options, see pages 776-783

MODEL NO./DESCRIPTION	LIST PRICE	DIMENSIONS				KW	CARTONED WEIGHT	CUBIC FEET
		D	W	H	A			
<b>RECEPTION RETURN</b>								
<b>LEFT-SHELL</b>								
<b>RIGHT-SHELL</b>								
QWW2460RSTFLW	2083	24 1/4	59 1/2	40 1/2	—	59 1/4	175 lbs.	47.0
WW2460RSTFLW	2083	24 1/4	59 1/2	40 1/2	—	59 1/4	175 lbs.	47.0
WW2460RSTFLLW	2083	24 1/4	59 1/2	40 1/2	—	59 1/4	175 lbs.	47.0
WW2460RSTFLL	1954	24 1/4	59 1/2	40 1/2	—	59 1/4	175 lbs.	47.0
QWW2460RSTFLLL	1563	24 1/4	59 1/2	40 1/2	—	59 1/4	175 lbs.	47.0
WW2460RSTFLLL	1563	24 1/4	59 1/2	40 1/2	—	59 1/4	175 lbs.	47.0

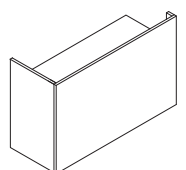

Approach view-right shown

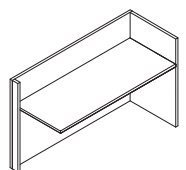

User view-right shown

- No glass on unit
- Reception Counter Kits available; see pages 398-400 for additional information
- Use with a main shell to make a reception L-station
- 23" deep undersurface pedestals can be ordered for storage; see pages 522-523
- Grain direction runs front-to-back on worksurface
- For tack board options, see pages 776-783
- When ordering a tack board, it is recommended to also order a reception counter kit for the best appearance

# WAVEWORKS

## PRODUCT SPECIFICATIONS

- Counter kits shipped with appropriate hardware to attach to reception units
- Rim on all 4 sides of laminate and wood counter kits
- Refer to pages 401-402 for examples of how the counter kits can be used

## TO ORDER, SPECIFY:

1. Model Number
2. Rim
3. PVC Rim Color (laminate models)
4. Laminate Top Color/Veneer Top Finish
5. Veneer Rim Finish (laminate/wood models)

## SAMPLE MODEL NUMBERS:

WWN15109TSW F MH  
 WWN15109TSLW F 405 MH  
 WWN15109TSL V405 MH

- See pages 356-361 for all options available in WaveWorks

MODEL NO./DESCRIPTION	LIST PRICE	DIMENSIONS					CARTONED WEIGHT	CUBIC FEET
		D	W	H	A	KW		
<b>RECEPTION COUNTER KITS</b>								
<b>1 1/16" TOP THICKNESS</b>								
WWN15109TSW Wood	\$ 1715	15 3/16	108 1/16	1 1/16	—	—	86 lbs.	3.5
WWN15109TSLW Laminate/Wood	1715	15 3/16	108 1/16	1 1/16	—	—	86 lbs.	3.5
WWN15109TSL Laminate	1667	15 3/16	108 1/16	1 1/16	—	—	86 lbs.	3.5
WWN1597TSW Wood	\$ 1397	15 3/16	96 1/16	1 1/16	—	—	76 lbs.	3.1
WWN1597TSLW Laminate/Wood	1397	15 3/16	96 1/16	1 1/16	—	—	76 lbs.	3.1
WWN1597TSL Laminate	1357	15 3/16	96 1/16	1 1/16	—	—	76 lbs.	3.1
WWN1584TSW Wood	\$ 1135	15 3/16	83 1/16	1 1/16	—	—	66 lbs.	2.7
WWN1584TSLW Laminate/Wood	1135	15 3/16	83 1/16	1 1/16	—	—	66 lbs.	2.7
WWN1584TSL Laminate	1103	15 3/16	83 1/16	1 1/16	—	—	66 lbs.	2.7
WWN1578TSW Wood	\$ 1087	15 3/16	77 1/16	1 1/16	—	—	62 lbs.	2.5
WWN1578TSLW Laminate/Wood	1087	15 3/16	77 1/16	1 1/16	—	—	62 lbs.	2.5
WWN1578TSL Laminate	1059	15 3/16	77 1/16	1 1/16	—	—	62 lbs.	2.5
WWN1572TSW Wood	\$ 1041	15 3/16	71 1/16	1 1/16	—	—	56 lbs.	2.3
WWN1572TSLW Laminate/Wood	1041	15 3/16	71 1/16	1 1/16	—	—	56 lbs.	2.3
WWN1572TSL Laminate	1012	15 3/16	71 1/16	1 1/16	—	—	56 lbs.	2.3
WWN1566TSW Wood	\$ 1003	15 3/16	65 1/16	1 1/16	—	—	52 lbs.	2.2
WWN1566TSLW Laminate/Wood	1003	15 3/16	65 1/16	1 1/16	—	—	52 lbs.	2.2
WWN1566TSL Laminate	978	15 3/16	65 1/16	1 1/16	—	—	52 lbs.	2.2
WWN1560TSW Wood	\$ 968	15 3/16	59 1/16	1 1/16	—	—	48 lbs.	2.0
WWN1560TSLW Laminate/Wood	968	15 3/16	59 1/16	1 1/16	—	—	48 lbs.	2.0
WWN1560TSL Laminate	937	15 3/16	59 1/16	1 1/16	—	—	48 lbs.	2.0
WWN1554TSW Wood	\$ 933	15 3/16	53 1/16	1 1/16	—	—	44 lbs.	1.8
WWN1554TSLW Laminate/Wood	933	15 3/16	53 1/16	1 1/16	—	—	44 lbs.	1.8
WWN1554TSL Laminate	905	15 3/16	53 1/16	1 1/16	—	—	44 lbs.	1.8

- Reference pages 401-402 for the multiple ways you can use Reception Counter Kits
- All hardware included to attach to reception units
- Reception Counter Kits can be used with Reception Mains, Reception Bridges and Reception Returns that do not have a Glass Reception Counters
- Reception Counter Kits can span the size of the unit or can extend beyond the unit and wrap around an entire L- or U-station to utilize counters on all sides



**PRODUCT SPECIFICATIONS**

- Counter kits shipped with appropriate hardware to attach to reception units
- Rim on all 4 sides of laminate and wood counter kits
- Refer to pages 401-402 for examples of how the counter kits can be used

**TO ORDER, SPECIFY:**

1. Model Number
2. Rim
3. PVC Rim Color (laminate models)
4. Laminate Top Color/Veneer Top Finish
5. Veneer Rim Finish (laminate/wood models)

**SAMPLE MODEL NUMBERS:**

WW15109TSW F MH  
 WW15109TSLW F 405 MH  
 WW15109TSL V405 MH

- See pages 356-361 for all options available in WaveWorks



Shaded model numbers are available on our "To You in 10 Days or Less" Quick Delivery program and will be delivered in 10 days or less.

**RECEPTION COUNTER KITS (CONTINUED)**



MODEL NO./DESCRIPTION	LIST PRICE	DIMENSIONS				KW	CARTONED WEIGHT	CUBIC FEET
		D	W	H	A			
<b>1 3/16" TOP THICKNESS</b>								
QWW15109TSW Wood	\$ 1531	15 3/16	108 1/16	1 3/16	—	—	86 lbs.	3.5
WW15109TSW Wood	1531	15 3/16	108 1/16	1 3/16	—	—	86 lbs.	3.5
WW15109TSLW Laminate/Wood	1531	15 3/16	108 1/16	1 3/16	—	—	86 lbs.	3.5
WW15109TSL Laminate	1486	15 3/16	108 1/16	1 3/16	—	—	86 lbs.	3.5
QWW15109TSLL TFL	1189	15 3/16	108 1/16	1 3/16	—	—	86 lbs.	3.5
WW15109TSLL TFL	1189	15 3/16	108 1/16	1 3/16	—	—	86 lbs.	3.5
<hr/>								
QWW1597TSW Wood	\$ 1212	15 3/16	96 1/16	1 3/16	—	—	76 lbs.	3.1
WW1597TSW Wood	1212	15 3/16	96 1/16	1 3/16	—	—	76 lbs.	3.1
WW1597TSLW Laminate/Wood	1212	15 3/16	96 1/16	1 3/16	—	—	76 lbs.	3.1
WW1597TSL Laminate	1179	15 3/16	96 1/16	1 3/16	—	—	76 lbs.	3.1
QWW1597TSLL TFL	944	15 3/16	96 1/16	1 3/16	—	—	76 lbs.	3.1
WW1597TSLL TFL	944	15 3/16	96 1/16	1 3/16	—	—	76 lbs.	3.1
<hr/>								
QWW1584TSW Wood	\$ 949	15 3/16	83 1/16	1 3/16	—	—	66 lbs.	2.7
WW1584TSW Wood	949	15 3/16	83 1/16	1 3/16	—	—	66 lbs.	2.7
WW1584TSLW Laminate/Wood	949	15 3/16	83 1/16	1 3/16	—	—	66 lbs.	2.7
WW1584TSL Laminate	925	15 3/16	83 1/16	1 3/16	—	—	66 lbs.	2.7
QWW1584TSLL TFL	740	15 3/16	83 1/16	1 3/16	—	—	66 lbs.	2.7
WW1584TSLL TFL	740	15 3/16	83 1/16	1 3/16	—	—	66 lbs.	2.7
<hr/>								
QWW1578TSW Wood	\$ 903	15 3/16	77 1/16	1 3/16	—	—	62 lbs.	2.5
WW1578TSW Wood	903	15 3/16	77 1/16	1 3/16	—	—	62 lbs.	2.5
WW1578TSLW Laminate/Wood	903	15 3/16	77 1/16	1 3/16	—	—	62 lbs.	2.5
WW1578TSL Laminate	878	15 3/16	77 1/16	1 3/16	—	—	62 lbs.	2.5
QWW1578TSLL TFL	702	15 3/16	77 1/16	1 3/16	—	—	62 lbs.	2.5
WW1578TSLL TFL	702	15 3/16	77 1/16	1 3/16	—	—	62 lbs.	2.5

- Reference pages 401-402 for the multiple ways you can use Reception Counter Kits
- All hardware included to attach to reception units
- Reception Counter Kits can be used with Reception Mains, Reception Bridges and Reception Returns that do not have a Glass Reception Counters
- Reception Counter Kits can span the size of the unit or can extend beyond the unit and wrap around an entire L- or U-station to utilize counters on all sides

WAVEWORKS

ASSEMBLED

# WAVEWORKS

## PRODUCT SPECIFICATIONS

- Counter kits shipped with appropriate hardware to attach to reception units
- Rim on all 4 sides of laminate and wood counter kits
- Refer to pages 401-402 for examples of how the counter kits can be used

## TO ORDER, SPECIFY:

1. Model Number
2. Rim
3. PVC Rim Color (laminate models)
4. Laminate Top Color/Veneer Top Finish
5. Veneer Rim Finish (laminate/wood models)

## SAMPLE MODEL NUMBERS:

WW1572TSW F MH  
 WW1572TSLW F 405 MH  
 WW1572TSL V405 MH

- See pages 356-361 for all options available in WaveWorks



Shaded model numbers are available on our "To You in 10 Days or Less" Quick Delivery program and will be delivered in 10 days or less.

## RECEPTION COUNTER KITS (CONTINUED)

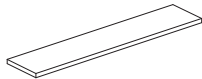

MODEL NO./DESCRIPTION	LIST PRICE	DIMENSIONS					CARTONED WEIGHT	CUBIC FEET
		D	W	H	A	KW		
<b>1 3/16" TOP THICKNESS (CONTINUED)</b>								
QWW1572TSW Wood	\$ 858	15 3/16	71 3/16	1 3/16	—	—	56 lbs.	2.3
WW1572TSW Wood	858	15 3/16	71 3/16	1 3/16	—	—	56 lbs.	2.3
WW1572TSLW Laminate/Wood	858	15 3/16	71 3/16	1 3/16	—	—	56 lbs.	2.3
WW1572TSL Laminate	832	15 3/16	71 3/16	1 3/16	—	—	56 lbs.	2.3
QWW1572TSLL TFL	667	15 3/16	71 3/16	1 1/2	—	—	56 lbs.	2.3
WW1572TSLL TFL	667	15 3/16	71 3/16	1 1/2	—	—	56 lbs.	2.3
<hr/>								
QWW1566TSW Wood	\$ 821	15 3/16	65 1/16	1 3/16	—	—	52 lbs.	2.2
WW1566TSW Wood	821	15 3/16	65 1/16	1 3/16	—	—	52 lbs.	2.2
WW1566TSLW Laminate/Wood	821	15 3/16	65 1/16	1 3/16	—	—	52 lbs.	2.2
WW1566TSL Laminate	798	15 3/16	65 1/16	1 3/16	—	—	52 lbs.	2.2
QWW1566TSLL TFL	660	15 3/16	65 1/16	1 1/2	—	—	52 lbs.	2.2
WW1566TSLL TFL	660	15 3/16	65 1/16	1 1/2	—	—	52 lbs.	2.2
<hr/>								
QWW1560TSW Wood	\$ 782	15 3/16	59 1/16	1 3/16	—	—	48 lbs.	2.0
WW1560TSW Wood	782	15 3/16	59 1/16	1 3/16	—	—	48 lbs.	2.0
WW1560TSLW Laminate/Wood	782	15 3/16	59 1/16	1 3/16	—	—	48 lbs.	2.0
WW1560TSL Laminate	761	15 3/16	59 1/16	1 3/16	—	—	48 lbs.	2.0
QWW1560TSLL TFL	609	15 3/16	59 1/16	1 1/2	—	—	48 lbs.	2.0
WW1560TSLL TFL	609	15 3/16	59 1/16	1 1/2	—	—	48 lbs.	2.0
<hr/>								
QWW1554TSW Wood	\$ 748	15 3/16	53 1/16	1 3/16	—	—	44 lbs.	1.8
WW1554TSW Wood	748	15 3/16	53 1/16	1 3/16	—	—	44 lbs.	1.8
WW1554TSLW Laminate/Wood	748	15 3/16	53 1/16	1 3/16	—	—	44 lbs.	1.8
WW1554TSL Laminate	727	15 3/16	53 1/16	1 3/16	—	—	44 lbs.	1.8
QWW1554TSLL TFL	582	15 3/16	53 1/16	1 1/2	—	—	44 lbs.	1.8
WW1554TSLL TFL	582	15 3/16	53 1/16	1 1/2	—	—	44 lbs.	1.8

- Reference pages 401-402 for the multiple ways you can use Reception Counter Kits
- All hardware included to attach to reception units
- Reception Counter Kits can be used with Reception Mains, Reception Bridges and Reception Returns that do not have a Glass Reception Counters
- Reception Counter Kits can span the size of the unit or can extend beyond the unit and wrap around an entire L- or U-station to utilize counters on all sides

WAVEWORKS

ASSEMBLED



# WAVEWORKS RECEPTION - THOUGHT STARTERS

- National's reception units are offered without the glass reception counters allowing the customer to keep the space open or add the laminate or wood Reception Counter Kits
- Shown below are thought starters or ideas for how the Reception Counter Kits can be used on 1 side only or used to wrap an entire unit
- Model numbers are shown as examples of sizes used and fit of counter
- Reception Counter Kits will have an overhang on the approach side

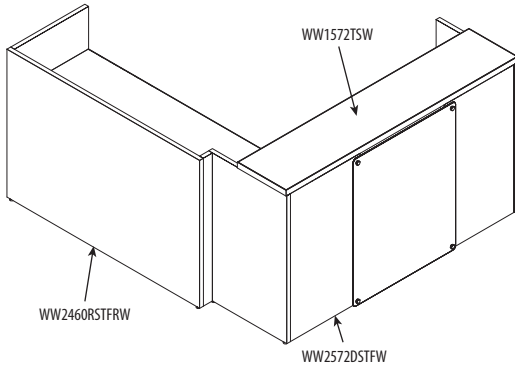

**Fig. A - Main Shell with Reception Return**  
(Counter on main shell)

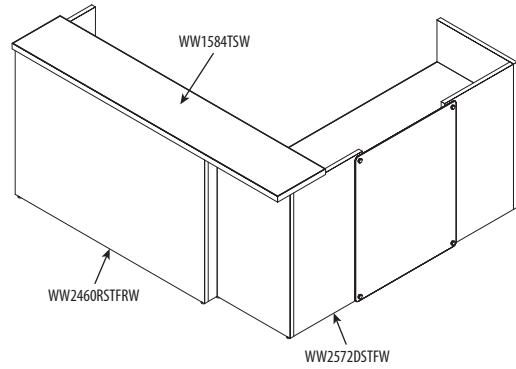

**Fig. B - Main Shell with Reception Return**  
(Counter on reception return spanning main shell)

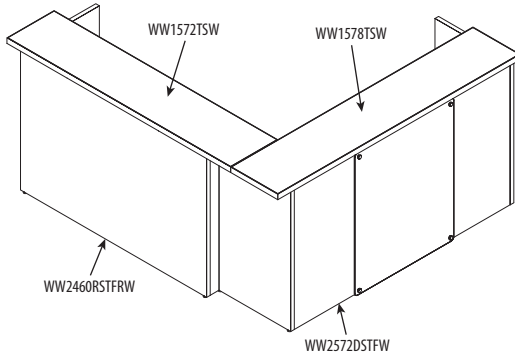

**Fig. C - Main Shell with Reception Return**  
(Counters across entire unit)

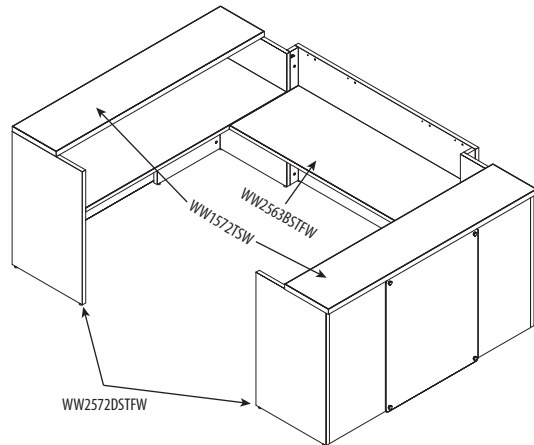

**Fig. D - 2 Main Shells with Reception Bridge**  
(Counters on main shell)

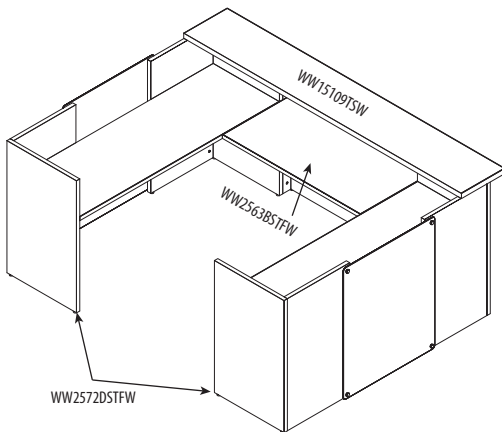

**Fig. E - 2 Main Shells with Reception Bridge**  
(Counter on reception bridge spanning main shells)

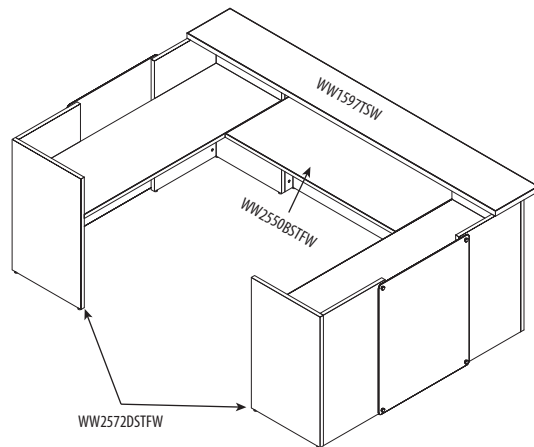
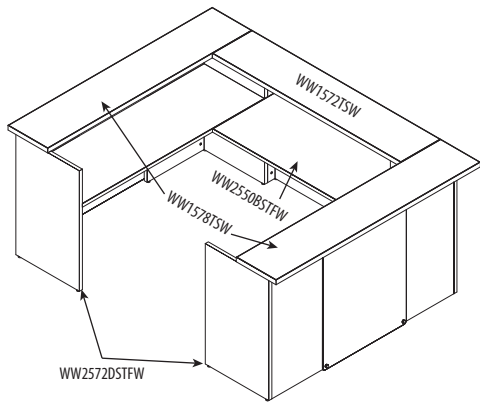

**Fig. F - 2 Main Shells with Reception Bridge**  
(Counter on reception bridge spanning main shells)

# THOUGHT STARTERS - WAVEWORKS RECEPTION

WAVEWORKS

ASSEMBLED



**Fig. G – 2 Main Shells with Reception Bridge**  
(Counters across entire unit)

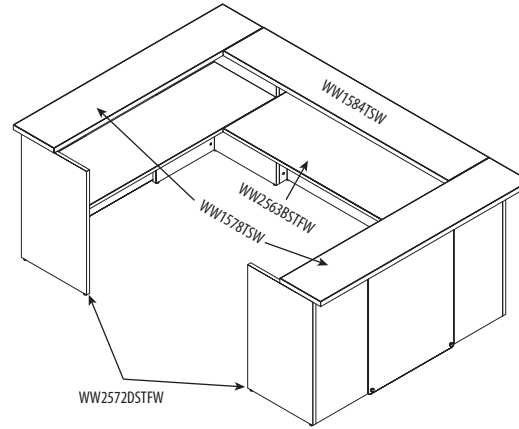

**Fig. H – 2 Main Shells with Reception Bridge**  
(Counters across entire unit)

	CONFIGURATION		
	RECEPTION COUNTER KIT(S) COVER MAIN AND/OR ADA SHELL ONLY (SEE FIG. A OR D)	RECEPTION COUNTER KIT COVERS BRIDGE OR RETURN ONLY (SEE FIG. B, E, OR F)	RECEPTION COUNTER KIT(S) COVER ENTIRE UNIT (SEE FIG. C, G, OR H)
<b>WAVEWORKS ADA COMPLIANT U-RECEPTION STATION</b>			
Main Shell	WW1572TS	–	WW1578TS
ADA Shell	WW1154TS	–	WW1154TS
– 63" Bridge	–	WW1566TS	WW1572TS
<b>WAVEWORKS U-RECEPTION STATION</b>			
Main Shell	WW1572TS	–	WW1578TS
ADA Shell	WW1154TS	–	WW1154TS
– 63" Bridge	–	WW1554TS	WW1560TS
<b>WAVEWORKS ADA COMPLIANT L-RECEPTION STATION</b>			
ADA Shell	WW1154TS	–	WW1154TS
– 60" Return	–	WW1566TS	WW1566TS
<b>WAVEWORKS RECEPTION U-UNIT</b>			
2 Main Shells	WW1572TS x 2	–	WW1578TS x 2
– 63" Bridge	–	WW15109TS	WW1584TS
<b>WAVEWORKS RECEPTION U-UNIT</b>			
2 Main Shells	WW1572TS x 2	–	WW1578TS x 2
– 63" Bridge	–	WW1597TS	WW1572TS
<b>WAVEWORKS RECEPTION L-UNIT</b>			
Main Shell	WW1572TS	–	WW1578TS
– 60" Return	–	WW1566TS	WW1572TS

# WAVEWORKS RECEPTION - THOUGHT STARTERS

## PRODUCT SPECIFICATIONS

- Wood and laminate tops and chassis available; refer to page 358 for options
- Refer to pages 741-784 for accessories
- Assembled units and component units are interchangeable
- If specifying wood, you must specify the same finish for all options
- Refer to page 361 for grommet options and upcharge

## TO ORDER, SPECIFY:

1. Model Number
2. Rim
3. PVC Rim Color (laminated models)
4. Pull
5. Grommet
6. Locking
7. Laminate Top Color (laminated/combo models)
8. Laminate Door/Drawer (laminated models)
9. Veneer Chassis Finish/Laminated Chassis Color

• See pages 356-361 for all options available in WaveWorks

## WAVEWORKS ADA COMPLIANT RECEPTION STATION



ITEM	PAGE	MODEL NO./DESCRIPTION	LIST	QTY	EXT. LIST
<b>WOOD CHASSIS/WORKSURFACE</b>					<b>\$ 14,039</b>
A.	393	WW2572DSTFW Reception Desk-Main Shell	\$ 6063	1	6,063
B.	395	WW2866BSTFW Reception Bridge-66"	1430	1	1,430
C.	394	WW2575DSTFRW Main Right-Shell-ADA	6546	1	6,546
<b>ADDITIONAL ADD-ONS:</b>					<b>\$ 3,447</b>
	484	WW2418CPTW Cornice Top for ADA Tower	\$ 782	1	782
	522	WW2318PUBBFW Undersurface Box/Box/File Pedestal	1807	1	1,807
	400	WW1572TSW Reception Counter Kit	858	1	858
<b>LAMINATE CHASSIS/WORKSURFACE:</b>					<b>\$ 11,183</b>
A.	393	WW2572DSTFL Reception Desk-Main Shell	\$ 4910	1	4,910
B.	395	WW2866BSTFL Reception Bridge-66"	986	1	986
C.	394	WW2575DSTFRL Main Right-Shell-ADA	5287	1	5,287
<b>ADDITIONAL ADD-ONS:</b>					<b>\$ 2,726</b>
	484	WW2418CPTL Cornice Top for ADA Tower	\$ 761	1	761
	522	WW2318PUBBFL Undersurface Box/Box/File Pedestal	1133	1	1,133
	400	WW1572TSL Reception Counter Kit	832	1	832
<b>WOOD CHASSIS/LAMINATE WORKSURFACE WITH WOOD RIM</b>					<b>\$ 14,039</b>
A.	393	WW2572DSTFLW Reception Desk-Main Shell	\$ 6063	1	6,063
B.	395	WW2866BSTFLW Reception Bridge-66"	1430	1	1,430
C.	394	WW2575DSTFRLW Main Right-Shell-ADA	6546	1	6,546
<b>ADDITIONAL ADD-ONS:</b>					<b>\$ 1,640</b>
	484	WW2418CPTLW Cornice Top for ADA Tower	\$ 782	1	782
	400	WW1572TSLW Reception Counter Kit	858	1	858

WAVEWORKS

ASSEMBLED

# THOUGHT STARTERS - WAVEWORKS RECEPTION

## PRODUCT SPECIFICATIONS

- Wood and laminate tops and chassis available; refer to page 358 for options
- Refer to pages 741-784 for accessories
- Assembled units and component units are interchangeable
- If specifying wood, you must specify the same finish for all options
- Refer to page 361 for grommet options and upcharge

## TO ORDER, SPECIFY:

1. Model Number
2. Rim
3. PVC Rim Color (laminate models)
4. Pull
5. Grommet
6. Locking
7. Laminate Top Color (laminate/combo models)
8. Laminate Door/Drawer (laminate models)
9. Veneer Chassis Finish/Laminate Chassis Color

• See pages 356-361 for all options available in WaveWorks

### WAVEWORKS RECEPTION U-UNIT

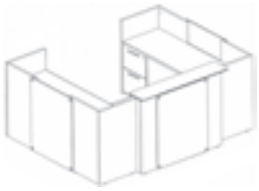

ITEM	PAGE	MODEL NO./DESCRIPTION	LIST	QTY	EXT. LIST
<b>WOOD CHASSIS/WORKSURFACE</b>					<b>\$ 13,601</b>
A.	393	WW2572DSTFW Reception Desk-Main Shell	\$ 6063	2	12,126
B.	395	WW2866BSTFW Reception Bridge-66"	1430	1	1,430
C.		Racetrack Grommet	45	1	45
<b>ADDITIONAL ADD-ONS:</b>					<b>\$ 3,614</b>
	522	WW2318PUBBFW Undersurface Box/Box/File Pedestal	\$ 1807	2	3,614
<b>LAMINATE CHASSIS/WORKSURFACE:</b>					<b>\$ 10,851</b>
A.	393	WW2572DSTFL Reception Desk-Main Shell	\$ 4910	2	9,820
B.	395	WW2866BSTFL Reception Bridge-66"	986	1	986
C.		Racetrack Grommet	45	1	45
<b>ADDITIONAL ADD-ONS:</b>					<b>\$ 2,266</b>
	522	WW2318PUBBFL Undersurface Box/Box/File Pedestal	\$ 1133	2	2,266
<b>WOOD CHASSIS/LAMINATE WORKSURFACE WITH WOOD RIM</b>					<b>\$ 13,601</b>
A.	393	WW2572DSTFLW Reception Desk-Main Shell	\$ 6063	2	12,126
B.	395	WW2866BSTFLW Reception Bridge-66"	1430	1	1,430
C.		Racetrack Grommet	45	1	45

WAVEWORKS

ASSEMBLED

# WAVEWORKS RECEPTIONS - THOUGHT STARTERS

## PRODUCT SPECIFICATIONS

- Wood and laminate tops and chassis available; refer to page 358 for options
- Refer to pages 741-784 for accessories
- Refer to page 363 for filing capabilities
- Assembled units and component units are interchangeable
- Refer to page 362 for grommet locations and page 361 for grommet options and upcharge
- If specifying wood, you must specify the same finish for all options

## TO ORDER, SPECIFY:

1. Model Number
  2. Rim
  3. PVC Rim Color (laminite models)
  4. Pull
  5. Grommet
  6. Locking
  7. Laminate Top Color (laminite/combo models)
  8. Laminate Door/Drawer (laminite models)
  9. Veneer Chassis Finish/Laminite Chassis Color
- See pages 356-361 for all options available in WaveWorks

### WAVEWORKS RECEPTION L-UNIT



ITEM	PAGE	MODEL NO./DESCRIPTION	LIST	QTY	EXT. LIST
<b>WOOD CHASSIS/WORKSURFACE</b>					<b>\$ 10,105</b>
A.	393	WW2572DSTFW Reception Desk-Main Shell	\$ 6063	1	6,063
B.	396	WW2860RSTFLW Reception Return-Left	2190	1	2,190
C.	523	WW2318PUFFW Undersurface File/File Pedestal	1807	1	1,807
D.		Racetrack Grommet Grommet	45	1	45
<b>ADDITIONAL ADD-ONS:</b>					<b>\$ 858</b>
	400	WW1572TSW Reception Counter Kit	\$ 858	1	858
<b>LAMINATE CHASSIS/WORKSURFACE:</b>					<b>\$ 8,132</b>
A.	393	WW2572DSTFL Reception Desk-Main Shell	\$ 4910	1	4,910
B.	396	WW2860RSTFLL Reception Return-Left	2044	1	2,044
C.	523	WW2318PUFFL Undersurface File/File Pedestal	1133	1	1,133
D.		Racetrack Grommet Grommet	45	1	45
<b>ADDITIONAL ADD-ONS:</b>					<b>\$ 832</b>
	400	WW1572TSL Reception Counter Kit	\$ 832	1	832
<b>WOOD CHASSIS/LAMINATE WORKSURFACE WITH WOOD RIM</b>					<b>\$ 8,298</b>
A.	393	WW2572DSTFLW Reception Desk-Main Shell	\$ 6063	1	6,063
B.	396	WW2860RSTFLLW Reception Return-Left	2190	1	2,190
C.		Racetrack Grommet Grommet	45	1	45
<b>ADDITIONAL ADD-ONS:</b>					<b>\$ 858</b>
	400	WW1572TSLW Reception Counter Kit	\$ 858	1	858

WAVEWORKS

ASSEMBLED

# WAVEWORKS

## PRODUCT SPECIFICATIONS

- Wood and laminate tops and chassis available; refer to page 358 for options
- Refer to pages 741-784 for accessories
- Refer to page 363 for filing capabilities
- Assembled units and component units are interchangeable
- Refer to page 362 for grommet locations and page 361 for grommet options and upcharge
- If specifying wood, you must specify the same finish for all options

## TO ORDER, SPECIFY:

1. Model Number
2. Rim
3. PVC Rim Color (laminated models)
4. Pull
5. Grommet
6. Locking
7. Laminate Top Color (laminated/combo models)
8. Laminate Door/Drawer Color (laminated models)
9. Veneer Chassis Finish/Laminate Chassis Color

## SAMPLE MODEL NUMBERS:

WW2442RREFW1 P 7SN G1C KRB AC  
 WW2442RREFL1 NAC2 7SN G1C KRB 405 AC2 AC2  
 WW2442RREFLW1 P 7SN G1C KRB 405 AC

- See pages 356-361 for all options available in WaveWorks

MODEL NO./DESCRIPTION	LIST PRICE	DIMENSIONS					CARTONED CUBIC			
		D	W	H	A	KW	WEIGHT	FEET		
<b>RETURN BOX/BOX/FILE</b>										
<b>1 1/2" TOP THICKNESS</b>										
<b>LEFT RETURN</b>			<b>RIGHT RETURN</b>							
WWN2460RLEFW1	WWN2460RREFW1	Wood	\$ 3315	24	60	29 3/8	1/16	44	180 lbs.	28.9
WWN2460RLEFLW1	WWN2460RREFLW1	Laminate/Wood	3315	24	60	29 3/8	1/16	44	180 lbs.	28.9
WWN2460RLEFL1	WWN2460RREFL1	Laminate	2078	24	60	29 3/8	1/16	44	180 lbs.	28.9
<b>1 1/2" TOP THICKNESS</b>										
<b>LEFT RETURN</b>			<b>RIGHT RETURN</b>							
WWN2448RLEFW1	WWN2448RREFW1	Wood	\$ 3191	24	48 1/16	29 3/8	1/16	33	160 lbs.	24.7
WWN2448RLEFLW1	WWN2448RREFLW1	Laminate/Wood	3191	24	48 1/16	29 3/8	1/16	33	160 lbs.	24.7
WWN2448RLEFL1	WWN2448RREFL1	Laminate	1945	24	48 1/16	29 3/8	1/16	33	160 lbs.	24.7
<b>1 1/2" TOP THICKNESS</b>										
<b>LEFT RETURN</b>			<b>RIGHT RETURN</b>							
WWN2442RLEFW1	WWN2442RREFW1	Wood	\$ 3067	24	42 1/16	29 3/8	1/16	27	140 lbs.	20.5
WWN2442RLEFLW1	WWN2442RREFLW1	Laminate/Wood	3067	24	42 1/16	29 3/8	1/16	27	140 lbs.	20.5
WWN2442RLEFL1	WWN2442RREFL1	Laminate	1867	24	42 1/16	29 3/8	1/16	27	140 lbs.	20.5
<b>1 1/2" TOP THICKNESS</b>										
<b>LEFT RETURN</b>			<b>RIGHT RETURN</b>							
WW2460RLEFW1	WW2460RREFW1	Wood	\$ 3013	24	60	28 1/16	1/16	44	186 lbs.	33.7
WW2460RLEFLW1	WW2460RREFLW1	Laminate/Wood	3013	24	60	28 1/16	1/16	44	186 lbs.	33.7
WW2460RLEFL1	WW2460RREFL1	Laminate	1890	24	60	28 1/16	1/16	44	186 lbs.	33.7
WW2460RLEFLL1	WW2460RREFLL1	TFL	1513	24	60	28 3/8	1/16	44	186 lbs.	33.7
<b>1 1/2" TOP THICKNESS</b>										
<b>LEFT RETURN</b>			<b>RIGHT RETURN</b>							
WW2448RLEFW1	WW2448RREFW1	Wood	\$ 2902	24	48 1/16	28 1/16	1/16	33	175 lbs.	27.6
WW2448RLEFLW1	WW2448RREFLW1	Laminate/Wood	2902	24	48 1/16	28 1/16	1/16	33	175 lbs.	27.6
WW2448RLEFL1	WW2448RREFL1	Laminate	1771	24	48 1/16	28 1/16	1/16	33	175 lbs.	27.6
WW2448RLEFLL1	WW2448RREFLL1	TFL	1416	24	48 1/16	28 3/8	1/16	33	175 lbs.	27.6
<b>1 1/2" TOP THICKNESS</b>										
<b>LEFT RETURN</b>			<b>RIGHT RETURN</b>							
WW2442RLEFW1	WW2442RREFW1	Wood	\$ 2790	24	42 1/16	28 1/16	1/16	27	166 lbs.	24.5
WW2442RLEFLW1	WW2442RREFLW1	Laminate/Wood	2790	24	42 1/16	28 1/16	1/16	27	166 lbs.	24.5
WW2442RLEFL1	WW2442RREFL1	Laminate	1696	24	42 1/16	28 1/16	1/16	27	166 lbs.	24.5
WW2442RLEFLL1	WW2442RREFLL1	TFL	1360	24	42 1/16	28 3/8	1/16	27	166 lbs.	24.5

- Grain direction runs front-to-back
- Random lock core (KRB, KRS) and specified lock core (KS1B, KS1S) available

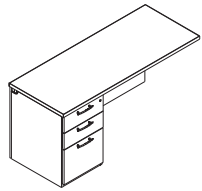

Left shown

**PRODUCT SPECIFICATIONS**

- Wood and laminate tops and chassis available; refer to page 358 for options
- Refer to pages 741-784 for accessories
- Refer to page 363 for filing capabilities
- Assembled units and component units are interchangeable
- Refer to page 362 for grommet locations and page 361 for grommet options and upcharge
- If specifying wood, you must specify the same finish for all options

**TO ORDER, SPECIFY:**

1. Model Number
2. Rim
3. PVC Rim Color (laminate models)
4. Pull
5. Grommet
6. Locking
7. Laminate Top Color (laminate/combo models)
8. Laminate Door/Drawer Color (laminate models)
9. Veneer Chassis Finish/ Laminate Chassis Color

**SAMPLE MODEL NUMBERS:**

WW2442RREFW2 P 7SN G1C KS1B AC  
 WW2442RREFL2 NAC2 7SN G1C KS1B 405 AC2 AC2  
 WW2442RREFLW2 P 7SN G1C KS1B 405 AC

• See pages 356-361 for all options available in WaveWorks

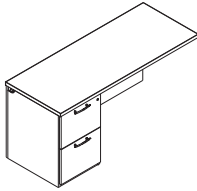
RETURN FILE/FILE	MODEL NO./DESCRIPTION	LIST PRICE	DIMENSIONS				KW	CARTONED WEIGHT	CUBIC FEET		
			D	W	H	A					
 <p>Left shown</p>	<b>1 1/8" TOP THICKNESS</b>										
		<b>LEFT RETURN</b>	<b>RIGHT RETURN</b>								
	WWN2460RLEFW2	WWN2460RREFW2	Wood	\$ 3315	24	60	29 3/8	1/16	44	180 lbs.	28.9
	WWN2460RLEFLW2	WWN2460RREFLW2	Laminate/Wood	3315	24	60	29 3/8	1/16	44	180 lbs.	28.9
	WWN2460RLEFL2	WWN2460RREFL2	Laminate	2078	24	60	29 3/8	1/16	44	180 lbs.	28.9
	WWN2448RLEFW2	WWN2448RREFW2	Wood	\$ 3191	24	48 1/16	29 3/8	1/16	33	160 lbs.	24.7
	WWN2448RLEFLW2	WWN2448RREFLW2	Laminate/Wood	3191	24	48 1/16	29 3/8	1/16	33	160 lbs.	24.7
	WWN2448RLEFL2	WWN2448RREFL2	Laminate	1945	24	48 1/16	29 3/8	1/16	33	160 lbs.	24.7
	WWN2442RLEFW2	WWN2442RREFW2	Wood	\$ 3067	24	42 1/16	29 3/8	1/16	27	140 lbs.	20.5
	WWN2442RLEFLW2	WWN2442RREFLW2	Laminate/Wood	3067	24	42 1/16	29 3/8	1/16	27	140 lbs.	20.5
	WWN2442RLEFL2	WWN2442RREFL2	Laminate	1867	24	42 1/16	29 3/8	1/16	27	140 lbs.	20.5
	<b>1 3/8" TOP THICKNESS</b>										
		<b>LEFT RETURN</b>	<b>RIGHT RETURN</b>								
	WW2460RLEFW2	WW2460RREFW2	Wood	\$ 3013	24	60	28 1/16	1/16	44	186 lbs.	33.7
	WW2460RLEFLW2	WW2460RREFLW2	Laminate/Wood	3013	24	60	28 1/16	1/16	44	186 lbs.	33.7
	WW2460RLEFL2	WW2460RREFL2	Laminate	1890	24	60	28 1/16	1/16	44	186 lbs.	33.7
	WW2460RLEFLL2	WW2460RREFLL2	TFL	1513	24	60	28 3/8	1/16	44	186 lbs.	33.7
	WW2448RLEFW2	WW2448RREFW2	Wood	\$ 2902	24	48 1/16	28 1/16	1/16	33	175 lbs.	27.6
WW2448RLEFLW2	WW2448RREFLW2	Laminate/Wood	2902	24	48 1/16	28 1/16	1/16	33	175 lbs.	27.6	
WW2448RLEFL2	WW2448RREFL2	Laminate	1771	24	48 1/16	28 1/16	1/16	33	175 lbs.	27.6	
WW2448RLEFLL2	WW2448RREFLL2	TFL	1416	24	48 1/16	28 3/8	1/16	33	175 lbs.	27.6	
WW2442RLEFW2	WW2442RREFW2	Wood	\$ 2790	24	42 1/16	28 1/16	1/16	27	166 lbs.	24.5	
WW2442RLEFLW2	WW2442RREFLW2	Laminate/Wood	2790	24	42 1/16	28 1/16	1/16	27	166 lbs.	24.5	
WW2442RLEFL2	WW2442RREFL2	Laminate	1696	24	42 1/16	28 1/16	1/16	27	166 lbs.	24.5	
WW2442RLEFLL2	WW2442RREFLL2	TFL	1360	24	42 1/16	28 3/8	1/16	27	166 lbs.	24.5	

- Grain direction runs front-to-back
- Random lock core (KRB, KRS) and specified lock core (KS1B, KS1S) available

WAVEWORKS

ASSEMBLED

# WAVEWORKS

## PRODUCT SPECIFICATIONS

- Wood and laminate tops and chassis available; refer to page 358 for options
- Refer to pages 741-784 for accessories
- Refer to page 363 for filling capabilities
- Refer to page 362 for grommet locations and page 361 for grommet options and upcharge
- If specifying wood, you must specify the same finish for all options

## TO ORDER, SPECIFY:

1. Model Number
2. Rim
3. PVC Rim Color (laminated models)
4. Grommet
5. Laminate Top Color (laminated/combo models)
6. Veneer Chassis Finish/  
Laminate Chassis Color

## SAMPLE MODEL NUMBERS:

WWN2442BEFW F X N MC  
 WWN2442BEFLW F X NM NM  
 WWN2442BEFL F G1C PB PB

- See pages 356-361 for all options available in WaveWorks

MODEL NO./DESCRIPTION	LIST PRICE	DIMENSIONS					CARTONED WEIGHT	CUBIC FEET
		D	W	H	A	KW		
<b>BRIDGE</b>								
<b>1 1/16" TOP THICKNESS</b>								
WWN2448BEFW Wood	\$ 1340	24	48 1/16	29 3/8	1/16	—	80 lbs.	4.1
WWN2448BEFLW Laminate/Wood	1340	24	48 1/16	29 3/8	1/16	—	80 lbs.	4.1
WWN2448BEFL Laminate	820	24	48 1/16	29 3/8	1/16	—	80 lbs.	4.1
<b>1 1/2" TOP THICKNESS</b>								
WWN2442BEFW Wood	\$ 1265	24	42 1/16	29 3/8	1/16	—	72 lbs.	3.7
WWN2442BEFLW Laminate/Wood	1265	24	42 1/16	29 3/8	1/16	—	72 lbs.	3.7
WWN2442BEFL Laminate	739	24	42 1/16	29 3/8	1/16	—	72 lbs.	3.7
<b>1 3/16" TOP THICKNESS</b>								
WW2448BEFW Wood	\$ 1220	24	48 1/16	28 13/16	1/16	—	80 lbs.	4.1
WW2448BEFLW Laminate/Wood	1220	24	48 1/16	28 13/16	1/16	—	80 lbs.	4.1
WW2448BEFL Laminate	741	24	48 1/16	28 13/16	1/16	—	80 lbs.	4.1
WW2448BEFL TFL	593	24	48 1/16	28 3/8	1/16	—	80 lbs.	4.1
<b>1 1/2" TOP THICKNESS</b>								
WW2442BEFW Wood	\$ 1148	24	42 1/16	28 13/16	1/16	—	72 lbs.	3.7
WW2442BEFLW Laminate/Wood	1148	24	42 1/16	28 13/16	1/16	—	72 lbs.	3.7
WW2442BEFL Laminate	669	24	42 1/16	28 13/16	1/16	—	72 lbs.	3.7
WW2442BEFL TFL	537	24	42 1/16	28 3/8	1/16	—	72 lbs.	3.7

- Some assembly required
- Grain direction runs front-to-back

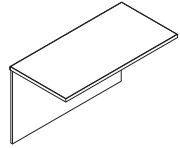

WAVEWORKS

ASSEMBLED



**PRODUCT SPECIFICATIONS**

- Wood and laminate tops and chassis available; refer to page 358 for options
- Refer to pages 741-784 for accessories
- Refer to page 363 for filing capabilities
- Refer to page 362 for grommet locations and page 361 for grommet options and upcharge
- If specifying wood, you must specify the same finish for all options

**TO ORDER, SPECIFY:**

1. Model Number
2. Rim
3. PVC Rim Color (laminated models)
4. Grommet
5. Laminate Top Color (laminated/combo models)
6. Veneer Chassis Finish/ Laminate Chassis Color

**SAMPLE MODEL NUMBERS:**

WWN2448BEFHW FX CW  
 WWN2448BEFHL FX 793 793  
 WWN2448BEFHLW FX PB PB

- See pages 356-361 for all options available in WaveWorks

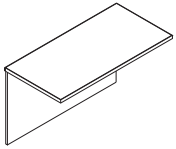
	MODEL NO./DESCRIPTION	LIST PRICE	DIMENSIONS				KW	CARTONED WEIGHT	CUBIC FEET	
			D	W	H	A				
	<b>1 1/16" TOP THICKNESS</b>									
	WWN2448BEFHW	Wood	\$ 1432	24	48 1/16	29 3/8	1/16	—	80 lbs.	4.1
	WWN2448BEFHLW	Laminate/Wood	1432	24	48 1/16	29 3/8	1/16	—	80 lbs.	4.1
	WWN2448BEFHL	Laminate	905	24	48 1/16	29 3/8	1/16	—	80 lbs.	4.1
	WWN2442BEFHW	Wood	\$ 1357	24	42 1/16	29 3/8	1/16	—	72 lbs.	3.7
	WWN2442BEFHLW	Laminate/Wood	1357	24	42 1/16	29 3/8	1/16	—	72 lbs.	3.7
	WWN2442BEFHL	Laminate	827	24	42 1/16	29 3/8	1/16	—	72 lbs.	3.7
	<b>1 3/16" TOP THICKNESS</b>									
	WW2448BEFHW	Wood	\$ 1312	24	48 1/16	28 1/16	1/16	—	80 lbs.	4.1
	WW2448BEFHLW	Laminate/Wood	1312	24	48 1/16	28 1/16	1/16	—	80 lbs.	4.1
	WW2448BEFHL	Laminate	829	24	48 1/16	28 1/16	1/16	—	80 lbs.	4.1
	WW2448BEFHLL	TFL	663	24	48 1/16	28 3/8	1/16	—	80 lbs.	4.1
WW2442BEFHW	Wood	\$ 1241	24	42 1/16	28 1/16	1/16	—	72 lbs.	3.7	
WW2442BEFHLW	Laminate/Wood	1241	24	42 1/16	28 1/16	1/16	—	72 lbs.	3.7	
WW2442BEFHL	Laminate	766	24	42 1/16	28 1/16	1/16	—	72 lbs.	3.7	
WW2442BEFHLL	TFL	611	24	42 1/16	28 3/8	1/16	—	72 lbs.	3.7	

- Some assembly required
- Unit has flexible grommet in modesty for cord management
- Modesty is hinged for access to cords
- Grain direction runs front-to-back

WAVEWORKS

ASSEMBLED

# WAVEWORKS

## PRODUCT SPECIFICATIONS

- Wood and laminate tops and chassis available; refer to page 358 for options
- Refer to pages 741-784 for accessories
- Refer to page 363 for filing capabilities
- Refer to page 362 for grommet locations and page 361 for grommet options and upcharge
- If specifying wood, you must specify the same finish for all options

## TO ORDER, SPECIFY:

1. Model Number
2. Rim
3. PVC Rim Color (laminate models)
4. Pull
5. Grommet
6. Locking
7. Laminate Top Color (laminate/combo models)
8. Laminate Door/Drawer Color (laminate models)
9. Veneer Chassis Finish/ Laminate Chassis Color

## SAMPLE MODEL NUMBERS:

WW2472CSFW P 7SN X KRB AC  
 WW2472CSFL NAC2 7SN X KRB 405 AC2 AC2  
 WW2472CSFLW P 7SN X KRB 405 AC

- See pages 356-361 for all options available in WaveWorks

## STORAGE CREDENZA

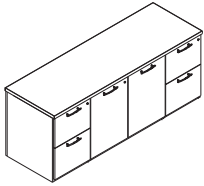

MODEL NO./DESCRIPTION	LIST PRICE	DIMENSIONS					CARTONED WEIGHT	CUBIC FEET
		D	W	H	A	KW		
<b>1 1/8" TOP THICKNESS</b>								
WWN2472CSFW Wood	\$ 5668	24	71 1/16	29 3/8	3/16	—	383 lbs.	36.3
WWN2472CSFLW Laminate/Wood	5668	24	71 1/16	29 3/8	3/16	—	383 lbs.	36.3
WWN2472CSFL Laminate	4517	24	71 1/16	29 3/8	3/16	—	383 lbs.	36.3
<b>1 1/2" TOP THICKNESS</b>								
WWN2466CSFW Wood	\$ 5324	24	66	29 3/8	3/16	—	355 lbs.	32.7
WWN2466CSFLW Laminate/Wood	5324	24	66	29 3/8	3/16	—	355 lbs.	32.7
WWN2466CSFL Laminate	4342	24	66	29 3/8	3/16	—	355 lbs.	32.7
<b>1 3/8" TOP THICKNESS</b>								
WW2472CSFW Wood	\$ 5158	24	71 1/16	28 1/16	3/16	—	346 lbs.	39.8
WW2472CSFLW Laminate/Wood	5158	24	71 1/16	28 1/16	3/16	—	346 lbs.	39.8
WW2472CSFL Laminate	4105	24	71 1/16	28 1/16	3/16	—	346 lbs.	39.8
WW2472CSFLL TFL	3286	24	71 1/16	28 3/8	3/16	—	346 lbs.	39.8
<b>1 1/2" TOP THICKNESS</b>								
WW2466CSFW Wood	\$ 4839	24	66	28 1/16	3/16	—	334 lbs.	32.7
WW2466CSFLW Laminate/Wood	4839	24	66	28 1/16	3/16	—	334 lbs.	32.7
WW2466CSFL Laminate	3947	24	66	28 1/16	3/16	—	334 lbs.	32.7
WW2466CSFLL TFL	3157	24	66	28 3/8	3/16	—	334 lbs.	32.7
<b>1 3/8" TOP THICKNESS</b>								
WW2460CSFW Wood	\$ 4706	24	60	28 1/16	3/16	—	318 lbs.	33.7
WW2460CSFLW Laminate/Wood	4706	24	60	28 1/16	3/16	—	318 lbs.	33.7
WW2460CSFL Laminate	3874	24	60	28 1/16	3/16	—	318 lbs.	33.7
WW2460CSFLL TFL	3101	24	60	28 3/8	3/16	—	318 lbs.	33.7

- 72" credenza features an adjustable shelf (20" deep x 34 3/16 wide)
- 66" credenza features an adjustable shelf (20" deep x 28 3/16 wide)
- 60" credenza features an adjustable shelf (20" deep x 22 3/16 wide)
- Random lock core (KRB, KRS) and specified lock core (KS3B, KS3S) available

**PRODUCT SPECIFICATIONS**

- Wood and laminate tops and chassis available; refer to page 358 for options
- Refer to pages 741-784 for accessories
- Refer to page 363 for filing capabilities
- Refer to page 362 for grommet locations and page 361 for grommet options and upcharge
- If specifying wood, you must specify the same finish for all options

**TO ORDER, SPECIFY:**

1. Model Number
2. Rim
3. PVC Rim Color (laminated models)
4. Pull
5. Grommet
6. Locking
7. Laminate Top Color (laminated/combo models)
8. Laminate Door/Drawer Color (laminated models)
9. Veneer Chassis Finish/Laminate Chassis Color

**SAMPLE MODEL NUMBERS:**

WWN2472CBVW P 7MB G1L KS2B AC  
 WWN2472CBVL VHN2 7MB X KS2B HN2 HN2  
 WWN2472CBVLW R 7MB X KS2B 405 AC

- See pages 356-361 for all options available in WaveWorks

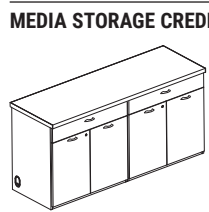
	MODEL NO./DESCRIPTION	LIST PRICE	DIMENSIONS					CARTONED WEIGHT	CUBIC FEET	
			D	W	H	A	KW			
	<b>72"–1 1/8" TOP THICKNESS</b>									
	WWN2472CVMSW	Wood	\$ 8253	24	72	35 1/16	–	–	383 lbs.	36.3
	WWN2472CVMSLW	Laminate/Wood	8253	24	72	35 1/16	–	–	383 lbs.	36.3
	WWN2472CVMSL	Laminate	7280	24	72	35 1/16	–	–	383 lbs.	36.3
	<b>60"–1 1/8" TOP THICKNESS</b>									
	WWN2460CVMSW	Wood	\$ 7995	24	60	35 1/16	–	–	325 lbs.	28.9
	WWN2460CVMSLW	Laminate/Wood	7995	24	60	35 1/16	–	–	325 lbs.	28.9
	WWN2460CVMSL	Laminate	7016	24	60	35 1/16	–	–	325 lbs.	28.9
	<b>48"–1 1/8" TOP THICKNESS</b>									
	WWN2448CVMSW	Wood	\$ 7731	24	48 1/16	35 1/16	–	–	290 lbs.	24.7
	WWN2448CVMSLW	Laminate/Wood	7731	24	48 1/16	35 1/16	–	–	290 lbs.	24.7
	WWN2448CVMSL	Laminate	6749	24	48 1/16	35 1/16	–	–	290 lbs.	24.7

- Infrared Repeater (IR) included with credenza which allows multi-media equipment to be stored and controlled behind solid doors
- Back panel is not fully finished and includes cutouts for venting
- Rim profile on front and sides only, 1 1/8" thick worksurface available
- Matching wood grommets in end panels for wire access
- Features an adjustable shelf
- Inside dimension of each storage section is 21 1/4" deep x 34 1/2" wide x 24 3/4" high for the WWN2472CVMS models, 21 1/4" deep x 28 1/2" wide x 24 3/4" high for the WWN2460CVMS models and 21 1/4" deep x 22 1/2" wide x 24 3/4" high for the WWN2448CVMS models
- Random lock core (KRB, KRS) and specified lock core (KS2B, KS2S) available

**ENTERTAINMENT CREDENZA**

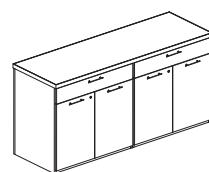

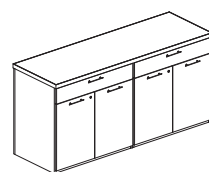
	MODEL NO./DESCRIPTION	LIST PRICE	DIMENSIONS					CARTONED WEIGHT	CUBIC FEET	
			D	W	H	A	KW			
	<b>1 1/8" TOP THICKNESS</b>									
	WWN2472CBVW	Wood	\$ 6509	24	71 1/16	35 1/16	–	–	381 lbs.	46.7
	WWN2472CBVLW	Laminate/Wood	6509	24	71 1/16	35 1/16	–	–	381 lbs.	46.7
	WWN2472CBVL	Laminate	5317	24	71 1/16	35 1/16	–	–	381 lbs.	46.7
	<b>1 1/8" TOP THICKNESS</b>									
	WW2472CBVW	Wood	\$ 5805	24	71 1/16	35 1/16	–	–	381 lbs.	46.7
WW2472CBVLW	Laminate/Wood	5805	24	71 1/16	35 1/16	–	–	381 lbs.	46.7	
WW2472CBVL	Laminate	4738	24	71 1/16	35 1/16	–	–	381 lbs.	46.7	
WW2472CBVLL	TFL	3789	24	71 1/16	35	–	–	381 lbs.	46.7	

- Back panel is not fully finished and includes cutouts for venting
- Rim profile on front and sides only
- Features an adjustable shelf
- Inside dimension of each storage section is 21 1/4" deep x 34 1/2" wide x 24 3/4" high
- Random lock core (KRB, KRS) and specified lock core (KS2B, KS2S) available

# WAVEWORKS

## PRODUCT SPECIFICATIONS

- Wood and laminate tops and chassis available; refer to page 358 for options
- Refer to pages 741-784 for accessories
- Refer to page 363 for filling capabilities
- Refer to page 362 for grommet locations and page 361 for grommet options and upcharge
- If specifying wood, you must specify the same finish for all options

## TO ORDER, SPECIFY:

1. Model Number
2. Rim
3. PVC Rim Color (laminated models)
4. Pull
5. Locking
6. Laminate Top Color (laminated/combo models)
7. Laminate Door/Drawer Color (laminated models)
8. Veneer Chassis Finish/ Laminate Chassis Color

## SAMPLE MODEL NUMBERS:

WW2472CBW P 7MB KS2B AC  
 WW2472CBL VHN2 7MB KS2B HN2 HN2 HN2  
 WW2472CBLW R 7MB KS2B 405 AC

- See pages 356-361 for all options available in WaveWorks

MODEL NO./DESCRIPTION	LIST PRICE	DIMENSIONS					CARTONED CUBIC	
		D	W	H	A	KW	WEIGHT	FEET
<b>1 1/8" TOP THICKNESS</b>								
WWN2472CBW Wood	\$ 6393	24	71 1/16	35 7/16	—	—	381 lbs.	46.7
WWN2472CBLW Laminate/Wood	6393	24	71 1/16	35 7/16	—	—	381 lbs.	46.7
WWN2472CBL Laminate	5222	24	71 1/16	35 7/16	—	—	381 lbs.	46.7
<b>1 3/8" TOP THICKNESS</b>								
WW2472CBW Wood	\$ 5701	24	71 1/16	35 7/16	—	—	381 lbs.	46.7
WW2472CBLW Laminate/Wood	5701	24	71 1/16	35 7/16	—	—	381 lbs.	46.7
WW2472CBL Laminate	4653	24	71 1/16	35 7/16	—	—	381 lbs.	46.7
WW2472CBL TFL	3721	24	71 1/16	35	—	—	381 lbs.	46.7

- Grommet option not available
- Features an adjustable shelf behind each set of doors
- Rim profile on front and sides only
- Features a fully finished back
- Inside dimension of each storage section is 21 1/4" deep x 34 1/2" wide x 24 3/4" high
- Random lock core (KRB, KRS) and specified lock core (KS2B, KS2S) available

## BUFFET CREDENZA WITH TRASH RECEPTACLE

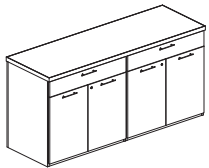

Left shown

1 1/8" TOP THICKNESS									
LEFT	RIGHT								
WWN2472CBTLW	WWN2472CBTRW	Wood	\$ 6465	24	71 1/16	35 7/16	—	—	lbs.
WWN2472CBTLLW	WWN2472CBTRLW	Laminate/Wood	6465	24	71 1/16	35 7/16	—	—	lbs.
WWN2472CBTLL	WWN2472CBTRL	Laminate	5257	24	71 1/16	35 7/16	—	—	lbs.
<b>1 3/8" TOP THICKNESS</b>									
LEFT	RIGHT								
WW2472CBTLW	WW2472CBTRW	Wood	\$ 5844	24	71 1/16	35 7/16	—	—	lbs.
WW2472CBTLLW	WW2472CBTRLW	Laminate/Wood	5844	24	71 1/16	35 7/16	—	—	lbs.
WW2472CBTLL	WW2472CBTRL	Laminate	4725	24	71 1/16	35 7/16	—	—	lbs.
WW2472CBTLLL	WW2472CBTRLL	TFL	3862	24	71 1/16	35 7/16	—	—	lbs.

- Specify a left model to have the trash receptacle on the far left side; right to have it on the right
- Includes 7 gallon trash receptacle

**PRODUCT SPECIFICATIONS**

- Wood and laminate tops and chassis available; refer to page 358 for options
- Refer to pages 741-784 for accessories
- Refer to page 363 for filing capabilities
- Refer to page 362 for grommet locations and page 361 for grommet options and upcharge
- If specifying wood, you must specify the same finish for all options

**TO ORDER, SPECIFY:**

1. Model Number
2. Rim
3. PVC Rim Color (laminate models)
4. Pull
5. Grommet
6. Locking
7. Laminate Top Color (laminate/combo models)
8. Laminate Door/Drawer Color (laminate models)
9. Veneer Chassis Finish/ Laminate Chassis Color

**SAMPLE MODEL NUMBERS:**

WWN2472CFFW P 7MB G1L KS2B AC  
 WWN2472CFFL VHN2 7MB X KS2B HN2 HN2 HN2  
 WWN2472CFFLW R 7MB X KS2B 405 AC

- See pages 356-361 for all options available in WaveWorks

MODEL NO./DESCRIPTION	LIST PRICE	DIMENSIONS				CARTONED WEIGHT	CUBIC FEET	
		D	W	H	A			KW
<b>1 1/8" TOP THICKNESS</b>								
<b>LEFT</b>								
WWN287241CBFLW	Wood	\$ 7901	28	71 1/16	41 1/16	—	—	lbs.
WWN287241CBFLW	Laminate/Wood	7901	28	71 1/16	41 1/16	—	—	lbs.
WWN287241CBFL	Laminate	6119	28	71 1/16	41 1/16	—	—	lbs.
<b>1 1/8" TOP THICKNESS</b>								
<b>RIGHT</b>								
WWN287236CBFLW	Wood	\$ 7470	28	71 1/16	35 1/16	—	—	lbs.
WWN287236CBFLW	Laminate/Wood	7470	28	71 1/16	35 1/16	—	—	lbs.
WWN287236CBFL	Laminate	5976	28	71 1/16	35 1/16	—	—	lbs.
<b>1 3/8" TOP THICKNESS</b>								
<b>LEFT</b>								
WW287241CBFLW	Wood	\$ 7281	28	71 1/16	41 3/8	—	—	lbs.
WW287241CBFLW	Laminate/Wood	7281	28	71 1/16	41 3/8	—	—	lbs.
WW287241CBFL	Laminate	5155	28	71 1/16	41 3/8	—	—	lbs.
WW287241CBFL	TFL	4222	28	71 1/16	41 3/8	—	—	lbs.
<b>1 3/8" TOP THICKNESS</b>								
<b>RIGHT</b>								
WW287236CBFLW	Wood	\$ 6850	28	71 1/16	35 3/8	—	—	lbs.
WW287236CBFLW	Laminate/Wood	6850	28	71 1/16	35 3/8	—	—	lbs.
WW287236CBFL	Laminate	5012	28	71 1/16	35 3/8	—	—	lbs.
WW287236CBFL	TFL	4079	28	71 1/16	35 3/8	—	—	lbs.

- Specify a left model to have the refrigerator on the far left side; right to have it on the right, 7 gallon trash receptacle in center section
- Back panel not fully finished and includes cutouts for venting in refrigerator section
- 36" H models only: Maximum refrigerator size 21 1/4" deep, 21 1/2" wide, x 27 1/16" high
- 41" H models only: Maximum refrigerator size 21 1/4" deep, 21 1/2" wide, x 32 1/16" high

**LATERAL FILE CREDENZA**

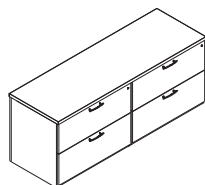

<b>1 1/8" TOP THICKNESS</b>									
WWN2472CFFW	Wood	\$ 6039	24	71 1/16	29 3/8	3/16	—	346 lbs.	36.3
WWN2472CFFLW	Laminate/Wood	6039	24	71 1/16	29 3/8	3/16	—	346 lbs.	36.3
WWN2472CFFL	Laminate	3944	24	71 1/16	29 3/8	3/16	—	346 lbs.	36.3
<b>1 3/8" TOP THICKNESS</b>									
WW2472CFFW	Wood	\$ 5490	24	71 1/16	28 1/16	3/16	—	346 lbs.	39.8
WW2472CFFLW	Laminate/Wood	5490	24	71 1/16	28 1/16	3/16	—	346 lbs.	39.8
WW2472CFFL	Laminate	3589	24	71 1/16	28 1/16	3/16	—	346 lbs.	39.8
WW2472CFFL	TFL	2869	24	71 1/16	28 1/8	3/16	—	346 lbs.	39.8

- Random lock core (KRB, KRS) and specified lock core (KS2B, KS2S) available
- When specifying Horizon pulls, lateral files will have 2 pulls on each drawer front
- End panel grommets come standard

# WAVEWORKS

## PRODUCT SPECIFICATIONS

- Wood and laminate tops and chassis available; refer to page 358 for options
- Refer to pages 741-784 for accessories
- Refer to page 363 for filing capabilities
- Assembled units and component units are interchangeable
- Refer to page 362 for grommet locations and page 361 for grommet options and upcharge
- If specifying wood, you must specify the same finish for all options

## TO ORDER, SPECIFY:

1. Model Number
2. Rim
3. PVC Rim Color (laminate models)
4. Pull
5. Grommet
6. Locking
7. Laminate Top Color (laminate/combo models)
8. Laminate Door/Drawer Color (laminate models)
9. Veneer Chassis Finish/Laminate Chassis Color

## SAMPLE MODEL NUMBERS:

WWN2472CKFW2 P 7MB G1L KRB AC  
 WWN2472CKFL2 VHN2 7MB X KRB HN2 HN2  
 WWN2472CKFLW2 R 7MB X KRB 405 AC

- See pages 356-361 for all options available in WaveWorks

MODEL NO./DESCRIPTION	LIST PRICE	DIMENSIONS					CARTONED WEIGHT	CUBIC FEET
		D	W	H	A	KW		
<b>KNEESPACE CREDENZA</b>								
<b>1<sup>1</sup>/<sub>16</sub>" TOP THICKNESS</b>								
WWN2472CKFW2 Wood	\$ 5044	24	71 <sup>1</sup> / <sub>16</sub>	29 <sup>3</sup> / <sub>8</sub>	<sup>3</sup> / <sub>16</sub>	35 <sup>5</sup> / <sub>8</sub>	273 lbs.	36.3
WWN2472CKFLW2 Laminate/Wood	5044	24	71 <sup>1</sup> / <sub>16</sub>	29 <sup>3</sup> / <sub>8</sub>	<sup>3</sup> / <sub>16</sub>	35 <sup>5</sup> / <sub>8</sub>	273 lbs.	36.3
WWN2472CKFL2 Laminate	3416	24	71 <sup>1</sup> / <sub>16</sub>	29 <sup>3</sup> / <sub>8</sub>	<sup>3</sup> / <sub>16</sub>	35 <sup>5</sup> / <sub>8</sub>	273 lbs.	36.3
<hr/>								
WWN2466CKFW2 Wood	\$ 4639	24	66	29 <sup>3</sup> / <sub>8</sub>	<sup>3</sup> / <sub>16</sub>	35 <sup>5</sup> / <sub>8</sub>	264 lbs.	32.7
WWN2466CKFLW2 Laminate/Wood	4639	24	66	29 <sup>3</sup> / <sub>8</sub>	<sup>3</sup> / <sub>16</sub>	35 <sup>5</sup> / <sub>8</sub>	264 lbs.	32.7
WWN2466CKFL2 Laminate	3263	24	66	29 <sup>3</sup> / <sub>8</sub>	<sup>3</sup> / <sub>16</sub>	35 <sup>5</sup> / <sub>8</sub>	264 lbs.	32.7
<hr/>								
WWN2460CKFW2 Wood	\$ 4495	24	60	29 <sup>3</sup> / <sub>8</sub>	<sup>3</sup> / <sub>16</sub>	29 <sup>1</sup> / <sub>16</sub>	250 lbs.	28.9
WWN2460CKFLW2 Laminate/Wood	4495	24	60	29 <sup>3</sup> / <sub>8</sub>	<sup>3</sup> / <sub>16</sub>	29 <sup>1</sup> / <sub>16</sub>	250 lbs.	28.9
WWN2460CKFL2 Laminate	3205	24	60	29 <sup>3</sup> / <sub>8</sub>	<sup>3</sup> / <sub>16</sub>	29 <sup>1</sup> / <sub>16</sub>	250 lbs.	28.9
<hr/>								
<b>1<sup>3</sup>/<sub>16</sub>" TOP THICKNESS</b>								
WW2472CKFW2 Wood	\$ 4588	24	71 <sup>1</sup> / <sub>16</sub>	28 <sup>1</sup> / <sub>16</sub>	<sup>3</sup> / <sub>16</sub>	35 <sup>5</sup> / <sub>8</sub>	279 lbs.	39.8
WW2472CKFLW2 Laminate/Wood	4588	24	71 <sup>1</sup> / <sub>16</sub>	28 <sup>1</sup> / <sub>16</sub>	<sup>3</sup> / <sub>16</sub>	35 <sup>5</sup> / <sub>8</sub>	279 lbs.	39.8
WW2472CKFL2 Laminate	3105	24	71 <sup>1</sup> / <sub>16</sub>	28 <sup>1</sup> / <sub>16</sub>	<sup>3</sup> / <sub>16</sub>	35 <sup>5</sup> / <sub>8</sub>	279 lbs.	39.8
WW2472CKFL2 TFL	2486	24	71 <sup>1</sup> / <sub>16</sub>	28 <sup>7</sup> / <sub>8</sub>	<sup>3</sup> / <sub>16</sub>	35 <sup>5</sup> / <sub>8</sub>	279 lbs.	39.8
<hr/>								
WW2466CKFW2 Wood	\$ 4217	24	66	28 <sup>1</sup> / <sub>16</sub>	<sup>3</sup> / <sub>16</sub>	35 <sup>5</sup> / <sub>8</sub>	267 lbs.	32.7
WW2466CKFLW2 Laminate/Wood	4217	24	66	28 <sup>1</sup> / <sub>16</sub>	<sup>3</sup> / <sub>16</sub>	35 <sup>5</sup> / <sub>8</sub>	267 lbs.	32.7
WW2466CKFL2 Laminate	2966	24	66	28 <sup>1</sup> / <sub>16</sub>	<sup>3</sup> / <sub>16</sub>	35 <sup>5</sup> / <sub>8</sub>	267 lbs.	32.7
WW2466CKFL2 TFL	2372	24	66	28 <sup>7</sup> / <sub>8</sub>	<sup>3</sup> / <sub>16</sub>	35 <sup>5</sup> / <sub>8</sub>	267 lbs.	32.7
<hr/>								
WW2460CKFW2 Wood	\$ 4084	24	60	28 <sup>1</sup> / <sub>16</sub>	<sup>3</sup> / <sub>16</sub>	29 <sup>1</sup> / <sub>16</sub>	256 lbs.	33.7
WW2460CKFLW2 Laminate/Wood	4084	24	60	28 <sup>1</sup> / <sub>16</sub>	<sup>3</sup> / <sub>16</sub>	29 <sup>1</sup> / <sub>16</sub>	256 lbs.	33.7
WW2460CKFL2 Laminate	2915	24	60	28 <sup>1</sup> / <sub>16</sub>	<sup>3</sup> / <sub>16</sub>	29 <sup>1</sup> / <sub>16</sub>	256 lbs.	33.7
WW2460CKFL2 TFL	2333	24	60	28 <sup>7</sup> / <sub>8</sub>	<sup>3</sup> / <sub>16</sub>	29 <sup>1</sup> / <sub>16</sub>	256 lbs.	33.7

- Random lock core (KRB, KRS) and specified lock core (KS2B, KS2S) available

WAVEWORKS

ASSEMBLED

**PRODUCT SPECIFICATIONS**

- Wood and laminate tops and chassis available; refer to page 358 for options
- Refer to pages 741-784 for accessories
- Refer to page 363 for filing capabilities
- Assembled units and component units are interchangeable
- Refer to page 362 for grommet locations and page 361 for grommet options and upcharge
- If specifying wood, you must specify the same finish for all options

**TO ORDER, SPECIFY:**

1. Model Number
2. Rim
3. PVC Rim Color (laminated models)
4. Pull
5. Grommet
6. Locking
7. Laminate Top Color (laminated/combo models)
8. Laminate Door/Drawer Color (laminated models)
9. Veneer Chassis Finish/ Laminate Chassis Color

**SAMPLE MODEL NUMBERS:**

WW2472CRFW2 P 7MB G1L KRB AC  
 WW2472CRFL2 VHN2 7MB X KRB HN2 HN2  
 WW2472CRFLW2 R 7MB X KRB 405 AC

- See pages 356-361 for all options available in WaveWorks

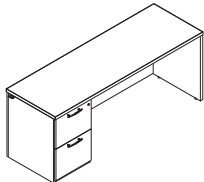
	MODEL NO./DESCRIPTION	LIST PRICE	DIMENSIONS				CARTONED WEIGHT	CUBIC FEET			
			D	W	H	A			KW		
<b>SINGLE PEDESTAL CREDENZA FILE/FILE</b> 	<b>1 1/4" TOP THICKNESS</b>										
		<b>LEFT PEDESTAL</b>	<b>RIGHT PEDESTAL</b>								
	WWN2472CLFW2	WWN2472CRFW2	Wood	\$ 3808	24	71 1/16	29 3/8	3/16	52 1/16	223 lbs.	36.3
	WWN2472CLFLW2	WWN2472CRFLW2	Laminate/Wood	3808	24	71 1/16	29 3/8	3/16	52 1/16	223 lbs.	36.3
	WWN2472CLFL2	WWN2472CRFL2	Laminate	2721	24	71 1/16	29 3/8	3/16	52 1/16	223 lbs.	36.3
	<hr/>										
	WWN2466CLFW2	WWN2466CRFW2	Wood	\$ 3744	24	66	29 3/8	3/16	52 1/16	214 lbs.	32.7
	WWN2466CLFLW2	WWN2466CRFLW2	Laminate/Wood	3744	24	66	29 3/8	3/16	52 1/16	214 lbs.	32.7
	WWN2466CLFL2	WWN2466CRFL2	Laminate	2600	24	66	29 3/8	3/16	52 1/16	214 lbs.	32.7
	<hr/>										
	WWN2460CLFW2	WWN2460CRFW2	Wood	\$ 3675	24	60	29 3/8	3/16	43 1/16	205 lbs.	28.9
	WWN2460CLFLW2	WWN2460CRFLW2	Laminate/Wood	3675	24	60	29 3/8	3/16	43 1/16	205 lbs.	28.9
WWN2460CLFL2	WWN2460CRFL2	Laminate	2553	24	60	29 3/8	3/16	43 1/16	205 lbs.	28.9	
<hr/>											
	<b>1 3/8" TOP THICKNESS</b>										
	<b>LEFT PEDESTAL</b>	<b>RIGHT PEDESTAL</b>									
WW2472CLFW2	WW2472CRFW2	Wood	\$ 3463	24	71 1/16	28 1/16	3/16	52 1/16	239 lbs.	39.8	
WW2472CLFLW2	WW2472CRFLW2	Laminate/Wood	3463	24	71 1/16	28 1/16	3/16	52 1/16	239 lbs.	39.8	
WW2472CLFL2	WW2472CRFL2	Laminate	2474	24	71 1/16	28 1/16	3/16	52 1/16	239 lbs.	39.8	
WW2472CLFLL2	WW2472CRFLL2	TFL	1980	24	71 1/16	28 3/8	3/16	52 1/16	239 lbs.	39.8	
<hr/>											
WW2466CLFW2	WW2466CRFW2	Wood	\$ 3407	24	66	28 1/16	3/16	52 1/16	227 lbs.	32.7	
WW2466CLFLW2	WW2466CRFLW2	Laminate/Wood	3407	24	66	28 1/16	3/16	52 1/16	227 lbs.	32.7	
WW2466CLFL2	WW2466CRFL2	Laminate	2367	24	66	28 1/16	3/16	52 1/16	227 lbs.	32.7	
WW2466CLFLL2	WW2466CRFLL2	TFL	1892	24	66	28 3/8	3/16	52 1/16	227 lbs.	32.7	
<hr/>											
WW2460CLFW2	WW2460CRFW2	Wood	\$ 3343	24	60	28 1/16	3/16	43 1/16	216 lbs.	33.7	
WW2460CLFLW2	WW2460CRFLW2	Laminate/Wood	3343	24	60	28 1/16	3/16	43 1/16	216 lbs.	33.7	
WW2460CLFL2	WW2460CRFL2	Laminate	2320	24	60	28 1/16	3/16	43 1/16	216 lbs.	33.7	
WW2460CLFLL2	WW2460CRFLL2	TFL	1858	24	60	28 3/8	3/16	43 1/16	216 lbs.	33.7	

- Random lock core (KRB, KRS) and specified lock core (KS1B, KS1S) available
- Grain direction runs with the width of all laminate modesty panels that exceed 60"

WAVEWORKS

ASSEMBLED

# WAVEWORKS

## PRODUCT SPECIFICATIONS

- Wood and laminate tops and chassis available; refer to page 358 for options
- Refer to pages 741-784 for accessories
- Refer to page 363 for filing capabilities
- Assembled units and component units are interchangeable
- Refer to page 362 for grommet locations and page 361 for grommet options and upcharge
- If specifying wood, you must specify the same finish for all options

## TO ORDER, SPECIFY:

1. Model Number
2. Rim
3. PVC Rim Color (laminate models)
4. Pull
5. Grommet
6. Locking
7. Laminate Top Color (laminate/combo models)
8. Laminate Door/Drawer Color (laminate models)
9. Veneer Chassis Finish/ Laminate Chassis Color

## SAMPLE MODEL NUMBERS:

WW2472CLFW12 F 7MB G1L KS2S AC  
 WW2472CLFL12 VHN2 7MB G1LX KS2S HN2 461 HN2  
 WW2472CLFLW12 F 7MB G1L KS2S 461 HN

- See pages 356-361 for all options available in WaveWorks

MODEL NO./DESCRIPTION	LIST PRICE	DIMENSIONS					CARTONED CUBIC	
		D	W	H	A	KW	WEIGHT	FEET
<b>SINGLE PEDESTAL CREDENZA LATERAL FILE</b>								
<b>1 1/8" TOP THICKNESS</b>		<b>LEFT PEDESTAL</b>		<b>RIGHT PEDESTAL</b>				
WWN2472CLFW6	4564	24	71 1/16	29 3/8	3/16	34 3/4	223 lbs.	36.3
WWN2472CLFLW6	4564	24	71 1/16	29 3/8	3/16	34 3/4	223 lbs.	36.3
WWN2472CLFL6	2974	24	71 1/16	29 3/8	3/16	34 3/4	223 lbs.	36.3
<b>1 1/8" TOP THICKNESS</b>		<b>LEFT PEDESTAL</b>		<b>RIGHT PEDESTAL</b>				
WW2472CLFW6	4149	24	71 1/16	28 1/16	3/16	34 3/4	279 lbs.	39.8
WW2472CLFLW6	4149	24	71 1/16	28 1/16	3/16	34 3/4	279 lbs.	39.8
WW2472CLFL6	2704	24	71 1/16	28 1/16	3/16	34 3/4	279 lbs.	39.8
WW2472CLFLL6	2164	24	71 1/16	28 3/8	3/16	34 3/4	279 lbs.	39.8
<ul style="list-style-type: none"> <li>• To prevent tipping, it is recommended that cabinets be ganged together or anchored to a suitable wall or floor</li> <li>• Random lock core (KRB, KRS) and specified lock core (KS1B, KS1S) available</li> <li>• When specifying Horizon pulls, lateral files will have 2 pulls on each drawer front</li> </ul>								
<b>SINGLE PEDESTAL CREDENZA BOX/BOX/FILE FILE/FILE</b>								
<b>1 1/8" TOP THICKNESS</b>		<b>LEFT PEDESTAL</b>		<b>RIGHT PEDESTAL</b>				
WWN2472CLFW12	4785	24	71 1/16	29 3/8	3/16	34 3/4	223 lbs.	36.3
WWN2472CLFLW12	4785	24	71 1/16	29 3/8	3/16	34 3/4	223 lbs.	36.3
WWN2472CLFL12	3416	24	71 1/16	29 3/8	3/16	34 3/4	223 lbs.	36.3
<b>1 1/8" TOP THICKNESS</b>		<b>LEFT PEDESTAL</b>		<b>RIGHT PEDESTAL</b>				
WW2472CLFW12	4349	24	71 1/16	28 1/16	3/16	34 3/4	279 lbs.	39.8
WW2472CLFLW12	4349	24	71 1/16	28 1/16	3/16	34 3/4	279 lbs.	39.8
WW2472CLFL12	3105	24	71 1/16	28 1/16	3/16	34 3/4	279 lbs.	39.8
WW2472CLFLL12	2486	24	71 1/16	28 3/8	3/16	34 3/4	279 lbs.	39.8
<ul style="list-style-type: none"> <li>• Random lock core (KRB, KRS) and specified lock core (KS2B, KS2S) available</li> </ul>								

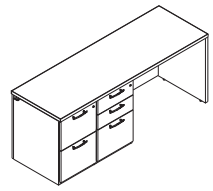
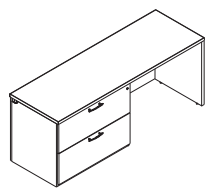

WAVEWORKS

ASSEMBLED



**PRODUCT SPECIFICATIONS**

- Wood and laminate chassis and doors available; refer to page 358 for options
- Tops of units are finished with flat edge detail
- Adjustable hinged doors
- If specifying wood, you must specify the same finish for all options
- Tack boards, task lights and vertical pigeon hole storage are available—see accessories section pages 741-784

**TO ORDER, SPECIFY:**

1. Model Number
2. Locking
3. Veneer Chassis Finish/  
Laminate Chassis Color

**SAMPLE MODEL NUMBERS:**

WW7238HBHW KRB HN  
WW7238HBHL KRB AC2 AC2

- See pages 356-361 for all options available in WaveWorks

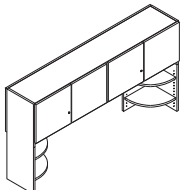
	MODEL NO./DESCRIPTION	LIST PRICE	DIMENSIONS					CARTONED WEIGHT	CUBIC FEET	
			D	W	H	A	KW			
<b>HIGHBACK ORGANIZER OPEN BACK</b>  	<b>38" HIGH—4 DOORS</b>									
	WW7238HBHW	Wood	\$ 3526	14 $\frac{3}{4}$	71 $\frac{1}{16}$	38	—	—	200 lbs.	16.2
	WW7238HBHL	Laminate	1728	14 $\frac{3}{4}$	71 $\frac{1}{16}$	38	—	—	200 lbs.	16.2
	WW6638HBHW	Wood	\$ 3336	14 $\frac{3}{4}$	65 $\frac{1}{16}$	38	—	—	180 lbs.	14.9
	WW6638HBHL	Laminate	1612	14 $\frac{3}{4}$	65 $\frac{1}{16}$	38	—	—	180 lbs.	14.9
	WW6038HBHW	Wood	\$ 3146	14 $\frac{3}{4}$	59 $\frac{1}{16}$	38	—	—	160 lbs.	13.6
	WW6038HBHL	Laminate	1493	14 $\frac{3}{4}$	59 $\frac{1}{16}$	38	—	—	160 lbs.	13.6
	<b>38" HIGH—3 DOORS</b>									
	WW4838HBHW	Wood	\$ 2902	14 $\frac{3}{4}$	47 $\frac{7}{8}$	38	—	—	145 lbs.	11.9
	WW4838HBHL	Laminate	1382	14 $\frac{3}{4}$	47 $\frac{7}{8}$	38	—	—	145 lbs.	11.9

- Units feature 4 adjustable curved shelves and partially open back
- All units have 4 doors except 48" unit which has 3 doors
- Highbacks must be placed on lower units with proper structure. The lower unit must consist of an end panel, support panel and/or undersurface pedestal on each side of the lower unit with a modesty panel spanning between
- For tack board options, see pages 776-783
- Random lock core (KRB, KRS) and specified lock core (KS2B, KS2S) available

**HIGHBACK ORGANIZER  
OPEN BACK - NO DOORS**

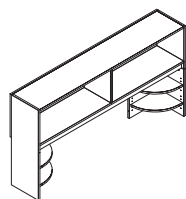

	MODEL NO./DESCRIPTION	LIST PRICE	DIMENSIONS					CARTONED WEIGHT	CUBIC FEET	
			D	W	H	A	KW			
<b>HIGHBACK ORGANIZER OPEN BACK - NO DOORS</b>	<b>38" HIGH—NO DOORS</b>									
	WW7238HBEW	Wood	\$ 3177	13 $\frac{3}{10}$	71 $\frac{1}{16}$	38	—	—	200 lbs.	16.2
	WW7238HBEL	Laminate	1376	13 $\frac{3}{10}$	71 $\frac{1}{16}$	38	—	—	200 lbs.	16.2
	WW6638HBEW	Wood	\$ 2985	13 $\frac{3}{10}$	65 $\frac{1}{16}$	38	—	—	180 lbs.	14.9
	WW6638HBEL	Laminate	1255	13 $\frac{3}{10}$	65 $\frac{1}{16}$	38	—	—	180 lbs.	14.9
	WW6038HBEW	Wood	\$ 2796	13 $\frac{3}{10}$	59 $\frac{1}{16}$	38	—	—	160 lbs.	13.6
	WW6038HBEL	Laminate	1140	13 $\frac{3}{10}$	59 $\frac{1}{16}$	38	—	—	160 lbs.	13.6
	WW4838HBEW	Wood	\$ 2690	13 $\frac{3}{10}$	47 $\frac{7}{8}$	38	—	—	145 lbs.	11.9
	WW4838HBEL	Laminate	1166	13 $\frac{3}{10}$	47 $\frac{7}{8}$	38	—	—	145 lbs.	11.9

- Units feature 4 adjustable curved shelves and partially open back
- Specify chassis finish only
- Highbacks must be placed on lower units with proper structure. The lower unit must consist of an end panel, support panel and/or undersurface pedestal on each side of the lower unit with a modesty panel spanning between
- For tack board options, see pages 776-783

# WAVEWORKS

## PRODUCT SPECIFICATIONS

- Wood and laminate chassis and doors available; refer to page 358 for options
- Tops of units are finished with flat edge detail
- Adjustable hinged doors
- If specifying wood, you must specify the same finish for all options
- Tack boards, task lights and vertical pigeon hole storage are available—see accessories section pages 741-784

## TO ORDER, SPECIFY:

1. Model Number
2. Locking
3. Door Frame Color (glass door models)
4. Veneer Chassis Finish/  
Laminate Chassis Color

## SAMPLE MODEL NUMBERS:

WW9050HBH2W KS3S NH  
WW9050HBH2L KS3S 440 AC2

- See pages 356-361 for all options available in WaveWorks

MODEL NO./DESCRIPTION	LIST PRICE	DIMENSIONS					CARTONED CUBIC	
		D	W	H	A	KW	WEIGHT	FEET
<b>HIGHBACK ORGANIZER FULL BACK</b>								
<b>50" HIGH—6 DOORS</b>								
WW10850HBH2GW Glass/Wood 2 Pieces	\$ 6383	14¾	107½	49½	—	—	378 lbs.	72.9
WW10850HBH2GL Glass/Laminate 2 Pieces	5893	14¾	107½	49½	—	—	378 lbs.	72.9
WW10850HBH2W Wood 2 Pieces	4784	14¾	107½	49½	—	—	378 lbs.	72.9
WW10850HBH2L Laminate 2 Pieces	2888	14¾	107½	49½	—	—	378 lbs.	72.9
<ul style="list-style-type: none"> <li>• Random lock core (KRB, KRS) and specified lock core (KS4B, KS4S) available</li> <li>• 49" task lights will not work under 2 piece highbacks</li> </ul>								
WW10250HBH2GW Glass/Wood 2 Pieces	\$ 6189	14¾	101¾	49½	—	—	362 lbs.	69.3
WW10250HBH2GL Glass/Laminate 2 Pieces	5718	14¾	101¾	49½	—	—	362 lbs.	69.3
WW10250HBH2W Wood 2 Pieces	4598	14¾	101¾	49½	—	—	362 lbs.	69.3
WW10250HBH2L Laminate 2 Pieces	2707	14¾	101¾	49½	—	—	362 lbs.	69.3
<ul style="list-style-type: none"> <li>• Random lock core (KRB, KRS) and specified lock core (KS4B, KS4S) available</li> <li>• 49" task lights will not work under 2 piece highbacks</li> </ul>								
WW9650HBH2GW Glass/Wood 2 Pieces	\$ 5991	14¾	95¾	49½	—	—	346 lbs.	61.9
WW9650HBH2GL Glass/Laminate 2 Pieces	5534	14¾	95¾	49½	—	—	346 lbs.	61.9
WW9650HBH2W Wood 2 Pieces	4417	14¾	95¾	49½	—	—	346 lbs.	61.9
WW9650HBH2L Laminate 2 Pieces	2527	14¾	95¾	49½	—	—	346 lbs.	61.9
<ul style="list-style-type: none"> <li>• Random lock core (KRB, KRS) and specified lock core (KS4B, KS4S) available</li> <li>• 49" task lights will not work under 2 piece highbacks</li> </ul>								
WW9050HBH2GW Glass/Wood	\$ 5793	14¾	89¾	49½	—	—	313 lbs.	58.3
WW9050HBH2GL Glass/Laminate	5347	14¾	89¾	49½	—	—	313 lbs.	58.3
WW9050HBH2W Wood	4370	14¾	89¾	49½	—	—	313 lbs.	58.3
WW9050HBH2L Laminate	2481	14¾	89¾	49½	—	—	313 lbs.	58.3
<ul style="list-style-type: none"> <li>• Random lock core (KRB, KRS) and specified lock core (KS3B, KS3S) available</li> </ul>								
<b>50" HIGH—4 DOORS</b>								
WW8450HBH2GW Glass/Wood	\$ 5592	14¾	83¾	49½	—	—	281 lbs.	54.6
WW8450HBH2GL Glass/Laminate	5168	14¾	83¾	49½	—	—	281 lbs.	54.6
WW8450HBH2W Wood	4323	14¾	83¾	49½	—	—	281 lbs.	54.6
WW8450HBH2L Laminate	2439	14¾	83¾	49½	—	—	281 lbs.	54.6
<ul style="list-style-type: none"> <li>• Random lock core (KRB, KRS) and specified lock core (KS2B, KS2S) available</li> <li>• Glass doors do not lock</li> <li>• Not intended for use on table desking</li> <li>• Highbacks must be placed on lower units with proper structure. The lower unit must consist of an end panel, support panel and/or undersurface pedestal on each side of the lower unit with a modesty panel spanning between</li> <li>• Features an adjustable shelf</li> <li>• For tack board options, see pages 776-783</li> </ul>								

WAVEWORKS

ASSEMBLED

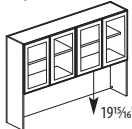
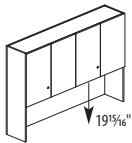
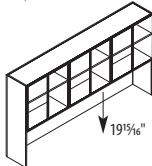
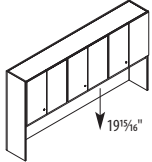
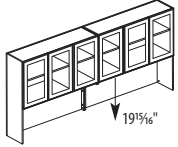
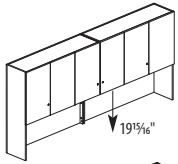

**PRODUCT SPECIFICATIONS**

- Wood and laminate chassis and doors available; refer to page 358 for options
- Tops of units are finished with flat edge detail
- Adjustable hinged doors
- If specifying wood, you must specify the same finish for all options
- Tack boards, task lights and vertical pigeon hole storage are available—see accessories section pages 741-784

**TO ORDER, SPECIFY:**

1. Model Number
2. Locking
3. Door Frame Color (glass door models)
4. Veneer Chassis Finish/  
Laminate Chassis Color

**SAMPLE MODEL NUMBERS:**

WW7250HBH2W KS2S NH  
WW7250HBH2L KS2S 440 AC2

- See pages 356-361 for all options available in WaveWorks

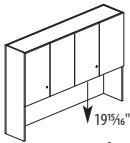
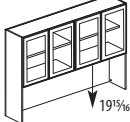
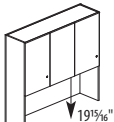
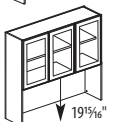
	MODEL NO./DESCRIPTION	LIST PRICE	DIMENSIONS					CARTONED CUBIC			
			D	W	H	A	KW	WEIGHT	FEET		
<b>HIGHBACK ORGANIZER FULL BACK</b>	<b>50" HIGH—4 DOORS</b>										
		WW7850HBH2GW	Glass/Wood	\$ 5391	14¾	77¼	49¼	—	—	261 lbs.	51.0
		WW7850HBH2GL	Glass/Laminate	4982	14¾	77¼	49¼	—	—	261 lbs.	51.0
		WW7850HBH2W	Wood	4232	14¾	77¼	49¼	—	—	261 lbs.	51.0
		WW7850HBH2L	Laminate	2347	14¾	77¼	49¼	—	—	261 lbs.	51.0
		WW7250HBH2GW	Glass/Wood	\$ 5192	14¾	71¼	49¼	—	—	242 lbs.	47.4
		WW7250HBH2GL	Glass/Laminate	4798	14¾	71¼	49¼	—	—	242 lbs.	47.4
		WW7250HBH2W	Wood	4047	14¾	71¼	49¼	—	—	242 lbs.	47.4
		WW7250HBH2L	Laminate	2168	14¾	71¼	49¼	—	—	242 lbs.	47.4
		WW6650HBH2GW	Glass/Wood	\$ 5013	14¾	65¼	49¼	—	—	223 lbs.	43.7
		WW6650HBH2GL	Glass/Laminate	4628	14¾	65¼	49¼	—	—	223 lbs.	43.7
		WW6650HBH2W	Wood	3859	14¾	65¼	49¼	—	—	223 lbs.	43.7
	WW6650HBH2L	Laminate	1990	14¾	65¼	49¼	—	—	223 lbs.	43.7	
	WW6050HBH2GW	Glass/Wood	\$ 4814	14¾	59¼	49¼	—	—	203 lbs.	40.1	
	WW6050HBH2GL	Glass/Laminate	4447	14¾	59¼	49¼	—	—	203 lbs.	40.1	
	WW6050HBH2W	Wood	3680	14¾	59¼	49¼	—	—	203 lbs.	40.1	
	WW6050HBH2L	Laminate	1812	14¾	59¼	49¼	—	—	203 lbs.	40.1	
	<b>50" HIGH—3 DOORS</b>										
	WW4850HBH2GW	Glass/Wood	\$ 4479	14¾	47¾	49¼	—	—	173 lbs.	32.8	
	WW4850HBH2GL	Glass/Laminate	3702	14¾	47¾	49¼	—	—	173 lbs.	32.8	
	WW4850HBH2W	Wood	3629	14¾	47¾	49¼	—	—	173 lbs.	32.8	
	WW4850HBH2L	Laminate	1728	14¾	47¾	49¼	—	—	173 lbs.	32.8	
	<ul style="list-style-type: none"> <li>• Not intended for use on table desking</li> <li>• Highbacks must be placed on lower units with proper structure. The lower unit must consist of an end panel, support panel and/or undersurface pedestal on each side of the lower unit with a modesty panel spanning between</li> <li>• Features an adjustable shelf</li> <li>• For tack board options, see pages 776-783</li> <li>• Glass doors do not lock</li> <li>• Random lock core (KRB, KRS) and specified lock core (KS2B, KS2S) available</li> </ul>										

WAVEWORKS

ASSEMBLED

# WAVEWORKS

## PRODUCT SPECIFICATIONS

- Wood and laminate chassis and doors available; refer to page 358 for options
- Tops of units are finished with flat edge detail
- Adjustable hinged doors
- If specifying wood, you must specify the same finish for all options
- Tack boards, task lights and vertical pigeon hole storage are available—see accessories section pages 741-784

## TO ORDER, SPECIFY:

1. Model Number
2. Locking
3. Door Frame Color (glass door models)
4. Veneer Chassis Finish/  
Laminate Chassis Color

## SAMPLE MODEL NUMBERS:

WW9038HBH2W KS3S NH  
 WW9038HBH2L KS3S 440 AC2  
 WW9038HBH2GW 503 HN

- See pages 356-361 for all options available in WaveWorks

### HIGHBACK ORGANIZER FULL BACK

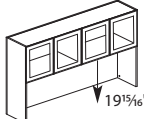
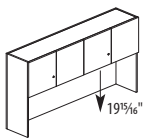
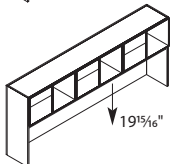
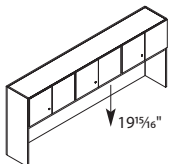
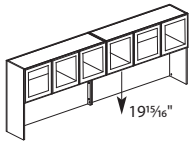
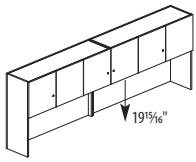

#### MODEL NO./DESCRIPTION

#### 38" HIGH—6 DOORS

MODEL NO./DESCRIPTION	LIST PRICE	D	W	H	A	KW	CARTONED WEIGHT	CUBIC FEET
WW10838HBH2GW Glass/Wood 2 Pieces	\$ 5554	14 3/4	107 1/16	38 3/8	—	—	282 lbs.	56.9
WW10838HBH2GL Glass/Laminate 2 Pieces	5126	14 3/4	107 1/16	38 3/8	—	—	282 lbs.	56.9
WW10838HBH2W Wood 2 Pieces	4711	14 3/4	107 1/16	38 3/8	—	—	282 lbs.	56.9
WW10838HBH2L Laminate 2 Pieces	2523	14 3/4	107 1/16	38 3/8	—	—	282 lbs.	56.9

- Random lock core (KRB, KRS) and specified lock core (KS4B, KS4S) available
- 49" task lights will not work under 2 piece highbacks

WW10238HBH2GW Glass/Wood 2 Pieces	\$ 5360	14 3/4	101 3/4	38 3/8	—	—	266 lbs.	54.1
WW10238HBH2GL Glass/Laminate 2 Pieces	4950	14 3/4	101 3/4	38 3/8	—	—	266 lbs.	54.1
WW10238HBH2W Wood 2 Pieces	4514	14 3/4	101 3/4	38 3/8	—	—	266 lbs.	54.1
WW10238HBH2L Laminate 2 Pieces	2346	14 3/4	101 3/4	38 3/8	—	—	266 lbs.	54.1

- Random lock core (KRB, KRS) and specified lock core (KS4B, KS4S) available
- 49" task lights will not work under 2 piece highbacks

WW9638HBH2GW Glass/Wood 2 Pieces	\$ 5171	14 3/4	95 3/4	38 3/8	—	—	252 lbs.	48.3
WW9638HBH2GL Glass/Laminate 2 Pieces	4775	14 3/4	95 3/4	38 3/8	—	—	252 lbs.	48.3
WW9638HBH2W Wood 2 Pieces	4311	14 3/4	95 3/4	38 3/8	—	—	252 lbs.	48.3
WW9638HBH2L Laminate 2 Pieces	2167	14 3/4	95 3/4	38 3/8	—	—	252 lbs.	48.3

- Random lock core (KRB, KRS) and specified lock core (KS4B, KS4S) available
- 49" task lights will not work under 2 piece highbacks

WW9038HBH2GW Glass/Wood	\$ 4964	14 3/4	89 3/4	38 3/8	—	—	233 lbs.	45.5
WW9038HBH2GL Glass/Laminate	4585	14 3/4	89 3/4	38 3/8	—	—	233 lbs.	45.5
WW9038HBH2W Wood	4114	14 3/4	89 3/4	38 3/8	—	—	233 lbs.	45.5
WW9038HBH2L Laminate	1989	14 3/4	89 3/4	38 3/8	—	—	233 lbs.	45.5

- Random lock core (KRB, KRS) and specified lock core (KS3B, KS3S) available

#### 38" HIGH—4 DOORS

WW8438HBH2GW Glass/Wood	\$ 4764	14 3/4	83 3/4	38 3/8	—	—	210 lbs.	42.6
WW8438HBH2GL Glass/Laminate	4401	14 3/4	83 3/4	38 3/8	—	—	210 lbs.	42.6
WW8438HBH2W Wood	3913	14 3/4	83 3/4	38 3/8	—	—	210 lbs.	42.6
WW8438HBH2L Laminate	1928	14 3/4	83 3/4	38 3/8	—	—	210 lbs.	42.6

- Random lock core (KRB, KRS) and specified lock core (KS2B, KS2S) available

- Glass doors do not lock
- Not intended for use on table desking
- Highbacks must be placed on lower units with proper structure. The lower unit must consist of an end panel, support panel and/or undersurface pedestal on each side of the lower unit with a modesty panel spanning between
- For tack board options, see pages 776-783

**PRODUCT SPECIFICATIONS**

- Wood and laminate chassis and doors available; refer to page 358 for options
- Tops of units are finished with flat edge detail
- Adjustable hinged doors
- If specifying wood, you must specify the same finish for all options
- Tack boards, task lights and vertical pigeon hole storage are available—see accessories section pages 741-784

**TO ORDER, SPECIFY:**

1. Model Number
2. Locking
3. Door Frame Color (glass door models)
4. Veneer Chassis Finish/  
Laminate Chassis Color

**SAMPLE MODEL NUMBERS:**

WW7838HBH2W KS2S NH  
 WW7838HBH2L KS2S 440 AC2  
 WW7838HBH2GW 503 HN

- See pages 356-361 for all options available in WaveWorks



Shaded model numbers are available on our "To You in 10 Days or Less" Quick Delivery program and will be delivered in 10 days or less.

**HIGHBACK ORGANIZER  
FULL BACK**

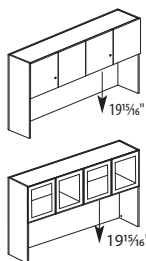

MODEL NO./DESCRIPTION	LIST PRICE	DIMENSIONS					CARTONED WEIGHT	CUBIC FEET
		D	W	H	A	KW		
<b>38" HIGH—4 DOORS</b>								
WW7838HBH2GW Glass/Wood	\$ 4564	14 3/4	77 1/16	38 3/8	—	—	194 lbs.	39.8
WW7838HBH2GL Glass/Laminate	4214	14 3/4	77 1/16	38 3/8	—	—	194 lbs.	39.8
WW7838HBH2W Wood	3721	14 3/4	77 1/16	38 3/8	—	—	194 lbs.	39.8
WW7838HBH2L Laminate	1841	14 3/4	77 1/16	38 3/8	—	—	194 lbs.	39.8
<b>38" HIGH—3 DOORS</b>								
WW7238HBH2GW Glass/Wood	\$ 4366	14 3/4	71 1/16	38 3/8	—	—	179 lbs.	37.0
WW7238HBH2GL Glass/Laminate	4033	14 3/4	71 1/16	38 3/8	—	—	179 lbs.	37.0
QWW7238HBH2W Wood	3526	14 3/4	71 1/16	38 3/8	—	—	179 lbs.	37.0
WW7238HBH2W Wood	3526	14 3/4	71 1/16	38 3/8	—	—	179 lbs.	37.0
QWW7238HBH2L Laminate	1728	14 3/4	71 1/16	38 3/8	—	—	179 lbs.	37.0
WW7238HBH2L Laminate	1728	14 3/4	71 1/16	38 3/8	—	—	179 lbs.	37.0
<b>38" HIGH—3 DOORS</b>								
WW6638HBH2GW Glass/Wood	\$ 4175	14 3/4	65 1/16	38 3/8	—	—	164 lbs.	34.1
WW6638HBH2GL Glass/Laminate	3853	14 3/4	65 1/16	38 3/8	—	—	164 lbs.	34.1
WW6638HBH2W Wood	3336	14 3/4	65 1/16	38 3/8	—	—	164 lbs.	34.1
WW6638HBH2L Laminate	1612	14 3/4	65 1/16	38 3/8	—	—	164 lbs.	34.1
<b>38" HIGH—3 DOORS</b>								
WW6038HBH2GW Glass/Wood	\$ 3983	14 3/4	59 1/16	38 3/8	—	—	148 lbs.	31.3
WW6038HBH2GL Glass/Laminate	3676	14 3/4	59 1/16	38 3/8	—	—	148 lbs.	31.3
WW6038HBH2W Wood	3146	14 3/4	59 1/16	38 3/8	—	—	148 lbs.	31.3
WW6038HBH2L Laminate	1493	14 3/4	59 1/16	38 3/8	—	—	148 lbs.	31.3
<b>38" HIGH—3 DOORS</b>								
WW4838HBH2GW Glass/Wood	\$ 3815	14 3/4	47 7/8	38 3/8	—	—	126 lbs.	25.6
WW4838HBH2GL Glass/Laminate	3524	14 3/4	47 7/8	38 3/8	—	—	126 lbs.	25.6
WW4838HBH2W Wood	2902	14 3/4	47 7/8	38 3/8	—	—	126 lbs.	25.6
WW4838HBH2L Laminate	1382	14 3/4	47 7/8	38 3/8	—	—	126 lbs.	25.6

- Not intended for use on table desking
- Highbacks must be placed on lower units with proper structure. The lower unit must consist of an end panel, support panel and/or undersurface pedestal on each side of the lower unit with a modesty panel spanning between
- For tack board options, see pages 776-783
- Glass doors do not lock
- Random lock core (KRB, KRS) and specified lock core (KS2B, KS2S) available

WAVEWORKS ASSEMBLED

# WAVEWORKS

## PRODUCT SPECIFICATIONS

- Wood or laminate chassis available, refer to page 358 for options
- If specifying wood, you must specify the same finish for all options
- Tops of units are finished with flat edge detail
- Tack boards, task lights and vertical pigeon hole storage are available—see accessories section pages 741-784

## TO ORDER, SPECIFY:

1. Model Number
2. Veneer Chassis Finish/  
Laminate Chassis Color

## SAMPLE MODEL NUMBERS:

WW10838HBE2W AC  
WW10838HBE2L 440

- See pages 356-361 for all options available in WaveWorks

MODEL NO./DESCRIPTION	LIST PRICE	DIMENSIONS					CARTONED WEIGHT	CUBIC FEET
		D	W	H	A	KW		
<b>HIGHBACK ORGANIZER FULL BACK - NO DOORS</b>								
<b>38" HIGH—NO DOORS</b>								
WW10838HBE2W Wood	\$ 4178	13 <sup>1</sup> / <sub>10</sub>	107 <sup>1</sup> / <sub>16</sub>	38 <sup>3</sup> / <sub>8</sub>	—	—	282 lbs.	56.9
WW10838HBE2L Laminate	1989	13 <sup>1</sup> / <sub>10</sub>	107 <sup>1</sup> / <sub>16</sub>	38 <sup>3</sup> / <sub>8</sub>	—	—	282 lbs.	56.9
• 49" task lights will not work under 2 piece highbacks								
WW10238HBE2W Wood	\$ 3982	13 <sup>1</sup> / <sub>10</sub>	101 <sup>3</sup> / <sub>4</sub>	38 <sup>3</sup> / <sub>8</sub>	—	—	266 lbs.	54.1
WW10238HBE2L Laminate	1812	13 <sup>1</sup> / <sub>10</sub>	101 <sup>3</sup> / <sub>4</sub>	38 <sup>3</sup> / <sub>8</sub>	—	—	266 lbs.	54.1
• 49" task lights will not work under 2 piece highbacks								
WW9638HBE2W Wood	\$ 3780	13 <sup>1</sup> / <sub>10</sub>	95 <sup>3</sup> / <sub>4</sub>	38 <sup>3</sup> / <sub>8</sub>	—	—	252 lbs.	48.3
WW9638HBE2L Laminate	1628	13 <sup>1</sup> / <sub>10</sub>	95 <sup>3</sup> / <sub>4</sub>	38 <sup>3</sup> / <sub>8</sub>	—	—	252 lbs.	48.3
• 49" task lights will not work under 2 piece highbacks								
WW9038HBE2W Wood	\$ 3583	13 <sup>1</sup> / <sub>10</sub>	89 <sup>3</sup> / <sub>4</sub>	38 <sup>3</sup> / <sub>8</sub>	—	—	233 lbs.	45.5
WW9038HBE2L Laminate	1452	13 <sup>1</sup> / <sub>10</sub>	89 <sup>3</sup> / <sub>4</sub>	38 <sup>3</sup> / <sub>8</sub>	—	—	233 lbs.	45.5
WW8438HBE2W Wood	\$ 3564	13 <sup>1</sup> / <sub>10</sub>	83 <sup>3</sup> / <sub>4</sub>	38 <sup>3</sup> / <sub>8</sub>	—	—	210 lbs.	42.6
WW8438HBE2L Laminate	1572	13 <sup>1</sup> / <sub>10</sub>	83 <sup>3</sup> / <sub>4</sub>	38 <sup>3</sup> / <sub>8</sub>	—	—	210 lbs.	42.6
WW7838HBE2W Wood	\$ 3370	13 <sup>1</sup> / <sub>10</sub>	77 <sup>1</sup> / <sub>16</sub>	38 <sup>3</sup> / <sub>8</sub>	—	—	194 lbs.	39.8
WW7838HBE2L Laminate	1492	13 <sup>1</sup> / <sub>10</sub>	77 <sup>1</sup> / <sub>16</sub>	38 <sup>3</sup> / <sub>8</sub>	—	—	194 lbs.	39.8
WW7238HBE2W Wood	\$ 3177	13 <sup>1</sup> / <sub>10</sub>	71 <sup>1</sup> / <sub>16</sub>	38 <sup>3</sup> / <sub>8</sub>	—	—	179 lbs.	37.0
WW7238HBE2L Laminate	1376	13 <sup>1</sup> / <sub>10</sub>	71 <sup>1</sup> / <sub>16</sub>	38 <sup>3</sup> / <sub>8</sub>	—	—	179 lbs.	37.0
WW6638HBE2W Wood	\$ 2985	13 <sup>1</sup> / <sub>10</sub>	65 <sup>1</sup> / <sub>16</sub>	38 <sup>3</sup> / <sub>8</sub>	—	—	164 lbs.	34.1
WW6638HBE2L Laminate	1255	13 <sup>1</sup> / <sub>10</sub>	65 <sup>1</sup> / <sub>16</sub>	38 <sup>3</sup> / <sub>8</sub>	—	—	164 lbs.	34.1
WW6038HBE2W Wood	\$ 2796	13 <sup>1</sup> / <sub>10</sub>	59 <sup>1</sup> / <sub>16</sub>	38 <sup>3</sup> / <sub>8</sub>	—	—	148 lbs.	31.3
WW6038HBE2L Laminate	1166	13 <sup>1</sup> / <sub>10</sub>	59 <sup>1</sup> / <sub>16</sub>	38 <sup>3</sup> / <sub>8</sub>	—	—	148 lbs.	31.3
WW4838HBE2W Wood	\$ 2690	13 <sup>1</sup> / <sub>10</sub>	47 <sup>7</sup> / <sub>8</sub>	38 <sup>3</sup> / <sub>8</sub>	—	—	126 lbs.	25.6
WW4838HBE2L Laminate	1140	13 <sup>1</sup> / <sub>10</sub>	47 <sup>7</sup> / <sub>8</sub>	38 <sup>3</sup> / <sub>8</sub>	—	—	126 lbs.	25.6
<ul style="list-style-type: none"> <li>• Not intended for use on table desking</li> <li>• Specify chassis finish only</li> <li>• Highbacks must be placed on lower units with proper structure. The lower unit must consist of an end panel, support panel and/or undersurface pedestal on each side of the lower unit with a modesty panel spanning between</li> <li>• For tack board options, see pages 776-783</li> </ul>								

### HIGHBACK ORGANIZER FULL BACK - NO DOORS

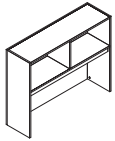
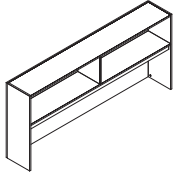

WAVEWORKS

ASSEMBLED

**PRODUCT SPECIFICATIONS**

- Wood, laminate, glass or no doors and wood or laminate chassis available; refer to page 358 for options
- All shelves are ¾" thick
- Tops of units are finished with flat edge detail
- Adjustable hinged doors
- If specifying wood, you must specify the same finish for all options
- Tack boards, slat walls, task lights and vertical pigeon hole storage are available—see accessories section pages 741-784
- National will not be liable for Exhibit mount cabinets or wall mount cabinets that are not properly installed
- Cabinets have a full height back panel

**TO ORDER, SPECIFY:**

1. Model Number
2. Locking
3. Door Frame Color (glass door models)
4. Veneer Chassis Finish/  
Laminate Chassis Color

**SAMPLE MODEL NUMBERS:**

WW3030SOHMGW KS1B AC  
 WW3030SOHML KS1B 440 AC2  
 WW3030SOHMGW 501 AC

- See pages 356-361 for all options available in WaveWorks

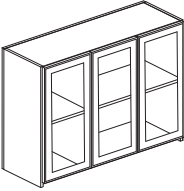
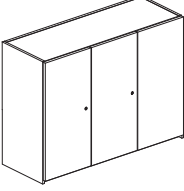
	MODEL NO./DESCRIPTION	LIST PRICE	DIMENSIONS					CARTONED CUBIC		
			D	W	H	A	KW	WEIGHT	FEET	
<b>OVERHEAD STORAGE CABINET WALL MOUNT</b>										
 	<b>30" HIGH—3 DOORS</b>									
	WW4830SOHMGW	Glass/Wood	\$ 3273	14¾	47⅞	29⅞	—	—	150 lbs.	34.0
	WW4830SOHMGL	Glass/Laminate	2154	14¾	47⅞	29⅞	—	—	150 lbs.	34.0
	WW4830SOHMGW	Wood	2356	14¾	47⅞	29⅞	—	—	150 lbs.	34.0
	WW4830SOHML	Laminate	1531	14¾	47⅞	29⅞	—	—	150 lbs.	34.0
	<ul style="list-style-type: none"> <li>• Glass doors do not lock</li> <li>• Random lock core (KRB, KRS) and specified lock core (KS2B, KS2S) available</li> </ul>									
	WW4230SOHMGW	Glass/Wood	\$ 3155	14¾	41⅞	29⅞	—	—	129 lbs.	29.2
	WW4230SOHMGL	Glass/Laminate	2035	14¾	41⅞	29⅞	—	—	129 lbs.	29.2
	WW4230SOHMGW	Wood	2246	14¾	41⅞	29⅞	—	—	129 lbs.	29.2
	WW4230SOHML	Laminate	1453	14¾	41⅞	29⅞	—	—	129 lbs.	29.2
	<ul style="list-style-type: none"> <li>• Glass doors do not lock</li> <li>• Random lock core (KRB, KRS) and specified lock core (KS2B, KS2S) available</li> </ul>									
	<b>30" HIGH—2 DOORS</b>									
WW3630SOHMGW	Glass/Wood	\$ 3034	14¾	35⅞	29⅞	—	—	102 lbs.	25.5	
WW3630SOHMGL	Glass/Laminate	1920	14¾	35⅞	29⅞	—	—	102 lbs.	25.5	
WW3630SOHMGW	Wood	2143	14¾	35⅞	29⅞	—	—	102 lbs.	25.5	
WW3630SOHML	Laminate	1377	14¾	35⅞	29⅞	—	—	102 lbs.	25.5	
<ul style="list-style-type: none"> <li>• Glass doors do not lock</li> <li>• Random lock core (KRB, KRS) and specified lock core (KS1B, KS1S) available</li> </ul>										
WW3030SOHMGW	Glass/Wood	\$ 2901	14¾	29⅞	29⅞	—	—	89 lbs.	21.9	
WW3030SOHMGL	Glass/Laminate	1790	14¾	29⅞	29⅞	—	—	89 lbs.	21.9	
WW3030SOHMGW	Wood	2034	14¾	29⅞	29⅞	—	—	89 lbs.	21.9	
WW3030SOHML	Laminate	1291	14¾	29⅞	29⅞	—	—	89 lbs.	21.9	
<ul style="list-style-type: none"> <li>• Glass doors do not lock</li> <li>• Random lock core (KRB, KRS) and specified lock core (KS1B, KS1S) available</li> <li>• Wall mount bracket, for attachment to wall, is included</li> <li>• National recommends that each overhead cabinet be secured by a minimum of 2 mounting locations (studs)</li> <li>• Features an adjustable shelf</li> <li>• For tack board options, see pages 776-783</li> <li>• Wall mount overheads can be utilized with DIRTT antler extrusion; see page 121</li> </ul>										

WAVEWORKS

ASSEMBLED

# WAVEWORKS

## PRODUCT SPECIFICATIONS

- Wood, laminate, glass or no doors and wood or laminate chassis available; refer to page 358 for options
- All shelves are ¾" thick
- Tops of units are finished with flat edge detail
- Adjustable hinged doors
- If specifying wood, you must specify the same finish for all options
- Tack boards, slat walls, task lights and vertical pigeon hole storage are available—see accessories section pages 741-784
- National will not be liable for Exhibit mount cabinets or wall mount cabinets that are not properly installed
- Cabinets have a full height back panel

## TO ORDER, SPECIFY:

1. Model Number
2. Veneer Chassis Finish/  
Laminate Chassis Color

## SAMPLE MODEL NUMBERS:

WW4830SOEMW AC  
WW4830SOEML 440

- See pages 356-361 for all options available in WaveWorks

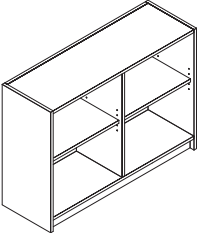
	MODEL NO./DESCRIPTION	LIST PRICE	DIMENSIONS					CARTONED CUBIC		
			D	W	H	A	KW	WEIGHT	FEET	
<b>OVERHEAD STORAGE CABINET NO DOORS - WALL MOUNT</b>    WW4230SOEMW shown- Center Divider Panel	<b>30" HIGH—CENTER DIVIDER PANEL</b>									
	WW4830SOEMW	Wood	\$ 2356	13 <sup>3</sup> / <sub>16</sub>	47 <sup>7</sup> / <sub>8</sub>	29 <sup>15</sup> / <sub>16</sub>	—	—	140 lbs.	34.0
	WW4830SOEML	Laminate	1531	13 <sup>3</sup> / <sub>16</sub>	47 <sup>7</sup> / <sub>8</sub>	29 <sup>15</sup> / <sub>16</sub>	—	—	140 lbs.	34.0
	WW4230SOEMW	Wood	\$ 2246	13 <sup>3</sup> / <sub>16</sub>	41 <sup>7</sup> / <sub>8</sub>	29 <sup>15</sup> / <sub>16</sub>	—	—	119 lbs.	29.2
	WW4230SOEML	Laminate	1453	13 <sup>3</sup> / <sub>16</sub>	41 <sup>7</sup> / <sub>8</sub>	29 <sup>15</sup> / <sub>16</sub>	—	—	119 lbs.	29.2
	<b>30" HIGH—NO DIVIDER PANEL</b>									
WW3630SOEMW	Wood	\$ 2143	13 <sup>3</sup> / <sub>16</sub>	35 <sup>7</sup> / <sub>8</sub>	29 <sup>15</sup> / <sub>16</sub>	—	—	92 lbs.	25.5	
WW3630SOEML	Laminate	1377	13 <sup>3</sup> / <sub>16</sub>	35 <sup>7</sup> / <sub>8</sub>	29 <sup>15</sup> / <sub>16</sub>	—	—	92 lbs.	25.5	
WW3030SOEMW	Wood	\$ 2034	13 <sup>3</sup> / <sub>16</sub>	29 <sup>15</sup> / <sub>16</sub>	29 <sup>15</sup> / <sub>16</sub>	—	—	79 lbs.	21.9	
WW3030SOEML	Laminate	1291	13 <sup>3</sup> / <sub>16</sub>	29 <sup>15</sup> / <sub>16</sub>	29 <sup>15</sup> / <sub>16</sub>	—	—	79 lbs.	21.9	

- Wall mount bracket, for attachment to wall, is included
- Cabinets are open and do not have doors
- National recommends that each overhead cabinet be secured by a minimum of 2 mounting locations (studs)
- Features an adjustable shelf
- For tack board options, see pages 776-783
- Wall mount overheads can be utilized with DIRTT antler extrusion; see page 121



**PRODUCT SPECIFICATIONS**

- Wood, laminate, glass or no doors and wood or laminate chassis available; refer to page 358 for options
- All shelves are ¾" thick
- Tops of units are finished with flat edge detail
- Adjustable hinged doors
- If specifying wood, you must specify the same finish for all options
- Tack boards, slat walls, task lights and vertical pigeon hole storage are available—see accessories section pages 741-784
- National will not be liable for Exhibit mount cabinets or wall mount cabinets that are not properly installed
- Cabinets have a full height back panel

**TO ORDER, SPECIFY:**

1. Model Number
2. Locking
3. Door Frame Color (glass door models)
4. Veneer Chassis Finish/  
Laminate Chassis Color

**SAMPLE MODEL NUMBERS:**

WW3018SOHMGW KS1B AC  
 WW3018SOHML KS1B 440 AC2  
 WW3018SOHMGW 501 AC

- See pages 356-361 for all options available in WaveWorks



Shaded model numbers are available on our "To You in 10 Days or Less" Quick Delivery program and will be delivered in 10 days or less.

	MODEL NO./DESCRIPTION	LIST PRICE	DIMENSIONS					CARTONED WEIGHT	CUBIC FEET	
			D	W	H	A	KW			
<b>OVERHEAD STORAGE CABINET - WALL MOUNT</b>										
	<b>18" HIGH—3 DOORS</b>									
	WW4818SOHMGW	Glass/Wood	\$ 2339	14¾	47¾	18¾	—	—	115 lbs.	11.8
	WW4818SOHMGL	Glass/Laminate	1583	14¾	47¾	18¾	—	—	115 lbs.	11.8
	WW4818SOHMGW	Wood	1876	14¾	47¾	18¾	—	—	115 lbs.	11.8
	WW4818SOHML	Laminate	1136	14¾	47¾	18¾	—	—	115 lbs.	11.8
	<ul style="list-style-type: none"> <li>• Glass doors do not lock</li> <li>• Random lock core (KRB, KRS) and specified lock core (KS2B, KS2S) available</li> </ul>									
	WW4218SOHMGW	Glass/Wood	\$ 2258	14¾	41¾	18¾	—	—	100 lbs.	11.1
	WW4218SOHMGL	Glass/Laminate	1508	14¾	41¾	18¾	—	—	100 lbs.	11.1
	WW4218SOHMGW	Wood	1797	14¾	41¾	18¾	—	—	100 lbs.	11.1
	WW4218SOHML	Laminate	1057	14¾	41¾	18¾	—	—	100 lbs.	11.1
	<ul style="list-style-type: none"> <li>• Glass doors do not lock</li> <li>• Random lock core (KRB, KRS) and specified lock core (KS2B, KS2S) available</li> </ul>									
	<b>18" HIGH—2 DOORS</b>									
	WW3618SOHMGW	Glass/Wood	\$ 2178	14¾	35¾	18¾	—	—	76 lbs.	7.7
	WW3618SOHMGL	Glass/Laminate	1430	14¾	35¾	18¾	—	—	76 lbs.	7.7
	QWW3618SOHMGW	Wood	1717	14¾	35¾	18¾	—	—	76 lbs.	7.7
	WW3618SOHMGW	Wood	1717	14¾	35¾	18¾	—	—	76 lbs.	7.7
	QWW3618SOHML	Laminate	980	14¾	35¾	18¾	—	—	76 lbs.	7.7
	WW3618SOHML	Laminate	980	14¾	35¾	18¾	—	—	76 lbs.	7.7
	<ul style="list-style-type: none"> <li>• Glass doors do not lock</li> <li>• Random lock core (KRB, KRS) and specified lock core (KS1B, KS1S) available</li> </ul>									
	WW3018SOHMGW	Glass/Wood	\$ 2088	14¾	29½	18¾	—	—	64 lbs.	6.4
WW3018SOHMGL	Glass/Laminate	1343	14¾	29½	18¾	—	—	64 lbs.	6.4	
QWW3018SOHMGW	Wood	1626	14¾	29½	18¾	—	—	64 lbs.	6.4	
WW3018SOHMGW	Wood	1626	14¾	29½	18¾	—	—	64 lbs.	6.4	
QWW3018SOHML	Laminate	899	14¾	29½	18¾	—	—	64 lbs.	6.4	
WW3018SOHML	Laminate	899	14¾	29½	18¾	—	—	64 lbs.	6.4	
<ul style="list-style-type: none"> <li>• Glass doors do not lock</li> <li>• Random lock core (KRB, KRS) and specified lock core (KS1B, KS1S) available</li> </ul>										
<ul style="list-style-type: none"> <li>• Wall mount bracket, for attachment to wall, is included</li> <li>• 30" and 36" units have 2 doors; the 42" and 48" units have 3 doors</li> <li>• National recommends that each overhead cabinet be secured by a minimum of 2 mounting locations (studs); National will not be liable for wall mount cabinets that are not properly installed</li> <li>• For tack board options, see pages 776-783</li> <li>• Wall mount overheads can be utilized with DIRTT antler extrusion; see page 121</li> </ul>										

WAVEWORKS

ASSEMBLED

# WAVEWORKS

## PRODUCT SPECIFICATIONS

- Wood, laminate, glass or no doors and wood or laminate chassis available; refer to page 358 for options
- All shelves are ¾" thick
- Tops of units are finished with flat edge detail
- Adjustable hinged doors
- If specifying wood, you must specify the same finish for all options
- Tack boards, slat walls, task lights and vertical pigeon hole storage are available—see accessories section pages 741-784
- National will not be liable for Exhibit mount cabinets or wall mount cabinets that are not properly installed
- Cabinets have a full height back panel

## TO ORDER, SPECIFY:

1. Model Number
2. Veneer Chassis Finish/  
Laminate Chassis Color

## SAMPLE MODEL NUMBERS:

WW4818SOEMW AC  
WW4818SOEML 440

- See pages 356-361 for all options available in WaveWorks



Shaded model numbers are available on our "To You in 10 Days or Less" Quick Delivery program and will be delivered in 10 days or less.

	MODEL NO./DESCRIPTION	LIST PRICE	DIMENSIONS					CARTONED CUBIC		
			D	W	H	A	KW	WEIGHT	FEET	
<b>OVERHEAD STORAGE CABINET NO DOORS - WALL MOUNT</b>	<b>18" HIGH—CENTER DIVIDER PANEL</b>									
	WW4818SOEMW	Wood	\$ 1876	13 <sup>1</sup> / <sub>16</sub>	47 <sup>7</sup> / <sub>16</sub>	18 <sup>1</sup> / <sub>16</sub>	—	—	90 lbs.	13.0
	WW4818SOEML	Laminate	1136	13 <sup>1</sup> / <sub>16</sub>	47 <sup>7</sup> / <sub>16</sub>	18 <sup>1</sup> / <sub>16</sub>	—	—	90 lbs.	13.0
	WW4218SOEMW	Wood	\$ 1797	13 <sup>1</sup> / <sub>16</sub>	41 <sup>1</sup> / <sub>16</sub>	18 <sup>1</sup> / <sub>16</sub>	—	—	80 lbs.	11.1
	WW4218SOEML	Laminate	1057	13 <sup>1</sup> / <sub>16</sub>	41 <sup>1</sup> / <sub>16</sub>	18 <sup>1</sup> / <sub>16</sub>	—	—	80 lbs.	11.1
<b>18" HIGH—NO DIVIDER PANEL</b>	QWW3618SOEMW	Wood	\$ 1717	13 <sup>1</sup> / <sub>16</sub>	35 <sup>5</sup> / <sub>16</sub>	18 <sup>1</sup> / <sub>16</sub>	—	—	70 lbs.	7.7
	WW3618SOEMW	Wood	1717	13 <sup>1</sup> / <sub>16</sub>	35 <sup>5</sup> / <sub>16</sub>	18 <sup>1</sup> / <sub>16</sub>	—	—	70 lbs.	7.7
	QWW3618SOEML	Laminate	980	13 <sup>1</sup> / <sub>16</sub>	35 <sup>5</sup> / <sub>16</sub>	18 <sup>1</sup> / <sub>16</sub>	—	—	70 lbs.	7.7
	WW3618SOEML	Laminate	980	13 <sup>1</sup> / <sub>16</sub>	35 <sup>5</sup> / <sub>16</sub>	18 <sup>1</sup> / <sub>16</sub>	—	—	70 lbs.	7.7
	QWW3018SOEMW	Wood	\$ 1626	13 <sup>1</sup> / <sub>16</sub>	29 <sup>1</sup> / <sub>16</sub>	18 <sup>1</sup> / <sub>16</sub>	—	—	60 lbs.	6.4
	WW3018SOEMW	Wood	1626	13 <sup>1</sup> / <sub>16</sub>	29 <sup>1</sup> / <sub>16</sub>	18 <sup>1</sup> / <sub>16</sub>	—	—	60 lbs.	6.4
	QWW3018SOEML	Laminate	899	13 <sup>1</sup> / <sub>16</sub>	29 <sup>1</sup> / <sub>16</sub>	18 <sup>1</sup> / <sub>16</sub>	—	—	60 lbs.	6.4
	WW3018SOEML	Laminate	899	13 <sup>1</sup> / <sub>16</sub>	29 <sup>1</sup> / <sub>16</sub>	18 <sup>1</sup> / <sub>16</sub>	—	—	60 lbs.	6.4

### OVERHEAD STORAGE CABINET NO DOORS - WALL MOUNT

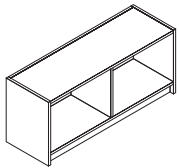

Center Divider Panel shown

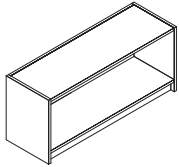

No Divider Panel shown

- Wall mount bracket, for attachment to wall, is included
- Cabinets are open and do not have doors
- National recommends that each overhead cabinet be secured by a minimum of 2 mounting locations (studs)
- For tack board options, see pages 776-783
- Wall mount overheads can be utilized with DIRT antler extrusion; see below

### DIRTT OVERHEAD MOUNTING KITS

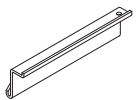

NAC480K	For 48" Overhead	\$ 255	1	6	1 <sup>1</sup> / <sub>16</sub>	—	—	8 lbs.	2.0
NAC420K	For 42" Overhead	246	1	6	1 <sup>1</sup> / <sub>16</sub>	—	—	8 lbs.	2.0
NAC360K	For 36" Overhead	237	1	6	1 <sup>1</sup> / <sub>16</sub>	—	—	8 lbs.	2.0
NAC300K	For 30" Overhead	218	1	6	1 <sup>1</sup> / <sub>16</sub>	—	—	8 lbs.	1.5

- Available in black only
- For use with Epic, Renegade, and WaveWorks wall mount cabinets
- Bracket designed to interact with the DIRT antler extrusion
- Can be used with 13", 18", and 30" high cabinets
- 30" comes with 2 brackets; 36"-48" comes with 3 brackets; each kit also includes a mounting extrusion strip that matches the size of the overhead

**PRODUCT SPECIFICATIONS**

- Wood or laminate chassis available; refer to page 358 for options
- All shelves are ¾" thick
- Tops of units are finished with flat edge detail
- Tack boards, slat walls, task lights and vertical pigeon hole storage are available—see accessories section pages 741-784
- National will not be liable for Exhibit mount cabinets or wall mount cabinets that are not properly installed
- Cabinets have a full height back panel

**TO ORDER, SPECIFY:**

1. Model Number
2. Locking
3. Door Frame Color (glass door models)
4. Veneer Chassis Finish/  
Laminate Chassis Color

**SAMPLE MODEL NUMBERS:**

WW4230SOHTGW 503 HN  
 WW4230SOHTL KRS 440 HN2  
 WW4230SOHTW KRS HN

- See pages 356-361 for all options available in WaveWorks

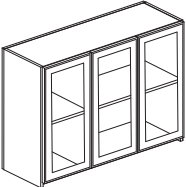
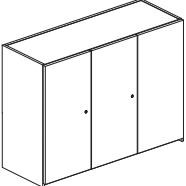
	MODEL NO./DESCRIPTION	LIST PRICE	DIMENSIONS					CARTONED CUBIC		
			D	W	H	A	KW	WEIGHT	FEET	
<b>OVERHEAD STORAGE CABINET EXHIBIT MOUNT</b>    	<b>30" HIGH—3 DOORS</b>									
	WW4830SOHTGW	Glass/Wood	\$ 3273	14¾	47⅞	29⅞	—	—	150 lbs.	34.0
	WW4830SOHTGL	Glass/Laminate	2154	14¾	47⅞	29⅞	—	—	150 lbs.	34.0
	WW4830SOHTW	Wood	2356	14¾	47⅞	29⅞	—	—	150 lbs.	34.0
	WW4830SOHTL	Laminate	1531	14¾	47⅞	29⅞	—	—	150 lbs.	34.0
		<ul style="list-style-type: none"> <li>• Glass doors do not lock</li> <li>• Random lock core (KRB, KRS) and specified lock core (KS2B, KS2S) available</li> </ul>								
	WW4230SOHTGW	Glass/Wood	\$ 3155	14¾	41⅞	29⅞	—	—	129 lbs.	29.2
	WW4230SOHTGL	Glass/Laminate	2035	14¾	41⅞	29⅞	—	—	129 lbs.	29.2
	WW4230SOHTW	Wood	2246	14¾	41⅞	29⅞	—	—	129 lbs.	29.2
	WW4230SOHTL	Laminate	1453	14¾	41⅞	29⅞	—	—	129 lbs.	29.2
		<ul style="list-style-type: none"> <li>• Glass doors do not lock</li> <li>• Random lock core (KRB, KRS) and specified lock core (KS2B, KS2S) available</li> </ul>								
		<b>30" HIGH—2 DOORS</b>								
	WW3630SOHTGW	Glass/Wood	\$ 3034	14¾	35⅞	29⅞	—	—	102 lbs.	25.5
	WW3630SOHTGL	Glass/Laminate	1920	14¾	35⅞	29⅞	—	—	102 lbs.	25.5
	WW3630SOHTW	Wood	2143	14¾	35⅞	29⅞	—	—	102 lbs.	25.5
	WW3630SOHTL	Laminate	1377	14¾	35⅞	29⅞	—	—	102 lbs.	25.5
	<ul style="list-style-type: none"> <li>• Glass doors do not lock</li> <li>• Random lock core (KRB, KRS) and specified lock core (KS1B, KS1S) available</li> </ul>									
WW3030SOHTGW	Glass/Wood	\$ 2901	14¾	29⅞	29⅞	—	—	89 lbs.	21.9	
WW3030SOHTGL	Glass/Laminate	1790	14¾	29⅞	29⅞	—	—	89 lbs.	21.9	
WW3030SOHTW	Wood	2034	14¾	29⅞	29⅞	—	—	89 lbs.	21.9	
WW3030SOHTL	Laminate	1291	14¾	29⅞	29⅞	—	—	89 lbs.	21.9	
	<ul style="list-style-type: none"> <li>• Glass doors do not lock</li> <li>• Random lock core (KRB, KRS) and specified lock core (KS1B, KS1S) available</li> <li>• Exhibit mount bracket is included, must order Exhibit wall rail separately</li> <li>• It is recommended that overheads are not slid to a new location when there are tack board inserts behind the overheads</li> <li>• If an overhead needs to be relocated, the overhead must be removed from the Exhibit rail and reinstalled in another location on the Exhibit rail</li> <li>• See page 430 for Exhibit Wall Rail and Filler Strip</li> <li>• Features an adjustable shelf</li> </ul>									

WAVEWORKS

ASSEMBLED

# WAVEWORKS

## PRODUCT SPECIFICATIONS

- Wood or laminate chassis available; refer to page 358 for options
- All shelves are ¾" thick
- Tops of units are finished with flat edge detail
- Tack boards, slat walls, task lights and vertical pigeon hole storage are available—see accessories section pages 741-784
- National will not be liable for Exhibit mount cabinets or wall mount cabinets that are not properly installed
- Cabinets have a full height back panel

## TO ORDER, SPECIFY:

1. Model Number
2. Veneer Chassis Finish/  
Laminate Chassis Color

## SAMPLE MODEL NUMBERS:

WW4830SOETW AC  
WW4830SOETL 440

- See pages 356-361 for all options available in WaveWorks

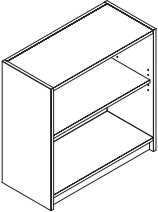
	MODEL NO./DESCRIPTION	LIST PRICE	DIMENSIONS					CARTONED CUBIC		
			D	W	H	A	KW	WEIGHT	FEET	
<b>OVERHEAD STORAGE CABINET NO DOORS - EXHIBIT MOUNT</b>   WW3030SOETW shown- No Divider Panel	<b>30" HIGH—CENTER DIVIDER PANEL</b>									
	WW4830SOETW	Wood	\$ 2356	13 <sup>3</sup> / <sub>16</sub>	47 <sup>7</sup> / <sub>8</sub>	29 <sup>1</sup> / <sub>16</sub>	—	—	140 lbs.	34.0
	WW4830SOETL	Laminate	1531	13 <sup>3</sup> / <sub>16</sub>	47 <sup>7</sup> / <sub>8</sub>	29 <sup>1</sup> / <sub>16</sub>	—	—	140 lbs.	34.0
	WW4230SOETW	Wood	\$ 2246	13 <sup>3</sup> / <sub>16</sub>	41 <sup>7</sup> / <sub>8</sub>	29 <sup>1</sup> / <sub>16</sub>	—	—	119 lbs.	29.2
	WW4230SOETL	Laminate	1453	13 <sup>3</sup> / <sub>16</sub>	41 <sup>7</sup> / <sub>8</sub>	29 <sup>1</sup> / <sub>16</sub>	—	—	119 lbs.	29.2
	<b>30" HIGH—NO DIVIDER PANEL</b>									
WW3630SOETW	Wood	\$ 2143	13 <sup>3</sup> / <sub>16</sub>	35 <sup>7</sup> / <sub>8</sub>	29 <sup>1</sup> / <sub>16</sub>	—	—	92 lbs.	25.5	
WW3630SOETL	Laminate	1377	13 <sup>3</sup> / <sub>16</sub>	35 <sup>7</sup> / <sub>8</sub>	29 <sup>1</sup> / <sub>16</sub>	—	—	92 lbs.	25.5	
WW3030SOETW	Wood	\$ 2034	13 <sup>3</sup> / <sub>16</sub>	29 <sup>1</sup> / <sub>16</sub>	29 <sup>1</sup> / <sub>16</sub>	—	—	79 lbs.	21.9	
WW3030SOETL	Laminate	1291	13 <sup>3</sup> / <sub>16</sub>	29 <sup>1</sup> / <sub>16</sub>	29 <sup>1</sup> / <sub>16</sub>	—	—	79 lbs.	21.9	

- Exhibit mount bracket is included, Exhibit wall rail must be ordered separately
- It is recommended that overheads are not slid to a new location when there are tack board inserts behind the overheads
- If an overhead needs to be relocated, the overhead must be removed from the Exhibit rail and reinstalled in another location on the Exhibit rail
- See page 430 for Exhibit Wall Rail and Filler Strip
- Features an adjustable shelf

**PRODUCT SPECIFICATIONS**

- Wood, laminate, glass or no doors and wood or laminate chassis available; refer to page 358 for options
- Tack boards, slat walls, task lights and vertical pigeon hole storage are available—see accessories section pages 741-784
- Tops of units are finished with flat edge detail
- Adjustable hinged doors
- If specifying wood, you must specify the same finish for all options
- National will not be liable for Exhibit mount cabinets or wall mount cabinets that are not properly installed
- Cabinets have a full height back panel

**TO ORDER, SPECIFY:**

1. Model Number
2. Locking
3. Door Frame Color (glass door models)
4. Veneer Chassis Finish/  
Laminate Chassis Color

**SAMPLE MODEL NUMBERS:**

WW4218SOHTGW 503 HN  
 WW4218SOHTL KRS 440 HN2  
 WW4218SOHTW KRS HN

- See pages 356-361 for all options available in WaveWorks

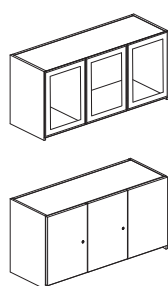
	MODEL NO./DESCRIPTION	LIST PRICE	DIMENSIONS					CARTONED WEIGHT	CUBIC FEET	
			D	W	H	A	KW			
<b>OVERHEAD STORAGE CABINET - EXHIBIT MOUNT</b> 	<b>18" HIGH—3 DOORS</b>									
	WW4818SOHTGW	Glass/Wood	\$ 2339	14 $\frac{3}{4}$	47 $\frac{7}{8}$	18 $\frac{1}{2}$	—	—	115 lbs.	11.8
	WW4818SOHTGL	Glass/Laminate	1583	14 $\frac{3}{4}$	47 $\frac{7}{8}$	18 $\frac{1}{2}$	—	—	115 lbs.	11.8
	WW4818SOHTW	Wood	1876	14 $\frac{3}{4}$	47 $\frac{7}{8}$	18 $\frac{1}{2}$	—	—	115 lbs.	11.8
	WW4818SOHTL	Laminate	1136	14 $\frac{3}{4}$	47 $\frac{7}{8}$	18 $\frac{1}{2}$	—	—	115 lbs.	11.8
	<ul style="list-style-type: none"> <li>• Glass doors do not lock</li> <li>• Random lock core (KRB, KRS) and specified lock core (KS2B, KS2S) available</li> </ul>									
	WW4218SOHTGW	Glass/Wood	\$ 2258	14 $\frac{3}{4}$	41 $\frac{1}{2}$	18 $\frac{1}{2}$	—	—	100 lbs.	11.1
	WW4218SOHTGL	Glass/Laminate	1508	14 $\frac{3}{4}$	41 $\frac{1}{2}$	18 $\frac{1}{2}$	—	—	100 lbs.	11.1
	WW4218SOHTW	Wood	1797	14 $\frac{3}{4}$	41 $\frac{1}{2}$	18 $\frac{1}{2}$	—	—	100 lbs.	11.1
	WW4218SOHTL	Laminate	1057	14 $\frac{3}{4}$	41 $\frac{1}{2}$	18 $\frac{1}{2}$	—	—	100 lbs.	11.1
	<ul style="list-style-type: none"> <li>• Glass doors do not lock</li> <li>• Random lock core (KRB, KRS) and specified lock core (KS2B, KS2S) available</li> </ul>									
	<b>18" HIGH—2 DOORS</b>									
	WW3618SOHTGW	Glass/Wood	\$ 2178	14 $\frac{3}{4}$	35 $\frac{7}{8}$	18 $\frac{1}{2}$	—	—	76 lbs.	7.7
	WW3618SOHTGL	Glass/Laminate	1430	14 $\frac{3}{4}$	35 $\frac{7}{8}$	18 $\frac{1}{2}$	—	—	76 lbs.	7.7
	WW3618SOHTW	Wood	1717	14 $\frac{3}{4}$	35 $\frac{7}{8}$	18 $\frac{1}{2}$	—	—	76 lbs.	7.7
	WW3618SOHTL	Laminate	980	14 $\frac{3}{4}$	35 $\frac{7}{8}$	18 $\frac{1}{2}$	—	—	76 lbs.	7.7
<ul style="list-style-type: none"> <li>• Glass doors do not lock</li> <li>• Random lock core (KRB, KRS) and specified lock core (KS1B, KS1S) available</li> </ul>										
WW3018SOHTGW	Glass/Wood	\$ 2088	14 $\frac{3}{4}$	29 $\frac{1}{16}$	18 $\frac{1}{2}$	—	—	64 lbs.	6.4	
WW3018SOHTGL	Glass/Laminate	1343	14 $\frac{3}{4}$	29 $\frac{1}{16}$	18 $\frac{1}{2}$	—	—	64 lbs.	6.4	
WW3018SOHTW	Wood	1626	14 $\frac{3}{4}$	29 $\frac{1}{16}$	18 $\frac{1}{2}$	—	—	64 lbs.	6.4	
WW3018SOHTL	Laminate	899	14 $\frac{3}{4}$	29 $\frac{1}{16}$	18 $\frac{1}{2}$	—	—	64 lbs.	6.4	
<ul style="list-style-type: none"> <li>• Glass doors do not lock</li> <li>• Random lock core (KRB, KRS) and specified lock core (KS1B, KS1S) available</li> </ul>										
<ul style="list-style-type: none"> <li>• Exhibit mount bracket is included, Exhibit Wall Rail needs to be ordered separately</li> <li>• It is recommended that overheads are not slid to a new location when there are tack board inserts behind the overheads</li> <li>• If an overhead needs to be relocated, the overhead must be removed from the Exhibit rail and reinstalled in another location on the Exhibit rail</li> <li>• See page 430 for Exhibit Wall Rail and Filler Strip</li> </ul>										

WAVEWORKS

ASSEMBLED

# WAVEWORKS

## PRODUCT SPECIFICATIONS

- Wood, laminate, glass or no doors and wood or laminate chassis available; refer to page 358 for options
- Tack boards, slat walls, task lights and vertical pigeon hole storage are available—see accessories section pages 741-784
- Tops of units are finished with flat edge detail
- Adjustable hinged doors
- If specifying wood, you must specify the same finish for all options
- National will not be liable for Exhibit mount cabinets or wall mount cabinets that are not properly installed
- Cabinets have a full height back panel

## TO ORDER, SPECIFY:

1. Model Number
2. Veneer Chassis Finish/  
Laminate Chassis Color

## SAMPLE MODEL NUMBERS:

WW4818SOETW AC  
WW4818SOETL 440

- See pages 356-361 for all options available in WaveWorks

WAVEWORKS

ASSEMBLED

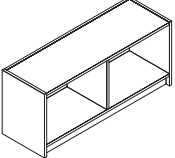
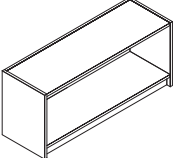
	MODEL NO./DESCRIPTION	LIST PRICE	DIMENSIONS					CARTONED WEIGHT	CUBIC FEET		
			D	W	H	A	KW				
 Center Divider Panel shown	<b>18" HIGH—CENTER DIVIDER PANEL</b>										
	WW4818SOETW	Wood	\$ 1876	13 <sup>1</sup> / <sub>16</sub>	47 <sup>7</sup> / <sub>16</sub>	18 <sup>1</sup> / <sub>16</sub>	—	—	115 lbs.	11.8	
	WW4818SOETL	Laminate	1136	13 <sup>1</sup> / <sub>16</sub>	47 <sup>7</sup> / <sub>16</sub>	18 <sup>1</sup> / <sub>16</sub>	—	—	115 lbs.	11.8	
 No Divider Panel shown	<b>18" HIGH—NO DIVIDER PANEL</b>										
	WW4218SOETW	Wood	\$ 1797	13 <sup>1</sup> / <sub>16</sub>	41 <sup>1</sup> / <sub>16</sub>	18 <sup>1</sup> / <sub>16</sub>	—	—	100 lbs.	11.1	
	WW4218SOETL	Laminate	1057	13 <sup>1</sup> / <sub>16</sub>	41 <sup>1</sup> / <sub>16</sub>	18 <sup>1</sup> / <sub>16</sub>	—	—	100 lbs.	11.1	
		<b>18" HIGH—NO DIVIDER PANEL</b>									
		WW3618SOETW	Wood	\$ 1717	13 <sup>1</sup> / <sub>16</sub>	35 <sup>5</sup> / <sub>16</sub>	18 <sup>1</sup> / <sub>16</sub>	—	—	76 lbs.	7.7
		WW3618SOETL	Laminate	980	13 <sup>1</sup> / <sub>16</sub>	35 <sup>5</sup> / <sub>16</sub>	18 <sup>1</sup> / <sub>16</sub>	—	—	76 lbs.	7.7
		WW3018SOETW	Wood	\$ 1626	13 <sup>1</sup> / <sub>16</sub>	29 <sup>1</sup> / <sub>16</sub>	18 <sup>1</sup> / <sub>16</sub>	—	—	64 lbs.	6.4
		WW3018SOETL	Laminate	899	13 <sup>1</sup> / <sub>16</sub>	29 <sup>1</sup> / <sub>16</sub>	18 <sup>1</sup> / <sub>16</sub>	—	—	64 lbs.	6.4

- Exhibit mount bracket is included, Exhibit Wall Rail must be ordered separately
- Cabinets are open and do not have doors
- It is recommended that overheads are not slid to a new location when there are tack board inserts behind the overheads
- If an overhead needs to be relocated, the overhead must be removed from the Exhibit rail and reinstalled in another location on the Exhibit rail
- See below for Exhibit Wall Rail and Filler Strip

## OVERHEAD STORAGE CABINET FILLER PANEL

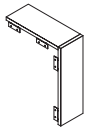

### FILLER PANELS

WW1329CPOFPL	\$ 136	6	14	29 <sup>1</sup> / <sub>16</sub>	—	—	—	0.8
WW1318CPOFPL	123	6	14	14 <sup>3</sup> / <sub>4</sub>	—	—	—	0.4

- To be used with overhead storage cabinets to fill in space as needed
- Can be field cut to desired width

## EXHIBIT WALL RAIL

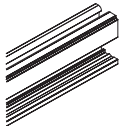

### WALL RAIL

11N72EXP1	1 Rail/No faceplate	\$ 133	<sup>3</sup> / <sub>4</sub>	72	1 <sup>3</sup> / <sub>4</sub>	—	—	6 lbs.	0.7
11N144EXP1	1 Rail/No faceplate	193	<sup>3</sup> / <sub>4</sub>	144	1 <sup>3</sup> / <sub>4</sub>	—	—	12 lbs.	1.4

- Includes 1 wall rail and 2 alignment brackets
- Specify 423 Concrete, 462 Cinder, 463 Iron, 501 Platinum Metallic or 503 Satin Nickel Metallic
- For use when hanging a worksurface or overhead without the use of an insert

## FILLER STRIP KIT EXHIBIT MOUNT

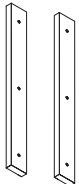

11NCPFSW	Wood	\$ 70	1	3	27 <sup>1</sup> / <sub>4</sub>	—	—	3 lbs.	1.0
11NCPFSL	Laminate	36	1	3	27 <sup>1</sup> / <sub>4</sub>	—	—	3 lbs.	1.0

- For use with Exhibit mounted overheads when an insert is not used behind the overhead
- Must be field scribed for 18" and 13" high overhead models
- Specify solid/woodgrain/Gallery laminate or wood finish

**PRODUCT SPECIFICATIONS**

- Wood, laminate, glass doors and wood or laminate chassis available; refer to page 358 for options
- Refer to pages 741-784 for accessories
- Tops of units are finished with flat edge detail
- Adjustable hinged doors
- If specifying wood, you must specify the same finish for all options
- Wood drawers feature dowel construction
- Wood drawers feature sides and backs that are ½" thick, bottoms are ¼" thick with veneer faces that are sealed and finished with a clear coat

**TO ORDER, SPECIFY:**

1. Model Number
2. Rim
3. Rim Color (laminate units only)
4. Pull
5. Locking
6. Top Finish (laminate units only)
7. Drawer Finish (laminate units only)
8. Chassis Finish

**SAMPLE MODEL NUMBERS:**

WW2436LFF2W C 7MB KRB MC  
 WW2436LFF2L VMH 7MB KRB 480 480  
 WW2436LFF2LW V 440 7MB KRB MH

• See pages 356-361 for all options available in WaveWorks

	MODEL NO./DESCRIPTION	LIST PRICE	DIMENSIONS					CARTONED WEIGHT	CUBIC FEET	
			D	W	H	A	KW			
<b>LATERAL FILE 2 DRAWER</b>  	<b>1 1/8" TOP THICKNESS</b>									
	WWN2436LFF2W	Wood	\$ 3397	24	36 1/16	29 3/8	—	—	155 lbs.	22.2
	WWN2436LFF2LW	Laminate/Wood	3397	24	36 1/16	29 3/8	—	—	155 lbs.	22.2
	WWN2436LFF2L	Laminate	2240	24	36 1/16	29 3/8	—	—	155 lbs.	22.2
	<b>1 3/16" TOP THICKNESS</b>									
	WW2436LFF2W	Wood	\$ 3088	24	36 1/16	28 1/16	—	—	155 lbs.	22.2
	WW2436LFF2LW	Laminate/Wood	3088	24	36 1/16	28 1/16	—	—	155 lbs.	22.2
	WW2436LFF2L	Laminate	2037	24	36 1/16	28 1/16	—	—	155 lbs.	22.2
	WW2436LFF2LL	TFL	1628	24	36 1/16	28 3/8	—	—	155 lbs.	22.2
	<ul style="list-style-type: none"> <li>• Interlock mechanism allows only 1 drawer to be open at a time</li> <li>• Random lock core (KRB, KRS) and specified lock core (KS1B, KS1S) available</li> <li>• When specifying Horizon pulls, lateral files will have 2 pulls on each drawer front</li> <li>• Wood drawers can be specified on 1 3/16" Wood models; add a "W" to the end of the model number and add \$329 to the list price</li> </ul>									

**LATERAL FILE  
3 DRAWER**



<b>1 1/8" TOP THICKNESS</b>									
WWN2436LFF3W	Wood	\$ 4580	24	36 1/16	41 7/8	—	—	210 lbs.	30.0
WWN2436LFF3LW	Laminate/Wood	4580	24	36 1/16	41 7/8	—	—	210 lbs.	30.0
WWN2436LFF3L	Laminate	3020	24	36 1/16	41 7/8	—	—	210 lbs.	30.0
<b>1 3/16" TOP THICKNESS</b>									
WW2436LFF3W	Wood	\$ 4164	24	36 1/16	41 1/2	—	—	210 lbs.	30.0
WW2436LFF3LW	Laminate/Wood	4164	24	36 1/16	41 1/2	—	—	210 lbs.	30.0
WW2436LFF3L	Laminate	2743	24	36 1/16	41 1/2	—	—	210 lbs.	30.0
WW2436LFF3LL	TFL	2198	24	36 1/16	41 1/8	—	—	210 lbs.	30.0
<ul style="list-style-type: none"> <li>• Interlock mechanism allows only 1 drawer to be open at a time</li> <li>• Random lock core (KRB, KRS) and specified lock core (KS1B, KS1S) available</li> <li>• When specifying Horizon pulls, lateral files will have 2 pulls on each drawer front</li> </ul>									

# WAVEWORKS

## PRODUCT SPECIFICATIONS

- Wood and laminate doors/drawers and chassis available; refer to page 358 for options
- Refer to page 363 for filing capabilities
- If specifying wood, you must specify the same finish for all options
- Wood drawers feature dowel construction
- Wood drawers feature sides and backs that are ½" thick, bottoms are ¼" thick with veneer faces that are sealed and finished with a clear coat

## TO ORDER, SPECIFY:

1. Model Number
2. Rim
3. Rim Color (laminite units only)
4. Pull
5. Locking
6. Top Finish (laminite units only)
7. Drawer Finish (laminite units only)
8. Chassis Finish

## SAMPLE MODEL NUMBERS:

WWN2436PF33W C 7MB KS1B MC  
 WWN2436PF33L VMH 7MB KS1B 480 480  
 WWN2436PF33LW V 440 7MB KS1B MH

- See pages 356-361 for all options available in WaveWorks

### LATERAL FILE 4 DRAWER

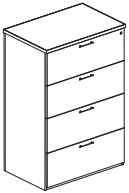

#### MODEL NO./DESCRIPTION

#### 1 1/8" TOP THICKNESS

MODEL NO./DESCRIPTION	LIST PRICE	D	W	H	A	KW	CARTONED WEIGHT	CUBIC FEET
WWN2436LFF4W Wood	\$ 5476	24	36 1/16	54 7/16	—	—	265 lbs.	33.4
WWN2436LFF4LW Laminate/Wood	5476	24	36 1/16	54 7/16	—	—	265 lbs.	33.4
WWN2436LFF4L Laminate	3461	24	36 1/16	54 7/16	—	—	265 lbs.	33.4

#### 1 3/8" TOP THICKNESS

WW2436LFF4W Wood	\$ 4973	24	36 1/16	54 1/16	—	—	265 lbs.	33.4
WW2436LFF4LW Laminate/Wood	4973	24	36 1/16	54 1/16	—	—	265 lbs.	33.4
WW2436LFF4L Laminate	3150	24	36 1/16	54 1/16	—	—	265 lbs.	33.4
WW2436LFF4LL TFL	2520	24	36 1/16	54	—	—	265 lbs.	33.4

- Interlock mechanism allows only 1 drawer to be open at a time
- Random lock core (KRB, KRS) and specified lock core (KS1B, KS1S) available
- When specifying Horizon pulls, lateral files will have 2 pulls on each drawer front
- Wood drawers can be specified on 1 3/8" Wood models; add a "W" to the end of the model number and add \$659 to the list price

### MIXED STORAGE CABINET

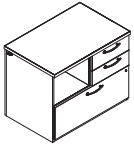

Left shown

#### 1 1/8" TOP THICKNESS

#### OPEN STORAGE ON LEFT

#### OPEN STORAGE ON RIGHT

MODEL NO./DESCRIPTION	LIST PRICE	D	W	H	A	KW	CARTONED WEIGHT	CUBIC FEET
WWN2436PF33W Wood	\$ 3835	24	36 1/16	29 3/8	—	—	130 lbs.	22.2
WWN2436PF33LW Lam/Wood	3835	24	36 1/16	29 3/8	—	—	130 lbs.	22.2
WWN2436PF33L Laminate	2471	24	36 1/16	29 3/8	—	—	130 lbs.	22.2

#### 1 3/8" TOP THICKNESS

#### OPEN STORAGE ON LEFT

#### OPEN STORAGE ON RIGHT

WW2436PF33W Wood	\$ 3526	24	36 1/16	28 1/16	—	—	130 lbs.	22.2
WW2436PF33LW Lam/Wood	3526	24	36 1/16	28 1/16	—	—	130 lbs.	22.2
WW2436PF33L Laminate	2266	24	36 1/16	28 1/16	—	—	130 lbs.	22.2
WW2436PF33LL TFL	1812	24	36 1/16	28 1/8	—	—	130 lbs.	22.2

- Interior dimensions of open storage are 16 3/4" W, 12" H
- Locking only on lateral file
- Random lock core (KRB, KRS) and specified lock core (KS1B, KS1S) available
- When specifying Horizon pulls, lateral files will have 2 pulls on each drawer front



**PRODUCT SPECIFICATIONS**

- Wood and laminate doors/drawers and chassis available; refer to page 358 for options
- Refer to page 363 for filing capabilities
- If specifying wood, you must specify the same finish for all options
- Wood drawers feature dowel construction
- Wood drawers feature sides and backs that are 1/2" thick, bottoms are 1/4" thick with veneer faces that are sealed and finished with a clear coat

**TO ORDER, SPECIFY:**

1. Model Number
2. Rim
3. Rim Color (laminite units only)
4. Pull
5. Locking
6. Top Finish (laminite units only)
7. Drawer Finish (laminite units only)
8. Chassis Finish

**SAMPLE MODEL NUMBERS:**

WW2436PFHW C 7MB KS1B MC  
 WW2436PFHL VMH 7MB KS1B 480 480  
 WW2436PFHLW V 440 7MB KS1B MH

• See pages 356-361 for all options available in WaveWorks

	MODEL NO./DESCRIPTION	LIST PRICE	DIMENSIONS					CARTONED CUBIC			
			D	W	H	A	KW	WEIGHT	FEET		
<b>MULTI-FILE STORAGE CABINET</b>	<b>1 1/8" TOP THICKNESS</b>										
	<b>FILE DRAWER ON LEFT</b>	<b>FILE DRAWER ON RIGHT</b>									
	WWN2436PF11W	WWN2436PF10W	Wood	\$ 4452	24	36 1/16	29 3/8	—	—	130 lbs.	22.2
	WWN2436PF11LW	WWN2436PF10LW	Lam/Wood	4452	24	36 1/16	29 3/8	—	—	130 lbs.	22.2
	WWN2436PF11L	WWN2436PF10L	Laminate	3093	24	36 1/16	29 3/8	—	—	130 lbs.	22.2

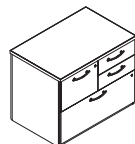

Left shown

	<b>1 1/8" TOP THICKNESS</b>										
	<b>FILE DRAWER ON LEFT</b>	<b>FILE DRAWER ON RIGHT</b>									
	WW2436PF11W	WW2436PF10W	Wood	\$ 4144	24	36 1/16	28 1/16	—	—	130 lbs.	22.2
	WW2436PF11LW	WW2436PF10LW	Lam/Wood	4144	24	36 1/16	28 1/16	—	—	130 lbs.	22.2
	WW2436PF11L	WW2436PF10L	Laminate	2891	24	36 1/16	28 1/16	—	—	130 lbs.	22.2
	WW2436PF11LL	WW2436PF10LL	TFL	2312	24	36 1/16	28 3/8	—	—	130 lbs.	22.2

- Locking only on file drawer and lateral file
- Random lock core (KRB, KRS) and specified lock core (KS2B, KS2S) available
- When specifying Horizon pulls, lateral files will have 2 pulls on each drawer front

**DOUBLE DOOR UNIT**

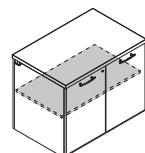

	<b>1 1/8" TOP THICKNESS</b>										
	WWN2436PFHW	Wood	\$ 3252		24	36 1/16	29 3/8	—	—	130 lbs.	22.2
	WWN2436PFHLW	Laminate/Wood	3252		24	36 1/16	29 3/8	—	—	130 lbs.	22.2
	WWN2436PFHL	Laminate	1892		24	36 1/16	29 3/8	—	—	130 lbs.	22.2
	<b>1 1/8" TOP THICKNESS</b>										
	WW2436PFHW	Wood	\$ 2954		24	36 1/16	28 1/16	—	—	130 lbs.	22.2
	WW2436PFHLW	Laminate/Wood	2954		24	36 1/16	28 1/16	—	—	130 lbs.	22.2
	WW2436PFHL	Laminate	1723		24	36 1/16	28 1/16	—	—	130 lbs.	22.2
	WW2436PFHLL	TFL	1377		24	36 1/16	28 3/8	—	—	130 lbs.	22.2

- Features an adjustable shelf
- Unit features a 110° door hinge
- Random lock core (KRB, KRS) and specified lock core (KS1B, KS1S) available

# WAVEWORKS

## PRODUCT SPECIFICATIONS

- Wood drawers feature dowel construction
- Wood drawers feature sides and backs that are ½" thick, bottoms are ¼" thick with veneer faces that are sealed and finished with a clear coat

## TO ORDER, SPECIFY:

1. Model Number
2. Pull
3. Grommet
4. Locking
5. Laminate Door Color
6. Finish/Laminate Chassis Color

## SAMPLE MODEL NUMBERS:

WW301853VPO1LW	6CC	G37PB	KRB	405	MH
WW301853VPO1LL	61R	X	KRB	405	MH
WW0653VSSPW	X	405			
WW0653VSSPL	CT1	405			

- See pages 356-361 for all options available in WaveWorks

MODEL NO./DESCRIPTION	LIST PRICE	DIMENSIONS					CARTONED WEIGHT	CUBIC FEET	
		D	W	H	A	KW			
<b>PULLOUT STORAGE</b>									
									
<b>30" DEPTH</b>									
<b>LEFT</b>			<b>RIGHT</b>						
WW301853VPO1LW	WW301853VPO1RW	Wood	\$ 6334	29½	17½	52½	—	—	lbs.
WW301853VPO1LL	WW301853VPO1RL	Laminate	4489	29½	17½	52½	—	—	lbs.
<hr/>									
WW301841VPO1LW	WW301841VPO1RW	Wood	\$ 6048	29½	17½	40½	—	—	lbs.
WW301841VPO1LL	WW301841VPO1RL	Laminate	4202	29½	17½	40½	—	—	lbs.
<hr/>									
<b>24" DEPTH</b>									
<b>LEFT</b>			<b>RIGHT</b>						
WW241853VPO1LW	WW241853VPO1RW	Wood	\$ 5761	23½	17½	52½	—	—	lbs.
WW241853VPO1LL	WW241853VPO1RL	Laminate	3914	23½	17½	52½	—	—	lbs.
<hr/>									
WW241841VPO1LW	WW241841VPO1RW	Wood	\$ 5473	23½	17½	40½	—	—	lbs.
WW241841VPO1LL	WW241841VPO1RL	Laminate	3628	23½	17½	40½	—	—	lbs.
<hr/>									
<ul style="list-style-type: none"> <li>• See pages for component top for pullout storage pages 519-520</li> <li>• Random lock core (KRB, KRS) and specified lock core (KS1B, KS1S) available</li> <li>• All WaveWorks pull options available with exception of Horizon</li> <li>• 1 coathook</li> <li>• 2 adjustable shelves</li> <li>• 1 full shelf at top where electrical is mounted</li> </ul>									

## PULLOUT STORAGE SPACER

WW0653VSSPW	Wood	\$ 946	6	17½	52½	—	—	lbs.
WW0653VSSPL	Laminate	587	6	17½	52½	—	—	lbs.
<hr/>								
WW0641VSSPW	Wood	\$ 928	6	17½	40½	—	—	lbs.
WW0641VSSPL	Laminate	568	6	17½	40½	—	—	lbs.
<hr/>								
WW1253VSSPW	Wood	\$ 1894	11½	17½	52½	—	—	lbs.
WW1253VSSPL	Laminate	1175	11½	17½	52½	—	—	lbs.
<hr/>								
WW1241VSSPW	Wood	\$ 1857	11½	17½	40½	—	—	lbs.
WW1241VSSPL	Laminate	1139	11½	17½	40½	—	—	lbs.
<hr/>								
<ul style="list-style-type: none"> <li>• Specify spacer to pass thru electrical when ganging 2 pullout storage back to back</li> <li>• Specify grommet cutout option and finish/laminate only</li> <li>• Can be used with Alloy</li> </ul>								

**PRODUCT SPECIFICATIONS**

- Wood, laminate or glass doors and wood or laminate chassis available; refer to page 358 for options
- Refer to page 363 for filing capabilities
- If specifying wood, you must specify the same finish for all options

**TO ORDER, SPECIFY:**

1. Model Number
2. Locking
3. Door Frame Color (glass door models)
4. Veneer Door Finish/Laminate Door Color (laminate/combo models)
5. Veneer Chassis Finish/  
Laminate Chassis Color

**SAMPLE MODEL NUMBERS:**

WWN1880VSWHLW	KRB	MH	
WWN1880VSWHLL	KRB	405	405
WWN1880VSWHLGW	503	MH	
WWN1880VSWHLGL	503	405	

• See pages 356-361 for all options available in WaveWorks

**WARDROBE/STORAGE CABINET  
SINGLE DOOR**

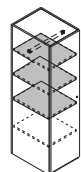
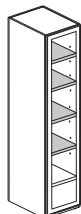

Left shown

MODEL NO./DESCRIPTION	LIST PRICE	DIMENSIONS					CARTONED CUBIC WEIGHT	CUBIC FEET			
		D	W	H	A	KW					
<b>INTENDED FOR USE WITH 1 1/8" THICK WORKSURFACE MODELS</b>											
<b>LEFT HINGED</b>			<b>RIGHT HINGED</b>								
WWN1880VSWHLGW		WWN1880VSWHRGW	Glass/Wood	\$ 5070	23 3/16	17 1/16	79 1/16	—	—	197 lbs.	31.0
WWN1880VSWHLGL		WWN1880VSWHRGL	Glass/Lam	3255	23 3/16	17 1/16	79 1/16	—	—	197 lbs.	31.0
WWN1880VSWHLW		WWN1880VSWHRW	Wood	3893	23 3/16	17 1/16	79 1/16	—	—	197 lbs.	31.0
WWN1880VSWHLL		WWN1880VSWHRL	Laminate	2203	23 3/16	17 1/16	79 1/16	—	—	197 lbs.	31.0
<b>INTENDED FOR USE WITH 1 1/8" THICK WORKSURFACE MODELS</b>											
<b>LEFT HINGED</b>			<b>RIGHT HINGED</b>								
WWN1869VSWHLGW		WWN1869VSWHRGW	Glass/Wood	\$ 4428	23 3/16	17 1/16	67 1/4	—	—	160 lbs.	26.7
WWN1869VSWHLGL		WWN1869VSWHRGL	Glass/Lam	2841	23 3/16	17 1/16	67 1/4	—	—	160 lbs.	26.7
WWN1869VSWHLW		WWN1869VSWHRW	Wood	3414	23 3/16	17 1/16	67 1/4	—	—	160 lbs.	26.7
WWN1869VSWHLL		WWN1869VSWHRL	Laminate	1934	23 3/16	17 1/16	67 1/4	—	—	160 lbs.	26.7
<b>INTENDED FOR USE WITH 1 1/8" THICK WORKSURFACE MODELS</b>											
<b>LEFT HINGED</b>			<b>RIGHT HINGED</b>								
WW1879VSWHLGW		WW1879VSWHRGW	Glass/Wood	\$ 5070	23 3/16	17 1/16	79 1/4	—	—	197 lbs.	31.0
WW1879VSWHLGL		WW1879VSWHRGL	Glass/Lam	3255	23 3/16	17 1/16	79 1/4	—	—	197 lbs.	31.0
WW1879VSWHLW		WW1879VSWHRW	Wood	3893	23 3/16	17 1/16	79 1/4	—	—	197 lbs.	31.0
WW1879VSWHLL		WW1879VSWHRL	Laminate	2203	23 3/16	17 1/16	79 1/4	—	—	197 lbs.	31.0
<b>INTENDED FOR USE WITH 1 1/8" THICK WORKSURFACE MODELS</b>											
<b>LEFT HINGED</b>			<b>RIGHT HINGED</b>								
WW1868VSWHLGW		WW1868VSWHRGW	Glass/Wood	\$ 4428	23 3/16	17 1/16	66 7/8	—	—	160 lbs.	26.7
WW1868VSWHLGL		WW1868VSWHRGL	Glass/Lam	2841	23 3/16	17 1/16	66 7/8	—	—	160 lbs.	26.7
WW1868VSWHLW		WW1868VSWHRW	Wood	3414	23 3/16	17 1/16	66 7/8	—	—	160 lbs.	26.7
WW1868VSWHLL		WW1868VSWHRL	Laminate	1934	23 3/16	17 1/16	66 7/8	—	—	160 lbs.	26.7

- Can be used as a wardrobe unit by removing adjustable shelves
- Removable coat rod standard
- Shaded shelves are adjustable, 1868 and 1869 models have 1 fixed shelf and 3 adjustable shelves, 1879 and 1880 models have 1 fixed shelf and 4 adjustable shelves
- Glass doors do not lock
- Random lock core (KRB, KRS) and specified lock core (KS1B, KS1S) available
- Almond Horizontal (ADH), Portobello Horizontal (PBH), Portico Horizontal (PTH), Skyline Horizontal (SKH), Sonoma Horizontal (SMH), Designer White Linear Horizontal (491H), Cinder Linear Horizontal (492H) and Sable Horizontal (792H) laminate options available on models 60" H or less

WAVEWORKS

ASSEMBLED

# WAVEWORKS

## PRODUCT SPECIFICATIONS

- Wood, laminate or glass doors and wood or laminate chassis available; refer to page 358 for options
- Refer to page 363 for filing capabilities
- If specifying wood, you must specify the same finish for all options

## TO ORDER, SPECIFY:

1. Model Number
2. Locking
3. Door Frame Color (glass door models)
4. Veneer Door Finish/Laminate Door Color (laminate/combo models)
5. Veneer Chassis Finish/Laminate Chassis Color

## SAMPLE MODEL NUMBERS:

WWN1880VSHLW	KRB	MH	
WWN1880VSHLL	KRB	405	405
WWN1880VSHLGW	503	MH	
WWN1880VSHLGL	503	405	

- See pages 356-361 for all options available in WaveWorks

### MEDIA STORAGE TOWER SINGLE DOOR

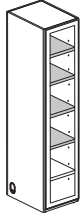

MODEL NO./DESCRIPTION	LIST PRICE	DIMENSIONS					CARTONED CUBIC	
		D	W	H	A	KW	WEIGHT	FEET
<b>LEFT HINGED</b>								
<b>RIGHT HINGED</b>								
WWN1880VSHLW	\$ 4222	23 <sup>3</sup> / <sub>16</sub>	17 <sup>1</sup> / <sub>16</sub>	79 <sup>3</sup> / <sub>4</sub>	—	—	197 lbs.	31.0
WWN1880VSHLL	2508	23 <sup>3</sup> / <sub>16</sub>	17 <sup>1</sup> / <sub>16</sub>	79 <sup>3</sup> / <sub>4</sub>	—	—	197 lbs.	31.0
WWN1880VSHLGW	5425	23 <sup>3</sup> / <sub>16</sub>	17 <sup>1</sup> / <sub>16</sub>	79 <sup>3</sup> / <sub>4</sub>	—	—	197 lbs.	31.0
WWN1880VSHLGL	3577	23 <sup>3</sup> / <sub>16</sub>	17 <sup>1</sup> / <sub>16</sub>	79 <sup>3</sup> / <sub>4</sub>	—	—	197 lbs.	31.0

- Glass units feature opaque glass with aluminum frame
- Shaded shelves are adjustable 1 fixed and 4 adjustable shelves
- Shortened shelves allow for easy wire access in the back of the cabinet
- Features grommets in end panels for wire access
- Glass doors do not lock
- Random lock core (KRB, KRS) and specified lock core (KS1B, KS1S) available
- Almond Horizontal (ADH), Portobello Horizontal (PBH), Portico Horizontal (PTH), Skyline Horizontal (SKH), Sonoma Horizontal (SMH), Designer White Linear Horizontal (491H), Cinder Linear Horizontal (492H) and Sable Horizontal (792H) laminate options available on models 60" H or less

### STORAGE/WARDROBE WITH FILE/FILE PEDESTAL

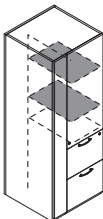

Left shown

#### INTENDED FOR USE WITH 1<sup>3</sup>/<sub>16</sub>" THICK WORKSURFACE MODELS

MODEL NO./DESCRIPTION	LIST PRICE	DIMENSIONS					CARTONED CUBIC	
		D	W	H	A	KW	WEIGHT	FEET
<b>LEFT HINGED</b>								
<b>RIGHT HINGED</b>								
WWN2480VHHL2W	\$ 5313	23 <sup>3</sup> / <sub>16</sub>	24	79 <sup>1</sup> / <sub>16</sub>	—	—	250 lbs.	31.3
WWN2480VHHL2L	3373	23 <sup>3</sup> / <sub>16</sub>	24	79 <sup>1</sup> / <sub>16</sub>	—	—	250 lbs.	31.3
WWN2469VHHL2W	\$ 4820	23 <sup>3</sup> / <sub>16</sub>	24	67 <sup>3</sup> / <sub>4</sub>	—	—	213 lbs.	27.0
WWN2469VHHL2L	3095	23 <sup>3</sup> / <sub>16</sub>	24	67 <sup>3</sup> / <sub>4</sub>	—	—	213 lbs.	27.0

#### INTENDED FOR USE WITH 1<sup>3</sup>/<sub>16</sub>" THICK WORKSURFACE MODELS

MODEL NO./DESCRIPTION	LIST PRICE	DIMENSIONS					CARTONED CUBIC	
		D	W	H	A	KW	WEIGHT	FEET
<b>LEFT HINGED</b>								
<b>RIGHT HINGED</b>								
WW2479VHHL2W	\$ 5313	23 <sup>3</sup> / <sub>16</sub>	24	79 <sup>3</sup> / <sub>4</sub>	—	—	250 lbs.	31.3
WW2479VHHL2L	3373	23 <sup>3</sup> / <sub>16</sub>	24	79 <sup>3</sup> / <sub>4</sub>	—	—	250 lbs.	31.3
WW2468VHHL2W	\$ 4820	23 <sup>3</sup> / <sub>16</sub>	24	66 <sup>7</sup> / <sub>8</sub>	—	—	213 lbs.	27.0
WW2468VHHL2L	3095	23 <sup>3</sup> / <sub>16</sub>	24	66 <sup>7</sup> / <sub>8</sub>	—	—	213 lbs.	27.0

- Removable coat rod is standard
- Storage cabinet contains 2 adjustable shelves in 2468 and 2469 models and 3 adjustable shelves in the 2479 and 2480 models
- Wardrobe door is 5<sup>1</sup>/<sub>2</sub>" wide, interior width is 5"
- Random lock core (KRB, KRS) and specified lock core (KS2B, KS2S) available
- Almond Horizontal (ADH), Portobello Horizontal (PBH), Portico Horizontal (PTH), Skyline Horizontal (SKH), Sonoma Horizontal (SMH), Designer White Linear Horizontal (491H), Cinder Linear Horizontal (492H) and Sable Horizontal (792H) laminate options available on models 60" H or less

**PRODUCT SPECIFICATIONS**

- Wood and laminate doors/drawers and chassis available; refer to page 358 for options
- Refer to page 363 for filing capabilities
- If specifying wood, you must specify the same finish for all options

**TO ORDER, SPECIFY:**

1. Model Number
2. Pull
3. Locking
4. Veneer Door Finish/Laminate Door Color (laminate/combo models)
5. Veneer Chassis Finish/Laminate Chassis Color

**SAMPLE MODEL NUMBERS:**

WWN2480VBWHL2W 7SN KS1B HN  
 WWN2480VBWHL2L 7SN KS1B 461 461

- See pages 356-361 for all options available in WaveWorks

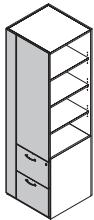
STORAGE SIDE BOOKCASE/WARDROBE WITH FILE/FILE PEDESTAL	MODEL NO./DESCRIPTION		LIST PRICE	DIMENSIONS				CARTONED CUBIC			
	LEFT HINGED	RIGHT HINGED		D	W	H	A	KW	WEIGHT	FEET	
 <p>Left shown with Wood/Laminate</p>	<b>INTENDED FOR USE WITH 1 1/4" THICK WORKSURFACE MODELS</b>										
	<b>LEFT HINGED</b>										
	WWN2480VBWHL2W	WWN2480VBWHR2W	Wood	\$ 5567	23 3/16	24	79 1/16	—	—	250 lbs.	31.3
	WWN2480VBWHL2L	WWN2480VBWHR2L	Laminate	3631	23 3/16	24	79 1/16	—	—	250 lbs.	31.3
	<b>RIGHT HINGED</b>										
	WWN2469VBWHL2W	WWN2469VBWHR2W	Wood	\$ 5075	23 3/16	24	67 1/4	—	—	213 lbs.	27.0
	WWN2469VBWHL2L	WWN2469VBWHR2L	Laminate	3353	23 3/16	24	67 1/4	—	—	213 lbs.	27.0
	<b>INTENDED FOR USE WITH 1 1/4" THICK WORKSURFACE MODELS</b>										
<b>LEFT HINGED</b>											
WW2479VBWHL2W	WW2479VBWHR2W	Wood	\$ 5567	23 3/16	24	79 3/4	—	—	250 lbs.	31.3	
WW2479VBWHL2L	WW2479VBWHR2L	Laminate	3631	23 3/16	24	79 3/4	—	—	250 lbs.	31.3	
<b>RIGHT HINGED</b>											
WW2468VBWHL2W	WW2468VBWHR2W	Wood	\$ 5075	23 3/16	24	66 3/4	—	—	213 lbs.	27.0	
WW2468VBWHL2L	WW2468VBWHR2L	Laminate	3353	23 3/16	24	66 3/4	—	—	213 lbs.	27.0	

- Removable coat rod is standard
- Open bookcase contains 2 adjustable shelves in 2468 and 2469 models and 3 adjustable shelves in the 2479 and 2480 models
- Wardrobe door is 5 1/2" wide, interior width is 5"
- Random lock core (KRB, KRS) and specified lock core (KS1B, KS1S) available
- Wardrobe door features a standard pull
- Almond Horizontal (ADH), Portobello Horizontal (PBH), Portico Horizontal (PTH), Skyline Horizontal (SKH), Sonoma Horizontal (SMH), Designer White Linear Horizontal (491H), Cinder Linear Horizontal (492H) and Sable Horizontal (792H) laminate options available on models 60" H or less

# WAVEWORKS

## PRODUCT SPECIFICATIONS

- Wood, laminate or glass doors and wood or laminate drawer fronts and chassis available; refer to page 358 for options
- Refer to page 363 for filing capabilities
- If specifying wood, you must specify the same finish for all options

## TO ORDER, SPECIFY:

1. Model Number
2. Pull
3. Locking
4. Veneer Door-Drawer Finish/Laminate Door-Drawer Color (laminate/combo models)
5. Veneer Chassis Finish/Laminate Chassis Color

## SAMPLE MODEL NUMBERS:

WWN1880VBL2W 7SN KS1B HN  
 WWN1880VBR2L 7SN KS1B 461 461

- See pages 356-361 for all options available in WaveWorks

MODEL NO./DESCRIPTION	LIST PRICE	DIMENSIONS					CARTONED WEIGHT	CUBIC FEET
		D	W	H	A	KW		
<b>STORAGE SIDE BOOKCASE WITH FILE/FILE PEDESTAL</b>								
<b>INTENDED FOR USE WITH 1<sup>5</sup>/<sub>16</sub>" THICK WORKSURFACE MODELS</b>								
<b>LEFT UNIT</b>								
WWN1880VBL2W	Wood \$ 4211	23 <sup>3</sup> / <sub>16</sub>	17 <sup>1</sup> / <sub>16</sub>	79 <sup>1</sup> / <sub>16</sub>	—	—	207 lbs.	31.0
WWN1880VBL2L	Laminate 2476	23 <sup>3</sup> / <sub>16</sub>	17 <sup>1</sup> / <sub>16</sub>	79 <sup>1</sup> / <sub>16</sub>	—	—	207 lbs.	31.0
<b>RIGHT UNIT</b>								
WWN1869VBL2W	Wood \$ 3721	23 <sup>3</sup> / <sub>16</sub>	17 <sup>1</sup> / <sub>16</sub>	67 <sup>1</sup> / <sub>4</sub>	—	—	175 lbs.	26.7
WWN1869VBL2L	Laminate 2203	23 <sup>3</sup> / <sub>16</sub>	17 <sup>1</sup> / <sub>16</sub>	67 <sup>1</sup> / <sub>4</sub>	—	—	175 lbs.	26.7
<b>INTENDED FOR USE WITH 1<sup>5</sup>/<sub>16</sub>" THICK WORKSURFACE MODELS</b>								
<b>LEFT UNIT</b>								
WW1879VBL2W	Wood \$ 4211	23 <sup>3</sup> / <sub>16</sub>	17 <sup>1</sup> / <sub>16</sub>	79 <sup>1</sup> / <sub>4</sub>	—	—	207 lbs.	31.0
WW1879VBL2L	Laminate 2476	23 <sup>3</sup> / <sub>16</sub>	17 <sup>1</sup> / <sub>16</sub>	79 <sup>1</sup> / <sub>4</sub>	—	—	207 lbs.	31.0
<b>RIGHT UNIT</b>								
WW1868VBL2W	Wood \$ 3721	23 <sup>3</sup> / <sub>16</sub>	17 <sup>1</sup> / <sub>16</sub>	66 <sup>7</sup> / <sub>8</sub>	—	—	175 lbs.	26.7
WW1868VBL2L	Laminate 2203	23 <sup>3</sup> / <sub>16</sub>	17 <sup>1</sup> / <sub>16</sub>	66 <sup>7</sup> / <sub>8</sub>	—	—	175 lbs.	26.7

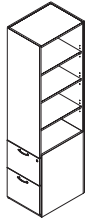

Left shown

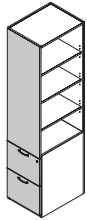

Left shown with Wood/Laminate

- Open bookcase contains 2 adjustable shelves in 1868 and 1869 models and 3 adjustable shelves in the 1879 and 1880 models
- Shaded area denotes wood drawer fronts and wood panel
- Random lock core (KRB, KRS) and specified lock core (KS1B, KS1S) available
- Almond Horizontal (ADH), Portobello Horizontal (PBH), Portico Horizontal (PTH), Skyline Horizontal (SKH), Sonoma Horizontal (SMH), Designer White Linear Horizontal (491H), Cinder Linear Horizontal (492H) and Sable Horizontal (792H) laminate options available on models 60" H or less

**PRODUCT SPECIFICATIONS**

- Wood, laminate or glass doors and wood or laminate drawer fronts and chassis available; refer to page 358 for options
- Refer to page 363 for filing capabilities
- If specifying wood, you must specify the same finish for all options

**TO ORDER, SPECIFY:**

1. Model Number
2. Locking
3. Door Frame Color (glass door models)
4. Veneer Door-Drawer Finish/Laminate Door-Drawer Color (laminate/combo models)
5. Veneer Chassis Finish/Laminate Chassis Color

**SAMPLE MODEL NUMBERS:**

WW3680VSWHGW 501 MH  
 WW3680VSWHW KS1B MH  
 WW3680VSWHL KS1B MH MH

- See pages 356-361 for all options available in WaveWorks

MODEL NO./DESCRIPTION	LIST PRICE	DIMENSIONS				KW	CARTONED WEIGHT	CUBIC FEET
		D	W	H	A			
<b>WARDROBE/STORAGE CABINET DOUBLE DOOR</b>								
<b>INTENDED FOR USE WITH 1<sup>1</sup>/<sub>6</sub>" THICK WORKSURFACE MODELS</b>								
WWN3680VSWHGW Glass/Wood	\$ 8205	23 <sup>3</sup> / <sub>16</sub>	35 <sup>5</sup> / <sub>8</sub>	79 <sup>1</sup> / <sub>16</sub>	—	—	345 lbs.	51.4
WWN3680VSWHGL Glass/Laminate	5269	23 <sup>3</sup> / <sub>16</sub>	35 <sup>5</sup> / <sub>8</sub>	79 <sup>1</sup> / <sub>16</sub>	—	—	345 lbs.	51.4
WWN3680VSWHW Wood	7785	23 <sup>3</sup> / <sub>16</sub>	35 <sup>5</sup> / <sub>8</sub>	79 <sup>1</sup> / <sub>16</sub>	—	—	345 lbs.	51.4
WWN3680VSWHL Laminate	4408	23 <sup>3</sup> / <sub>16</sub>	35 <sup>5</sup> / <sub>8</sub>	79 <sup>1</sup> / <sub>16</sub>	—	—	345 lbs.	51.4
<b>INTENDED FOR USE WITH 1<sup>1</sup>/<sub>6</sub>" THICK WORKSURFACE MODELS</b>								
WWN3669VSWHGW Glass/Wood	\$ 7113	23 <sup>3</sup> / <sub>16</sub>	35 <sup>5</sup> / <sub>8</sub>	67 <sup>1</sup> / <sub>4</sub>	—	—	160 lbs.	44.1
WWN3669VSWHGL Glass/Laminate	4565	23 <sup>3</sup> / <sub>16</sub>	35 <sup>5</sup> / <sub>8</sub>	67 <sup>1</sup> / <sub>4</sub>	—	—	160 lbs.	44.1
WWN3669VSWHW Wood	6828	23 <sup>3</sup> / <sub>16</sub>	35 <sup>5</sup> / <sub>8</sub>	67 <sup>1</sup> / <sub>4</sub>	—	—	160 lbs.	44.1
WWN3669VSWHL Laminate	3865	23 <sup>3</sup> / <sub>16</sub>	35 <sup>5</sup> / <sub>8</sub>	67 <sup>1</sup> / <sub>4</sub>	—	—	160 lbs.	44.1
<b>INTENDED FOR USE WITH 1<sup>1</sup>/<sub>6</sub>" THICK WORKSURFACE MODELS</b>								
WW3679VSWHGW Glass/Wood	\$ 8205	23 <sup>3</sup> / <sub>16</sub>	35 <sup>5</sup> / <sub>8</sub>	79 <sup>1</sup> / <sub>4</sub>	—	—	345 lbs.	51.4
WW3679VSWHGL Glass/Laminate	5269	23 <sup>3</sup> / <sub>16</sub>	35 <sup>5</sup> / <sub>8</sub>	79 <sup>1</sup> / <sub>4</sub>	—	—	345 lbs.	51.4
WW3679VSWHW Wood	7785	23 <sup>3</sup> / <sub>16</sub>	35 <sup>5</sup> / <sub>8</sub>	79 <sup>1</sup> / <sub>4</sub>	—	—	345 lbs.	51.4
WW3679VSWHL Laminate	4408	23 <sup>3</sup> / <sub>16</sub>	35 <sup>5</sup> / <sub>8</sub>	79 <sup>1</sup> / <sub>4</sub>	—	—	345 lbs.	51.4
<b>INTENDED FOR USE WITH 1<sup>1</sup>/<sub>6</sub>" THICK WORKSURFACE MODELS</b>								
WW3668VSWHGW Glass/Wood	\$ 7113	23 <sup>3</sup> / <sub>16</sub>	35 <sup>5</sup> / <sub>8</sub>	66 <sup>5</sup> / <sub>8</sub>	—	—	160 lbs.	44.1
WW3668VSWHGL Glass/Laminate	4565	23 <sup>3</sup> / <sub>16</sub>	35 <sup>5</sup> / <sub>8</sub>	66 <sup>5</sup> / <sub>8</sub>	—	—	160 lbs.	44.1
WW3668VSWHW Wood	6828	23 <sup>3</sup> / <sub>16</sub>	35 <sup>5</sup> / <sub>8</sub>	66 <sup>5</sup> / <sub>8</sub>	—	—	160 lbs.	44.1
WW3668VSWHL Laminate	3865	23 <sup>3</sup> / <sub>16</sub>	35 <sup>5</sup> / <sub>8</sub>	66 <sup>5</sup> / <sub>8</sub>	—	—	160 lbs.	44.1

**WARDROBE/STORAGE CABINET DOUBLE DOOR**

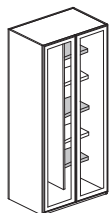

- Coat rod standard
- Shaded shelves are adjustable, 3668 and 3669 models have 1 fixed and 3 adjustable shelves, 3679 and 3680 models have 2 fixed and 3 adjustable shelves
- Glass doors do not lock
- Random lock core (KRB, KRS) and specified lock core (KS1B, KS1S) available
- Almond Horizontal (ADH), Portobello Horizontal (PBH), Portico Horizontal (PTH), Skyline Horizontal (SKH), Sonoma Horizontal (SMH), Designer White Linear Horizontal (491H), Cinder Linear Horizontal (492H) and Sable Horizontal (792H) laminate options available on models 60" H or less

WAVEWORKS

ASSEMBLED

# WAVEWORKS

## PRODUCT SPECIFICATIONS

- Wood, laminate or glass doors and wood or laminate drawer fronts and chassis available; refer to page 358 for options
- Refer to page 363 for filing capabilities
- If specifying wood, you must specify the same finish for all options

## TO ORDER, SPECIFY:

1. Model Number
2. Locking
3. Door Frame Color (glass door models)
4. Veneer Door-Drawer Finish/Laminate Door-Drawer Color (laminate/combo models)
5. Veneer Chassis Finish/Laminate Chassis Color

## SAMPLE MODEL NUMBERS:

WWN3680VSHGW 501 MH  
 WWN3680VSHW KS1B MH  
 WWN3680VSHL KS1B MH MH

- See pages 356-361 for all options available in WaveWorks

## DOUBLE DOOR STORAGE CABINET

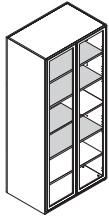
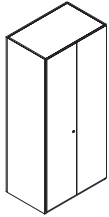

MODEL NO./DESCRIPTION	LIST PRICE	DIMENSIONS					CARTONED WEIGHT	CUBIC FEET
		D	W	H	A	KW		
<b>INTENDED FOR USE WITH 1<sup>5</sup>/<sub>16</sub>" THICK WORKSURFACE MODELS</b>								
WWN3680VSHGW Glass/Wood	\$ 7624	23 <sup>3</sup> / <sub>16</sub>	35 <sup>5</sup> / <sub>16</sub>	79 <sup>1</sup> / <sub>16</sub>	—	—	345 lbs.	51.4
WWN3680VSHGL Glass/Laminate	4675	23 <sup>3</sup> / <sub>16</sub>	35 <sup>5</sup> / <sub>16</sub>	79 <sup>1</sup> / <sub>16</sub>	—	—	345 lbs.	51.4
WWN3680VSHW Wood	7200	23 <sup>3</sup> / <sub>16</sub>	35 <sup>5</sup> / <sub>16</sub>	79 <sup>1</sup> / <sub>16</sub>	—	—	345 lbs.	51.4
WWN3680VSHL Laminate	3818	23 <sup>3</sup> / <sub>16</sub>	35 <sup>5</sup> / <sub>16</sub>	79 <sup>1</sup> / <sub>16</sub>	—	—	345 lbs.	51.4
<b>INTENDED FOR USE WITH 1<sup>5</sup>/<sub>16</sub>" THICK WORKSURFACE MODELS</b>								
WWN3669VSHGW Glass/Wood	\$ 6531	23 <sup>3</sup> / <sub>16</sub>	35 <sup>5</sup> / <sub>16</sub>	67 <sup>1</sup> / <sub>4</sub>	—	—	160 lbs.	44.1
WWN3669VSHGL Glass/Laminate	3979	23 <sup>3</sup> / <sub>16</sub>	35 <sup>5</sup> / <sub>16</sub>	67 <sup>1</sup> / <sub>4</sub>	—	—	160 lbs.	44.1
WWN3669VSHW Wood	6248	23 <sup>3</sup> / <sub>16</sub>	35 <sup>5</sup> / <sub>16</sub>	67 <sup>1</sup> / <sub>4</sub>	—	—	160 lbs.	44.1
WWN3669VSHL Laminate	3277	23 <sup>3</sup> / <sub>16</sub>	35 <sup>5</sup> / <sub>16</sub>	67 <sup>1</sup> / <sub>4</sub>	—	—	160 lbs.	44.1
<b>INTENDED FOR USE WITH 1<sup>5</sup>/<sub>16</sub>" THICK WORKSURFACE MODELS</b>								
WW3679VSHGW Glass/Wood	\$ 7624	23 <sup>3</sup> / <sub>16</sub>	35 <sup>5</sup> / <sub>16</sub>	79 <sup>1</sup> / <sub>4</sub>	—	—	345 lbs.	51.4
WW3679VSHGL Glass/Laminate	4675	23 <sup>3</sup> / <sub>16</sub>	35 <sup>5</sup> / <sub>16</sub>	79 <sup>1</sup> / <sub>4</sub>	—	—	345 lbs.	51.4
WW3679VSHW Wood	7200	23 <sup>3</sup> / <sub>16</sub>	35 <sup>5</sup> / <sub>16</sub>	79 <sup>1</sup> / <sub>4</sub>	—	—	345 lbs.	51.4
WW3679VSHL Laminate	3818	23 <sup>3</sup> / <sub>16</sub>	35 <sup>5</sup> / <sub>16</sub>	79 <sup>1</sup> / <sub>4</sub>	—	—	345 lbs.	51.4
<b>INTENDED FOR USE WITH 1<sup>5</sup>/<sub>16</sub>" THICK WORKSURFACE MODELS</b>								
WW3668VSHGW Glass/Wood	\$ 6531	23 <sup>3</sup> / <sub>16</sub>	35 <sup>5</sup> / <sub>16</sub>	66 <sup>7</sup> / <sub>8</sub>	—	—	160 lbs.	44.1
WW3668VSHGL Glass/Laminate	3979	23 <sup>3</sup> / <sub>16</sub>	35 <sup>5</sup> / <sub>16</sub>	66 <sup>7</sup> / <sub>8</sub>	—	—	160 lbs.	44.1
WW3668VSHW Wood	6248	23 <sup>3</sup> / <sub>16</sub>	35 <sup>5</sup> / <sub>16</sub>	66 <sup>7</sup> / <sub>8</sub>	—	—	160 lbs.	44.1
WW3668VSHL Laminate	3277	23 <sup>3</sup> / <sub>16</sub>	35 <sup>5</sup> / <sub>16</sub>	66 <sup>7</sup> / <sub>8</sub>	—	—	160 lbs.	44.1

- 3668 and 3669 models have 2 fixed and 2 adjustable shelves, 3679 and 3680 models have 2 fixed and 3 adjustable shelves
- Units includes shelves from top to bottom, see above bullet for correct number of shelves according to size
- Glass doors do not lock
- Random lock core (KRB, KRS) and specified lock core (KS1B, KS1S) available
- Almond Horizontal (ADH), Portobello Horizontal (PBH), Portico Horizontal (PTH), Skyline Horizontal (SKH), Sonoma Horizontal (SMH), Designer White Linear Horizontal (491H), Cinder Linear Horizontal (492H) and Sable Horizontal (792H) laminate options available on models 60" H or less

WAVEWORKS

ASSEMBLED



**PRODUCT SPECIFICATIONS**

- Wood, laminate or glass doors and wood or laminate drawer fronts and chassis available; refer to page 358 for options
- Refer to page 363 for filing capabilities
- If specifying wood, you must specify the same finish for all options

**TO ORDER, SPECIFY:**

1. Model Number
2. Pull
3. Locking
4. Door Frame Color (glass door models)
5. Veneer Door-Drawer Finish/Laminate Door-Drawer Color (laminate/combo models)
6. Veneer Chassis Finish/Laminate Chassis Color

**SAMPLE MODEL NUMBERS:**

WWN3680VHF2GW 501 MH  
 WWN3680VHF2W KS1B MH  
 WWN3680VHF2L KS1B MH MH

- See pages 356-361 for all options available in WaveWorks

**STORAGE/LATERAL FILE CABINET**

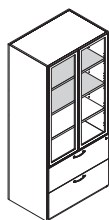
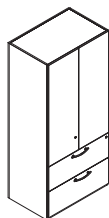

MODEL NO./DESCRIPTION	LIST PRICE	DIMENSIONS					CARTONED WEIGHT	CUBIC FEET
		D	W	H	A	KW		
<b>INTENDED FOR USE WITH 1 3/8" THICK WORKSURFACE MODELS</b>								
WWN3680VHF2GW Glass/Wood	\$ 7798	23 3/16	35 3/8	79 1/16	—	—	345 lbs.	56.5
WWN3680VHF2GL Glass/Laminate	4789	23 3/16	35 3/8	79 1/16	—	—	345 lbs.	56.5
WWN3680VHF2W Wood	7306	23 3/16	35 3/8	79 1/16	—	—	345 lbs.	56.5
WWN3680VHF2L Laminate	3879	23 3/16	35 3/8	79 1/16	—	—	345 lbs.	56.5
<b>INTENDED FOR USE WITH 1 3/8" THICK WORKSURFACE MODELS</b>								
WWN3669VHF2GW Glass/Wood	\$ 6692	23 3/16	35 3/8	67 1/4	—	—	160 lbs.	48.6
WWN3669VHF2GL Glass/Laminate	4079	23 3/16	35 3/8	67 1/4	—	—	160 lbs.	48.6
WWN3669VHF2W Wood	6336	23 3/16	35 3/8	67 1/4	—	—	160 lbs.	48.6
WWN3669VHF2L Laminate	3331	23 3/16	35 3/8	67 1/4	—	—	160 lbs.	48.6
<b>INTENDED FOR USE WITH 1 3/8" THICK WORKSURFACE MODELS</b>								
WW3679VHF2GW Glass/Wood	\$ 7798	23 3/16	35 3/8	79 3/4	—	—	345 lbs.	56.5
WW3679VHF2GL Glass/Laminate	4789	23 3/16	35 3/8	79 3/4	—	—	345 lbs.	56.5
WW3679VHF2W Wood	7306	23 3/16	35 3/8	79 3/4	—	—	345 lbs.	56.5
WW3679VHF2L Laminate	3879	23 3/16	35 3/8	79 3/4	—	—	345 lbs.	56.5
<b>INTENDED FOR USE WITH 1 3/8" THICK WORKSURFACE MODELS</b>								
WW3668VHF2GW Glass/Wood	\$ 6692	23 3/16	35 3/8	66 3/8	—	—	160 lbs.	48.6
WW3668VHF2GL Glass/Laminate	4079	23 3/16	35 3/8	66 3/8	—	—	160 lbs.	48.6
WW3668VHF2W Wood	6336	23 3/16	35 3/8	66 3/8	—	—	160 lbs.	48.6
WW3668VHF2L Laminate	3331	23 3/16	35 3/8	66 3/8	—	—	160 lbs.	48.6

- 3679 and 3680 models have 1 fixed and 2 adjustable shelves, 3668 and 3669 models have 1 fixed and 1 adjustable shelf
- For glass/wood or glass/laminate units: random lock core (KRB, KRS) and specified lock core (KS1B, KS1S) available
- For wood, wood/laminate or laminate units: random lock core (KRB, KRS) and specified lock core (KS2B, KS2S) available
- When specifying Horizon pulls, lateral files will have 2 pulls on each drawer front
- Almond Horizontal (ADH), Portobello Horizontal (PBH), Portico Horizontal (PTH), Skyline Horizontal (SKH), Sonoma Horizontal (SMH), Designer White Linear Horizontal (491H), Cinder Linear Horizontal (492H) and Sable Horizontal (792H) laminate options available on models 60" H or less

WAVEWORKS

ASSEMBLED

# WAVEWORKS

## PRODUCT SPECIFICATIONS

- Wood, laminate or glass doors and wood or laminate drawer fronts and chassis available; refer to page 358 for options
- Refer to page 363 for filing capabilities
- Tops of units are finished with flat edge detail
- Adjustable hinged doors
- If specifying wood, you must specify the same finish for all options

## TO ORDER, SPECIFY:

1. Model Number
2. Pull
3. Locking
4. Door Frame Color (glass door models)
5. Veneer Door-Drawer Finish/Laminate Door-Drawer Color (laminate/combo models)
6. Veneer Chassis Finish/Laminate Chassis Color

## SAMPLE MODEL NUMBERS:

- |              |      |      |        |
|--------------|------|------|--------|
| WW1868VHL2GW | 75PL | 501  | MH     |
| WW1868VHL2GL | 75PL | 501  | 480    |
| WW1868VHL2W  | 75PL | KS2B | MH     |
| WW1868VHL2L  | 75PL | KS2B | 480 MH |
- See pages 356-361 for all options available in WaveWorks

### STORAGE CABINET WITH FILE/FILE PEDESTAL

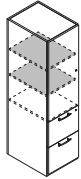
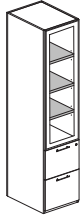

MODEL NO./DESCRIPTION		LIST PRICE	DIMENSIONS					CARTONED CUBIC		
			D	W	H	A	KW	WEIGHT	FEET	
<b>INTENDED FOR USE WITH 1<sup>3</sup>/<sub>16</sub>" THICK WORKSURFACE MODELS</b>										
<b>LEFT HINGED</b>					<b>RIGHT HINGED</b>					
WWN1880VHL2GW	WWN1880VHR2GW	Glass/Wood	\$ 5243	23 <sup>3</sup> / <sub>16</sub>	17 <sup>1</sup> / <sub>16</sub>	79 <sup>1</sup> / <sub>16</sub>	—	—	207 lbs.	31.0
WWN1880VHL2GL	WWN1880VHR2GL	Glass/Lam	3366	23 <sup>3</sup> / <sub>16</sub>	17 <sup>1</sup> / <sub>16</sub>	79 <sup>1</sup> / <sub>16</sub>	—	—	207 lbs.	31.0
WWN1880VHL2W	WWN1880VHR2W	Wood	3996	23 <sup>3</sup> / <sub>16</sub>	17 <sup>1</sup> / <sub>16</sub>	79 <sup>1</sup> / <sub>16</sub>	—	—	207 lbs.	31.0
WWN1880VHL2L	WWN1880VHR2L	Laminate	2265	23 <sup>3</sup> / <sub>16</sub>	17 <sup>1</sup> / <sub>16</sub>	79 <sup>1</sup> / <sub>16</sub>	—	—	207 lbs.	31.0
WWN1869VHL2GW	WWN1869VHR2GW	Glass/Wood	\$ 4588	23 <sup>3</sup> / <sub>16</sub>	17 <sup>1</sup> / <sub>16</sub>	67 <sup>1</sup> / <sub>4</sub>	—	—	175 lbs.	26.7
WWN1869VHL2GL	WWN1869VHR2GL	Glass/Lam	2943	23 <sup>3</sup> / <sub>16</sub>	17 <sup>1</sup> / <sub>16</sub>	67 <sup>1</sup> / <sub>4</sub>	—	—	175 lbs.	26.7
WWN1869VHL2W	WWN1869VHR2W	Wood	3508	23 <sup>3</sup> / <sub>16</sub>	17 <sup>1</sup> / <sub>16</sub>	67 <sup>1</sup> / <sub>4</sub>	—	—	175 lbs.	26.7
WWN1869VHL2L	WWN1869VHR2L	Laminate	1988	23 <sup>3</sup> / <sub>16</sub>	17 <sup>1</sup> / <sub>16</sub>	67 <sup>1</sup> / <sub>4</sub>	—	—	175 lbs.	26.7
<b>INTENDED FOR USE WITH 1<sup>3</sup>/<sub>16</sub>" THICK WORKSURFACE MODELS</b>										
<b>LEFT HINGED</b>					<b>RIGHT HINGED</b>					
WW1879VHL2GW	WW1879VHR2GW	Glass/Wood	\$ 5243	23 <sup>3</sup> / <sub>16</sub>	17 <sup>1</sup> / <sub>16</sub>	79 <sup>1</sup> / <sub>4</sub>	—	—	207 lbs.	31.0
WW1879VHL2GL	WW1879VHR2GL	Glass/Lam	3366	23 <sup>3</sup> / <sub>16</sub>	17 <sup>1</sup> / <sub>16</sub>	79 <sup>1</sup> / <sub>4</sub>	—	—	207 lbs.	31.0
WW1879VHL2W	WW1879VHR2W	Wood	3996	23 <sup>3</sup> / <sub>16</sub>	17 <sup>1</sup> / <sub>16</sub>	79 <sup>1</sup> / <sub>4</sub>	—	—	207 lbs.	31.0
WW1879VHL2L	WW1879VHR2L	Laminate	2265	23 <sup>3</sup> / <sub>16</sub>	17 <sup>1</sup> / <sub>16</sub>	79 <sup>1</sup> / <sub>4</sub>	—	—	207 lbs.	31.0
WW1868VHL2GW	WW1868VHR2GW	Glass/Wood	\$ 4588	23 <sup>3</sup> / <sub>16</sub>	17 <sup>1</sup> / <sub>16</sub>	66 <sup>7</sup> / <sub>8</sub>	—	—	175 lbs.	26.7
WW1868VHL2GL	WW1868VHR2GL	Glass/Lam	2943	23 <sup>3</sup> / <sub>16</sub>	17 <sup>1</sup> / <sub>16</sub>	66 <sup>7</sup> / <sub>8</sub>	—	—	175 lbs.	26.7
WW1868VHL2W	WW1868VHR2W	Wood	3508	23 <sup>3</sup> / <sub>16</sub>	17 <sup>1</sup> / <sub>16</sub>	66 <sup>7</sup> / <sub>8</sub>	—	—	175 lbs.	26.7
WW1868VHL2L	WW1868VHR2L	Laminate	1988	23 <sup>3</sup> / <sub>16</sub>	17 <sup>1</sup> / <sub>16</sub>	66 <sup>7</sup> / <sub>8</sub>	—	—	175 lbs.	26.7

- Shaded shelves are adjustable
- 1879 and 1880 models include 3 adjustable shelves, 1868 and 1869 models include 2 adjustable shelves
- For glass/wood or glass/laminate units: random lock core (KRB, KRS) and specified lock core (KS1B, KS1S) available
- For wood, wood/laminate or laminate units: random lock core (KRB, KRS) and specified lock core (KS2B, KS2S) available
- Almond Horizontal (ADH), Portobello Horizontal (PBH), Portico Horizontal (PTH), Skyline Horizontal (SKH), Sonoma Horizontal (SMH), Designer White Linear Horizontal (491H), Cinder Linear Horizontal (492H) and Sable Horizontal (792H) laminate options available on models 60" H or less

**PRODUCT SPECIFICATIONS**

- Laminate only; refer to page 358 for options
- Tops of units are finished with flat edge detail
- Adjustable hinged doors

**TO ORDER, SPECIFY:**

1. Model Number
2. Pull
3. Locking
4. Laminate Door-Drawer Color
5. Laminate Chassis Color

**SAMPLE MODEL NUMBER:**

WW241879VPL1LL 87MB KS1B 461 PT  
 • See pages 356-361 for all options available in WaveWorks

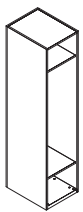
	MODEL NO./DESCRIPTION	LIST PRICE	DIMENSIONS					CARTONED WEIGHT	CUBIC FEET	
			D	W	H	A	KW			
<b>OPEN LOCKER</b> 	<b>LOCKERS/OPEN</b>									
	WW241879VPL1OL	Laminate	\$ 1880	22 <sup>3</sup> / <sub>4</sub>	17 <sup>1</sup> / <sub>16</sub>	78 <sup>1</sup> / <sub>16</sub>	—	—	—	25.8
	WW241579VPL1OL	Laminate	1880	22 <sup>3</sup> / <sub>4</sub>	14 <sup>1</sup> / <sub>16</sub>	78 <sup>1</sup> / <sub>16</sub>	—	—	—	21.8
	WW241868VPL1OL	Laminate	\$ 1612	22 <sup>3</sup> / <sub>4</sub>	17 <sup>1</sup> / <sub>16</sub>	66 <sup>7</sup> / <sub>8</sub>	—	—	—	22.3
	WW241568VPL1OL	Laminate	1612	22 <sup>3</sup> / <sub>4</sub>	14 <sup>1</sup> / <sub>16</sub>	66 <sup>7</sup> / <sub>8</sub>	—	—	—	18.9
	WW181879VPL1OL	Laminate	\$ 1824	16 <sup>7</sup> / <sub>8</sub>	17 <sup>1</sup> / <sub>16</sub>	78 <sup>1</sup> / <sub>16</sub>	—	—	—	20.3
	WW181579VPL1OL	Laminate	1824	16 <sup>7</sup> / <sub>8</sub>	14 <sup>1</sup> / <sub>16</sub>	78 <sup>1</sup> / <sub>16</sub>	—	—	—	17.2
	WW181868VPL1OL	Laminate	\$ 1552	16 <sup>7</sup> / <sub>8</sub>	17 <sup>1</sup> / <sub>16</sub>	66 <sup>7</sup> / <sub>8</sub>	—	—	—	17.5
	WW181568VPL1OL	Laminate	1552	16 <sup>7</sup> / <sub>8</sub>	14 <sup>1</sup> / <sub>16</sub>	66 <sup>7</sup> / <sub>8</sub>	—	—	—	14.8

- Lockers offered in laminate model only
- Included are 2 fixed shelves and 2 coat hooks
- If using 1 locker by itself it MUST be attached to a wall
- If using more than 1 locker side by side they MUST be ganged together
- If using more than 1 locker back to back, a cluster of 4 lockers MUST be ordered and ganged both side to side and front to back

**LOCKER 1 DOOR**



Right shown

	LOCKERS/1 DOOR		LIST PRICE	DIMENSIONS					CARTONED WEIGHT	CUBIC FEET
	LEFT HINGED	RIGHT HINGED		D	W	H	A	KW		
WW241879VPL1LL	WW241879VPL1RL	Laminate	\$ 1997	23 <sup>3</sup> / <sub>16</sub>	17 <sup>1</sup> / <sub>16</sub>	78 <sup>1</sup> / <sub>16</sub>	—	—	—	26.8
WW241579VPL1LL	WW241579VPL1RL	Laminate	1997	23 <sup>3</sup> / <sub>16</sub>	14 <sup>1</sup> / <sub>16</sub>	78 <sup>1</sup> / <sub>16</sub>	—	—	—	22.5
WW241868VPL1LL	WW241868VPL1RL	Laminate	\$ 1726	23 <sup>3</sup> / <sub>16</sub>	17 <sup>1</sup> / <sub>16</sub>	66 <sup>7</sup> / <sub>8</sub>	—	—	—	23.0
WW241568VPL1LL	WW241568VPL1RL	Laminate	1726	23 <sup>3</sup> / <sub>16</sub>	14 <sup>1</sup> / <sub>16</sub>	66 <sup>7</sup> / <sub>8</sub>	—	—	—	19.5
WW181879VPL1LL	WW181879VPL1RL	Laminate	\$ 1938	17 <sup>1</sup> / <sub>16</sub>	17 <sup>1</sup> / <sub>16</sub>	78 <sup>1</sup> / <sub>16</sub>	—	—	—	21.1
WW181579VPL1LL	WW181579VPL1RL	Laminate	1938	17 <sup>1</sup> / <sub>16</sub>	14 <sup>1</sup> / <sub>16</sub>	78 <sup>1</sup> / <sub>16</sub>	—	—	—	17.9
WW181868VPL1LL	WW181868VPL1RL	Laminate	\$ 1668	17 <sup>1</sup> / <sub>16</sub>	17 <sup>1</sup> / <sub>16</sub>	66 <sup>7</sup> / <sub>8</sub>	—	—	—	18.2
WW181568VPL1LL	WW181568VPL1RL	Laminate	1668	17 <sup>1</sup> / <sub>16</sub>	14 <sup>1</sup> / <sub>16</sub>	66 <sup>7</sup> / <sub>8</sub>	—	—	—	15.4

- Lockers offered in laminate only
- 2 fixed shelves and 2 coat hooks included
- If using 1 locker by itself it MUST be attached to a wall
- If using more than 1 locker side by side they MUST be ganged together
- If using more than 1 locker back to back, a cluster of 4 lockers MUST be ordered and ganged both side to side and front to back
- Pulls will be installed vertically. All Waveworks pull options available with the exception of Horizon
- If specifying the "no pull" option, unit will have a touch latch closure

# WAVEWORKS

## PRODUCT SPECIFICATIONS

- Laminate only; refer to page 358 for options
- Tops of units are finished with flat edge detail
- Adjustable hinged doors

## TO ORDER, SPECIFY:

1. Model Number
2. Pull
3. Locking
4. Laminate Door-Drawer Color
5. Laminate Chassis Color

## SAMPLE MODEL NUMBERS:

WW241879VPL2LL 87MB KS2B PT PT  
 WW241879VPL3LL 87MB KRB PT PT

- See pages 356-361 for all options available in WaveWorks

### LOCKER 2 DOOR

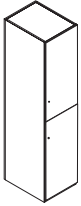

Right shown

#### MODEL NO./DESCRIPTION

#### LIST PRICE

#### DIMENSIONS

D W H A KW

#### CARTONED CUBIC

WEIGHT FEET

#### LOCKERS/2 DOOR LEFT HINGED

#### RIGHT HINGED

MODEL NO.	DESCRIPTION	LAMINATE	LIST PRICE	D	W	H	A	KW	WEIGHT	FEET
WW241879VPL2LL	WW241879VPL2RL	Laminate	\$ 2141	23 <sup>3</sup> / <sub>16</sub>	17 <sup>1</sup> / <sub>16</sub>	78 <sup>1</sup> / <sub>16</sub>	—	—	—	26.8
WW241579VPL2LL	WW241579VPL2RL	Laminate	2141	23 <sup>3</sup> / <sub>16</sub>	14 <sup>1</sup> / <sub>16</sub>	78 <sup>1</sup> / <sub>16</sub>	—	—	—	22.5
WW241868VPL2LL	WW241868VPL2RL	Laminate	\$ 1869	23 <sup>3</sup> / <sub>16</sub>	17 <sup>1</sup> / <sub>16</sub>	66 <sup>7</sup> / <sub>16</sub>	—	—	—	23.0
WW241568VPL2LL	WW241568VPL2RL	Laminate	1869	23 <sup>3</sup> / <sub>16</sub>	14 <sup>1</sup> / <sub>16</sub>	66 <sup>7</sup> / <sub>16</sub>	—	—	—	19.5
WW181879VPL2LL	WW181879VPL2RL	Laminate	\$ 2081	17 <sup>1</sup> / <sub>16</sub>	17 <sup>1</sup> / <sub>16</sub>	78 <sup>1</sup> / <sub>16</sub>	—	—	—	21.1
WW181579VPL2LL	WW181579VPL2RL	Laminate	2081	17 <sup>1</sup> / <sub>16</sub>	14 <sup>1</sup> / <sub>16</sub>	78 <sup>1</sup> / <sub>16</sub>	—	—	—	17.9
WW181868VPL2LL	WW181868VPL2RL	Laminate	\$ 1811	17 <sup>1</sup> / <sub>16</sub>	17 <sup>1</sup> / <sub>16</sub>	66 <sup>7</sup> / <sub>16</sub>	—	—	—	18.2
WW181568VPL2LL	WW181568VPL2RL	Laminate	1811	17 <sup>1</sup> / <sub>16</sub>	14 <sup>1</sup> / <sub>16</sub>	66 <sup>7</sup> / <sub>16</sub>	—	—	—	15.4

- Lockers offered in laminate only
- 2 coat hooks behind each door
- If using 1 locker by itself it MUST be attached to a wall
- If using more than 1 locker side by side they MUST be ganged together
- If using more than 1 locker back to back, a cluster of 4 lockers MUST be ordered and ganged both side to side and front to back
- Pulls will be installed vertically. All WaveWorks pull options available with the exception of Horizon
- If specifying the "no pull" option, unit will have a touch latch closure

### LOCKER 3 DOOR

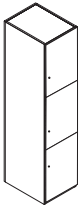

Right shown

#### LOCKERS/3 DOOR LEFT HINGED

#### RIGHT HINGED

MODEL NO.	DESCRIPTION	LAMINATE	LIST PRICE	D	W	H	A	KW	WEIGHT	FEET
WW241879VPL3LL	WW241879VPL3RL	Laminate	\$ 2284	23 <sup>3</sup> / <sub>16</sub>	17 <sup>1</sup> / <sub>16</sub>	78 <sup>1</sup> / <sub>16</sub>	—	—	—	26.8
WW241579VPL3LL	WW241579VPL3RL	Laminate	2284	23 <sup>3</sup> / <sub>16</sub>	14 <sup>1</sup> / <sub>16</sub>	78 <sup>1</sup> / <sub>16</sub>	—	—	—	22.5
WW241868VPL3LL	WW241868VPL3RL	Laminate	\$ 2013	23 <sup>3</sup> / <sub>16</sub>	17 <sup>1</sup> / <sub>16</sub>	66 <sup>7</sup> / <sub>16</sub>	—	—	—	23.0
WW241568VPL3LL	WW241568VPL3RL	Laminate	2013	23 <sup>3</sup> / <sub>16</sub>	14 <sup>1</sup> / <sub>16</sub>	66 <sup>7</sup> / <sub>16</sub>	—	—	—	19.5
WW181879VPL3LL	WW181879VPL3RL	Laminate	\$ 2225	17 <sup>1</sup> / <sub>16</sub>	17 <sup>1</sup> / <sub>16</sub>	78 <sup>1</sup> / <sub>16</sub>	—	—	—	21.1
WW181579VPL3LL	WW181579VPL3RL	Laminate	2225	17 <sup>1</sup> / <sub>16</sub>	14 <sup>1</sup> / <sub>16</sub>	78 <sup>1</sup> / <sub>16</sub>	—	—	—	17.9
WW181868VPL3LL	WW181868VPL3RL	Laminate	\$ 1956	17 <sup>1</sup> / <sub>16</sub>	17 <sup>1</sup> / <sub>16</sub>	66 <sup>7</sup> / <sub>16</sub>	—	—	—	18.2
WW181568VPL3LL	WW181568VPL3RL	Laminate	1956	17 <sup>1</sup> / <sub>16</sub>	14 <sup>1</sup> / <sub>16</sub>	66 <sup>7</sup> / <sub>16</sub>	—	—	—	15.4

- Lockers offered in laminate only
- 2 coat hooks behind each door
- If using 1 locker by itself it MUST be attached to a wall
- If using more than 1 locker side by side they MUST be ganged together
- If using more than 1 locker back to back, a cluster of 4 lockers MUST be ordered and ganged both side to side and front to back
- Pulls will be installed vertically. All WaveWorks pull options available with the exception of Horizon
- If specifying the "no pull" option, unit will have a touch latch closure

**PRODUCT SPECIFICATIONS**

- Laminate only; refer to page 358 for options
- Tops of units are finished with flat edge detail
- Adjustable hinged doors

**TO ORDER, SPECIFY:**

1. Model Number
2. E lock color
3. Laminate Door-Drawer Color
4. Laminate Chassis Color

**SAMPLE MODEL NUMBERS:**

WW241879VPL1LEL B PB PB  
 • See pages 356-361 for all options available in WaveWorks

	MODEL NO./DESCRIPTION			LIST PRICE	DIMENSIONS					CARTONED WEIGHT	CUBIC FEET
					D	W	H	A	KW		
<b>LOCKER 1 DOOR ELECTRONIC LOCK</b>  	<b>LOCKERS/1 DOOR/ELECTRONIC LOCK</b>										
	<b>LEFT HINGED</b>										
	<b>RIGHT HINGED</b>										
	WW241879VPL1LEL	WW241879VPL1REL	Laminate	\$ 2515	23 <sup>3</sup> / <sub>16</sub>	17 <sup>1</sup> / <sub>16</sub>	78 <sup>1</sup> / <sub>16</sub>	—	—	—	26.8
	WW241579VPL1LEL	WW241579VPL1REL	Laminate	2515	23 <sup>3</sup> / <sub>16</sub>	14 <sup>1</sup> / <sub>16</sub>	78 <sup>1</sup> / <sub>16</sub>	—	—	—	22.5
	WW241868VPL1LEL	WW241868VPL1REL	Laminate	\$ 2243	23 <sup>3</sup> / <sub>16</sub>	17 <sup>1</sup> / <sub>16</sub>	66 <sup>7</sup> / <sub>8</sub>	—	—	—	23.0
	WW241568VPL1LEL	WW241568VPL1REL	Laminate	2243	23 <sup>3</sup> / <sub>16</sub>	14 <sup>1</sup> / <sub>16</sub>	66 <sup>7</sup> / <sub>8</sub>	—	—	—	19.5
	WW181879VPL1LEL	WW181879VPL1REL	Laminate	\$ 2455	17 <sup>1</sup> / <sub>16</sub>	17 <sup>1</sup> / <sub>16</sub>	78 <sup>1</sup> / <sub>16</sub>	—	—	—	21.1
	WW181579VPL1LEL	WW181579VPL1REL	Laminate	2455	17 <sup>1</sup> / <sub>16</sub>	14 <sup>1</sup> / <sub>16</sub>	78 <sup>1</sup> / <sub>16</sub>	—	—	—	17.9
	WW181868VPL1LEL	WW181868VPL1REL	Laminate	\$ 2185	17 <sup>1</sup> / <sub>16</sub>	17 <sup>1</sup> / <sub>16</sub>	66 <sup>7</sup> / <sub>8</sub>	—	—	—	18.2
WW181568VPL1LEL	WW181568VPL1REL	Laminate	2185	17 <sup>1</sup> / <sub>16</sub>	14 <sup>1</sup> / <sub>16</sub>	66 <sup>7</sup> / <sub>8</sub>	—	—	—	15.4	

- Locks ship separately and require field installation
- 2 fixed shelves and 2 coat hooks included
- If using 1 locker by itself it MUST be attached to a wall
- If using more than 1 locker side by side they MUST be ganged together
- If using more than 1 locker back to back, a cluster of 4 lockers MUST be ordered and ganged both side to side and front to back
- Do not specify pull when ordering electronic locking units
- Electronic locking features passcode operation; can be used for multi-use or single use
- Rechargeable lithium battery included. Charge with either a wired USB charger or USB power pack (not included)

**LOCKER  
2 DOOR  
ELECTRONIC LOCK**



	MODEL NO./DESCRIPTION			LIST PRICE	DIMENSIONS					CARTONED WEIGHT	CUBIC FEET
					D	W	H	A	KW		
	<b>LOCKERS/2 DOOR/ELECTRONIC LOCK</b>										
	<b>LEFT HINGED</b>										
	<b>RIGHT HINGED</b>										
	WW241879VPL2LEL	WW241879VPL2REL	Laminate	\$ 3177	23 <sup>3</sup> / <sub>16</sub>	17 <sup>1</sup> / <sub>16</sub>	78 <sup>1</sup> / <sub>16</sub>	—	—	—	26.8
	WW241579VPL2LEL	WW241579VPL2REL	Laminate	3177	23 <sup>3</sup> / <sub>16</sub>	14 <sup>1</sup> / <sub>16</sub>	78 <sup>1</sup> / <sub>16</sub>	—	—	—	22.5
	WW241868VPL2LEL	WW241868VPL2REL	Laminate	\$ 2904	23 <sup>3</sup> / <sub>16</sub>	17 <sup>1</sup> / <sub>16</sub>	66 <sup>7</sup> / <sub>8</sub>	—	—	—	23.0
	WW241568VPL2LEL	WW241568VPL2REL	Laminate	2904	23 <sup>3</sup> / <sub>16</sub>	14 <sup>1</sup> / <sub>16</sub>	66 <sup>7</sup> / <sub>8</sub>	—	—	—	19.5
	WW181879VPL2LEL	WW181879VPL2REL	Laminate	\$ 3117	17 <sup>1</sup> / <sub>16</sub>	17 <sup>1</sup> / <sub>16</sub>	78 <sup>1</sup> / <sub>16</sub>	—	—	—	21.1
	WW181579VPL2LEL	WW181579VPL2REL	Laminate	3117	17 <sup>1</sup> / <sub>16</sub>	14 <sup>1</sup> / <sub>16</sub>	78 <sup>1</sup> / <sub>16</sub>	—	—	—	17.9
	WW181868VPL2LEL	WW181868VPL2REL	Laminate	\$ 2847	17 <sup>1</sup> / <sub>16</sub>	17 <sup>1</sup> / <sub>16</sub>	66 <sup>7</sup> / <sub>8</sub>	—	—	—	18.2
WW181568VPL2LEL	WW181568VPL2REL	Laminate	2847	17 <sup>1</sup> / <sub>16</sub>	14 <sup>1</sup> / <sub>16</sub>	66 <sup>7</sup> / <sub>8</sub>	—	—	—	15.4	

- Locks ship separately and require field installation
- 2 coat hooks behind each door
- If using 1 locker by itself it MUST be attached to a wall
- If using more than 1 locker side by side they MUST be ganged together
- If using more than 1 locker back to back, a cluster of 4 lockers MUST be ordered and ganged both side to side and front to back
- Do not specify pull when ordering electronic locking units
- Electronic locking features passcode operation; can be used for multi-use or single use
- Rechargeable lithium battery included. Charge with either a wired USB charger or USB power pack (not included)

# WAVEWORKS

## PRODUCT SPECIFICATIONS

- Laminate only; refer to page 358 for options
- Tops of units are finished with flat edge detail
- Adjustable hinged doors

## TO ORDER, SPECIFY:

1. Model Number
2. E lock color
3. Laminate Door-Drawer Color
4. Laminate Chassis Color

## SAMPLE MODEL NUMBERS:

WW241879VPL3LEL S MC MC  
WW2379CPFPL CW

- See pages 356-361 for all options available in WaveWorks

MODEL NO./DESCRIPTION	LIST PRICE	DIMENSIONS					CARTONED CUBIC	
		D	W	H	A	KW	WEIGHT	FEET
<b>LOCKER 3 DOOR ELECTRONIC LOCK</b>								
<b>LOCKERS/3 DOOR/ELECTRONIC LOCK LEFT HINGED      RIGHT HINGED</b>								
WW241879VPL3LEL      WW241879VPL3REL      Laminate	\$ 3837	23 <sup>3</sup> / <sub>16</sub>	17 <sup>1</sup> / <sub>16</sub>	78 <sup>1</sup> / <sub>16</sub>	—	—	—	26.8
WW241579VPL3LEL      WW241579VPL3REL      Laminate	3837	23 <sup>3</sup> / <sub>16</sub>	14 <sup>1</sup> / <sub>16</sub>	78 <sup>1</sup> / <sub>16</sub>	—	—	—	22.5
WW241868VPL3LEL      WW241868VPL3REL      Laminate	\$ 3566	23 <sup>3</sup> / <sub>16</sub>	17 <sup>1</sup> / <sub>16</sub>	66 <sup>7</sup> / <sub>8</sub>	—	—	—	23.0
WW241568VPL3LEL      WW241568VPL3REL      Laminate	3566	23 <sup>3</sup> / <sub>16</sub>	14 <sup>1</sup> / <sub>16</sub>	66 <sup>7</sup> / <sub>8</sub>	—	—	—	19.5
WW181879VPL3LEL      WW181879VPL3REL      Laminate	\$ 3779	17 <sup>1</sup> / <sub>16</sub>	17 <sup>1</sup> / <sub>16</sub>	78 <sup>1</sup> / <sub>16</sub>	—	—	—	21.1
WW181579VPL3LEL      WW181579VPL3REL      Laminate	3779	17 <sup>1</sup> / <sub>16</sub>	14 <sup>1</sup> / <sub>16</sub>	78 <sup>1</sup> / <sub>16</sub>	—	—	—	17.9
WW181868VPL3LEL      WW181868VPL3REL      Laminate	\$ 3509	17 <sup>1</sup> / <sub>16</sub>	17 <sup>1</sup> / <sub>16</sub>	66 <sup>7</sup> / <sub>8</sub>	—	—	—	18.2
WW181568VPL3LEL      WW181568VPL3REL      Laminate	3509	17 <sup>1</sup> / <sub>16</sub>	14 <sup>1</sup> / <sub>16</sub>	66 <sup>7</sup> / <sub>8</sub>	—	—	—	15.4



- Locks ship separately and require field installation
- 2 coat hooks behind each door
- If using 1 locker by itself it MUST be attached to a wall
- If using more than 1 locker side by side they MUST be ganged together
- If using more than 1 locker back to back, a cluster of 4 lockers MUST be ordered and ganged both side to side and front to back
- Do not specify pull when ordering electronic locking units
- Electronic locking features passcode operation; can be used for multi-use or single use
- Rechargeable lithium battery included. Charge with either a wired USB charger or USB power pack (not included)

## WARDROBE/STORAGE CABINETS AND LOCKERS FILLER PANELS



23" DEPTH								
WW2379CPFPL	\$ 281	6	23 <sup>3</sup> / <sub>16</sub>	78 <sup>1</sup> / <sub>4</sub>	—	—	—	1.5
WW2368CPFPL	228	6	23 <sup>3</sup> / <sub>16</sub>	66 <sup>7</sup> / <sub>16</sub>	—	—	—	0.9
17" DEPTH								
WW1779CPFPL	\$ 209	6	17 <sup>1</sup> / <sub>16</sub>	78 <sup>1</sup> / <sub>4</sub>	—	—	—	1.5
WW1768CPFPL	186	6	17 <sup>1</sup> / <sub>16</sub>	66 <sup>7</sup> / <sub>16</sub>	—	—	—	1.3

- To be used with Wardrobe Storage Cabinets and Lockers to fill in space as needed
- Can be field cut to desired width

**PRODUCT SPECIFICATIONS**

- Wood and laminate doors and chassis available; refer to page 358 for options
- Tops of units are finished with flat edge detail
- If specifying wood, you must specify the same finish for all options

**TO ORDER, SPECIFY:**

1. Model Number
2. Veneer Chassis Finish/Laminate Chassis Color

**SAMPLE MODEL NUMBERS:**

- WWN3680BCOFW MH  
 WWN3680BCOFL AD
- See pages 356-361 for all options available in WaveWorks



Shaded model numbers are available on our "To You in 10 Days or Less" Quick Delivery program and will be delivered in 10 days or less.

**5 SHELF OPEN BOOKCASE**

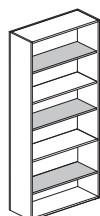

MODEL NO./DESCRIPTION	LIST PRICE	DIMENSIONS					CARTONED WEIGHT	CUBIC FEET
		D	W	H	A	KW		
<b>INTENDED FOR USE WITH 1 1/8" THICK WORKSURFACE MODELS</b>								
WWN3680BCOFW Wood	\$ 2797	13 1/8"	35 1/8"	79 1/8"	—	—	184 lbs.	38.3
WWN3680BCOFL Laminate	1389	13 1/8"	35 1/8"	79 1/8"	—	—	184 lbs.	38.3
<b>INTENDED FOR USE WITH 1 3/8" THICK WORKSURFACE MODELS</b>								
QWW3679BCOFW Wood	\$ 2797	13 1/8"	35 1/8"	79 1/4"	—	—	184 lbs.	38.3
WW3679BCOFW Wood	2797	13 1/8"	35 1/8"	79 1/4"	—	—	184 lbs.	38.3
QWW3679BCOFL Laminate	1389	13 1/8"	35 1/8"	79 1/4"	—	—	184 lbs.	38.3
WW3679BCOFL Laminate	1389	13 1/8"	35 1/8"	79 1/4"	—	—	184 lbs.	38.3

- Specify chassis finish only
- Shaded shelves are adjustable
- Not intended for use as set-on surface storage
- Almond Horizontal (ADH), Portobello Horizontal (PBH), Portico Horizontal (PTH), Skyline Horizontal (SKH), Sonoma Horizontal (SMH), Designer White Linear Horizontal (491H), Cinder Linear Horizontal (492H) and Sable Horizontal (792H) laminate options available on models 60" H or less

**4 SHELF OPEN BOOKCASE**

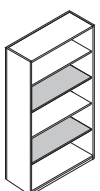

<b>INTENDED FOR USE WITH 1 1/8" THICK WORKSURFACE MODELS</b>								
WWN3669BCOFW Wood	\$ 2432	13 1/8"	35 1/8"	67 1/4"	—	—	188 lbs.	31.6
WWN3669BCOFL Laminate	1211	13 1/8"	35 1/8"	67 1/4"	—	—	188 lbs.	31.6
<b>INTENDED FOR USE WITH 1 3/8" THICK WORKSURFACE MODELS</b>								
QWW3668BCOFW Wood	\$ 2432	13 1/8"	35 1/8"	66 7/8"	—	—	188 lbs.	31.6
WW3668BCOFW Wood	2432	13 1/8"	35 1/8"	66 7/8"	—	—	188 lbs.	31.6
QWW3668BCOFL Laminate	1211	13 1/8"	35 1/8"	66 7/8"	—	—	188 lbs.	31.6
WW3668BCOFL Laminate	1211	13 1/8"	35 1/8"	66 7/8"	—	—	188 lbs.	31.6

- Specify chassis finish only
- Shaded shelves are adjustable
- Not intended for use as set-on surface storage
- Almond Horizontal (ADH), Portobello Horizontal (PBH), Portico Horizontal (PTH), Skyline Horizontal (SKH), Sonoma Horizontal (SMH), Designer White Linear Horizontal (491H), Cinder Linear Horizontal (492H) and Sable Horizontal (792H) laminate options available on models 60" H or less

**3 SHELF OPEN BOOKCASE**

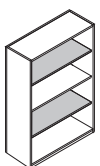

QWW3653BCOFW Wood	\$ 2234	13 1/8"	35 1/8"	52 1/8"	—	—	140 lbs.	26.7
WW3653BCOFW Wood	2234	13 1/8"	35 1/8"	52 1/8"	—	—	140 lbs.	26.7
QWW3653BCOFL Laminate	1093	13 1/8"	35 1/8"	52 1/8"	—	—	140 lbs.	26.7
WW3653BCOFL Laminate	1093	13 1/8"	35 1/8"	52 1/8"	—	—	140 lbs.	26.7

- Specify chassis finish only
- Shaded shelves are adjustable
- Not intended for use as set-on surface storage

# WAVEWORKS

## PRODUCT SPECIFICATIONS

- Wood and laminate doors and chassis available; refer to page 358 for options
- Tops of units are finished with flat edge detail
- Adjustable hinged doors
- If specifying wood, you must specify the same finish for all options

## TO ORDER, SPECIFY:

1. Model Number
2. Pull
3. Locking
4. Veneer Door-Drawer Finish/Laminate Door-Drawer Color (laminate/combo models)
5. Veneer Chassis Finish/Laminate Chassis Color

## SAMPLE MODEL NUMBERS:

WW3640BCOFW AC  
WW3640BCOFL AC2

- See pages 356-361 for all options available in WaveWorks

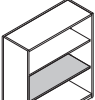

Shaded model numbers are available on our "To You in 10 Days or Less" Quick Delivery program and will be delivered in 10 days or less.

	MODEL NO./DESCRIPTION	LIST PRICE	DIMENSIONS					CARTONED CUBIC	
			D	W	H	A	KW	WEIGHT	FEET
<b>2 SHELF OPEN BOOKCASE</b> 	QWW3640BCOFW Wood	\$ 1894	13 <sup>1</sup> / <sub>16</sub>	35 <sup>3</sup> / <sub>8</sub>	40 <sup>3</sup> / <sub>16</sub>	—	—	112 lbs.	20.6
	WW3640BCOFW Wood	1894	13 <sup>1</sup> / <sub>16</sub>	35 <sup>3</sup> / <sub>8</sub>	40 <sup>3</sup> / <sub>16</sub>	—	—	112 lbs.	20.6
	QWW3640BCOFL Laminate	955	13 <sup>1</sup> / <sub>16</sub>	35 <sup>3</sup> / <sub>8</sub>	40 <sup>3</sup> / <sub>16</sub>	—	—	112 lbs.	20.6
	WW3640BCOFL Laminate	955	13 <sup>1</sup> / <sub>16</sub>	35 <sup>3</sup> / <sub>8</sub>	40 <sup>3</sup> / <sub>16</sub>	—	—	112 lbs.	20.6

- Specify chassis finish only
- Shaded shelf is adjustable
- Not intended for use as set-on surface storage

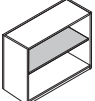
<b>1 SHELF OPEN BOOKCASE</b> 	QWW3628BCOFW Wood	\$ 1656	13 <sup>1</sup> / <sub>16</sub>	35 <sup>3</sup> / <sub>8</sub>	27 <sup>3</sup> / <sub>16</sub>	—	—	75 lbs.	13.7
	WW3628BCOFW Wood	1656	13 <sup>1</sup> / <sub>16</sub>	35 <sup>3</sup> / <sub>8</sub>	27 <sup>3</sup> / <sub>16</sub>	—	—	75 lbs.	13.7
	QWW3628BCOFL Laminate	820	13 <sup>1</sup> / <sub>16</sub>	35 <sup>3</sup> / <sub>8</sub>	27 <sup>3</sup> / <sub>16</sub>	—	—	75 lbs.	13.7
	WW3628BCOFL Laminate	820	13 <sup>1</sup> / <sub>16</sub>	35 <sup>3</sup> / <sub>8</sub>	27 <sup>3</sup> / <sub>16</sub>	—	—	75 lbs.	13.7



- Specify chassis finish only
- Shaded shelf is adjustable
- Not intended for use as set-on surface storage

## BOOKCASE WITH DOORS

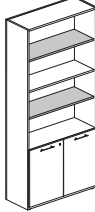
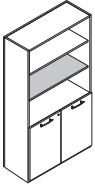
### INTENDED FOR USE WITH 1<sup>1</sup>/<sub>16</sub>" THICK WORKSURFACES

	WVN3680BCOHFW Wood	\$ 3423	14 <sup>3</sup> / <sub>8</sub>	35 <sup>3</sup> / <sub>8</sub>	79 <sup>1</sup> / <sub>16</sub>	—	—	220 lbs.	35.0
	WVN3680BCOHFL Laminate	1943	14 <sup>3</sup> / <sub>8</sub>	35 <sup>3</sup> / <sub>8</sub>	79 <sup>1</sup> / <sub>16</sub>	—	—	220 lbs.	35.0
	WVN3669BCOHFW Wood	\$ 2977	14 <sup>3</sup> / <sub>8</sub>	35 <sup>3</sup> / <sub>8</sub>	67 <sup>1</sup> / <sub>4</sub>	—	—	193 lbs.	31.6
	WVN3669BCOHFL Laminate	1690	14 <sup>3</sup> / <sub>8</sub>	35 <sup>3</sup> / <sub>8</sub>	67 <sup>1</sup> / <sub>4</sub>	—	—	193 lbs.	31.6

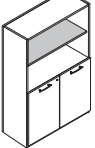
### INTENDED FOR USE WITH 1<sup>1</sup>/<sub>16</sub>" THICK WORKSURFACES

	WW3679BCOHFW Wood	\$ 3423	14 <sup>3</sup> / <sub>8</sub>	35 <sup>3</sup> / <sub>8</sub>	79 <sup>1</sup> / <sub>4</sub>	—	—	220 lbs.	35.0
	WW3679BCOHFL Laminate	1943	14 <sup>3</sup> / <sub>8</sub>	35 <sup>3</sup> / <sub>8</sub>	79 <sup>1</sup> / <sub>4</sub>	—	—	220 lbs.	35.0
	WW3668BCOHFW Wood	\$ 2977	14 <sup>3</sup> / <sub>8</sub>	35 <sup>3</sup> / <sub>8</sub>	66 <sup>3</sup> / <sub>8</sub>	—	—	193 lbs.	31.6
	WW3668BCOHFL Laminate	1690	14 <sup>3</sup> / <sub>8</sub>	35 <sup>3</sup> / <sub>8</sub>	66 <sup>3</sup> / <sub>8</sub>	—	—	193 lbs.	31.6
	WW3653BCOHFW Wood	\$ 2768	14 <sup>3</sup> / <sub>8</sub>	35 <sup>3</sup> / <sub>8</sub>	52 <sup>1</sup> / <sub>4</sub>	—	—	145 lbs.	26.7
	WW3653BCOHFL Laminate	1566	14 <sup>3</sup> / <sub>8</sub>	35 <sup>3</sup> / <sub>8</sub>	52 <sup>1</sup> / <sub>4</sub>	—	—	145 lbs.	26.7

- Shaded shelves are adjustable
- Cabinet features an adjustable shelf in bottom storage behind doors
- Random lock core (KRB, KRS) and specified lock core (KS1B, KS1S) available
- Almond Horizontal (ADH), Portobello Horizontal (PBH), Portico Horizontal (PTH), Skyline Horizontal (SKH), Sonoma Horizontal (SMH), Designer White Linear Horizontal (491H), Cinder Linear Horizontal (492H) and Sable Horizontal (792H) laminate options available on models 60" H or less

WAVEWORKS

ASSEMBLED



**PRODUCT SPECIFICATIONS**

- Wood and laminate doors and chassis available; refer to page 358 for options
- Tops of units are finished with flat edge detail
- If specifying wood, you must specify the same finish for all options

**TO ORDER, SPECIFY:**

1. Model Number
2. Veneer Chassis Finish/Laminate Chassis Color

**SAMPLE MODEL NUMBERS:**

- WW3650BCOW AC  
 WW3650BCOL AC2
- See pages 356-361 for all options available in WaveWorks

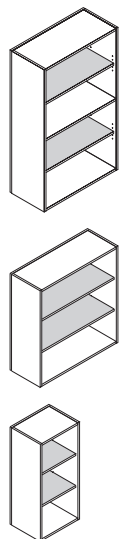
	MODEL NO./DESCRIPTION	LIST PRICE	DIMENSIONS					CARTONED CUBIC		
			D	W	H	A	KW	WEIGHT	FEET	
<b>OPEN BOOKCASE SET-ON SURFACE</b>  	<b>50" HIGH</b>									
	WW3650BCOW	Wood	\$ 1972	13 <sup>1</sup> / <sub>16</sub>	35 <sup>7</sup> / <sub>8</sub>	50	—	—	109 lbs.	25.5
	WW3650BCOL	Laminate	1130	13 <sup>1</sup> / <sub>16</sub>	35 <sup>7</sup> / <sub>8</sub>	50	—	—	109 lbs.	25.5
	WW3050BCOW	Wood	\$ 1837	13 <sup>1</sup> / <sub>16</sub>	29 <sup>1</sup> / <sub>16</sub>	50	—	—	97 lbs.	21.9
	WW3050BCOL	Laminate	1057	13 <sup>1</sup> / <sub>16</sub>	29 <sup>1</sup> / <sub>16</sub>	50	—	—	97 lbs.	21.9
	WW1850BCOW	Wood	\$ 1617	13 <sup>1</sup> / <sub>16</sub>	17 <sup>1</sup> / <sub>16</sub>	50	—	—	81 lbs.	14.7
	WW1850BCOL	Laminate	955	13 <sup>1</sup> / <sub>16</sub>	17 <sup>1</sup> / <sub>16</sub>	50	—	—	81 lbs.	14.7
	WW1550BCOW	Wood	\$ 1484	13 <sup>1</sup> / <sub>16</sub>	14 <sup>1</sup> / <sub>16</sub>	50	—	—	68 lbs.	9.5
	WW1550BCOL	Laminate	878	13 <sup>1</sup> / <sub>16</sub>	14 <sup>1</sup> / <sub>16</sub>	50	—	—	68 lbs.	9.5
	<b>38" HIGH</b>									
	WW3638BCOW	Wood	\$ 1558	13 <sup>1</sup> / <sub>16</sub>	35 <sup>7</sup> / <sub>8</sub>	38	—	—	100 lbs.	20.6
	WW3638BCOL	Laminate	748	13 <sup>1</sup> / <sub>16</sub>	35 <sup>7</sup> / <sub>8</sub>	38	—	—	100 lbs.	20.6
WW3038BCOW	Wood	\$ 1430	13 <sup>1</sup> / <sub>16</sub>	29 <sup>1</sup> / <sub>16</sub>	38	—	—	85 lbs.	16.8	
WW3038BCOL	Laminate	680	13 <sup>1</sup> / <sub>16</sub>	29 <sup>1</sup> / <sub>16</sub>	38	—	—	85 lbs.	16.8	
WW1838BCOW	Wood	\$ 1212	13 <sup>1</sup> / <sub>16</sub>	17 <sup>1</sup> / <sub>16</sub>	38	—	—	60 lbs.	11.0	
WW1838BCOL	Laminate	576	13 <sup>1</sup> / <sub>16</sub>	17 <sup>1</sup> / <sub>16</sub>	38	—	—	60 lbs.	11.0	
WW1538BCOW	Wood	\$ 1081	13 <sup>1</sup> / <sub>16</sub>	14 <sup>1</sup> / <sub>16</sub>	38	—	—	55 lbs.	9.5	
WW1538BCOL	Laminate	507	13 <sup>1</sup> / <sub>16</sub>	14 <sup>1</sup> / <sub>16</sub>	38	—	—	55 lbs.	9.5	

- Specify chassis finish only
- Not intended for use on table desking
- Shaded shelves are adjustable
- 50" high models have 3 adjustable shelves; 38" high models have 2 adjustable shelves

WAVEWORKS

ASSEMBLED

# WAVEWORKS

## PRODUCT SPECIFICATIONS

- Wood, laminate or glass doors and wood or laminate chassis available; refer to page 358 for options
- Tops of units are finished with flat edge detail
- If specifying wood, you must specify the same finish for all options

## TO ORDER, SPECIFY:

1. Model Number
2. Locking
3. Door Frame Color (glass door models)
4. Veneer Door-Drawer Finish/Laminate Door-Drawer Color (laminate/combo models)
5. Veneer Chassis Finish/Laminate Chassis Color

## SAMPLE MODEL NUMBERS:

WW3650BCHW KRB CW  
 WW3650BCHL KRB 405 405

- See pages 356-361 for all options available in WaveWorks

### BOOKCASE WITH DOORS SET-ON SURFACE

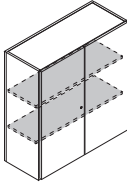
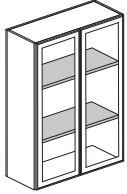

MODEL NO./DESCRIPTION	LIST PRICE	DIMENSIONS					CARTONED WEIGHT	CUBIC FEET
		D	W	H	A	KW		
<b>50" HIGH</b>								
WW3650BCHGW Glass/Wood	\$ 4384	14 $\frac{3}{4}$	35 $\frac{5}{8}$	49 $\frac{1}{16}$	—	—	144 lbs.	25.5
WW3650BCHGL Glass/Laminate	3409	14 $\frac{3}{4}$	35 $\frac{5}{8}$	49 $\frac{1}{16}$	—	—	144 lbs.	25.5
WW3650BCHW Wood	2143	14 $\frac{3}{4}$	35 $\frac{5}{8}$	49 $\frac{1}{16}$	—	—	144 lbs.	25.5
WW3650BCHL Laminate	1188	14 $\frac{3}{4}$	35 $\frac{5}{8}$	49 $\frac{1}{16}$	—	—	144 lbs.	25.5
<b>38" HIGH</b>								
WW3050BCHGW Glass/Wood	\$ 3983	14 $\frac{3}{4}$	29 $\frac{1}{16}$	49 $\frac{1}{16}$	—	—	126 lbs.	21.9
WW3050BCHGL Glass/Laminate	3098	14 $\frac{3}{4}$	29 $\frac{1}{16}$	49 $\frac{1}{16}$	—	—	126 lbs.	21.9
WW3050BCHW Wood	2013	14 $\frac{3}{4}$	29 $\frac{1}{16}$	49 $\frac{1}{16}$	—	—	126 lbs.	21.9
WW3050BCHL Laminate	1095	14 $\frac{3}{4}$	29 $\frac{1}{16}$	49 $\frac{1}{16}$	—	—	126 lbs.	21.9
WW3638BCHGW Glass/Wood	\$ 3911	14 $\frac{3}{4}$	35 $\frac{5}{8}$	38 $\frac{3}{8}$	—	—	110 lbs.	19.9
WW3638BCHGL Glass/Laminate	2114	14 $\frac{3}{4}$	35 $\frac{5}{8}$	38 $\frac{3}{8}$	—	—	110 lbs.	19.9
WW3638BCHW Wood	1723	14 $\frac{3}{4}$	35 $\frac{5}{8}$	38 $\frac{3}{8}$	—	—	110 lbs.	19.9
WW3638BCHL Laminate	809	14 $\frac{3}{4}$	35 $\frac{5}{8}$	38 $\frac{3}{8}$	—	—	110 lbs.	19.9
WW3038BCHGW Glass/Wood	\$ 3553	14 $\frac{3}{4}$	29 $\frac{1}{16}$	38 $\frac{3}{8}$	—	—	94 lbs.	17.1
WW3038BCHGL Glass/Laminate	1920	14 $\frac{3}{4}$	29 $\frac{1}{16}$	38 $\frac{3}{8}$	—	—	94 lbs.	17.1
WW3038BCHW Wood	1593	14 $\frac{3}{4}$	29 $\frac{1}{16}$	38 $\frac{3}{8}$	—	—	94 lbs.	17.1
WW3038BCHL Laminate	717	14 $\frac{3}{4}$	29 $\frac{1}{16}$	38 $\frac{3}{8}$	—	—	94 lbs.	17.1

- Not intended for use on table desking
- Shaded shelves are adjustable
- 50" high models have 3 adjustable shelves; 38" high models have 2 adjustable shelves
- Glass doors do not lock
- Random lock core (KRB, KRS) and specified lock core (KS1B, KS1S) available

WAVEWORKS

ASSEMBLED

**PRODUCT SPECIFICATIONS**

- Wood, laminate or glass doors and wood or laminate chassis available; refer to page 358 for options
- Tops of units are finished with flat edge detail
- If specifying wood, you must specify the same finish for all options

**TO ORDER, SPECIFY:**

1. Model Number
2. Locking
3. Door Frame Color (glass door models)
4. Veneer Door-Drawer Finish/Laminate Door-Drawer Color (laminate/combo models)
5. Veneer Chassis Finish/Laminate Chassis Color

**SAMPLE MODEL NUMBERS:**

WW1850BCHLW KRB CW  
 WW1850BCHLL KRB 405 405

- See pages 356-361 for all options available in WaveWorks

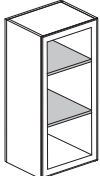
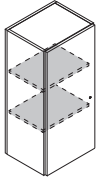
	MODEL NO./DESCRIPTION		LIST PRICE	DIMENSIONS					CARTONED WEIGHT	CUBIC FEET	
				D	W	H	A	KW			
<b>BOOKCASE WITH DOOR SET-ON SURFACE</b>      Left shown	<b>50" HIGH</b>										
		<b>LEFT HINGED</b>	<b>RIGHT HINGED</b>								
	WW1850BCHLGW	WW1850BCHRGW	Glass/Wood	\$ 3620	14 <sup>3</sup> / <sub>4</sub>	17 <sup>1</sup> / <sub>16</sub>	49 <sup>1</sup> / <sub>16</sub>	—	—	98 lbs.	14.7
	WW1850BCHLGL	WW1850BCHRGL	Glass/Lam	2545	14 <sup>3</sup> / <sub>4</sub>	17 <sup>1</sup> / <sub>16</sub>	49 <sup>1</sup> / <sub>16</sub>	—	—	98 lbs.	14.7
	WW1850BCHLW	WW1850BCHRW	Wood	1692	14 <sup>3</sup> / <sub>4</sub>	17 <sup>1</sup> / <sub>16</sub>	49 <sup>1</sup> / <sub>16</sub>	—	—	98 lbs.	14.7
	WW1850BCHLL	WW1850BCHRL	Laminate	987	14 <sup>3</sup> / <sub>4</sub>	17 <sup>1</sup> / <sub>16</sub>	49 <sup>1</sup> / <sub>16</sub>	—	—	98 lbs.	14.7
	WW1550BCHLGW	WW1550BCHRGW	Glass/Wood	\$ 3418	14 <sup>3</sup> / <sub>4</sub>	14 <sup>1</sup> / <sub>16</sub>	49 <sup>1</sup> / <sub>16</sub>	—	—	98 lbs.	14.7
	WW1550BCHLGL	WW1550BCHRGL	Glass/Lam	1865	14 <sup>3</sup> / <sub>4</sub>	14 <sup>1</sup> / <sub>16</sub>	49 <sup>1</sup> / <sub>16</sub>	—	—	98 lbs.	14.7
	WW1550BCHLW	WW1550BCHRW	Wood	1579	14 <sup>3</sup> / <sub>4</sub>	14 <sup>1</sup> / <sub>16</sub>	49 <sup>1</sup> / <sub>16</sub>	—	—	98 lbs.	14.7
	WW1550BCHLL	WW1550BCHRL	Laminate	905	14 <sup>3</sup> / <sub>4</sub>	14 <sup>1</sup> / <sub>16</sub>	49 <sup>1</sup> / <sub>16</sub>	—	—	98 lbs.	14.7
		<b>38" HIGH</b>									
		<b>LEFT HINGED</b>	<b>RIGHT HINGED</b>								
	WW1838BCHLGW	WW1838BCHRGW	Glass/Wood	\$ 2325	14 <sup>3</sup> / <sub>4</sub>	17 <sup>1</sup> / <sub>16</sub>	38 <sup>3</sup> / <sub>8</sub>	—	—	77 lbs.	11.4
	WW1838BCHLGL	WW1838BCHRGL	Glass/Lam	1255	14 <sup>3</sup> / <sub>4</sub>	17 <sup>1</sup> / <sub>16</sub>	38 <sup>3</sup> / <sub>8</sub>	—	—	77 lbs.	11.4
	WW1838BCHLW	WW1838BCHRW	Wood	1283	14 <sup>3</sup> / <sub>4</sub>	17 <sup>1</sup> / <sub>16</sub>	38 <sup>3</sup> / <sub>8</sub>	—	—	77 lbs.	11.4
	WW1838BCHLL	WW1838BCHRL	Laminate	611	14 <sup>3</sup> / <sub>4</sub>	17 <sup>1</sup> / <sub>16</sub>	38 <sup>3</sup> / <sub>8</sub>	—	—	77 lbs.	11.4
WW1538BCHLGW	WW1538BCHRGW	Glass/Wood	\$ 2157	14 <sup>3</sup> / <sub>4</sub>	14 <sup>1</sup> / <sub>16</sub>	38 <sup>3</sup> / <sub>8</sub>	—	—	77 lbs.	11.4	
WW1538BCHLGL	WW1538BCHRGL	Glass/Lam	1166	14 <sup>3</sup> / <sub>4</sub>	14 <sup>1</sup> / <sub>16</sub>	38 <sup>3</sup> / <sub>8</sub>	—	—	77 lbs.	11.4	
WW1538BCHLW	WW1538BCHRW	Wood	1174	14 <sup>3</sup> / <sub>4</sub>	14 <sup>1</sup> / <sub>16</sub>	38 <sup>3</sup> / <sub>8</sub>	—	—	77 lbs.	11.4	
WW1538BCHLL	WW1538BCHRL	Laminate	531	14 <sup>3</sup> / <sub>4</sub>	14 <sup>1</sup> / <sub>16</sub>	38 <sup>3</sup> / <sub>8</sub>	—	—	77 lbs.	11.4	

- Not intended for use on table desking
- Shaded shelves are adjustable
- 50" high models have 3 adjustable shelves; 38" high models have 2 adjustable shelves
- Glass doors do not lock
- Random lock core (KRB, KRS) and specified lock core (KS1B, KS1S) available

WAVEWORKS

ASSEMBLED

# WAVEWORKS

## PRODUCT SPECIFICATIONS

- Wood and laminate doors and chassis available; refer to page 358 for options
- Tops of units are finished with flat edge detail
- If specifying wood, you must specify the same finish for all options

## TO ORDER, SPECIFY:

1. Model Number
2. Finish (wood models)
3. Door Laminate Color (laminate models)
4. Laminate Color (laminate models)

## SAMPLE MODEL NUMBERS:

WW3664BCOHHMALW CW  
 WW3664BCOHHMALL 405 PB

- See pages 356-361 for all options available in WaveWorks

MODEL NO./DESCRIPTION	LIST PRICE	DIMENSIONS					CARTONED CUBIC	
		D	W	H	A	KW	WEIGHT	FEET
<b>SET-ON BOOKCASE STYLE A</b>								
<b>64" HIGH LEFT</b>								
WW3664BCOHHMALW	Wood	\$ 3262	14¾	35½	63¾	—	—	lbs.
WW3664BCOHHMALL	Laminate	2113	14¾	35½	63¾	—	—	lbs.
<b>64" HIGH RIGHT</b>								
WW3064BCOHHMALW	Wood	\$ 3161	14¾	29½	63¾	—	—	lbs.
WW3064BCOHHMALL	Laminate	2012	14¾	29½	63¾	—	—	lbs.

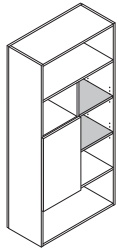

Left shown

- Cornice frames are available. See pages 485-491
- Not intended for table desking
- Shaded shelves are adjustable
- Back not finished; for use with wall
- Not to be used in open plan; however, units can be used if back to back and ganged
- Must be attached to wall
- Non-locking, no pull

## SET-ON BOOKCASE STYLE B

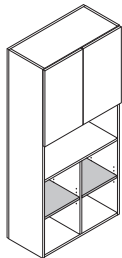

MODEL NO./DESCRIPTION	LIST PRICE	DIMENSIONS					CARTONED CUBIC		
			D	W	H	A	KW	WEIGHT	FEET
<b>64" HIGH</b>									
WW3664BCOHHMBW	Wood	\$ 3262	14¾	35½	63¾	—	—	lbs.	
WW3664BCOHHMBL	Laminate	2113	14¾	35½	63¾	—	—	lbs.	
WW3064BCOHHMBW	Wood	\$ 3161	14¾	29½	63¾	—	—	lbs.	
WW3064BCOHHMBL	Laminate	2012	14¾	29½	63¾	—	—	lbs.	

- Cornice frames are available. See pages 485-491
- Not intended for table desking
- Shaded shelves are adjustable
- Back not finished; for use with wall
- Not to be used in open plan; however, units can be used if back to back and ganged
- Must be attached to wall
- Non-locking, no pull

## SET-ON BOOKCASE STYLE C

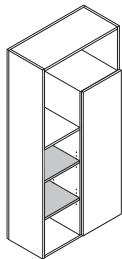

Right shown

MODEL NO./DESCRIPTION	LIST PRICE	DIMENSIONS					CARTONED CUBIC		
			D	W	H	A	KW	WEIGHT	FEET
<b>64" HIGH LEFT</b>									
WW3664BCOHHMCLW	Wood	\$ 3262	14¾	35½	63¾	—	—	lbs.	
WW3664BCOHHMCLL	Laminate	2113	14¾	35½	63¾	—	—	lbs.	
<b>64" HIGH RIGHT</b>									
WW3064BCOHHMCLW	Wood	\$ 3161	14¾	29½	63¾	—	—	lbs.	
WW3064BCOHHMCLL	Laminate	2012	14¾	29½	63¾	—	—	lbs.	

- Cornice frames are available. See pages 485-491
- Not intended for table desking
- Shaded shelves are adjustable
- Back not finished; for use with wall
- Not to be used in open plan; however, units can be used if back to back and ganged
- Must be attached to wall
- Non-locking, no pull

WAVEWORKS

ASSEMBLED

**PRODUCT SPECIFICATIONS**

- Wood and laminate doors and chassis available; refer to page 358 for options
- Tops of units are finished with flat edge detail
- If specifying wood, you must specify the same finish for all options

**TO ORDER, SPECIFY:**

1. Model Number
2. Finish (wood models)
3. Door Laminate Color (laminate models)
4. Laminate Color (laminate models)

**SAMPLE MODEL NUMBERS:**

WW3050BCOHMALW MC  
WW3050BCOHMALL 405 462

- See pages 356-361 for all options available in WaveWorks

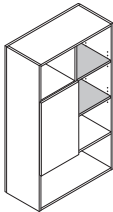
	MODEL NO./DESCRIPTION		LIST PRICE	DIMENSIONS					CARTONED CUBIC		
				D	W	H	A	KW	WEIGHT	FEET	
<b>SET-ON BOOKCASE STYLE A</b>   Left shown	<b>50" HIGH</b>										
		<b>LEFT</b>	<b>RIGHT</b>								
	WW3650BCOHMALW	WW3650BCOHBMARW	Wood	\$ 2544	14¾	35½	50	—	—	lbs.	
	WW3650BCOHMALL	WW3650BCOHBMARL	Laminate	1825	14¾	35½	50	—	—	lbs.	
	WW3050BCOHMALW	WW3050BCOHBMARW	Wood	\$ 2443	14¾	29⅞	50	—	—	lbs.	
	WW3050BCOHMALL	WW3050BCOHBMARL	Laminate	1724	14¾	29⅞	50	—	—	lbs.	
	<ul style="list-style-type: none"> <li>• Cornice frames are available. See pages 485-491</li> <li>• Not intended for table desking</li> <li>• Shaded shelves are adjustable</li> <li>• Back not finished; for use with wall</li> <li>• Not to be used in open plan; however, units can be used if back to back and ganged</li> <li>• Must be attached to wall</li> <li>• Non-locking, no pull</li> </ul>										

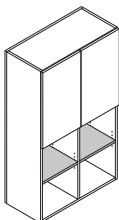
<b>SET-ON BOOKCASE STYLE B</b>  	<b>50" HIGH</b>										
	WW3650BCOHBMBW	Wood	\$ 2544	14¾	35½	50	—	—	lbs.		
	WW3650BCOHBMBL	Laminate	1825	14¾	35½	50	—	—	lbs.		
	WW3050BCOHBMBW	Wood	\$ 2443	14¾	29⅞	50	—	—	lbs.		
	WW3050BCOHBMBL	Laminate	1724	14¾	29⅞	50	—	—	lbs.		
	<ul style="list-style-type: none"> <li>• Cornice frames are available. See pages 485-491</li> <li>• Not intended for table desking</li> <li>• Shaded shelves are adjustable</li> <li>• Back not finished; for use with wall</li> <li>• Not to be used in open plan; however, units can be used if back to back and ganged</li> <li>• Must be attached to wall</li> <li>• Non-locking, no pull</li> </ul>										

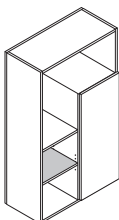
<b>SET-ON BOOKCASE STYLE C</b>   Right shown	<b>50" HIGH</b>										
		<b>LEFT</b>	<b>RIGHT</b>								
	WW3650BCOHBMLW	WW3650BCOHBMLRW	Wood	\$ 2544	14¾	35½	50	—	—	lbs.	
	WW3650BCOHBMLL	WW3650BCOHBMLRL	Laminate	1825	14¾	35½	50	—	—	lbs.	
	WW3050BCOHBMLW	WW3050BCOHBMLRW	Wood	\$ 2443	14¾	29⅞	50	—	—	lbs.	
	WW3050BCOHBMLL	WW3050BCOHBMLRL	Laminate	1724	14¾	29⅞	50	—	—	lbs.	
	<ul style="list-style-type: none"> <li>• Cornice frames are available. See pages 485-491</li> <li>• Not intended for table desking</li> <li>• Shaded shelf is adjustable</li> <li>• Back not finished; for use with wall</li> <li>• Not to be used in open plan; however, units can be used if back to back and ganged</li> <li>• Must be attached to wall</li> <li>• Non-locking, no pull</li> </ul>										

# WAVEWORKS

## PRODUCT SPECIFICATIONS

- Wood and laminate doors and chassis available; refer to page 358 for options
- Tops of units are finished with flat edge detail
- If specifying wood, you must specify the same finish for all options

## TO ORDER, SPECIFY:

1. Model Number
2. Finish (wood models)
3. Door Laminate Color (laminate models)
4. Laminate Color (laminate models)

## SAMPLE MODEL NUMBERS:

WW3638BCOHHMALW MC  
WW3638BCOHHMALL 462 PB

- See pages 356-361 for all options available in WaveWorks

MODEL NO./DESCRIPTION	LIST PRICE	DIMENSIONS					CARTONED CUBIC	
		D	W	H	A	KW	WEIGHT	FEET
<b>SET-ON BOOKCASE STYLE A</b>								
<b>38" HIGH LEFT</b>								
WW3638BCOHHMALW	Wood \$ 2255	14¾	35½	38	—	—	lbs.	
WW3638BCOHHMALL	Laminate 1538	14¾	35½	38	—	—	lbs.	
<b>38" HIGH RIGHT</b>								
WW3038BCOHHMALW	Wood \$ 2154	14¾	29⅞	38	—	—	lbs.	
WW3038BCOHHMALL	Laminate 1437	14¾	29⅞	38	—	—	lbs.	

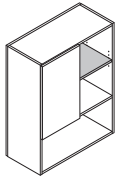

Left shown

- Cornice frames are available. See pages 485-491
- Not intended for table desking
- Shaded shelf is adjustable
- Back not finished; for use with wall
- Not to be used in open plan; however, units can be used if back to back and ganged
- Must be attached to wall
- Non-locking, no pull

## SET-ON BOOKCASE STYLE B

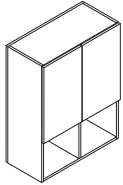

MODEL NO./DESCRIPTION	LIST PRICE	D	W	H	A	KW	CARTONED CUBIC WEIGHT
<b>38" HIGH</b>							
WW3638BCOHHMBW	Wood \$ 2255	14¾	35½	38	—	—	lbs.
WW3638BCOHHMBL	Laminate 1538	14¾	35½	38	—	—	lbs.
WW3038BCOHHMBW	Wood \$ 2154	14¾	29⅞	38	—	—	lbs.
WW3038BCOHHMBL	Laminate 1437	14¾	29⅞	38	—	—	lbs.

- Cornice frames are available. See pages 485-491
- Not intended for table desking
- Back not finished; for use with wall
- Not to be used in open plan; however, units can be used if back to back and ganged
- Must be attached to wall
- Non-locking, no pull

## SET-ON BOOKCASE STYLE C

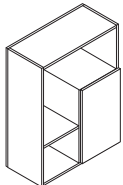

Right shown

MODEL NO./DESCRIPTION	LIST PRICE	D	W	H	A	KW	CARTONED CUBIC WEIGHT
<b>38" HIGH LEFT</b>							
WW3638BCOHHMCLW	Wood \$ 2255	14¾	35½	38	—	—	lbs.
WW3638BCOHHMCLL	Laminate 1538	14¾	35½	38	—	—	lbs.
<b>38" HIGH RIGHT</b>							
WW3038BCOHHMCRW	Wood \$ 2154	14¾	29⅞	38	—	—	lbs.
WW3038BCOHHMCRL	Laminate 1437	14¾	29⅞	38	—	—	lbs.

- Cornice frames are available. See pages 485-491
- Not intended for table desking
- Back not finished; for use with wall
- Not to be used in open plan; however, units can be used if back to back and ganged
- Must be attached to wall
- Non-locking, no pull

**PRODUCT SPECIFICATIONS**

- Wood and laminate doors and chassis available; refer to page 358 for options
- If specifying wood, you must specify the same finish for all options

**TO ORDER, SPECIFY:**

1. Model Number
2. Rim
3. PVC Rim Color
4. Pull
5. Grommet
6. Locking
7. Laminate Top Color (laminate models)
8. Laminate Door/Drawer Color (laminate models)
9. Veneer Chassis Finish/Laminate Chassis Color
10. Metal Color

**SAMPLE MODEL NUMBERS:**

WWN2415PFBBFW F 3CC KRB  
 WWN2415PFBBFL F 6CC KRB

- See pages 356-361 for all options available in WaveWorks

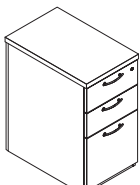
	MODEL NO./DESCRIPTION	LIST PRICE	DIMENSIONS					CARTONED WEIGHT	CUBIC FEET	
			D	W	H	A	KW			
<b>FREESTANDING PEDESTAL BOX/BOX/FILE</b> 	<b>1 1/16" TOP THICKNESS</b>									
	WWN2415PFBBFW	Wood	\$ 2379	23 1/16	15 3/16	29 3/4	—	—	83 lbs.	11.4
	WWN2415PFBBFL	Laminate	1507	23 1/16	15 3/16	29 3/4	—	—	83 lbs.	11.4
	<b>1 3/16" TOP THICKNESS</b>									
	WW2415PFBBFW	Wood	\$ 1895	23 1/16	15 3/16	28 3/8	—	—	83 lbs.	11.4
	WW2415PFBBFL	Laminate	1249	23 1/16	15 3/16	28 3/8	—	—	83 lbs.	11.4

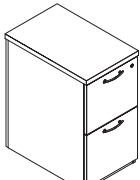
<b>FREESTANDING PEDESTAL FILE/FILE</b> 	<b>1 1/16" TOP THICKNESS</b>									
	WWN2415PFFFW	Wood	\$ 2379	23 1/16	15 3/16	29 3/4	—	—	83 lbs.	11.4
	WWN2415PFFFL	Laminate	1507	23 1/16	15 3/16	29 3/4	—	—	83 lbs.	11.4
	<b>1 3/16" TOP THICKNESS</b>									
	WW2415PFFFW	Wood	\$ 1895	23 1/16	15 3/16	28 3/8	—	—	83 lbs.	11.4
	WW2415PFFFL	Laminate	1249	23 1/16	15 3/16	28 3/8	—	—	83 lbs.	11.4

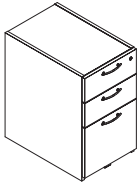
<b>MOBILE PEDESTAL BOX/BOX/FILE WITH TOP</b> 	WW2315PMBBF2W	Wood	\$ 2327	22 3/16	14 1/16	25 3/8	—	—	75 lbs.	9.9
	WW2315PMBBF2L	Laminate	1475	22 3/16	14 1/16	25 3/8	—	—	75 lbs.	9.9

WAVEWORKS

ASSEMBLED

# WAVEWORKS

## PRODUCT SPECIFICATIONS

- Wood and laminate doors and chassis available; refer to page 358 for options
- If specifying wood, you must specify the same finish for all options



## TO ORDER, SPECIFY:

1. Model Number
2. Rim
3. PVC Rim Color
4. Pull
5. Grommet
6. Locking
7. Laminate Top Color (laminate models)
8. Laminate Door/Drawer Color (laminate models)
9. Veneer Chassis Finish/Laminate Chassis Color
10. Metal Color

## SAMPLE MODEL NUMBER:

WW2315PMFFW 6MB KRB HN

- See pages 356-361 for all options available in WaveWorks

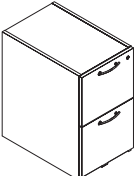
	MODEL NO./DESCRIPTION	LIST PRICE	DIMENSIONS					CARTONED WEIGHT	CUBIC FEET
			D	W	H	A	KW		
<b>MOBILE PEDESTAL FILE/FILE</b> 	WW2315PMFFW Wood	\$ 2050	23 <sup>3</sup> / <sub>16</sub>	15 <sup>7</sup> / <sub>8</sub>	26 <sup>5</sup> / <sub>16</sub>	—	—	70 lbs.	9.9
	WW2315PMFFL Laminate	1299	23 <sup>3</sup> / <sub>16</sub>	15 <sup>7</sup> / <sub>8</sub>	26 <sup>5</sup> / <sub>16</sub>	—	—	70 lbs.	9.9
	<ul style="list-style-type: none"> <li>• Unit features a finished back</li> <li>• Top is a black, high impact polystyrene organizer tray with exposed, easy access filing</li> <li>• Top drawer does not pull out due to filing from the top</li> <li>• 4 double wheel non-locking casters standard</li> <li>• Random lock core (KRB, KRS) and specified lock core (KS1B, KS1S) available</li> </ul>								
<b>MOBILE PEDESTAL BOX/FILE</b> 	WW2315PMBFW Wood	\$ 1999	23 <sup>3</sup> / <sub>16</sub>	15 <sup>7</sup> / <sub>8</sub>	26 <sup>5</sup> / <sub>16</sub>	—	—	70 lbs.	9.9
	WW2315PMBFL Laminate	1268	23 <sup>3</sup> / <sub>16</sub>	15 <sup>7</sup> / <sub>8</sub>	26 <sup>5</sup> / <sub>16</sub>	—	—	70 lbs.	9.9
	<ul style="list-style-type: none"> <li>• Unit features a finished back</li> <li>• Top is a black, high impact polystyrene organizer tray</li> <li>• 4 double wheel non-locking casters standard</li> <li>• Random lock core (KRB, KRS) and specified lock core (KS1B, KS1S) available</li> </ul>								
<b>MOBILE PEDESTAL BOX/FILE WITH TOP</b> 	WW2315PMBF2W Wood	\$ 2327	22 <sup>1</sup> / <sub>16</sub>	15 <sup>7</sup> / <sub>8</sub>	21 <sup>1</sup> / <sub>2</sub>	—	—	76 lbs.	8.7
	WW2315PMBF2L Laminate	1475	22 <sup>1</sup> / <sub>16</sub>	15 <sup>7</sup> / <sub>8</sub>	21 <sup>1</sup> / <sub>2</sub>	—	—	76 lbs.	8.7
	<ul style="list-style-type: none"> <li>• 4 double wheel non-locking casters standard</li> <li>• Maximum weight unit can hold is 300 pounds</li> <li>• Do not specify rim option</li> <li>• Random lock core (KRB, KRS) and specified lock core (KS1B, KS1S) available</li> </ul>								
<b>MOBILE PEDESTAL FILE/FILE WITH TOP</b> 	WW2315PMFF2W Wood	\$ 2327	22 <sup>1</sup> / <sub>16</sub>	14 <sup>1</sup> / <sub>16</sub>	25 <sup>1</sup> / <sub>2</sub>	—	—	75 lbs.	9.9
	WW2315PMFF2L Laminate	1475	22 <sup>1</sup> / <sub>16</sub>	14 <sup>1</sup> / <sub>16</sub>	25 <sup>1</sup> / <sub>2</sub>	—	—	75 lbs.	9.9

WAVEWORKS

ASSEMBLED



**PRODUCT SPECIFICATIONS**

- Wood and laminate doors and chassis available; refer to page 358 for options
- If specifying wood, you must specify the same finish for all options

**TO ORDER, SPECIFY:**

1. Model Number
2. Rim
3. PVC Rim Color
4. Pull
5. Grommet
6. Locking
7. Laminate Top Color (laminate models)
8. Laminate Door/Drawer Color (laminate models)
9. Veneer Chassis Finish/Laminate Chassis Color
10. Metal Color

**SAMPLE MODEL NUMBER:**

WW2315PMBFCW 6MB KRB 4 41301 HN  
 • See pages 356-361 for all options available in WaveWorks

**MOBILE PEDESTAL CUSHION TOP**



**MODEL NO./DESCRIPTION**

		GRADE / LIST PRICE							
		1	2/COM	3/COL	4	5	6	7	
WW2315PMBFCW	Wood	\$ 2052	2081	2094	2116	2139	2179	2232	

**ALLIANCE GRADE / LIST PRICE**

	A	B	C	D	E	F	G	H	I	J
\$	2101	2132	2155	2180	2207	2236	2260	2290	2320	2351
	K	L	M	N	O	P	Q	R	S	T
\$	2397	2492	2551	2582	2612	2643	2674	2703	2733	2763

**GRADE / LIST PRICE**

		1	2/COM	3/COL	4	5	6	7
WW2315PMBFCL	Laminate	\$ 1449	1478	1491	1513	1536	1576	1629

**ALLIANCE GRADE / LIST PRICE**

	A	B	C	D	E	F	G	H	I	J
\$	1498	1529	1552	1577	1604	1633	1657	1687	1717	1748
	K	L	M	N	O	P	Q	R	S	T
\$	1794	1889	1948	1979	2009	2040	2071	2100	2130	2160

**DIMENSIONS**

Depth	22 <sup>3</sup> / <sub>8</sub>	Height	23	Weight	78
Width	15 <sup>1</sup> / <sub>8</sub>			Cubic Ft.	9.2

- Maximum weight unit can hold is 300 pounds
- Refer to pages 5-13 and [www.NationalOfficeFurniture.com/Alliance](http://www.NationalOfficeFurniture.com/Alliance) for available upholstery options
- Specify fabric grade and color for cushion top
- Random lock core (KRB, KRS) and specified lock core (KS1B, KS1S) available

WAVEWORKS

ASSEMBLED

# WAVEWORKS

## PRODUCT SPECIFICATIONS

- Wood and laminate doors and chassis available; refer to page 358 for options
- If specifying wood, you must specify the same finish for all options

## TO ORDER, SPECIFY:

1. Model Number
2. Rim
3. PVC Rim Color
4. Pull
5. Grommet
6. Locking
7. Laminate Top Color (laminate models)
8. Laminate Door/Drawer Color (laminate models)
9. Veneer Chassis Finish/Laminate Chassis Color
10. Metal Color

## SAMPLE MODEL NUMBER:

WWN2436MUCW 6MB KRB HN

- See pages 356-361 for all options available in WaveWorks

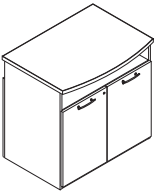
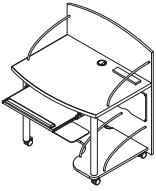
	MODEL NO./DESCRIPTION	LIST PRICE	DIMENSIONS					CARTONED WEIGHT	CUBIC FEET
			D	W	H	A	KW		
	<b>1<sup>1</sup>/<sub>6</sub>" TOP THICKNESS</b>								
	WWN2436MUCW	Wood	\$ 2919	26 <sup>7</sup> / <sub>16</sub>	36 <sup>3</sup> / <sub>16</sub>	34 <sup>7</sup> / <sub>16</sub>	—	—	155 lbs. 17.1
	WWN2436MUCLW	Laminate/Wood	2919	26 <sup>7</sup> / <sub>16</sub>	36 <sup>3</sup> / <sub>16</sub>	34 <sup>7</sup> / <sub>16</sub>	—	—	155 lbs. 17.1
	WWN2436MUCL	Laminate	2187	26 <sup>7</sup> / <sub>16</sub>	36 <sup>3</sup> / <sub>16</sub>	34 <sup>7</sup> / <sub>16</sub>	—	—	155 lbs. 17.1
	<b>1<sup>3</sup>/<sub>8</sub>" TOP THICKNESS</b>								
	WW2436MUCW	Wood	\$ 2654	26 <sup>7</sup> / <sub>16</sub>	36 <sup>3</sup> / <sub>16</sub>	34 <sup>1</sup> / <sub>2</sub>	—	—	155 lbs. 17.1
	WW2436MUCLW	Laminate/Wood	2654	26 <sup>7</sup> / <sub>16</sub>	36 <sup>3</sup> / <sub>16</sub>	34 <sup>1</sup> / <sub>2</sub>	—	—	155 lbs. 17.1
	WW2436MUCL	Laminate	1989	26 <sup>7</sup> / <sub>16</sub>	36 <sup>3</sup> / <sub>16</sub>	34 <sup>1</sup> / <sub>2</sub>	—	—	155 lbs. 17.1
	WW2436MUCLL	TFL	1591	26 <sup>7</sup> / <sub>16</sub>	36 <sup>3</sup> / <sub>16</sub>	34 <sup>7</sup> / <sub>16</sub>	—	—	155 lbs. 17.1
		<ul style="list-style-type: none"> <li>• Can function as a serving cart or media cart</li> <li>• 1 adjustable shelf behind hinged doors</li> <li>• 4 double wheel non-locking casters standard</li> <li>• Center grommet option available</li> <li>• Random lock core (KRB, KRS) and specified lock core (KS1B, KS1S) available</li> </ul>							
	WW2436MCCW	Wood	\$ 3348	27 <sup>3</sup> / <sub>16</sub>	36 <sup>3</sup> / <sub>16</sub>	43 <sup>1</sup> / <sub>4</sub>	—	—	85 lbs. 24.5
	WW2436MCCL	Laminate	2681	27 <sup>3</sup> / <sub>16</sub>	36 <sup>3</sup> / <sub>16</sub>	43 <sup>1</sup> / <sub>4</sub>	—	—	85 lbs. 24.5
	WW2436MCCLL	TFL	2144	27 <sup>3</sup> / <sub>16</sub>	36 <sup>3</sup> / <sub>16</sub>	43 <sup>3</sup> / <sub>16</sub>	—	—	85 lbs. 24.5
		<ul style="list-style-type: none"> <li>• Do not specify pull, grommet or door finish</li> <li>• Mesh cord manager included</li> <li>• Power director included in worksurface</li> <li>• 4 double wheel locking casters standard</li> <li>• Worksurface height is 28<sup>3</sup>/<sub>16</sub>"</li> <li>• This unit is available with Cinder (462) or Silver Platinum (508) metal components; must specify metal color</li> </ul>							

WAVEWORKS

ASSEMBLED

**TO ORDER, SPECIFY:**

1. Model Number
2. Rim
3. Finish
4. Laminate
5. Paint

**SAMPLE MODEL NUMBER:**

WW243626NKBW F CW

• See pages 356-361 for all options available in WaveWorks

**NESTING TABLE  
KIDNEY SHAPED**



MODEL NO./DESCRIPTION	LIST PRICE	DIMENSIONS					CARTONED CUBIC	
		D	W	H	A	KW	WEIGHT	FEET
WW243626NKBW Wood	\$ 1901	24	36	26 <sup>3</sup> / <sub>4</sub>	—	—	45 lbs.	5.8
WW243626NKBLW Laminate/Wood	1901	24	36	26 <sup>3</sup> / <sub>4</sub>	—	—	45 lbs.	5.8
WW243626NKBL Laminate	1375	24	36	26 <sup>3</sup> / <sub>4</sub>	—	—	45 lbs.	5.8
WW243626NKBLL TFL	1101	24	36	26 <sup>1</sup> / <sub>6</sub>	—	—	45 lbs.	5.8

- Unit shipped with 4 legs
- Table height is 26<sup>3</sup>/<sub>4</sub>"; slides underneath standard worksurface
- Locking casters
- Zip rim option does not have "run-out" on curves of kidney shaped table
- Table leg finishes:
  - 462 Cinder
  - 501 Platinum Metallic
  - 503 Satin Nickel Metallic

**NESTING TABLE  
CONVEX SHAPED**

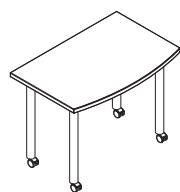

WW243626NCVW Wood	\$ 1901	24	36	26 <sup>3</sup> / <sub>4</sub>	—	—	45 lbs.	5.8
WW243626NCVLW Laminate/Wood	1901	24	36	26 <sup>3</sup> / <sub>4</sub>	—	—	45 lbs.	5.8
WW243626NCVL Laminate	1375	24	36	26 <sup>3</sup> / <sub>4</sub>	—	—	45 lbs.	5.8
WW243626NCVLL TFL	1101	24	36	26 <sup>1</sup> / <sub>6</sub>	—	—	45 lbs.	5.8

- Unit shipped with 4 legs
- Table height is 26<sup>3</sup>/<sub>4</sub>"; slides underneath standard worksurface
- Locking casters
- Table leg finishes:
  - 462 Cinder
  - 501 Platinum Metallic
  - 503 Satin Nickel Metallic

