



CFMOTO

OWNER'S MANUAL



READ THIS MANUAL CAREFULLY
It contains important safety information

CF800 (ZFORCE 800 EX)
4 X 4

This ROV should not be ridden
by anyone under 16 years of age.

ZFORCE
800 EX

WELCOME

Thank you for purchasing a CFMOTO vehicle, and welcome to our world-wide family of CFMOTO enthusiasts. Be sure to visit us online at www.CFMOTO.com for the latest news, new product introductions, upcoming events, career opportunities and more.

CFMOTO develops, manufactures, markets and delivers the world's most reliable and cost-effective motorcycles and scooters, all terrain vehicles, utility vehicles, boat and powersports engines. Founded in 1989 and teaming up with more than 1200 companions, CFMOTO has developed 98 models vehicles and 51 models engines, which are distributed in over 70 countries and regions. CFMOTO is edging into the advanced ranks in the world in the powersports industry and aims at supplying super products to dealers and fans globally.

For safe and enjoyable operation of your vehicle, be sure to follow the instructions and recommendations in this owner's manual. Your manual contains instructions for minor maintenance, but information about major repairs is outlined in the CFMOTO Service Manual. Your CFMOTO dealer knows your vehicle best and is interested in your total satisfaction. Be sure to return to your dealership for all of your service needs during, and after, the warranty period.



 **WARNING**

The engine exhaust from this product contains chemicals known to the State of California to cause cancer, birth defects or other reproductive harm.

Warranty period

The warranty period for this vehicle is 10,000 kilometers (6,200 miles), 1000 hours of engine operation, or 60 calendar months from the original purchase date, whichever comes first.

CFMOTO POWERSPORTS, INC. MAKES NO OTHER WARRANTY OF ANY KIND, EXPRESSED OR IMPLIED. ALL IMPLIED WARRANTIES OF MERCHANTABILITY AND FITNESS FOR A PARTICULAR PURPOSE WHICH EXCEED THE OBLIGATIONS AND TIME LIMITS STATED IN THIS WARRANTY ARE HEREBY DISCLAIMED BY CFMOTO POWERSPORTS, INC. AND EXCLUDED FROM THIS WARRANTY.

SOME STATES DO NOT ALLOW LIMITATIONS ON HOW LONG AN IMPLIED WARRANTY LASTS, SO THE ABOVE LIMITATION MAY NOT APPLY TO YOU. ALSO EXCLUDED FROM THIS WARRANTY ARE ANY INCIDENTAL OR CONSEQUENTIAL DAMAGES INCLUDING LOSS OF USE. SOME STATES DO NOT ALLOW THE EXCLUSION OR LIMITATION OF INCIDENTAL OR CONSEQUENTIAL DAMAGES, SO THE ABOVE EXCLUSION MAY NOT APPLY TO YOU.

THIS WARRANTY GIVES YOU SPECIFIC LEGAL RIGHTS, AND YOU MAY ALSO HAVE OTHER RIGHTS WHICH VARY FROM STATE TO STATE.

CFMOTO POWERSPORTS, INC.
3555 Holly Lane N. Suite#30
Plymouth, MN 55447

TAMPERING WITH NOISE CONTROL SYSTEM PROHIBITED:

Federal law prohibits the following acts or causing thereof:

(1) The removal or rendering inoperative by any person other than for purposes of maintenance, repair, or replacement, of any device or element of design incorporated into any new vehicle for the purpose of noise control prior to its sale or delivery to the ultimate purchaser or while it is in use or (2) the use of the vehicle after such device or element of design has been removed or rendered inoperative by any person.

“AMONG THOSE ACTS PRESUMED TO CONSTITUTE TAMPERING ARE THE ACTS LISTED BE-LOW”.

These acts include tampering with the following systems; i.e., modification, removal, etc.

Exhaust system

- *Muffler*
- *Exhaust*
- *Silencer*

Intake system

- *Air cleaner case*
- *Air cleaner element*
- *Intake duct*

Rider Safety

Signal words

A word that calls attention to a safety message or messages, or a property damage message or messages, and designates a degree or level of hazard seriousness. The signal words in this standard are DANGER, CAUTION and NOTICE.

WARNING

Indicates a hazardous situation which, if not avoided, could result in serious injury or death.

CAUTION

Indicates a hazardous situation which, if not avoided, could result in minor or moderate injury.

NOTICE

Indicates a signal word to address practices not related to personal injury.

 WARNING

Improper operation of this vehicle could result in serious injury or death.

NEVER:

- **operate without necessary guide and training.**
- **operate on road, you may have a traffic collision.**
- **operate at speeds beyond your skills, the conditions and terrain.**
- **overload the vehicle when driving.**
- **operate with more than one passenger.**
- **operate on paved roads - pavement may seriously affect handling and control.**

ALWAYS:

- **use proper driving skills, when driving on hills, rugged roads and sharp turns, to avoid rollover.**
- **wear goggles, helmet and protective clothing.**



ALWAYS USE AN APPROVED, SUITABLE HELMET AND PROTECTIVE GEAR FOR OPERATOR AND PASSENGER.

NEVER USE DRUG OR ALCOHOL BEFORE OR WHEN RIDING.

⚠ WARNING

Read, understand, and follow all of the instructions and safety precautions in this manual and on all product labels. Failure to follow the safety precautions could result in serious injury or death.

Introduction

Thank you for purchasing a CFMOTO vehicle.

This Owner's Manual is intended to acquaint the owner/operator with the various vehicle controls and safe operating instructions. It contains important safety information, driving skills, along with basic maintenance and inspection procedures. If you have any questions regarding the operation or maintenance of your vehicle, please consult a CFMOTO dealer.

CAUTION: Please respect the following instructions to protect your catalytic converter.

- *Use only unleaded gasoline, even if the gasoline contains a little lead. Lead could damage the noble metal contained in catalytic converter and disable it.*
- *Never add the rust preventive oil and engine oil into muffler, otherwise it could disable the catalytic converter.*

EVAP (Evaporative Emission Control System)

Do not modify EVAP, Ensure that all the hoses are not clogged or kinked, otherwise it could damage the fuel pump or distort the fuel tank.

Due to constant improvements in the design and quality of production components, some minor discrepancies may result between the actual vehicle and the information presented in this publication. Depictions and/or procedures in this publication are intended for reference use only.

Table of Contents

FOREWORD

FOREWORD	1
Rider safety.....	1
Introduction.....	4

SAFETY INFORMATION

GENERAL PRECAUTIONS	13
Avoid Carbon Monoxide Poisoning.....	13
Avoid Gasoline Fires and Other Hazards.....	13
Avoid Burns from Hot Parts.....	14
Accessories and Modifications.....	14
SAFE OPERATION - RESPONSIBILITIES	14
Owner - Be Responsible.....	14
Operator - Be Qualified and Responsible.....	15
Riding Carefully.....	16
Occupant Restraint System	17
Terrain Condition.....	17
PRE-RIDE INSPECTION	19
Pre-Ride Inspection Check List.....	19

PREPARE TO RIDE	23
Before you Go.....	23
Riding Gear.....	23
AVOID ACCIDENTS	24
Avoid Rollovers and Tipovers.....	24
Avoid Collisions.....	26
RIDING YOUR VEHICLE	26
Practice Exercises.....	26
Off-Road Operation.....	28
General Riding Techniques.....	29
MOVING LOADS AND DOING WORK	35
Working with your Vehicle.....	35
Carrying Loads.....	35
Hauling a Load.....	37
Pulling a Trailer.....	37
WARNING DECALS AND LOCATION	38
Safety Decals.....	38
 VEHICLE INFORMATION	
PRIMARY CONTROLS	43
Steering Wheels.....	43

Throttle Pedal.....	43
Brake Pedal.....	44
Shift Lever.....	44
SECONDARY CONTROLS.....	46
Ignition Switch.....	46
Horn Switch.....	47
H/L Beam Switch.....	48
2WD/4WD Switch.....	49
Override Switch.....	50
Front Hood.....	50
Winch Switch.....	51
Hazard Switch.....	51
12V DC Outlets.....	52
Clock Button.....	52
SET Button.....	52
MULTIFUNCTION METER.....	53
General Description.....	53
EQUIPMENT.....	57
Footrests.....	59
Glove Box.....	56

Tool Kit.....	59
Glove Compartment.....	59
Passenger Handholds.....	60
Driver Seat.....	60
Passenger Seat.....	60
Seat Belts.....	61
Winch.....	61
Fuel Cap.....	61
Anchoring Hooks.....	61
Hitch Support.....	61
Cargo Box.....	61
SUSPENSION	61
Suspension Adjustment Guideline.....	61
FUEL	62
Recommended Fuel.....	62
Vehicle Fueling Procedure.....	63
BREAK-IN PERIOD	64
Operation During Break-in.....	64
PRE-RIDE INSPECTION	65
BASIC PROCEDURES	66

Starting the Engine.....	67
Shifting the Transmission.....	67
SPECIAL PROCEDUES.....	68
Cleaning the CVT Inlet.....	68
What to do if Water Collects in CVT.....	68
What to do if Vehicle is Submerged.....	68
Transporting the Vehicle.....	68
MAINTENANCE SCHEDULE.....	70
Severe Use Definition.....	70
Maintenance Chart Key.....	71
Lubrication Recommendations.....	72
Lubrication Chart.....	72
MAINTENANCE PROCEDURES.....	73
Air Filter.....	73
Spark Arrestor.....	74
Engine Oil.....	75
Rear Gearcase Oil.....	78
Front Differential Oil.....	79
Cooling System.....	80
Spark Plugs.....	83
Battery.....	85

Fuses.....	86
Lights.....	88
Drive Shaft Boots.....	89
Wheel Bearing.....	89
Wheel and Tires.....	89
Suspension.....	90
Brakes.....	90
Throttle Body.....	92
Valve Clearance Adjustment.....	92
VEHICLE IDENTIFICATIONS	
VEHICLE IDENTIFICATIONS	93
Engine Identification Number.....	93
Vehicle Identification Number.....	94
SPECIFICATIONS	
SPECIFICATIONS	95
TROUBLESHOOTING	

TROUBLESHOOTING GUIDELINES.....	100
TROUBLESHOOTING THE EFI SYSTEM.....	105

General Precautions

Avoid Carbon Monoxide Poisoning

All engine exhaust contains carbon monoxide, a deadly gas. Breathing carbon monoxide can cause headaches, dizziness, drowsiness, nausea, confusion and eventually death.

Carbon monoxide is a colorless, odorless, tasteless gas that may be present even if you do not see or smell any engine exhaust. Deadly levels of carbon monoxide can collect rapidly, and you can quickly be overcome and unable to save yourself. Also, deadly levels of carbon monoxide can linger for hours or days in enclosed or poorly ventilated areas.

To prevent serious injury or death from carbon monoxide:

- Never run the vehicle in poorly ventilated or partially enclosed areas.
- Never run the vehicle outdoor where engine exhaust can be drawn into a building through openings such as windows and doors.

Avoid Gasoline Fires and Other Hazards

Gasoline is extremely flammable and highly explosive. Fuel vapors can spread and be ignited by a spark or flame many feet away from the engine.

To reduce the risk of fire or explosion, follow these instructions:

- Use only an approved gasoline container to store fuel.
- Never fill the gasoline container in the vehicle cargo box or on the vehicle - an electrical static discharge may ignite the fuel.
- Strictly adhere to fueling procedure.
- Never start or operate the engine if the fuel cap is not properly installed.

Gasoline is poisonous and can cause injury or death.

- Never siphon gasoline by mouth.
- If you swallow gasoline, get any in your eye(s), or inhale gasoline vapor, see a doctor immediately.
- If gasoline spills on you, wash with soap and

– water and change your clothes.

Avoid Burns from Hot Parts

The exhaust system and engine become hot during operation. Avoid contact during and shortly after operation to avoid burns.

Accessories and Modifications

We are concerned for the safety of our customers and for the general public. Therefore, it's strongly recommended not to install on a CFMOTO vehicle any equipment that may increase the speed or power of the vehicle, or make any other modifications to the vehicle for these purposes. Since modifications to your vehicle may negatively impact vehicle stability and result in serious injury or death.

The warranty on your CFMOTO vehicle is terminated if any equipment has been added to the vehicle, or if any modifications have been made to the vehicle, that increase its speed or power.

NOTE: The addition of certain accessories,

and familiarize yourself with their function and effect on the vehicle.

Safe Operation - Responsibilities

Owner - Be Responsible

Read this Owner's Manual thoroughly and take a training course if available.

Always inspect and confirm the safe operating condition of your vehicle prior to ride.

Always follow the maintenance schedule described in this Owner's Manual.

Never allow anyone to operate your vehicle unless they have read this Owner's Manual and warning decals on this vehicle and can fully understand them. Advise your new drivers of vehicle operation, driving rules and limits(e.g., whether they can carry passenger, what they may do with the vehicle, where they may ride, etc). Be sure that all operators and passengers meet the qualifications below and agree to follow the safety information.

Operator - Be Qualified and Responsible

Read this Owner's Manual and the warning decals on this vehicle carefully. Take a safety training on open areas if available. Practice at low speeds. Higher speeds require greater experience, knowledge and suitable riding conditions. Become completely familiar with the operational controls and the general operation of the vehicle.

This vehicle is an ADULT VEHICLE ONLY. Operation is prohibited for anyone under 16 years of age. Be tall enough to be properly seated: back against the backrest with the seat belt fastened, to hold the steering wheel with both hands and still be able to reach the full stroke of brake and throttle pedals with the right foot and to firmly plant left foot on the footrest.

Have a proper driver's license in accordance with local laws.

Carrying Passenger

Only carry one passenger. The passenger must be properly seated in the passenger seat.

The passenger must be at least 12 years old and tall enough to always be properly seated: back against the backrest with seat belt fastened, holding both handholds, and feet firmly planted - right foot on the footrest and the left foot on the vehicle floor.

Never carry a passenger who has used drugs or alcohol, or is tired or ill. These slow reaction time and impair judgment.

Instruct the passenger to read the vehicle's safety labels.

Never carry a passenger if you judge his ability or judgement insufficient to concentrate on the terrain conditions and adapt accordingly. More specifically for side-by-side vehicles, the passenger must also pay constant attention to the terrain ahead and be able to brace for bumps.

Riding Carefully

- This vehicle is not a toy and can be hazardous to operate. This vehicle handles differently from other vehicles, such as motorcycles, cars. A collision or rollover can occur quickly, during abrupt maneuvers such as doing sharp turns, acceleration or deceleration and driving on hills or over obstacles, if you fail to take proper precautions.
- Never operate at excessive speeds. Always go at a speed that is proper for the terrain, visibility, and operating conditions, and your experience.
- Never attempt jumps, side slides, donuts or any other stunts.
- Never attempt rapid acceleration or deceleration when performing a sharp turn. This may result in a roll over. Never attempt skidding or sliding. If vehicle starts to skid or slide, counter steer in the direction of skidding or sliding. On extremely slippery surfaces, such as ice, go slowly and be very cautious in or-

der to reduce the chance of skidding out of control.

- Always be sure there are no obstacles or people behind the vehicle when reversing. Pay attention to blind spots. When it is safe to proceed in reverse, go slowly.
- Never exceed the stated load limits for this vehicle. Cargo must be properly secured. Reduce speed, allow for greater braking distance and follow other instructions in this manual.
- Ensure that the cargo is well distributed in cargo box. Otherwise, it could change the center-of-gravity and may result in rollover.

The Roll Over Protection System (ROPS)

The ROPS on this vehicle meets the performance requirements of ISO 3471:2008. The ROPS can limit intrusions of outside objects and reduce your risk of injury in rollovers.

Always follow all safe operating practices outlined in this manual to avoid vehicle rollover.

Do not put your hands and/or feet outside of the vehicle when driving. The ROPS will not protect you from injury in all rollovers.

Always have your authorized CFMOTO dealer thoroughly inspect the ROPS if it ever becomes damaged in any way.

Occupant Restraint System

- This vehicle is designed to carry one driver and one passenger, both wearing proper protective gears.
- The driver and passenger must latch the side doors and wear the seat belts at all times when riding.

Terrain Condition

- Avoid sharp turns, abrupt acceleration and sudden braking when passing public roads.
- Always go slowly and be extra careful when operating on unfamiliar terrain. Always be alert to changing terrain conditions when operating this vehicle. Take the time to learn how the vehicle performs in different environments.

- Never operate on excessively rough, slippery or loose terrain until you have learned and practiced the skills necessary to control this vehicle on such terrain. Always be especially cautious on these kinds of terrain.
- Never operate this vehicle on hills too steep for the vehicle or your abilities. Practice on small inclines.
- Always follow proper procedures for climbing or going down hills. Never go over the top of any hill at high speed.
- Never attempt steep hills or side hilling when pulling a trailer.
- Always check for obstacles before operating in a new area. Always follow proper procedures when operating over obstacles or fallen trees.
- Never operate this vehicle in deeper water or fast flowing water. Remember that wet brakes may have reduced stopping ability. Test your brakes after leaving water. If necessary, apply them several times to let fric-

- tion dry out the brakes.
- Always ensure to properly park the vehicle on the flattest terrain section available. Put shift lever in PARK, stop engine, remove key before leaving the vehicle.
 - Never assume that the vehicle will go everywhere safely. Sudden changes in terrain caused by holes, depressions, banks, softer or harder "ground" or other irregularities may cause the vehicle to topple or become unstable. To avoid this, slow down and always observe the terrain ahead. If the vehicle begins to topple or rollover, the best advice is to immediately steer in the direction of the rollover. Never attempt to prevent a rollover with your arms or legs. You should keep your limbs inside the cage.

Pre-ride Inspection

Always inspect and confirm the safe operating condition of your vehicle prior to ride. Always follow the maintenance schedule described in this Owner's Manual.

WARNING

Perform a pre-ride inspection before each ride to detect any potential problem that could occur during operation. The pre-ride inspection can help you monitor component wear and deterioration before they become a problem.

Pre-Ride Inspection Check List

What to Do Before Starting the Engine (Key OFF)

ITEM	INSPECTION TO PERFORM	REMARKS
Tires	Check tire pressure and condition. Front: 70 kPa (10 PSI) Rear: 100 kPa (14 PSI)	
Wheels	Check wheels and wheel nuts for damage.	
Radiator	Check cleanliness of the radiator.	
Engine oil	Check engine oil level.	
Coolant	Check coolant level.	
Air filter	Inspect the air filter.	
Drive shaft boots	Check drive shaft and drive shaft boots conditions.	

ITEM	INSPECTION TO PERFORM	REMARKS
Cargo and load	<p>Cargo Load: If you transport a cargo, respect the rear cargo box capacity of 100 kg(220.31 lb). Ensure cargo is properly secured to the rear cargo box.</p> <p>Vehicle Load: Ensure that total load on the vehicle (including operator, passenger, cargo and added cargo and load accessories) does not exceed 315 kg(694lb).</p>	
	<p>If you are pulling a trailer or another equipment:</p> <ul style="list-style-type: none"> * Check hitch and trailer ball condition. * Respect the tongue capacity and towing capacity. * Ensure trailer is properly secured to hitch. 	
Rear cargo box	Check if the cargo box is properly latched.	
	Check if the tail gate is properly latched.	
Chassis and suspension	Check underneath vehicle for any debris on chassis or suspension and clean them properly.	

What to Do Before Starting the Engine (Key ON)

ITEMS	INSPECTION TO PERFORM	REMARKS
Dashboard	Check operation of indicator lights in dashboard.	
	Check for messages in dashboard.	
Lights and reflectors	Check cleanliness of headlights, taillights, turn signals, position lights and reflectors.	
	Check operation of headlights (high and low beams), brake lights, turn signals and position lights.	
	Check operation of hazard lights.	
Seats, side nets and seat belts	Check if seats are properly latched.	
	Check if side doors are properly latched.	
	Check seat belts for any damage. Fasten seat belts and confirm that they latch securely.	
Throttle pedal	Press on the throttle pedal a few times to ensure it operates freely and it returns to the rest position when released.	
Brake pedal	Press down on the brake pedal and make sure you feel firm resistance and that it fully returns to position when released.	
Fuel level	Check the fuel level.	
Horn	Check horn operation.	
Mirrors	Adjust mirrors to proper positions.	

What to Do After the Engine is Started

ITEMS	INSPECTION TO PERFORM	REMARKS
Steering	Check if steering operates freely by completely turning it from side to side.	
Ignition switch	Turn the ignition switch to OFF to verify if engine will shut down. Restart engine.	
Shift lever	Check operation of shift lever (P, R, N, H and L).	
2WD/4WD and 4WD/LOCK switch	Check operation of 2WD/4WD and 4WD/LOCK switches.	
Brakes	Drive forward slowly a few feet and apply brakes. The brake pedal must feel firm when applied. The pedal must return to rest position when released. The brakes must respond adequately to the driver's input.	

Prepare To Ride

Before you Go

Perform pre-ride inspection to confirm the safe operating condition of your vehicle.

Refer to PRE-RIDE INSPECTION subsection.

Driver and passenger must:

- Be properly seated.
- Latch both side nets and fasten seat belt.
- Wear appropriate riding gear. (Refer to RIDING GEAR subsection below.)

Riding Gear

It is important that the operator and passenger always wears appropriate protective clothing and apparel.

1. Helmet

An approved helmet can protect the head and brain from injury.

2. Eye Protection

Ordinary glasses or sunglasses are not sufficient eye protection for riders. They

can shatter or fly off, and they allow wind and airborne objects to reach the eyes. A helmet with face protection or a pair of goggles offer better eye protection. Eye protection must be shatterproof and kept clean.

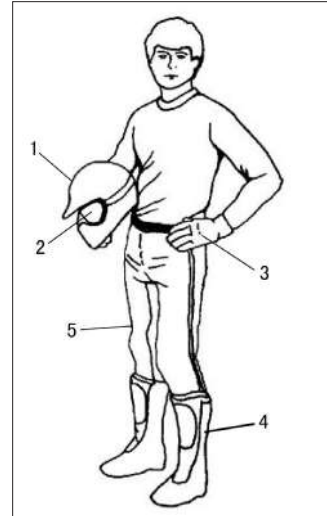

3. Gloves

A pair of off-road gloves with knuckle protection can protect your hands in the event of an accident or a rollover.

4. Boots

Sturdy over-the-ankle boots with non-slip soles offer more protection and allow you to plant your foot properly on footrest.

5. Clothing

Wear long sleeves and long pants to protect arms and legs. Pants with knee protection and jackets with shoulder protection offer better protection for riders.

Avoid Accidents

Avoid Rollovers and Tipovers

Side-by-side vehicles handle differently from other vehicles. Side-by-side vehicles are designed to handle off-road terrain (for example, their wheel base and track width, ground clearance, suspension, drivetrain, tires, etc.), and, as a result, can overturn in situations where

vehicles designed for use primarily on paved or smooth terrain may not.

A rollover or other accident can occur quickly during abrupt maneuvers such as sharp turns or hard acceleration or deceleration when turning, or when driving on hills or over obstacles. Abrupt maneuvers or aggressive driving can cause rollovers or loss of control even in flat open areas. If the vehicle rolls over, any part of your body (such as arms, legs, or head) outside of the cab can be crushed and trapped by the cage or other parts of the vehicle. You can also be injured by impact with the ground, cab or other objects.

To reduce the risk of rollovers:

Use care when turning.

- Adjust steering inputs accordingly to your speed and environment.
- Slow down before entering a turn. Avoid hard braking during a turn.
- Avoid sudden or hard acceleration when turning, even from a stop or low speed.

- * Never attempt donuts, skids, slides, fishtails, jumps, or other stunts. If vehicle starts to skid or slide, steer in the direction of the skid or slide. Never slam the brakes and lock the wheels.
- * This vehicle is built primarily for OFF-ROAD purposes. Riding on paved surfaces may seriously affect vehicle handling and control - if you must drive on paved surfaces for a short distance, reduce speed and avoid abrupt inputs to steering wheel, accelerator and brake pedals.

This vehicle can roll over sideways or tip over forward or backwards on slopes or uneven terrain.

- * Avoid side hilling (driving along the slope rather than up or down a hill). When possible, drive straight up and down inclines rather than across them. If you must side hill, use extreme caution and avoid slippery surfaces, objects, or depressions. If you feel the vehicle start to rollover or slide sideways,

steer downhill if possible.

- * Avoid steep hills and follow procedures in this manual for climbing and descending hills.
- * Sudden changes in terrain such as holes, depressions, banks, softer or harder ground or other irregularities may cause the vehicle to tip or become unstable. Observe the terrain ahead and slow down in areas of uneven terrain.

This vehicle will handle differently when carrying or pulling a load.

- * Reduce speed and follow instructions in this manual for carrying cargo or pulling a trailer.
- * Avoid hills and rough terrain.
- * Allow more distance to stop.

Be prepared in case of rollover

- * Latch side doors and fasten seat belt to help you avoid sticking out arms or legs.
- * Never grab the cage while riding. Hands

can be crushed between the cage and the ground in a rollover. Keep hands on the steering wheel or handholds.

- * Never try to stop a rollover using your arms or legs. If you think that the vehicle may tip or roll, the driver should keep both hands on the steering wheel and the left foot firmly planted on the floor. The passenger should keep both hands on the handholds and both feet firmly planted on the floor.

Avoid Collisions

At higher speeds, there is an increased risk of losing control, particularly in challenging off-road conditions, and the risk of injury in a collision is greater. Never operate at excessive speeds. Always go at a speed that is proper for the terrain, visibility, and operating conditions, and your experience. This vehicle does not have the same kind of protection for collisions as a car; for example, there are no air bags, the cab is not fully enclosed, and it is not designed for collisions with other vehicles. Therefore, it

is particularly important to fasten seat belts and latch side doors and wear proper riding gear.

Riding Your Vehicle Practice Exercises

Before you go out for a ride, it is very important to familiarize yourself with the handling of your vehicle by practicing in a controlled environment. Find a suitable area to practice and perform the following exercises. It should be at least 45 m by 45 m, free of obstacles like trees and rocks.

Turning Exercises

Turning is one of the most frequent causes of accidents. It is easier for the vehicle to lose traction or rollover if you turn too sharply, or go too fast. Slow down when you approach a turn.

- * First learn how to perform slight right turns at very low speeds. Release the throttle before turning and slowly reapply the throttle

when turning.

- * Repeat turning exercise but this time maintain the throttle at the same level while turning.
- * Finally, repeat turning exercise while accelerating slowly.
- * Practice exercises turning on the other side.

Note how your vehicle reacts in these different exercises. We recommend releasing the throttle before entering a turn to help initiate directional change. You will feel the lateral force increasing with the speed and with your steering input. The lateral force should be maintained as low as possible to make sure it does not cause the vehicle to roll over.

U turn Exercises

Practice doing U turns.

- * Accelerate slowly and while remaining at low speed, gradually turn the steering wheel to the right until you have completed the U turn. Repeat U turn exercise with different

steering inputs and always at a very low speed.

- * Repeat U turn exercise on the other side.

As mentioned before in this manual, do not ride on paved surfaces as the vehicle behavior will not be the same, increasing the risk of roll-over.

Braking Exercises

Practice braking to get familiar with the brake response.

- * Do it at low speed first, then increase the speed.
- * Practice braking in straight line at different speeds and different braking force.
- * Practice emergency braking; optimal braking is obtained in straight line, with high force applied, without locking the wheels.

Remember, braking distance depends on vehicle speed, load and the type of surface. Also, the tires and brakes conditions play a major

role.

Reverse Exercises

The next step involves using the reverse.

- * Install 1 cone marker on both sides of the vehicle beside each rear wheel. Move the vehicle forward until you can see the cone markers, then stop the vehicle. Acknowledge the distance required to see obstacles behind you.
- * Learn how the vehicle handles itself in reverse and reacts with steering inputs.
- * Always perform this reverse exercise at slow speeds.
- * Become familiar with the usage of the override function. Do not steer while using the override as it increases the risks of rollover

Emergency Engine Stopping Exercise

Learn how to stop your engine quickly in an emergency situation.

- * While running at low speed, simply turn the ignition key to the off position.

This is to familiarize you with the vehicle's reaction when the engine is turned off while driving and to develop this reflex.

Off-Road Operation

The very nature of off-road operation is dangerous. Any terrain, which has not been specially prepared to carry vehicles, presents an inherent danger where terrain substance, shape and steepness are unpredictable. The terrain itself presents a continual element of danger, which must be knowingly accepted by anyone venturing over it.

An operator who takes a vehicle off-road should always exercise the utmost care in selecting the safest path and keeping close watch on the terrain ahead of him. The vehicle should never be operated by anyone who is not completely familiar with the driving instructions applicable to the vehicle, nor should it be

operated on steep or treacherous terrain.

General Riding Techniques

General Driving Tips

Care, caution, experience and driving skill are the best precautions against the hazards of vehicle operation. Whenever there is the slightest doubt that the vehicle can safely negotiate an obstacle or a particular piece of terrain, always choose an alternate route. In off-road operation, power and traction, not speed, are important. Never drive faster than visibility and your own ability to select a safe route permit. Never operate the vehicle if the controls do not function normally. See your dealer. Operating in Reverse

When operating in reverse, check that the path behind the vehicle is free of people or obstacles. Pay attention to blind spots. When it is safe to proceed in reverse, go slowly and avoid sharp turns.

WARNING

Steering inputs in reverse operation increase the risk of rollover.

NOTE: In reverse operation, the engine RPM is limited thus limiting the vehicle reverse speed.

WARNING

When driving downhill in reverse, gravity can increase the vehicle speed above the set limited reverse speed.

Crossing Roads

If you have to cross a road, ensure to have complete visibility on both sides for incoming traffic and decide on exit point on other side of road. Drive in a straight line toward that point. Do not make sharp direction changes or abrupt accelerations as it may result in a rollover situation. Do not travel on sidewalks or bicycle

trails as they are designated specifically for those uses.

Riding on Paved Surfaces

Avoid paved surfaces. This vehicle is not designed to operate on paved surfaces and is more likely to roll over. If you must drive on pavement, turn gradually, go slowly, and avoid abrupt acceleration and braking.

Shallow Water Crossing

Water can be a unique hazard. If it is too deep the vehicle may “float” and topple. Check the water depth and current before you attempt to cross any water. Water depth should not exceed 60 cm(23.6 inches) for vehicle to safely cross the obstacle. Beware of slippery surfaces such as rocks, grass, logs, etc., both in the water and on its banks. A loss of traction may occur. Do not attempt to enter the water at high speed.

Water will affect the braking ability of your vehicle. Make sure you dry the brakes by applying them several times after the vehicle leaves the water.

Riding on Snow or Ice

When performing pre-ride inspection, pay special attention to locations on the vehicle where snow and/or ice accumulations may obstruct visibility of the tail lamp, clog ventilation openings, block the radiator and fan, and interfere with the movement of controls. Before starting with your vehicle, check the steering, throttle and brake pedals for interference free operation.

Whenever this vehicle is ridden on a snow covered drive path, the tire grip is generally reduced causing the vehicle to react differently to control inputs from the operator.

Riding on Sand

Sand and riding on sand dunes is another unique experience but there are some basic precautions that should be observed. Wet, deep or fine sand may create a loss of traction and cause the vehicle to slide, drop off or become “bogged” down. If this occurs look for a firmer base. Again, the best advice is to slow down and be watchful of the conditions.

When riding in sand dunes it is advisable to equip the vehicle with an antenna type safety flag. This will help make your location more visible to others over the next sand dune. Proceed carefully should you see another safety flag ahead.

Riding on Gravel, Loose Stones or Other Slippery Surfaces

Riding on loose stones or gravel is very similar to riding on ice. They will affect the steering of vehicle, possibly causing it to slide and tip over especially at high speeds. In addition, braking distance may be affected. Remember that “gunning” the throttle or sliding may cause loose stones to be ejected rearwards and could hit other people.

Crossing Obstacles

Obstacles on the “trail” should be traversed with caution. This includes rocks, fallen trees, and depressions. You should avoid them whenever possible. Remember that some obstacles are too large or dangerous to cross and should be avoided. As a guideline, never attempt to cross an obstacle higher than the ground clearance of the vehicle. Small rocks or small fallen trees may be safely crossed - approach obstacle at low speed and as much as pos-

sible at a right angle. Adjust speed without losing momentum and do not accelerate abruptly. Passenger must grasp handholds firmly and brace feet on the floor.

Hill Driving Conditions

When driving on hills or slopes, two things are highly important: be prepared for slippery surfaces or terrain variations and obstacles and brace yourself properly inside vehicle. If you climb or descend a hill that is too slippery or has too loose a surface, you can lose control. If you go over the top of a hill at high speed, you may not have time to prepare for the terrain on the other side. Avoid parking on a slope. Always put the shift lever in PARK when stopped or parked, especially on an incline, to avoid rolling. If you must park on a steep incline, block the wheels using rocks or bricks.

Uphill Driving

Use the low range (L) for uphill driving. Due to its configuration, this vehicle has very good traction even while climbing, so much so that tip over is possible before traction is lost. For example, it is common to encounter terrain situations where the top of the hill has eroded to a point that the hill peak rises very sharply. This vehicle is not designed to negotiate such a condition. Take an alternate route.

If you feel that the slope is getting too steep to climb, apply brakes to immobilize vehicle. Put shift lever in reverse (R), and back down the hill, barely releasing brakes to remain at low speed.

Do not attempt to turn around. Never coast down hill while vehicle is in neutral. Do not perform hard braking as it increases the risk of tipover.

Downhill Driving

This vehicle can climb steeper slopes than it can descend safely. Therefore, it is essential to assure that a safe route exists to descend a slope before you climb it. Decelerating while negotiating a slippery downhill slope could “toboggan” the vehicle, causing it to slide. Maintain steady speed and/or accelerate slightly to regain control. Never slam brakes and lock the wheels.

Side Hilling

WARNING

Improper side hilling or turning on hills could cause the vehicle to be out of control or roll over and may result in serious injury or death.

Whenever possible, side hilling (driving across a slope rather than up or down it) should be avoided. If necessary, do so with extreme caution. Side hilling on steep inclines could result in rollover. Avoid all objects or depressions that will intensify the raising of one side of the vehicle higher than the other, thus causing rollover. If you feel the vehicle start to rollover or slide sideways, steer downhill if possible.

Recreational, Group and Distance Riding

Stay away from areas designated for other types of off road use. This includes snowmobile trails, equestrian trails, cross country ski trails, mountain bike trails, etc.

Join a local side-by-side vehicle club. It will provide you with a map and advice or inform you where you can ride. Never ride under the influence of alcohol or drugs, or tired or ill.

Always keep a safe distance from other riders.

Environment

One of the benefits of this vehicle is that it can take you off the beaten path away from most communities. However, you should always respect nature and the rights of others to enjoy it.

Chasing wildlife is illegal in many areas. Wildlife can die of exhaustion after being chased by a motorized vehicle.

Observe the rule... “what you take in, carry out.” Do not litter.

Moving Loads and Doing Work

Working with your Vehicle

Your vehicle can help you perform a number of different light tasks ranging from snow removal to pulling wood or carrying cargo. The equipped accessories can change the vehicle handling. To prevent possible injury, follow the instructions and warnings in this manual and on the vehicle.

Always respect the load limits of the vehicle. Overloading the vehicle can overstress the components and cause failure.

Carrying Loads

The load limit of the vehicle, including the weight of operator, passenger, cargo, accessories and trailer tongue weight: 315 kg (694 lb).

Following are examples of suitable total vehicle load distribution:

EXAMPLES OF SUITABLE VEHICLE TOTAL LOADS				
Operator and Passenger	Cargo Box Load	Accessories	Tongue Weight	Total Vehicle Load
250 kg (550 lb)	100 kg (220.31 lb)	4.8 kg (10.6 lb)	50 kg (110 lb)	315 kg (694 lb)

Vehicle Settings When Carrying Load

When the total load exceeds 315 kg, including weight of operator, passenger, cargo, accessories and trailer tongue weight, inflate the tires to maximum pressure 70 kPa (10 PSI) Front, 100 kPa (14 PSI) Rear.

NOTE: When carrying heavy loads in cargo box, readjust suspension accordingly.

NOTE: When carrying heavy loads in cargo box or pulling a trailer, operate with the shift lever in L (low range).

Loading the Cargo Box

Cargo box load capacity: 100 kg (220.3 lb)

Operating While Carrying a Load

Reduce your speed when carrying cargo and turn gradually. Avoid hills and rough terrain. Allow more distance for braking.

WARNING

Never operate when fully loaded on hills steeper than 15 degrees.

Tilting the Cargo Box

The cargo box can be tilted to ease unloading. Use release handles on either side of cargo box.

WARNING

- * Always ensure no one is standing behind the cargo box before you actuate the release handle.
- * The load weight may affect the operation of the cargo box tilting feature (tilting or lowering).

To lower the cargo box, simply push on the cargo box.

⚠ WARNING

- * Keep yourself and others clear of the cargo box and vehicle frame junction when lowering cargo box.
- * Ensure to securely latch the cargo box and the tailgates before riding.

Hauling a Load

Never pull a load by attaching it to the cage; this can cause the vehicle to tip over. Use only the trailer hitch or winch (if installed) to pull a load.

When pulling loads with a chain or cable, ensure that there is no slack before starting and maintain tension while pulling.

When hauling a load, respect the maximum hauling capacity.

⚠ WARNING

Slack can cause the chain or cable to break and snap back.

When pulling another vehicle, be sure that someone is controlling the pulled vehicle. They must brake and steer to prevent the vehicle from going out of control. Before pulling loads with a winch, refer to the winch Owner's Manual. Reduce your speed when hauling a load and turn gradually. Avoid hills and rough terrain. Never attempt steep hills. Allow more distance for braking, especially on inclined surfaces. Be careful not to skid or slide.

Pulling a Trailer

If a trailer is used behind the vehicle make sure that its hitch is compatible with the one on the vehicle. Make sure the trailer is horizontal with the vehicle. Use security chains or cables to secure the trailer with the vehicle.

Improperly loading a trailer may cause loss of control. Respect the recommended maximum

hauling capacity and maximum tongue load. Make sure there is at least some weight on the tongue.

Always make sure load is evenly distributed and safely secured on the trailer; an evenly balanced trailer is easier to control.

Always put the shift lever to L (low range) for hauling a trailer .

When stopped or parked, block the vehicle and trailer wheels from possible movement.

Use caution when disconnecting a loaded trailer; it or its load may topple on you or others.

When hauling a trailer, respect the following maximum hauling capacity.

MAXIMUM HAULING CAPACITY			
Type of Attachment	Trailer Load Allowed	Tongue Weight Allowed	Note
50.8 mm X 50.8 mm hitch ball support	250 kg (550 lb)	50 kg (110 lb)	Includes trailer and trailer load.

Warning Labels and Location Safety Labels

Warning labels have been placed on the vehicle for your protection. Read and follow the instructions of the labels on the vehicle carefully.

If any label becomes illegible or comes off, contact your dealer for the replacement.

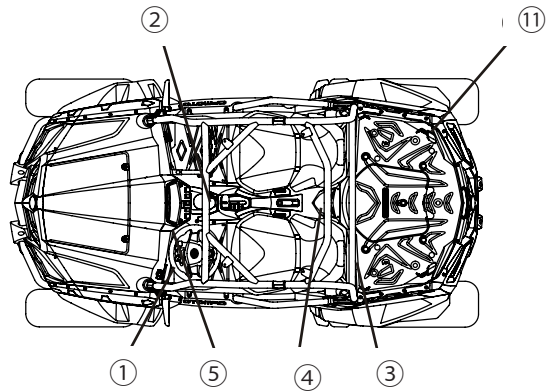
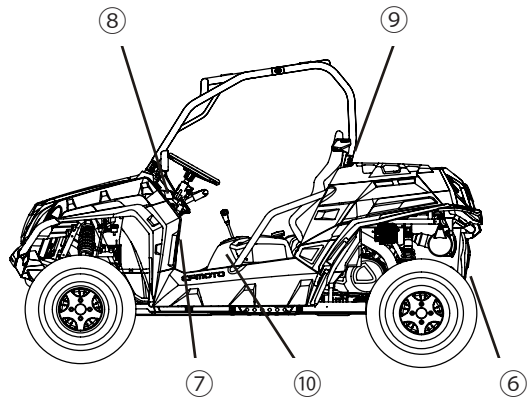

1

⚠ WARNING

Improper Use of Off-Highway Vehicles Can Cause Severe Injury or Death

This off-highway utility vehicle will handle and maneuver differently from an ordinary passenger car or other vehicle.

- Vehicle capacity: 1 operator and 1 passenger. Passenger must be able to reach and hold the handgrip inside enclosure.
- This vehicle is recommended only for operators 16 and older with a valid motor vehicle license. Adults must supervise use by minors. Check state laws for minimum age requirements.
- Gross Vehicle Weight Rating: 1940lbs (880kg) maximum including operator, passenger, accessories and cargo.
- Passenger and cargo can affect vehicle handling.

Be Sure Riders Pay Attention and Plan Ahead

If you think or feel the vehicle may tip or roll, reduce your risk to injury:

- Keep a firm grip on the steering wheel or handholds and brace yourself.
- Do not put any part of your body outside of the vehicle for any reason.

Be Prepared

- Fasten seat belts.
- Wear an approved helmet and protective gear.
- Always secure cab nets.
- Each rider must be able to sit with back against seat, feet flat on floor, and hands on steering wheel or handholds. Stay completely inside the vehicle.

Locate and Read Owner's Manual
Follow All Instruction and Warnings



7000-190201
US1303

2

⚠ WARNING

Improper Use of Off-Highway Vehicles Can Cause Severe Injury or Death

Drive Responsibly
Avoid loss of control and rollovers:

- Avoid abrupt maneuvers, sideways sliding, skidding, or fishtailing, and never do donuts.
- Slow down before entering a turn.
- Avoid hard acceleration when turning, even from a stop.
- Plan for hills, rough terrain, ruts, and other changes in traction and terrain. Avoid paved surfaces.
- Avoid side hilling (riding across slopes).

Rollovers have caused severe injuries and death, even on flat, open areas.



Require Proper Use of Your Vehicle
Do your part to prevent injuries:

- Do not allow careless or reckless driving. Make sure operators are 16 or older with a valid driver's license.
- Do not let people drive or ride after using alcohol or drugs.
- Do not allow operation on public roads-collisions with cars and trucks can occur.
- Do not exceed seating capacity: 1 passenger.

Locate and Read Owner's Manual
Follow All Instruction and Warnings



3

⚠ WARNING

Severe INJURY or DEATH can result if you ignore the following:

- Maximum Load in Cargo Bed: 100kg (220lbs).
- Never carry passengers in cargo bed.
- Cargo can affect handling and stability. Read Owner's Manual before loading or towing.
- When loading with cargo or towing a trailer: Reduce speed and allow more room to stop. Avoid hills and rough terrain.
- Be sure cargo is secured - a loose load could change handling unexpectedly.
- Keep weight in the cargo bed centered, and as low and far forward as possible. Top - heavy loads increase the risk of overturn.



7000-190204 US1303

④



⑤



⑦



⑥

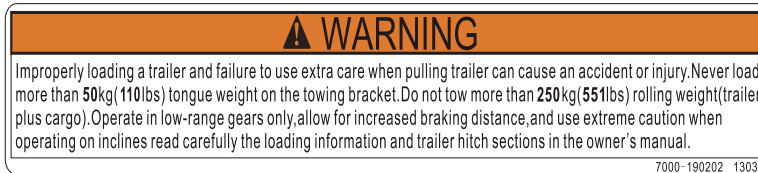

8

⚠ WARNING

Turning the off road vehicle in 4WD-LOCK ("DIFF. LOCK") takes more effort.
Operate at a slow speed and allow extra time and distance for maneuvers to avoid loss of control.

9

The ROPS meets the performance requirements of ISO 3471:2008.

Vehicle model: CF800
m=700 kg for ISO 3471:2008

9060-190203 US1310

CFMOTO

10

⚠ WARNING

Improper tire pressure or overloading can cause loss of control. Loss of control can result in severe injury or death.

- Cold tire pressure:
 - Front: **10 psi (70 kPa)**
 - Rear: **14 psi (100 kPa)**
- Maximum weight capacity: **694lbs. (315kg)**

7000-190203 US1303

11

⚠ WARNING

REMOVAL OF THIS MUFFLER IS A VIOLATION OF CLEAN AIR ACT § 203 AND CONSIDERED TAMPERING. VIOLATORS ARE SUBJECT TO A FEDERAL FINE OF UP TO \$37,500 PER OCCURRENCE.

This label may NOT be removed except by the consumer.

Primary Controls

1) Steering Wheel

The steering wheel is located in front of the operator's seat.

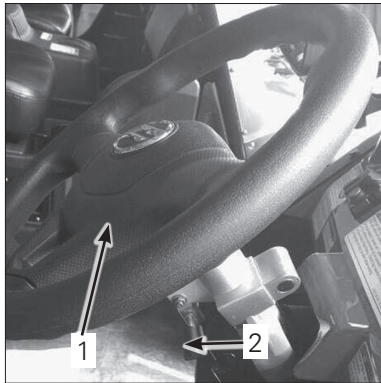

1. *Steering wheel*

2. *Tilt lever*

It can be adjusted to fit the operator's height.

2) Throttle pedal

The throttle pedal is located on the right side of the brake pedal.

The throttle pedal controls the engine speed.

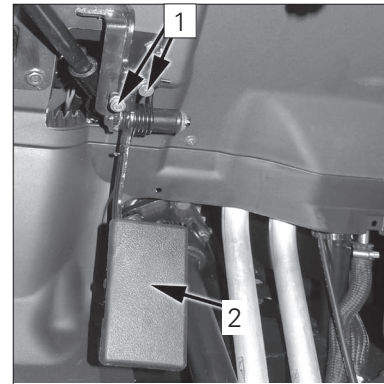

1. *Bolt*

2. *Throttle pedal*

To control vehicle speed, press on the throttle pedal with your right foot, check the pedal before driving.

3) Brake Pedal

The brake pedal is located on the left side of the throttle pedal.

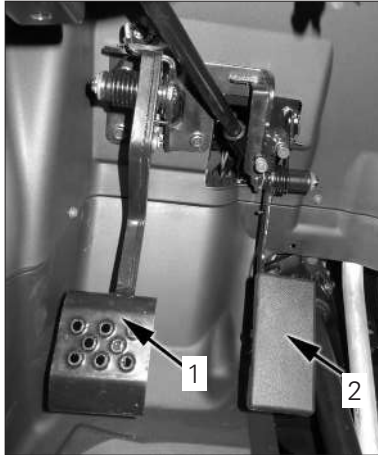

- 1. Brake pedal
- 2. Throttle pedal

4) Shift Lever

The shift lever is located on the right of the driver's seat. The shift lever is used to change the gearbox position.

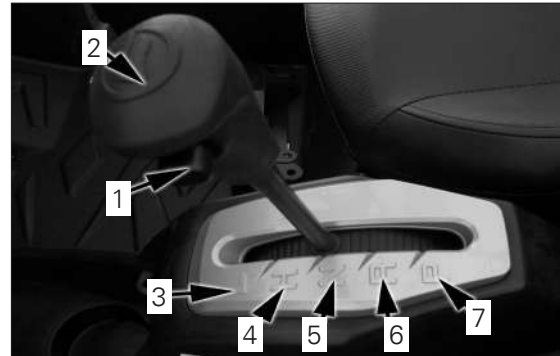

- 1. Shift button
- 2. Shift lever
- 3. L range
- 4. H range
- 5. Neutral
- 6. Reverse
- 7. Park

Shift Button

Press shift button before shifting the gear.

L Range

This position selects the low speed range of the gearbox. It allows the vehicle to move slowly with maximum torque at the wheels.

CAUTION

Use the low speed range to pull a trailer, carry heavy cargo, go over obstacles or drive uphill and downhill.

High Range

This position selects the high speed range of the gearbox. It is the normal driving speed range. It allows the vehicle to reach its maximum speed.

Neutral

Disengages the engine power take-off.

Reverse

The reverse position allows the vehicle to go backwards.

NOTE: In reverse operation, the engine's RPM is limited, thus limiting the vehicle reverse speed under 25 km/ h (15.5 mile/ h).

WARNING

When driving downhill in reverse, gravity can increase the vehicle speed above the set limited reverse speed.

Park

The park position locks the gearbox to help prevent vehicle movement.

WARNING

Always use the PARK (P) position when the vehicle is not in operation. The vehicle can roll if the shift lever is not set to P (PARK).

Secondary Controls

1) Ignition Switch and Engine Stop Switch



The ignition switch and engine stop switch are located on the bottom left of the dashboard.

WARNING

Do not leave the ignition key inserted when the operator is away. An unauthorized use of the vehicle by others may result in serious injury or death. Always remember to remove the ignition key when the vehicle is not in use.

Ignition switch has 3 positions. Use a key to control the ignition switch and then start the engine.

When the key is in the position of "OFF"; it can be removed from the ignition switch.

Ignition switch	OFF (1)	Engine is shut down. The electrical except winch motor's and DC outlet's is disabled.
	ON (2)	The electrical system of the vehicle is activated.
	START (3)	Turn ignition key to "  " to start the engine. Ignition key returns to "On " when released.
Engine stop switch		Engine doesn't work.
		Engine is ready for work.

Note:

Do not keep the ignition switch in "START " for more than 10 seconds.



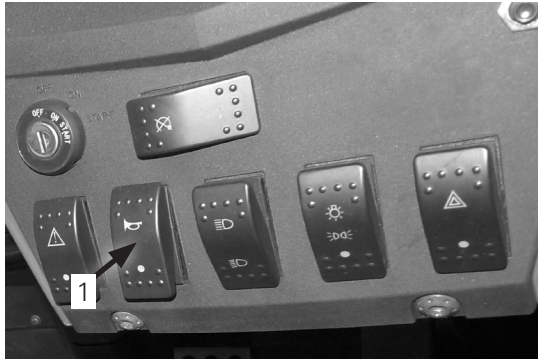

Switches on the dashboard Horn Switch







1. Horn switch

The horn can be activated by pushing the end of the multifunction lever toward the steering wheel.

High/ Low beam switch

 :	High beam is selected when light switch is in  position.
 :	Low beam is selected when light switch is in  position.

Light Switch

Light switch consists of: "", "", "", "" switch.

☀	Headlight, dashboard light, and position lights go on when light switch is in this position.
☀	Dashboard light, and position lights go on when light switch is in this position.
●	Headlight, dashboard light, and position lights go off when light switch is in this position.

NOTE

Ignition key must be turned to "ON " position before operating head lights.

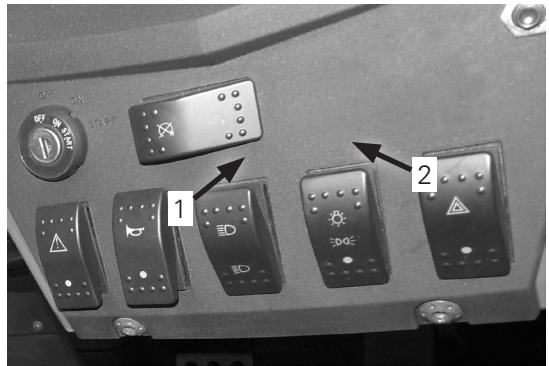

1. High /low beam indicator 2. Light switch

2WD/ 4WD Switch ②

This switch selects 2 Wheel Drive or 4 Wheel Drive mode when the vehicle is stopped and the engine is running.

When drivetrain is in 4WD, the indicator “” lights up in dashboard.

Ensure to push operation lever in position “a” prior to 2WD/4WD selection.

4WD/LOCK Switch ①

This switch selects 4 Wheel Drive or 4 Wheel Drive Lock mode when the vehicle is stopped and the engine is running.

4WD-lock indicator “” when 4WD/Lock switch is in “LOCK” position.

CAUTION
<p>The vehicle must be stopped to engage or disengage both 2WD/ 4WD and 4WD/ LOCK switch. Mechanical damage may occur if the switch is engaged or disengaged while driving.</p>

- When 4WD/LOCK is set to LOCK, the indicator blinks constantly until 4WD LOCK is engaged.
- When 4WD/LOCK indicator is flashing, left or right turn may ease the engagement.
- Engine RPM is limited in 4WD LOCK mode.
- Speed is limited under 35 km/h (22 mile/h) in 4WD LOCK mode. Depress override switch to override the restriction.

Override Switch



1. Override switch

The override switch main function is to bypass the engine speed limiter in 4WD LOCK operation by allowing maximum engine torque.

To disengage the override function, simply release the override switch.

When using the override function, the override indicator will light up to confirm that the function is activated.

Front Hood

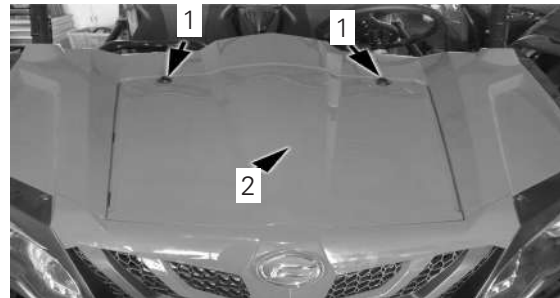

1. Release knob

2. Front hood

Front hood release lever is under the front grille. Push the release lever clockwise to open the front hood.

Winch switch

This vehicle comes with winch cable control and remote control which are located in the glove compartment.

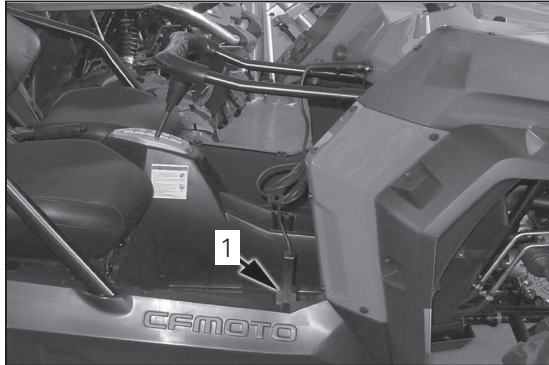

1. Cable control

Hazard Switch



1. Hazard switch

When using hazard switch function, front and rear turn signal lights will go on.

Besides, hazard switch indicator light in dashboard will light up.

12V DC Outlets



1. 12V DC outlet

This vehicle has 1 DC outlet.

Output voltage: 12 V

Maximum output current: 10 A

Clock Button

Clock button is located under instrument cluster.



1. SET button

2. Clock button

To reset the clock:

1. Press and release clock button once to advance the setting by one hour.
2. Press and hold clock button to set the minutes.

SET Button

Pressing the SET button will scroll through the functions of the secondary digital display, including engine RPM, Metric/Imperial units, trip, engine oil reminder setting, etc.

1. Metric/Imperial Units

To switch between metric and imperial units, press the "SET" button once in ODO mode.

2. Trip Meter Mode

To switch to trip meter mode, press and release "SET" button in ODO mode. To clear trip meter, press and hold "SET" button until the total changes to 0.

3. Tachometer Mode

To switch to tachometer mode, press "SET" button two times.

4. Odometer Mode

To toggle to ODO mode, press and release "SET" button two times in TRIP mode.

5. Oil Change Reminder Setting

To shut off oil change reminder function:

1. Turn off the ignition switch.
2. Press and hold both SET button and clock button.
3. Turn on the ignition switch.

Multifunction Meter

General Description

Coolant temperature gauge

When coolant temperature gauge is in green zone or at the "C" end, it indicates the coolant temperature is normal.

When coolant temperature gauge is in red zone or at the "H" end, it indicates the coolant temperature is excessively high. Engine should be stopped immediately in this case.

If the coolant temperature is frequently excessively high, ensure to check the coolant level or consult your dealer.

— **If the vehicle is overloaded, it may result in engine overheat when driving. Reduce the loads in this case.**

— **Ensure the coolant temperature is in white zone or at "C" end after restarting the engine. If coolant temperature in red zone or at "H" end, continual use of the vehicle.**

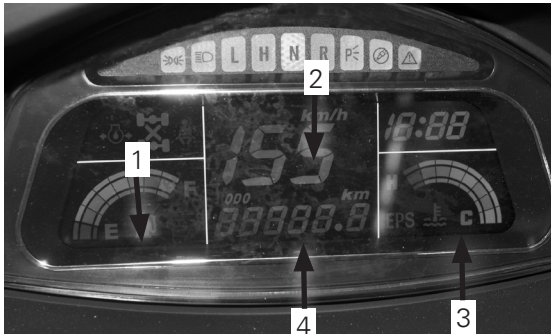

1. Fuel gauge
2. Speedometer
3. Coolant temperature gauge
4. Odometer

Fuel gauge

Indicates the fuel level in the fuel tank. "F" indicates there the fuel level is 26 L. When fuel gauge is in red zone, the residual fuel in the fuel tank is 3.5 L. Refuel in this case.

Speedometer

Indicates the speed of the vehicle. Press mode button to switch to MPH.

Odometer

Indicates the total milage the vehicle has traveled. Press mode button to toggle to TRIP meter, or tachometer, or imperial units mode.

4WD indicator

 : When 2WD/4WD switch is set to 4WD, this indicator will be on.

 : When 4WD/LOCK switch is set to LOCK, this indicator will be on.

Due to the synchronizer setting in the front differential, 4WD indicator may light up after the vehicle is moving.

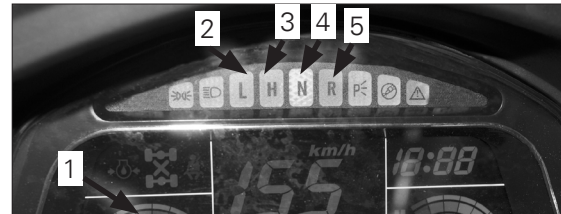

- | | |
|----------------------|----------------------|
| 1. 4WD indicator | 3. H range indicator |
| 2. L range indicator | 4. N indicator |
| | 5. R indicator |

L range indicator

This indicator lights up when gearbox is in L range.

H range indicator

This indicator lights up when gearbox is in L range.

N indicator

This indicator lights up when gearbox is in neutral.

R indicator

This indicator lights up when gearbox is in reverse.

Position light indicator 1

This indicator lights up when position lights are on.

Hi beam indicator 2

This indicator lights up when high beam is selected.

P indicator 3

This indicator lights up when parking is engaged.

MIL 4

MIL will blink if fuel system has some troubles or some history error codes are not erased.

Override indicator 5

This indicator lights up when override switch is depressed.

Clock 6

Indicates the time.

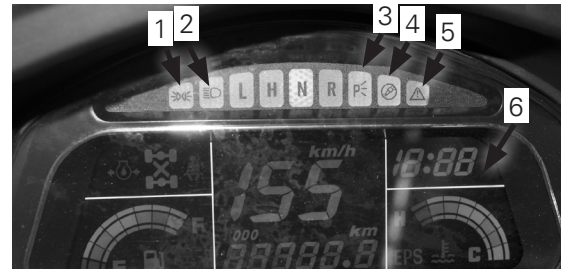

Oil pressure warning indicator

If this indicator lights up when engine revs over 1000 rpm, it indicates engine oil is not enough or oil pressure is too low. Add oil if oil level is under the lower limit. If oil pressure warning indicator is still on when oil level is correct, it indicates oil pressure sensor or instrument cluster or lubrication system has troubles. Please call your dealer in this case.

Seat belt indicator

This indicator lights up when seat belt is not fastened during driving.

Oil change reminder

This indicator initially lights up to remind operator of oil change at 750 km. It secondly lights up to remind operator of oil change at 3000 km. Then, it goes on every 3000 km.

NOTE
If indicator light goes on or speedometer does not work, please have your dealer check the circuit of speed sensor.

Equipment

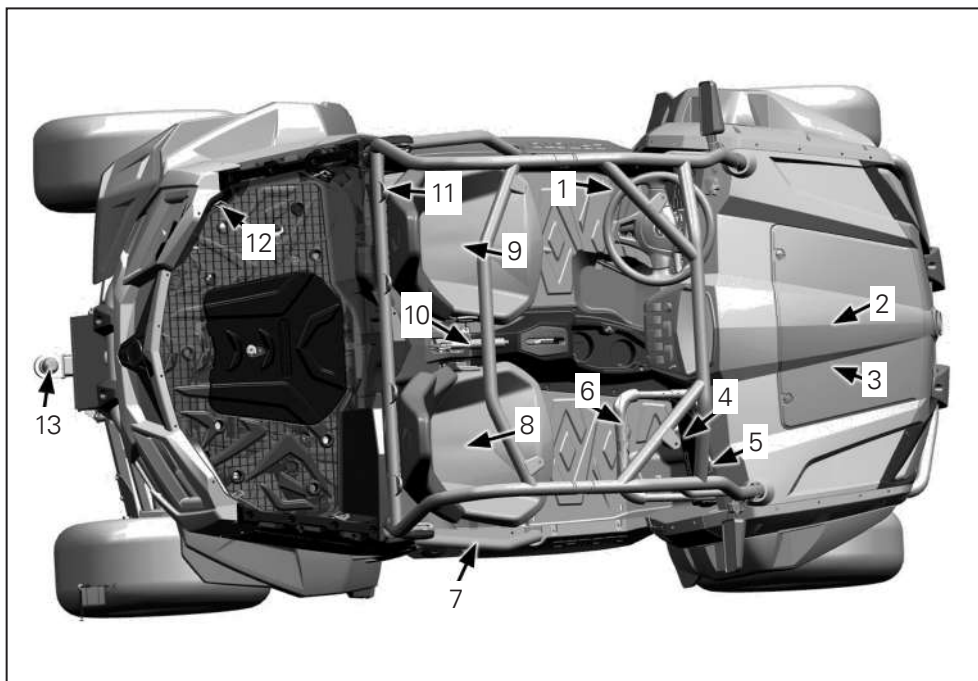



1) Footrests

The vehicle is equipped with driver and passenger footrests to allow firmly planting feet on vehicle floor, which helps to maintain proper body position while riding.

The footrests help minimize the risk of leg or foot injury.

Always wear appropriate footwear.

2) Glove Box

Maximum: 4.8 kg

3) Tool Kit

A tool kit with basic tools is provided. It is located in the glove box.

4) Glove Compartment

The vehicle is equipped with a closed glove compartment made to carry light objects. The capacity is 5 kg.

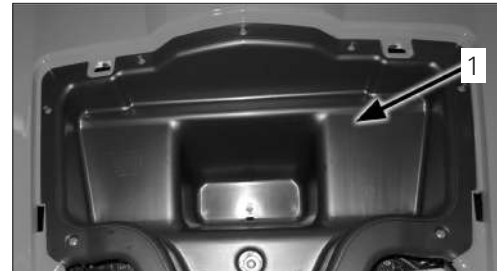

1. Glove box

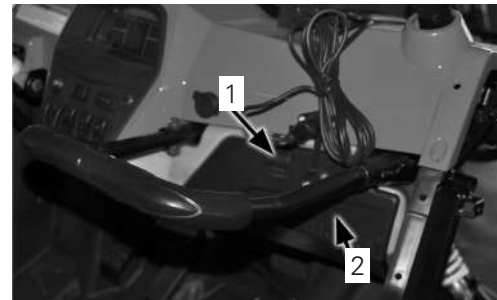

1. Stap 2. Glove compartment

5) Winch Cable Control Connector

This vehicle comes with a winch cable control, which is designated to use when the winch remote control is defective.

6) Passenger Handholds

The passenger must hold both handholds securely during driving. Any part of the body should not be outside of the cab to prevent possible injury.

⚠ WARNING

Never use any part of vehicle cage as handholds. Hands can be struck by objects outside the cockpit or crushed in a rollover.

7) Shoulder Guards

The vehicle is equipped with shoulder guards to help restrain the entire body of driver and passenger inside vehicle.

8) Driver Seat

The driver's seat offers fore and aft adjustments.

To adjust seat, move the seat lever to unlock the seat. Release the lever to lock the seat into desired position.

9) Passenger Seat

The passenger seat is not adjustable.

10) Hand Brake

To park the vehicle, shift to the "P" position. Press the release button to pull up the hand brake lever. Press the release button to disengage the hand brake before driving.

11) Seat Belts

This vehicle is equipped with 3 points seat belts to help protect driver and passenger in the event of collisions, rollovers or tipovers to help keep passengers in the cab.

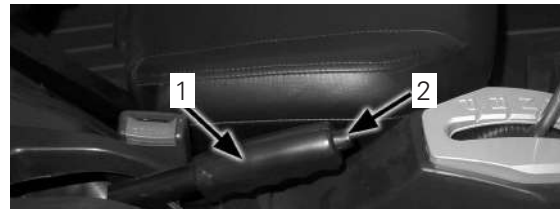

1. Hand brake

2. Button

Seat belt indicator light will flash if seat belt is not fastened during driving.

12) Anchoring Hooks

To provide anchoring point in order to secure cargo inside the cargo box, 4 anchoring hooks are located inside the cargo area.

13) Hitch Support

The vehicle comes equipped with a 51 mm x 51 mm (2 in x 2 in) box size standard hitch support.

14) Winch

The winch can be actuated inside the vehicle using the winch cable control and the remote control.

Refer to your winch manual for further information.

15) Fuel Cap

The fuel cap is located on the right hand side

of the vehicle behind the passenger seat.

Capacity: 27L

16) Cargo Box

Refer to the safety decals on cargo box for loads information.

Suspension

Suspension Adjustment Guideline

The suspension can be adjusted by the loading, which is also influenced by recovery damping, spring preload and compression damping.

The suspension system had been set before exported. The setting apply to the regular driving condition only.

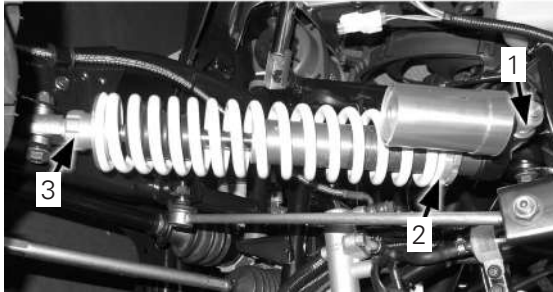

1. *Recovery damping adjuster*
2. *Spring preload adjuster*
3. *Compression damping adjuster*

Since this vehicle comes equipped with rear sway bar, basically it's not necessary to reset suspension.

Only have professionals reset suspension if the vehicle is fully loaded and return to initial setting when loads are released.

When the vehicle is prepared to pull loads, please contact your dealer to adjust the suspension, using special tool.

To adjust suspension, observe the following rules:

- Return to factory setting after loads are released.
- Ensure to adjust each shock spring on the same cam position.

If the vehicle carrying loads are low, do not adjust suspension to the highest position or the second highest position.

Carrying loads include driver, passenger, allowed accessories, trailer tongue weight and cargo.

Do not exceed the load limits of the vehicle.

Fuel

Recommended Fuel

The recommended fuel for this vehicle is #93 unleaded gasoline.

 WARNING

Fuel is flammable and explosive under certain conditions. Be careful whenever using gasoline:

- Always stop engine prior to refueling. Ensure to refuel outdoors or in well ventilated areas.
- Never fill the gasoline container in the vehicle cargo box or on-the vehicle - an electrical static discharge may ignite the fuel.
- Never smoke or allow flame or spark in gas station or fuel storage.
- Never top up the fuel tank before placing the vehicle in a warm area. As temperature increases, fuel expands and may overflow.
- If fuel spills on you, wash with soap and water and change your clothes.
- Never run the engine in enclosed or poorly ventilated areas for a prolonged period. Engine exhaust is poisonous and if deadly levels collect, you can quickly lose consciousness or even die.

Vehicle Fueling Procedure

1. Stop the engine.
2. Have the driver and passenger get off the vehicle.
3. Unscrew slowly the fuel tank cap counterclockwise to remove it.
4. Insert the spout into the filler neck.
5. Pour fuel slowly so that air can escape from the tank and prevent fuel flow back. Be careful not to spill fuel.
6. Stop filling when the fuel reaches the bottom of filler neck. Do not overfill.
7. Fully tighten fuel tank cap clockwise.

Break-In Period

Operation During Break-In

A break-in period of 20 operating hours or 750 km is required for this vehicle.

CAUTION:

During the break-in period:

- Do not carry or pull loads in initial 20 hours or 750 km.
- Avoid full throttle. Full throttle in break-in period may result in engine parts damage or a shorter engine service life.
- Avoid pressing throttle pedal more than 1/2 of the stroke in the initial 10 hours of the break-in period.
- Avoid pressing throttle pedal more than 3/4 of the stroke in the 10-20 hours of the break in period.
- The use of non recommended engine oil can result in serious engine damage. The recommended engine oil is SAE15W-40/SG.

Preparations before driving:

- Refuel if necessary.
- Place the vehicle on a level ground. Check the engine oil level. Add oil if necessary. Ensure to keep engine oil level is between upper and lower limits.
- Drive slowly at the beginning. Choose open areas to familiarize yourself with the controls and operation of vehicle.
- Vary throttle and do not run the engine at sustained throttle position.
- Periodically check coolant level, controls, along with the items outlined in periodic maintenance chart.
- Ensure to carry light loads.
- Ensure to change oil and oil filter after break in period.

Pre-Ride Inspection

WARNING

Fuel is flammable and explosive under certain conditions.

PRE-RIDE INSPECTION		
ITEMS	INSPECTION TO PERFORM	REMARKS
Brake system/brake pedal	Check the operation.	
Brake fluid	Check the fluid level.	
Front suspension	Check the operation. Lubricate if necessary.	
Rear suspension	Check the operation. Lubricate if necessary.	
Steering	Check if steering operates freely.	
Tires	Check tire pressure and condition.	
Wheel/fasteners	Check wheels and wheel nuts for damage.	
Nuts, bolts and other fasteners on the frame	Check for fastness.	
Fuel and engine oil	Check the level.	
Coolant level	Check the level.	
Coolant hose	Check for leaks.	
Throttle	Check if throttle pedal operates freely.	
Gear shift	Check the operation.	

Indicators/switches	Check the operation.	
Air filter element	Inspect and clean.	
Air filter moisture catch tube	Clean the liquids or sediment if visible.	
Headlights	Check the operation.	
Brake/tail light	Check the operation.	
Riding gear	Wear helmet, gloves and protective clothes.	

Basic Procedures

Starting the Engine

WARNING

Engine exhaust contains carbon monoxide, a deadly gas, which can make you lose consciousness or even die. Never run the engine in enclosed areas.

WARNING

Do not drive the vehicle immediately after the engine is started in winter. Warm up prior to ride. Otherwise, it could result in engine damage.

Cold starting:

1. Press down the brake pedal.
2. Turn the ignition switch to “⌚”.
3. Shift transmission to Neutral.

NOTE

- When transmission is in Neutral, if the Neutral indicator light in dashboard is off, have your dealer inspect the wiring or adjust the gear shift linkage.
- The engine can be started in any gear when brake pedal is pressed down. Anyway, it's recommended to start the engine in Neutral or Park.

4. Ensure throttle pedal is released.
5. Turn the ignition switch to “⌚” to start the engine.

CAUTION

- If engine does not start after a few seconds, do not keep the ignition switch in “⌚” more than 10 seconds.
- If the battery is discharged, remove and charge the battery.

6. Before you go, warm up the engine until it idles smoothly.

CAUTION

Refer to the information in Break-In period when starting the engine for the first time.

Shifting the Transmission

Apply brakes and select the desired shift lever position.

Release brakes

CAUTION

When changing gearbox position, always completely stop the vehicle and apply the brakes prior to moving the shift lever. Damage to the transmission may occur.

Stopping the Engine and Parking the Vehicle

⚠ WARNING

Avoid parking on steep slope as the vehicle may roll away.

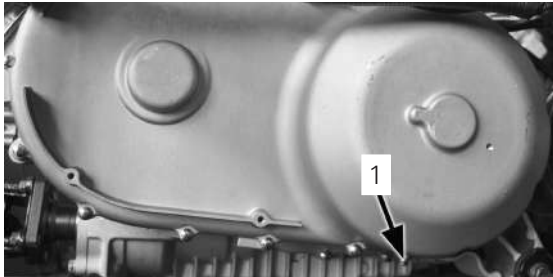

1. Drain bolt

⚠ WARNING

Always put the vehicle in PARK when stopped or parked to prevent rolling.

Special Procedures

Cleaning the CVT Inlet

If water or dirt is present in the CVT inlet, remove and clean it.

What to do if Water collects in CVT

If water collects in CVT, remove the drain bolt to drain the water.

CAUTION

Have your dealer check this vehicle after you drain the water, as the residual water could damage other engine components.

What to do if Vehicle is Submerged

If the vehicle become immersed, it will be necessary to have it transported to your dealer as soon as possible.

CAUTION

Never start the engine as immersion of the vehicle can cause serious damage to the engine if the correct restart procedure is not followed.

Transporting the Vehicle

CAUTION

Do not transport the vehicle with it erected. If your vehicle needs to be transported, proceed as follows:

1. Stop the engine. Remove the ignition key.
2. Shift to Neutral. Block the front and rear wheels.
3. Ensure that both the front and rear wheels are firmly fastened.
4. Ensure that fuel cap, oil dipstick and seats are installed properly.

Maintenance Schedule

Maintenance is very important for keeping your vehicle in safe operating condition.

Always follow the inspection and maintenance procedures and schedules described in the Owner's Manual.

Inspect, clean, lubricate, adjust and replace some components when necessary. Always use genuine spare parts.

CAUTION

Periodic maintenance and adjustment is very important. Have a qualified dealer perform this service if you are not familiar with maintenance and adjustment procedures.

The maintenance intervals outlined in below chart is based on average driving conditions. The assumed average speed is 30 km/h. Service more often when the vehicle is subject to severe use.

Severe Use Definition

- Frequent immersion in mud, water or sand
- Racing or race-style high RPM use
- Prolonged low speed, heavy load operation
- Extended idle
- Frequent short trip in wold weather

Pay special attention to the oil level. A rise in oil level during cold weather can indicate contaminants collect in the crankcase. Change oil immediately if the oil level begins to rise. Monitor the oil level, and if it continues to rise, discontinue use and determine the cause or see your dealer.

Lubrication Recommendations

Check and lubricate all components at the intervals outlined in the Periodic Maintenance Chart, or more often under severe use, such as wet or dusty conditions.

Items not listed in the chart should be lubricated at the general lubrication intervals.

Lubrication Chart

ITEM	LUBE	METHOD
Engine oil	SAE15W - 40/SG	Add to proper level on dipstick.
Brake fluid	DOT3 or DOT4	Maintain level between upper and lower limits.
Front differential oil	SAE80W90GL-4	
Rear gearcase oil	SAE80W90GL-4	
Tie rod ends, pivots, fittings	Grease	

Maintenance Procedures

Air Filter

NOTE
The air filter comes installed with a moisture catch tube. If dust or liquids collect in this tube, clean out this tube, air filter element and air filter housing. If a large amount of water is present in the air filter, have your dealer check for water entering crankcase.

Cleaning the air filter

To clean the air filter element, proceed as follows:

1. Remove the air filter cover.
2. Disengage the clamps 1 to remove the air filter housing cover.
3. Remove the clamp bolt 4.
4. Remove the air filter #5.
5. Clean the air filter foam element, using a high flash point cleaner. Dry out the foam element and reinstall it.

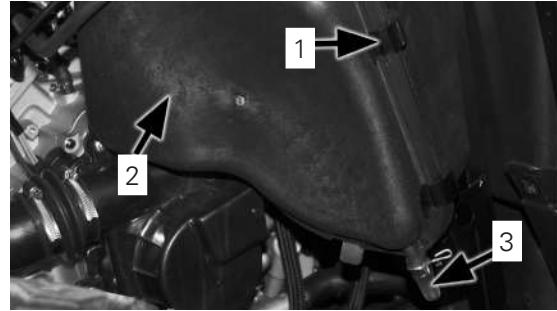

1. Clamp 2. Air filter cover 3. Moisture catch tube

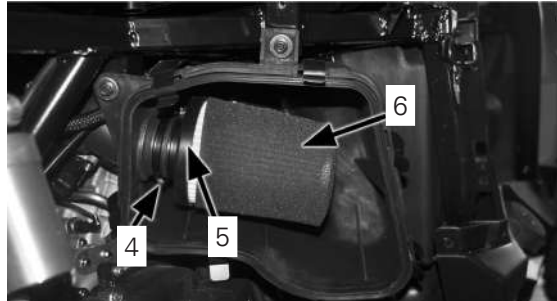

4. Bolt 5. Air filter #5 6. Foam element

6. Lightly clean out the dust collects on the paper element.
7. Replace the air filter as needed.

CAUTION

Do not use liquid cleaner to clean the paper element.

8. Install the air filter. Ensure that the filter is properly seated on the intake duct.
9. Install the air filter housing cover. Ensure to securely latch it.

NOTE

Air filter element should be replaced every 50h or 1500 km. Air filter replacement frequency must be increased if the vehicle is often operated in dusty areas. Ensure to check if the air filter intake is clogged. Check if the air filter, throttle body and intake duct are securely connected. Fasten all the connections to prevent unfiltered air entering the engine.

CAUTION

Do not start the engine without air filter. Otherwise unfiltered air will enter the engine and engine premature wear or even damage may occur. Moreover, driving without air filter could result in engine performance degradation and overheat.
--

Spark Arrestor

Cleaning the spark arrestor

 WARNING
--

Ensure that the exhaust pipe and muffler are fully cooled down while servicing the spark arrestor.
--

To clean the spark arrestor, proceed as follows:

1. Remove the retaining screws #1.
2. Remove the spark arrestor #2 from the end of the muffler.
3. Lightly tap the spark plug. Use a metal brush to clean out the carbon deposits on

the arrestor screen.

4. Insert the spark arrestor into the muffler and align the screw holes.

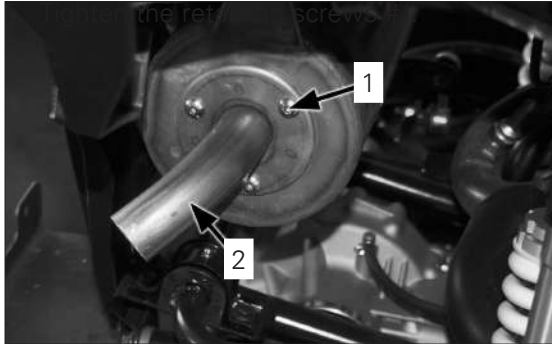

1. Bolt 2. Spark arrestor

Engine oil

Inspect and replace the engine oil as per the maintenance intervals outlined in periodic maintenance chart.

To Check the Engine Oil Level

With vehicle on a level surface, check the oil level as follows:

1. Remove the passenger seat.
2. Place the vehicle on the plain ground.
3. Start the engine and allow it to idle for 20 ~30 seconds. Stop the engine.
4. Wait for a few minutes to allow the engine oil to settle down in crankcase.
5. Unscrew the oil dipstick and then wipe it off with a clean rag.
6. Insert the dipstick completely into the oil filler hole, and then remove it again to check the oil level.

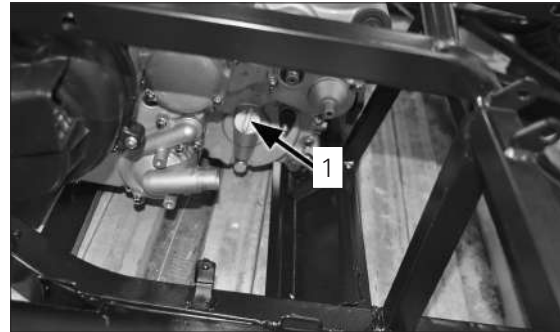

1. Oil dipstick

NOTE

Engine oil level should be between the upper and lower marks.

7. If the engine level is below the lower mark, add oil to proper level.
8. Insert the oil dipstick and fully tighten it.
9. Reinstall the removed passenger seat.

To Change the Engine Oil

1. Start the engine and allow it to warm up for 2 ~ 3 minutes, then stop the engine.
2. Place an oil pan under the engine to collect the used oil, and then remove the dipstick.
3. Remove the engine oil drain bolt to drain the oil from the crankcase.

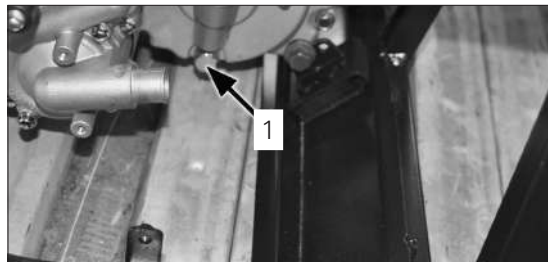

1. Drain bolt

To Change the Oil Filter

1. Remove 3 engine oil bolts no.1, open the filter cover no. 2 to take out the filter.
2. Replace with the new oil filter.

NOTE

Make sure the O-ring no. 4 is well and installed in the box.
--

3. Install the new oil filter no. 3 and fix the 3 bolts in the oil filter cover no. 2. Tighten it to specified torque.

NOTE

Bolt no. 1 tightening torque: 10 N·m

4. Use a new drain bolt washer and tighten it to specified torque.

NOTE

Drain bolt washer tightening torque: 30 N·m

5. Add recommended oil to specified level and then screw in the oil dipstick.

NOTE

- Oil capacity at the first replacement: 3.0 L
- Oil capacity without oil filter replacement: 2.8 L
- Oil capacity with oil filter replacement: 2.9 L
- Oil radiator: add 0.5 L after first start
- Oil radiator: add 0.45 L after service

6. Start the engine and allow it to warm up for a few minutes. Check for oil leakage when the engine is warm. Stop the engine immediately if oil leaks are present.
7. Stop the engine and check the engine level. Revise if necessary.

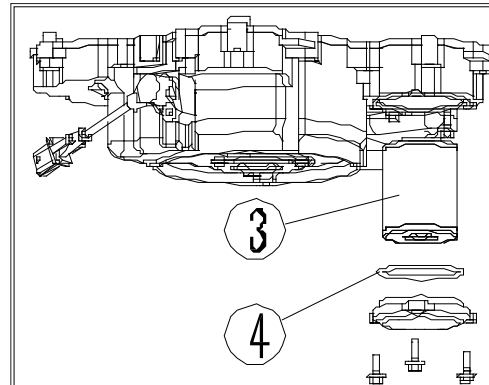
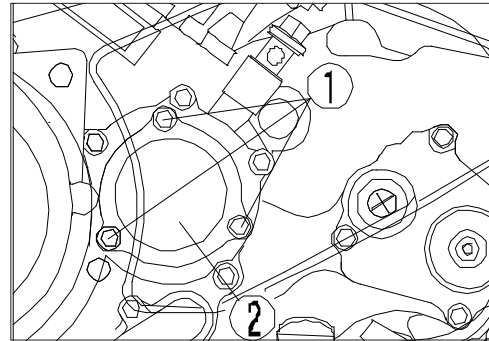

Rear Gearcase Oil

Check the rear gearcase for oil leaks prior to each use. If oil leakage is present, have your dealer determine the cause.

To Change the Rear Gearcase Oil

1. Place the vehicle on a level surface and remove the fill plug #1.
2. Place an oil pan under the engine to collect the used oil.
3. Remove the drain plug #2 and allow the oil to drain completely.
4. Install the drain plug and torque it to specification.

NOTE

Drain plug tightening torque: 25 N·m

5. Add the recommended oil to proper level.

NOTE

Oil capacity(at periodic maintenance): 0.25 L
Oil capacity(preliminary): 0.30 L

6. Reinstall the fill plug and torque to specification.

7. Check for oil leaks. If oil leakage is present, troubleshoot the failure.

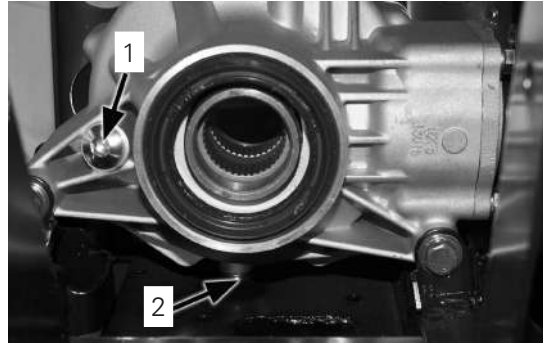

1. Fill plug 2. Drain plug

NOTE

Fill plug tightening torque: 25 N·m

CAUTION

Make sure that no foreign material enters the rear final drive.

Front Differential Oil

To Check the Front Differential Oil

1. Place the vehicle on a level surface.
2. Remove the fill plug #2 and check the oil level. Maintain the oil level even with the bottom thread of the fill plug hole.
3. Reinstall the fill plug and torque it to specification.

NOTE
Fill plug tightening torque: 25 N·m

To Change the Front Differential Oil

1. Place the vehicle on a level surface.
2. Place an oil pan under the front differential to collect the used oil.
3. Remove the fill plug and drain plug. Allow the oil to drain completely.
4. Reinstall the fill plug #2 and torque it to specification.

NOTE
Drain plug tightening torque: 25 N·m

5. Add recommended oil to proper level.

NOTE
* Oil capacity at periodic maintenance: 0.28L * Oil capacity in total: 0.33L

6. Install the fill plug #2 and torque to specification.
7. Check for oil leaks. If oil leakage is present, troubleshoot the problem.

CAUTION
No foreign material enters the rear final drive.

Cooling System

To Check the Coolant Level

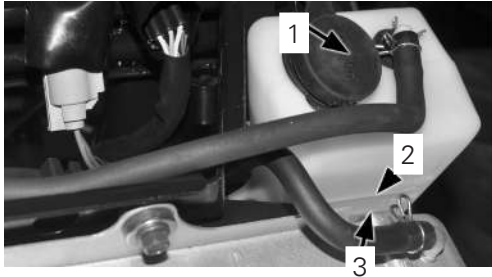

1. *Coolant reservoir cap*
2. *“Upper” mark*
3. *“Lower” mark*

1. Place the vehicle on a level surface.
2. Check the coolant level in the coolant reservoir, as the coolant level in the coolant reservoir varies with the engine temperature changes.

NOTE

Engine coolant level should be between the upper and lower marks.

3. If the coolant level in the coolant reservoir is below the lower mark, open the coolant reservoir cap and add coolant to the upper mark. Reinstall the coolant reservoir cap and other removed parts.

NOTE

Coolant reservoir capacity at the lower mark: 0.23 L.

CAUTION

Tap water or sea water is harmful for the engine, which can only be alternated as coolant in special conditions temporarily.

CAUTION

If tap water or distilled water is alternated as coolant temporarily, have your dealer replace with specific coolant and inspect the cooling system performance.

To Change the Coolant

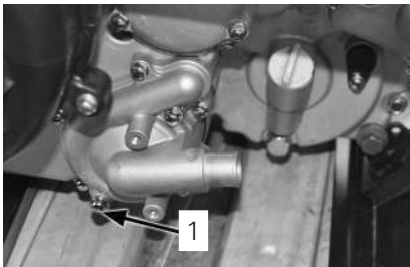

1. Coolant drain bolt

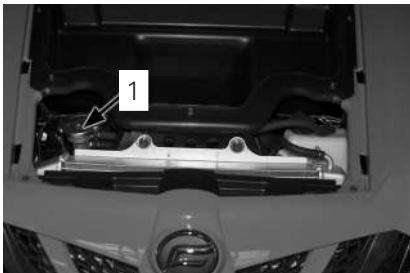

1. Radiator cap

With vehicle on a level surface and engine cold, proceed as follows:

1. Place an container under the engine to collect the used oil.
2. Remove the coolant drain plug #1.
3. Remove the radiator pressure cap, along with the coolant reservoir cap.

⚠ WARNING

In order to avoid potential burns, do not remove the pressure cap or loosen the coolant drain plug if the engine is hot.

4. Drain the coolant in coolant reservoir.
5. If the drain plug washer is worn out, replace it with a new one.
6. Torque the drain plug to specification.

NOTE

Coolant drain plug tightening torque: 10 N·m

7. Install the coolant reservoir hose.
8. Add recommended coolant to proper level.

NOTE

Remove the thermostat cover screw before filling the coolant. This would help to bleed the air trapped in cooling system. Install the thermostat screw when coolant spills.

NOTE

Always use ethylene-glycol antifreeze containing corrosion inhibitors specifically for internal combustion aluminum engines.
We recommend the use of a 50/50 mixture of anti-freeze and distilled water.
Always use CFMOTO premixed coolant.
Coolant capacity in total: 2.9 L
Coolant capacity at replacement: 2.8 L

CAUTION

Tap water or sea water is harmful for the engine. Always use recommended coolant.

9. Install the radiator pressure cap.
10. Start the engine and allow it to idle for a few minutes, and then stop the engine. Check the coolant level in radiator after the cooling system is fully cooled down. If coolant level is below the lower mark, add recommended coolant to radiator filler neck.
11. Add coolant in reservoir to the upper mark.
12. Install the coolant reservoir cap and check for coolant leaks.
13. Install the removable hood.

To change the coolant in reservoir

Coolant reservoir capacity: 0.3 L

Spark Plugs

Access to Spark Plugs

1. Tilt the rear cargo box to access to spark plug of the first cylinder.
2. Remove air filter housing cover to access to spark plug of the second cylinder.

Spark Plug Removal

1. Unplug spark plug cable.
2. Remove spark plug, using a special wrench.

NOTE
Spark plug removal procedure is the same for both cylinders.

3. Using compressed air, clean spark plug and cylinder head.

Spark Plug Inspection

The spark plug is an important engine component and is easy to inspect. The condition of the spark plug can indicate the condition of the engine.

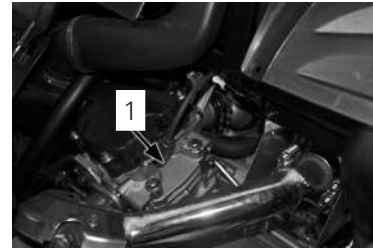

1. Spark plug cap, front cylinder

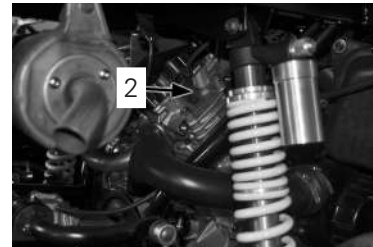

2. Spark plug cap, rear cylinder

The ideal color of the porcelain insulator around the center electrode is a medium-to-light tan for a vehicle that is being ridden normally.

You should periodically remove and inspect the spark plug because heat and deposits will cause the spark plug to slowly break down and erode. If electrode erosion becomes excessive, or if carbon and other deposits are excessive, you should replace the spark plug with the specified plug.

NOTE
Specified spark plug: DCPR8E (NGK)

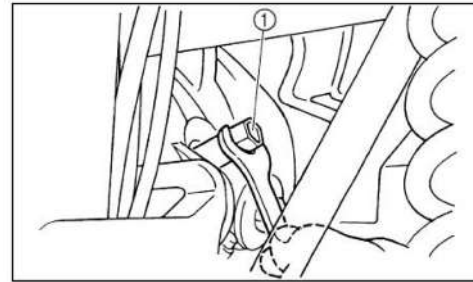

1. Spark plug removal tool

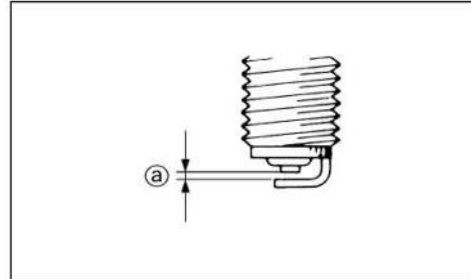

a. Spark plug gap

Spark Plug Installation

1. Measure the spark plug gap with a feeler gauge and, if necessary, adjust the gap to specification.

NOTE
Spark plug gap: 0.8 ~ 0.9 mm

2. Clean the surface of the spark plug gasket and its mating surface, and then wipe off any grime .
3. Install the spark plug and tighten it to the specified torque.

NOTE
Spark plug tightening torque: 20 N·m If a torque wrench is not available when you are installing the spark plug, a good estimate of the correct torque is one-quarter to one-half turn past finger tight.

4. Install the spark plug cable.
5. Install other removed parts.

Battery

The battery is located under the front hood. It is a maintenance-free type battery, there is no need to add water to adjust electrolyte level. If the battery is discharged, consult your dealer.

Battery capacity: 12 V 30 Ah

CAUTION
Do not try to remove the sealing caps of the battery cells. You may damage the battery.

 WARNING
Avoid battery contact with skin, eyes, or clothing. Shield eyes when working near batteries. Keep out of reach of children.

In case of accidental contact with battery electrolyte:

EXTERNAL: Flush with water.

INTERNAL: Drink large quantities of water or

milk. Follow with milk of magnesia, beaten egg, or vegetable oil. Seek prompt medical attention.

EYES: Flush with water for 15 minutes and get prompt medical attention.

⚠ WARNING

Batteries may produce explosive gases. Ventilate when charging or using in a closed space. Keep batteries away from sparks, flames, cigarettes, or other sources of ignition.

Battery Maintenance

1. If the vehicle will not be used for more than one month, remove the battery and then place it in a cool, dry place. If the battery will be stored for more than two months, fully charge it if necessary.

CAUTION

To charge this battery, a specified battery charger is required. Using a conventional battery charger will damage the battery.

2. Ensure to the cables are properly routed when installing the battery.

Fuses

Fuse replacement

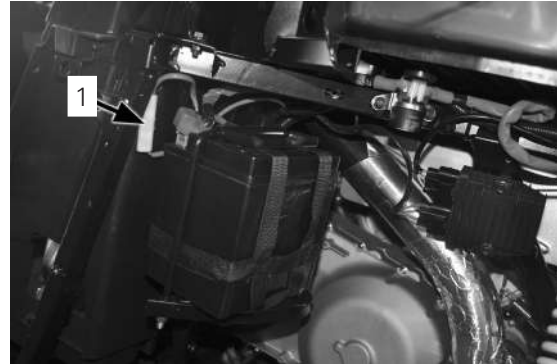

1. Main fuse

1. The main fuse is located beside the battery. The fuse box is located in front of the steering column. The main fuse is installed on starter relay.
2. If a fuse is blown, turn off the ignition

switch. Install the specified fuse and turn on the ignition switch. If the fuse is blown again, consult your dealer.

CAUTION
Always use a fuse of the specified amperage. Never use any material in place of the proper fuse. Using an improper fuse can cause damage to the electrical system and may lead to a fire.

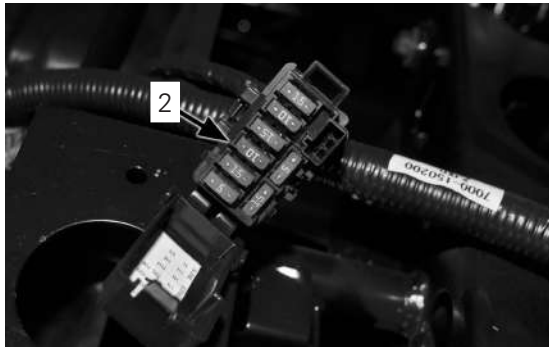

2. Fuse box

Ref	FUSE	RATING
F1	Main fuse	25A
F2	Fuel pump/EFI/ignition power supply/auxiliary starter relay	15A
F3	Turn signal/position light/dashboard/ horn/diff. gear motor relay	10A
F4	DC outlet/MP3/navigator	15A
F5	ECU power supply	5A
F6	Fan motor	15A
F7	Headlight	10A

CAUTION
To prevent accidental short-circuiting, turn off the main switch when checking or replacing a fuse.

Lights

Always check light operation prior to each use.

Replacing a headlight bulb

If a headlight bulb burns out, replace it as follows

1. Remove the back cover of the headlight by turning it counter-clockwise.
2. Disengage the headlight bulb clamp.
3. Remove the headlight bulb.

WARNING

Wait for the headlight bulb to cool before touching or removing it. Always wear gloves to perform the bulb replacement.

4. Insert a new headlight bulb and engage the bulb clamp.
5. Reinstall the headlight back cover.

Headlight beam adjustment

CAUTION

It is advisable to have your dealer make this adjustment.

To adjust high beam, turn the screw #1.

To adjust low beam, turn the screw #2.

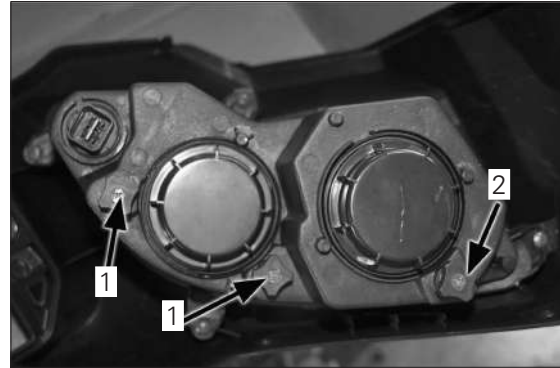

1. Hi beam adjustment screw

2. Lo beam adjustment screw

Tail/brake light/turn signal light bulb replacement

Brake/tail lights, rear turn signal lights and front position lights are LED type. Have your dealer replace the entire light if a bulb is damaged.

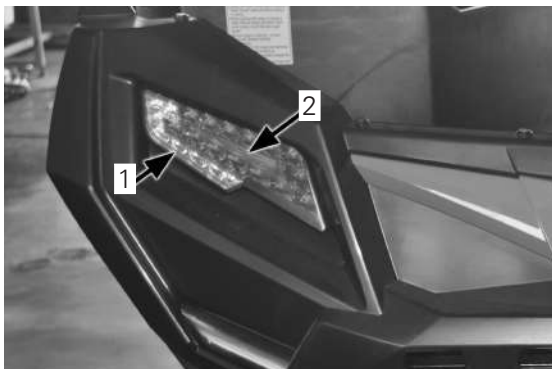

1. Brake/tail light
2. Rear left turn light

Drive Shaft Boots

Drive Shaft Boot Inspection

Check drive shaft boots for cracks, tears, leaking grease, etc.
Repair or replace damaged parts as necessary.

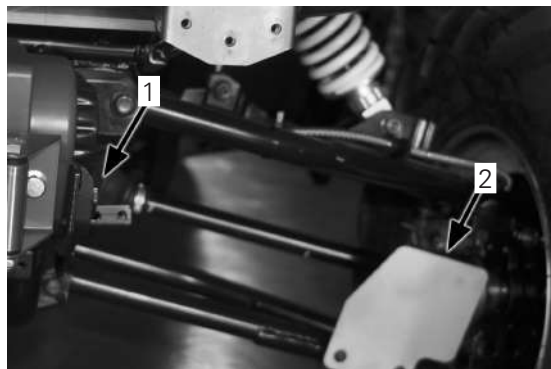

1. Inner CV joint
2. Outer CV joint

Wheel Bearing

Wheel Bearing Inspection

Lift the vehicle and support it securely.
Push and pull the wheels from the upper edge to feel the play.
See your dealer if there is any play.

Wheels and Tires

Wheel Removal

1. Place the vehicle on a level surface.
2. Elevate the vehicle and place a suitable stand under the frame.
3. Remove the wheel nuts #1.
4. Remove the wheel.

Wheel Installation

Install the wheel and wheel nuts.

NOTE
Torque the wheel nuts to specification.

NOTE
Wheel nut tightening torque: 55 N·m front, 55 N·m rear.

Suspension

Front and Rear Suspension Lubrication

Periodically clean and lubricate the grease fittings.

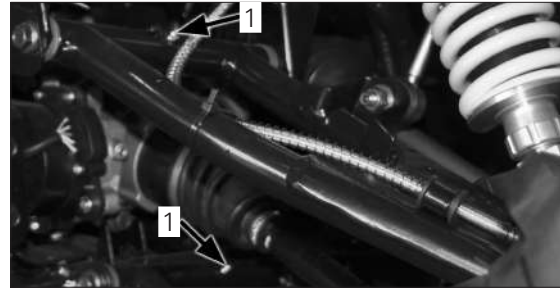

1. Grease fittings

Brakes

Replacement of brake components requires professional knowledge. Brake service should be performed by your dealer.

Checking the front and rear brake pads If the brake pad lining is worn to 1.5 mm, have your dealer replace the brake pads.

Checking the brake fluid level

Before riding, check that the brake fluid is above the minimum level mark. Replenish the brake fluid if necessary. Observe these precautions:

1. Place the vehicle on a level surface when checking the brake fluid level through the fluid level check window.
2. Insufficient brake fluid may allow air to enter the brake system, reducing braking performance.
3. Use only the specified brake fluid; otherwise, the rubber seals may deteriorate, causing leakage.

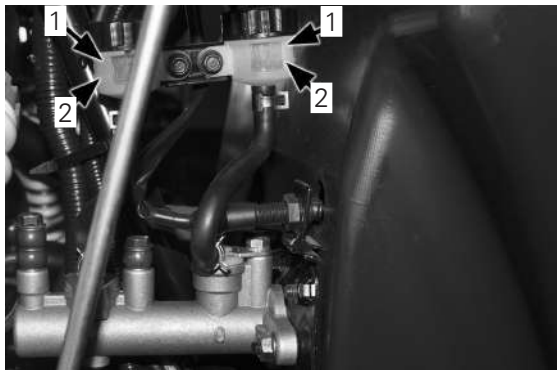

1. Maximum level mark
2. Minimum level mark

NOTE

Recommended brake fluid: DOT3 or DOT4

1. Refill with the same type of brake fluid. Adding a brake fluid other than the specified brake fluid may result in a harmful chemical reaction.
2. Be careful that water does not enter the brake fluid reservoir when refilling. Water will significantly lower the boiling point of the fluid and may result in vapor lock.
3. Brake fluid may damage painted surfaces or plastic parts. Always clean up spilled fluid immediately.
4. As the brake pads wear, it is normal for the brake fluid level to gradually go down. A low brake fluid level may indicate worn brake pads and/or brake system leakage; therefore, be sure to check the brake pads for wear and the brake system for leakage. If the brake fluid level goes down suddenly, have your dealer check the cause before further riding.

Throttle Body

Throttle body is an important engine component, which, requires professional adjustment. Have your dealer perform the adjustment as they have professional knowledge and experience.

CAUTION
Throttle body is set after many tests. If the setting is disturbed by anyone without enough professional knowledge and experience, it may result in engine performance degradation or other damages. Throttle body limit screw is precisely calibrated and can not be reset again.

Check the idle speed for stability. If the idle speed is unstable, ask your dealer for help.

Idle Speed

The idle speed is controlled by EFI system and it does not require any adjustment. Improper adjustment of idle speed may affect the engine performance. If the idle speed is abnormal, consult your dealer.

NOTE
Idle speed: 1, 300r/min \pm 100r/min

Valve Clearance Adjustment

The correct valve clearance changes with use, resulting in improper fuel/air supply or engine noise.

To prevent this, the valve clearance must be adjusted regularly. This adjustment however, should be performed by your dealer.

Record your vehicle identification number(VIN) and engine identification number(EIN) in the spaces provided.

Remove the spare key and store it in a safe place. You can only use your existing key to duplicate a new one. Therefore, if the 2 keys are lost, the complete lock kit has to be replaced.

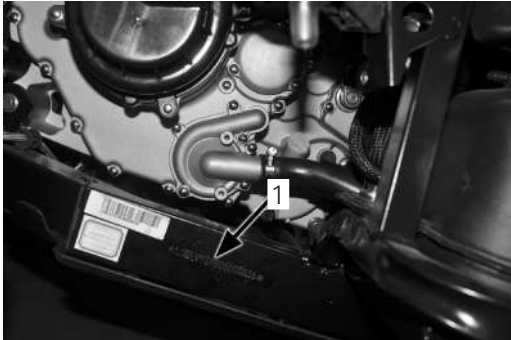

1. VIN

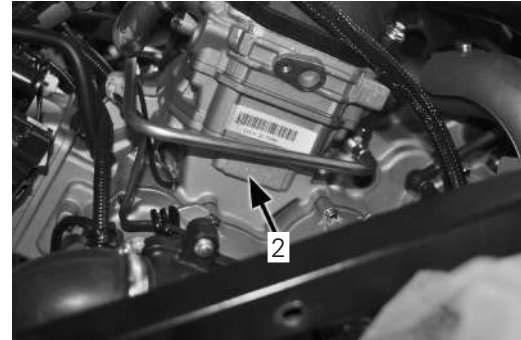

2. EIN

1. Engine identification number: _____
2. Vehicle identification number: _____

ITEM	SPECIFICATION
Length	2870 mm
Width	1510 mm
Height	1830 mm
Wheelbase	2040 mm
Min. ground clearance	310 mm
Min. turning radius	9500 mm
Curb weight: with fuel and oil	552±15 kg
Engine model	2V91W
Type	V-twin, 4-stroke, liquid-cooled, 8 valves, SOHC
Bore × stroke	91 mm × 61.5 mm
Displacement	800 cc
Compression ratio	10.3 : 1
Starting	Electric
Lubrication	Pressure & spray

Engine oil: Grade Oil change: Oil change with oil filter replacement Overhaul Oil radiator: Oil replenishment after first start Oil replenishment after service	SAE15W-40/SG 2.9 L 3.0 L 0.5 0.45
Rear gearcase oil: Grade Capacity: Periodic change Preliminary	SAE80W90 GL-4 0.25 L 0.30 L
Front differential oil: Grade Capacity: Periodic change Preliminary	SAE80W90 GL-4 0.30 L 0.33 L
Air filter	Paper type
Fuel: Fuel tank capacity Fuel remaining when low fuel light turns ON	93# or above unleaded gasoline 27 ± 0.5 L 2.0 L

Throttle body type:		0800-173000	
Spark plug: Type Spark plug gap		DCPR8E(NGK) 0.8 ~ 0.9 mm	
Transmission	Clutch		Wet, centrifugal
	Transmission type		CVT + gearbox
	Shift operation		Left hand/L-H-R-P
	CVT ratio		2.88 - 0.70
	Gearbox	Low gear	43/17 = 2.529
		High gear	32/28 = 1.143
Reverse		29/13 = 2.231	
Chassis: Frame type		Tubular steel	
Tires Type Size Pressure		Tubeless Front: AT 26 X 9.00 – 12 65K or AT 26 X 9 – 14 64K Rear: AT 26 X 11.00 – 12 72K or AT 26 X 11 – 14 71K	
Brakes Front: Rear:		Hydraulic disc, foot operation Hydraulic disc, foot operation	

Front Suspension: Type Suspension travel Shock type	Double swing-arm Coil spring/oil damping or coil spring + gas spring/oil damping
Rear Suspension: Type Suspension travel Shock type	Double swing-arm Coil spring/oil damping or coil spring + gas spring/oil damping
Cooling system: Preliminary Change Coolant reservoir capacity	2.9 L 2.8 L 0.3 L
Electrical system: Ignition type Alternator	ECU Permanent magnet, AC
Lights: Low beam, headlight High beam, headlight Front position light Brake/tail light	H3 12V, 55W × 2 H7 12V, 55W × 2 LED LED

Battery Capacity	12V 30Ah	
Dashboard	Neutral indicator light	Green/diode
	Reverse indicator light	Red/diode
	Park indicator light	Red/diode
	High range indicator light	Yellow/diode
	Low range indicator light	Yellow/diode
	Panel light	Color LCD
	High beam indicator light	Blue/diode
	Override indicator light	Red/diode
	2WD/42D indicator light	LCD
	Coolant temp. indicator	LCD
	Fuel level indicator	LCD
	MIL	LED

Troubleshooting Guidelines

Drive Belt Wear/Burn

POSSIBLE CAUSE	SOLUTION
Driving onto a pickup or tall trailer in high range	Use low range during loading.
Starting out going up a steep incline	Use low range.
Driving at low RPM or ground speed (5-10 km/h)	Drive at a higher speed or use low range more frequently.
Insufficient warm-up at low ambient temperatures	Warm up the engine. The belt will become more flexible and prevent belt burning.
Slow/easy clutch engagement	Use the throttle quickly and effectively.
Towing/pushing at low RPM/low ground speed	Use low range only.
Utility use/plowing	Use low range only.
Stuck in mud or snow	Shift the transmission to low range and carefully use fast, aggressive throttle application to engage clutch. WARNING: Excessive throttle may cause loss of control and vehicle overturn.

Climbing over large objects from a stopped position	Shift the transmission to low range and carefully use fast, brief, aggressive throttle application to engage clutch. WARNING: Excessive throttle may cause loss of control and vehicle overturn.
---	--

Troubleshooting Guidelines

Drive Belt Wear/Burn

POSSIBLE CAUSE	SOLUTION
Driving onto a pickup or tall trailer in high range	Use low range during loading.
Starting out going up a steep incline	Use low range.
Driving at low RPM or ground speed (5-10 km/h)	Drive at a higher speed or use low range more frequently.
Insufficient warm-up at low ambient temperatures	Warm up the engine. The belt will become more flexible and prevent belt burning.
Slow/easy clutch engagement	Use the throttle quickly and effectively.
Towing/pushing at low RPM/low ground speed	Use low range only.
Utility use/plowing	Use low range only.

Stuck in mud or snow	Shift the transmission to low range and carefully use fast, aggressive throttle application to engage clutch. WARNING: Excessive throttle may cause loss of control and vehicle overturn.
Climbing over large objects from a stopped position	Shift the transmission to low range and carefully use fast, brief, aggressive throttle application to engage clutch. WARNING: Excessive throttle may cause loss of control and vehicle overturn.
Low battery voltage	Recharge the battery to 12.5 V
Mechanical failure	See your dealer
Loosen ground cable	Reconnect
Loosen crankshaft position sensor(CPS) connector	Reconnect

Engine Backfires

POSSIBLE CAUSE	SOLUTION
Weak spark from spark plug	Inspect, clean and/or replace spark plugs
Incorrect spark plug gap or heat range	Set gap to specs or replace plugs
Old or non-recommended fuel	Replace with fresh recommended fuel

Incorrectly installed spark plug wires	See your dealer
Incorrect ignition timing	See your dealer
Mechanical failure	See your dealer

Engine Pings or Knocks

POSSIBLE CAUSE	SOLUTION
Poor quality or low octane fuel	Replace with recommended fuel
Incorrect ignition timing	See your dealer
Incorrect spark plug gap or heat range	Set gap to specs or replace plugs

Engine Runs Irregularly, Stalls or Misfires

POSSIBLE CAUSE	SOLUTION
Fouled or defective spark plugs	Inspect, clean and/or replace spark plugs
Worn or defective spark plug wires	See your dealer
Incorrect spark plug gap or heat range	Set gap to specs or replace plugs
Loose ignition connections	Check all connections and tighten
Water present in fuel	Replace with new fuel
Low battery voltage	Recharge battery to 12.5 V

Kinked or plugged fuel tank vent line	Kinked or plugged fuel tank vent line Inspect and replace
Incorrect fuel	Replace with recommended fuel
Clogged air filter	Inspect and clean or replace
Other mechanical failure	See your dealer

POSSIBLE LEAN FUEL CAUSE

SOLUTION

Low or contaminated fuel	Add or change fuel, clean the fuel system
Low octane fuel	Replace with recommended fuel
Clogged fuel filter	See your dealer
Possible Rich Fuel Cause	

POSSIBLE LEAN FUEL CAUSE

SOLUTION

Fuel is very high octane	Replace with lower octane fuel
--------------------------	--------------------------------

Engine Stops or Loses Power

POSSIBLE CAUSE

SOLUTION

Out of fuel	Refuel
Kinked or plugged fuel vent line	Inspect and replace
Water is present in fuel	Replace with new fuel
Fouled or defective spark plugs	Inspect, clean and/or replace spark plug

Worn or defective spark plug wires	See your dealer
Incorrect spark plug gap or heat range	Set gap to specs or replace plug
Loose ignition connections	Check all connections and tighten
Low battery voltage	Recharge the battery to 12.8 V
Incorrect fuel	Replace with fresh recommended fuel
Clogged air filter	Inspect and clean or replace
Other mechanical failure	See your dealer
Overheated engine	Clean radiator screen and core, clean engine exterior, see your dealer

Troubleshooting the EFI System

1. Turn on the ignition switch. Do not start the engine. There is no error code present:

- MIL stays on for 5 seconds and then turns off.

2. Turn on the ignition switch. Start the engine. There is error code present.

- MIL stays on for 5 seconds and turns off. Then, it starts to blink the error codes in turn.
- The interval between the 2 error codes is 3.2 seconds.
- The interval between the 2 digits of error code is 1.2 seconds.
- A blink takes 0.4 seconds and the interval between each blink is 0.4 seconds.
- MIL blinks 10 times to indicate digit "0". From 1~9, how many it counts, how many times the MIL blinks.

Take error codes P0117 and P0232 for example:

P0117:

MIL stays on for 5 seconds → MIL stays off for 3.2 seconds → MIL blinks for 10 times → MIL stays off for 1.2 seconds → MIL blinks once → MIL stays off for 1.2 seconds → MIL blinks once → MIL stays off for 1.2 seconds → MIL blinks for 7 times.

P0232:

MIL stays off for 3.2 seconds → MIL blinks for 10 times → MIL stays off for 1.2 seconds → MIL blinks for 2 times → MIL stays off for 1.2 seconds → MIL blinks for 3 times → MIL stays off for 1.2 seconds → MIL blinks for 2 times.

MIL blinks P0117 then P0232 in turn until ignition switch is turned off or the engine is started.

3. Ignition switch is turned on and start the engine. There is error code present:

- MIL keeps on until the problem is fixed.

REF.	ERROR CODE	DESCRIPTION	REMARKS
1	P0107	MAP Circuit Low Voltage or Open	
2	P0108	MAP Circuit High Voltage	
3	P0112	IAT Circuit Low Voltage	
7	P0113	IAT Circuit High Voltage or Open	

9	P0117	Coolant/Oil Temperature Sensor Circuit Low Voltage	
10	P0118	Coolant/Oil Temperature Sensor Circuit High Voltage or Open	
11	P0122	TPS Circuit Low Voltage or Open	
12	P0123	TPS Circuit High Voltage	
13	P0131	O2S 1 Circuit Low Voltage	
14	P0132	O2S 1 Circuit High Voltage	
15	P0032	O2S 1 Heater Circuit High Voltage	
16	P0031	O2S 1 Heater Circuit Low Voltage	
17	P0201	Injector 1 Circuit Malfunction	
18	P0202	Injector 2 Circuit Malfunction	
19	P0230	FPR Coil Circuit Low Voltage or Open	
20	P0232	FPR Coil Circuit High Voltage	
21	P0336	CKP Sensor Noisy Signal	
22	P0337	CKP Sensor No Signal	
23	P0351	Cylinder 1 Ignition Coil Malfunction	

24	P0352	Cylinder 2 Ignition Coil Malfunction	
29	P0505	Idle Speed Control Error	
30	P0562	System Voltage Low	
31	P0563	System Voltage High	
32	P0650	MIL Circuit Malfunction	
33	P1693	Tachometer Circuit Low Voltage	
36	P1694	Tachometer Circuit High Voltage	
37	P0137	O2S 2 Circuit Low Voltage	
38	P0138	O2S 2 Circuit High Voltage	
39	P0038	O2S Heater 2 Circuit High Voltage	
51	P0037	O2S Heater 2 Circuit Low Voltage	
52	P0500	VSS No Signal	
60	P0850	Park Neutral Switch Error	
61	P0445	SAR short to high	
62	P0444	SAR short to low/open	
63	P0171	Several BLM value hit maximum	

64	P0172	Several BLM value hit minimum	
65	P0174	PE mode burned AFR keeps lean	

TABLE OF CONTENTS

CFMOTO WARRANTY COVERAGE.....	2
TERMS & CONDITIONS.....	2
DEALER INSPECTION REGISTRATION.....	7
CHANGE OF OWNERSHIP REGISTRATION.....	9
CFMOTO EMISSIONS LIMITED WARRANTY.....	10
MAINTENANCE CHART KEY.....	10
PERIODIC MAINTENANCE CHART.....	11

WARRANTY ACTIVATION:

- Dealer & Customer Information
- Dealer Checklist
- Customer Checklist



CFMOTO WARRANTY COVERAGE

Dear Customer,

Thank you for purchasing a CFMOTO ATV, UTV, SSV, Motorcycle, or Scooter. If any component on your vehicle is found to be defective in materials or workmanship within the terms and conditions of this Limited Warranty, the defective component will be repaired or replaced (at the option of CFMOTO) without charge for parts and/or labor at any authorized dealer located within the United States. The CFMOTO Limited Warranty is subject to the following terms and conditions:

TERMS & CONDITIONS

- 1. WARRANTY DURATION.** The duration of the Warranty period is one (1) year from the date of the new vehicle purchase from an authorized CFMOTO POWERSPORTS, Inc., Dealer. The warranty coverage is invoked from the purchase and use of CFMOTO vehicles only within the continental United States. During the warranty period, CFMOTO POWERSPORTS, Inc. will cover parts and labor costs incurred by an authorized CFMOTO POWERSPORTS, Inc., Dealer arising from a defect in material and/or workmanship of a CFMOTO vehicle. Any vehicles used for commercial purposes will have their warranty period reduced to six (6) months. If CFMOTO POWERSPORTS, Inc., covers a full engine replacement or a complete vehicle replacement under this warranty, the warranty period does not get extended and remains the same as the original purchase date of the vehicle at issue.
- 2. WARRANTY LIMITATIONS.** CFMOTO POWERSPORTS, Inc., provides warranty coverage for one (1) year on all parts and labor for all of its new CFMOTO Motorcycles, Scooters, ATVs, UTVs, and SSVs. However, the following coverage, exceptions, and limitations apply to all CFMOTO vehicles:
- 3. EXCLUSIONS FROM WARRANTY COVERAGE.** Any Damage resulting from the following acts or circum-

- a. **A 30-DAY WARRANTY** coverage period applies to all new CFMOTO vehicles in relation to the vehicles':
 - Battery
 - Spark Plugs
 - Air Filters
 - Oil and Fuel Filters
- b. **A 90-DAY WARRANTY** coverage period applies to all new CFMOTO vehicles in relation to the vehicles':
 - Drive Belts
 - Gear Shift, CVT, and Wet Clutches
 - Throttle, Brake, and Clutch Cables
 - Front/Rear Rims
 - Front/Rear Tires
 - Front/Rear Brake Pads or Shoes
 - Front/Rear Brake Discs or Drums
 - Wheel or Steering Stem Bearings and Seals
 - Rubber Parts/Engine Mounts/Grips/Boots
 - Brake or Clutch Levers
 - Floor Boards or Pegs
 - ATV/UTV/SSV Winch
 - Light Bulbs/Fuses
 - Body Plastics and Cosmetic Defects

stances is not covered by the CFMOTO POWERSPORTS, Inc., Limited Warranty:

- Fire
- Collision
- Theft
- Unavoidable natural disasters
- Improper storage or transportation
- Failure or negligence in the performance of periodic vehicle maintenance
- Improper or negligent use or operation
- Unauthorized repair or adjustment
- Unauthorized modifications or performance upgrades
- Use of vehicle as a rental vehicle
- Use of vehicle in competitive or racing events

4. VEHICLE CARE AND MAINTENANCE. The vehicle's owner must properly use, maintain, and care for the vehicle as outlined in the CFMOTO POWERSPORTS, Inc., Owner's Manual. Any warranty repairs must be performed exclusively by CFMOTO POWERSPORTS, Inc., authorized Dealers. Any warranty work performed by anyone other than an authorized CFMOTO Dealer will not be covered under the CFMOTO POWERSPORTS, Inc., Limited Warranty policy.

5. TRANSFER OR CONTINUATION OF WARRANTY. This warranty is transferable only under the following conditions:

- Transfer information must be provided to an authorized CFMOTO POWERSPORTS, Inc., dealer, who will then forward the information to CFMOTO POWERSPORTS, Inc.;
- The complete model and serial number as shown on the original warranty document must be provided;
- The name and address of the existing and new owners must be provided;
- The original delivery date of the vehicle must be provided;
- The new owner must indicate in writing that he/she has received and read the vehicle's Owner's Manual and the CFMOTO POWERSPORTS, Inc. Warranty Policy.

6. **WARRANTY REGISTRATION.** The Dealer must register the vehicle online and provide the completed registration form to CFMOTO POWERSPORTS, Inc., within seven (7) days of completing the sale of the vehicle. Please note that NO warranty claims will be processed unless the product warranty online registration form is completed and the form is received by CFMOTO POWERSPORTS, Inc., from the Dealer.
7. **CUSTOMER ASSISTANCE.** Any questions regarding your CFMOTO vehicle or related products should be directed to an authorized CFMOTO dealer. However, if a dealer is not available to answer customer concerns, or address a technical issue with a CFMOTO vehicle or product, CFMOTO POWERSPORTS, Inc., customer representatives can be contacted directly at (763) 398-2690 or by e-mail at info@cfmoto-us.com.
8. **DEALER RESPONSIBILITIES.** A CFMOTO authorized Dealer must perform warranty coverage repairs at no charge to the customer, even if they are not the dealer that sold the CFMOTO vehicle to the customer and must use CFMOTO OEM parts for all warranty repairs. All vehicles sold by the dealer must be inspected and tested by the dealer to ensure proper performance and operation prior to delivery to the customer. No vehicles may be delivered to a customer without first passing a dealer inspection and an operational test.
9. **COMMERCIAL USE.** The duration of the warranty for commercial use shall be limited to a period of six (6) months instead of one year for recreational use. All other conditions and limitations shall apply.
10. **TIRES PROVIDED AS ORIGINAL EQUIPMENT.** Other than provided herein, vehicle tires supplied as original equipment are warranted separately by the individual tire manufacturer or its representatives.
11. **DISCLAIMER.** NO EXPRESS WARRANTY IS PROVIDED BY CFMOTO POWERSPORTS, INC. WITH RESPECT TO CFMOTO VEHICLES EXCEPT AS SPECIFICALLY SET FORTH HEREIN. ANY IMPLIED WARRANTY, WARRANTY OF MERCHANTABILITY, WARRANTY OF FITNESS FOR A PARTICULAR PURPOSE, AND ALL IMPLIED WARRANTIES ARISING FROM A COURSE OF DEALING, USAGE OF TRADE, BY STATUTE OR OTHERWISE, ARE HEREBY STRICTLY LIMITED TO THE TERMS OF THIS

WRITTEN LIMITED WARRANTY.

12. INTEGRATION. This limited warranty supersedes any and all oral, express, or written warranties, statements, or undertakings that may previously have been made, and contains the entire agreement of the parties with respect to the warranty of CFMOTO vehicles. Any and all warranties not contained in this Agreement are specifically excluded. This warranty extends to each original (and subsequent) owner of any CFMOTO ATV, UTV, SSV, Motorcycle, or Scooter for the term of the original warranty period. This limited warranty shall be the sole and exclusive remedy available to the customer with respect to the covered CFMOTO vehicle. In the event of any alleged breach of any warranty or any legal action brought by the customer based on alleged negligence or other conduct by CFMOTO POWERSPORTS, Inc., or its related parties, the customer's sole and exclusive remedy will be repair or replacement of defective components as stated above, unless otherwise provided by law. Some states do not allow limitations on how long an implied warranty lasts, so the above limitations may not apply if they are deemed inconsistent with the controlling state law.

USA

INSPECTION REGISTRATION CARD	SERVICING MUST BE CARRIED OUT ACCORDING TO THE SCHEDULE DEFINED IN THE PRODUCTS USE AND MAINTENANCE BOOKLET					
INSPECTION NUMBER	1	2	3	4	5	6
Date						
Km/Miles						
Stamp and Signature of the Dealer						

<p align="center">INSPECTION REGISTRATION CARD</p>	<p align="center">SERVICING MUST BE CARRIED OUT ACCORDING TO THE SCHEDULE DEFINED IN THE PRODUCTS USE AND MAINTENANCE BOOKLET</p>					
<p>INSPECTION NUMBER</p>	7	8	9	10	11	12
<p>Date</p>						
<p>Km/Miles</p>						
<p>Stamp and Signature of the Dealer</p>						



CHANGE OF OWNERSHIP

If you sell the product, any valid remainder of the warranty can be transferred to the new Owner.
Please record the details of the exchange below and inform an Authorized **CFMOTO Dealer**.

REGISTRATION OF CHANGE OF OWNERSHIP	2nd OWNER	3rd OWNER	4th OWNER
OWNER'S NAME			
ADDRESS			
TOWN/CITY			
STATE-ZIP			
TELEPHONE			
E-MAIL			
DATE OF PURCHASE			
ODOMETER READING			
NEW OWNER SIGNATURE			

IMPORTANT:

If the details contained in the Change of Ownership Application form do not include the required details or are inaccurate, we reverse the right to investigate the actual ownership of the product and its service history and possibly refuse the application if the requirements for transfer have not been fulfilled.

EMISSION CONTROL SYSTEM WARRANTY:

CFMOTO Powersports, Inc. warrants to the ultimate purchaser and each subsequent purchaser of each 2013 and later model CFMOTO ROV covered by this warranty that vehicle is designed, built, and equipped so as to conform at the time of sale with all U.S. emissions standards applicable at the time of manufacture and that it is free from defects in materials and workmanship which would cause it not to meet these standards within the period listed immediately below. Failures other than those resulting from defects in material or workmanship which arise solely as a result of owner abuse and/or lack of proper maintenance are not covered by this warranty.

Maintenance Chart Key

- ▶ Perform these operations more often for vehicles subjected to severe use.
- Have an authorized dealer perform these services.
- ◆ Emission-related components.

 WARNING

Improperly performing the procedures marked with a ■ could result in component failure and lead to serious injury or death. Have an authorized dealer perform these services.

Periodic Maintenance Chart

Perform all services at whichever maintenance interval is reached first.

ITEM		MAINTENANCE INTERVAL (WHICHEVER COMES FIRST)			REMARKS
		Hours	Calendar	KM	
■	Steering wheel	—	Pre-ride	—	
▶	Front suspension	—	Pre-ride	—	
▶	Rear suspension	—	Pre-ride	—	
	Tires	—	Pre-ride	—	
▶	Brake fluid level	—	Pre-ride	—	
	Brake pads/brake pedal	—	Pre-ride	—	
	Brake system	—	Pre-ride	—	
	Wheels/fasteners	—	Pre-ride	—	
	Frame fasteners	—	Pre-ride	—	
▶	Engine oil level	—	Pre-ride	—	
▶	Air filter inlet	—	Pre-ride	—	Inspect, clean when necessary.
▶	Air filter moisture catch tube				Clean when necessary.

	Coolant	50h	—	1500km	Check at the first 20 H or 750 km. Replace every 2 years or 6000 km or 200 H.
	Headlights/tail lights		Daily		Check the operation.
▶◆	Air filter element	50h	—	1500km	Replace at the first 750 km or 20 H.
	CVT inlet, outlet and drain tube	20h	—	750km	Clean, and drain the water when necessary. Check at the first 750 km or 20 H.
▶	Brake pad wear	20h	Monthly	750km	Check for abnormal wear.
	Battery	50h	Monthly	1500km	Check the terminals and clean oxide. Check at the first 750 km or 20 H.
▶	Front differential oil	50	Monthly	1500km	Check the oil level. Replace every 3000 km or 100 H. Replace at the first 750 km or 20 H.
▶	Rear gearcase oil	50	Monthly	1500km	Check the level. Replace every 3000 km or 100 H. Replace at the first 750 km or 20 H.
▶	Clutch	100	12 M	3000km	Inspect
▶	General lubrication	20	3 M	600	Lubricate all the fittings, pivots, cables, etc.
	Steering knuckle	20	3 M	600	Inspect, lubricate, adjust

■	Steering system	20h	3M	600km	Lubricate
▶	Front suspension	20h	3M	600km	Lubricate
▶	Rear suspension	20h	3M	600km	Lubricate
	Shift linkage	20h	3M	600km	Inspect, lubricate, adjust
■	Throttle cable	20h	3M	600km	Inspect, lubricate, adjust. Replace if necessary.
■	Drive belt	50h	—	1500km	Replace every 100 H or 3000 km.
■	Throttle body	100h	—	3000km	Check for dirt ingress, clean as needed. Check at first 20H or 750km.
▶	Engine oil change	100h	12M	3000km	Replace after first 20 H or 750 km.
▶◆	Fuel hoses	40h	—	3000km	Check the routing, conditions. Replace the high pressure fuel hoses every 4 years.
■◆	Valve clearance	100h	12M	3000km	Inspect, adjust at the first 750 km or 20 H.
■	Fuel system	100h	12M	3000km	Inspect fuel cap, fuel pump and fuel pump relay.
■	Air filter	100h	12M	3000km	Replace. Replace at the first 750 km or 20 H.

▶	Radiator, radiator cap, cooling system pressure	200h	24M	6000km	Inspect at the first 750 km or 20 H. Clean the radiator fins as needed.
▶	Coolant hoses	100h	—	3000km	Inspect at the first 750 km or 20 H.
▶	Engine mounts	100h	12M	3000km	Inspect at the first 750 km or 20 H.
	Exhaust system	100h	12M	3000km	Inspect
■	Ignition coil	100h	12M	3000km	Inspect. Replace if necessary.
■	ECU	100h	12M	3000km	Inspect. Replace if necessary.
▶	Wiring	100h	12M	3000km	Inspect. Replace if necessary.
■	Drive and driven pulleys	100h	12M	3000km	Inspect, clean. Replace worn parts .
■	Wheel bearings	50h	12M	1500km	Inspect. Replace if necessary.
■	Brake fluid	100h	12M	3000km	Inspect. Replace every 2 years.
◆	Spark plug	100h	12M	3000km	Inspect at the first 20 H or 750 km. Replace every 200 H or 6000 km
	Idle speed				Standard: 1300 ±100 rpm
■	Master cylinder push rod				Check periodically. Replace the parts if necessary.
■	Auxiliary brake				Inspect daily. Adjust as needed.
	Headlight aim				Adjust when necessary.



IMPORT BY: CFMOTO POWERSPORTS, INC.

3555 Holly Lane N. Suit# 30, Plymouth, MN 55447, USA

Toll free: (888)8-CFMOTO(823-6686)

Tel:(1)763 398 2690Fax:(1)763 398 2695

Website:www.cfmoto-us.com