



Welder's Handbook

For gas shielded arc welding
and oxy-fuel cutting

United Kingdom

Air Products PLC
T +44 0800 389 0202
apukinfo@airproducts.com
airproducts.co.uk

Ireland

Air Products Ireland Ltd.
T +353 1800 99 50 29
ieinfo@airproducts.com
airproducts.ie

© Air Products and Chemicals, Inc., 2018

First published 2017

All rights reserved. No part of this publication may be reproduced, stored in a retrieval system or transmitted, in any form or by means, electronic, mechanical, photocopying, recording or otherwise, without prior permission of Air Products and Chemicals, Inc.

Printed in the UK

Although the author has made every effort to ensure that the information contained in this document was correct at time of publication, it does not assume and hereby disclaims any liability to any party for any loss, damage or disruption caused by errors or omissions, whether such errors or omissions result from negligence, accident or any other cause.



£13.00

Welder's Handbook

For gas shielded arc welding
and oxy-fuel cutting

Contents

Introduction

Welding basics	2
Why use welding?	3
Which process?	4

MIG/MAG welding

Principles	6
Operation	7
Welding positions	8
Gases for MIG/MAG welding	10
Maxx® gases: our best weld process gases	10-11
Standard weld process gases	11

TIG welding

Principles	12
Operation	12
Power sources for TIG welding	13
Choice of current	14
Crater filling	14
Tungsten Electrodes	15
Torches	17
Maxx® gases: our best weld process gases	18
Pulsed TIG	19
TIG spot welding	19

Plasma arc welding 20

Gas backing 21

Welding of sheet metal 22

MIG/MAG welding of plate

Recommended joint preparations for butt welds in carbon and stainless steels	24
---	----

Welding pipes and tubes	27
<hr/>	
Defects in weld	
Porosity	29
Lack of fusion/penetration	30
Undercut	31
Spatter	31
Solidification cracks	32
<hr/>	
Useful data for MIG/MAG welding	33
Typical conditions for MAG welding of carbon/carbon manganese steel	34
Typical conditions for MIG/MAG welding with solid wire	35
Typical welding conditions for all positional rutile cored wires	38
Current ranges for MIG/MAG welding with steel wire	39
<hr/>	
Useful data for TIG welding	
Typical conditions for TIG welding with non-pulsed welding machines	40-41
<hr/>	
Oxygen-fuel gas cutting	42
Equipment	43
<hr/>	
Safe operating practices - oxy-fuel gas	
Assembly and initial set-up	44
Purging the system	46
Lighting up	47
Shutting down	48
<hr/>	
Oxygen and acetylene Integra® cylinder	49
The quality of a cut surface depends on a number of variables	51
Quality of cut	52
Operating techniques	52
Typical operating conditions	54
Injector torches	55
<hr/>	

Introduction

Welding basics

Welding by fusion requires localised melting of the components to be joined. The melted materials mix in the weld pool which solidifies forming a weld.

Two widely used heat sources are:

Electric arc

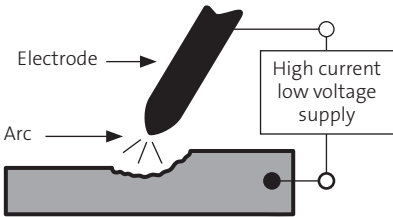

Gas flame

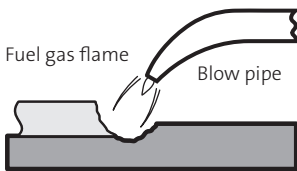

The strength of the welded joint should be greater than, or equal to, the strength of the parent material. Quality is paramount.

The molten metal and surrounding area must be protected from the atmosphere. This is commonly achieved using a weld process gas or flux (see examples below).

Metal inert gas

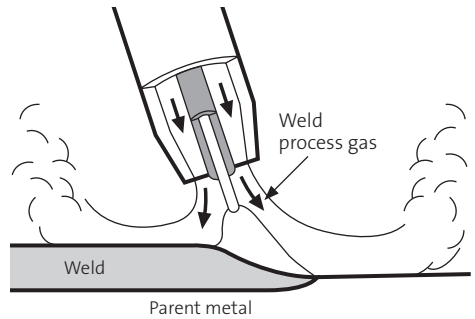

In metal inert gas (MIG) welding, a weld process gas is used.

Manual metal arc welding

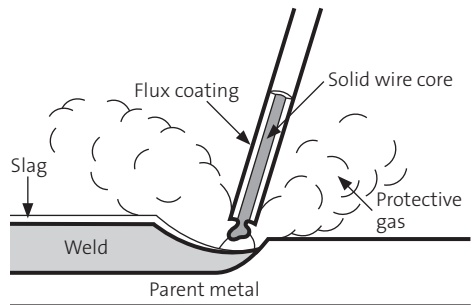

In manual metal arc (MMA) welding, a flux is used to generate a protective gas and slag.

Why use welding?

Welding is used because it is:

- One of the most cost-effective methods of joining metal components
- Suitable for a wide range of materials and thicknesses
- Applicable to a wide range component shapes and sizes

The joints produced by welding are:

- Permanent
- Strong, usually matching or exceeding the strength of the parent materials
- Leak-tight
- Reproducible
- Readily inspected by non-destructive techniques

Welding can be carried out:

- In the workshop or on-site
- Manually, mechanised or robotic

“T” joint

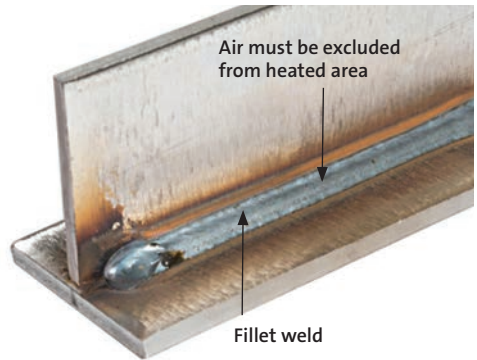

Butt joint

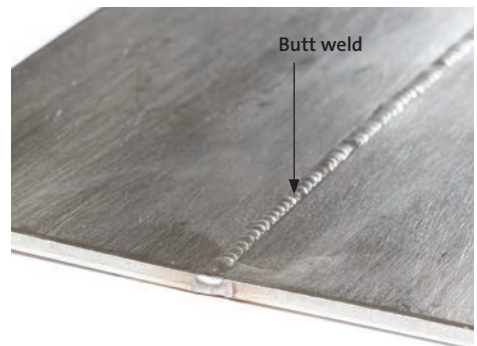

Which process?

A large number of welding processes and techniques are available. The most common are:

- **Manual metal arc (MMA) welding** also known as **shielded metal arc welding (SMAW)** or **stick welding**
- **Tungsten inert gas (TIG)** also known as **gas tungsten arc welding (GTAW)**
- **Metal inert gas (MIG) / metal active gas (MAG)** also known as **gas metal arc welding (GMAW)**

There is no single process that is universally better than another, each process has its own special attributes and must be matched to the application. Choosing the most suitable process requires careful consideration of a number of factors including:

- Type of material to be welded
- Availability of consumables and equipment
- Joint configuration and position
- Material thickness
- Production quantity
- Quality assurance and quality control requirements
- Skills and qualifications of available labour
- Working environment and conditions
- Health, safety and environmental considerations

MIG/MAG

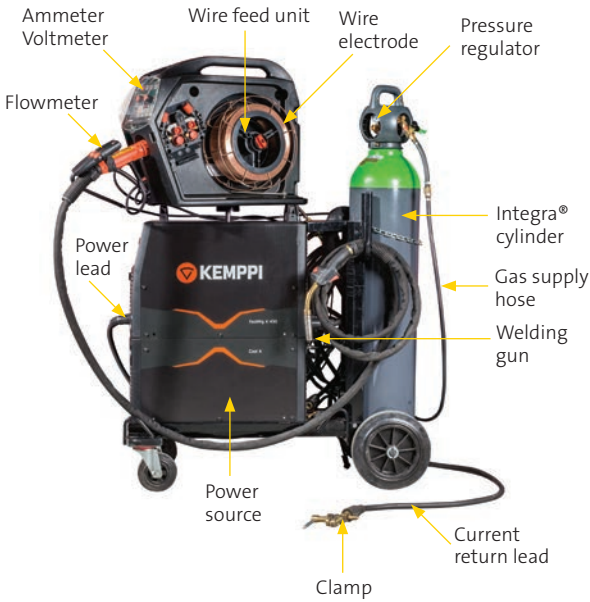

Two of the most common arc weld processes - **MIG/MAG** and **TIG** - use a gas shield to protect the weld metal from atmospheric contamination.

TIG



MIG/MAG welding

Principles

A semi-automatic consumable electrode process which is suitable for manual, mechanised and robotic welding.

A low voltage (12–45V), high current (60–500A) arc between the end of a consumable wire electrode and the work provides the heat needed for the welding operation. The consumable wire electrode is continuously fed through the welding torch, where it melts, mixes with the molten base material and forms a weld pool. The weld pool and surrounding areas are protected from atmospheric contamination by a weld process gas. This gas also stabilises the arc and assists metal transfer.

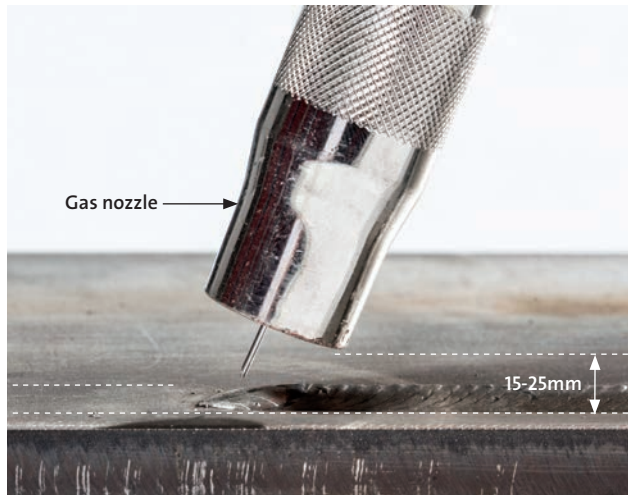

Operation

An electric motor feeds the wire into the arc, and the power source keeps the arc length at a preset value. This allows the welder to concentrate on ensuring a complete fusion of the joint.

Most power sources for MIG/MAG welding processes are known as **constant voltage machines**.

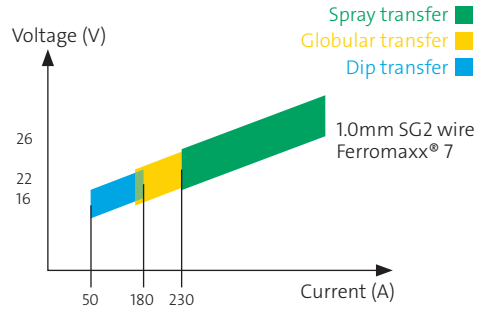
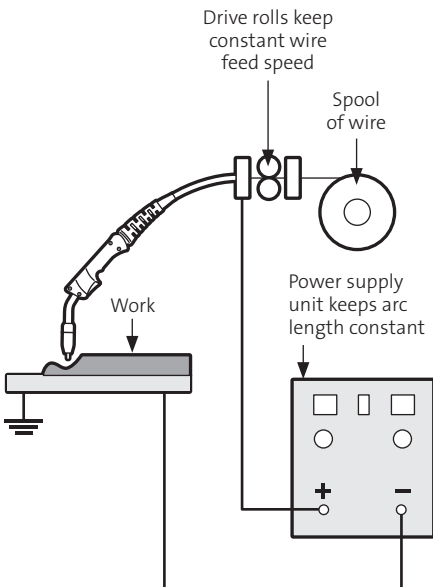

To set up a MIG/MAG welding machine, there are three key parameters;

- arc current / wire feed speed
- arc voltage
- welding speed

The correct settings of these parameters depend on the type of parent material, thickness, type of joint, welding position, type of filler material and weld process gas. Guide values can be found in data tables supplied with your welding machine or by consumables manufacturers.

Air Products provides preliminary weld procedure specifications (pWPS) and associated weld procedure qualification records (WPQR) which contain all key parameters for commonly welded joints. These can be accessed via the Air Products website.

The combination of these key parameters determines the stability of the arc, the size of the weld and the applied heat input. Heat input may need to be controlled in order to achieve required mechanical properties. Check your WPS for guidance and if you do not have an approved WPS, seek expert advice from a qualified welding engineer.

Welding positions

When welding, it is ideal to orientate your work in positions where gravity helps to control the weld pool. These are positions PA and PB (see diagram) - in these positions, the most productive transfer mode - 'spray arc' - can be used. In all other positions, 'short-arc' or 'pulse' transfer are typically used when welding with a solid wire. Alternatively, a range of flux cored wires are available to assist when positional welding.

Top Tip

Faster travel speeds with Ferromaxx[®], Inomaxx[®] and Alumaxx[®] welding gases mean reduced welding costs.

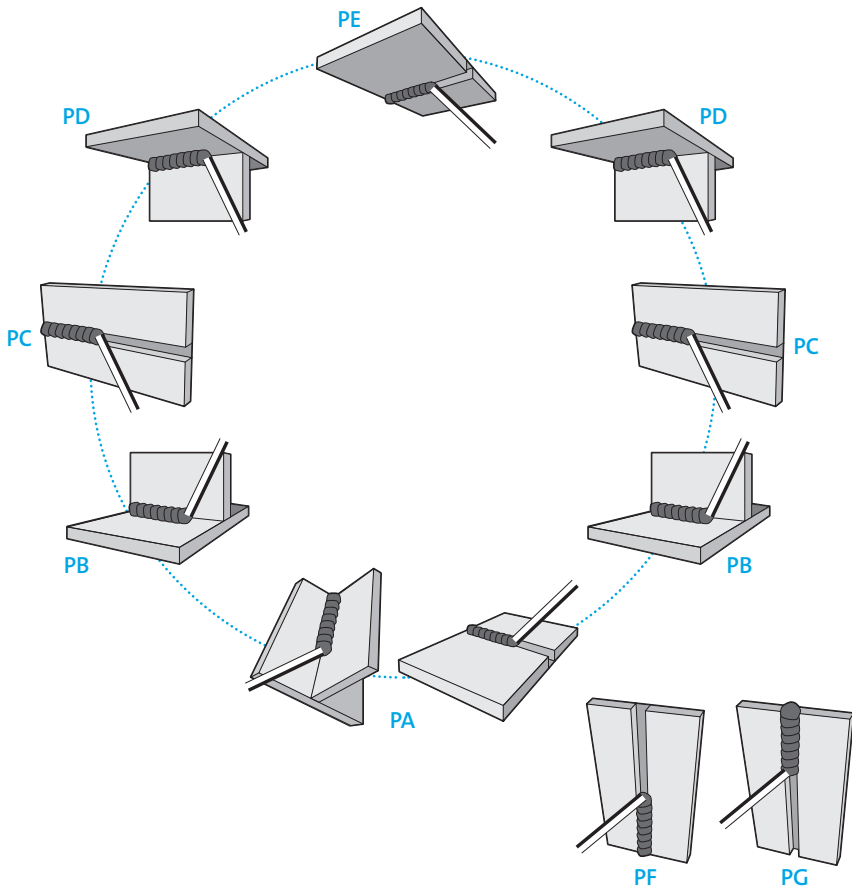

The most commonly used welding technique is forehand welding where the torch is pointing in the direction of travel.

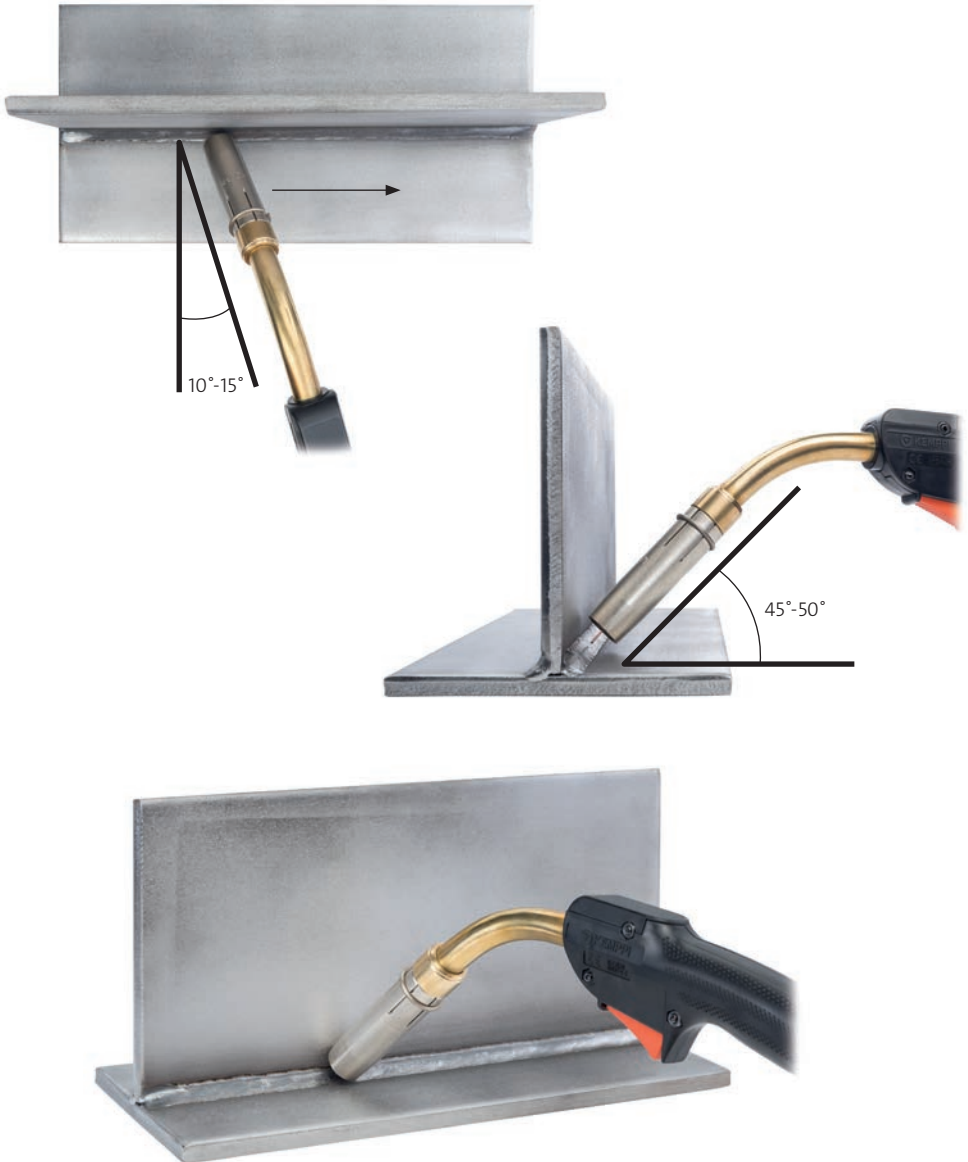

Pulsed MIG/MAG welding uses the welding current to control droplet transfer allowing positional welding

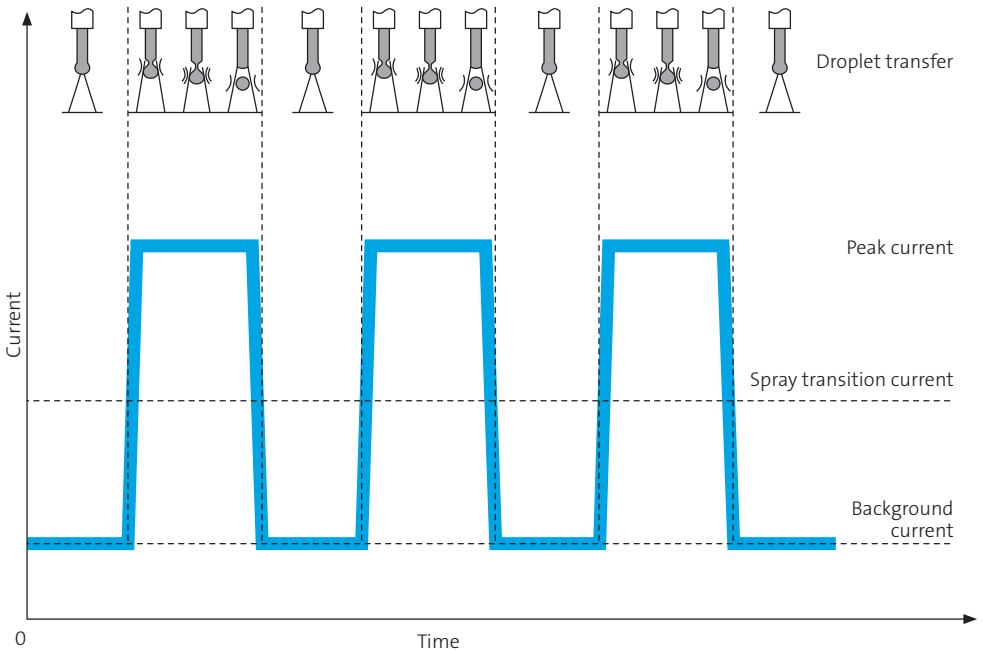

Gases for MIG/MAG welding

Air Products' weld process gases are designed to deliver optimum performance when MIG/MAG welding. All of these gases meet the requirements of ISO14175 / AWS 5.32 - "Welding consumables - Gases and gas mixtures for fusion welding and allied processes"

This standard is widely used across industry to classify weld process gases. It assists with the correct gas selection and minimum quality control and labeling requirements.

Maxx[®] gases: our best weld process gases

These gases are grouped into three families to ensure easy selection:

- **Ferromaxx[®]** gases - for carbon steels
- **Inomaxx[®]** gases - for stainless steels
- **Alumaxx[®]** gases - for aluminium and alloys

Maxx[®] gases: our best weld process gases

Material	Weld Process Gases	Application
Carbon and alloy steels	Ferromaxx[®] Plus - M20ArHeC20/12 The best gas mixture for faster, cleaner MAG welding of carbon steel	MAG welding, extremely suitable for mechanized and robotic welding. Solid, metal and flux cored wires. Coated steels.
	Ferromaxx[®] 7 - M24ArCO7/2.5 The thin and medium carbon steel specialist	MAG welding, specially good performance on thin materials. Dip, pulsed and spray transfer. All welding positions. Solid wires.
	Ferromaxx[®] 15 - M24ArCO15/2.5 The reliable all-rounder for carbon steel MAG welding	MAG welding, all material thickness. Dip, pulsed and spray transfer. All welding positions. Solid, metal and flux cored wires.
Stainless steels	Inomaxx[®] Plus - M12ArHeC35/2 The best gas mixture for MAG welding stainless steel	MAG welding, all material thickness. Dip, pulsed and spray transfer. All welding positions. Solid & metal cored wires. Manual, robotic or automated welding.
	Inomaxx[®] 2 - M12ArC2 The reliable gas mixture for MAG welding thin and medium thickness stainless steel	MAG welding, all material thickness. Dip, pulsed and spray transfer. All welding positions. Solid wires.
Aluminium and alloys	Alumaxx[®] Plus - I3ArHe30 The best gas mixture for MIG and TIG welding aluminium	MIG welding, all material thickness. Pulsed & spray transfer. Manual, robotic or automated welding.

Standard weld process gases

Material	Weld Process Gases	Application
Carbon and alloy steels	M14ArC5/2 M20ArC8 M20ArC12	MAG welding, on thin and clean materials. dip, pulse and spray transfer. All welding positions. Solid wires.
	M20ArC15 M21ArC18 M21ArC20 M21ArC25 M24ArC12/2 M24ArC15/2 M26ArC20/2	MAG welding, all material thickness. Dip, pulsed and spray transfer. All welding positions. Solid, metal and flux cored wires.
Stainless steels	M12ArC2 M13ArO1 M13ArO2	MAG welding, all material thickness. Dip, pulsed and spray transfer. All welding positions. Solid wires.
Aluminium and alloys	I1 Ar (100% Argon)	MIG welding, all material thickness. Pulse & spray transfer. Manual, robotic or automated welding.

TIG welding

Principles

Tungsten inert gas welding is usually called TIG welding.

An electric arc between a non-consumable tungsten electrode and the workpiece provides the heat needed for the welding operation. The tungsten electrode is not melted and any filler metal needed to build up the weld profile is added separately. The molten metal in the weld pool, the tip of the filler wire and the hot electrode are protected from atmospheric contamination by a shield of inert gas. Usually the gas is argon, but helium by itself, or mixed with argon, may be used for special applications. Argon-hydrogen mixtures can be used for austenitic stainless steel.



Operation

In manual welding the operator points the electrode in the direction of welding and uses the arc to melt the metal at the joint. If filler metal is required, when making a fillet weld for example, it is added to the leading edge of the weld pool. Filler is supplied as cut lengths of wire, usually 1 meter in length.

Arc length is controlled by the welder and is usually between 2mm and 5mm.

Travel speed is adjusted to match the time needed to melt the joint and keep a constant weld pool size.

TIG welding allows independent control of the heat from the arc and the input of the filler material. This enables excellent control of the weld pool making TIG welding the optimum choice when welding root passes, thinner materials and when a superior weld surface finish is required.

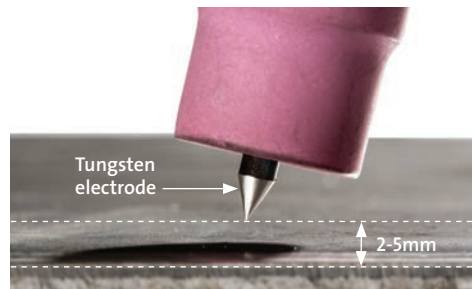



Top Tip

Weld process gases containing helium enhance heat transfer which assists when welding metals with high thermal conductivity such as aluminium, copper and their alloys.

Power sources for TIG welding

Power sources for use with TIG welding can either be alternating current (AC) or direct current (DC), both must be capable of delivering a constant current at a preset value.

One of the advantages of TIG is that it allows you to weld a wide range of materials. Modern power sources combine constant current and constant voltage characteristics and deliver excellent arc stability. Machines ranging from 5A (micro-TIG) to over 500A are available.

Using a high frequency (HF) arc starting device enables the arc to be struck without the need to touch the workpiece with the electrode.

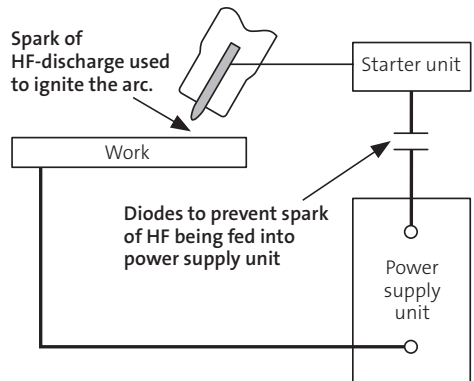

Choice of current

Both direct current (DC) and alternating current (AC) are commonly used when TIG welding.

Direct current with the electrode connected to the negative terminal (DCEN) of the power source is used for:

- Carbon steels
- Copper and its alloys
- Stainless steels
- Nickel and its alloys
- Titanium and its alloys
- Zirconium and its alloys

Alternating current is used for welding:

- Aluminium and its alloys
- Magnesium and its alloys
- Aluminium bronze

Power sources are available to deliver pulsed DC or combining AC and DC.

Top Tip

Only use stainless steel wire brushes and scrapers to clean aluminium before welding. Do not use these to clean other materials.

Crater filling



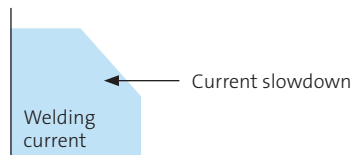
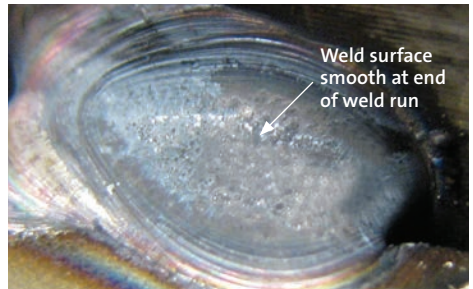
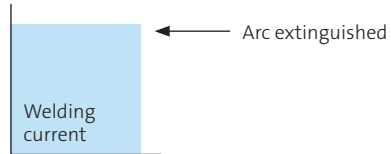
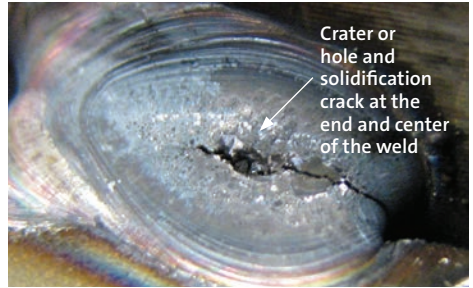

















Automatic gradual reduction of the current at the end of a weld run avoids the formation of a crater.



Tungsten Electrodes

Pure tungsten electrodes can be used however, thoriated and zirconiated types give easier starting and better arc stability and are therefore the preferred choice. Ceriated or lanthanated tungstens are also available (see table below.)

Thoriated electrodes contain a radioactive material and may pose a health and environmental risk as the dust from grinding these electrodes is particularly hazardous if ingested or inhaled. They can be replaced by electrodes with lanthanum, cerium, yttrium and zirconium.

Metal	Type of Current	Tungsten
Aluminium, aluminium alloys	AC	 Pure  Zirconiated  Ceriated  Thoriated  Lanthanated
	AC Squarewave	 Zirconiated  Ceriated  Thoriated  Lanthanated
Copper, copper alloys	DCEN	 Ceriated  Thoriated
Magnesium alloys	AC	 Zirconiated  Ceriated  Thoriated  Lanthanated
Plain carbon steels	DCEN	 Ceriated  Thoriated  Lanthanated
Stainless steels	DCEN	 Ceriated  Thoriated  Lanthanated

The diameter of the electrode is chosen to match the current. The maximum current which a given diameter of electrode can carry is determined as the current beyond which the electrode overheats and melts. The minimum current depends on arc stability.

Electrode diameter (mm)	Direct current (A)	Zirconated and Pure Tungsten	Ceriated, Thoriated and Lanthanated
1.0	15 - 80	10 - 30	20 - 60
1.6	50 - 150	30 - 80	50 - 120
2.4	100 - 250	60 - 130	80 - 180
3.2	200 - 400	100 - 180	160 - 250

Before use, the end of the electrode is prepared using a special electrode grinder to give the most appropriate profile.

For DC welding a sharp point is required. For AC welding only a small bevel is needed as the end of the electrode becomes rounded when the arc is operated.



AC welding
Ø All mm

DC welding
Ø ≥ 3.2mm

DC welding
Ø < 3.2mm

AC square
wave welding
Ø All mm

Top Tip

When grinding tungsten electrodes it is recommended that a dedicated grindstone with local dust extraction is used and a filter mask and eye protection is worn.

Torches

TIG torches are rated according to the current they can carry without overheating. At currents typically above 250A, the torch body and possibly the nozzle are water cooled. At lower currents, the flow of the weld process gas provides sufficient cooling.

Semi-automatic torch



Manual (scratch start) torch



A torch with a gas lens provides a laminar gas flow allowing the electrode to be set further out from the end of the nozzle giving better visibility of the arc and weld pool whilst maintaining the proper shield.

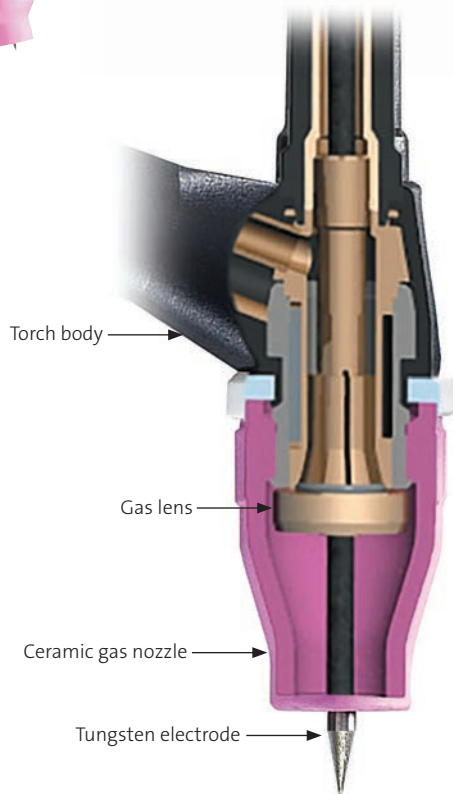

Air Products' weld process gases are designed to deliver optimum performance when TIG welding. All of these gases meet the requirements of ISO14175 / AWS 5.32 - "Welding consumables — Gases and gas mixtures for fusion welding and allied processes."

This standard is widely used across industry to classify weld process gases. It assists with the correct gas selection and minimum quality control and labeling requirements.

Maxx[®] gases: our best weld process gases

These gases are grouped into three families to ensure easy selection:

- Argon - for carbon steels
- Inomaxx[®] TIG gases - for stainless steels
- Alumaxx[®] gases - for aluminium and alloys

Material	Weld Process Gases
Carbon and alloy steels	<p>Argon - I1Ar Suitable for TIG welding of all materials</p>
Stainless steels	<p>Inomaxx[®] TIG - R1ArH2 The best gas for TIG welding of austenitic stainless steels</p>
	<p>Argon - I1Ar Suitable for TIG welding of all materials</p>
Aluminium and alloys	<p>Alumaxx[®] Plus - I3ArHe30 The best gas for TIG welding of all aluminium and its alloys</p>
	<p>Argon - I1Ar Suitable for TIG welding of all materials</p>

Pulsed TIG

When TIG welding thin section materials control of the weld pool and penetration become more difficult with a continuous weld current. Pulsing the current improves control at the lower heat input levels required for thin section materials. The pulsed TIG arc switches from a low (base) current, just sufficient to maintain the arc and allow the weld pool to cool, and a higher peak current selected to achieve the required fusion and weld pool geometry.



Low pulse frequencies are used when a cosmetically-appealing weld finish (commonly referred to as 'fish scales') is required.

High pulse frequencies are commonly used when a higher welding speed and a deeper and narrower fusion profile is required.

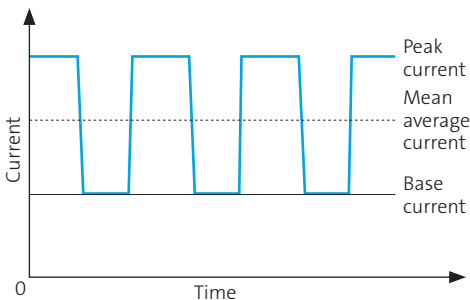

Pulsed TIG can be used to weld cylindrical components. This avoids the need to increase travel speed to keep the weld width uniform which is a great advantage in mechanised welding.

TIG spot welding

TIG spot welding provides an alternative to resistance spot welding where access is from one side only or where it is not possible to fit the component between the arms of the spot welder.

In this technique, the electrode is held at a fixed distance above the surface of a lap joint using a special gas nozzle. A combination of weld current and time is selected to create a spot weld. After the weld has formed the current is reduced progressively to allow the weld to solidify without a crater.

Plasma arc welding

Plasma arc welding is similar to TIG welding. The key difference is that the arc is forced through an additional nozzle which constricts the arc and positions the electrode within the body of the torch. The plasma arc has a much higher energy concentration than TIG creating deeper, narrower welds.

Plasma arc welding commonly utilises a special mechanised or automated technique known as keyhole welding. First a hole is pierced through the joint (keyhole) by the plasma arc. The torch is moved along the joint, metal melts at the front of the hole, swirls to the back and solidifies. Additional filler may, or may not, be required.

Another common application of plasma arc welding is hard facing or weld cladding - this is where a powder or wire consumable is used to build up a layer of wear or corrosion resistant material on the surface of a component. This is known as plasma powder arc welding (PPAW).

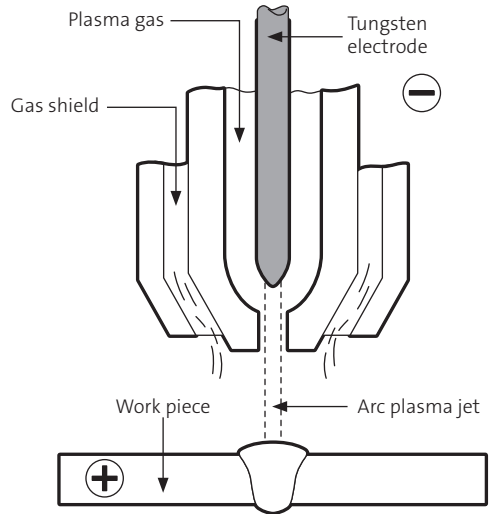

The gas surrounding the electrode, the plasma gas, is usually argon and the gas providing the shield can be argon or mixtures of argon/hydrogen or argon/helium.

Pure helium or argon/helium mixtures can be beneficial as a plasma gas for hard facing or cladding applications.

Conventional TIG welding

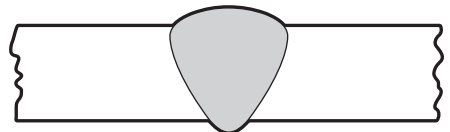

Plasma arc welding

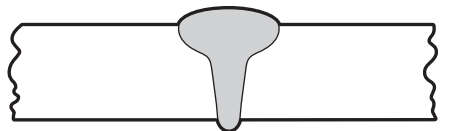

Gas backing

When weld metal penetrates through the root in a butt joint, it is exposed to air and oxidises. This can cause poor quality welds in steels especially stainless steel and reactive metals such as titanium. Contamination can be avoided by protecting the weld root with a gas shield known as a backing or forming gas.

Material	Backing gas
Carbon, alloy and stainless steels	Argon Nitrogen/hydrogen Nitrogen
Aluminium and alloys	Argon

Argon is most commonly used as a backing gas, however, advantages will be seen, particularly when welding stainless steels if mixtures of hydrogen in nitrogen are selected. N5NH5 (5% hydrogen in nitrogen) or N5NH10 (10% hydrogen in nitrogen) are recommended for backing gas when welding stainless. The hydrogen scavenges the oxygen in the gas-protected area around the root often reducing purge times and the amount of backing gas required, resulting in a brighter weld finish (less oxidation).

Top Tip

Use backing gas for 1st, 2nd and 3rd passes as well on wall thicknesses greater than 10mm.

Purging should be completed in 3 stages:

- Slowly displace the air before starting to weld. Oxygen levels should be below 50 parts per million (ppm).
- Maintain the purge during welding. A minimum flowrate should be selected to maintain oxygen levels below 50 ppm
- Maintain the purge after welding. A minimum flowrate should be selected to maintain oxygen levels below 50 ppm until temperature has dropped below 250°C.

The purging technique is determined by the density of the backing gas:

Lighter than air

- N5NH5
- Helium
- N5NH10
- Nitrogen

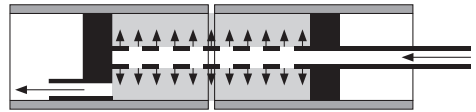

Heavier than air

- Argon
- R1ArH5

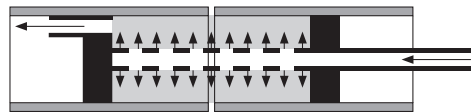

Welding of sheet metal

Both TIG and MIG/MAG processes can be used to weld sheet material - this is typically regarded as material which is 3mm or less. When MIG/MAG welding you should only use dip or pulse transfer techniques.

The edges of the sheet to be welded should be:

- cut square
- free of burrs
- clean and degreased
- free of oxides

When welding sheet material, always ensure a close fit-up of the joint. Sheets should be held in alignment by clamping to a backing bar. If this is not possible, place small tack welds every 50mm along the joint line. When welding butt joints and a full penetration weld is required, set a gap equal to 50% of the plate thickness prior to clamping or tack welding.

The most common joint types are:

'T' joint



Butt joint

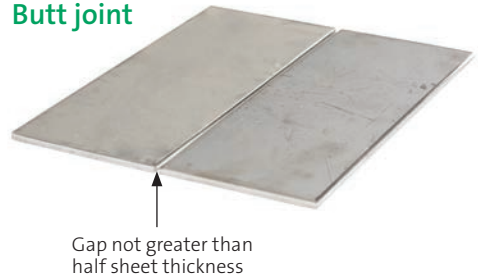

Corner joint



For all joint types, use the same slightly pushing torch technique as used on thicker plate material. The arc should be directed into the center of the joint and your parameters adjusted so that the arc plays on the middle of the weld pool rather than on the leading edge. This will minimize the risk of burn-through.

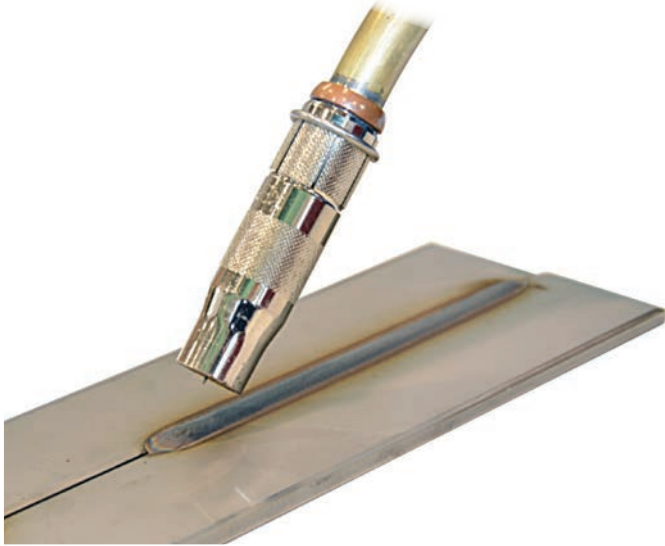

When butt joints in sheet of less than 1mm thick are to be TIG welded, the edges of the sheet can be flanged to avoid the need to use filler metal. When welding without filler metal the process is referred to as autogenous welding.

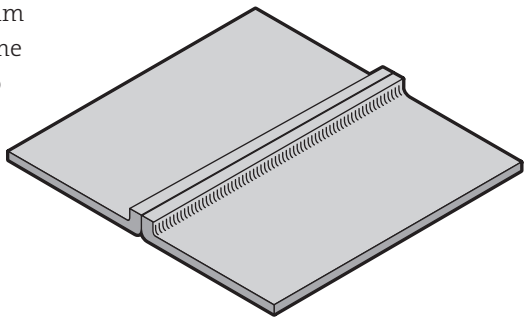

Welding of plate

Both TIG and MIG/MAG processes can be used to weld plate material - this is typically regarded as material which is over 3mm.

For plate up to 6mm thickness, the edges can be cut square and for 6mm and over, an edge preparation such as a single 'v' or double 'v' (photo page 25) is required, which calls for a larger weld. MIG/MAG welding,

or a combination of MIG/MAG welding with a TIG welded root pass, are the most commonly used techniques.

Spray transfer is highly productive and can be used for butt joints in the flat position and for T-joints in both flat (PA), and horizontal/vertical (PB) positions.

Recommended joint preparations for butt welds in carbon and stainless steels

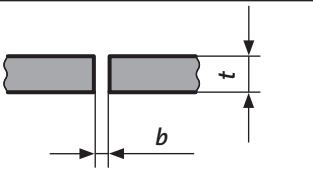
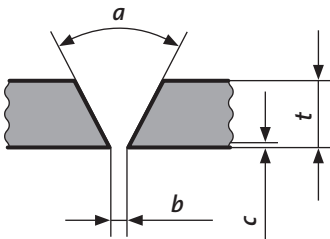
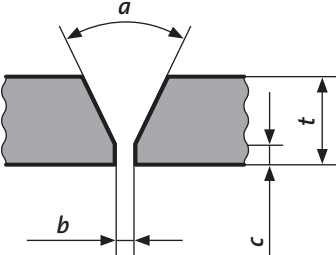
	Thickness (t)	Angle ^a a, β	Gap ^b b (mm)	Thickness of root face c (mm)
	Up to 6mm	–	$\sim t$	–
	4 - 12mm	$40^\circ \leq a \leq 60^\circ$	≤ 4	≤ 2
	5 - 40mm	$a \approx 60^\circ$	$1 \leq b \leq 4$	$2 \leq c \leq 4$

Single 'V'

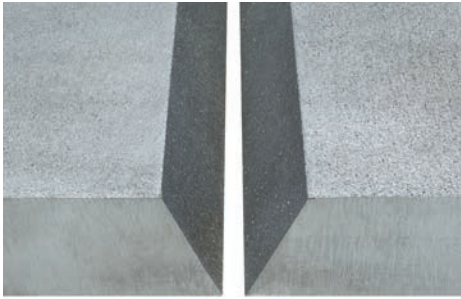

Double 'V'

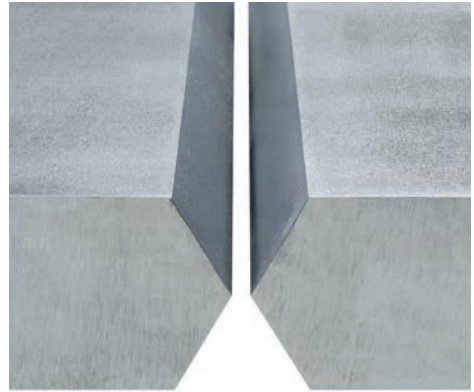

Recommendations for weld preparation of aluminium and its alloys can be referenced in ISO 9692-3 "Welding and allied processes — Types of joint preparation — Part 3: MIG and TIG welding of aluminium and its alloys."

Cross-section	Thickness (t)	Angle ^a a, β	Gap ^b b (mm)	Thickness of root face c (mm)	Depth of prep. h (mm)
	> 12mm	$40^\circ \leq a \leq 60^\circ$	$1 \leq b \leq 3$	≤ 2	$\approx t/2$
		$40^\circ \leq a_1 \leq 60^\circ$ $40^\circ \leq a_2 \leq 60^\circ$			$\approx t/3$

The number of runs needed to fill the groove depends on the thickness.

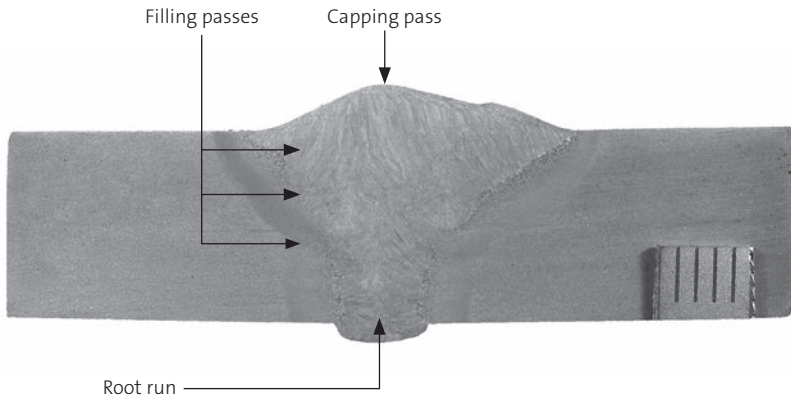

The deep penetration characteristic of spray transfer makes it difficult to control the molten metal in a root run. The root run can be deposited with dip or pulsed MIG/MAG or TIG welding.

Alternatively, the underside of the root run can be supported by a ceramic backing strip which is removed after welding.

Welding pipes and tubes

There are three main types of welded joint used:

- butt
- branch
- flange

The pipe or tube should, if possible, be positioned in a manipulator and rotated so that the weld is made in the horizontal position (PA position, see page 8) enabling the most productive welding process to be used.

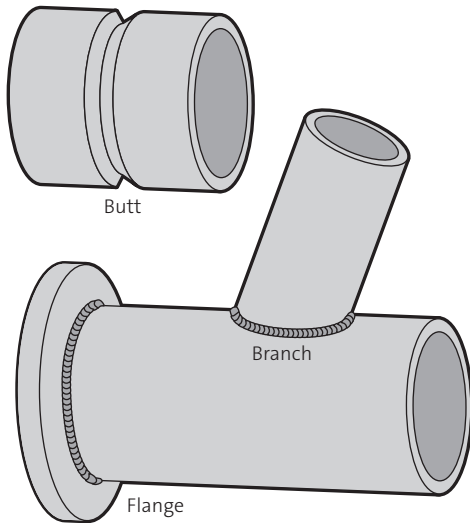
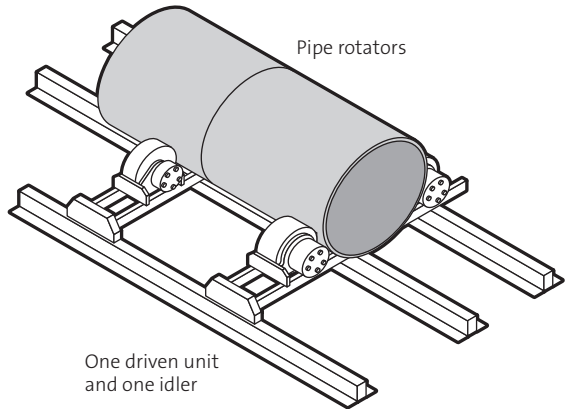

Before welding, the pipes can be clamped or tack welded to maintain alignment.

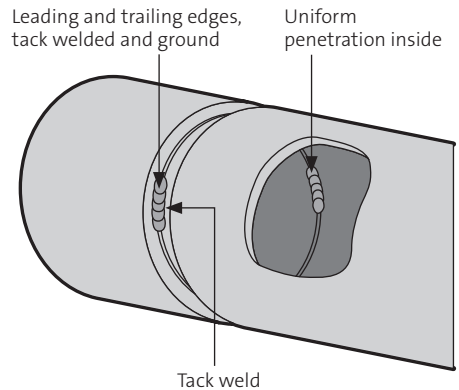

Root runs can be made by TIG or MIG/MAG with dip or pulse welding and the tube or pipe can be filled with a backing gas (see page 21) or backing strip.

Unbacked butt joint

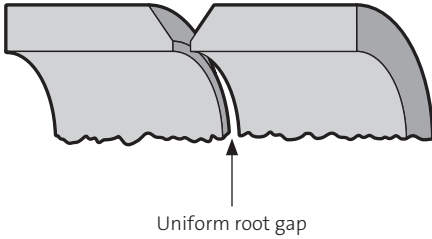

The edge preparation can be chosen in accordance with the guidance table on page 24.

Backed butt joint

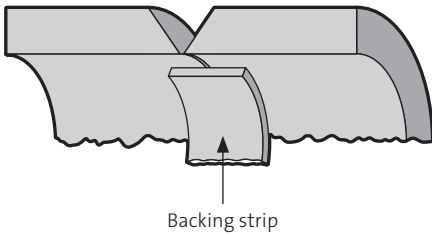

Flange joints are either fillet or butt welded.

Fillet

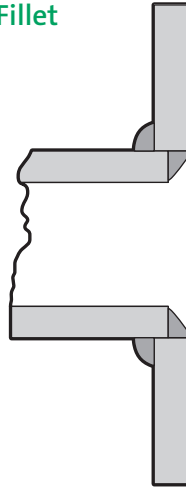

Butt

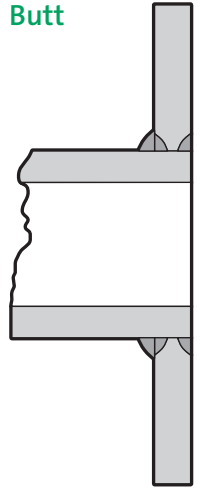

When welding flanges, for ease and productivity, the axis of the pipe should be vertical and the flange rotated.

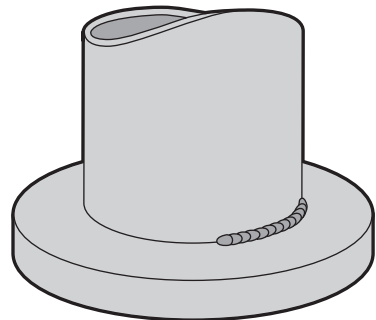

Flange rotated →

Defects in welds

Porosity

Porosity may be caused by:

- inadequate/incorrect weld process gas
- contamination of the weld preparation or consumables
- welding onto material which reacts or which contains dissolved gases
- incorrect welding parameters

Prevention methods:

- ensure satisfactory cleanliness of the workpiece. Remove contaminants such as grease, oil, moisture, rust, paint and dirt before welding
- eliminate contamination of the welding consumables
- ensure the correct selection and flowrate of your weld process gas
- eliminate draughts
- purchase materials from reputable suppliers
- use filler wire with sufficient deoxidants when welding steels
- ensure weld process gas delivery system is contamination and leak free



To avoid porosity, always select weld parameters that generate sufficient weld pool size and fluidity to ensure gases are not entrapped. This is particularly important when welding:

- Double-sided fillet welds
- Butt welds with depth to width ratios greater than 1

Lack of fusion/penetration

Causes:

This occurs when the arc fails to melt the base material. It can be caused by incorrect alignment of the arc with the joint or by the weld pool moving ahead of the arc.

This is a common problem when welding materials with a high thermal conductivity e.g. aluminium and copper.

Depending on the precise location in the welded joint, this fault is often characterised as follows:

- lack of side fusion
- lack of inter-run fusion
- lack of root fusion

Prevention methods:

- Maintain correct torch angle
- Adjust weld parameters to ensure the arc is directed onto the leading edge of the weld pool
- ensure joint faces are free of excessive mill scale
- modify the joint design
- ensure correct weld process gas selection

Undercut

Causes:

Base material is melted by the arc and an undercut is formed as a groove or dip in the parent material directly along the edges of the weld. It is often present as a shape discontinuity at the weld toe which only constitutes a defect if it exceeds the specification limits.

Prevention methods:

- reduce travel speed
- reduce arc voltage
- reduce welding current
- maintain correct torch angle
- ensure correct weld process gas selection

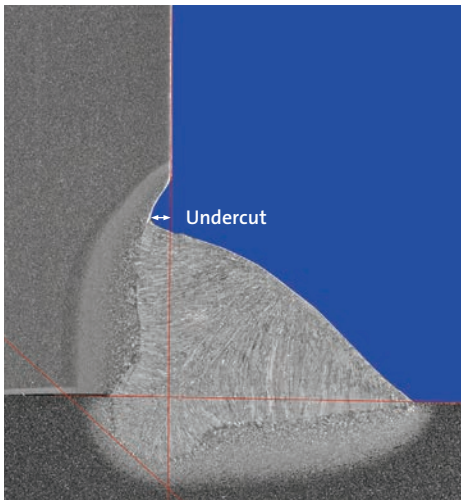

Spatter

Causes:

Spatter is caused by arc instabilities during metal transfer which cause molten metal droplets to be expelled from the arc.

Prevention methods:

- optimise welding parameters, paying particular attention to arc voltage
- ensure correct weld process gas is selected
- ensure welding equipment is in good working order
- ensure joint faces are clean and free of excessive mill scale and slag
- maintain correct torch angles (push technique)



Solidification cracks

Causes:

The liquid weld pool contracts as it solidifies to form a weld bead. Solidification starts from the outside of the weld pool and progresses towards the centerline. Solidification cracking occurs during the final stage of solidification when the liquid weld pool has insufficient strength to withstand the contraction stresses generated as the weld pool solidifies and contracts.

Prevention methods:

- **Weld pool composition –** impurities that encourage the formation of low melting point films such as sulphur and phosphorus should be minimised. Increased levels of manganese, silicon and nickel can help to reduce this risk.
- **Weld bead shape –**
 - use welding conditions which produce a depth to width ratio in the range of 0.5 - 0.8.
 - aim for a slightly convex weld cap.
 - avoid excessively wide root gaps.
 - use high performance weld process gas mixtures containing helium.
- **Welding speed –** excessive welding speeds which produce long weld pools, which may increase the risk of cracking.

Useful data for MIG/MAG welding

Optimum current ranges for solid steel wire

Wire diameter (mm)	Weld Current (A)	
	Min	Max
0.8	60	200
1.0	80	300
1.2	120	380
1.4	150	420
1.6	225	550
2.0	300	650

Weight per meter of wire

Wire diameter (mm)	Weight per meter of wire (g)	
	Carbon steel and stainless steels	Aluminium
0.8	3.9	1.35
1.0	5.6	2.08
1.2	8.7	3.01
1.4	11.9	4.11
1.6	15.5	5.36
2.0	24.2	8.37

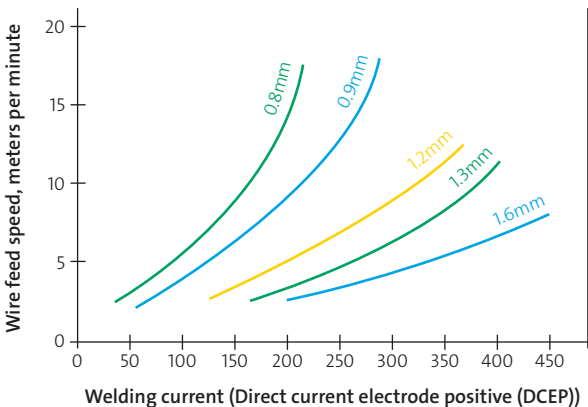

Typical conditions for MAG welding of carbon/carbon manganese steel (135)

The following tables summarise the weld procedure specification (WPS) and weld procedure qualification records (WPQRs) available for users of Air Products' Maxx® gases range. Permission to use these standard procedures under ISO 15612-1 can be obtained via your Air Products representative.

WPS - WPQR table; MAG welding (135)

Material: Carbon steel; s355J2; material group 1.2 acc. to ISO 15608

Wire; G42 4 M2 3Si1 - ISO EN 14341-A

Butt welds in flat PA position

Plate thickness (mm)	Wire diameter (mm)	Weld current (A)	Arc voltage (V)	Weld speed (cm/min)	Weld process gas
1	1.0	50 - 60	14.5 - 15.5	35 - 40	Ferromaxx® 7
2	1.0	105 - 115	16.5 - 17.5	30 - 35	Ferromaxx® 7
3	1.0	100 - 110	17 - 18	20 - 25	Ferromaxx® 7
12 (root)	1.0	100 - 110	17 - 19	12 - 14	Ferromaxx® 7 / Ferromaxx® 15
12 (layer 2-n)	1.0	250 - 270	29 - 31	30 - 35	Ferromaxx® 7 / Ferromaxx® 15

Fillet welds in the PB position

Plate thickness (mm)	Throat size (sl/ml) (mm)	Wire diameter (mm)	Weld current (A)	Arc voltage (V)	Weld speed (cm/min)	Weld process gas
1	2 (sl)	0.8	60 - 70	16 - 17	30 - 35	Ferromaxx® 7
6	4 (sl)	1.0	240 - 250	28 - 30	35 - 40	Ferromaxx® 7
10	5 (sl)	1.0	255 - 265	29 - 31	30 - 35	Ferromaxx® 7 / Ferromaxx® 15
10	5 (sl)	1.2	275 - 285	29 - 31	30 - 35	Ferromaxx® 7 / Ferromaxx® 15
10	7 (ml)	1.0	240 - 250	28 - 30	40 - 50	Ferromaxx® 7 / Ferromaxx® 15
10	7 (ml)	1.2	275 - 285	29 - 31	35 - 40	Ferromaxx® 7 / Ferromaxx® 15
30	15 (ml)	1.0	240 - 250	28 - 30	35 - 40	Ferromaxx® 7 / Ferromaxx® 15
30	15 (ml)	1.2	290 - 310	29 - 31	35 - 40	Ferromaxx® 7 / Ferromaxx® 15

Typical conditions for MIG/MAG welding with solid wire

Butt joints in the flat PA position

Carbon steel - Ferromaxx® Plus / Ferromaxx® 15

Run	Wire diameter (mm)	Weld current (A)	Arc voltage (V)	Wire feed speed (m/min)
Root	1	100 - 110	17 - 19	3.5 - 4.0
2 - n	1.2	290 - 310	29 - 31	9.5 - 10.5

Stainless steel - Inomaxx® Plus

Run	Wire diameter (mm)	Weld current (A)	Arc voltage (V)	Wire feed speed (m/min)
Root	1	100 - 110	17 - 19	3.5 - 4.0
2 - n (pulsed)	1	210 - 220	25 - 27	13 - 14

Aluminium - Alumaxx® Plus; bevel of total 90° - 110°, 1-2mm root face; no gap

Run	Wire diameter (mm)	Weld current (A)	Arc voltage (V)	Wire feed speed (m/min)
Root (pulsed)	1.2	230 - 240	24 - 25	14 - 15
2 - n (pulsed)	1.2	235 - 245	25 - 26	14 - 15

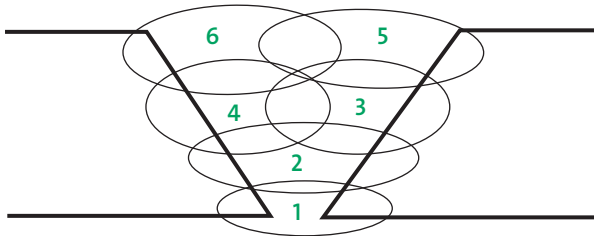

Fillet welds in PB position

Throat size (mm)	Wire diameter (mm)	Weld current (A)	Arc voltage (V)	Number of runs
5	1.2	275 - 285	29 - 31	1
7	1.2	275 - 285	29 - 31	3
15	1.2	290 - 310	29 - 31	10

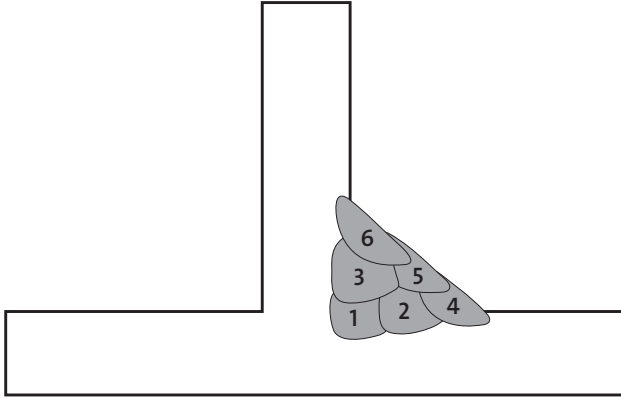

Butt and fillet welds in vertical PF position

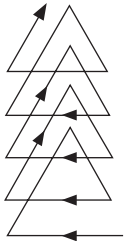

Use a
triangular
weave

Ensure fusion
in the root

Leg lengths (z)	Wire diameter (mm)	Weld current (A)	Arc voltage (V)	Number of runs
6	1.0	80 - 95	17 - 18	1
10	1.0	70 - 180	19 - 20	1
12 ⁽¹⁾	1.0	80 - 95	17 - 18	2
12 ⁽²⁾	1.0	70 - 180	19 - 20	2

A fillet weld's size is defined by throat thickness (a) or leg length (z).

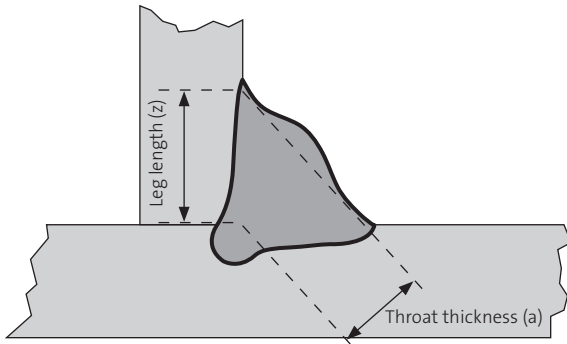

The ideal relation between throat thickness and leg length is given in the following formula and is shown in the table below -
 $z = \sqrt{2} * a$.

a-size (mm)	z-size (mm)	Weld surface (mm ²)
2	2.8	4.0
2.5	3.5	6.3
3	4.2	9.0
3.5	4.9	12.3
4	5.7	16.0
5	7.1	25.0
6	8.5	36.0

Typical welding conditions for all positional rutile cored wires (seamless) steel plate - Ferromaxx® 15 and Ferromaxx® Plus weld process gas; Gas flow 18-20 l/min.

Butt welds – PA position – 50-60° bevel preparation and gap up to 4mm and ceramic backing

Run	Wire diameter (mm)	Weld current (A)	Arc voltage (V)	Wire feed speed (m/min)
Root	1.2	220 - 240	22 - 24	7.5 - 8.0
2 - n	1.2	260 - 280	25 - 27	9.5 - 10.0

Butt welds – vertical up PF position 50-60° bevel preparation and gap up to 4mm

Run	Wire diameter (mm)	Weld current (A)	Arc voltage (V)	Wire feed speed (m/min)
Root	1.2	150 - 170	21 - 23	5.0 - 5.5
2 - n	1.2	210 - 230	24 - 26	7.5 - 8.0

Fillet welds – multi layer PB position

Run	Wire diameter (mm)	Weld current (A)	Arc voltage (V)	Wire feed speed (m/min)
Root	1.2	250 - 270	26 - 28	10.0 - 10.5
2 - n	1.2	230 - 250	25 - 27	9.5 - 10.0

Current ranges for MIG/MAG welding of steel with cored wire

Basic core flux

Wire diameter (mm)	Weld Current (A)	
	Min	Max
1.0	100	230
1.2	120	300
1.4	130	350
1.6	140	400
2.4	250	500

All positional rutile cored wire

Wire diameter (mm)	Weld Current (A)	
	Min	Max
1.2	150	350
1.4	150	350
1.6	150	450

Metal cored wire

Wire diameter (mm)	Weld Current (A)	
	Min	Max
1.2	100	360
1.4	150	380
1.6	150	450

Cored wire diameters above 2.4mm are not commonly used for manual welding.

Useful data for TIG welding

Typical conditions for TIG welding with non-pulsed welding machines

Butt welds (PA position)

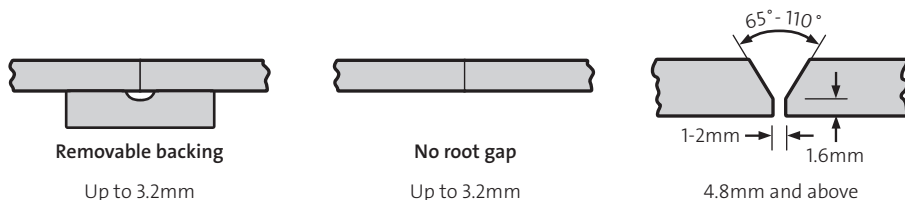

Metal thickness (mm)	Electrode diameter (mm)	Filler rod diameter (mm)	Weld current (A)	Shielding gas flow (l/min)
----------------------	-------------------------	--------------------------	------------------	----------------------------

Aluminium – alternating current – zirconiated electrode

1.6	2.4	1.6	60 - 80	6
3.2	3.2	2.4	125 - 145	7
4.8	4.0	3.2	180 - 220	10
6.0	4.8	4.8	235 - 275	12

Stainless steel – direct current – electrode negative – lanthanated electrode

1.6	1.6	1.6	60 - 70	5
3.2	2.4	2.4	70 - 95	6
4.8	2.4	3.2	100 - 120	7
6.0	3.2	4.0	135 - 160	8

Carbon steel – direct current – electrode negative – lanthanated electrode

1.6	1.6	1.6	60 - 70	5
3.2	2.4	2.4	75 - 95	6
4.8	2.4	3.2	110 - 130	7
6.0	3.2	4.8	155 - 175	8

Typical conditions for TIG welding with non-pulsed welding machines

Fillet welds (PB position)

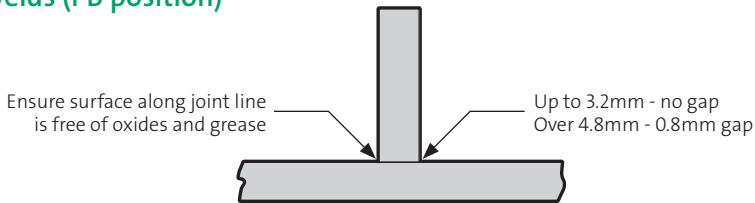

Metal thickness (mm)	Electrode diameter (mm)	Filler rod diameter (mm)	Weld current (A)	Weld process gas flow (l/min)
1.6	2.4	1.6	60 - 80	5
3.2	3.2	2.4	125 - 145	6
4.8	3.2 or 4.0	3.2	195 - 230	7
6.0	4.0 or 4.8	4.8	260 - 295	10

Aluminium – alternating current – zirconiated electrode

Stainless steel – direct current – electrode negative – lanthanated electrode

1.6	1.6	1.6	50 - 70	5
3.2	2.4	2.4	85 - 105	5
4.8	2.4	3.2	120 - 145	6
6.0	3.2	4.0	165 - 180	7

Carbon steel – direct current – electrode negative – lanthanated electrode

1.6	1.6	1.6	50 - 70	5
3.2	2.4	2.4	90 - 120	5
4.8	2.4	3.2	135 - 175	6
6.0	3.2	4.8	170 - 200	7

Oxy-fuel gas cutting

Oxygen, used with a fuel gas such as acetylene or propane can be used for many processes including cutting, brazing and heating. Only acetylene fuel gas is suitable for welding. Oxy-fuel is a portable, low-cost, versatile, safe and easy to use process but must only be used only by trained personnel.

When cutting, any fuel gas can be used with oxygen to cut ferrous metals. The process can easily be automated to enhance productivity and cut accuracy. Acetylene is the only commonly used fuel gas that can produce a variety of bevel edge preparations on plate, pipe and tube. All edge preparations require grinding of the cut surface prior to welding to remove the oxide layer.

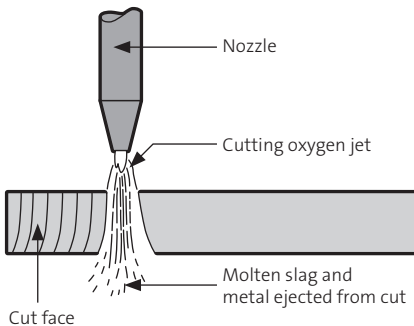
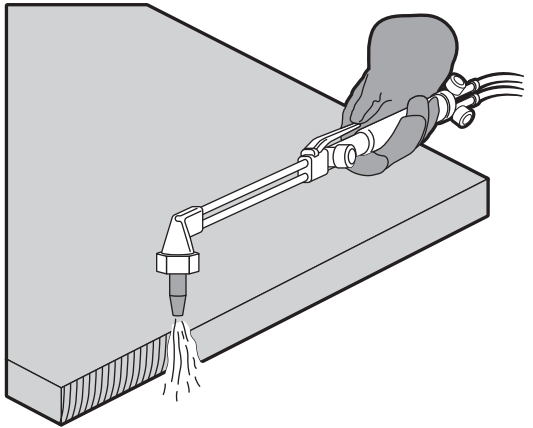

The cutting action depends on a chemical reaction between oxygen and the iron (Fe) in the steel. A preheat flame is used to raise the surface of the metal to the ignition temperature at which the reaction takes place. The heat from the reaction melts the metal which is blown from the cut by the oxygen jet.

Equipment

The essential equipment for cutting is detailed below:



It is critical that the safety equipment shown is installed, tested and regularly maintained in accordance with national standards. Visit: airproducts.co.uk/integrasafety airproducts.ie/integrasafety

Safe operating practices - oxy-fuel gas

Always...

- Secure cylinders in an upright position during storage, transportation and use.
- Use a suitable trolley when moving cylinders.
- Comply with safety requirements regarding the use of oxygen and acetylene cylinders and associated equipment.
- Wear all required personal protective equipment (PPE).
- If you need to transport an acetylene cylinder horizontally, ensure it is left to stand upright for 24 hours prior to use.
- Use an approved lighting up and shutting down procedure (see pages 46 and 47).

Assembly and initial set-up

- Ensure the correct equipment is selected
 - cylinder regulators shall not be more than 5 years from the manufacture date/last retest date.

- **Cylinder regulators shall only be used for their specified gas, e.g. do not use a propane regulator on acetylene, etc.**
- **Cylinder adaptors shall not be used.**

- Inspect the equipment thoroughly for damage and replace as required.
- Ensure all equipment is free from oil and grease.
- If using traditional cylinders, connect the...
 - cylinder regulator to the cylinder valve,
 - flashback arrestor to the regulator,
 - hose to the flashback arrestor.
- When using Integra® cylinders connect the...
 - integrated flashback arrestor and quick connector to the Integra® quick connect outlet,
 - hose to the flashback arrestor.

- Blue hose to oxygen fitting
- Red hose to fuel gas fitting

- Attach the non-return valve to each connection on the handle of the torch and attach the hoses to the non-return valves.
- Select and fit a nozzle suitable for the type of fuel gas and for the thickness of material you need to cut.
- Tighten all connections prior to pressurising the system.
- Open both cylinder valves.

Before attempting to light the torch, purge each hose separately to ensure that only oxygen or fuel gas is present in the appropriate hose.

Purging the system

- Turn the pressure adjusting screw clockwise on the oxygen regulator to set the outlet pressure required for the type of nozzle fitted. The correct outlet pressure information is normally supplied by the nozzle manufacturer.
- Open the oxygen valve on the torch. The pressure will fall slightly. Adjust the oxygen pressure shown on the regulator back to the correct level.
- Close the valve on the torch. You have also purged the oxygen hose.
- Repeat the above steps for the fuel gas cylinder.
- Leak test all joints with an approved oxygen-compatible leak-detection fluid prior to use.

This operation should take place in a well-ventilated space away from any source of ignition.

Never open both torch valves at the same time when purging the system.

It is essential that the system is purged after each period of prolonged non-use (see 'closing down' procedure on page 47).

Lighting up

- Use a spark lighter to ignite the flame. Matches or gas lighters shall not be used.



- First open the fuel gas (red) torch valve slowly and ignite the gas, increase to reduce smoke if necessary.
- Next open the oxygen (blue) torch valve slowly and adjust until a neutral flame is achieved.
- You are now ready to commence cutting.

In the unlikely event of a sustained back fire/flashback, you must turn the oxygen (blue) torch valve off first, followed by the fuel (red) torch valve and then carefully close both cylinder valves.

If using acetylene, carefully check the cylinder with bare hands to identify any heat spots. If localised heat is detected, treat the cylinder as if it has been in a fire, evacuate the area and then contact the emergency services advising them of a suspected acetylene fire incident.

Neutral flame

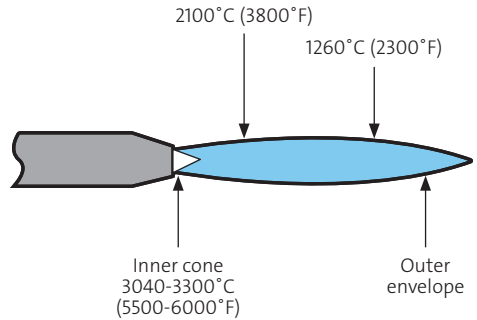

Oxidising flame

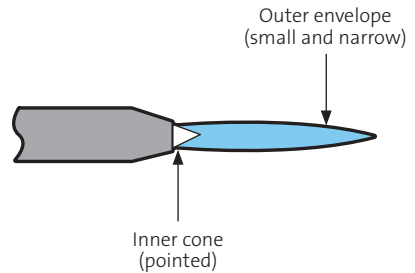

Carburising (reducing) flame

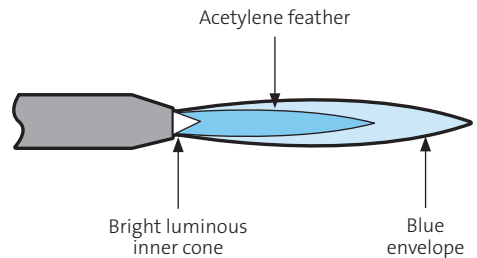

Shutting down

There are two scenarios for shutting down your system, (i) a **short term shut down**, e.g. when repositioning between cuts, etc. or (ii) **closing down** e.g. when stopping for a lunch break, at the end of a shift or to change a cylinder etc.

Short-term shut down:

- Close the fuel gas (red) torch valve.
- Close the oxygen (blue) torch valve.
- Stow the hoses in a safe manner and ensure the hot torch nozzle is not in contact with any part of the system, including the cylinders.

Closing down:

- Close the fuel gas (red) torch valve.
- Close the oxygen (blue) torch valve.
- Close the cylinder valve on both cylinders.
- Open the fuel gas (red) torch valve, vent the line and close the valve.
- Open the oxygen (blue) torch valve, vent the line and close the valve.

Never open both torch valves at the same time when venting the system.

- Now fully wind anti-clockwise the pressure adjusting screw on each cylinder regulator. All pressure regulators should now read zero.
- Stow the hoses in a safe manner and ensure the hot torch is not in contact with any part of the system, including the cylinders.

Oxygen and acetylene Integra[®] cylinder

Protective valve guard

Prevents accidental damage and makes the cylinder easy to handle. Independently safety tested. Exceeds the requirements of EN ISO 11117. Protects all critical components and provides full access for valve operation.

Contents gauge

Always shows how much gas is left, even when cylinder is not in use!

Built-in regulator

Calibrated and maintained by Air Products. Regulates outlet pressure and provides a variable pressure control. Suitable for all cutting, welding and brazing applications.

Filling point

Quick connect gas outlet

Allows safe and rapid gas cylinder change-over. Safety device in valve outlet ensures no gas flow if the quick connector is not fitted to the valve.

Quick connector with built-in safety

Ensures the safest connection every time the cylinder is used. Snap-on connection to cylinder – no spanner needed. Additional safety locking and release device prevents accidental removal.

Built in safety devices:

- Safety locking and release mechanism
- Flame arrestor
- Non-return valve
- Thermal cut-off valve
- Dust filter



Oxygen Integra[®] cylinder shown

Many fuel gases are available such as acetylene, ethylene, hydrogen, methane, propane, propylene and mixtures. Each gas has different characteristics and benefits. The most common ones are:

- Acetylene which is lighter than air. It is colourless and odourless in its pure state, however, commercial acetylene has a slightly garlic-like odour. It is also selected due to its versatility as it suitable for welding as well as cutting.
- Apachi® cutting gas; propylene liquid petroleum gas which is exclusively available from Air Products. It is heavier than air.
- Propane, a liquid petroleum gas, also heavier than air.

Fuel gas selection criteria

Factor for choice	Acetylene	Apachi	Propane
Time to start cut	•••	••	•
Cutting speed	•••	••	•

••• = best choice • = also suitable

The quality of a cut surface depends on a number of variables

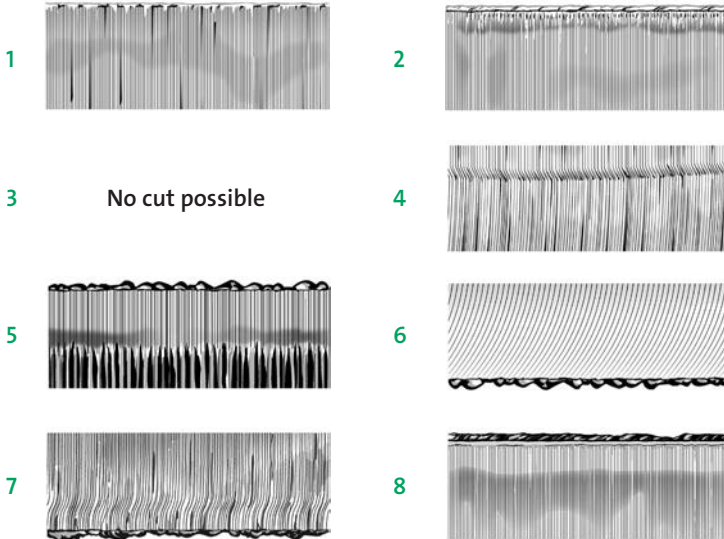

Variable	Condition	Effect
Nozzle-plate distance	1 too low	top edge rounded
	2 too high	undercutting
Cutting oxygen pressure	3 too low	(no cut possible)
	4 too high	irregular face; variable width
Cutting speed	5 too low	excessive melting; slag adheres to face
	6 too high	undercut; slag bridges bottom
Preheat flame	7 too small	cutting stops
	8 too big	top edge very rounded

Quality of cut

The aim is to produce a cut with:

- a uniform gap (kerf)
- clearly defined edges
- smooth faces
- no adhering slag

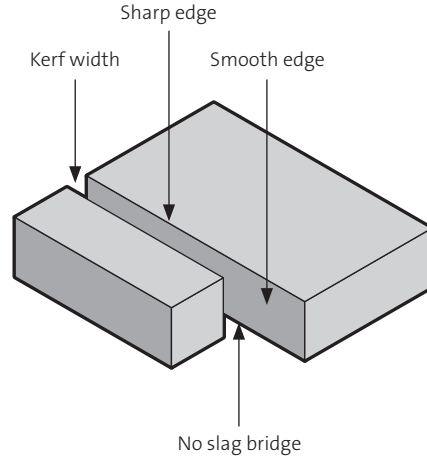

Operating techniques

Manual cutting is used across many industries including ship building and repair, recycling and automotive/machinery repair and maintenance.

It is difficult to achieve a uniform cut with manual techniques. Variations in travel speed and nozzle-to-plate distance give irregular cut faces.

Improved results can be obtained by using guides for straight lines and radius bars for circles.

With good quality cuts, both pieces should separate from each other cleanly.





Mechanised cutting produces a superior cut quality.

A variety of mechanised traversing systems are available.

Mechanised systems can be used to prepare the edges of plate prior to welding.

More than one cut can be made at the same time.

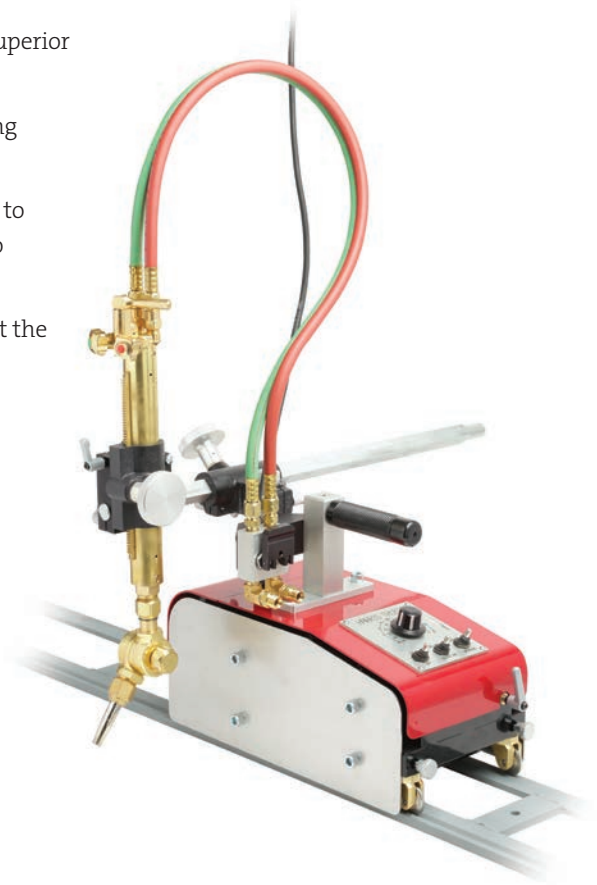

Typical operating conditions

Equal pressure/nozzle mix torches

Cutting

Nozzle size inches	Plate thickness mm	Acetylene pressure bar	Oxygen pressure bar
1/32	3.0 - 6.0	0.15	1.5 - 2.0
3/64	6.0 - 20.0	0.15	2.0 - 3.0
1/16	20.0 - 75.0	0.15 - 0.2	3.0 - 4.0

Welding and brazing

Nozzle size No	Plate thickness mm	Acetylene pressure bar	Oxygen pressure bar
1	0.9	0.15	0.15
2	1.2	0.15	0.15
3	2.0	0.15	0.15
5	2.6	0.15	0.15
7	3.2	0.15	0.15
10	4.0	0.2	0.2
13	5.0	0.3	0.3
18	6.5	0.3	0.3
25	8.0	0.4	0.4
35	10.0	0.6	0.6

For manual cutting, it is recommended to use nozzle mix torches as it significantly reduces the risk of a flash-back.

An injector torch is typically used when mechanised or machine cutting.

Injector torches

Cutting

Plate thickness inches	Acetylene pressure bar	Oxygen pressure bar
3.0 - 10.0	0.5	2.0 - 3.0
10.0 - 25.0	0.5	3.0 - 4.0
25.0 - 75.0	0.5	4.0 - 5.5

Welding and brazing

Plate thickness mm	Acetylene pressure bar	Oxygen pressure bar
0.5 - 1.0	0.2 - 0.25	2.5
1.0 - 2.0	0.2 - 0.25	2.5
2.0 - 4.0	0.2 - 0.25	2.5
3.0 - 5.0	0.2 - 0.25	2.5
4.0 - 6.0	0.2 - 0.25	2.5
6.0 - 9.0	0.2 - 0.25	2.5
9.0 - 14.0	0.2 - 0.25	2.5

* The information included in this document is for guidance only. Torch and/or nozzle manufacturers' recommendations should also be consulted. Please note that recommendations may vary between manufacturers.

For more information, please contact us at:

United Kingdom

Air Products PLC
T +44 0800 389 0202
apukinfo@airproducts.com
airproducts.co.uk

Ireland

Air Products Ireland Ltd.
T +353 1800 99 50 29
ieinfo@airproducts.com
airproducts.ie



tell me more
airproducts.co.uk/welding
airproducts.ie/welding

© Air Products and Chemicals, Inc., 2018

Ferromaxx®, Inomaxx®, Alumaxx®, Apachi+®
are registered trademarks of Air Products and Chemicals, Inc.

ISBN 9780955221903

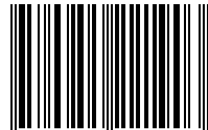

9 780955 221903

£13.00

