



Quality meets Innovation

Welding Elements Catalogue



2016 - Welding Elements Catalogue

**Welding Elements Catalogue
Issue 09/2016**

**Transmission and duplication of this document, dissemination and notification
of the contents are not permitted unless expressly approved.**

















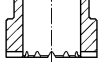

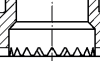

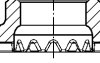
All rights, errors and technical amendments reserved.

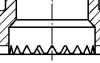
© HBS Bolzenschweiss-Systeme GmbH & Co. KG

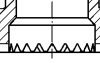
Table of Contents

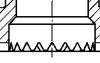
0	Welding Elements – Types and Symbols	5
1	CD – Capacitor Discharge stud welding	6
	Welding elements for capacitor discharge stud welding with tip ignition – Overview	6
	Technical data and information	8
	Threaded studs type PT	10
	Unthreaded studs (pins) type UT	14
	Studs with internal thread type IT	15
	CD Paint clearing threaded studs	18
	CD Fir tree studs	20
	Ground clips (single and double style)	21
	Silicone cover	22
2	ARC – Drawn arc stud welding	24
	Welding elements for drawn arc stud welding (with ceramic ferrule or shielding gas) – Overview	24
	Technical data and information	26
	Threaded studs with reduced shaft type RD (with ceramic ferrule)	28
	Threaded studs with reduced shaft type RD (with shielding gas)	31
	Virtually fully threaded studs type DD (with ceramic ferrule)	34
	Virtually fully threaded stud type DD (with shielding gas)	36
	Threaded studs type PD (with ceramic ferrule)	38
	Threaded studs type PD (with shielding gas)	39
	Unthreaded studs (pins) type UD (with ceramic ferrule)	40
	Unthreaded studs (pins) type UD (with shielding gas)	41
	Studs with internal thread type ID (with ceramic ferrule)	42
	Studs with internal thread type ID (with shielding gas)	43
	Shear connectors / Concrete anchors type SD	44
	Ceramic ferrules	45

3	SC – Short Cycle	46
	Welding elements for drawn arc stud welding	
	Short Cycle – Overview	46
	Technical data and information	48
	Threaded studs with flange type PS	50
	Unthreaded studs (pins) with flange type US	52
	Studs with internal thread and flange type IS	53
	SC Paint clearing threaded studs	54
	SC Fir tree studs	55
4	ISO – Insulation application	56
	Welding elements for insulation application – Overview	56
	Technical data and information	58
	ISO Cupped head pins	60
	CD ISO Nails	62
	ARC ISO Pins	64
	Clips / Nail protection caps	65
	Bimetallic insulation pins	67
5	MARC	68
	Welding elements for welding with magnetically positioned light arc – Overview	68
	Technical data and information	69
	MARC Welding nuts type Hex ^{Nut}	70
6	Welding elements for special applications – examples	71

Welding technique	Type of stud ¹⁾	Symbol for stud	Symbol for ceramic ferrule
Stud welding with tip ignition - CD	Threaded stud (pitch) ²⁾	 PT	—
	Unthreaded stud (pin) ²⁾	 UT	—
	Stud with internal thread ²⁾	 IT	—
	Ground clip single style	 F1	—
	Ground clip double style	 F2	—
Drawn arc stud welding with ceramic ferrule or shielding gas - ARC	Threaded stud with reduced shaft ²⁾	 RD	 RF
	Virtually fully threaded stud	 DD (MD)	 UF (MF)
	Partially threaded stud (pitch) ²⁾	 PD	 PF
	Unthreaded stud (pin) ²⁾	 UD	 UF
	Stud with internal thread ²⁾	 ID	 UF
	Shear connector ²⁾	 SD	 UF/DF
Short cycle drawn arc stud welding - SC	Threaded stud with flange (pitch) ²⁾	 PS	—
	Unthreaded stud (pin) with flange ²⁾	 US	—
	Stud with internal thread and flange ²⁾	 IS	—

¹⁾ Further types of stud and ceramic ferrules can be specified as required for special applications.

²⁾ according to standard DIN EN ISO 13918

1

Welding process:

Capacitor discharge stud welding with tip ignition (CD)

	<p>Welding elements type PT Threaded studs</p> <p>Name for a metric threaded stud according to DIN EN ISO 13918</p> <div style="display: flex; justify-content: space-around; align-items: flex-end;"> <div style="text-align: center;">  4.8 copper plated from page 10 </div> <div style="text-align: center;">  A2-50 from page 11 </div> <div style="text-align: center;">  CuZn37 from page 12 </div> <div style="text-align: center;">  AlMg3 from page 13 </div> </div>
	<p>Welding elements type UT Unthreaded studs (pins)</p> <p>Name for a pin according to DIN EN ISO 13918</p> <div style="display: flex; justify-content: space-around; align-items: flex-end;"> <div style="text-align: center;">  4.8 copper plated from page 14 </div> <div style="text-align: center;">  A2-50 from page 14 </div> <div style="text-align: center;">  CuZn37 from page 14 </div> <div style="text-align: center;">  AlMg3 from page 14 </div> </div>
	<p>Welding elements type IT Studs with internal thread</p> <p>Name for a stud with internal thread according to DIN EN ISO 13918</p> <div style="display: flex; justify-content: space-around; align-items: flex-end;"> <div style="text-align: center;">  4.8 copper plated from page 15 </div> <div style="text-align: center;">  A2-50 from page 16 </div> <div style="text-align: center;">  AlMg3 from page 17 </div> </div>
	<p>CD Paint clearing threaded studs</p> <p>Name for a metric threaded stud with transverse grooves</p> <p>The welding geometry is designed similar to DIN EN ISO 13918.</p> <p>Especially suitable for subsequent painting/coating.</p> <div style="display: flex; justify-content: space-around; align-items: flex-end;"> <div style="text-align: center;">  4.8 copper plated from page 18 </div> <div style="text-align: center;">  CuZn37 from page 19 </div> </div>



Welding process:

Capacitor discharge stud welding with tip ignition (CD)

	<p>CD Fir tree studs</p> <p>Name for a threaded stud, also referred to as a saw tooth stud or coarse threaded stud. Fir tree studs have a special thread with a defined pitch (P) of 1.6 mm.</p> <p>The welding geometry is designed similar to DIN EN ISO 13918.</p> <p>Especially suitable for the quick installation of snap-on elements such as plastic nuts or cable mountings.</p> <div style="display: flex; justify-content: space-around; align-items: flex-end;"> <div style="text-align: center;">  <p>4.8 copper plated from page 20</p> </div> <div style="text-align: center;">  <p>A2-50 from page 20</p> </div> </div>
	<p>Ground clips, single style (F1) and double style (F2)</p> <p>Ground clips are also referred to as earthing connections.</p> <p>The welding geometry is designed similar to DIN EN ISO 13918.</p> <div style="display: flex; justify-content: space-around; align-items: flex-end;"> <div style="text-align: center;">  <p>4.8 copper plated from page 21</p> </div> <div style="text-align: center;">  <p>A2-50 from page 21</p> </div> <div style="text-align: center;">  <p>CuZn37 from page 21</p> </div> <div style="text-align: center;">  <p>AlMg3 from page 21</p> </div> </div>
	<p>Silicone caps</p> <p>Silicone caps protect the mechanically important areas of welding elements during painting and powder coating as well as during the baking process.</p> <p>from page 22</p>



1

Stud types, abbreviations, material, norm, mechanical characteristics according to DIN EN ISO 13918

Stud types		Abbreviations for studs	Material	Norm	Mechanical characteristics: tensile strength R_m 0,2 % yield strength $R_{p0,2}$
Stud welding with capacitor discharge (TS)	Threaded stud	PT	Steel 4.8 ¹⁾ copper plated (C1E)	ISO 898-1	$R_m \geq 420 \text{ N/mm}^2$
			A2-50	ISO 3506-1	$R_m \geq 500 \text{ N/mm}^2$ $R_{p0,2} \geq 210 \text{ N/mm}^2$
	Unthreaded stud (Pin)	UT	A2-50	ISO 3506-1	$R_m \geq 500 \text{ N/mm}^2$ $R_{p0,2} \geq 210 \text{ N/mm}^2$
			CuZn37	EN 12166	$R_m \geq 370 \text{ N/mm}^2$
	Stud with internal thread	IT	CuZn37	EN 12166	$R_m \geq 370 \text{ N/mm}^2$
			EN AW-Al99,5	EN 573-3	$R_m \geq 100 \text{ N/mm}^2$
		EN AW-AlMg3	EN 1301-2	$R_m \geq 230 \text{ N/mm}^2$	

Further material upon request

¹⁾ suitable for welding

Prestress at installation (tie load) and torque

Threaded stud	Steel 4.8 ¹⁾ $\mu = 0.18$ $R_{p0,2} = 340 \text{ N/mm}^2$		A2-50 $\mu = 0.18$ $R_{p0,2} = 210 \text{ N/mm}^2$		AlMg3 (F23) $\mu = 0.18$ $R_{p0,2} = 170 \text{ N/mm}^2$		CuZn37 $\mu = 0.18$ $R_{p0,2} = 250 \text{ N/mm}^2$	
	Prestress at installation (kN)	Torque (Nm)	Prestress at installation (kN)	Torque (Nm)	Prestress at installation (kN)	Torque (Nm)	Prestress at installation (kN)	Torque (Nm)
M3	1.1	0.8	0.7	0.5	0.5	0.4	0.8	0.6
M4	1.8	1.8	1.1	1.1	1.0	0.9	1.4	1.3
M5	3.0	3.6	1.9	2.3	1.6	1.9	2.3	2.7
M6	4.3	6.1	2.7	3.8	2.2	3.1	3.2	4.5
M8	8.0	15.0	4.9	9.5	4.0	7.5	6.0	11.0

Values correspond with DVS leaflet 0904 (September 2004)

¹⁾ suitable for welding

All given values are leads for minimum tensile strength and minimum torque of a weld without permanent deformation of parts to be joined. Parts to be joined must have sufficient wall thickness. Values apply for cold rolled threaded studs with standard thread without surface protection and without thread lubrication. Throughout the entire stud length, at least the stressed cross section must be present. Values apply for indicated yield strengths.

Material combinations

according to DIN EN ISO 14555

(Select stud material in a way that material of the same kind is welded)

Stud material	base material				
	ISO/TR 15608 Groups 1 to 6, 11.1	ISO/TR 15608 groups 1 to 6, 11.1 and galvanized and metal plated steel sheets, max. coating thickness 25 µm	ISO/TR 15608 Groups 8	Copper and unleaded copper alloys, e.g. CuZn37 (CW508L)	ISO/TR 15608 Groups 21 and 22
Steel 4.8 ¹⁾	a	b	a	b	--
A2-50	a	b	a	b	--
CuZn37	b	b	b	a	--
EN AW-Al99.5	--	--	--	--	b
EN AW-AlMg3	--	--	--	--	a

Exemplification of welding suitability:
 -- non weldable
 a well suited for any application, e. g. power transmission
 b suitable, limitations with power transmission

Weldability tests of other material combinations upon request.

¹⁾ suitable for welding

Stud Flange

The stud flange is designed according to DIN EN ISO 13918. The flange is part of the welding stud. Its diameter is bigger than the diameter of the stud. During welding, it prevents the arc from burning to the cylindrical part of the stud and increases the welding area simultaneously. This results in higher strength of the welded joint. The flange also serves to automatic feeding using HBS stud feeding units. Depending on requirements, you can use welding studs which have different flange dimensions or even no flange.

Threads

Non coated threaded studs are provided with a thread to DIN ISO 724, DIN EN ISO 4759-1, product class A, tolerance zone 6g. Galvanized threaded studs correspond with DIN EN ISO 4042, tolerance zone 6h.

Cold rolling of thread shows the following advantages:

- no interruption of fiber orientation,
- increase of strength by up to 200 %,
- decrease of surface roughness in connection with
- increased corrosion resistance.

Surface Treatment

Studs, pins, and studs with internal thread (PT, UT, IT) made of steel (4.8) are normally protected against corrosion through a galvanized copper coating (C1E). Layer thickness is between 3 and 5 µm.

Quality level

HBS welding studs are supplied according to DIN EN ISO 3269 with quality level (AQL) 1.5.

Order key for welding elements

00-00-000
 | | | |
 | | | | Length
 | | | | Outer Ø
 | | | | Internal Ø (Thread)
 | | | | Material
 | | | | Stud type

Stud type	
1	Threaded stud
2	Pin
3	Stud with internal thread, Grounding clip, Silicon cove

Material	
1	Steel, 4.8 copper plated
2	1.4301/03 (A2-50)
3	CuZn37
4	AlMg3 (EN AW AlMg3)

Order examples: Threaded stud M4 x 20, material steel 4.8 copper coated
 Stud with internal thread Ø 5 x 12 M3, material (A2-50)

Order No. 11-04-020
Order No. 32-35-012

Excess/minor deliveries

With respect to articles made as per sample or drawing and requiring special manufacture production-related excess/short deliveries of up to 10 % have to be accepted as delivery according to contract. Exceptions need to be noted explicitly in the order and to be confirmed in writing.

Tolerances

As long as no tolerances are specified for dimensions, form and position HBS welding studs are supplied according to DIN EN ISO 4759-1, product class A.

Storage

We recommend to store the welding studs factory-packed. That's how you can avoid irregular welding results caused by humidity (oxidation), dirt etc.

With aluminium welding studs, the thickness of the oxide layer of the surface can be reduced to a minimum value using the recommended storage procedure.

Due to its corrosion properties, we recommend quick processing.

Please avoid mixing different batches.

Ordering

You make order processing a lot easier if you indicate the order numbers which are part of the price lists.

Welding elements with particular specifications available on request

1



Threaded studs type PT

	Type	Material	Suitable for stud feeding	
	PT Threaded studs	Steel 4.8 copper plated (suitable for welding)	Manual e.g. 	Automation ¹⁾ e.g. 

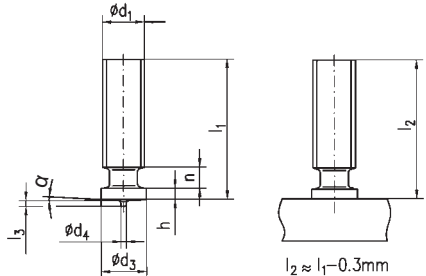
d_1	l_1	$d_3 \pm 0.2$	$d_4 \pm 0.08$	$l_3 \pm 0.05$	h	n_{max}	$\alpha \pm 1^\circ$	
M3	see table	4.50	0.60	0.55	0.70 - 1.40	0.60	3°	
M4		5.50	0.65	0.55				
M5		6.50	0.75	0.80				
M6		7.50	0.75	0.80	0.80 - 1.40	1.00		
M8		9.00	0.75	0.85	1.20 - 1.80	1.50		
M10 ²⁾		10.70	0.80	0.85				

Length	Diameter					
	M3	M4	M5	M6	M8	M10
	Order No.	Order No.	Order No.	Order No.	Order No.	Order No.
6 mm	11-03-006	11-04-006	--	--	--	--
8 mm	11-03-008	11-04-008	11-05-008	11-06-008	--	--
10 mm	11-03-010	11-04-010	11-05-010	11-06-010	11-08-010	--
12 mm	11-03-012	11-04-012	11-05-012	11-06-012	11-08-012	--
15 mm	11-03-015	11-04-015	11-05-015	11-06-015	11-08-015	--
16 mm	11-03-016	11-04-016	11-05-016	11-06-016	11-08-016	--
20 mm	11-03-020	11-04-020	11-05-020	11-06-020	11-08-020	11-10-020*
25 mm	11-03-025	11-04-025	11-05-025	11-06-025	11-08-025	11-10-025*
30 mm	11-03-030	11-04-030	11-05-030	11-06-030	11-08-030	11-10-030*
35 mm	--	11-04-035	11-05-035	11-06-035	11-08-035	--
40 mm	--	11-04-040	11-05-040	11-06-040	11-08-040	11-10-040*
45 mm	--	--	--	11-06-045	11-08-045	--

Chuck	82-50-003	82-50-004	82-50-005	82-50-006	82-50-008	82-50-009
						 <small>(Distance ring 92-40-010 or leg assembly 92-40-043 necessary)</small>
Chuck	84-50-003	84-50-004	84-50-005	84-50-006	84-50-008	--
						

Further accessories see accessories catalogue



* Minimum order quantity, delivery time and price upon request.

Custom dimensions are not listed in the table – HBS manufactures customised welding elements. On request we can provide pricing.

1) For automation: Diameter: M3 to M8 (M10 with modification only)
Stud length: 8 to 40 mm (other lengths on request)

2) Similar to DIN EN ISO 13918

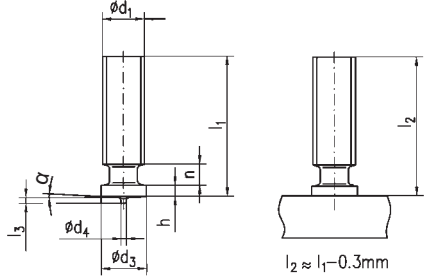

		Type			Material			Suitable for stud feeding	
								Manual	Automation ¹⁾
		PT Threaded studs			A2-50			e.g. 	e.g. 
d ₁	l ₁	d ₃ ±0.2	d ₄ ±0.08	l ₃ ±0.05	h	n _{max}	α ±1°		
M3	see table	4.50	0.60	0.55	0.70 - 1.40	0.60	3°		
M4		5.50	0.65	0.55					
M5		6.50	0.75	0.80					
M6		7.50	0.75	0.80					
M8		9.00	0.75	0.85	0.80 - 1.40	1.50			
M10 ²⁾	10.70	0.80	0.85	1.20 - 1.80					

Length	Diameter					
	M3	M4	M5	M6	M8	M10
	Order No.	Order No.	Order No.	Order No.	Order No.	Order No.
6 mm	12-03-006	12-04-006	--	--	--	--
8 mm	12-03-008	12-04-008	12-05-008	12-06-008	--	--
10 mm	12-03-010	12-04-010	12-05-010	12-06-010	12-08-010	--
12 mm	12-03-012	12-04-012	12-05-012	12-06-012	12-08-012	--
15 mm	12-03-015	12-04-015	12-05-015	12-06-015	12-08-015	--
16 mm	12-03-016	12-04-016	12-05-016	12-06-016	12-08-016	--
20 mm	12-03-020	12-04-020	12-05-020	12-06-020	12-08-020	12-10-020*
25 mm	12-03-025	12-04-025	12-05-025	12-06-025	12-08-025	12-10-025*
30 mm	12-03-030	12-04-030	12-05-030	12-06-030	12-08-030	12-10-030*
35 mm	12-03-035	12-04-035	12-05-035	12-06-035	12-08-035	12-10-035*
40 mm	--	12-04-040	12-05-040	12-06-040	12-08-040	12-10-040*
45 mm	--	12-04-045	--	12-06-045	12-08-045	--
50 mm	--	--	--	12-06-050	12-08-050	12-10-050*
55 mm	--	--	--	12-06-055	12-08-055	--

Chuck	82-50-003	82-50-004	82-50-005	82-50-006	82-50-008	82-50-009
						 <small>(Distance ring 92-40-010 or leg assembly 92-40-043 necessary)</small>
Chuck	84-50-003	84-50-004	84-50-005	84-50-006	84-50-008	--
						

Further accessories see accessories catalogue

* Minimum order quantity, delivery time and price upon request.



Custom dimensions are not listed in the table – HBS manufactures customised welding elements. On request we can provide pricing.

- For automation: Diameter: M3 to M8 (M10 with modification only)
Stud length: 8 to 40 mm (other lengths on request)
- Similar to DIN EN ISO 13918

1



Threaded studs type PT

	Type	Material	Suitable for stud feeding	
	PT Threaded studs	CuZn37 (CW 508L)³⁾	Manual e.g. 	Automation ¹⁾ e.g. 

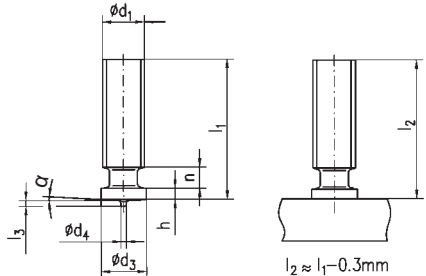
d_1	l_1	$d_3 \pm 0.2$	$d_4 \pm 0.08$	$l_3 \pm 0.05$	h	n_{max}	$\alpha \pm 1^\circ$	
M3	see table	4.50	0.60	0.55	0.70 - 1.40	0.60	3°	
M4		5.50	0.65	0.55				
M5		6.50	0.75	0.80				
M6		7.50	0.75	0.80	0.80 - 1.40	1.00		
M8		9.00	0.75	0.85	1.20 - 1.80	1.50		
M10 ²⁾		10.70	0.80	0.85				

Length	Diameter					
	M3	M4	M5	M6	M8	M10
	Order No.	Order No.	Order No.	Order No.	Order No.	Order No.
6 mm	13-03-006*	13-04-006*	--	--	--	--
8 mm	13-03-008	13-04-008	13-05-008*	13-06-008*	--	--
10 mm	13-03-010	13-04-010	13-05-010*	13-06-010*	--	--
12 mm	13-03-012	13-04-012	13-05-012*	13-06-012*	--	--
15 mm	13-03-015	13-04-015*	13-05-015*	13-06-015*	--	--
16 mm	13-03-016	13-04-016*	13-05-016*	13-06-016*	--	--
20 mm	13-03-020	13-04-020*	13-05-020*	13-06-020*	--	--
25 mm	13-03-025	13-04-025*	13-05-025*	13-06-025*	--	--
30 mm	13-03-030	13-04-030*	13-05-030*	13-06-030*	--	--
35 mm	--	13-04-035*	13-05-035*	13-06-035*	--	--
40 mm	--	13-04-040*	13-05-040*	13-06-040*	--	--
45 mm	--	--	--	13-06-045*	--	--
50 mm	--	--	--	13-06-050*	--	--

Chuck	82-50-003	82-50-004	82-50-005	82-50-006	82-50-008	82-50-009
						 (Distance ring 92-40-010 or leg assembly 92-40-043 necessary)
Chuck	84-50-003	84-50-004	84-50-005	84-50-006	84-50-008	--
						



Further accessories see accessories catalogue

* Minimum order quantity, delivery time and price upon request.

Custom dimensions are not listed in the table – HBS manufactures customised welding elements. On request we can provide pricing.

- For automation: Diameter: M3 to M8 (M10 with modification only)
Stud length: 8 to 40 mm (other lengths on request)
- Similar to DIN EN ISO 13918
- Due to the process and material properties a maximum stud diameter of M8 is recommended.

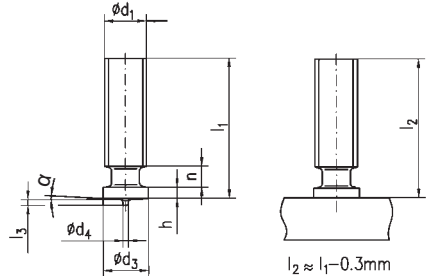

		Type			Material			Suitable for stud feeding	
								Manual	Automation ¹⁾
		PT Threaded studs			AlMg3 (EN AW AlMg3) ³⁾			e.g. 	e.g. 
d ₁	l ₁	d ₃ ±0.2	d ₄ ±0.08	l ₃ ±0.05	h	n _{max}	α ±1°		
M3	see tabel	4.50	0.60	0.55	0.70 - 1.40	0.60	3°		
M4		5.50	0.65	0.55					
M5		6.50	0.75	0.80					
M6		7.50	0.75	0.80	0.80 - 1.40	1.00			
M8		9.00	0.75	0.85					
M10 ²⁾		10.70	0.80	0.85	1.20 - 1.80	1.50			

Length	Diameter					
	M3	M4	M5	M6	M8	M10
	Order No.	Order No.	Order No.	Order No.	Order No.	Order No.
6 mm	14-03-006*	14-04-006	--	--	--	--
8 mm	14-03-008	14-04-008	14-05-008	14-06-008*	--	--
10 mm	14-03-010*	14-04-010	14-05-010	14-06-010	--	--
12 mm	14-03-012*	14-04-012	14-05-012	14-06-012	--	--
15 mm	14-03-015	14-04-015	14-05-015	14-06-015	--	--
16 mm	14-03-016*	14-04-016	14-05-016	14-06-016	--	--
20 mm	14-03-020*	14-04-020	14-05-020	14-06-020	--	--
25 mm	14-03-025	14-04-025*	14-05-025	14-06-025	--	--
30 mm	14-03-030*	14-04-030	14-05-030*	14-06-030	--	--
35 mm	--	14-04-035*	14-05-035*	14-06-035*	--	--
40 mm	--	14-04-040	14-05-040*	14-06-040*	--	--
45 mm	--	--	--	14-06-045*	--	--
50 mm	--	--	--	14-06-050*	--	--

Chuck	82-50-003	82-50-004	82-50-005	82-50-006	82-50-008	82-50-009
						 (Distance ring 92-40-010 or leg assembly 92-40-043 necessary)
Chuck	84-50-003	84-50-004	84-50-005	84-50-006	84-50-008	--
						

Further accessories see accessories catalogue

* Minimum order quantity, delivery time and price upon request.

Custom dimensions are not listed in the table – HBS manufactures customised welding elements. On request we can provide pricing.

- 1) For automation: Diameter: M3 to M8 (M10 with modification only)
Stud length: 8 to 40 mm (other lengths on request)
- 2) Similar to DIN EN ISO 13918
- 3) Due to the process and material properties a maximum stud diameter of M8 is recommended.

1



Unthreaded studs (pins) type UT

	Type	Material	Suitable for stud feeding	
			Manual	Automation ¹⁾
	UT Unthreaded studs (pins)*	Steel 4.8 copper plated (suitable for welding) A2-50, CuZn37, AlMg3		

d_1 ± 0.1	l_1	d_3 ± 0.2	d_4 ± 0.08	l_3 ± 0.05	h	α $\pm 1^\circ$	
3	see table	4.50	0.60	0.55	0.70 - 1.40	3°	
4		5.50	0.65				
5		6.50	0.75	0.80			
6		7.50					
7.1		9					

Material	Diameter				
	Ø 3 mm	Ø 4 mm	Ø 5 mm	Ø 6 mm	Ø 7.1 mm
	Order No.	Order No.	Order No.	Order No.	Order No.
Steel 4.8 copper plated (suitable for welding)	21-03-XXX	21-04-XXX	21-05-XXX	21-06-XXX	21-07-XXX
A2-50	22-03-XXX	22-04-XXX	22-05-XXX	22-06-XXX	22-07-XXX
CuZn37	23-03-XXX	23-04-XXX	23-05-XXX	23-06-XXX	--
AlMg3	24-03-XXX	24-04-XXX	24-05-XXX	24-06-XXX	--

Chuck	82-50-003	82-50-004	82-50-005	82-50-006	82-50-071
Chuck	84-50-003	84-50-004	84-50-005	84-50-006	84-50-071

Further accessories see accessories catalogue

* Not in stock, minimum order quantity, delivery time and price upon request. Please send us the article number with your request. In the article number "XXX" is to be replaced by the respective length (e.g. 025 for 25 mm).

Custom dimensions are not listed in the table – HBS manufactures customised welding elements. On request we can provide pricing.

1) For automation: Diameter: 3 to 7.1 mm
Stud length: 8 to 40 mm (other lengths on request)



		Type	Material						Suitable for stud feeding						
									Manual	Automation ¹⁾					
		IT Studs with internal thread	Steel 4.8 copper plated (suitable for welding)						e.g. 	e.g. 					
d_1 ± 0.1	d_2								l_1	b $+0.2$	d_3 ± 0.2	d_4 ± 0.08	l_3	h	α $\pm 1^\circ$
5	M3								see table	5.00	6.50	0,75	0.80	0.70-1.40	3°
6 ²⁾	M3 ²⁾									6.00	7.50		0.80		
6	M4	6.00	7.50	0.80											
7.1	M5	7.50	9.00	0.85	0.80-1.40										

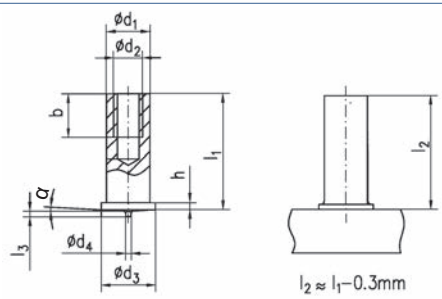

Length	Diameter			
	M3 / Ø 5 mm	M3 / Ø 6 mm	M4 / Ø 6 mm	M5 / Ø 7.1 mm
	Order No.	Order No.	Order No.	Order No.
8 mm	31-35-008	31-36-008*	31-46-008	--
10 mm	31-35-010	31-36-010*	31-46-010	31-57-010
12 mm	31-35-012	31-36-012*	31-46-012	31-57-012
15 mm	31-35-015*	31-36-015*	31-46-015	31-57-015
16 mm	31-35-016*	31-36-016*	31-46-016	31-57-016*
20 mm	31-35-020*	31-36-020*	31-46-020*	31-57-020
25 mm	31-35-025*	31-36-025*	31-46-025*	31-57-025
30 mm	31-35-030*	31-36-030*	31-46-030*	31-57-030
35 mm	--	--	31-46-035*	--

Chuck	82-50-905	82-50-906	82-50-906	82-50-971
Chuck	84-50-005	84-50-006	84-50-006	84-50-071

Further accessories see accessories catalogue

* Minimum order quantity, delivery time and price upon request.

Custom dimensions are not listed in the table – HBS manufactures customised welding elements. On request we can provide pricing.

1) For automation: Diameter: 5 to 7.1 mm
Stud length: 8 to 40 mm (other lengths on request)

2) Similar to DIN EN ISO 13918

1



Studs with internal thread type IT

	Type IT Studs with internal thread	Material A2-50	Suitable for stud feeding	
			Manual e.g.	Automation ¹⁾ e.g.

d_1 ± 0.1	d_2	l_1	b $+0.2$	d_3 ± 0.2	d_4 ± 0.08	l_3	h	α $\pm 1^\circ$	
5	M3	see table	5.00	6.50	0.75	0.80	0.70-1.40	3°	
6 ²⁾	M3 ²⁾		6.00	7.50		0.80			
6	M4		6.00	7.50		0.80			
7.1	M5		7.50	9.00		0.85	0.80-1.40		

	Diameter			
	M3 / Ø 5 mm	M3 / Ø 6 mm	M4 / Ø 6 mm	M5 / Ø 7.1 mm
	Order No.	Order No.	Order No.	Order No.
Length				
6 mm	32-35-006	--	--	--
8 mm	32-35-008	32-36-008*	32-46-008	--
10 mm	32-35-010	32-36-010*	32-46-010	32-57-010
12 mm	32-35-012	32-36-012*	32-46-012	32-57-012
15 mm	32-35-015*	32-36-015*	32-46-015	32-57-015
16 mm	32-35-016*	32-36-016*	32-46-016	32-57-016*
20 mm	32-35-020	32-36-020*	32-46-020	32-57-020
25 mm	32-35-025*	--	32-46-025*	32-57-025*
30 mm	32-35-030*	--	32-46-030*	32-57-030*
35 mm	--	--	32-46-035*	--
Chuck	82-50-905	82-50-906	82-50-906	82-50-971
Chuck	84-50-005	84-50-006	84-50-006	84-50-071

Further accessories see accessories catalogue

* Minimum order quantity, delivery time and price upon request.

Custom dimensions are not listed in the table – HBS manufactures customised welding elements. On request we can provide pricing.

1) For automation: Diameter: 5 to 7.1 mm
Stud length: 8 to 40 mm (other lengths on request)

2) Similar to DIN EN ISO 13918



		Type	Material	Suitable for stud feeding							
				Manual	Automation ¹⁾						
		IT Studs with internal thread	AlMg3 (EN AW AlMg3)	e.g.	e.g.						
d_1 ± 0.1	d_2	see table	b $+0.2$	d_3 ± 0.2	d_4 ± 0.08	l_3	h	α $\pm 1^\circ$			
5	M3		5.00	6.50						0.80	0.70-1.40
6 ²⁾	M3 ²⁾		6.00	7.50						0.80	
6	M4		6.00	7.50						0.80	
7.1	M5	7.50	9.00	0.85	0.80-1.40	$l_2 \approx l_1 - 0.3\text{mm}$					

Length	Diameter		
	M3 / Ø 5 mm	M3 / Ø 6 mm	M4 / Ø 6 mm
	Order No.	Order No.	Order No.
6 mm	34-35-006*	--	--
8 mm	34-35-008	34-36-008*	34-46-008*
10 mm	34-35-010	34-36-010*	34-46-010*
12 mm	34-35-012	--	34-46-012*
15 mm	34-35-015*	--	34-46-015*
16 mm	34-35-016*	--	34-46-016*
20 mm	34-35-020*	34-36-020*	34-46-020*
25 mm	34-35-025*	--	34-46-025*
30 mm	34-35-030*	--	34-46-030*
35 mm	--	--	34-46-035*

Chuck	82-50-905	82-50-906	82-50-906
Chuck	84-50-005	84-50-006	84-50-006

Further accessories see accessories catalogue

* Minimum order quantity, delivery time and price upon request.



Custom dimensions are not listed in the table – HBS manufactures customised welding elements. On request we can provide pricing.







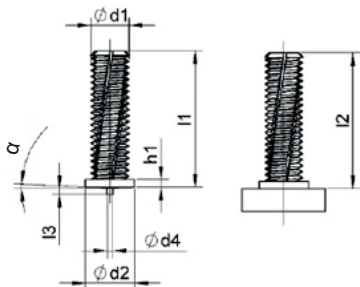

- 1) For automation: Diameter: 5 to 7.1 mm
Stud length: 8 to 40 mm (other lengths on request)
- 2) Similar to DIN EN ISO 13918

1



CD Paint clearing threaded studs

		Type		Material		Suitable for stud feeding	
						Manual	Automation ¹⁾
		CD Paint clearing threaded studs ²⁾		Steel 4.8 copper plated (suitable for welding)		 e.g.	 e.g.
d_1	l_1	$d_2 \pm 0.2$	$d_4 \pm 0.08$	$l_3 \pm 0.05$	h_1	$\alpha \pm 1^\circ$	
M4	see table	5.50	0.65	0.55	0.70 - 1.40	3°	
M5		6.50	0.75	0.80			
M6		7.50	0.75	0.80			
M8		9	0.75	0.85	0.80 - 1.40		

		Diameter →			
		M4	M5	M6	M8
		Order No.	Order No.	Order No.	Order No.
Length ↓	6 mm	11-14-006*	--	--	--
	8 mm	11-14-008*	--	--	--
	10 mm	11-14-010*	11-15-010*	11-16-010	11-18-010*
	12 mm	--	11-15-012*	11-16-012*	11-18-012*
	15 mm	--	11-15-015*	11-16-015	11-18-015*
	16 mm	11-14-016*	11-15-016*	11-16-016	--
	20 mm	11-14-020*	11-15-020*	11-16-020*	11-18-020*
25 mm	--	--	11-16-025*	--	
Chuck		82-50-004	82-50-005	82-50-006	82-50-008
					
Chuck		84-50-004	84-50-005	84-50-006	84-50-008
					

Further accessories see accessories catalogue



* Minimum order quantity, delivery time and price upon request.









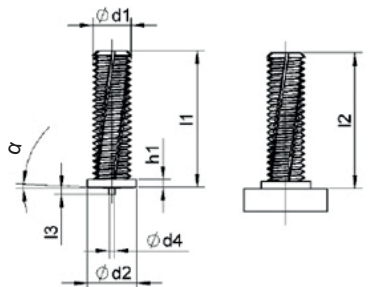

Custom dimensions are not listed in the table – HBS manufactures customised welding elements. On request we can provide pricing.

1) For automation: Diameter: M4 to M8
Stud length: 8 to 40 mm (other lengths on request)

2) Similar to DIN EN ISO 13918



	Type		Material				Suitable for stud feeding	
	CD Paint clearing threaded studs ²⁾		CuZn37				Manual e.g. 	Automation ¹⁾ e.g. 
d_1	l_1	$d_2 \pm 0.2$	$d_4 \pm 0.08$	$l_3 \pm 0.05$	h_1	$\alpha \pm 1^\circ$		
M4	see table	5.50	0.65	0.55	0.70 - 1.40	3°		
M5		6.50	0.75	0.80				
M6		7.50	0.75	0.80				
M8		9	0.75	0.85				

		Diameter →			
		M4	M5	M6	M8
		Order No.	Order No.	Order No.	Order No.
Length ↓	6 mm	--	--	--	--
	8 mm	--	13-15-008	--	--
	10 mm	--	13-15-010	--	--
	12 mm	--	13-15-012	--	--
	14 mm	--	--	13-16-014*	--
	15 mm	--	--	--	--
	16 mm	--	13-15-016	13-16-016*	--
	20 mm	--	13-15-020	--	--
	25 mm	--	--	--	--
Chuck		82-50-004	82-50-005	82-50-006	82-50-008
					
Chuck		84-50-004	84-50-005	84-50-006	84-50-008
					

Further accessories see accessories catalogue

* Minimum order quantity, delivery time and price upon request.

Custom dimensions are not listed in the table – HBS manufactures customised welding elements. On request we can provide pricing.



1) For automation: Diameter: M4 to M8
Stud length: 8 to 40 mm (other lengths on request)



2) Similar to DIN EN ISO 13918

1

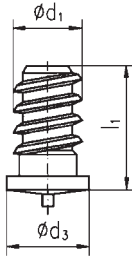

CD Fir tree studs

	Type		Material		Suitable for stud feeding	
	CD Fir tree studs ²⁾		Steel 4.8 copper plated (suitable for welding) A2-50		Manual e.g. 	Automation ¹⁾ e.g. 
	d ₁	l ₁				
	5.0	9.0				
		14.2				
		18.0				
		25.0				

	Diameter			
	Ø 5 x 9 mm	Ø 5 x 14.2 mm	Ø 5 x 18 mm	Ø 5 x 25 mm
	Order No.	Order No.	Order No.	Order No.
Steel 4.8 copper plated (suitable for welding)	10-15-009	10-15-014	10-15-018	10-15-025
A2-50	10-35-009	10-35-014	10-35-018	10-35-025
Chuck 	82-50-005 	82-50-005 	82-50-005 	82-50-005 
Chuck 	84-50-005 	84-50-005 	84-50-005 	84-50-005 

Further accessories see accessories catalogue

* Minimum order quantity, delivery time and price upon request.

Custom dimensions are not listed in the table – HBS manufactures customised welding elements. On request we can provide pricing.

- 1) For automation: Diameter: M4 to M8
Stud length: 8 to 40 mm (other lengths on request)
- 2) Similar to DIN EN ISO 13918

	Type	Material	Suitable for stud feeding
	Ground clips (single and double style)	Steel 4.8 copper plated (suitable for welding) A2-50, CuZn37, AlMg3	Manual e.g.

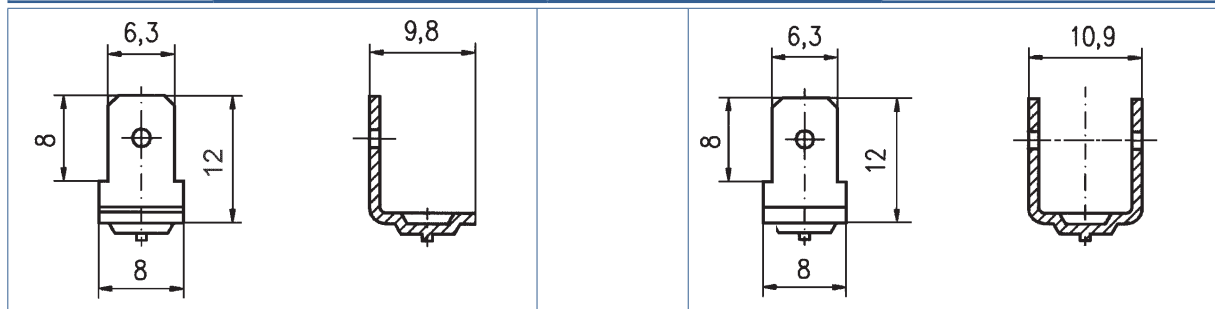

Variations possible. Variations in dimensions do not impair the weld quality.

Material	Steel (4.8) copper plated	A2-50	CuZn37	AlMg3
Ground clips (single style)				
Order No.	30-10-063	30-20-063	30-30-063*	30-40-063
Ground clips (double style)				
Order No.	30-12-063	30-22-063	30-32-063*	30-42-063
Chuck	82-50-050	82-50-050	82-50-050	82-50-050

Further accessories see accessories catalogue

* Minimum order quantity, delivery time and price upon request.

Custom dimensions are not listed in the table – HBS manufactures customised welding elements. On request we can provide pricing.

1

	Type Silicone cover*	Suitable for stud feeding
		Manual

Silicone cover

Silicone cover for threaded studs and pins

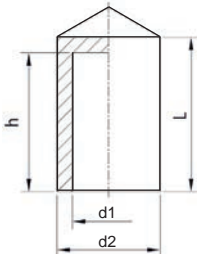
Drawing	G	h	Order No.
	G3	12.0 mm	38-90-003*
	G4	12.0 mm	38-90-004*
	G5	12.0 mm	38-90-005*
	G6	12.0 mm	38-90-006*
	G8	12.0 mm	38-90-008*
	G10	30.0 mm	38-90-010*

Silicone cover for ground clips (single and double style)

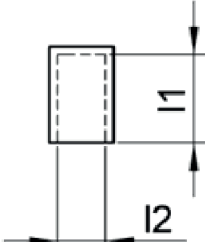
Drawing	I1	I2	Order No.
	11.0 mm	6.0 mm	38-90-063*

* Not in stock, dimension, minimum order quantity, delivery time and price upon request.

	Type Silicone cover*	Suitable for stud feeding
		Manual

1



Silicone cover

Further types (on request):

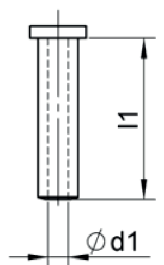
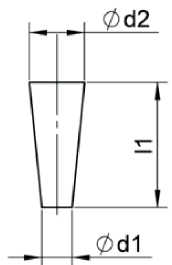
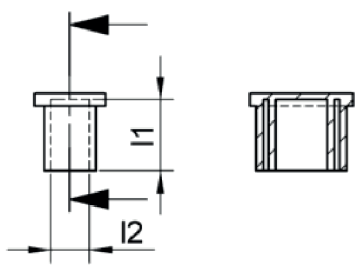

























Silicone cover for threaded studs and pins	Silicone cover for studs with internal thread	Silicone cover for ground clips (single and double style)
		

* Not in stock, dimension, minimum order quantity, delivery time and price upon request.

2

Welding process:

Drawn arc stud welding

	<p>Welding elements type RD Threaded studs with reduced shaft</p> <p>Name for a metric threaded stud according to DIN EN ISO 13918</p>			
	<table><tr><td> Mild steel 4.8 from page 28</td><td> A2-50 from page 29</td><td> 4.8 nickel plated (E2E) from page 30</td></tr></table>	 Mild steel 4.8 from page 28	 A2-50 from page 29	 4.8 nickel plated (E2E) from page 30
 Mild steel 4.8 from page 28	 A2-50 from page 29	 4.8 nickel plated (E2E) from page 30		
	<p>Welding elements type DD Virtually fully threaded studs</p> <p>Special type of PD studs</p> <p>Name for a metric threaded stud similar to DIN EN ISO 13918</p>			
	<table><tr><td> Mild steel 4.8 from page 34</td><td> A2-50 from page 35</td></tr></table>	 Mild steel 4.8 from page 34	 A2-50 from page 35	
 Mild steel 4.8 from page 34	 A2-50 from page 35			
	<p>Welding elements type PD Partially threaded studs</p> <p>Name for a metric threaded stud according to DIN EN ISO 13918</p>			
	<table><tr><td> Mild steel 4.8 from page 38</td><td> A2-50 from page 38</td></tr></table>	 Mild steel 4.8 from page 38	 A2-50 from page 38	
 Mild steel 4.8 from page 38	 A2-50 from page 38			
	<p>Welding elements type UD Unthreaded studs (pins)</p> <p>Name for an unthreaded stud according to DIN EN ISO 13918</p>			
	<table><tr><td> Mild steel 4.8 from page 40</td><td> A2-50 from page 40</td></tr></table>	 Mild steel 4.8 from page 40	 A2-50 from page 40	
 Mild steel 4.8 from page 40	 A2-50 from page 40			

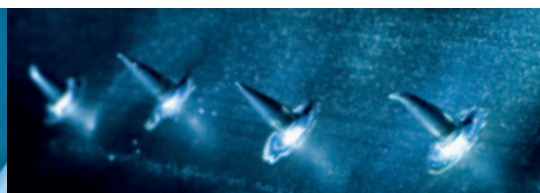

Welding process:

Drawn arc stud welding

	<p>Welding elements type ID Studs with internal thread</p> <p>Name for a stud (pin) with internal thread according to DIN EN ISO 13918</p> <div style="display: flex; justify-content: space-around;"> <div data-bbox="779 585 876 753">  <p>Mild steel 4.8 from page 42</p> </div> <div data-bbox="1031 585 1128 753">  <p>A2-50 from page 42</p> </div> </div>
	<p>Welding elements type SD Shear connectors / Concrete anchors</p> <p>Name for a shear connector according to DIN EN ISO 13918</p> <div style="text-align: center;">  <p>S235J2G3+C450 from page 44</p> </div>
	<p>Ceramic ferrules (CF)</p> <p>To contain the weld pool when using welding elements with flux (Aluminium ball).</p> <p style="text-align: center;">from page 45</p>



2

Stud types, abbreviations, material, norm, mechanical characteristics according to DIN EN ISO 13918

Stud types		Abbreviations for studs (ceramic ferrules)	Material	Norm	Mechanical characteristics tensile strength R_m upper yield strength R_{eH} 0,2 % yield strength $R_{p0.2}$ elongation A_5
Drawn arc welding with ceramic ferrule (CF) or shielding gas (SG)	Threaded stud	PD (PF)	Mild steel 4.8 ¹⁾	ISO 898-1	$R_m \geq 420 \text{ N/mm}^2$ $R_{eH} \geq 340 \text{ N/mm}^2$
	Threaded stud with reduced shaft	RD (RF)	Mild steel 4.8 ¹⁾	ISO 898-1	$R_m \geq 420 \text{ N/mm}^2$ $R_{eH} \geq 340 \text{ N/mm}^2$
			A2-50	ISO 3506-1	$R_m \geq 500 \text{ N/mm}^2$ $R_{p0.2} \geq 210 \text{ N/mm}^2$
	Unthreaded stud (Pin)	UD (UF)	Mild steel 4.8 ¹⁾	ISO 3506-1	$R_m \geq 420 \text{ N/mm}^2$ $R_{eH} \geq 340 \text{ N/mm}^2$
			A2-50	ISO 3506-1	$R_m \geq 500 \text{ N/mm}^2$ $R_{p0.2} \geq 210 \text{ N/mm}^2$
	Stud with internal thread	ID (IF)	Mild steel 4.8 ¹⁾	ISO 3506-1	$R_m \geq 420 \text{ N/mm}^2$ $R_{eH} \geq 340 \text{ N/mm}^2$
			A2-50	ISO 3506-1	$R_m \geq 500 \text{ N/mm}^2$ $R_{p0.2} \geq 210 \text{ N/mm}^2$
	Shear connectors	SD (UF)	S 235 J2G3+C450 C \leq 0,2%; CEV \leq 0,35; Al \geq 0,02%	ISO/TR 15608 Werkstoffgruppe 1	$R_m \geq 450 \text{ N/mm}^2$ $R_{eH} \geq 350 \text{ N/mm}^2$ $A_5 \geq 15 \%$
A2-50			EN 10088-1	$R_m \geq 500 - 780 \text{ N/mm}^2$ $R_{p0.2} \geq 350 \text{ N/mm}^2$ $A_5 \geq 25 \%$	

Further material upon request

¹⁾ suitable for welding

Prestress at installation (tie load) and torque

Threaded stud	Steel (4.8 ¹⁾) $\mu = 0.18$ $R_{p0.2} = 340 \text{ N/mm}^2$		A2-50 $\mu = 0.18$ $R_{p0.2} = 210 \text{ N/mm}^2$		AlMg3 (F23) $\mu = 0.18$ $R_{p0.2} = 170 \text{ N/mm}^2$		CuZn37 $\mu = 0.18$ $R_{p0.2} = 250 \text{ N/mm}^2$	
	Prestress at installation (kN)	Torque (Nm)	Prestress at installation (kN)	Torque (Nm)	Prestress at installation (kN)	Torque (Nm)	Prestress at installation (kN)	Torque (Nm)
M6	4.3	6.1	2.7	3.8	2.2	3.1	3.2	4.5
M8	8.0	15.0	4.9	9.5	4.0	7.5	6.0	11.0
M10	13.0	30.0	7.8	19.0				
M12	19.0	53.0	12.0	33.0				
M16	35.0	135.0	22.0	82.0				

Values correspond with DVS-Merkblatt 0904 (December 2004)

¹⁾ suitable for welding

All given values are leads for minimum tensile strength and minimum torque of a weld without permanent deformation of parts to be joined. Parts to be joined must have sufficient wall thickness. Values apply for cold rolled threaded studs with standard thread without surface protection and without thread lubrication. Throughout the entire stud length, at least the stressed cross section must be present. Values apply for indicated yield strengths.

Material combinations

according to DIN EN ISO 14555 (Select stud material in a way that material of the same kind is welded)

Stud material	Base material			
	ISO/TR 15608 Groups 1 and 2.1	ISO/TR 15608 Groups 2.2, 3 to 6	ISO/TR 15608 Groups 8 and 10	ISO/TR 15608 Groups 21 and 22
Steel 4.8 ¹⁾	a		b	--
A2-50	b/a		a	--
EN AW-AlMg3/EN AW-5754	--		--	b

Exemplification of welding suitability:
 -- non weldable
 a well suited for any application, e.g. power transmission
 b suitable, limitations with power transmission

Weldability tests of other material combinations upon request.

¹⁾ suitable for welding

Flux (Aluminium Ball)

Welding studs in steel (S235) 4.8¹⁾ (for drawn ARC welding with ceramic ferrule) have a flux (aluminium ball) on the welding area. The flux will ignite the arc easier and the welding bath will be deoxidized.

No flux necessary when welding with shielding gas.

Surface Treatment

The studs will be supplied without surface protection.

If the number of pieces exceeds a certain limit studs can also be delivered with following layers:

- nickel plated
- copper plated
- zinc plated

Layer thickness corresponds with DIN EN ISO 4042; tolerance zone 6h DIN 13-20, could be achieved.

For coated threaded studs the tolerances apply before coating.

Threads

Non coated threaded studs are provided with a thread to DIN ISO 724, DIN EN ISO 4759-1, product class A, tolerance zone 6g. Galvanized threaded studs correspond with DIN EN ISO 4042, tolerance zone 6h.

Cold rolling of thread shows the following advantages:

- no interruption of fiber orientation,
- increase of strength by up to 200 %,
- decrease of surface roughness in connection with
- increased corrosion resistance.

Type of Stud

• Type DD (Type MD)

The stud is full threaded. After welding the total length the thread is utilizable. The welding bulge is approx. 3 to 4 mm larger than the outside diameter of the stud.

¹⁾ suitable for welding

• Type RD (previously Type MR)

The stud is part threaded. The base is not threaded and reduced to the core of the stud. The welding bulge is approx. 0.5 to 1 mm larger than the outside diameter of the stud.

• Type PD (previously Type MP)

The stud is part threaded (approx. 1/3 of total length). Thread is only on the end of the stud.

Quality level

HBS welding studs are supplied according to DIN EN ISO 3269 with quality level (AQL) 1.5.

Excess/minor deliveries

With respect to articles made as per sample or drawing and requiring special manufacture production-related excess/short deliveries of up to 10 % have to be accepted as delivery according to contract. Exceptions need to be noted explicitly in the order and to be confirmed in writing.

Tolerances

As long as no tolerances are specified for dimensions, form and position HBS welding studs are supplied according to DIN EN ISO 4759-1, product class A.

Storage

We recommend to store the welding studs factorypacked.

That's how you can avoid irregular welding results caused by humidity, dirt etc.

With aluminium welding studs, the thickness of the oxide layer of the surface can be reduced to a minimum value using the recommended storage procedure.

Due to its corrosion properties, we recommend quick processing.

Please avoid mixing different batches.

Ordering

You make order processing a lot easier if you indicate the order numbers which are part of the price lists.

Welding elements with particular specifications available on request

Order key for welding elements PD, RD and DD

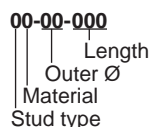

Stud type	
5	RD Threaded studs with reduced shaft
6	DD Virtually fully threaded stud
7	PD Partially threaded studs

Material	
1	Mild steel 4.8
2	A2-50
7	Steel 4.8 nickel plated (E2E)

Order key for welding elements UD, ID and SD

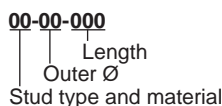

Stud type	
70	SC Shear connector type SD material S235/J2G3+C450
74	Unthreaded studs (pins) type UD material mild steel 4.8
75	Unthreaded studs (pins) type UD material A2-50
76	Pins with internal thread type ID material mild steel 4.8
77	Pins with internal thread type ID material A2-50

Order examples:
 Threaded stud type RD M8 x 25, material mild steel (4.8), with ball
 Threaded stud type DD M12 x 30, material A2-50, without ball
 Threaded stud type PD M10 x 40, material A2-50, with ball

Order No. 51-08-025K
Order No. 62-12-030
Order No. 72-10-040K

2









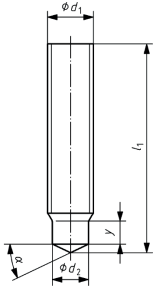
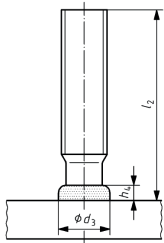















Threaded studs with reduced shaft type RD

 <p>(Ceramic ferrule included in delivery)</p>	Type	Material	Suitable for stud feeding
	RD Threaded studs with reduced shaft (with ceramic ferrule)	Mild steel 4.8 (suitable for welding)	Manual
			e.g. 

d ₁	l ₂ ²⁾	d ₂	d ₃ ¹⁾	y _{min}	h ₁ ¹⁾
M6	see table	4.7	7.0	4.0	2.5
M8		6.2	9.0	4.0	2.5
M10		7.9	11.5	5.0	3.0
M12		9.5	13.5	6.0	4.0
M16		13.2	18.0	7.5	5.0
M20		16.5	23.0	9.0	6.0
M24		20.0	28.0	12.0	7.0



	Diameter						
	M6	M8	M10	M12	M16	M20	M24
	Order No.	Order No.	Order No.	Order No.	Order No.	Order No.	Order No.
20 mm	51-06-020K*	51-08-020K*	51-10-020K*	51-12-020K*	--	--	--
25 mm	51-06-025K*	51-08-025K*	51-10-025K*	51-12-025K*	--	--	--
30 mm	51-06-030K*	51-08-030K*	51-10-030K*	51-12-030K*	51-16-030K*	--	--
35 mm	51-06-035K*	51-08-035K*	51-10-035K*	51-12-035K*	51-16-035K*	--	--
40 mm	51-06-040K*	51-08-040K*	51-10-040K*	51-12-040K*	51-16-040K*	--	--
45 mm	--	51-08-045K*	51-10-045K*	51-12-045K*	51-16-045K*	--	--
50 mm	51-06-050K*	51-08-050K*	51-10-050K*	51-12-050K*	51-16-050K*	51-20-050K*	51-24-050K*
55 mm	--	--	51-10-055K*	51-12-055K*	51-16-055K*	51-20-055K*	--
60 mm	--	51-08-060K*	--	51-12-060K*	51-16-060K*	51-20-060K*	--
65 mm	--	--	--	--	51-16-065K*	--	--
70 mm	--	--	51-10-070K*	51-12-070K*	51-16-070K*	--	--
80 mm	--	--	51-10-080K*	51-12-080K*	51-16-080K*	--	--
90 mm	--	--	--	51-12-090K*	--	51-20-090K*	--
100 mm	--	--	51-10-100K*	--	51-16-100K*	--	--
Chuck	83-50-006	83-50-008	83-50-010	83-50-012	83-50-016	83-50-020	83-50-024
							
Ceramic ferrule grip	80-31-095	80-31-120	80-31-150	80-31-170	80-30-116	80-31-262	80-31-307
							
Ceramic ferrule	50-50-006	50-50-008	50-50-010	50-50-012	50-50-016	50-50-020K	50-50-024K
							

Further accessories see accessories catalogue

* Minimum order quantity, delivery time and price upon request.

Custom dimensions are not listed in the table – HBS manufactures customised welding elements. On request we can provide pricing.

- The dimensions of stud collars are guidance values and may be generally achieved in welding position PA according to ISO 6947. The weld collars are subject to variations regarding evenness and shape.
- The length after welding l₂ is a design value. By proper control of the welding it is possible to keep variations in l₂ within ±1 mm.

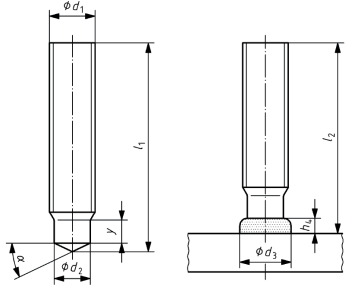
 <p>(Ceramic ferrule included in delivery)</p>	Type	Material				Suitable for stud feeding
	RD Threaded studs with reduced shaft (with ceramic ferrule)	A2-50				Manual
						e.g. 
d_1	$l_2^{2)}$	d_2	$d_3^{1)}$	y_{min}	$h_1^{1)}$	
M6	see table	4.7	7.0	4.0	2.5	
M8		6.2	9.0	4.0	2.5	
M10		7.9	11.5	5.0	3.0	
M12		9.5	13.5	6.0	4.0	
M16		13.2	18.0	7.5	5.0	
M20		16.5	23.0	9.0	6.0	
M24		20.0	28.0	12.0	7.0	



Threaded studs with reduced shaft type RD

	Diameter						
	M6	M8	M10	M12	M16	M20	M24
	Order No.	Order No.	Order No.	Order No.	Order No.	Order No.	
20 mm	52-06-020K*	52-08-020K*	52-10-020K*	52-12-020K*	--	--	--
25 mm	52-06-025K*	52-08-025K*	52-10-025K*	52-12-025K*	--	--	--
30 mm	52-06-030K*	52-08-030K*	52-10-030K*	52-12-030K*	52-16-030K*	--	--
35 mm	52-06-035K*	52-08-035K*	52-10-035K*	52-12-035K*	52-16-035K*	--	--
40 mm	52-06-040K*	52-08-040K*	52-10-040K*	52-12-040K*	52-16-040K*	--	--
45 mm	--	52-08-045K*	52-10-045K*	52-12-045K*	52-16-045K*	--	--
50 mm	52-06-050K*	52-08-050K*	52-10-050K*	52-12-050K*	52-16-050K*	52-20-050K*	52-24-050K*
55 mm	--	--	52-10-055K*	52-12-055K*	52-16-055K*	52-20-055K*	--
60 mm	--	--	52-10-060K*	52-12-060K*	52-16-060K*	52-20-060K*	--
65 mm	--	--	--	--	52-16-065K*	--	--
70 mm	--	--	52-10-070K*	52-12-070K*	52-16-070K*	--	--
75 mm	--	52-08-075K*	--	--	--	--	--
80 mm	--	--	52-10-080K*	52-12-080K*	52-16-080K*	--	--
90 mm	--	--	--	--	--	52-20-090K*	--
100 mm	--	--	52-10-100K*	52-12-100K*	52-16-100K*	--	--

Chuck	83-50-006	83-50-008	83-50-010	83-50-012	83-50-016	83-50-020	83-50-024
							
Ceramic ferrule grip	80-31-095	80-31-120	80-31-150	80-31-170	80-30-116	80-31-262	80-31-307
							
Ceramic ferrule	50-50-006	50-50-008	50-50-010	50-50-012	50-50-016	50-50-020K	50-50-024K
							

Further accessories see accessories catalogue

* Minimum order quantity, delivery time and price upon request.



Custom dimensions are not listed in the table – HBS manufactures customised welding elements. On request we can provide pricing.

- 1) The dimensions of stud collars are guidance values and may be generally achieved in welding position PA according to ISO 6947. The weld collars are subject to variations regarding evenness and shape.
- 2) The length after welding l_2 is a design value. By proper control of the welding it is possible to keep variations in l_2 within ± 1 mm.

2









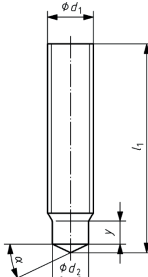
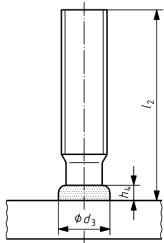





Threaded studs with reduced shaft type RD

 <p>(Ceramic ferrule included in delivery)</p>	Type	Material	Suitable for stud feeding
	RD Threaded studs with reduced shaft (with ceramic ferrule)	Steel 4.8 nickel plated (E2E) (suitable for welding)	Manual e.g. 

d_1	$l_2^{2)}$	d_2	$d_3^{1)}$	y_{min}	$h_1^{1)}$
M6	see table	4.7	7.0	4.0	2.5
M8		6.2	9.0	4.0	2.5
M10		7.9	11.5	5.0	3.0
M12		9.5	13.5	6.0	4.0
M16		13.2	18.0	7.5	5.0
M20		16.5	23.0	9.0	6.0
M24		20.0	28.0	12.0	7.0

	Diameter →			
	M12	M16	M20	
	Order No.	Order No.	Order No.	
Length ↓	20 mm	57-12-020K*	--	--
	25 mm	57-12-025K*	--	--
	30 mm	57-12-030K*	57-16-030K*	--
	35 mm	--	--	--
	40 mm	57-12-040K*	57-16-040K*	--
	45 mm	--	57-16-045K*	--
	50 mm	57-12-050K*	57-16-050K*	57-20-050K*
	60 mm	57-12-060K*	--	--
	70 mm	57-12-070K*	--	--
	Chuck	83-50-012	83-50-016	83-50-020
				
	Ceramic ferrule grip	80-31-170	80-30-116	80-31-262
				
	Ceramic ferrule	50-50-012	50-50-016	50-50-020K
				

Further accessories see accessories catalogue

* Minimum order quantity, delivery time and price upon request.





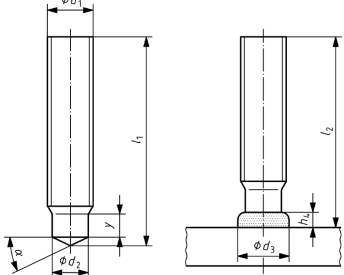

Custom dimensions are not listed in the table – HBS manufactures customised welding elements. On request we can provide pricing.

- The dimensions of stud collars are guidance values and may be generally achieved in welding position PA according to ISO 6947. The weld collars are subject to variations regarding evenness and shape.
- The length after welding l_2 is a design value. By proper control of the welding it is possible to keep variations in l_2 within ± 1 mm.

 (Delivery without ceramic ferrule)	Type	Material	Suitable for stud feeding
	RD Threaded studs with reduced shaft (with shielding gas)	Mild steel 4.8 (suitable for welding)	Manual e.g. 

d_1	$l_2^{2)}$	d_2	$d_3^{1)}$	y_{min}	$h_1^{1)}$
M6	see table	4.7	7.0	4.0	2.5
M8		6.2	9.0	4.0	2.5
M10		7.9	11.5	5.0	3.0
M12		9.5	13.5	6.0	4.0
M16		13.2	18.0	7.5	5.0
M20		16.5	23.0	9.0	6.0
M24		20.0	28.0	12.0	7.0



	Diameter →				
	M6	M8	M10	M12	M16
	Order No.	Order No.	Order No.	Order No.	Order No.
10 mm	51-06-010*	--	--	--	--
12 mm	--	51-08-012*	51-10-012*	--	--
15 mm	51-06-015*	51-08-015*	51-10-015*	--	--
20 mm	51-06-020*	51-08-020*	51-10-020	51-12-020*	--
25 mm	51-06-025*	51-08-025*	51-10-025	51-12-025*	--
30 mm	51-06-030*	51-08-030*	51-10-030	51-12-030*	51-16-030*
35 mm	51-06-035*	51-08-035*	51-10-035*	51-12-035*	51-16-035*
40 mm	51-06-040*	51-08-040*	51-10-040*	51-12-040*	51-16-040*
45 mm	51-06-045*	51-08-045*	51-10-045*	51-12-045*	51-16-045*
50 mm	51-06-050*	51-08-050*	51-10-050*	51-12-050*	51-16-050*
55 mm	--	--	51-10-055*	51-12-055*	51-16-055*
60 mm	--	--	51-10-060*	51-12-060*	51-16-060*
Chuck	83-51-006	83-51-008	83-51-010	83-51-012	83-51-016
					

Further accessories see accessories catalogue

Threaded studs with reduced shaft type RD

* Minimum order quantity, delivery time and price upon request.



Custom dimensions are not listed in the table – HBS manufactures customised welding elements. On request we can provide pricing.

- 1) The dimensions of stud collars are guidance values and may be generally achieved in welding position PA according to ISO 6947. The weld collars are subject to variations regarding evenness and shape.
- 2) The length after welding l_2 is a design value. By proper control of the welding it is possible to keep variations in l_2 within ± 1 mm.

2



Threaded studs with reduced shaft type RD





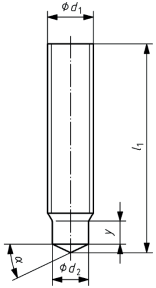
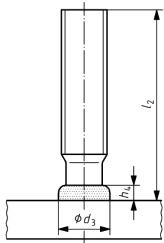

 (Delivery without ceramic ferrule)	Type	Material	Suitable for stud feeding
	RD Threaded studs with reduced shaft (with shielding gas)	A2-50	Manual e.g. 

d_1	$l_2^{2)}$	d_2	$d_3^{1)}$	y_{min}	$h_1^{1)}$
M6	see table	4.7	7.0	4.0	2.5
M8		6.2	9.0	4.0	2.5
M10		7.9	11.5	5.0	3.0
M12		9.5	13.5	6.0	4.0
M16		13.2	18.0	7.5	5.0
M20		16.5	23.0	9.0	6.0
M24		20.0	28.0	12.0	7.0

	Diameter →				
	M6	M8	M10	M12	M16
	Order No.	Order No.	Order No.	Order No.	Order No.
10 mm	52-06-010	--	--	--	--
12 mm	--	52-08-012*	--	--	--
15 mm	52-06-015	52-08-015	52-10-015	--	--
20 mm	52-06-020	52-08-020	52-10-020	52-12-020	--
25 mm	52-06-025	52-08-025	52-10-025	52-12-025	--
30 mm	52-06-030	52-08-030	52-10-030	52-12-030	52-16-030*
35 mm	52-06-035*	52-08-035*	52-10-035*	52-12-035	52-16-035*
40 mm	52-06-040*	52-08-040*	52-10-040*	52-12-040*	52-16-040*
45 mm	52-06-045*	52-08-045*	52-10-045*	52-12-045*	52-16-045*
50 mm	52-06-050*	52-08-050*	52-10-050*	52-12-050*	52-16-050*
55 mm	--	--	52-10-055*	52-12-055*	52-16-055*
60 mm	--	--	52-10-060*	52-12-060*	52-16-060*
70 mm	--	--	52-10-070	--	--
80 mm	--	--	52-10-080	--	--
100 mm	--	--	52-10-100	--	--

Length ↓



Chuck	83-51-006	83-51-008	83-51-010	83-51-012	83-51-016
					

Further accessories see accessories catalogue

* Minimum order quantity, delivery time and price upon request.



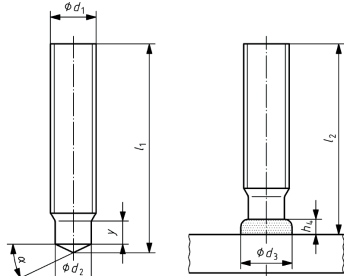

Custom dimensions are not listed in the table – HBS manufactures customised welding elements. On request we can provide pricing.

- The dimensions of stud collars are guidance values and may be generally achieved in welding position PA according to ISO 6947. The weld collars are subject to variations regarding evenness and shape.
- The length after welding l_2 is a design value. By proper control of the welding it is possible to keep variations in l_2 within ± 1 mm.

 (Delivery without ceramic ferrule)	Type		Material			Suitable for stud feeding	
	RD Threaded studs with reduced shaft (with shielding gas)		Steel 4.8 nickel plated (E2E) (suitable for welding)			Manual e.g. 	
d_1	$l_2^{2)}$	d_2	$d_3^{1)}$	y_{min}	$h_1^{1)}$		
M6	see table	4.7	7.0	4.0	2.5		
M8		6.2	9.0	4.0	2.5		
M10		7.9	11.5	5.0	3.0		
M12		9.5	13.5	6.0	4.0		
M16		13.2	18.0	7.5	5.0		
M20		16.5	23.0	9.0	6.0		
M24		20.0	28.0	12.0	7.0		



Threaded studs with reduced shaft type RD

	Diameter →			
	M6	M8	M10	M12
	Order No.	Order No.	Order No.	Order No.
10 mm	57-06-010*	--	--	--
12 mm	57-06-012*	57-08-012	57-10-012*	--
15 mm	57-06-015*	57-08-015	57-10-015*	--
20 mm	57-06-020*	57-08-020	57-10-020*	--
25 mm	--	57-08-025	57-10-025*	--
30 mm	57-06-030*	57-08-030	57-10-030*	57-12-030*
35 mm	--	57-08-035	57-10-035*	57-12-035*
40 mm	--	57-08-040	57-10-040*	57-12-040*
45 mm	--	57-08-045	57-10-045*	57-12-045*
50 mm	--	57-08-050	57-10-050*	57-12-050*
55 mm	--	--	57-10-055*	57-12-055*
60 mm	--	--	57-10-060*	57-12-060*
Chuck	83-51-006	83-51-008	83-51-010	83-51-012
				

Further accessories see accessories catalogue

* Minimum order quantity, delivery time and price upon request.

Custom dimensions are not listed in the table – HBS manufactures customised welding elements. On request we can provide pricing.

- 1) The dimensions of stud collars are guidance values and may be generally achieved in welding position PA according to ISO 6947. The weld collars are subject to variations regarding evenness and shape.
- 2) The length after welding l_2 is a design value. By proper control of the welding it is possible to keep variations in l_2 within ± 1 mm.



2

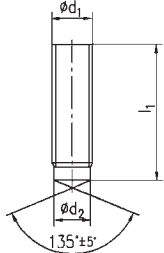
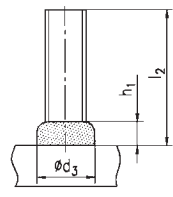

Virtually fully threaded studs type DD

 <p>(Ceramic ferrule included in delivery)</p>	Type	Material	Suitable for stud feeding
	DD Virtually fully threaded studs ³⁾ (with ceramic ferrule)	Mild steel 4.8 (suitable for welding)	Manual
			e.g. 

d ₁	l ₂ ²⁾	d ₂	d ₃	h ₁		
M6	see table	5.35	9.0	3.5		
M8		7.19	9.9	3.0		
M10		9.03	12.5	3.4		
M12		10.86	14.5	4.2		
M16		14.60	17.8	5.8		



	Diameter					
	M6	M8	M10	M12	M16	
	Order No.	Order No.	Order No.	Order No.	Order No.	
Length ↓	20 mm	61-06-020K*	61-08-020K*	61-10-020K*	--	--
	25 mm	61-06-025K*	61-08-025K*	61-10-025K*	61-12-025K*	--
	30 mm	61-06-030K*	61-08-030K*	61-10-030K*	61-12-030K*	61-16-030K*
	35 mm	61-06-035K*	61-08-035K*	61-10-035K*	61-12-035K*	61-16-035K*
	40 mm	61-06-040K*	61-08-040K*	61-10-040K*	61-12-040K*	61-16-040K*
	45 mm	--	61-08-045K*	61-10-045K*	61-12-045K*	--
	50 mm	--	61-08-050K*	61-10-050K*	61-12-050K*	61-16-050K*
	55 mm	--	--	61-10-055K*	61-12-055K*	61-16-055K*
	60 mm	--	--	61-10-060K*	61-12-060K*	61-16-060K*
Chuck		83-50-006	83-50-008	83-50-010	83-50-012	83-50-016
Ceramic ferrule grip		80-31-095	80-31-150	80-31-150	80-31-205	80-31-262
Ceramic ferrule		50-60-006	50-60-008	50-60-010	50-60-012	50-60-016

Further accessories see accessories catalogue



* Minimum order quantity, delivery time and price upon request.

Custom dimensions are not listed in the table – HBS manufactures customised welding elements. On request we can provide pricing.

1) The dimensions of stud collars are guidance values and may be generally achieved in welding position PA according to ISO 6947. The weld collars are subject to variations regarding evenness and shape.
 2) The length after welding l₂ is a design value. By proper control of the welding it is possible to keep variations in l₂ within ± 1 mm..
 3) Similar to DIN EN ISO 13918

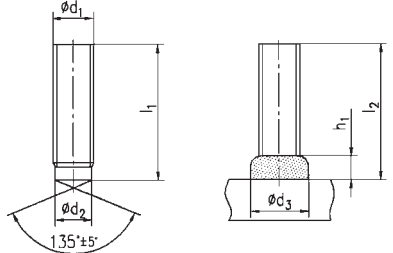
 <p>(Ceramic ferrule included in delivery)</p>	Type	Material	Suitable for stud feeding
	DD Virtually fully threaded studs ³⁾ (with ceramic ferrule)	A2-50	Manual e.g. 

d ₁	l ₂ ²⁾	d ₂	d ₃	h ₁	
M6	see table	5.35	9.0	3.5	
M8		7.19	9.9	3.0	
M10		9.03	12.5	3.4	
M12		10.86	14.5	4.2	
M16		14.60	17.8	5.8	

	Diameter					
	M6	M8	M10	M12	M16	
	Order No.	Order No.	Order No.	Order No.	Order No.	
Length ↓	20 mm	62-06-020K*	62-08-020K*	62-10-020K*	--	--
	25 mm	62-06-025K*	62-08-025K*	62-10-025K*	62-12-025K*	--
	30 mm	62-06-030K*	62-08-030K*	62-10-030K*	62-12-030K*	62-16-030K*
	35 mm	62-06-035K*	62-08-035K*	62-10-035K*	62-12-035K*	62-16-035K*
	40 mm	62-06-040K*	62-08-040K*	62-10-040K*	62-12-040K*	62-16-040K*
	45 mm	--	62-08-045K*	62-10-045K*	--	--
	50 mm	--	62-08-050K*	62-10-050K*	62-12-050K*	62-16-050K*
	55 mm	--	--	62-10-055K*	62-12-055K*	62-16-055K*
	60 mm	--	--	62-10-060K*	62-12-060K*	62-16-060K*
Chuck		83-50-006	83-50-008	83-50-010	83-50-012	83-50-016
Ceramic ferrule grip		80-31-095	80-31-150	80-31-150	80-31-205	80-31-262
Ceramic ferrule		50-60-006	50-60-008	50-60-010	50-60-012	50-60-016

Further accessories see accessories catalogue

* Minimum order quantity, delivery time and price upon request.

Custom dimensions are not listed in the table – HBS manufactures customised welding elements. On request we can provide pricing.

- 1) The dimensions of stud collars are guidance values and may be generally achieved in welding position PA according to ISO 6947. The weld collars are subject to variations regarding evenness and shape.
- 2) The length after welding l₂ is a design value. By proper control of the welding it is possible to keep variations in l₂ within ± 1 mm.
- 3) Similar to DIN EN ISO 13918



Virtually fully threaded studs type DD

2



Virtually fully threaded studs type DD

 (Delivery without ceramic ferrule)	Type	Material	Suitable for stud feeding
	DD Virtually fully threaded studs ³⁾ (with shielding gas)	Mild steel 4.8 (suitable for welding)	Manual e.g. 

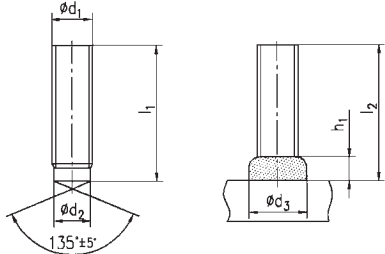
d ₁	l ₂ ²⁾	d ₂	d ₃	h ₁	
M6	see table	5.35	9.0	3.5	
M8		7.19	9.9	3.0	
M10		9.03	12.5	3.4	
M12		10.86	14.5	4.2	
M16		14.60	17.8	5.8	



Length ↓	Diameter →				
	M6	M8	M10	M12	M16
	Order No.	Order No.	Order No.	Order No.	Order No.
15 mm	61-06-015*	61-06-015*	--	--	--
20 mm	61-06-020*	61-08-020*	61-10-020*	--	--
25 mm	61-06-025*	61-08-025*	61-10-025*	61-12-025*	--
30 mm	61-06-030*	61-08-030*	61-10-030*	61-12-030*	61-16-030*
35 mm	61-06-035*	61-08-035*	61-10-035*	61-12-035*	61-16-035*
40 mm	61-06-040*	61-08-040*	61-10-040*	61-12-040*	61-16-040*
45 mm	--	61-08-045*	61-10-045*	61-12-045*	61-16-045*
50 mm	--	61-08-050*	61-10-050*	61-12-050*	61-16-050*
55 mm	--	--	61-10-055*	61-12-055*	61-16-055*
60 mm	--	--	61-10-060*	61-12-060*	61-16-060*
Chuck	83-51-006	83-51-008	83-51-010	83-51-012	83-51-016

Further accessories see accessories catalogue

* Minimum order quantity, delivery time and price upon request.





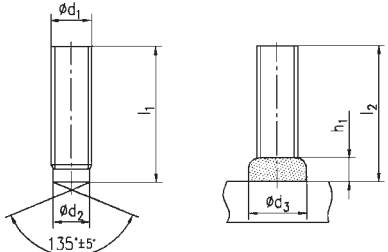

Custom dimensions are not listed in the table – HBS manufactures customised welding elements. On request we can provide pricing.

- 1) The dimensions of stud collars are guidance values and may be generally achieved in welding position PA according to ISO 6947. The weld collars are subject to variations regarding evenness and shape.
- 2) The length after welding l₂ is a design value. By proper control of the welding it is possible to keep variations in l₂ within ± 1 mm.
- 3) Similar to DIN EN ISO 13918

 (Delivery without ceramic ferrule)	Type		Material		Suitable for stud feeding	
	DD Virtually fully threaded studs ³⁾ (with shielding gas)		A2-50		Manual e.g. 	
d ₁	l ₂ ²⁾	d ₂	d ₃	h ₁		
M6	see table	5.35	9.0	3.5		
M8		7.19	9.9	3.0		
M10		9.03	12.5	3.4		
M12		10.86	14.5	4.2		
M16		14.60	17.8	5.8		



Virtually fully threaded studs type DD

	Diameter				
	M6	M8	M10	M12	M16
	Order No.	Order No.	Order No.	Order No.	Order No.
15 mm	62-06-015*	62-08-015*	--	--	--
20 mm	62-06-020*	62-08-020*	62-10-020*	--	--
25 mm	62-06-025*	62-08-025*	62-10-025*	62-12-025*	--
30 mm	62-06-030*	62-08-030*	62-10-030*	62-12-030*	62-16-030*
35 mm	62-06-035*	62-08-035*	62-10-035*	62-12-035*	62-16-035*
40 mm	62-06-040*	62-08-040*	62-10-040*	62-12-040*	62-16-040*
45 mm	--	62-08-045*	62-10-045*	62-12-045*	62-16-045*
50 mm	--	62-08-050*	62-10-050*	62-12-050*	62-16-050*
55 mm	--	--	62-10-055*	62-12-055*	62-16-055*
60 mm	--	--	62-10-060*	62-12-060*	62-16-060*
Chuck	83-51-006	83-51-008	83-51-010	83-51-012	83-51-016
					

Further accessories see accessories catalogue

* Minimum order quantity, delivery time and price upon request.



Custom dimensions are not listed in the table – HBS manufactures customised welding elements. On request we can provide pricing.

- 1) The dimensions of stud collars are guidance values and may be generally achieved in welding position PA according to ISO 6947. The weld collars are subject to variations regarding evenness and shape.
- 2) The length after welding l₂ is a design value. By proper control of the welding it is possible to keep variations in l₂ within ± 1 mm.
- 3) Similar to DIN EN ISO 13918

2



Threaded studs type PD

 <p>(ceramic ferrule included in delivery)</p>	Type	Material	Suitable for stud feeding
	PD Threaded studs* (with ceramic ferrule)	Mild steel 4.8 (suitable for welding) A2-50	Manual e.g. 

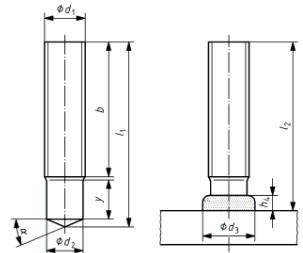
d ₁	l ₂ ²⁾	d ₂	d ₃ ¹⁾	h ₄	α ±2.5°	l ₁ ±1	
M6	see table	5.35	8.5	3.5	22.5°	l ₂ + 2.2	
M8		7.19	10.0	3.5		l ₂ + 2.4	
M10		9.03	12.5	4.0		l ₂ + 2.6	
M12		10.86	15.5	4.5		l ₂ + 3.1	
M16		14.6	19.5	6.0		l ₂ + 3.9	
M20		18.38	24.5	7.0		l ₂ + 4.3	
M24		22.05	30.0	10.0		l ₂ + 5.1	

Material ↓	Diameter →					
	M6	M8	M10	M12	M16	M20
	Order No.	Order No.	Order No.	Order No.	Order No.	Order No.
Mild steel 4.8 (suitable for welding)	71-06-XXXXK	71-08-XXXXK	71-10-XXXXK	71-12-XXXXK	71-16-XXXXK	71-20-XXXXK
A2-50	72-06-XXXXK	72-08-XXXXK	72-10-XXXXK	72-12-XXXXK	72-16-XXXXK	72-20-XXXXK
Chuck	83-50-006	83-50-008	83-50-010	83-50-012	83-50-016	83-50-020
						
Ceramic ferrule grip	80-31-095	80-31-120	80-31-150	80-31-170	80-30-116	80-31-262
						
Ceramic ferrule	50-50-006	50-50-008	50-50-010	50-50-012	50-50-016	50-50-020K
						



Further accessories see accessories catalogue





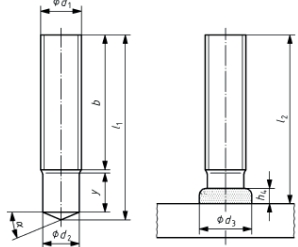

* Not in stock, minimum order quantity, delivery time and price upon request. Please send us the article number with your request. In the article number "XXX" is to be replaced by the respective length (e.g. 025 for 25 mm).

Custom dimensions are not listed in the table – HBS manufactures customised welding elements. On request we can provide pricing.

- The dimensions of stud collars are guidance values and may be generally achieved in welding position PA according to ISO 6947. The weld collars are subject to variations regarding evenness and shape.
- The length after welding l₂ is a design value. By proper control of the welding it is possible to keep variations in l₂ within ±1 mm.



 (delivery without ceramic ferrule)		Type		Material		Suitable for stud feeding	
		PD Threaded studs* (with shielding gas)		Mild steel 4.8 (suitable for welding) A2-50		Manual  e.g.	
d_1	$l_2^{2)}$	d_2	$d_3^{1)}$	h_4	$\alpha \pm 2.5^\circ$	$l_1 \pm 1$	
M6	see table	5.35	8.5	3.5	22.5°	$l_2 + 2.2$	
M8		7.19	10.0	3.5		$l_2 + 2.4$	
M10		9.03	12.5	4.0		$l_2 + 2.6$	
M12		10.86	15.5	4.5		$l_2 + 3.1$	
M16		14.6	19.5	6.0		$l_2 + 3.9$	
M20		18.38	24.5	7.0		$l_2 + 4.3$	
M24		22.05	30.0	10.0		$l_2 + 5.1$	

		Diameter →					
		M6	M8	M10	M12	M16	M20
		Order No.	Order No.	Order No.	Order No.	Order No.	Order No.
Material ↓	Mild steel 4.8 (suitable for welding)	71-06-XXX	71-08-XXX	71-10-XXX	71-12-XXX	71-16-XXX	71-20-XXX
	A2-50	72-06-XXX	72-08-XXX	72-10-XXX	72-12-XXX	72-16-XXX	72-20-XXX
Chuck		83-51-006	83-51-008	83-51-010	83-51-012	83-51-016	83-51-020
							

Further accessories see accessories catalogue

* Not in stock, minimum order quantity, delivery time and price upon request.
Please send us the article number with your request. In the article number "XXX" is to be replaced by the respective length (e.g. 025 for 25 mm).



Custom dimensions are not listed in the table – HBS manufactures customised welding elements. On request we can provide pricing.

- 1) The dimensions of stud collars are guidance values and may be generally achieved in welding position PA according to ISO 6947. The weld collars are subject to variations regarding evenness and shape.
- 2) The length after welding l_2 is a design value. By proper control of the welding it is possible to keep variations in l_2 within ± 1 mm.

2



Unthreaded studs (pins) type UD

 <p>(Ceramic ferrule included in delivery)</p>	Type	Material	Suitable for stud feeding
	UD Unthreaded studs (pins)* (with ceramic ferrule)	Mild steel 4.8 (suitable for welding) A2-50	Manual e.g. 

d_1	$l_2^{(2)}$	$d_3^{(1)}$	h_4	$\alpha \pm 2.5^\circ$	$l_1 \pm 1$
6	see table	8.5	4	22.5°	$l_2 + 2.4$
8		11.0	4		$l_2 + 2.6$
10		13.0	4		$l_2 + 2.8$
12		16.0	5		$l_2 + 3.4$
14.6		18.5	6		$l_2 + 3.9$
16		21.0	7		$l_2 + 3.9$

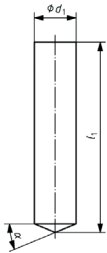
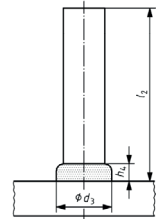
	Diameter					
	Ø 6 mm	Ø 8 mm	Ø 10 mm	Ø 12 mm	Ø 16 mm	
	Order No.	Order No.	Order No.	Order No.	Order No.	
Material	Mild steel 4.8 (suitable for welding)	74-06-XXXXK	74-08-XXXXK	74-10-XXXXK	74-12-XXXXK	74-16-XXXXK
	A2-50	75-06-XXXXK	75-08-XXXXK	75-10-XXXXK	75-12-XXXXK	75-16-XXXXK
Chuck	83-50-006	83-50-008	83-50-010	83-50-012	83-50-016	
						
Ceramic ferrule grip	80-31-095	80-31-150	80-31-150	80-31-205	80-31-262	
						
Ceramic ferrule	50-60-006	50-60-008	50-60-010	50-60-012	50-60-016	
						

Further accessories see accessories catalogue

* Not in stock, minimum order quantity, delivery time and price upon request. Please send us the article number with your request. In the article number "XXX" is to be replaced by the respective length (e.g. 025 for 25 mm).

Custom dimensions are not listed in the table – HBS manufactures customised welding elements. On request we can provide pricing.

- The dimensions of stud collars are guidance values and may be generally achieved in welding position PA according to ISO 6947. The weld collars are subject to variations regarding evenness and shape.
- The length after welding l_2 is a design value. By proper control of the welding it is possible to keep variations in l_2 within ± 1 mm.

<p>(delivery without ceramic ferrule)</p>	Type	Material	Suitable for stud feedingg
	UD Unthreaded studs (pins)* (with shielding gas)	Mild steel 4.8 (suitable for welding) A2-50	Manual e.g.

d_1	$l_2^{2)}$	$d_3^{1)}$	h_4	$\alpha \pm 2.5^\circ$	$l_1 \pm 1$	
6	see table	8.5	4	22.5°	$l_2 + 2.4$	
8		11.0	4		$l_2 + 2.6$	
10		13.0	4		$l_2 + 2.8$	
12		16.0	5		$l_2 + 3.4$	
14.6		18.5	6		$l_2 + 3.9$	
16		21.0	7		$l_2 + 3.9$	

Material	Diameter				
	Ø 6 mm	Ø 8 mm	Ø 10 mm	Ø 12 mm	Ø 16 mm
	Order No.	Order No.	Order No.	Order No.	Order No.
Mild steel 4.8 (suitable for welding)	74-06-XXX	74-08-XXX	74-10-XXX	74-12-XXX	74-16-XXX
A2-50	75-06-XXX	75-08-XXX	75-10-XXX	75-12-XXX	75-16-XXX
Chuck	83-51-006	83-51-008	83-51-010	83-51-012	83-51-016

Further accessories see accessories catalogue

* Not in stock, minimum order quantity, delivery time and price upon request. Please send us the article number with your request. In the article number "XXX" is to be replaced by the respective length (e.g. 025 for 25 mm).



Custom dimensions are not listed in the table – HBS manufactures customised welding elements. On request we can provide pricing.

- 1) The dimensions of stud collars are guidance values and may be generally achieved in welding position PA according to ISO 6947. The weld collars are subject to variations regarding evenness and shape.
- 2) The length after welding l_2 is a design value. By proper control of the welding it is possible to keep variations in l_2 within ± 1 mm.

2









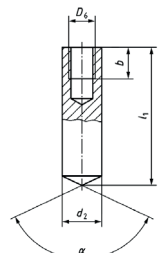
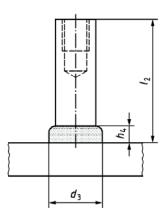

Studs with internal thread type ID



 (Ceramic ferrule included in delivery)	Type	Material	Suitable for stud feeding
	ID Studs with internal thread* (with ceramic ferrule)	Mild steel 4.8 (suitable for welding) A2-50	Manual e.g. 

D ₆	l ₂ ²⁾	d ₂ ±0.1	d ₃	b+2P	h ₄	α ±7°	l ₁ ±1
M5	see table	10	13	7.5	4	140°	l ₂ + 2.3
M6		10	13	9	4		l ₂ + 2.3
M8		12	16	12	5		l ₂ + 2.8
M8		14.6	18.5	15	6		l ₂ + 3.5
M10		14.6	18.5	15	6		l ₂ + 3.5
M10		16	21	15	7		l ₂ + 3.5
M12		18.38	23	18	7		l ₂ + 3.7



Material ↓	Diameter →		
	M6 / Ø 10 mm	M8 / Ø 12 mm	M10 / Ø 16 mm
	Order No.	Order No.	Order No.
Mild steel 4.8 (suitable for welding)	76-10-XXXXK	76-12-XXXXK	76-16-XXXXK
A2-50	77-10-XXXXK	77-12-XXXXK	77-16-XXXXK
Chuck	83-50-010	83-50-012	83-50-016
			
Ceramic ferrule grip	80-31-150	80-31-205	80-31-262
			
Ceramic ferrule	50-60-010	50-60-012	50-60-016
			





Further accessories see accessories catalogue

* Not in stock. Minimum order quantity, delivery time and price upon request. Please send us the article number with your request. In the article number "XXX" is to be replaced by the respective length (e.g. 025 for 25 mm).

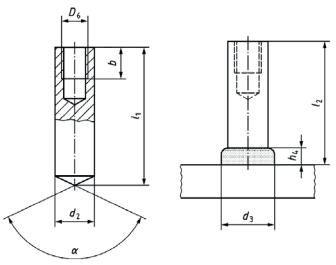
Custom dimensions are not listed in the table – HBS manufactures customised welding elements. On request we can provide pricing.

- The dimensions of stud collars are guidance values and may be generally achieved in welding position PA according to ISO 6947. The weld collars are subject to variations regarding evenness and shape.
- The length after welding l₂ is a design value. By proper control of the welding it is possible to keep variations in l₂ within ± 1 mm.

 (Delivery without ceramic ferrule)		Type					Material		Suitable for stud feeding	
		ID Studs with internal thread* (with shielding gas)					Mild steel 4.8 (suitable for welding) A2-50		Manual e.g. 	
D_6	$l_2^{2)}$	$d_2 \pm 0.1$	d_3	$b+2P$	h_4	$\alpha \pm 7^\circ$	$l_1 \pm 1$			
M5	see table	10	13	7.5	4	140°	$l_2 + 2.3$			
M6		10	13	9	4		$l_2 + 2.3$			
M8		12	16	12	5		$l_2 + 2.8$			
M8		14.6	18.5	15	6		$l_2 + 3.5$			
M10		14.6	18.5	15	6		$l_2 + 3.5$			
M10		16	21	15	7		$l_2 + 3.5$			
M12		18.38	23	18	7		$l_2 + 3.7$			

		Diameter →		
		M6 Ø 10 mm	M8 Ø 12 mm	M10 Ø 16 mm
		Order No.	Order No.	Order No.
Material ↓	Mild steel 4.8 (suitable for welding)	76-10-XXX	76-12-XXX	76-16-XXX
	A2-50	77-10-XXX	77-12-XXX	77-16-XXX
Chuck		83-51-010	83-51-012	83-51-016
				

Further accessories see accessories catalogue



* Not in stock. Minimum order quantity, delivery time and price upon request. Please send us the article number with your request. In the article number "XXX" is to be replaced by the respective length (e.g. 025 for 25 mm).

Custom dimensions are not listed in the table – HBS manufactures customised welding elements. On request we can provide pricing.

- 1) The dimensions of stud collars are guidance values and may be generally achieved in welding position PA according to ISO 6947. The weld collars are subject to variations regarding evenness and shape.
- 2) The length after welding l_2 is a design value. By proper control of the welding it is possible to keep variations in l_2 within ± 1 mm.

2

Shear connectors / Concrete anchors type SD

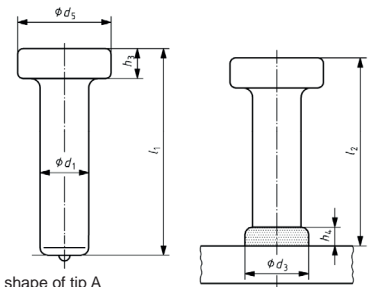
 (Ceramic ferrule included in delivery)		Type	Material				Suitable for stud feeding
		SD Shear connectors / Concrete anchors (with ceramic ferrule)	S235J2G3+C450				Manual
							 e.g.
$d_1 - 0.4^{a, e}$	$d_5 \pm 0.3$	d_3^c	$h_3 +1_{-0.5}$	h_4^c	$l_1 \pm 1.5$	 shape of tip A	
9,5	19	13	7	2,5	$l_2^{b, c} + 3$		
10							
12.7	25	17	8	3	$l_2^{b, c} + 4$		
13							
16	32 ^d	21	10	4.5	$l_2^{b, c} + 4.5$		
19	32	23		6	$l_2^{b, c} + 5$		
22	35	29	12	7	$l_2^{b, c} + 5.5$		
25	41	31					
25.4							

		Diameter					
		Ø 10 mm	Ø 13 mm	Ø 16 mm	Ø 19 mm	Ø 22 mm	Ø 25 mm
		Order No.	Order No.	Order No.	Order No.	Order No.	Order No.
Length ↓	75 mm	70-10-075*	70-13-075*	70-16-075*	70-19-075*	70-22-075*	70-25-075*
	100 mm	70-10-100*	70-13-100*	70-16-100*	70-19-100*	70-22-100*	70-25-100*
	125 mm	70-10-125*	70-13-125*	70-16-125*	70-19-125*	70-22-125*	70-25-125*
	150 mm	70-10-150*	70-13-150*	70-16-150*	70-19-150*	70-22-150*	70-25-150*
	175 mm	70-10-175*	70-13-175*	70-16-175*	70-19-175*	70-22-175*	70-25-175*
	200 mm	--	70-13-200*	70-16-200*	70-19-200*	70-22-200*	70-25-200*
Chuck		83-53-010	83-53-012	83-53-019	83-53-019	83-53-022	83-53-025
Ceramic ferrule grip		80-30-210	80-30-213	80-30-219	80-30-219	80-30-222	88-15-823
Ceramic ferrule		50-60-010K	50-60-013K	50-60-016K	50-60-019K	50-60-022K	50-60-025K

Further accessories see accessories catalogue

* Minimum order quantity, delivery time and price upon request.

Custom dimensions are not listed in the table – HBS manufactures customised welding elements. On request we can provide pricing.

- a Excess diameter or production impressions in the shaft area below the head are permitted up to 0.5 mm, provided they do not affect proper plunge.
- b Tolerance on l_2 is $+1_{-2}$ mm.
- c For special conditions, e.g. through-deck stud welding, the dimensions and the tolerances are not applicable.
- d May be reduced to 29 mm for shear application.
- e Use of the optional dimension depends on national regulations.

Ceramic ferrules

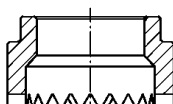
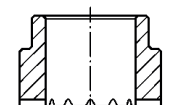
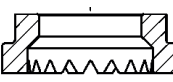
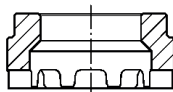

Ceramic ferrules

Order No.	Designation	Overall height in mm ±2	Overall Ø in mm ±2	Used for (type of stud)	Sketch
--	UF4	9	10	ND	
50-60-005	UF5	8	11.5	ND	
50-60-006	UF6	8	11.5	DD, UD, ID, SD	
50-60-008	UF8	8.5	15.5	DD, UD, ID	
50-60-010	UF10	10	18	DD, UD, ID	
50-60-012	UF12	10.5	20	DD, UD, ID	
--	UF12.7	11	22	SD	
50-60-013	UF13	11	22/26 ^a	SD	
50-60-016	UF16	13	30	DD, UD, ID, SD	
--	UF19	16.5	31	SD	
50-60-020	UF20	16.5	31	DD, UD, ID	
50-60-022	UF22	19	39	SD	
50-70-006	PF6	6.5	11.5	PD	
50-70-008	PF8	6.5	15	PD	
50-70-010	PF10	6.5	18	PD	
50-70-012	PF12	9	20	PD	
50-70-016	PF16	11	26	PD	
--	PF20	10	34	PD	
--	PF24	18.5	39	PD	
50-50-006	RF6	10	12	RD	
50-50-008	RF8	9	15	RD	
50-50-010	RF10	11.5	18	RD	
50-50-012	RF12	13	20	RD	
50-50-016	RF16	15.5	30	RD	
50-50-020	RF20	22	32	RD	
50-50-024	RF24	25	33	RD	
50-51-016	RF16	9	30	RD	
--	RF20	9	32	RD	
--	RF24	13	36 ^a	RD	
50-80-016	DF16 ^b	17	30	SD	
50-80-019	DF19 ^b	15	34	SD	
50-80-022	DF22 ^b	19	39	SD	

a At the manufacturer's discretion

b For stud welding through decking sheet (through-deck stud welding)

3

Welding processes:

Drawn arc stud welding (short cycle SC)

	Welding elements type PS Threaded studs with flange Name for a metric threaded stud according to DIN EN ISO 13918	
	 4.8 copper plated from page 50	 A2-50 from page 51
	Welding elements type US Unthreaded studs (pins) with flange Name for a pin according to DIN EN ISO 13918	
	 4.8 copper plated from page 52	 A2-50 from page 52
	Welding elements type IS Studs with internal thread and flange Name for a pin with internal thread according to DIN EN ISO 13918	
	 4.8 copper plated from page 53	 A2-50 from page 53



Welding processes:

Drawn arc stud welding (short cycle SC)

	<p>SC Paint clearing threaded studs</p> <p>Name for a metric threaded stud with transverse grooves.</p> <p>The welding geometry is designed similar to DIN EN ISO 13918.</p> <p>Especially suitable for subsequent painting/coating.</p>  <p>4.8 copper plated from page 54</p>
	<p>SC Fir tree studs</p> <p>Name for a threaded stud, also referred to as a saw tooth stud or coarse threaded stud. Fir tree studs have a special thread with a defined pitch (P) of 1.6 mm.</p> <p>The welding geometry is designed similar to DIN EN ISO 13918.</p> <p>Especially suitable for the quick installation of snap-on elements such as plastic nuts or cable mountings.</p>  <p>4.8 copper plated from page 55</p>  <p>A2-50 from page 55</p>



3

Stud types, abbreviations, material, norm, mechanical characteristics according to DIN EN ISO 13918

Stud types		Abbreviations for studs	Material	Norm	Mechanical characteristics tensile strength R_m upper yield strength R_{eH} 0,2 % yield strength $R_{p0,2}$
Short cycle welding with drawn arc	Threaded stud with flange	PS	Mild steel 4.8 ¹⁾ copper plated (C1E)	ISO 898-1	$R_m \geq 420 \text{ N/mm}^2$ $R_{eH} \geq 340 \text{ N/mm}^2$
			A2-50	ISO 3506-1	$R_m \geq 500 \text{ N/mm}^2$ $R_{p0,2} \geq 210 \text{ N/mm}^2$
	Pin with flange	US	Mild steel 4.8 ¹⁾ copper plated (C1E)	ISO 898-1	$R_m \geq 420 \text{ N/mm}^2$ $R_{eH} \geq 340 \text{ N/mm}^2$
			A2-50	ISO 3506-1	$R_m \geq 500 \text{ N/mm}^2$ $R_{p0,2} \geq 210 \text{ N/mm}^2$
	Stud with internal thread and flange	IS	Mild steel 4.8 ¹⁾ copper plated (C1E)	ISO 898-1	$R_m \geq 420 \text{ N/mm}^2$ $R_{eH} \geq 340 \text{ N/mm}^2$
			A2-50	ISO 3506-1	$R_m \geq 500 \text{ N/mm}^2$ $R_{p0,2} \geq 210 \text{ N/mm}^2$

Further material upon request

¹⁾ suitable for welding

Prestress at installation (tie load) and torque

Threaded stud	Steel (4.8 ¹⁾) $\mu = 0.18$ $R_{p0,2} = 340 \text{ N/mm}^2$		A2-50 $\mu = 0.18$ $R_{p0,2} = 210 \text{ N/mm}^2$		AlMg3 (F23) $\mu = 0.18$ $R_{p0,2} = 170 \text{ N/mm}^2$		CuZn37 $\mu = 0.18$ $R_{p0,2} = 250 \text{ N/mm}^2$	
	Prestress at installation (kN)	Torque (Nm)	Prestress at installation (kN)	Torque (Nm)	Prestress at installation (kN)	Torque (Nm)	Prestress at installation (kN)	Torque (Nm)
M6	4.3	6.1	2.7	3.8	2.2	3.1	3.2	4.5
M8	8.0	15.0	4.9	9.5	4.0	7.5	6.0	11.0
M10	13.0	30.0	7.8	19.0				
M12	19.0	53.0	12.0	33.0				
M16	35.0	135.0	22.0	82.0				

Values correspond with DVS-leaflet 0904 (September 2004)

¹⁾ suitable for welding

All given values are leads for minimum tensile strength and minimum torque of a weld without permanent deformation of parts to be joined. Parts to be joined must have sufficient wall thickness. Values apply for cold rolled threaded studs with standard thread without surface protection and without thread lubrication. Throughout the entire stud length, at least the stressed cross section must be present. Values apply for indicated yield strengths.

Material combinations

according to DIN EN ISO 14555 (Select stud material in a way that material of the same kind is welded)

Stud material	Base material			
	ISO/TR 15608 Groups 1 and 2.1	ISO/TR 15608 Groups 2.2, 3 to 6	ISO/TR 15608 Groups 8 and 10	ISO/TR 15608 Groups 21 and 22
Steel 4.8 ¹⁾ 16Mo3	a	b	b	--
A2-50	b/a	b	a	--
EN AW-AlMg3/EN AW-5754	--	--	--	b

Exemplification of welding suitability:

- non weldable
- a well suited for any application, e.g. power transmission
- b suitable, limitations with power transmission

Weldability tests of other material combinations upon request.

¹⁾ suitable for welding

Stud Flange

The stud flange is designed according to DIN EN ISO 13918. The flange is part of the welding stud. Its diameter is bigger than the diameter of the stud. During welding, it prevents the arc from burning to the cylindrical part of the stud and increases the welding area simultaneously. This results in higher strength of the welded joint. The flange also serves to automatic feeding using HBS stud feeding units. Depending on requirements, you can use welding studs which have different flange dimensions or even no flange.

Flux (Aluminium Ball)

No flux necessary when welding with short cycle.

Surface Treatment

Unless otherwise specified, studs PS, US and IS of property class 4.8 are supplied with electroplated copper coating (C1E).

Threads

Non coated threaded studs are provided with a thread to DIN ISO 724, DIN EN ISO 4759-1, product class A, tolerance zone 6g. Galvanized threaded studs correspond with DIN EN ISO 4042, tolerance zone 6h.

Cold rolling of thread shows the following advantages:

- no interruption of fiber orientation,
- increase of strength by up to 200 %,
- decrease of surface roughness in connection with
- increased corrosion resistance.

¹⁾ suitable for welding

Quality level

HBS welding studs are supplied according to DIN EN ISO 3269 with quality level (AQL) 1,5.

Excess/minor deliveries

With respect to articles made as per sample or drawing and requiring special manufacture production-related excess/ short deliveries of up to 10 % have to be accepted as delivery according to contract. Exceptions need to be noted explicitly in the order and to be confirmed in writing.

Tolerances

As long as no tolerances are specified for dimensions, form and position HBS welding studs are supplied according to DIN EN ISO 4759-1, product class A.

Storage

We recommend to store the welding studs factorypacked. That's how you can avoid irregular welding results caused by humidity, dirt etc. With aluminium welding studs, the thickness of the oxide layer of the surface can be reduced to a minimum value using the recommended storage procedure. Due to its corrosion properties, we recommend quick processing.

Please avoid mixing different batches.

Ordering

You make order processing a lot easier if you indicate the order numbers which are part of the price lists.

Welding elements with particular specifications available on request

Order key for welding elements

00-00-000
 | Length
 | Outer Ø
 | Welding process
 | Material
 | Stud type

Stud type	
1	PS Threaded stud (previously FD)
2	US Unthreaded stud with flange

Material	
1	Steel 4.8 copper plated
2	A2-50

00-0-00-000
 | Length
 | Outer Ø
 | Welding process
 | Internal Ø (Thread)
 | Material
 | Stud type

Stud type	
3	IS Stud with internal thread and flange

Welding process	
5	Short Cycle

Order examples: Threaded stud type PS M6 x 25, material steel 4.8 copper plated
 Unthreaded stud (pin) type US Ø 3 x 4 mm, material A2-50
 Stud with internal thread type IS M4, Ø 6 mm, material steel 4.8 copper plated

Order No. 11-56-025
Order No. 22-53-004
Order No. 31-5-46-020

3



Threaded studs with flange type PS

	Type	Material	Suitable for stud feeding	
	PS Threaded studs with flange	Steel 4.8 copper plated (suitable for welding)	Manual e.g. 	Automation ¹⁾ e.g. 

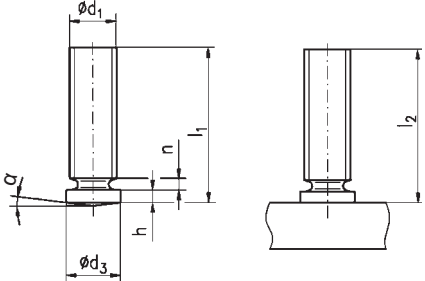
d ₁	l ₁	d ₃ ±0.2	h	n _{max}	α ±1°	
M5	see table	6.0	0.7 - 1.40	1.0	7°	
M6		7.0				
M8		9.0	0.80 - 1.40	1.5		



Length ↓	Diameter →		
	M5	M6	M8
	Order No.	Order No.	Order No.
10 mm	11-55-010*	11-56-010*	--
12 mm	--	--	11-58-012*
15 mm	11-55-015*	11-56-015*	11-58-015*
16 mm	11-55-016*	11-56-016*	11-58-016*
20 mm	11-55-020*	11-56-020*	11-58-020*
25 mm	11-55-025*	11-56-025*	11-58-025*
30 mm	11-55-030*	11-56-030*	11-58-030*
35 mm	--	11-56-035*	11-58-035*
40 mm	--	11-56-040*	11-58-040*
Chuck	82-50-005	82-50-006	82-50-008
			
Chuck	83-51-005	83-51-006	83-51-008
			
Chuck	84-50-005	84-50-006	84-50-008
			

Further accessories see accessories catalogue

* Minimum order quantity, delivery time and price upon request.

Custom dimensions are not listed in the table – HBS manufactures customised welding elements. On request we can provide pricing.

1) For automation: Diameter: M3 to M8 (M10 with modification only)
Stud length: 8 to 40 mm (other lengths on request)

		Type	Material			Suitable for stud feeding	
						Manual	Automation ¹⁾
		PS Threaded studs with flange	A2-50			e.g. 	e.g. 
d_1	l_1					$d_3 \pm 0.2$	h
M5	see table	6.0	0.7 - 1.40	1.0	7°		
M6		7.0					
M8		9.0	0.80 - 1.40	1.5			

		Diameter		
		M5	M6	M8
		Order No.	Order No.	Order No.
Length	10 mm	12-55-010*	12-56-010*	--
	12 mm	--	--	12-58-012*
	15 mm	12-55-015*	12-56-015*	12-58-015*
	16 mm	12-55-016*	12-56-016*	12-58-016*
	20 mm	12-55-020*	12-56-020*	12-58-020*
	25 mm	12-55-025*	12-56-025*	12-58-025*
	30 mm	12-55-030*	12-56-030*	12-58-030*
	35 mm	--	12-56-035*	12-58-035*
	40 mm	--	12-56-040*	12-58-040*
Chuck		82-50-005	82-50-006	82-50-008
				
Chuck		83-51-005	83-51-006	83-51-008
				
Chuck		84-50-005	84-50-006	84-50-008
				

Further accessories see accessories catalogue

* Minimum order quantity, delivery time and price upon request.



Custom dimensions are not listed in the table – HBS manufactures customised welding elements. On request we can provide pricing.

1) For automation: Diameter: M3 to M8 (M10 with modification only)
Stud length: 8 to 40 mm (other lengths on request)

3



Unthreaded studs (pins) with flange type US

	Type	Material	Suitable for stud feeding	
			Manual	Automation ¹⁾
	US Unthreaded studs (pins) with flange*	Steel 4.8 copper plated (suitable for welding) A2-50	e.g. 	e.g. 

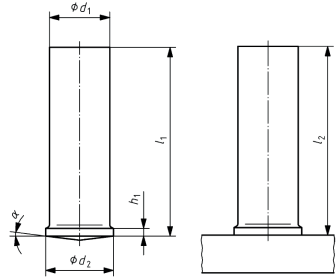
$d_1 \pm 0.1$	l_1	$d_2 \pm 0.2$	h_1	$\alpha \pm 1^\circ$	
3	see table	4	0.7 - 1.40	7°	
4		5			
5		6			
6		7			
7.1		9			
8					

Material	Diameter					
	Ø 3 mm	Ø 4 mm	Ø 5 mm	Ø 6 mm	Ø 7.1 mm	Ø 8 mm
	Order No.	Order No.	Order No.	Order No.	Order No.	Order No.
Steel 4.8 copper plated (suitable for welding)	215-3-XXX	215-4-XXX	215-5-XXX	215-6-XXX	215-7-XXX	215-8-XXX
A2-50	225-3-XXX	225-4-XXX	225-5-XXX	225-6-XXX	225-7-XXX	225-8-XXX
Chuck	82-50-003	82-50-004	82-50-005	82-50-006	82-50-071	82-50-008
						
Chuck	83-51-003	83-51-004	83-51-005	83-51-006	83-51-071	83-51-008
						
Chuck	84-50-003	84-50-004	84-50-005	84-50-006	84-50-071	84-50-008
						

Further accessories see accessories catalogue

* Not in stock, minimum order quantity, delivery time and price upon request. Please send us the article number with your request. In the article number "XXX" is to be replaced by the respective length (e.g. 025 for 25 mm).

Custom dimensions are not listed in the table – HBS manufactures customised welding elements. On request we can provide pricing.

1) For automation: Diameter: 3 to 8 mm
Stud length: 8 to 40 mm (other lengths on request)



	Type		Material			Suitable for stud feeding	
	IS Studs with internal thread and flange*			Steel 4.8 copper plated (suitable for welding) A2-50			Manual e.g.
D_6	l_1	$d_2 \pm 0.2$	$d_1 \pm 0.1$	h_1	$\alpha \pm 1^\circ$		
M3	see table	6.0	5.0	0.7 - 1.40	7°		
M4		7.0	6.0				
M5		9.0	7.1	0.80 - 1.40			
M5			8.0				
M6							

Material	Diameter				
	M3 / Ø 5 mm	M4 / Ø 6 mm	M5 / Ø 7.1 mm	M5 / Ø 8 mm	M6 / Ø 8 mm
	Order No.	Order No.	Order No.	Order No.	Order No.
Steel 4.8 copper plated (suitable for welding)	315-35-XXX	315-46-XXX	315-57-XXX	315-58-XXX	315-68-XXX
A2-50	325-35-XXX	325-46-XXX	325-57-XXX	325-58-XXX	325-68-XXX
Chuck	82-50-905	82-50-906	82-50-971	82-50-908	82-50-908
Chuck	83-51-005	83-51-006	83-51-071	83-51-008	83-51-008
Chuck	84-50-005	84-50-006	84-50-071	84-50-008	84-50-008

Further accessories see accessories catalogue

* Not in stock. Minimum order quantity, delivery time and price upon request.
Please send us the article number with your request. In the article number "XXX" is to be replaced by the respective length (e.g. 025 for 25 mm).

Custom dimensions are not listed in the table – HBS manufactures customised welding elements. On request we can provide pricing.

1) For Automation: Diameter: 3 to 8 mm
Stud length: 8 to 40 mm (other lengths on request)

3



SC Paint clearing threaded studs

		Type			Material		Suitable for stud feeding	
							Manual	Automation ²⁾
		SC Paint clearing threaded studs* 2)			Steel 4.8 copper plated (suitable for welding)		e.g.	e.g.
d ₁	l ₁	d ₂ ±0.2	d ₄ ±0.08	l ₃ ±0.05	h ₁	α ±1°		
M4	see table	5.50	0.65	0.55	0.70 - 1.40	3°		
M5		6.50	0.75	0.80				
M6		7.50	0.75	0.80				
M8		9	0.75	0.85	0.80 - 1.40			

		Diameter	
		M6	M8
Material	Steel 4.8 copper plated (suitable for welding)	Order No. 10-16-XXX	Order No. 10-18-XXX
	Chuck	82-50-006	82-50-008
Chuck	84-50-006	84-50-008	



Further accessories see accessories catalogue







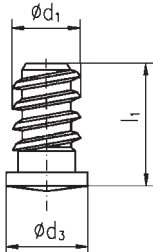

* Minimum order quantity, delivery time and price upon request.

Custom dimensions are not listed in the table – HBS manufactures customised welding elements. On request we can provide pricing.

- 1) For Automation: Diameter: M4 to M8
Stud length: 8 to 40 mm (other lengths on request)
- 2) Similar to DIN EN ISO 13918



	Type		Material		Suitable for stud feeding	
	SC Fir tree studs ²⁾		Steel 4.8 copper plated (suitable for welding) A2-50		Manual e.g. 	Automation ¹⁾ e.g. 
	d ₁	l ₁				
	5.0	9.0				
		14.2				
		18.0				
		25.0				

		Diameter			
		Ø 5 x 9 mm	Ø 5 x 14.2 mm	Ø 5 x 18 mm	Ø 5 x 25 mm
		Order No.	Order No.	Order No.	Order No.
Material ↓	Steel 4.8 copper plated (suitable for welding)	10-25-009	10-25-014	10-25-018	10-25-025
	A2-50	10-45-009	--	--	--
Chuck		82-50-005	82-50-005	82-50-005	82-50-005
					
Chuck		84-50-005	84-50-005	84-50-005	84-50-005
					

Further accessories see accessories catalogue

* Minimum order quantity, delivery time and price upon request.

Custom dimensions are not listed in the table – HBS manufactures customised welding elements. On request we can provide pricing.

1) For automation: Diameter: M4 to M8
Stud length: 8 to 40 mm (other lengths on request)

2) Similar to DIN EN ISO 13918

4

Welding process:

Capacitor discharge stud welding with tip ignition (CD)
Drawn arc stud welding (ARC)

	<p>Welding elements type CD ISO cupped head pins</p> <p>The welding geometry has a process-optimised design. Especially suitable for welding through insulating mats.</p> <div data-bbox="649 551 974 734"><p>Pin not insulated from page 60 Pin insulated from page 61</p></div>
<p>ISO clip ISO nail with ISO clip (not included in delivery)</p>	<p>Welding elements type CD ISO nails</p> <p>Name for an insulation nail. This nail is not standardised. The welding geometry is designed in compliance with DIN EN ISO 13918.</p> <p>Especially suitable for the subsequent attachment of insulating mats.</p> <div data-bbox="649 987 974 1170"><p>4.8 copper plated from page 62 A2-50 from page 63</p></div>
<p>ISO clip ISO pin with ISO clip (not included in delivery)</p>	<p>Welding elements type ARC ISO pins</p> <p>Name for an insulation pin. This pin is not standardised.</p> <p>Especially suitable for the subsequent attachment of insulating mats.</p> <div data-bbox="649 1354 974 1542"><p>4.8 copper plated from page 64 A2-50 from page 64</p></div>

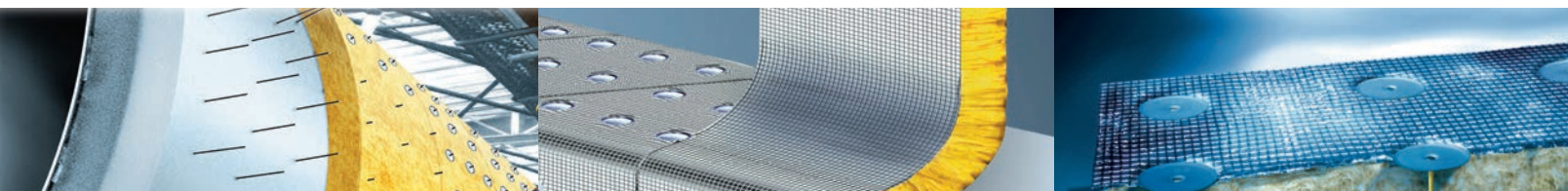

Welding process:

Capacitor discharge stud welding with tip ignition (CD)
 Drawn arc stud welding (ARC)

ISO clips / nail protective caps

Insulation clips are required for securing the insulating mats.

Nail protective caps protect against injury.

from page 65

from page 66

from page 66

Welding elements of type CD bimetallic insulation pins (composite pins)

Composite pins consist of an aluminium blind hole bush with pressed-in insulating pin.

Especially suitable for insulation on an aluminium base material.

4.8 copper plated
from page 67

A2-50
from page 67

1.4571 (A4-50)
from page 67

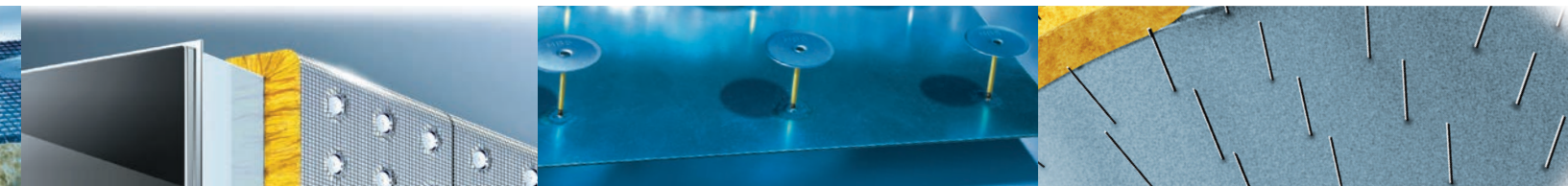

4

Material combinations

according to DIN EN ISO 14555

(Select stud material in a way that material of the same kind is welded.)

Stud material	Base material			
	ISO/TR 15608 Groups 1 to 6, 11.1	ISO/TR 15608 Groups 1 to 6, 11.1 and galvanized and metal plated steel sheets, max. coating thickness 25 µm	ISO/TR 15608 Group 8	ISO/TR 15608 Groups 21 and 22
Steel 4.8 ¹⁾	a	b	a	--
A2-50	a	b	a	--
EN AW-Al99,5	--	--	--	b
EN AW-AlMg3	--	--	--	a
Exemplification of welding suitability: -- non weldable a well suited for any application, e.g. power transmission b suitable, limitations with power transmission				

¹⁾ suitable for welding

Weldability tests of other material combinations upon request.

Quality level

HBS welding stud are supplied according to DIN EN ISO 3269 with quality level (AQL) 1,5.

Excess/minor deliveries

With respect to articles made as per sample or drawing and requiring special manufacture production-related excess/ short deliveries of up to 10 % have to be accepted as delivery according to contract. Exceptions need to be noted explicitly in the order and to be confirmed in writing.

Tolerances

HBS welding studs are supplied according to DIN EN ISO 2768 tolerance class m (medium).

Storage

We recommend to store the welding studs factorypacked. That's how you can avoid irregular welding results caused by humidity, dirt etc.

Due to its corrosion properties, we recommend quick processing.

Please avoid mixing different batches.

Ordering

You make order processing a lot easier if you indicate the order numbers which are part of the price lists.

Welding elements with particular specifications available on request

Order key for cupped head pins

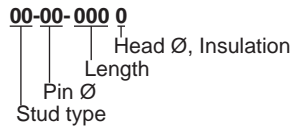

Stud type	
49	Cupped head pin

Pin Ø	
20	2.0 mm
27	2.7 mm

Head Ø, Insulation	
0	Head Ø 30 mm, not insulated
1	Head Ø 38 mm, not insulated
4	Head Ø 30 mm, pin, insulated
5	Head Ø 38 mm, pin, insulated

Order key for CD ISO nails

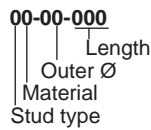

Stud type	
4	Insulation nail

Material	
1	Steel 4.8 copper plated
2	A2-50

Order key for ARC ISO pins

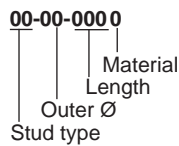

Stud type	
79	Insulation pin

Material	
1	Steel 4.8 copper plated
2	A2-50

Order key for clips

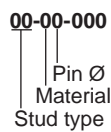

Stud type	
49	Clip

Material	
1	Steel 4.8 galvanized
2	A2-50

Order key for bimetallic insulation pins (sleeve AlMg3)

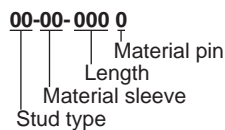

Stud type	
79	Bimetallic insulation pin

Material	
1	Steel 4.8 galvanized
2	A2-50
45	AlMg3 (sleeve)



Order examples: Cupped head pin Ø 2 x 28.6, pin with insulation
 CD ISO nails Ø 2 x 40, material: steel 4.8 copper plated
 ARC ISO pin Ø 3 x 40, material: steel 4.8 copper plated
 Clip Ø 38/Ø 2, four times slotted, material: steel 4.8 galvanized
 Bimetallic insulation pin Ø 3 x 80, material pin: A2-50, material sleeve: AlMg3

Order No. 49-20-0294
Order No. 41-02-040
Order No. 79-13-040 1
Order No. 49-12-001A
Order No. 79-45-0802

4



ISO Cupped head pins

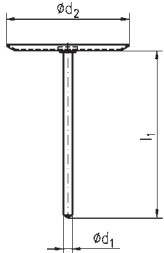

	Type		Material		Suitable for stud feeding
	ISO Cupped head pins (pin not insulated)		Pin: Mild steel 4.8 (suitable for welding) Head: Steel 4.8 galvanized		Manual e.g. 
	d ₁	l ₁	d ₂		
	2	see table	30		
	2.7		38		

Length	Diameter	
	Ø 2 / Ø 30 mm	Ø 2.7 / Ø 38 mm
	Order-No.	Order-No.
9.5 mm	49-20-0100	49-27-0101*
12.7 mm	49-20-0130*	49-27-0131*
19.1 mm	49-20-0190	49-27-0191*
22.2 mm	49-20-0220	49-27-0221*
25.4 mm	49-20-0250	49-27-0251*
28.6 mm	49-20-0290	49-27-0291*
34.9 mm	49-20-0350*	49-27-0351*
38.1 mm	49-20-0380	49-27-0381
41.3 mm	49-20-0410*	49-27-0411
47.6 mm	49-20-0480	49-27-0481
50.8 mm	49-20-0510	49-27-0511
54.0 mm	49-20-0540	49-27-0541*
63.5 mm	--	49-27-0641
73.0 mm	--	49-27-0731
76.2 mm	--	49-27-0761
89.9 mm	--	49-27-0891
101.6 mm	--	49-27-1011
152.4 mm	--	49-27-1511*
Chuck	82-50-310B	82-50-308A
		

Further accessories see accessories catalogue

* Minimum order quantity, delivery time and price upon request.

Custom dimensions are not listed in the table – HBS manufactures customised welding elements. On request we can provide pricing.

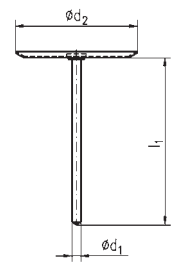
	Type		Material		Suitable for stud feeding
	ISO Cupped head pins (pin insulated)		Pin: Mild steel 4.8 (suitable for welding) Head: Steel 4.8 galvanized		Manual e.g. 
	d ₁	l ₁	d ₂		
	2	see table	30		
	2.7		38		

Length	Diameter	
	Ø 2 / Ø 30 mm	Ø 2.7 / Ø 38 mm
	Order No.	Order No.
9.5 mm	49-20-0104*	49-27-0105*
12.7 mm	49-20-0134*	49-27-0135*
19.1 mm	49-20-0194A	49-27-0195*
22.2 mm	49-20-0224	49-27-0225*
25.4 mm	49-20-0254	49-27-0255*
28.6 mm	49-20-0284	49-27-0295*
34.9 mm	49-20-0354*	49-27-0355*
38.1 mm	49-20-0384A	49-27-0385*
41.3 mm	49-20-0414*	49-27-0415*
47.6 mm	49-20-0474	49-27-0485*
50.8 mm	49-20-0514	49-27-0515*
54.0 mm	49-20-0544	49-27-0545*
63.5 mm	--	49-27-0645
73.0 mm	--	49-27-0735
76.2 mm	--	49-27-0765
89.9 mm	--	49-27-0895
101.6 mm	--	49-27-1015
152.4 mm	--	49-27-1515*
Chuck	82-50-310B	82-50-308A
		

Minimum order quantity, delivery time and price upon request.



* Minimum order quantity, delivery time and price upon request.

Custom dimensions are not listed in the table – HBS manufactures customised welding elements. On request we can provide pricing.

4



CD ISO Nails

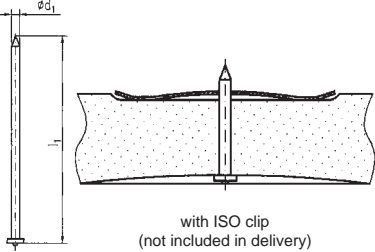

	Type		Material	Suitable for stud feeding
	CD ISO Nails		Steel 4.8 copper plated (suitable for welding)	Manual e.g. 
	d ₁	l ₁		
	2	see table		
	2.6			
	3			

	Diameter		
	Ø 2 mm	Ø 2.6 mm	Ø 3 mm
	Order No.	Order No.	Order No.
20 mm	41-02-020*	41-26-020*	--
30 mm	41-02-030*	41-26-030	41-03-030*
40 mm	41-02-040*	--	41-03-040*
50 mm	41-02-050*	--	41-03-050*
60 mm	41-02-060*	--	41-03-060*
65 mm	41-02-065*	41-26-060*	--
70 mm	41-02-070*	--	41-03-070*
80 mm	41-02-080*	--	41-03-080*
90 mm	41-02-090*	--	41-03-090*
100 mm	41-02-100*	--	41-03-100*
Chuck	82-50-020	82-50-027	82-50-030
			

Further accessories see accessories catalogue

* Minimum order quantity, delivery time and price upon request.

Custom dimensions are not listed in the table – HBS manufactures customised welding elements. On request we can provide pricing.

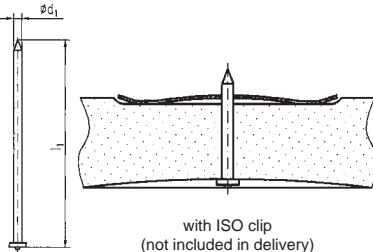
	Type		Material	Suitable for stud feeding
	CD ISO Nails		A2-50	Manual 
	d ₁	l ₁		 with ISO clip (not included in delivery)
	2	see table		
	3			

	Diameter →			
	Ø 2 mm	Ø 2.6 mm	Ø 3 mm	
	Order No.	Order No.	Order No.	
Length ↓	20 mm	42-02-020*	--	--
	30 mm	42-02-030*	--	42-03-030*
	40 mm	42-02-040*	--	42-03-040*
	50 mm	42-02-050*	--	42-03-050*
	60 mm	42-02-060*	--	42-03-060*
	65 mm	42-02-065*	--	--
	70 mm	42-02-070*	--	42-03-070*
	80 mm	42-02-080*	--	42-03-080*
	90 mm	42-02-090*	--	42-03-090*
	100 mm	42-02-100*	--	42-03-100*
	Chuck	82-50-020	82-50-027	82-50-030
				

Further accessories see accessories catalogue

* Minimum order quantity, delivery time and price upon request.







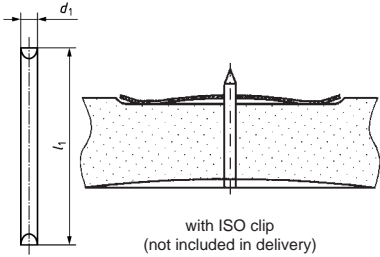

Custom dimensions are not listed in the table – HBS manufactures customised welding elements. On request we can provide pricing.

4

ARC ISO Pins

	Type		Material	Suitable for stud feeding
	ARC ISO Pins		Steel 4.8 copper plated (suitable for welding)	Manual
			A2-50	e.g. 



	d_1	l_1		
	3	see table		
	4			
	5			
	6			

Material	Diameter			
	\varnothing 3 mm	\varnothing 4 mm	\varnothing 5 mm	\varnothing 6 mm
	Order No.	Order No.	Order No.	Order No.
Steel 4.8 copper plated (suitable for welding)	79-13-XXX 1	79-14-XXX 1	79-15-XXX 1	79-16-XXX 1
A2-50	79-13-XXX 2	79-14-XXX 2	79-15-XXX 2	79-16-XXX 2
Chuck for ISO pins up to L = 110 mm	80-04-959	80-04-960	80-04-961	80-04-962
				
Chuck for ISO pins from L = 110 mm	80-05-452	80-05-513	80-04-956	80-04-957
				

Further accessories see accessories catalogue

* Minimum order quantity, delivery time and price upon request.
Please send us the article number with your request. In the article number "XXX" is to be replaced by the respective length (e.g. 025 for 25 mm).

Custom dimensions are not listed in the table – HBS manufactures customised welding elements. On request we can provide pricing.

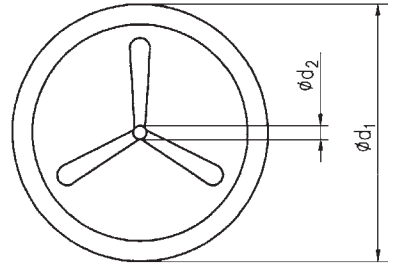
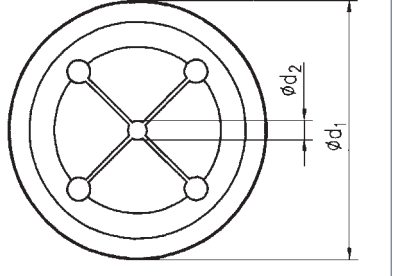
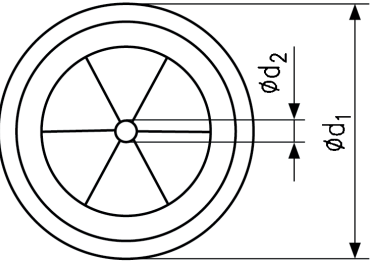
	Type	Material	Suitable for stud feeding
	Clips / Nail protection caps	Steel 4.8 galvanized A2-50	Manual e.g. 
			
3 x slotted ¹⁾		4 x slotted ¹⁾	
		6 x slotted ¹⁾	

		Diameter							
		Ø 38 / Ø 2	Number of Slots	Ø 38 / Ø 3	Number of Slots	Ø 38 / Ø 4	Number of Slots	Ø 38 / Ø 5	Number of Slots
Material	 Steel 4.8 galvanized (suitable for welding)	Order No.		Order No.		Order No.		Order No.	
		49-12-001	6	49-13-001	6	49-14-001	3	49-15-001	3
		49-12-001A	4	49-13-001A	3				
A2-50	49-22-001A	4	49-23-001	3	49-24-001	3	49-25-001	3	
	49-22-001C	6							

		Diameter							
		Ø 30 / Ø 2	Number of Slots	Ø 30 / Ø 3	Number of Slots	Ø 30 / Ø 4	Number of Slots	Ø 30 / Ø 5	Number of Slots
Material	 Steel 4.8 galvanized (suitable for welding)	Order No.		Order No.		Order No.		Order No.	
		--		--		--		--	
		49-22-001	6	--		--		--	

Further accessories see accessories catalogue

* Minimum order quantity, delivery time and price upon request.

Custom dimensions are not listed in the table – HBS manufactures customised welding elements. On request we can provide pricing.

1) = The multiple slot increases the even distribution and reduces the tilting of the clips.

4

Clips / Nail protection caps

	Type	Material	Suitable for stud feeding
	Clips / Nail protection caps	Steel 4.8 galvanized A2-50	Manual e.g.

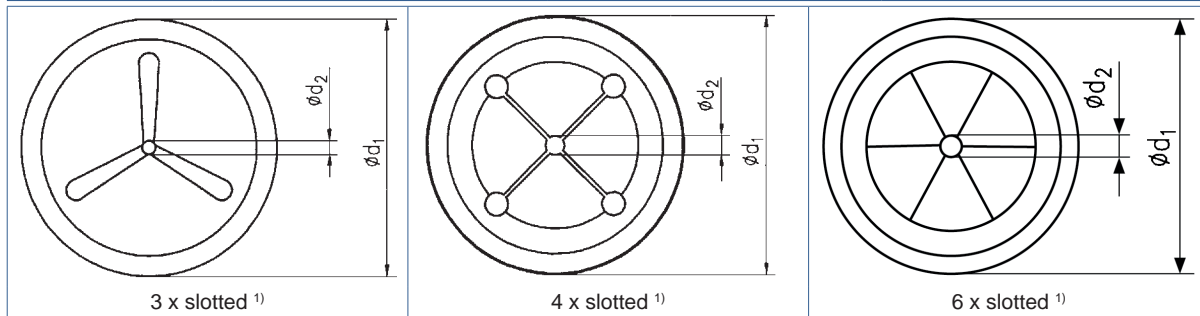

Material	Diameter							
	Ø 38 / Ø 2	Number of Slots	Ø 38 / Ø 3	Number of Slots	Ø 38 / Ø 4	Number of Slots	Ø 30 / Ø 5	Number of Slots
Steel 4.8 galvanized with plastic cap	Order No.		Order No.		Order No.		Order No.	
	49-12-005	3	49-13-005	3	49-14-005	3	--	

Further accessories see accessories catalogue



Material	Length	
	9 mm	14 mm
plastic	Order No.	Order No.
	47-82-001	47-83-001

Further accessories see accessories catalogue

* Minimum order quantity, delivery time and price upon request.

Custom dimensions are not listed in the table – HBS manufactures customised welding elements. On request we can provide pricing.

1) = The multiple slot increases the even distribution and reduces the tilting of the clips.

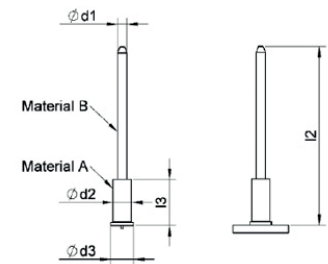
		Type Bimetallic insulation pins			Suitable for stud feeding	
					Manual	
						
d_1	d_2	l_2	Material A (sleeve)	Material B (pin)		
$\varnothing 3$		see table	AlMg3	see table		



Bimetallic insulation pins

		Length →			
		50 mm	60 mm	70 mm	80 mm
		Order No.	Order No.	Order No.	Order No.
Material B ↓	Steel 4.8 (suitable for welding)	79-45-050 1*	79-45-060 1*	79-45-070 1*	79-45-080 1*
	A2-50	79-45-050 2*	79-45-060 2*	79-45-070 2*	79-45-080 2*
	1.4571 (A4-50)	79-45-050 4*	79-45-060 4*	79-45-070 4*	79-45-080 4*
Chuck for insulation pins (with backstop)		80-04-959	80-04-959	80-04-959	80-04-959
					

Further accessories see accessories catalogue

* Minimum order quantity, delivery time and price upon request.

Custom dimensions are not listed in the table – HBS manufactures customised welding elements. On request we can provide pricing.

5

Welding process:

MARC Welding with magnetically positioned light arc

	<p>MARC welding nuts type Hex^{Nut}</p> <p>Name for a hexagon nut according to HBS guidelines</p> <p>60-06-0082 60-08-0082A 60-10-0092 60-12-0112</p> <p>A2-50 from page 70</p>
---	--

Further round and hexagonal nuts on request



Stud types, abbreviations, materials, standards, mechanical characteristics

Materials

The strength of connection parts and, therefore, the mechanical properties of these parts are decisive factors for the user. On the other hand, some applications are subject to increased demands with respect to the optical quality of weld seams as well as more stringent requirements regarding pressure and gas tightness. These properties are not only determined by the welding process but also by the material used.

Nuts and sleeves made of non-rusting stainless steel (A2, A4) have a considerably higher process and functional reliability as well as a longer service life compared to standard steel.

Hexagon nut acc. to DIN 934 / ISO 4032 (A2, A4)

Owing to their geometrical design, these hexagon nuts are suitable for simple fastening tasks. The hexagon nut to DIN 934 only partly takes into account constructional component requirements such as centring and thread consistency as well as the effects of the welding process.

HBS welding nut type Hex^{Nut}

Unlike the hexagon nut to DIN 934 / ISO 4032, the HBS welding nut type Hex^{Nut} has been adapted to the demands of the MARC process. The constructional design features of the HBS welding nut type Hex^{Nut} take into account the ability to centre on through holes as well as continuous smooth threading for all recommended bore diameters. The constructional design of the geometry of the welding element enables a weld seam to be formed which is both pressure-tight and impervious to gas.

Thread

Threads comply with DIN ISO 724, tolerance 6g.

Acceptable quality level

HBS welding elements are delivered in compliance with DIN EN ISO 3269 with acceptable quality level (AQL) 1.5.

Excess/minor deliveries

With respect to articles made as per sample or drawing and requiring special manufacture production-related excess/short deliveries of up to 10 % have to be accepted as delivery according to contract. Exceptions need to be noted explicitly in the order and to be confirmed in writing.

Tolerances

As long as no tolerances are specified for dimensions, form and position welding elements are supplied according to DIN EN ISO 4759-1, product class A.

Storage

We recommend to store the welding elements factorypacked. That's how you can avoid irregular welding results caused by humidity, dirt etc.
Please avoid mixing different batches.

Ordering

You make order processing a lot easier if you indicate the order numbers which are part of the price lists.

Welding elements with particular specifications available on request

5



MARC Welding elements

	Type		Material			Suitable for stud feeding	
	MARC Welding nuts type Hex ^{Nut}		A2-50			Manual	
						e.g. 	















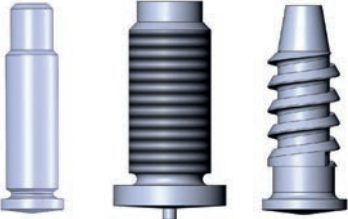

WAF	d1	d2 ^{-0,1} in mm	suitable for d _{hole} ^{+0,1 ...+0,4} in mm	h1 in mm	h2 in mm	
14	M6	10.5	10.6	7.5	8	
14	M8	10.5	10.6	7.5	8	
17	M10	12.5	12.6	8.5	9	
19	M12	14.8	14.9	10.5	11	

Material	Diameter			
	M6	M8	M10	M12
	Order No.	Order No.	Order No.	Order No.
A2-50	60-06-0082*	60-08-0082A*	60-10-0092*	60-12-0112*
Sleeve fixture	88-22-532	88-21-107	88-21-108	88-21-109

Further accessories see accessories catalogue

* Minimum order quantity, delivery time and price upon request.

Welding elements for special applications – examples















	<p>SC collar studs with plastic cap</p> <p>The plastic cap provides protection against mechanical stress, e.g. impacts, and means that the stud does not need to be covered manually prior to painting work.</p> <div style="display: flex; justify-content: space-around; align-items: center;">    </div> <div style="display: flex; justify-content: space-around; align-items: center;"> 10-70-825* 10-70-815* 10-70-612W* </div>
	<p>SC collar studs</p> <p>The nut provides protection if painting is required. The nut can be reused without problem after painting work.</p> <div style="display: flex; justify-content: space-around; align-items: center;">   </div> <div style="display: flex; justify-content: space-around; align-items: center;"> 10-74-815* 10-70-613S* </div>
	<p>ARC break-off pins</p> <p>The geometrical design of a stud as a break-off pin enables comparatively short welding elements to be welded onto components. Extension of the stud allows the stud to be fixed securely in the chuck and a ceramic ferrule to be fed. After welding, the fixing element which is no longer required can be removed by snapping off.</p> <div style="display: flex; justify-content: center; align-items: center;">  </div> <div style="display: flex; justify-content: center; align-items: center;"> 10-08-05020* </div>
	<p>Welding elements with dogpoint</p> <p>The end of the stud can be designed as a so-called dogpoint – a short or long trunnion with flat tip (in compliance with DIN 78, type SD and type LD). This trunnion with reduced shaft diameter serves as a locating aid for the nut which is to be attached, especially in the case of automatic nut feeders.</p> <div style="display: flex; justify-content: space-around; align-items: center;">    </div> <div style="display: flex; justify-content: space-around; align-items: center;"> 12-55-020Z* 12-04-010Z* 10-25-014* </div>
	<p>Large flange studs</p> <p>The large flange permits high torque loads to be transmitted. The transverse grooves in the thread allow excess paint to run off during painting. When the nut is unscrewed after painting, the transverse grooves help remove the excess, dried paint.</p> <div style="display: flex; justify-content: space-around; align-items: center;">    </div> <div style="display: flex; justify-content: space-around; align-items: center;"> 14-56-0185Z* 11-56-013LZ* 10-16-2017Z* </div>

6

Welding elements for special applications – examples



Welding elements for special applications

	<p>T studs</p>	<p>The welding element named after its geometry is welded to the cylindrical shaft. By inserting and engaging, fastening elements made of plastic or metal (e.g. clips, clamps or trim strips) can be locked and guided on the head of the stud. The dimensions of the T stud allow low installation heights and high pull-off forces.</p>
	<p>10-23-054*</p>	
	<p>ARC SC Fir tree studs (special geometry)</p>	
	<p>40-25-0155A*</p>	
	<p>Refractory anchors</p>	
	<p>79-36-0504*</p>	
	<p>Balls</p>	
		
<p>Ø 4: 10-20-004*</p>	<p>Ø 5: 10-20-005*</p>	<p>Ø 6: 10-20-006*</p>
	<p>ARC fixing pins (Fiberfix)</p>	
	<p>79-25-1002*</p>	
	<p>ARC flat anchors</p>	
	<p>79-56-0252*</p>	

Welding elements for special applications – examples

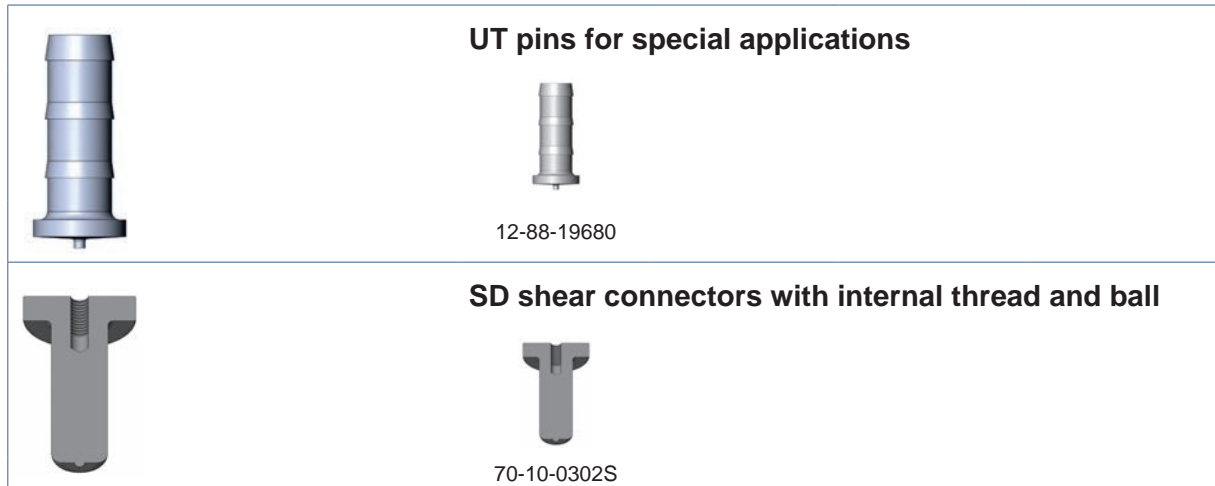

Please do not hesitate to contact us with queries concerning welding elements for your specific application.

HBS Bolzenschweiss-Systeme GmbH & Co. KG
Felix-Wankel-Strasse 18
85221 Dachau
GERMANY
Phone: 08131 511-0
E-Mail: post@hbs-info.com





Leading through Technology, Quality and Service

Welding Elements Catalogue

2016