



Boise Cascade
Engineered Wood Products

WESTERN SPECIFIER GUIDE

for products manufactured in White City, Oregon



WSG 03/14/2013

The SIMPLE FRAMING SYSTEM® Makes Designing Homes Easier

Architects, engineers, and designers trust Boise Cascade's engineered wood products to provide a better system for framing floors and roofs.

It's the SIMPLE FRAMING SYSTEM®, featuring beams, joists and rim boards that work together as a system, so you spend less time cutting and fitting. In fact, the SIMPLE FRAMING SYSTEM® uses fewer pieces and longer lengths than conventional framing, so you'll complete jobs in less time.

You'll Build Better Homes with the SIMPLE FRAMING SYSTEM®

Now it's easier than ever to design and build better floor systems. When you specify the SIMPLE FRAMING SYSTEM®, your clients will have fewer problems with squeaky floors and ceiling gypsum board cracks. The SIMPLE FRAMING SYSTEM® also means overall better floor and roof framing than dimension lumber allows.

Better Framing Doesn't Have to Cost More

Boise Cascade Engineered Wood Products' SIMPLE FRAMING SYSTEM® often costs less than

conventional framing methods when the resulting reduced labor and materials waste are considered. There's less sorting and cost associated with disposing of waste because you order only what you need. Although our longer lengths help your clients get the job done faster, they cost no more.

Environmentally Sound

As an added bonus, floor and roof systems built with BCI® Joists require about half the number of trees as those built with dimension lumber. This helps you design a home both you and future generations will be proud to own.

What Makes the SIMPLE FRAMING SYSTEM® So Simple?

☑ Floor and Roof Framing with BCI® Joists

Light in weight, but heavy-duty, BCI® Joists have a better strength / weight ratio than dimension lumber. Knockouts can be removed for

cross-ventilation and wiring.

☑ Ceilings Framed with BCI® Joists

The consistent size of BCI® Joists helps keep gypsum board flat and free of unsightly nail pops and ugly shadows, while keeping finish work to a minimum.

☑ VERSA-LAM® Beams for Floor and Roof Framing

These highly-stable beams are free of the large-scale defects that plague dimension beams. The result is quieter, flatter floors (no camber) and no shrinkage-related call-backs.

☑ Boise Cascade Rimboard

Boise Cascade Engineered Wood Products offer several engineered rimboard products regionally, including BC RIM BOARD® OSB, VERSA-RIM®, VERSA-STRAND™ 0.8 and VERSA-LAM® 1.4 1800 (check supplier or Boise Cascade EWP rep for availability). These products work with BCI® Joists to provide a solid connection at the critical floor/wall intersection.

Product Profiles, BCI® Specifications	3
BCI® Residential Floor Span Tables, About Floor Performance, One Hour Floor/Ceiling Assembly	4
BCI® Floor Framing Details	5 - 6
BCI® Joist Hole Location and Sizing	7
BCI® Cantilever Details, Web Stiffener Requirements	8 - 9
BCI® Floor Load Tables	10 - 12
BCI® Roof Framing Details	13 - 14
BCI® Roof Span Tables	15 - 18
BCI® Roof Load Tables	19 - 23
BCI® Design Properties, BCI® Allowable Nail Spacing	24
Boise Cascade Rimboard Products	25

VERSA-LAM® Products, Specifications, Allowable Holes	26
VERSA-LAM® Details, Multiple Member Connectors	27
VERSA-LAM® Floor Load Tables (100% Load Duration)	28
VERSA-LAM® Snow Roof Load Tables (115% Load Duration)	29
VERSA-LAM® Non-Snow Roof Load Tables (125% Load Duration)	30
VERSA-LAM® Closest Allowable Nail Spacing	31
VERSA-LAM® Design Values	31
VERSA-LAM® Columns, VERSA-STUD®	32
Computer Software	33
Framing Connectors	34 - 35
Lifetime Guarantee	Back Cover

BCI® Joists

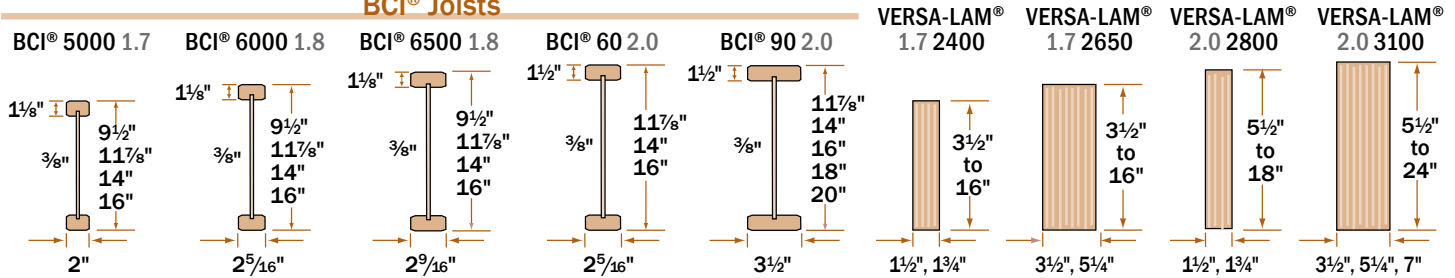

Some products may not be available in all markets. Contact your Boise Cascade EWP representative for availability. BCI® and VERSA-LAM® products shall be installed in dry-use applications only, per their respective ICC ESR evaluation reports.



BCI® Joist Architectural Specifications

Scope: This work includes the complete furnishing and installation of all BCI® Joists as shown on the drawings, herein specified and necessary to complete the work.

Materials: BCI® Joists shall be manufactured by Boise Cascade Engineered Wood Products with oriented strand board webs, VERSA-LAM® laminated veneer lumber flanges and waterproof, structural adhesives.

Joist webs shall be graded Structural I Exposure 1 by an agency listed by a model code evaluation service. Strands on the face layers of the web panels shall be oriented vertically in the joist. The web panels shall be glued together to form a continuous web member. The web panels shall be machined to fit into a groove in the center of the wide face of the flange members so as to form a pressed glue joint at that junction.

Design: The BCI® Joists shall be sized and detailed to fit the dimensions and loads indicated on the plans. All designs shall be in accordance with allowable values and section properties developed in accordance with ASTM D5055 and listed in the governing code evaluation service's report.

Drawing: Additional drawings showing layout and detail necessary for determining fit and placement in the building are (are not) to be provided by the supplier.

Fabrication: The BCI® Joists and section properties shall be manufactured in a plant evaluated for fabrication by the governing code evaluation service and under the supervision of a third-party inspection agency listed by the corresponding evaluation service.

Storage and Installation: The BCI® Joists, if stored prior to erection, shall be stored in a vertical and level position and protected from the weather. They shall be handled with care so they are not damaged.

The BCI® Joists are to be installed in accordance with the plans and the Boise Cascade Engineered Wood Products Installation Guide. Temporary construction loads which cause stresses beyond design limits are not permitted. Erection bracing shall be provided to keep the BCI® Joists straight and plumb as required and to assure adequate lateral support for the individual BCI® Joists and the entire system until the sheathing material has been applied.

Codes: The BCI® Joists shall be evaluated by a model code evaluation service.

Residential Floor Span Tables

About Floor Performance

Homeowner's expectations and opinions vary greatly due to the subjective nature of rating a new floor. Communication with the ultimate end user to determine their expectation is critical. **Vibration** is usually the cause of most complaints. Installing lateral bridging may help; however, squeaks may occur if not installed properly. Spacing the joists closer together does little to affect the perception of the floor's performance. The most common methods used to increase the performance and reduce vibration of wood floor systems is to

increase the joist depth, limit joist deflections, glue and screw a thicker, tongue-and-groove subfloor, install the joists vertically plumb with level-bearing supports, and install a direct-attached ceiling to the bottom flanges of the joists.

The floor span tables listed below offer three very different performance options, based on performance requirements of the homeowner.

Joist Depth	BCI® Joist Series	★★★THREE STAR★★★					★★★★FOUR STAR★★★★					CAUTION ★ MINIMUM STIFFNESS ALLOWED BY CODE ★ CAUTION				
		12" o.c.	16" o.c.	19.2" o.c.	24" o.c.	32" o.c.	12" o.c.	16" o.c.	19.2" o.c.	24" o.c.	32" o.c.	12" o.c.	16" o.c.	19.2" o.c.	24" o.c.	32" o.c.
9½"	5000 1.7	17'-1"	15'-7"	14'-9"	13'-9"	12'-0"	11'-6"	11'-6"	10'-0"	10'-0"	9'-6"	18'-11"	17'-0"	15'-6"	13'-11"	12'-0"
	6000 1.8	17'-11"	16'-5"	15'-6"	14'-5"	13'-2"	11'-6"	11'-6"	10'-0"	10'-0"	9'-10"	19'-10"	18'-2"	17'-2"	15'-9"	13'-8"
	6500 1.8	18'-5"	16'-10"	15'-11"	14'-10"	13'-6"	11'-6"	11'-6"	10'-0"	10'-0"	10'-0"	20'-5"	18'-8"	17'-8"	16'-5"	14'-3"
11⅞"	5000 1.7	20'-2"	18'-5"	17'-5"	15'-9"	13'-4"	15'-6"	14'-4"	13'-6"	12'-7"	11'-5"	22'-3"	19'-4"	17'-7"	15'-9"	13'-4"
	6000 1.8	21'-3"	19'-5"	18'-4"	17'-1"	14'-10"	15'-6"	15'-1"	14'-3"	13'-3"	12'-0"	23'-6"	21'-6"	20'-0"	17'-11"	14'-10"
	6500 1.8	21'-11"	20'-0"	18'-11"	17'-7"	14'-10"	16'-0"	15'-7"	14'-9"	13'-8"	12'-5"	24'-3"	22'-2"	20'-11"	18'-10"	14'-10"
	60 2.0	23'-3"	21'-3"	20'-1"	18'-8"	16'-4"	18'-0"	16'-7"	15'-7"	14'-6"	13'-2"	25'-9"	23'-6"	22'-3"	20'-9"	16'-4"
	90 2.0	26'-3"	23'-11"	22'-6"	20'-11"	19'-1"	19'-0"	18'-7"	17'-6"	16'-2"	14'-8"	29'-0"	26'-6"	25'-0"	23'-3"	19'-4"
14"	5000 1.7	22'-11"	21'-0"	19'-2"	17'-2"	13'-11"	18'-0"	16'-5"	15'-6"	14'-5"	13'-1"	24'-4"	21'-0"	19'-2"	17'-2"	13'-11"
	6000 1.8	24'-2"	22'-2"	20'-11"	19'-6"	15'-5"	18'-11"	17'-3"	16'-3"	15'-2"	13'-9"	26'-9"	23'-11"	21'-10"	19'-6"	15'-5"
	6500 1.8	24'-10"	22'-9"	21'-5"	20'-0"	15'-5"	19'-5"	17'-9"	16'-8"	15'-6"	14'-1"	27'-6"	25'-1"	22'-11"	20'-6"	15'-5"
	60 2.0	26'-5"	24'-2"	22'-9"	21'-3"	16'-4"	20'-8"	18'-10"	17'-9"	16'-5"	14'-11"	29'-3"	26'-8"	25'-3"	21'-10"	16'-4"
	90 2.0	29'-9"	27'-1"	25'-6"	23'-8"	19'-6"	23'-3"	21'-1"	19'-9"	18'-4"	16'-7"	32'-10"	30'-0"	28'-3"	26'-0"	19'-6"
16"	6000 1.8	26'-9"	24'-5"	23'-1"	20'-10"	15'-9"	20'-11"	19'-1"	18'-0"	16'-9"	15'-2"	29'-6"	25'-6"	23'-4"	20'-10"	15'-9"
	6500 1.8	27'-5"	25'-1"	23'-8"	21'-1"	15'-9"	21'-6"	19'-7"	18'-5"	17'-2"	15'-7"	30'-4"	26'-11"	24'-6"	21'-1"	15'-9"
	60 2.0	29'-3"	26'-8"	25'-2"	21'-10"	16'-4"	22'-10"	20'-10"	19'-7"	18'-2"	16'-4"	32'-4"	29'-6"	27'-4"	21'-10"	16'-4"
	90 2.0	32'-11"	29'-11"	28'-2"	26'-2"	19'-7"	25'-8"	23'-4"	21'-11"	20'-3"	18'-4"	36'-4"	33'-2"	31'-3"	26'-2"	19'-7"
18"	90 2.0	35'-11"	32'-8"	30'-9"	28'-7"	23'-10"	28'-1"	25'-5"	23'-11"	22'-2"	20'-0"	39'-8"	36'-2"	34'-1"	31'-9"	23'-10"
20"	90 2.0	38'-10"	35'-4"	33'-4"	30'-11"	24'-8"	30'-4"	27'-6"	25'-11"	24'-0"	21'-8"	42'-11"	39'-1"	36'-10"	32'-11"	24'-8"

- Table values based on residential floor loads of 40 psf live load and 10 psf dead load (12 psf dead load for BCI® 90 2.0 joists).
- Span values assume 23/32" min plywood/OSB rated sheathing is glued and nailed to joists for composite action (joists spaced at 32" o.c. require sheathing rated for such spacing - 7/8" plywood/OSB).
- Table values represent the most restrictive of simple or multiple span applications.
- Table values are the maximum allowable clear distance between supports.

- Table values assume minimum bearing lengths without web stiffeners for joist depths of 16" inches and less (18" & 20" joists require web stiffeners at all bearing locations).
- Floor tile will increase dead load and may require specific deflection limits, contact Boise Cascade EWP Engineering for further information.
- This table was designed to apply to a broad range of applications. It may be possible to exceed the limitations of this table by analyzing a specific application with the BC CALC® sizing software.

One-Hour Fire Resistive Assembly

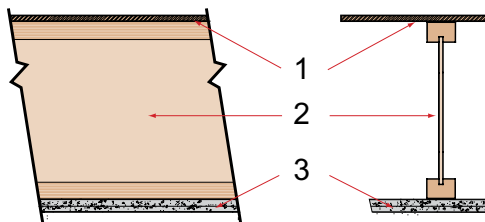

ICC ESR 1336

FIRE ASSEMBLY COMPONENTS

1. Min. 23/32" thick tongue and groove sheathing (exterior glue), installed with long edge perpendicular to joist length, staggered one joist spacing with adjacent sheets, and glued to joists with construction adhesive.
2. BCI® Joists at 24" o.c. or less.
3. Two layers 5/8" Type X or two layers 1/2" Type C gypsum board, installed per Figures 2 or 3 of ICC ESR 1336.

SOUND ASSEMBLY COMPONENTS

When constructed with resilient channels

- Add carpet & pad to fire assembly:
- Add 3/2" glass fiber insulation to fire assembly:
- Add an additional layer of minimum 5/8" sheathing and 9 1/2" glass fiber insulation to fire assembly:

STC=54	IIC=68	or
STC=55	IIC=46	
STC=61	IIC=50	or

See Boise Cascade Fire Design & Installation Guide - US version for specific specific assembly information and other fire resistive options or contact your local Boise Cascade representative.

NOTE

The illustration below is showing several suggested applications for the Boise Cascade EWP products. It is not intended to show an actual house under construction.

BCI® Joist block or 2x4 "squash" block on each side required when supporting a load-bearing wall above.

When installing Boise Cascade EWP products with treated wood, use only connectors/fasteners that are approved for use with the corresponding wood treatment.

NO MIDSPAN BRIDGING IS REQUIRED FOR BCI® JOISTS

FOR INSTALLATION STABILITY, Temporary strut lines (1x4 min.) 8' on center max. Fasten at each joist with 2-8d nails minimum.

Dimension lumber is not suitable for use as a rim board in BCI® floor systems.

BCI® rim joist. See page 6.

Boise Cascade Rimboard. See pages 6 and 25.

For load bearing cantilever details, see page 9.

VERSA-LAM® header or a BCI® Joist header.

1½" knockout holes at approximately 12" o.c. are pre-punched.

See page 7 for allowable hole sizes and location.

VERSA-LAM® LVL beam.

Endwall blocking as required per governing building code.

BCI® Joist Blocking is required when BCI® Joists are cantilevered.

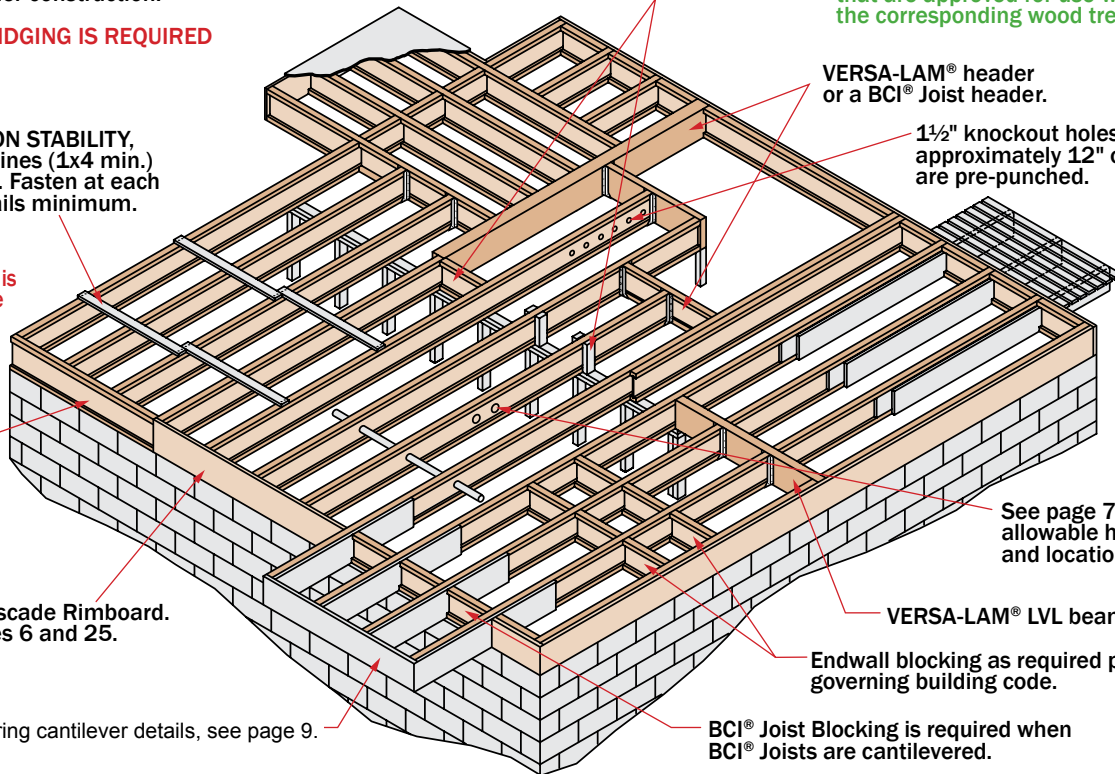

BCI® Joists, VERSA-LAM® and ALLJOIST® must be stored, installed and used in accordance with the Boise Cascade EWP Installation Guide, building codes, and to the extent not inconsistent with the Boise Cascade EWP Installation Guide, usual and customary building practices and standards. VERSA-LAM®, ALLJOIST®, and BCI® Joists must be wrapped, covered, and stored off of the ground on stickers at all times prior to installation. VERSA-

LAM®, ALLJOIST® and BCI® Joists are intended only for applications that assure no exposure to weather or the elements and an environment that is free from moisture from any source, or any pest, organism or substance which degrades or damages wood or glue bonds. Failure to correctly store, use or install VERSA-LAM®, ALLJOIST®, and BCI® Joist in accordance with the Boise Cascade EWP Installation Guide will void the limited warranty.

SAFETY WARNING

DO NOT ALLOW WORKERS ON BCI® JOISTS UNTIL ALL HANGERS, BCI® RIM JOISTS, RIM BOARDS, BCI® BLOCKING PANELS, X-BRACING AND TEMPORARY 1x4 STRUT LINES ARE INSTALLED AS SPECIFIED BELOW. SERIOUS ACCIDENTS CAN RESULT FROM INSUFFICIENT ATTENTION TO PROPER BRACING DURING CONSTRUCTION. ACCIDENTS CAN BE AVOIDED UNDER NORMAL CONDITIONS BY FOLLOWING THESE GUIDELINES:

- Build a braced end wall at the end of the bay, or permanently install the first eight feet of BCI® Joists and the first course of sheathing. As an alternate, temporary sheathing may be nailed to the first four feet of BCI® Joists at the end of the bay.
- All hangers, BCI® rim joists, rim boards, BCI® blocking panels, and x-bracing must be completely installed and properly nailed as each BCI® Joist is set.
- Install temporary 1x4 strut lines at no more than eight feet on center as additional BCI® Joists are set. Nail the strut lines to the sheathed area, or braced end wall, and to each BCI® Joist with two 8d nails.
- The ends of cantilevers must be temporarily secured by strut lines on both the top and bottom flanges.
- Straighten the BCI® Joists to within 1/2 inch of true alignment before attaching strut lines and sheathing.
- Remove the temporary strut lines only as required to install the permanent sheathing.
- Failure to install temporary bracing may result in sideways buckling or roll-over under light construction loads.
- Do not stack construction materials (sheathing, drywall, etc) in the middle of BCI Joist spans, contact Boise Cascade EWP Engineering for proper storage and shoring information.



Additional floor framing details available with BC FRAMER® software (see page 33)

END BEARING DETAILS

F07

Nail Boise Cascade Rimboard to BCI® Joists with 8d nail into each flange. Dimension lumber is not suitable for use as rim board with BCI® Joists.

F07A

Dimension lumber is not suitable for use as rim board with BCI® Joists.

F02

BCI® rim joist.

F01

BCI® Joist blocking.

F27A

Top Flange or Face Mount Joist Hanger
VERSA-LAM®

F52

One 8d nail each side at bearing
1 1/2" minimum bearing length
To limit splitting flange, start nails at least 1 1/2" from end. Nails may need to be driven at an angle to limit splitting of bearing plate.

F08

Solid block all posts from above to bearing below.

F03

BCI® rim joist.

Note: BCI® floor joist must be designed to carry wall above when not stacked over wall below.

INTERMEDIATE BEARING DETAILS

F06

For load bearing wall above (stacked over wall below).

BCI® Joist blocking.

F09

Blocking may be required at intermediate bearings for floor diaphragm per IRC in high seismic areas, consult local building official.

Load bearing wall above (stacked over wall below)
2x block.

F28

Floor Joist Blocking per IRC 502.7 Required in seismic design categories D₀ and higher for floor diaphragm (required for all joist types).

Intermediate Bearing.
Cross bracing OK as blocking only if support below is not a braced wall panel or shear wall and no wall exists above.

F14

BCI® Joist Slope Cut Reinforcement
Detail below restores original allowable shear/reaction value to cut end of BCI® joist. BCI® Joist shall not be used as a collar or rafter tension tie.
2 x 6 min. rafter. Rafter shall be supported by ridge beam or other upper bearing support.

Heel Depth (see table below)
6 min, 12, 16" max. BCI® depth, 24"

F10

Backer block (minimum 12" wide). Nail with 10-10d nails.

Joist Hanger
Backer block (minimum 12" wide). Nail with 10-10d nails.
Filler block. Nail with 10-10d nails.

Backer block required where top flange joist hanger load exceeds 250 lbs. Install tight to top flange.

F58

Double BCI® Joist Connection

Filler Block (see chart below)
Web-Filler Nailing 12" on-center

Connection valid for all applications. Contact Boise Cascade EWP Engineering for specific conditions.

F05

Sheathing or rimboard closure

BCI® Joist blocking required for cantilever.

For load bearing cantilever, see pages 8 and 9. Uplift on backspan shall be considered in all cantilever designs.

End Wall Bearing	Minimum Heel Depth					
	Roof Pitch					
	6/12	7/12	8/12	9/12	10/12	12/12
2 x 4	4 3/8"	4 5/8"	4 3/4"	4 1/4"	4 1/4"	4 1/4"
2 x 6	3 3/8"	3 3/8"	2 5/8"	2 7/8"	2 9/16"	2 1/4"

LATERAL SUPPORT

- BCI® Joists shall be laterally supported at the ends with hangers, rimboard, BCI® rim joist or blocking panels. BCI® blocking panels or rimboard are required at cantilever supports.
- Blocking may be required at intermediate bearings for floor diaphragm per IRC in high seismic areas, consult local building official.

MINIMUM BEARING LENGTH FOR BCI® JOISTS

- Minimum Bearing Lengths: 1 1/2" end bearing, 3 1/2" intermediate and adjacent cantilever bearing.
- Longer bearing lengths allow higher reaction values. Refer to the building code evaluation report or the BC CALC® software.

NAILING REQUIREMENTS

- BCI® rim joist, rim board or closure panel to BCI® joist:
 - Rims or closure panel 1 3/4 inches thick and less: 2-8d nails, one each in the top and bottom flange.
 - BCI® 5000 rim joist: 2-10d box nails, one each in the top and bottom flange.
 - BCI® 6000, 60 rim joist: 2-16d box nails, one each in the top and bottom flange.
 - BCI® 6500, 90 rim joist: Toe-nail top flange to rim joist with 2-10d box nails, one each side of flange.
- BCI® rim joist, rim board or BCI® blocking panel to support:
 - Min. 8d nails @ 6" o.c. per IRC.
 - Connection per design professional of record's specification for shear transfer.

- BCI® joist to support:
 - 2-8d nails, one on each side of the web, placed 1 1/2 inches minimum from the end of the BCI® Joist to limit splitting.
- Sheathing to BCI® joist:
 - Prescriptive residential floor sheathing nailing requires 8d common nails @ 6" o.c. on edges and @ 12" o.c. in the field (IRC Table R602.3(1)).
 - See closest allowable nail spacing limits on page 24 for floor diaphragm nailing specified at closer spacing than IRC.
 - Maximum nail spacing for minimum lateral stability: 18" for BCI® 5000, 24" for larger BCI® joist series.
 - 14 gauge staples may be substituted for 8d nails if the staples penetrate at least 1 inch into the joist.
 - Wood screws may be acceptable, contact local building official and/or Boise Cascade EWP Engineering for further information.

BACKER AND FILLER BLOCK DIMENSIONS

Series	Backer Block Thickness	Filler Block Thickness
5000 1.7	3/4" or 7/8" wood panels	Two 3/4" wood panels or 2x_
6000 1.8	1 1/8" or two 1/2" wood panels	2x_ + 7/16" or 1/2" wood panel
6500 1.8	1 1/8" or two 3/8" wood panels	2x_ + 5/8" or 3/4" wood panel
60 2.0	1 1/8" or two 1/2" wood panels	2x_ + 7/16" or 1/2" wood panel
90 2.0	2x_ lumber	Double 2x_ lumber

- Cut backer and filler blocks to a maximum depth equal to the web depth minus 1/4" to avoid a forced fit.

BCI® RIM JOISTS AND BCI® BLOCKING

Depth [in]	Series	Vertical Load Capacity	
		No W.S. ⁽¹⁾	W.S. ⁽²⁾
9 1/2"	5000 1.7, 6000 1.8, 6500 1.8	2300	N/A
	60 2.0, 90 2.0	2500	N/A
11 1/8"	5000 1.7, 6000 1.8, 6500 1.8	2150	N/A
	60 2.0, 90 2.0	2500	N/A
14"	5000 1.7, 6000 1.8, 6500 1.8	2000	N/A
	60 2.0, 90 2.0	2400	N/A
16"	6000 1.8, 6500 1.8	1900	2500
	60 2.0, 90 2.0	2300	2700
18"	60 2.0, 90 2.0	N/A	2700
20"	90 2.0	N/A	2700

- No web stiffeners required
 - Web stiffeners required at each end of blocking, values not applicable for rim joists
- N/A: Not applicable

WEB STIFFENER REQUIREMENTS

- See Web Stiffener Requirements on page 9.

PROTECT BCI® JOISTS FROM THE WEATHER

- BCI® Joists are intended only for applications that provide permanent protection from the weather. Bundles of BCI® Joists should be covered and stored off of the ground on stickers.

BCI® Joists are manufactured with 1/2" round perforated knockouts in the web at approximately 12" on center

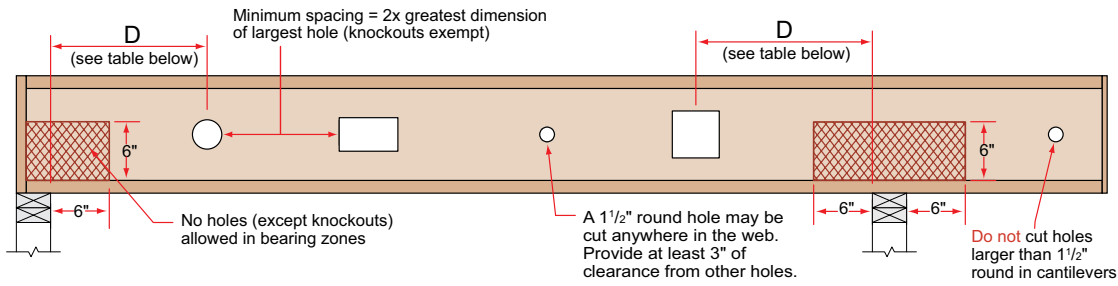

DO NOT cut or notch flange

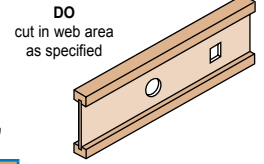
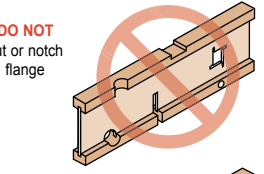

DO cut in web area as specified

Minimum distance from support, listed in table below, is required for all holes greater than 1 1/2"

MINIMUM DISTANCE (D) FROM ANY SUPPORT TO THE CENTERLINE OF THE HOLE																
Round Hole Diameter [in]		2	3	4	5	6	7	8	8 7/8	10	11	12	13	14	15	
Rectangular Hole Side [in]		-	-	-	3	5	7	-	-	-	-	-	-	-	-	
Any 9 1/2" Joist	Span [ft]	8	1'-0"	1'-1"	1'-8"	2'-4"	2'-11"	3'-7"								
		12	1'-0"	1'-7"	2'-7"	3'-6"	4'-5"	5'-4"								
		16	1'-0"	2'-2"	3'-5"	4'-8"	5'-11"	7'-2"								
Round Hole Diameter [in]		2	3	4	5	6	7	8	8 7/8	10	11	12	13	14	15	
Rectangular Hole Side [in]		-	-	-	2	3	5	7	8	-	-	-	-	-	-	
Any 11 1/8" Joist	Span [ft]	8	1'-0"	1'-1"	1'-6"	2'-0"	2'-5"	2'-11"	3'-5"	3'-10"						
		12	1'-0"	1'-7"	2'-3"	3'-0"	3'-8"	4'-5"	5'-1"	5'-9"						
		16	1'-2"	2'-1"	3'-0"	4'-0"	4'-11"	5'-10"	6'-10"	7'-8"						
		20	1'-5"	2'-7"	3'-10"	5'-0"	6'-2"	7'-4"	8'-6"	9'-7"						
Round Hole Diameter [in]		2	3	4	5	6	7	8	8 7/8	10	11	12	13	14	15	
Rectangular Hole Side [in]		-	-	-	-	2	3	5	6	8	9	-	-	-	-	
Any 14" Joist	Span [ft]	8	1'-0"	1'-1"	1'-2"	1'-2"	1'-6"	1'-11"	2'-4"	2'-9"	3'-3"	3'-8"				
		12	1'-0"	1'-1"	1'-2"	1'-7"	2'-3"	2'-11"	3'-6"	4'-1"	4'-10"	5'-6"				
		16	1'-0"	1'-1"	1'-3"	2'-2"	3'-0"	3'-10"	4'-9"	5'-6"	6'-6"	7'-4"				
		20	1'-0"	1'-1"	1'-7"	2'-8"	3'-9"	4'-10"	5'-11"	6'-10"	8'-1"	9'-2"				
		24	1'-0"	1'-1"	1'-11"	3'-3"	4'-6"	5'-10"	7'-1"	8'-3"	9'-9"	11'-0"				
Round Hole Diameter [in]		2	3	4	5	6	7	8	8 7/8	10	11	12	13	14	15	
Rectangular Hole Side [in]		-	-	-	-	-	2	3	5	6	8	9	10	-	-	
Any 16" Joist	Span [ft]	8	1'-0"	1'-1"	1'-2"	1'-2"	1'-3"	1'-3"	1'-7"	1'-11"	2'-4"	2'-9"	3'-2"	3'-7"		
		12	1'-0"	1'-1"	1'-2"	1'-2"	1'-3"	1'-9"	2'-4"	2'-11"	3'-7"	4'-2"	4'-9"	5'-4"		
		16	1'-0"	1'-1"	1'-2"	1'-2"	1'-7"	2'-5"	3'-2"	3'-10"	4'-9"	5'-7"	6'-4"	7'-2"		
		20	1'-0"	1'-1"	1'-2"	1'-2"	2'-0"	3'-0"	4'-0"	4'-10"	5'-11"	6'-11"	7'-11"	8'-11"		
		24	1'-0"	1'-1"	1'-2"	1'-3"	2'-5"	3'-7"	4'-9"	5'-10"	7'-2"	8'-4"	9'-6"	10'-9"		
Round Hole Diameter [in]		2	3	4	5	6	7	8	8 7/8	10	11	12	13	14	15	
Rectangular Hole Side [in]		-	-	-	-	-	-	2	3	5	6	7	9	10	11	
18" BCI® 90 2.0 Joist	Span [ft]	12	1'-0"	1'-1"	1'-2"	1'-2"	1'-5"	1'-11"	2'-4"	2'-9"	3'-3"	3'-9"	4'-2"	4'-8"	5'-1"	5'-7"
		16	1'-0"	1'-1"	1'-2"	1'-4"	1'-11"	2'-7"	3'-2"	3'-8"	4'-5"	5'-0"	5'-7"	6'-3"	6'-10"	7'-5"
		20	1'-0"	1'-1"	1'-2"	1'-8"	2'-5"	3'-3"	4'-0"	4'-8"	5'-6"	6'-3"	7'-0"	7'-9"	8'-7"	9'-4"
		24	1'-0"	1'-1"	1'-2"	2'-0"	2'-11"	3'-10"	4'-9"	5'-7"	6'-7"	7'-6"	8'-5"	9'-4"	10'-3"	11'-2"
		28	1'-0"	1'-1"	1'-4"	2'-5"	3'-5"	4'-6"	5'-7"	6'-6"	7'-9"	8'-9"	9'-10"	10'-11"	12'-0"	13'-1"
Round Hole Diameter [in]		2	3	4	5	6	7	8	8 7/8	10	11	12	13	14	15	
Rectangular Hole Side [in]		-	-	-	-	-	-	-	2	3	5	6	7	8	10	
20" BCI® 90 2.0 Joist	Span [ft]	12	1'-0"	1'-1"	1'-2"	1'-2"	1'-3"	1'-6"	1'-11"	2'-3"	2'-9"	3'-2"	3'-7"	3'-11"	4'-4"	4'-9"
		16	1'-0"	1'-1"	1'-2"	1'-2"	1'-6"	2'-1"	2'-7"	3'-1"	3'-8"	4'-3"	4'-9"	5'-3"	5'-10"	6'-4"
		20	1'-0"	1'-1"	1'-2"	1'-3"	1'-11"	2'-7"	3'-3"	3'-10"	4'-7"	5'-3"	5'-11"	6'-7"	7'-4"	8'-0"
		24	1'-0"	1'-1"	1'-2"	1'-6"	2'-4"	3'-1"	3'-11"	4'-7"	5'-6"	6'-4"	7'-2"	7'-11"	8'-9"	9'-7"
		28	1'-0"	1'-1"	1'-2"	1'-9"	2'-8"	3'-8"	4'-7"	5'-5"	6'-6"	7'-5"	8'-4"	9'-3"	10'-3"	11'-2"

- Select a table row based on joist depth and the actual joist span rounded up to the nearest table span. Scan across the row to the column headed by the appropriate round hole diameter or rectangular hole side. Use the longest side of a rectangular hole. The table value is the closest that the centerline of the hole may be to the centerline of the nearest support.
- The entire web may be cut out. **DO NOT** cut the flanges. Holes apply to either single or multiple joists in repetitive member conditions.
- For multiple holes, the amount of uncut web between holes must equal at least twice the diameter (or longest side) of the largest hole.
- 1/2" round knockouts in the web may be removed by using a short piece of metal pipe and hammer.
- Holes may be positioned vertically anywhere in the web. The joist may be set with the 1/2" knockout holes turned either up or down.
- This table was designed to apply to the design conditions covered by tables elsewhere in this publication. Use the BC CALC® software to check other hole sizes or holes under other design conditions. It may be possible to exceed the limitations of this table by analyzing a specific application with the BC CALC® software.

Reinforced Load Bearing Cantilever Table

KEY TO TABLE

0 No Reinforcement Required
 WS Web Stiffeners at Support

BCI® Joists

1 Web Stiffeners Plus One Reinforcer
 2 Web Stiffeners Plus Two Reinforcers
 X Use Deeper Joists or Closer Spacing

Joist Depth [in]	Joist Series	Roof Truss Span [ft]	Roof Total Load [psf]									
			35			45			55			
			Joist Spacing [in]			Joist Spacing [in]			Joist Spacing [in]			
			16	19.2	24	16	19.2	24	16	19.2	24	
9 1/2"	5000	1.7	24	0	0	0	0	0	X	0	X	X
			26	0	0	0	0	0	X	0	X	X
			28	0	0	X	0	0	X	0	X	X
			30	0	0	X	0	X	X	X	X	X
			32	0	0	X	0	X	X	X	X	X
			34	0	0	X	0	X	X	X	X	X
	6000	1.8	24	0	0	0	0	0	0	0	0	X
			26	0	0	0	0	0	0	0	0	X
			28	0	0	0	0	0	1	0	0	X
			30	0	0	0	0	0	X	0	1	X
			32	0	0	0	0	0	X	0	X	X
			34	0	0	0	0	0	X	0	X	X
6500	1.8	24	0	0	0	0	0	1	0	0	X	
		26	0	0	0	0	0	WS	0	0	X	
		28	0	0	0	0	0	1	0	0	X	
		30	0	0	0	0	0	1	0	1	X	
		32	0	0	0	0	0	X	0	1	X	
		34	0	0	0	0	0	X	0	1	X	
11 7/8"	5000	1.7	24	0	0	0	0	0	WS	0	0	X
			26	0	0	0	0	0	WS	0	0	X
			28	0	0	0	0	0	WS	0	WS	X
			30	0	0	0	0	0	X	0	WS	X
			32	0	0	WS	0	0	X	0	X	X
			34	0	0	WS	0	0	X	0	X	X
	6000	1.8	24	0	0	0	0	0	0	0	0	1
			26	0	0	0	0	0	0	0	0	1
			28	0	0	0	0	0	WS	0	0	X
			30	0	0	0	0	0	1	0	0	X
			32	0	0	0	0	0	1	0	WS	X
			34	0	0	0	0	0	1	0	1	X
6500	1.8	24	0	0	0	0	0	1	0	1	X	
		26	0	0	0	0	0	WS	0	0	X	
		28	0	0	0	0	0	WS	0	0	X	
		30	0	0	0	0	0	1	0	0	X	
		32	0	0	0	0	0	1	0	WS	X	
		34	0	0	0	0	0	1	0	1	X	
60	2.0	24	0	0	0	0	0	X	0	1	X	
		26	0	0	0	0	0	X	0	1	X	
		28	0	0	0	0	0	X	0	1	X	
		30	0	0	0	0	0	X	0	1	X	
		32	0	0	0	0	0	X	0	1	X	
		34	0	0	0	0	0	X	0	1	X	
90	2.0	24	0	0	0	0	0	X	0	X	X	
		26	0	0	0	0	0	0	0	0	0	
		28	0	0	0	0	0	0	0	0	0	
		30	0	0	0	0	0	0	0	0	0	
		32	0	0	0	0	0	0	0	0	0	
		34	0	0	0	0	0	0	0	0	1	

Joist Depth [in]	Joist Series	Roof Truss Span [ft]	Roof Total Load [psf]										
			35			45			55				
			Joist Spacing [in]			Joist Spacing [in]			Joist Spacing [in]				
			16	19.2	24	16	19.2	24	16	19.2	24		
14"	5000	1.7	24	0	0	0	0	0	0	0	0	WS	
			26	0	0	0	0	0	0	WS	0	0	WS
			28	0	0	0	0	0	0	0	WS	0	1
			30	0	0	0	0	0	0	0	WS	0	X
			32	0	0	0	0	0	0	0	WS	0	X
			34	0	0	WS	0	0	1	0	WS	X	X
	6000	1.8	24	0	0	0	0	0	0	0	0	WS	
			26	0	0	0	0	0	0	0	0	WS	
			28	0	0	0	0	0	0	0	WS	0	WS
			30	0	0	0	0	0	0	0	WS	0	1
			32	0	0	0	0	0	0	0	WS	0	1
			34	0	0	0	0	0	0	0	WS	0	X
6500	1.8	24	0	0	0	0	0	0	WS	0	1		
		26	0	0	0	0	0	0	0	0	WS		
		28	0	0	0	0	0	0	0	WS	0	WS	
		30	0	0	0	0	0	0	0	WS	0	1	
		32	0	0	0	0	0	0	0	WS	0	X	
		34	0	0	0	0	0	0	0	WS	0	X	
16"	6000	1.8	24	0	0	0	0	0	0	0	0	WS	
			26	0	0	0	0	0	0	0	0	WS	
			28	0	0	0	0	0	0	0	0	0	WS
			30	0	0	0	0	0	0	0	WS	0	WS
			32	0	0	0	0	0	0	0	WS	0	WS
			34	0	0	0	0	0	0	0	WS	0	WS
	6500	1.8	24	0	0	0	0	0	0	WS	0	WS	
			26	0	0	0	0	0	0	0	0	WS	
			28	0	0	0	0	0	0	0	WS	0	WS
			30	0	0	0	0	0	0	0	WS	0	WS
			32	0	0	0	0	0	0	0	WS	0	WS
			34	0	0	0	0	0	0	0	WS	0	WS
90	2.0	24	0	0	0	0	0	0	WS	0	WS		
		26	0	0	0	0	0	0	0	0	WS		
		28	0	0	0	0	0	0	0	0	0	WS	
		30	0	0	0	0	0	0	0	WS	0	WS	
		32	0	0	0	0	0	0	0	WS	0	WS	
		34	0	0	0	0	0	0	0	WS	0	WS	

- Cut 48" long reinforcers to match the joist depth. Use min. 23/32" plywood/OSB-rated sheathing, Exposure 1, 48/24 Span Rating panels. The face grain must be horizontal (measure the 48" dimension along the long edge of the panel).
- Fasten the reinforcer to the joist flanges with 8d nails at 6" o.c. When reinforcing both sides, stagger the nails to avoid splitting the joist flanges.
- Attach web stiffeners per intermediate *Web Stiffener Nailing Schedule* on page 9.
- Use the BC CALC® software to analyze conditions that are not covered by this table. It may be possible to exceed the limitations of this table by analyzing a specific application with BC CALC® software.

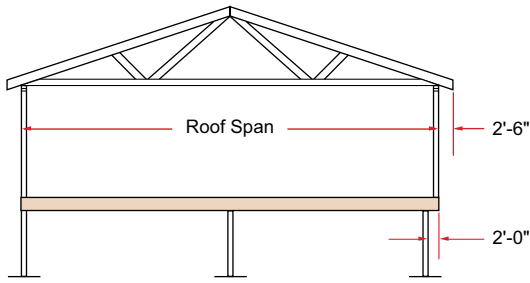

PLYWOOD / OSB REINFORCEMENT (If Required per BC CALC® analysis)

Analyze BCI® Load Bearing Cantilevers in BC CALC® Software

- The tables and details on pages 8 and 9 indicate the type of reinforcements, if any, that are required for load-bearing cantilevers up to a maximum length of 2'-0". Cantilevers longer than 2'-0" cannot be reinforced. **However, longer cantilevers with lower loads may be allowable without reinforcement. Analyze specific applications with the BC CALC® software.**

- 2³/₃₂" Min. x 48" long plywood / OSB rated sheathing must match the full depth of the BCI® Joist. Nail to the BCI® Joist with 8d nails at 6" o.c. and nail with 4-8d nails into backer block. When reinforcing both sides, stagger nails to limit splitting. Install with horizontal face grain.
- Contact Boise Cascade EWP Engineering for reinforcement requirements on BCI® Joist depths greater than 16".

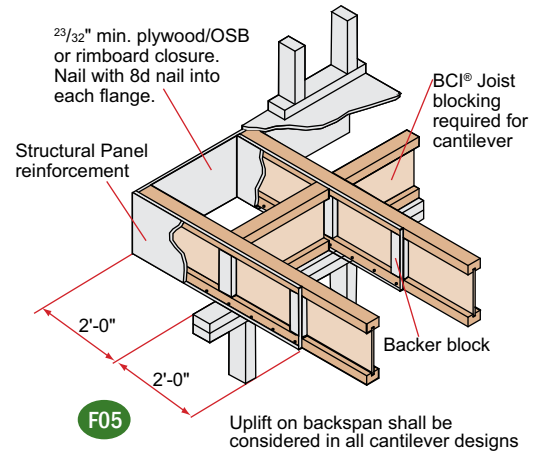

Non-Load Bearing Wall Cantilever Details

BCI® Joists are intended only for applications that provide permanent protection from the weather.

Fasten the 2x8 minimum to the BCI® Joist by nailing through the backer block and joist web with 2 rows of 10d nails at 6" on center. Use 16d nails with BCI® 90 2.0 joists. Clinch all nails.

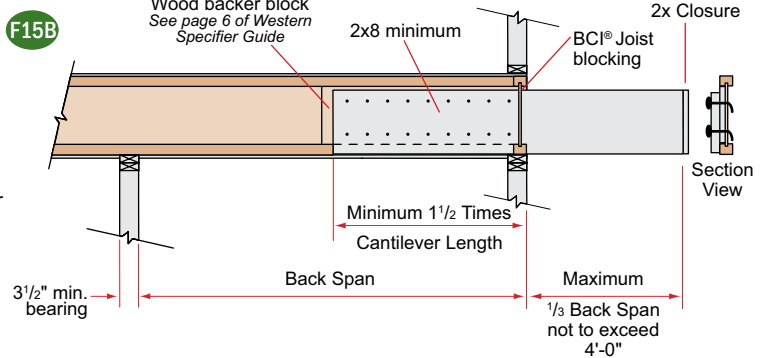
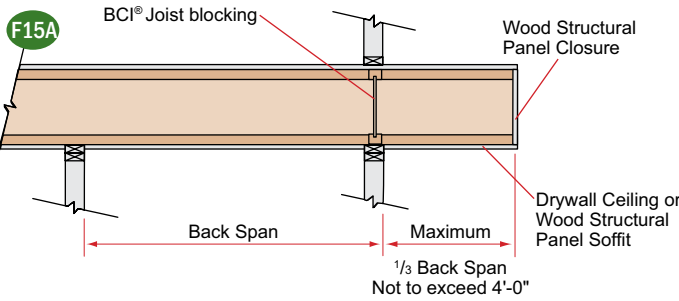

- These details apply to cantilevers with uniform loads only.
- It may be possible to exceed the limitations of these details by analyzing a specific application with the BC CALC® software.

Web Stiffener Requirements

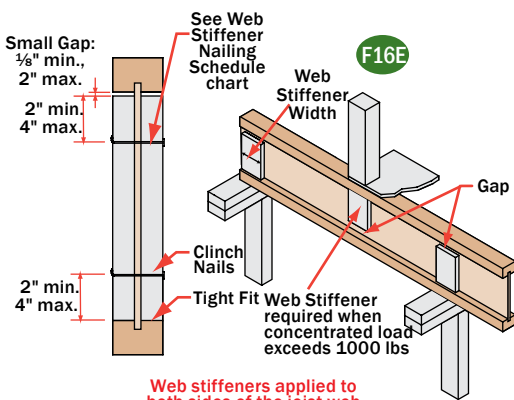

NOTES

- Web stiffeners are optional except as noted below.
- Web stiffeners are always required for all 18" and 20" BCI® Joists at all bearing locations.
- Web stiffeners are always required in hangers that do not extend up to support the top flange of the BCI® Joist. Web stiffeners may be required with certain sloped or skewed hangers or to achieve uplift values. Refer to the hanger manufacturer's installation requirements.
- Web stiffeners are always required in certain roof applications. See Roof Framing Details on page 14.
- Web stiffeners are always required under concentrated loads that exceed 1000 pounds. Install the web stiffeners snug to the top flange in this situation. Follow the nailing schedule for intermediate bearings.
- Web stiffeners may be cut from structural rated wood panels, engineered rimboard or 2x lumber (BCI® 90 only).
- For Structural Capacity: Web stiffeners needed to increase the BCI® Joist's reaction capacity at a specific bearing location.
- Lateral Restraint in Hanger: Web stiffeners needed when hanger does not lateral support the top flange (e.g., adjustable height hangers). Web stiffeners may be of multiple thickness (e.g., BCI® 6500, double 1/2" panel OK).
- Web stiffeners may be used to increase allowable reaction values. See BCI® Design Properties on page 24 or the BC CALC® software.

Web Stiffener Specifications

BCI® Joist Series	For Structural Capacity (Min. Thick)	Lateral Restraint in Hanger	Minimum Width
5000 1.7	5/8"	3/4"	2 ⁵ / ₁₆ "
6000 1.8	3/4"	7/8"	2 ⁵ / ₁₆ "
6500 1.8	3/4"	1" or 1 ¹ / ₈ "	2 ⁵ / ₁₆ "
60 2.0	3/4"	7/8"	2 ⁵ / ₁₆ "
90 2.0	2x4 lumber (vertical)		

Web Stiffener Nailing Schedule

BCI® Joist Series	Joist Depth	Bearing Location	
		End	Intermediate
5000 1.7	9 1/2"	2-8d	2-8d
	11 7/8"	2-8d	3-8d
	14"	2-8d	5-8d
6000 1.8	9 1/2"	2-8d	2-8d
	11 7/8"	2-8d	3-8d
	14"	2-8d	5-8d
6500 1.8	9 1/2"	2-8d	2-8d
	11 7/8"	2-8d	3-8d
	14"	2-8d	5-8d
60 2.0	11 7/8"	2-8d	3-8d
	14"	2-8d	5-8d
	16"	2-8d	6-8d
90 2.0	11 7/8"	3-16d	3-16d
	14"	5-16d	5-16d
	16"	6-16d	6-16d
	18"	7-16d	7-16d
	20"	8-16d	8-16d

Allowable Uniform Floor Load (in pounds per linear foot [PLF])

100% Load Duration

Span Length	BCI® 5000 1.7 Series 2" Flange Width						BCI® 6000 1.8 Series 2 ⁵ / ₁₆ " Flange Width							
	9½" BCI® 5000 1.7		11⅞" BCI® 5000 1.7		14" BCI® 5000 1.7		9½" BCI® 6000 1.8		11⅞" BCI® 6000 1.8		14" BCI® 6000 1.8		16" BCI® 6000 1.8	
	Live Load	Total Load	Live Load	Total Load	Live Load	Total Load	Live Load	Total Load	Live Load	Total Load	Live Load	Total Load	Live Load	Total Load
6	-	280	-	300	-	313	-	320	-	333	-	346	-	353
7	-	240	-	257	-	268	-	274	-	285	-	297	-	302
8	-	210	-	225	-	235	-	240	-	250	-	260	-	265
9	-	186	-	200	-	208	-	213	-	222	-	231	-	235
10	151	168	-	180	-	188	175	192	-	200	-	208	-	212
11	117	152	-	163	-	170	135	174	-	181	-	189	-	192
12	91	136	146	150	-	156	107	160	-	166	-	173	-	176
13	73	116	117	138	-	144	85	147	138	153	-	160	-	163
14	59	100	95	128	-	134	69	129	113	142	-	148	-	151
15	48	87	78	112	115	125	57	112	93	133	135	138	-	141
16	40	76	65	98	96	116	47	95	78	125	113	130	-	132
17			55	87	80	103	40	80	65	112	95	122	-	124
18			47	77	68	92			56	100	81	115	108	117
19			40	69	58	82			48	89	70	106	93	111
20					50	74			41	81	60	96	80	106
21					44	67					52	87	70	99
22											46	79	61	90

- Total Load values are limited by shear, moment, or deflection equal to L/240.
- Live Load values are limited by deflection equal to L/480. For deflection limits of L/360 and L/960, multiply the Live Load values by 1.33 and 0.50 respectively.
- Both the Total Load and Live Load columns must be checked. Where a Live Load value is not shown, the Total Load value will control.
- Table values apply to either simple or multiple span joists. Span is measured center to center of the minimum required bearing length. Analyze multiple span joists with the BC CALC® software if the length of any span is less than half the length of an adjacent span.
- Table values do not consider composite action from gluing and nailing floor sheathing (composite action is considered in floor span tables on page 4).
- Total Load values assume minimum bearing lengths without web stiffeners for joist depths of 16 inches and less. 18 and 20 inch joists require web stiffeners.
- For assistance with floor design, consult the section *About Floor Performance* on page 4.
- This table was designed to apply to a broad range of applications. It may be possible to exceed the limitations of this table by analyzing a specific application with the BC CALC® software.

Allowable Uniform Floor Load (in pounds per linear foot [PLF])

100% Load Duration

Span Length	BCI® 6500 1.8 Series 2 ⁹ / ₁₆ " Flange Width								BCI® 60 2.0 Series 2 ⁵ / ₁₆ " Flange Width					
	9 ¹ / ₂ " BCI® 6500 1.8		11 ⁷ / ₈ " BCI® 6500 1.8		14" BCI® 6500 1.8		16" BCI® 6500 1.8		11 ⁷ / ₈ " BCI® 60 2.0		14" BCI® 60 2.0		16" BCI® 60 2.0	
	Live Load	Total Load	Live Load	Total Load	Live Load	Total Load	Live Load	Total Load	Live Load	Total Load	Live Load	Total Load	Live Load	Total Load
6	-	320	-	333	-	346	-	353	-	366	-	366	-	366
7	-	274	-	285	-	297	-	302	-	314	-	314	-	314
8	-	240	-	250	-	260	-	265	-	275	-	275	-	275
9	-	213	-	222	-	231	-	235	-	244	-	244	-	244
10	190	192	-	200	-	208	-	212	-	220	-	220	-	220
11	147	174	-	181	-	189	-	192	-	200	-	200	-	200
12	116	160	-	166	-	173	-	176	-	183	-	183	-	183
13	93	147	152	153	-	160	-	163	-	169	-	169	-	169
14	76	137	124	142	-	148	-	151	149	157	-	157	-	157
15	62	124	103	133	-	138	-	141	123	146	-	146	-	146
16	52	104	85	125	123	130	-	132	103	137	-	137	-	137
17	44	88	72	117	104	122	-	124	87	129	125	129	-	129
18			61	110	88	115	117	117	74	122	106	122	-	122
19			52	99	76	109	101	111	63	115	92	115	-	115
20			45	89	65	104	87	106	55	110	79	110	105	110
21					57	96	76	100	48	96	69	104	92	104
22					50	88	66	96	42	84	60	100	81	100
23					44	80	58	92			53	95	71	95
24							52	84			47	91	63	91
25							46	77			42	84	56	88
26							41	72					50	84
27													45	81
28													40	78
29														
30														



Allowable Uniform Floor Load (in pounds per linear foot [PLF])

100% Load Duration

Span Length	BCI® 90 2.0 Series 3½" Flange Width									
	11⅞" BCI® 90 2.0		14" BCI® 90 2.0		16" BCI® 90 2.0		18" BCI® 90 2.0		20" BCI® 90 2.0	
	Live Load	Total Load	Live Load	Total Load	Live Load	Total Load	Live Load	Total Load	Live Load	Total Load
6	-	450	-	453	-	456	-	553	-	573
7	-	385	-	388	-	391	-	474	-	491
8	-	337	-	340	-	342	-	415	-	430
9	-	300	-	302	-	304	-	368	-	382
10	-	270	-	272	-	274	-	332	-	344
11	-	245	-	247	-	249	-	301	-	312
12	-	225	-	226	-	228	-	276	-	286
13	-	207	-	209	-	210	-	255	-	264
14	-	192	-	194	-	195	-	237	-	245
15	174	180	-	181	-	182	-	221	-	229
16	146	168	-	170	-	171	-	207	-	215
17	124	158	-	160	-	161	-	195	-	202
18	106	150	150	151	-	152	-	184	-	191
19	91	142	129	143	-	144	-	174	-	181
20	79	135	112	136	-	137	-	166	-	172
21	69	128	98	129	-	130	-	158	-	163
22	61	122	86	123	115	124	146	150	-	156
23	53	107	76	118	101	119	129	144	-	149
24	47	95	68	113	90	114	115	138	-	143
25	42	85	60	108	80	109	103	132	128	137
26			54	104	72	105	92	127	115	132
27			48	97	65	101	83	122	104	127
28			44	88	58	97	75	118	94	122
29					53	94	68	114	85	118
30					48	91	62	110	77	114

- Total Load values are limited by shear, moment, or deflection equal to L/240.
- Live Load values are limited by deflection equal to L/480. For deflection limits of L/360 and L/960, multiply the Live Load values by 1.33 and 0.50 respectively.
- Both the Total Load and Live Load columns must be checked. Where a Live Load value is not shown, the Total Load value will control.
- Table values apply to either simple or multiple span joists. Span is measured center to center of the minimum required bearing length. Analyze multiple span joists with the BC CALC® software if the length of any span is less than half the length of an adjacent span.
- Table values do not consider composite action from gluing and nailing floor sheathing (composite action is considered in floor span tables on page 4).
- Total Load values assume minimum bearing lengths without web stiffeners for joist depths of 16 inches and less. 18 and 20 inch joists require web stiffeners.
- For assistance with floor design, consult the section *About Floor Performance* on page 4.
- This table was designed to apply to a broad range of applications. It may be possible to exceed the limitations of this table by analyzing a specific application with the BC CALC® software.

BCI® Rafters

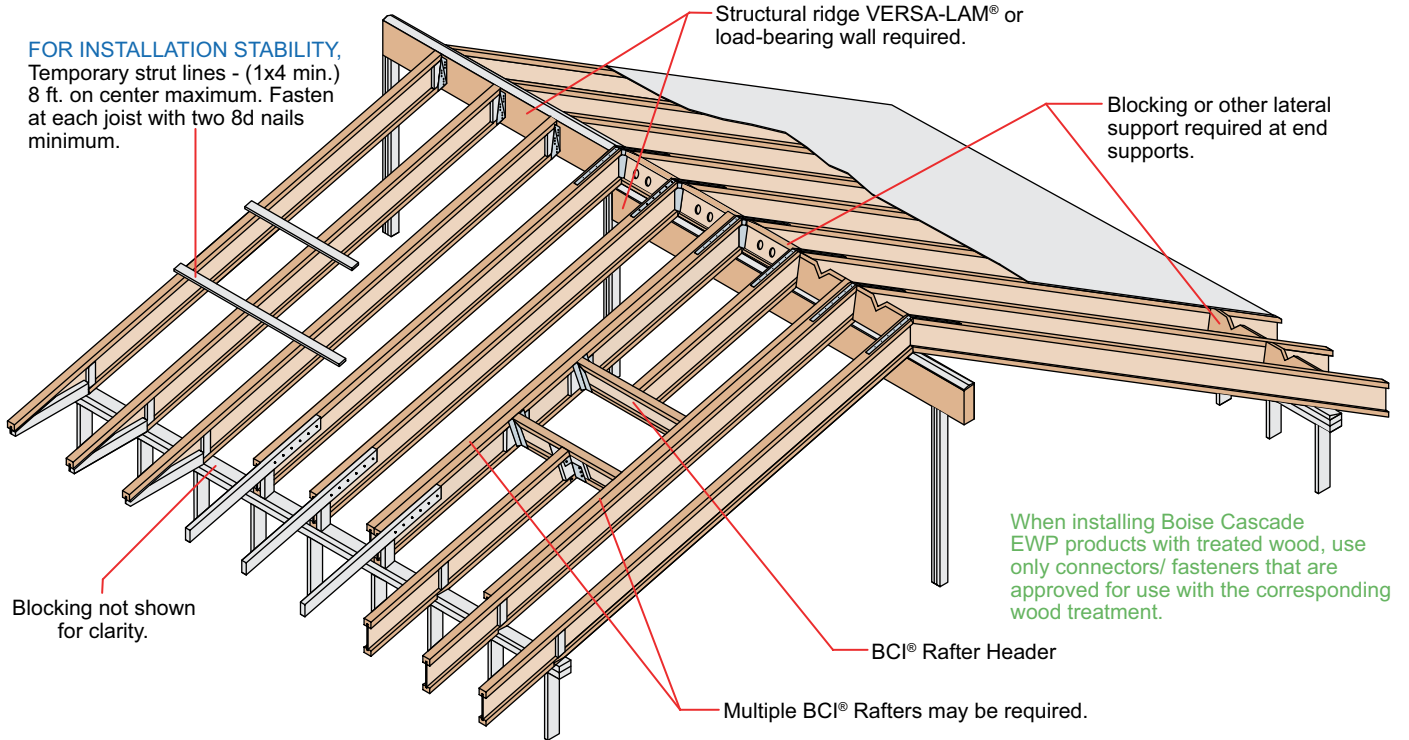

SAFETY WARNING

DO NOT ALLOW WORKERS ON BCI® JOISTS UNTIL ALL HANGERS, BCI® RIM JOISTS, RIM BOARDS, BCI® BLOCKING PANELS, X-BRACING AND TEMPORARY 1x4 STRUT LINES ARE INSTALLED AS SPECIFIED BELOW.

SERIOUS ACCIDENTS CAN RESULT FROM INSUFFICIENT ATTENTION TO PROPER BRACING DURING CONSTRUCTION. ACCIDENTS CAN BE AVOIDED UNDER NORMAL CONDITIONS BY FOLLOWING THESE GUIDELINES:

- Build a braced end wall at the end of the bay, or permanently install the first eight feet of BCI® Joists and the first course of sheathing. As an alternate, temporary sheathing may be nailed to the first four feet of BCI® Joists at the end of the bay.
- All hangers, BCI® rim joists, rim boards, BCI® blocking panels, and x-bracing must be completely installed and properly nailed as each BCI® Joist is set.
- Install temporary 1x4 strut lines at no more than eight feet on center as additional BCI® Joists are set. Nail the strut lines to the sheathed area, or braced end wall, and to each BCI® Joist with two 8d nails.
- The ends of cantilevers must be temporarily secured by strut lines on both the top and bottom flanges.
- Straighten the BCI® Joists to within 1/2 inch of true alignment before attaching strut lines and sheathing.
- Remove the temporary strut lines only as required to install the permanent sheathing.
- Failure to install temporary bracing may result in sideways buckling or roll-over under light construction loads.

BCI® Ceiling Joist with Bevel End Cut (For Limited-Access Attics Only)

BCI® Joist shall not be used as collar/tension tie.

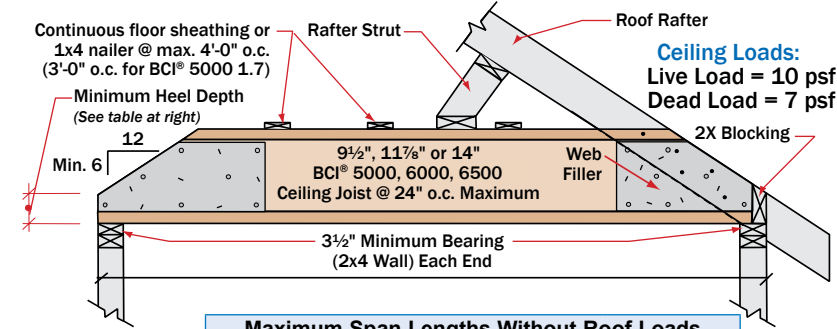

Maximum Span Lengths Without Roof Loads	
9 1/2" BCI® 5000 1.7 / 6000 1.8 / 6500 1.8	19'-6"
11 1/8" BCI® 5000 1.7 / 6000 1.8 / 6500 1.8	22'-0"
14" BCI® 6000 1.8 / 6500 1.8	25'-0"

(If roof loads present, see Notes 2 & 3 at right)

Minimum Heel Depths	Joist Depth	End Wall	
		2 x 4	2 x 6
9 1/2"	9 1/2"	2 1/2"	1 1/2"
11 1/8"	11 1/8"	3 1/2"	2 1/2"
14"	14"	4 1/2"	3 1/2"

Notes:

- 1) Detail is to be used only for ceiling joists with no access to attic space.
- 2) Ceiling joist must be designed to carry all roof load transferred through rafter struts as shown.
- 3) BCI® ceiling joist end reaction may not exceed 550 pounds.
- 4) Minimum roof slope is 6/12.
- 5) Nail roof rafter to BCI® top flange with 1-16d sinker or box nail.
- 6) Nail BCI® top flange to roof rafter with 1-16d nail (for stability resistance only).
- 7) Install a web stiffener on each side of BCI® Joist at beveled ends. Nail roof rafter to BCI® Joist per building code requirements for ceiling joist to roof rafter connection.

Additional roof framing details available with BC FRAMER® software (see page 33)

R01

2x beveled plate for slope greater than 1/4/12.

Simpson VPA or USP TMP connectors or equal can be used in lieu of beveled plate for slopes from 3/12 to 12/12.

R04

10d nails at 6" o.c.

2x4 one side for 135 PLF max.
2x6 one side for 240 PLF max.

Backer block. Thickness per corresponding BCI® series.

2x block

BCI® blocking
Holes cut for ventilation.

4'-0" horiz.
2'-6" horiz.

R02

Rimboard / VERSA-LAM® blocking.
Ventilation "V" cut:
1/3 of length, 1/2 of depth

2x4 blocking for soffit support.

2'-6" max.

Flange of BCI® Joists may be birdsmouth cut only at the low end of the joist. Birds mouth cut BCI® joist must bear fully on plate, web stiffener required each side. Bottom flange shall be fully supported.

DN05

DO NOT bevel-cut joist beyond inside face of wall, except for specific conditions in details shown on pages 6 and 13 of the Western Specifier Guide.

R03

Rimboard / VERSA-LAM® blocking.
Ventilation "V" cut:
1/3 of length, 1/2 of depth

Tight fit for lateral stability.

Flange of BCI® Joists may be birdsmouth cut only at the low end of the joist. Birds mouth cut BCI® Joist must bear fully on plate, web stiffener required each side.

2'-6" max.

R07

Backer block (minimum 12" wide).
Nail with 10-10d nails.

Joist Hanger

Filler block. Nail with 10-10d nails.

Backer block required where top flange joist hanger load exceeds 250 lbs. Install tight to top flange.

R05

Simpson or USP LSTA24 strap, nailing per governing building code.

VERSA-LAM® LVL support beam.

BCI® blocking
Holes cut for ventilation.

Double-beveled wood plate.

Blocking on both sides of ridge may be required for shear transfer per design professional of record.

R06

Simpson or USP LSTA24 strap where slope exceeds 7/12 (straps may be required for lower slopes in high-wind areas). Nailing per governing building code.

VERSA-LAM® LVL support beam.

Beveled web stiffener on each side.

Simpson LSSUI or USP TMU hanger.

R11

Double joist may be required when L exceeds rafter spacing.

Blocking as required.

Nail outrigger through BCI® web.

2" x outrigger notched around BCI® top flange. Outrigger spacing no greater than 24" on-center.

End Wall.

L (2'-0" max.)

LATERAL SUPPORT

- BCI® Joists must be laterally supported at end supports (including supports adjacent to overhangs) with hangers, rimboard, or blocking (VERSA-LAM®, Boise Cascade Rimboard or BCI® Joist). Metal cross bracing or other x-bracing provides adequate lateral support for BCI® Joists, consult governing building code for roof diaphragm connection provisions.

MINIMUM BEARING LENGTH FOR BCI® JOISTS

- Minimum Bearing Lengths: 1½" end bearing, 3½" intermediate and adjacent cantilever bearing.
- Longer bearing lengths allow higher reaction values. Refer to the building code evaluation report or the BC CALC® software.

NAILING REQUIREMENTS

- BCI® rim joist, rim board or closure panel to BCI® joist:
 - Rims or closure panel 1¾ inches thick and less: 2-8d nails, one each in the top and bottom flange.
 - BCI® 5000 rim joist: 2-10d box nails, one each in the top and bottom flange.
 - BCI® 6000, 60 rim joist: 2-16d box nails, one each in the top and bottom flange.
 - BCI® 6500, 90 rim joist: Toe-nail top flange to rim joist with 2-10d box nails, one each side of flange.
- BCI® rim joist, rim board or BCI® blocking panel to support:
 - Min. 8d nails @ 6" o.c. per IRC.
 - Connection per design professional of record's specification for shear transfer.

- BCI® joist to support:
 - 2-8d nails, one on each side of the web, placed 1½ inches minimum from the end of the BCI® Joist to limit splitting.

- Sheathing to BCI® joist:
 - Prescriptive residential roof sheathing nailing requires 8d common nails @ 6" o.c. on edges and @ 12" o.c. in the field (IRC Table R602.3(1)).
 - See closest allowable nail spacing limits on page 24 for floor diaphragm nailing specified at closer spacing than IRC.
 - Maximum nail spacing for minimum lateral stability: 18" for BCI® 5000, 24" for larger BCI® joist series.
 - 14 gauge staples may be substituted for 8d nails if the staples penetrate at least 1 inch into the joist.
 - Wood screws may be acceptable, contact local building official and/or Boise Cascade EWP Engineering for further information.

BACKER AND FILLER BLOCK DIMENSIONS

Series	Backer Block Thickness	Filler Block Thickness
5000 1.7	¾" or ⅝" wood panels	Two ¾" wood panels or 2x
6000 1.8	1½" or two ¾" wood panels	2x + 7/16" or ½" wood panel
6500 1.8	1½" or two ¾" wood panels	2x + 5/8" or ¾" wood panel
60 2.0	1½" or two ¾" wood panels	2x + 7/16" or ½" wood panel
90 2.0	2x lumber	Double 2x lumber

- Cut backer and filler blocks to a maximum depth equal to the web depth minus ¼" to avoid a forced fit.

WEB STIFFENER REQUIREMENTS

- See *Web Stiffener Requirements* on page 9.

PROTECT BCI® JOISTS FROM THE WEATHER

- BCI® Joists are intended only for applications that provide permanent protection from the weather. Bundles of BCI® Joists should be covered and stored off of the ground on stickers.

MAXIMUM SLOPE

- Unless otherwise noted, all roof details are valid for slopes of 12 in 12 or less.

VENTILATION

- The 1½ inch, pre-stamped knock-out holes spaced at 12 inches on center along the BCI® Joist may all be knocked out and used for cross ventilation. Deeper joists than what is structurally needed may be advantageous in ventilation design. Consult local building official and/or ventilation specialist for specific ventilation requirements.

BIRDSMOUTH CUTS

- BCI® Joists may be birdsmouth cut only at the low end support. BCI® joists with birdsmouth cuts may cantilever up to 2'-6" past the low end support. The bottom flange must sit fully on the support and may not overhang the inside face of the support. High end supports and intermediate supports may not be birdsmouth cut.

Maximum clear span in feet and inches, based on horizontal spans.

115% and 125% Load Duration

		BCI® 5000 1.7 Series 2" Flange Width											BCI® 6000 1.8 Series 2 ⁵ / ₁₆ " Flange Width													
					9½" BCI® 5000 1.7			11⅞" BCI® 5000 1.7			14" BCI® 5000 1.7			9½" BCI® 6000 1.8			11⅞" BCI® 6000 1.8			14" BCI® 6000 1.8			16" BCI® 6000 1.8			
		Live Load [psf]	Dead Load [psf]		4/12 or Less	4/12 to 8/12	8/12 to 12/12	4/12 or Less	4/12 to 8/12	8/12 to 12/12	4/12 or Less	4/12 to 8/12	8/12 to 12/12	4/12 or Less	4/12 to 8/12	8/12 to 12/12	4/12 or Less	4/12 to 8/12	8/12 to 12/12	4/12 or Less	4/12 to 8/12	8/12 to 12/12	4/12 or Less	4/12 to 8/12	8/12 to 12/12	4/12 or Less
12" o.c.	Non-Snow 125%	20	10	24'-1"	22'-9"	21'-1"	28'-7"	26'-11"	25'-0"	32'-7"	30'-8"	28'-6"	25'-6"	24'-1"	22'-4"	30'-5"	28'-8"	26'-7"	34'-8"	32'-8"	30'-4"	38'-4"	36'-2"	33'-6"		
		20	15	22'-10"	21'-5"	19'-9"	27'-1"	25'-5"	23'-5"	30'-10"	29'-0"	26'-9"	24'-2"	22'-8"	20'-11"	28'-10"	27'-1"	25'-0"	32'-10"	30'-10"	28'-5"	36'-4"	34'-1"	31'-5"		
		20	20	21'-9"	20'-5"	18'-9"	25'-10"	24'-2"	22'-3"	29'-5"	27'-7"	25'-4"	23'-1"	21'-7"	19'-10"	27'-6"	25'-9"	23'-8"	31'-4"	29'-4"	26'-11"	34'-8"	32'-5"	29'-10"		
	Snow 115%	25	10	22'-11"	21'-8"	20'-2"	27'-2"	25'-8"	23'-10"	30'-10"	29'-3"	27'-2"	24'-3"	22'-11"	21'-4"	28'-11"	27'-4"	25'-5"	32'-11"	31'-1"	28'-11"	36'-5"	34'-5"	32'-0"		
		25	15	21'-10"	20'-7"	19'-0"	25'-10"	24'-4"	22'-7"	28'-9"	27'-9"	25'-8"	23'-1"	21'-9"	20'-2"	27'-7"	25'-11"	24'-0"	31'-5"	29'-7"	27'-4"	34'-9"	32'-8"	30'-3"		
		30	10	21'-11"	20'-9"	19'-4"	25'-11"	24'-7"	22'-11"	28'-10"	28'-0"	26'-1"	23'-2"	21'-11"	20'-6"	27'-7"	26'-2"	24'-5"	31'-6"	29'-9"	27'-9"	34'-10"	32'-11"	30'-9"		
		30	15	21'-0"	19'-10"	18'-4"	24'-10"	23'-5"	21'-9"	27'-2"	26'-6"	24'-10"	22'-3"	21'-0"	19'-5"	26'-6"	25'-0"	23'-2"	30'-2"	28'-5"	26'-5"	33'-0"	31'-6"	29'-3"		
		40	10	19'-11"	19'-1"	18'-0"	23'-7"	22'-8"	21'-4"	25'-10"	25'-5"	24'-4"	21'-1"	20'-3"	19'-1"	25'-1"	24'-1"	22'-9"	28'-8"	27'-5"	25'-11"	31'-4"	30'-5"	28'-8"		
		50	10	18'-5"	17'-8"	17'-3"	22'-6"	22'-0"	20'-6"	24'-7"	24'-1"	23'-4"	20'-9"	19'-8"	18'-4"	24'-9"	23'-5"	21'-10"	27'-11"	26'-8"	24'-10"	29'-10"	29'-3"	27'-6"		
	50	15	18'-3"	17'-7"	16'-5"	20'-9"	20'-5"	19'-5"	22'-7"	22'-3"	21'-8"	19'-6"	18'-7"	17'-4"	23'-3"	22'-2"	20'-8"	25'-3"	23'-7"	21'-0"	27'-5"	27'-0"	26'-1"			
	16" o.c.	Non-Snow 125%	20	10	21'-10"	20'-7"	19'-1"	25'-11"	24'-5"	22'-8"	29'-6"	27'-10"	25'-10"	23'-2"	21'-10"	20'-3"	27'-7"	26'-0"	24'-2"	31'-5"	29'-7"	27'-6"	34'-9"	32'-9"	30'-5"	
			20	15	20'-8"	19'-5"	17'-11"	24'-6"	23'-0"	21'-3"	27'-8"	26'-3"	24'-3"	21'-11"	20'-7"	19'-0"	26'-1"	24'-6"	22'-8"	29'-9"	27'-11"	25'-9"	32'-11"	30'-11"	28'-6"	
20			20	19'-9"	18'-6"	17'-0"	23'-5"	21'-11"	20'-2"	25'-10"	25'-0"	22'-11"	20'-11"	19'-7"	18'-0"	24'-11"	23'-4"	21'-5"	28'-5"	26'-7"	24'-5"	31'-5"	29'-5"	27'-0"		
Snow 115%		25	10	20'-9"	19'-7"	18'-3"	24'-6"	23'-3"	21'-8"	26'-8"	26'-1"	24'-8"	22'-0"	20'-9"	19'-4"	26'-2"	24'-9"	23'-0"	29'-10"	28'-2"	26'-3"	32'-5"	31'-2"	29'-0"		
		25	15	19'-9"	18'-7"	17'-3"	22'-10"	22'-1"	20'-5"	24'-10"	24'-3"	23'-4"	20'-11"	19'-9"	18'-3"	24'-11"	23'-6"	21'-9"	28'-3"	26'-9"	24'-10"	30'-3"	29'-5"	27'-5"		
		30	10	19'-10"	18'-9"	17'-6"	22'-11"	22'-3"	20'-9"	24'-11"	24'-6"	23'-8"	21'-0"	19'-11"	18'-7"	25'-0"	23'-8"	22'-1"	28'-4"	27'-0"	25'-2"	30'-4"	29'-9"	27'-10"		
		30	15	19'-0"	17'-11"	16'-8"	21'-6"	21'-0"	19'-9"	23'-5"	22'-11"	22'-2"	20'-1"	19'-0"	17'-7"	24'-0"	22'-7"	21'-0"	26'-8"	25'-9"	23'-11"	28'-6"	27'-10"	26'-6"		
		40	10	18'-0"	17'-4"	16'-4"	20'-6"	20'-2"	19'-4"	22'-4"	22'-0"	21'-7"	19'-1"	18'-4"	17'-3"	22'-9"	21'-10"	20'-7"	25'-5"	24'-11"	23'-6"	27'-2"	26'-9"	26'-0"		
		50	10	16'-6"	16'-0"	15'-2"	18'-8"	18'-6"	18'-0"	20'-4"	20'-1"	19'-9"	17'-8"	16'-11"	16'-1"	21'-1"	20'-2"	19'-2"	23'-2"	22'-11"	21'-10"	24'-9"	24'-6"	24'-1"		
50		15	15'-10"	15'-6"	14'-10"	17'-11"	17'-7"	17'-3"	19'-6"	19'-2"	18'-9"	17'-8"	16'-10"	15'-9"	20'-4"	20'-0"	18'-9"	22'-2"	21'-10"	21'-4"	23'-9"	23'-4"	22'-10"			
19.2" o.c.		Non-Snow 125%	20	10	20'-6"	19'-4"	18'-0"	24'-4"	22'-11"	21'-4"	27'-5"	26'-2"	24'-3"	21'-9"	20'-6"	19'-0"	25'-11"	24'-5"	22'-8"	29'-6"	27'-10"	25'-10"	32'-8"	30'-10"	28'-7"	
			20	15	19'-5"	18'-3"	16'-10"	23'-0"	21'-8"	20'-0"	25'-3"	24'-6"	22'-9"	20'-7"	19'-4"	17'-10"	24'-6"	23'-0"	21'-3"	27'-11"	26'-3"	24'-3"	30'-8"	29'-0"	26'-10"	
	20		20	18'-6"	17'-4"	15'-11"	21'-8"	20'-7"	18'-11"	23'-7"	22'-9"	21'-7"	19'-7"	18'-4"	16'-11"	23'-4"	21'-11"	20'-2"	26'-8"	24'-11"	22'-11"	28'-8"	27'-7"	25'-5"		
	Snow 115%	25	10	19'-6"	18'-5"	17'-2"	22'-4"	21'-10"	20'-4"	24'-4"	23'-10"	23'-2"	20'-7"	19'-6"	18'-2"	24'-7"	23'-3"	21'-8"	27'-8"	26'-6"	24'-8"	29'-7"	28'-11"	27'-3"		
		25	15	18'-4"	17'-6"	16'-2"	20'-10"	20'-3"	19'-2"	22'-8"	22'-1"	21'-4"	19'-8"	18'-6"	17'-2"	23'-5"	22'-1"	20'-5"	25'-9"	25'-1"	23'-4"	27'-7"	26'-10"	25'-9"		
		30	10	18'-5"	17'-8"	16'-5"	20'-11"	20'-6"	19'-6"	22'-9"	22'-4"	21'-10"	19'-8"	18'-8"	17'-5"	23'-6"	22'-3"	20'-9"	25'-10"	25'-4"	23'-8"	27'-8"	27'-2"	26'-2"		
		30	15	17'-4"	16'-10"	15'-8"	19'-7"	19'-2"	18'-6"	21'-5"	20'-11"	20'-3"	18'-11"	17'-10"	16'-7"	22'-4"	21'-3"	19'-9"	24'-4"	23'-9"	22'-6"	26'-0"	25'-5"	24'-7"		
		40	10	16'-6"	16'-3"	15'-4"	18'-8"	18'-5"	18'-0"	20'-4"	20'-1"	19'-8"	17'-11"	17'-2"	16'-3"	21'-3"	20'-6"	19'-4"	23'-2"	22'-10"	22'-1"	24'-9"	24'-5"	23'-11"		
		50	10	15'-8"	15'-4"	14'-8"	17'-9"	17'-5"	16'-11"	19'-4"	19'-0"	18'-6"	17'-8"	16'-11"	15'-7"	20'-2"	19'-10"	18'-7"	22'-0"	21'-7"	21'-0"	23'-6"	23'-1"	22'-6"		
	50	15	15'-0"	14'-10"	14'-3"	17'-0"	16'-10"	16'-7"	18'-7"	18'-4"	18'-0"	16'-7"	15'-11"	15'-1"	19'-5"	19'-0"	18'-0"	21'-1"	20'-10"	20'-6"	22'-7"	22'-4"	21'-11"			
	24" o.c.	Non-Snow 125%	20	10	19'-0"	17'-11"	16'-8"	22'-5"	21'-3"	19'-9"	24'-6"	23'-11"	22'-6"	20'-1"	19'-0"	17'-7"	24'-0"	22'-7"	21'-0"	27'-4"	25'-9"	23'-11"	29'-9"	28'-6"	26'-6"	
			20	15	18'-0"	16'-11"	15'-7"	20'-9"	20'-0"	18'-6"	22'-7"	21'-11"	21'-0"	19'-0"	17'-11"	16'-6"	22'-8"	21'-4"	19'-8"	25'-8"	24'-4"	22'-5"	27'-5"	26'-7"	24'-10"	
20			20	17'-1"	16'-1"	14'-9"	19'-4"	18'-8"	17'-6"	21'-1"	20'-4"	19'-5"	18'-2"	17'-0"	15'-8"	21'-8"	20'-3"	18'-8"	23'-11"	23'-1"	21'-3"	25'-7"	24'-9"	23'-6"		
Snow 115%		25	10	17'-7"	17'-1"	15'-11"	19'-11"	19'-6"	18'-10"	21'-9"	21'-3"	20'-8"	19'-1"	18'-1"	16'-10"	22'-8"	21'-6"	20'-0"	24'-8"	24'-2"	22'-10"	26'-5"	25'-10"	25'-2"		
		25	15	16'-5"	15'-11"	15'-0"	18'-7"	18'-1"	17'-5"	20'-3"	19'-9"	19'-0"	18'-2"	17'-2"	15'-10"	21'-2"	20'-5"	18'-11"	23'-0"	22'-5"	21'-7"	24'-8"	24'-0"	23'-2"		
		30	10	16'-5"	16'-2"	15'-3"	18'-8"	18'-4"	17'-10"	20'-4"	20'-0"	19'-6"	18'-3"	17'-3"	16'-2"	21'-2"	20'-7"	19'-3"	23'-1"	22'-8"	21'-11"	24'-9"	24'-3"	23'-8"		
		30	15	15'-5"	15'-1"	14'-6"	17'-6"	17'-1"	16'-7"	19'-1"	18'-8"	18'-1"	17'-6"	16'-6"	15'-4"	19'-11"	19'-6"	18'-3"	21'-9"	21'-3"	20'-6"	23'-3"	22'-8"	21'-11"		
		40	10	14'-8"	14'-6"	14'-2"	16'-8"	16'-5"	16'-1"	18'-2"	17'-11"	17'-7"	16'-7"	15'-11"	15'-0"	19'-0"	18'-8"	17'-11"	20'-8"	20'-4"	20'-0"	22'-1"	21'-9"	21'-4"		
		50	10	14'-0"	13'-8"	13'-4"	15'-10"	15'-7"	15'-2"	17'-3"	16'-11"	16'-6"	15'-11"	15'-5"	14'-5"	18'-0"	17'-8"	17'-2"	19'-8"	19'-3"	18'-9"	21'-0"	20'-7"	19'-8"		
50		15	13'-5"	13'-3"	13'-0"	15'-3"	15'-0"	14'-9"	16'-7"	16'-5"	16'-1"	15'-3"	14'-8"	14'-0"	17'-4"	17'-1"	16'-8"	18'-10"	18'-8"	18'-4"	19'-10"	19'-5"	18'-9"			
50		15	12'-10"	12'-8"	12'-4"	14'-7"	14'-4"	14'-0"	15'-11"	15'-8"	14'-11"	14'-7"	14'-4"	13'-8"	16'-7"	16'-4"	15'-11"	17'-11"	17'-4"	16'-6"	18'-3"	17'-8"	16'-10"			

- Table values are limited by shear, moment, total load deflection equal to L/180 and live load deflection equal to L/240. Check the local building code for other deflection limits that may apply.
- This table was designed to apply to a broad range of applications. It may be possible to exceed the limitations of this table by analyzing a specific application with the BC CALC® software.
- Table values represent the most restrictive of simple or multiple span applications.
- Slope roof joists at least ¼" over 12" to minimize ponding.
- Table values assume minimum bearing lengths without web stiffeners for joist depths of 16 inches and less. 18 and 20 inch joists require web stiffeners.
- Allowable spans and loads shall be adjusted and checked for wind load as required by local building code.

Roof Span Tables

Maximum clear span in feet and inches, based on horizontal spans.

115% and 125% Load Duration

			BCI® 6500 1.8 Series 2 ⁹ / ₁₆ " Flange Width													
			9½" BCI® 6500 1.8			11⅝" BCI® 6500 1.8			14" BCI® 6500 1.8			16" BCI® 6500 1.8				
			4/12 or Less	4/12 to 8/12	8/12 to 12/12	4/12 or Less	4/12 to 8/12	8/12 to 12/12	4/12 or Less	4/12 to 8/12	8/12 to 12/12	4/12 or Less	4/12 to 8/12	8/12 to 12/12		
o.c.	Live Load [psf]	Dead Load [psf]	115% and 125% Load Duration													
			12"	Non-Snow 125%	20	10	26'-5"	24'-11"	23'-3"	31'-5"	29'-7"	27'-5"	35'-9"	33'-8"	31'-3"	39'-6"
20	15	25'-0"			23'-6"	21'-8"	29'-9"	27'-11"	25'-9"	33'-10"	31'-9"	29'-4"	37'-5"	35'-2"	32'-5"	
20	20	23'-10"			22'-4"	20'-6"	28'-4"	26'-7"	24'-5"	32'-3"	30'-3"	27'-9"	35'-8"	33'-5"	30'-9"	
Snow 115%	25	10		25'-1"	23'-8"	22'-1"	29'-10"	28'-2"	26'-2"	33'-11"	32'-1"	29'-10"	37'-6"	35'-5"	33'-0"	
	25	15		23'-11"	22'-6"	20'-10"	28'-5"	26'-9"	24'-9"	32'-4"	30'-5"	28'-2"	35'-9"	33'-8"	31'-2"	
	30	10		23'-11"	22'-8"	21'-2"	28'-6"	27'-0"	25'-2"	32'-5"	30'-8"	28'-8"	35'-10"	33'-11"	31'-8"	
	30	15		23'-0"	21'-8"	20'-1"	27'-4"	25'-9"	23'-11"	31'-1"	29'-4"	27'-3"	34'-5"	32'-5"	30'-1"	
	40	10		21'-10"	20'-11"	19'-9"	25'-11"	24'-10"	23'-6"	29'-6"	28'-4"	26'-9"	32'-8"	31'-4"	29'-7"	
	40	15		21'-5"	20'-4"	18'-11"	25'-6"	24'-2"	22'-6"	29'-1"	27'-6"	25'-7"	31'-5"	30'-5"	28'-4"	
	50	10		20'-2"	19'-4"	18'-4"	24'-0"	23'-0"	21'-10"	27'-4"	26'-3"	24'-11"	30'-2"	29'-0"	27'-6"	
	50	15		20'-2"	19'-3"	18'-0"	24'-0"	22'-10"	21'-4"	27'-0"	26'-0"	24'-4"	28'-11"	28'-5"	26'-11"	
16"	Non-Snow 125%	20		10	23'-11"	22'-7"	20'-11"	28'-5"	26'-10"	24'-11"	32'-5"	30'-6"	28'-4"	35'-10"	33'-9"	31'-4"
		20		15	22'-8"	21'-3"	19'-8"	26'-11"	25'-4"	23'-4"	30'-8"	28'-10"	26'-7"	33'-11"	31'-10"	29'-5"
		20		20	21'-7"	20'-3"	18'-7"	25'-8"	24'-1"	22'-1"	29'-3"	27'-5"	25'-2"	32'-4"	30'-3"	27'-10"
	Snow 115%	25	10	22'-8"	21'-6"	20'-0"	27'-0"	25'-6"	23'-9"	30'-9"	29'-1"	27'-1"	34'-0"	32'-2"	29'-11"	
		25	15	21'-8"	20'-5"	18'-11"	25'-9"	24'-3"	22'-5"	29'-4"	27'-7"	25'-7"	31'-10"	30'-6"	28'-3"	
		30	10	21'-8"	20'-7"	19'-2"	25'-10"	24'-5"	22'-10"	29'-5"	27'-10"	26'-0"	31'-11"	30'-9"	28'-9"	
		30	15	20'-10"	19'-8"	18'-3"	24'-9"	23'-4"	21'-8"	28'-1"	26'-7"	24'-8"	30'-0"	29'-4"	27'-4"	
		40	10	19'-9"	18'-11"	17'-10"	23'-6"	22'-6"	21'-3"	26'-9"	25'-8"	24'-3"	28'-7"	28'-2"	26'-9"	
		40	15	19'-5"	18'-5"	17'-2"	23'-1"	21'-11"	20'-5"	25'-5"	24'-11"	23'-3"	27'-2"	26'-8"	25'-8"	
		50	10	18'-3"	17'-6"	16'-8"	21'-9"	20'-10"	19'-10"	24'-5"	23'-9"	22'-7"	26'-1"	25'-9"	24'-11"	
		50	15	18'-3"	17'-5"	16'-3"	21'-5"	20'-9"	19'-4"	23'-5"	23'-0"	22'-0"	25'-0"	24'-7"	24'-0"	
	19.2"	Non-Snow 125%	20	10	22'-6"	21'-2"	19'-8"	26'-9"	25'-2"	23'-5"	30'-5"	28'-8"	26'-8"	33'-8"	31'-9"	29'-5"
			20	15	21'-3"	20'-0"	18'-5"	25'-4"	23'-9"	21'-11"	28'-10"	27'-1"	25'-0"	31'-10"	29'-11"	27'-7"
			20	20	20'-3"	19'-0"	17'-6"	24'-2"	22'-7"	20'-9"	27'-6"	25'-9"	23'-8"	30'-2"	28'-5"	26'-2"
Snow 115%		25	10	21'-4"	20'-2"	18'-9"	25'-4"	24'-0"	22'-4"	28'-11"	27'-4"	25'-5"	31'-1"	30'-2"	28'-1"	
		25	15	20'-4"	19'-2"	17'-9"	24'-2"	22'-9"	21'-1"	27'-2"	25'-11"	24'-0"	29'-9"	28'-3"	26'-7"	
		30	10	20'-4"	19'-4"	18'-0"	24'-3"	23'-0"	21'-5"	27'-3"	26'-2"	24'-5"	29'-1"	28'-7"	27'-0"	
		30	15	19'-6"	18'-5"	17'-1"	23'-3"	21'-11"	20'-4"	25'-7"	25'-0"	23'-2"	27'-5"	26'-9"	25'-8"	
		40	10	18'-6"	17'-9"	16'-9"	22'-1"	21'-2"	20'-0"	24'-4"	24'-0"	22'-9"	26'-1"	25'-8"	25'-2"	
		40	15	18'-3"	17'-3"	16'-1"	21'-3"	20'-7"	19'-2"	23'-2"	22'-9"	21'-10"	24'-9"	24'-4"	23'-8"	
		50	10	17'-1"	16'-5"	15'-7"	20'-5"	19'-7"	18'-7"	22'-3"	22'-0"	21'-2"	23'-9"	23'-6"	23'-1"	
		50	15	17'-1"	16'-4"	15'-3"	19'-7"	19'-3"	18'-2"	21'-4"	21'-0"	20'-6"	22'-10"	22'-2"	21'-2"	
24"		Non-Snow 125%	20	10	20'-10"	19'-8"	18'-3"	24'-9"	23'-4"	21'-8"	28'-2"	26'-7"	24'-8"	31'-2"	29'-5"	27'-4"
			20	15	19'-8"	18'-6"	17'-1"	23'-5"	22'-0"	20'-4"	26'-8"	25'-1"	23'-2"	28'-11"	27'-9"	25'-7"
			20	20	18'-9"	17'-7"	16'-2"	22'-4"	22'-11"	19'-3"	25'-3"	23'-10"	21'-11"	26'-11"	26'-0"	24'-3"
	Snow 115%	25	10	19'-9"	18'-8"	17'-5"	23'-6"	22'-3"	20'-8"	26'-0"	25'-4"	23'-7"	27'-10"	27'-3"	26'-1"	
		25	15	18'-10"	17'-9"	16'-5"	22'-3"	21'-1"	19'-6"	24'-3"	23'-7"	22'-3"	25'-11"	25'-3"	24'-4"	
		30	10	18'-10"	17'-10"	16'-8"	22'-4"	21'-3"	19'-10"	24'-4"	23'-11"	22'-7"	26'-0"	25'-7"	24'-11"	
		30	15	18'-1"	17'-1"	15'-10"	21'-0"	20'-4"	18'-10"	22'-10"	22'-4"	21'-6"	24'-5"	23'-11"	23'-1"	
		40	10	17'-1"	16'-5"	15'-6"	20'-0"	19'-7"	18'-6"	21'-9"	21'-5"	21'-0"	23'-3"	22'-11"	22'-3"	
		40	15	16'-9"	16'-0"	14'-11"	19'-0"	18'-7"	17'-9"	20'-8"	20'-4"	19'-3"	21'-7"	20'-9"	19'-8"	
		50	10	15'-10"	15'-2"	14'-5"	18'-3"	18'-0"	17'-3"	19'-6"	19'-0"	18'-5"	19'-10"	19'-5"	18'-9"	
		50	15	15'-5"	15'-1"	14'-1"	17'-3"	16'-8"	15'-11"	17'-11"	17'-4"	16'-6"	18'-3"	17'-8"	16'-10"	



Maximum clear span in feet and inches, based on horizontal spans.

115% and 125% Load Duration													
		BCI® 60 2.0 Series 2 ⁵ / ₁₆ " Flange Width											
		11 ⁵ / ₁₆ " BCI® 60 2.0			14" BCI® 60 2.0			16" BCI® 60 2.0					
		Live Load [psf]	Dead Load [psf]	4/12 or Less	4/12 to 8/12	8/12 to 12/12	4/12 or Less	4/12 to 8/12	8/12 to 12/12	4/12 or Less	4/12 to 8/12	8/12 to 12/12	
12" o.c.	Non-Snow 125%	20	10	33'-7"	31'-8"	29'-5"	38'-4"	36'-1"	33'-6"	42'-5"	40'-0"	37'-1"	
		20	15	31'-10"	29'-11"	27'-7"	36'-3"	34'-1"	31'-5"	40'-2"	37'-8"	34'-10"	
		20	20	30'-4"	28'-5"	26'-2"	34'-7"	32'-5"	29'-9"	38'-4"	35'-10"	33'-0"	
	Snow 115%	25	10	31'-11"	30'-2"	28'-1"	36'-4"	34'-4"	32'-0"	40'-3"	38'-1"	35'-5"	
		25	15	30'-5"	28'-8"	26'-6"	34'-8"	32'-8"	30'-3"	38'-5"	36'-2"	33'-6"	
		30	10	30'-6"	28'-11"	26'-11"	34'-9"	32'-11"	30'-8"	38'-6"	36'-5"	34'-0"	
		30	15	29'-3"	27'-7"	25'-7"	33'-4"	31'-5"	29'-2"	36'-11"	34'-10"	32'-4"	
		40	10	27'-9"	26'-7"	25'-2"	31'-8"	30'-4"	28'-8"	35'-0"	33'-7"	31'-9"	
		40	15	27'-4"	25'-10"	24'-1"	31'-2"	29'-6"	27'-6"	34'-6"	32'-8"	30'-5"	
		50	10	25'-9"	24'-8"	23'-5"	29'-4"	28'-1"	26'-8"	32'-5"	31'-1"	29'-6"	
	50	15	25'-9"	24'-6"	22'-11"	29'-4"	27'-11"	26'-1"	32'-5"	30'-11"	28'-11"		
	16" o.c.	Non-Snow 125%	20	10	30'-5"	28'-9"	26'-8"	34'-9"	32'-9"	30'-5"	38'-5"	36'-3"	33'-8"
			20	15	28'-10"	27'-1"	25'-0"	32'-10"	30'-10"	28'-6"	36'-5"	34'-2"	31'-7"
			20	20	27'-6"	25'-9"	23'-8"	31'-4"	29'-4"	27'-0"	34'-9"	32'-6"	29'-11"
Snow 115%		25	10	28'-11"	27'-4"	25'-5"	32'-11"	31'-2"	29'-0"	36'-6"	34'-6"	32'-1"	
		25	15	27'-7"	26'-0"	24'-1"	31'-5"	29'-7"	27'-5"	34'-10"	32'-9"	30'-4"	
		30	10	27'-8"	26'-2"	24'-5"	31'-6"	29'-10"	27'-10"	34'-11"	33'-0"	30'-10"	
		30	15	26'-6"	25'-0"	23'-3"	30'-2"	28'-6"	26'-6"	33'-5"	31'-7"	29'-4"	
		40	10	25'-2"	24'-1"	22'-9"	28'-8"	27'-6"	26'-0"	31'-9"	30'-5"	28'-9"	
		40	15	24'-9"	23'-5"	21'-10"	28'-3"	26'-8"	24'-11"	31'-3"	29'-7"	27'-7"	
		50	10	23'-3"	22'-4"	21'-2"	26'-6"	25'-5"	24'-2"	29'-5"	28'-2"	26'-9"	
50		15	23'-3"	22'-2"	20'-9"	26'-6"	25'-3"	23'-8"	28'-7"	27'-8"	26'-2"		
19.2" o.c.		Non-Snow 125%	20	10	28'-7"	27'-0"	25'-1"	32'-7"	30'-9"	28'-7"	36'-1"	34'-1"	31'-7"
			20	15	27'-1"	25'-5"	23'-6"	30'-10"	29'-0"	26'-9"	34'-2"	32'-1"	29'-8"
			20	20	25'-10"	24'-2"	22'-3"	29'-5"	27'-7"	25'-4"	32'-7"	30'-6"	28'-1"
	Snow 115%	25	10	27'-2"	25'-8"	23'-11"	30'-11"	29'-3"	27'-3"	34'-3"	32'-5"	30'-2"	
		25	15	25'-11"	24'-5"	22'-7"	29'-6"	27'-10"	25'-9"	32'-8"	30'-9"	28'-6"	
		30	10	25'-11"	24'-7"	22'-11"	29'-7"	28'-0"	26'-2"	32'-9"	31'-0"	29'-0"	
		30	15	24'-11"	23'-6"	21'-10"	28'-4"	26'-9"	24'-10"	31'-5"	29'-8"	27'-6"	
		40	10	23'-7"	22'-8"	21'-5"	26'-11"	25'-10"	24'-5"	29'-10"	28'-7"	27'-0"	
		40	15	23'-3"	22'-0"	20'-6"	26'-6"	25'-1"	23'-5"	28'-1"	27'-0"	25'-7"	
		50	10	21'-10"	21'-0"	19'-11"	24'-11"	23'-11"	22'-8"	25'-10"	25'-3"	24'-5"	
	50	15	21'-10"	20'-10"	19'-6"	23'-9"	23'-0"	21'-11"	23'-9"	23'-0"	21'-11"		
	24" o.c.	Non-Snow 125%	20	10	26'-6"	25'-0"	23'-3"	30'-2"	28'-6"	26'-6"	33'-5"	31'-7"	29'-4"
			20	15	25'-1"	23'-7"	21'-9"	28'-7"	26'-10"	24'-10"	31'-8"	29'-9"	27'-6"
			20	20	23'-11"	22'-5"	20'-7"	27'-3"	25'-6"	23'-6"	30'-2"	28'-3"	26'-0"
Snow 115%		25	10	25'-2"	23'-9"	22'-2"	28'-8"	27'-1"	25'-3"	31'-9"	30'-0"	28'-0"	
		25	15	24'-0"	22'-7"	20'-11"	27'-4"	25'-9"	23'-10"	30'-3"	28'-6"	26'-5"	
		30	10	24'-0"	22'-9"	21'-3"	27'-5"	25'-11"	24'-3"	30'-4"	28'-9"	26'-10"	
		30	15	23'-0"	21'-9"	20'-2"	26'-3"	24'-9"	23'-0"	27'-4"	26'-1"	24'-5"	
		40	10	21'-10"	21'-0"	19'-10"	24'-9"	23'-11"	22'-7"	24'-9"	24'-1"	23'-1"	
		40	15	21'-6"	20'-4"	19'-0"	22'-5"	21'-6"	20'-5"	22'-5"	21'-6"	20'-5"	
		50	10	20'-2"	19'-5"	18'-5"	20'-8"	20'-2"	19'-6"	20'-8"	20'-2"	19'-6"	
50		15	19'-0"	18'-4"	17'-6"	19'-0"	18'-4"	17'-6"	19'-0"	18'-4"	17'-6"		

- Table values are limited by shear, moment, total load deflection equal to L/180 and live load deflection equal to L/240. Check the local building code for other deflection limits that may apply.
- Table values represent the most restrictive of simple or multiple span applications.
- Table values assume minimum bearing lengths without web stiffeners for joist depths of 16 inches and less. 18 and 20 inch joists require web stiffeners.
- This table was designed to apply to a broad range of applications. It may be possible to exceed the limitations of this table by analyzing a specific application with the BC CALC® software.
- Slope roof joists at least 1/4" over 12" to minimize ponding.
- Allowable spans and loads shall be adjusted and checked for wind load as required by local building code.

Roof Span Tables

Maximum clear span in feet and inches, based on horizontal spans.

115% and 125% Load Duration

			BCI® 90 2.0 Series 3 1/2" Flange Width																		
			11 7/8" BCI® 90 2.0			14" BCI® 90 2.0			16" BCI® 90 2.0			18" BCI® 90 2.0			20" BCI® 90 2.0						
			4/12 or Less	4/12 to 8/12	8/12 to 12/12	4/12 or Less	4/12 to 8/12	8/12 to 12/12	4/12 or Less	4/12 to 8/12	8/12 to 12/12	4/12 or Less	4/12 to 8/12	8/12 to 12/12	4/12 or Less	4/12 to 8/12	8/12 to 12/12	4/12 or Less	4/12 to 8/12	8/12 to 12/12	
o.c.	Load	Live	Dead																		
		Load [psf]	Load [psf]																		
12"	Non-Snow 125%	20	10	38'-5"	36'-3"	33'-8"	43'-7"	41'-2"	38'-2"	48'-4"	45'-7"	42'-3"	50'-0"	49'-9"	46'-2"	50'-0"	50'-0"	50'-0"	50'-0"	50'-0"	
		20	15	36'-5"	34'-2"	31'-7"	41'-4"	38'-10"	35'-10"	45'-9"	43'-0"	39'-8"	50'-0"	46'-11"	43'-4"	50'-0"	50'-0"	50'-0"	50'-0"	46'-11"	
		20	20	34'-9"	32'-6"	29'-11"	39'-5"	36'-11"	33'-11"	43'-8"	40'-10"	37'-7"	47'-8"	44'-8"	41'-1"	50'-0"	48'-4"	44'-5"			
	Snow 115%	25	10	36'-6"	34'-6"	32'-1"	41'-5"	39'-2"	36'-5"	45'-10"	43'-4"	40'-4"	50'-0"	47'-5"	44'-1"	50'-0"	50'-0"	47'-9"			
		25	15	34'-10"	32'-9"	30'-4"	39'-6"	37'-2"	34'-5"	43'-9"	41'-2"	38'-2"	47'-10"	45'-0"	41'-8"	50'-0"	48'-8"	45'-1"			
		30	10	34'-11"	33'-1"	30'-10"	39'-7"	37'-6"	35'-0"	43'-10"	41'-6"	38'-9"	47'-11"	45'-5"	42'-4"	50'-0"	49'-1"	45'-10"			
		30	15	33'-5"	31'-7"	29'-4"	38'-0"	35'-10"	33'-3"	42'-1"	39'-8"	36'-10"	45'-11"	43'-4"	40'-3"	49'-9"	46'-11"	43'-7"			
		40	10	31'-9"	30'-5"	28'-9"	36'-0"	34'-7"	32'-8"	39'-11"	38'-3"	36'-2"	43'-7"	41'-10"	39'-6"	47'-2"	45'-3"	42'-9"			
		40	15	31'-3"	29'-7"	27'-7"	35'-6"	33'-7"	31'-3"	39'-3"	37'-2"	34'-8"	42'-11"	40'-8"	37'-10"	46'-5"	44'-0"	41'-0"			
		50	10	29'-5"	28'-2"	26'-9"	33'-4"	32'-0"	30'-5"	36'-11"	35'-5"	33'-8"	40'-5"	38'-9"	36'-9"	43'-8"	41'-11"	39'-10"			
	50	15	29'-5"	28'-0"	26'-2"	33'-4"	31'-9"	29'-8"	36'-11"	35'-3"	32'-11"	40'-5"	38'-6"	36'-0"	43'-8"	41'-8"	38'-11"				
	16"	Non-Snow 125%	20	10	34'-10"	32'-10"	30'-6"	39'-6"	37'-4"	34'-7"	43'-9"	41'-4"	38'-4"	47'-10"	45'-2"	41'-11"	50'-0"	48'-10"	45'-4"		
20			15	33'-0"	31'-0"	28'-7"	37'-5"	35'-2"	32'-6"	41'-5"	38'-11"	36'-0"	45'-4"	42'-7"	39'-4"	49'-0"	46'-1"	42'-6"			
20			20	31'-6"	29'-6"	27'-1"	35'-8"	33'-5"	30'-9"	39'-7"	37'-0"	34'-1"	43'-3"	40'-6"	37'-3"	46'-9"	43'-10"	40'-3"			
Snow 115%		25	10	33'-1"	31'-3"	29'-1"	37'-6"	35'-6"	33'-1"	41'-7"	39'-4"	36'-7"	45'-5"	42'-11"	40'-0"	49'-2"	46'-6"	43'-3"			
		25	15	31'-6"	29'-8"	27'-6"	35'-9"	33'-8"	31'-3"	39'-8"	37'-4"	34'-7"	43'-4"	40'-10"	37'-9"	46'-10"	44'-2"	40'-11"			
		30	10	31'-7"	29'-11"	27'-11"	35'-10"	34'-0"	31'-9"	39'-9"	37'-8"	35'-2"	43'-5"	41'-2"	38'-5"	47'-0"	44'-6"	41'-6"			
		30	15	30'-4"	28'-7"	26'-7"	34'-5"	32'-5"	30'-2"	38'-1"	35'-11"	33'-5"	41'-7"	39'-3"	36'-6"	45'-0"	42'-6"	39'-6"			
		40	10	28'-9"	27'-7"	26'-1"	32'-7"	31'-4"	29'-7"	36'-2"	34'-8"	32'-9"	39'-6"	37'-11"	35'-10"	42'-9"	41'-0"	38'-9"			
		40	15	28'-4"	26'-9"	25'-0"	32'-1"	30'-5"	28'-4"	35'-7"	33'-8"	31'-5"	38'-10"	36'-10"	34'-4"	42'-1"	39'-10"	37'-2"			
		50	10	26'-7"	25'-6"	24'-3"	30'-2"	29'-0"	27'-6"	33'-5"	32'-1"	30'-6"	36'-7"	35'-1"	33'-4"	39'-7"	38'-0"	36'-1"			
50		15	26'-7"	25'-4"	23'-9"	30'-2"	28'-9"	26'-11"	33'-5"	31'-11"	29'-10"	36'-7"	34'-10"	32'-7"	39'-7"	37'-8"	35'-3"				
19.2"		Non-Snow 125%	20	10	32'-9"	30'-11"	28'-8"	37'-2"	35'-0"	32'-6"	41'-2"	38'-10"	36'-0"	44'-11"	42'-5"	39'-4"	48'-8"	45'-11"	42'-7"		
	20		15	31'-0"	29'-1"	26'-11"	35'-2"	33'-0"	30'-6"	38'-11"	36'-7"	33'-9"	42'-7"	40'-0"	36'-11"	46'-0"	43'-3"	39'-11"			
	20		20	29'-6"	27'-8"	25'-5"	33'-6"	31'-5"	28'-11"	37'-2"	34'-9"	32'-0"	40'-7"	38'-0"	35'-0"	43'-11"	41'-2"	37'-10"			
	Snow 115%	25	10	31'-1"	29'-5"	27'-4"	35'-3"	33'-4"	31'-1"	39'-0"	36'-11"	34'-5"	42'-8"	40'-4"	37'-7"	46'-2"	43'-8"	40'-8"			
		25	15	29'-7"	27'-11"	25'-10"	33'-7"	31'-8"	29'-4"	37'-3"	35'-1"	32'-6"	40'-8"	38'-4"	35'-6"	44'-0"	41'-6"	38'-5"			
		30	10	29'-8"	28'-1"	26'-3"	33'-8"	31'-11"	29'-10"	37'-4"	35'-4"	33'-0"	40'-9"	38'-8"	36'-1"	44'-1"	41'-10"	39'-0"			
		30	15	28'-5"	26'-10"	24'-11"	32'-3"	30'-6"	28'-4"	35'-9"	33'-9"	31'-4"	39'-1"	36'-11"	34'-3"	42'-3"	39'-11"	37'-1"			
		40	10	27'-0"	25'-11"	24'-6"	30'-7"	29'-5"	27'-9"	33'-11"	32'-7"	30'-9"	37'-1"	35'-7"	33'-7"	40'-1"	38'-6"	36'-5"			
		40	15	26'-7"	25'-2"	23'-5"	30'-2"	28'-7"	26'-7"	33'-5"	31'-7"	29'-6"	36'-6"	34'-7"	32'-3"	39'-6"	37'-5"	34'-11"			
		50	10	24'-11"	24'-0"	22'-9"	28'-4"	27'-2"	25'-10"	31'-5"	30'-2"	28'-8"	34'-4"	32'-11"	31'-4"	37'-1"	35'-8"	33'-10"			
	50	15	24'-11"	23'-10"	22'-3"	28'-4"	27'-0"	25'-3"	29'-8"	28'-8"	27'-5"	34'-4"	32'-8"	30'-7"	37'-1"	35'-5"	33'-1"				
	24"	Non-Snow 125%	20	10	30'-4"	28'-7"	26'-7"	34'-5"	32'-5"	30'-2"	38'-1"	35'-11"	33'-5"	41'-7"	39'-3"	36'-6"	45'-0"	42'-6"	39'-6"		
20			15	28'-8"	26'-11"	24'-11"	32'-6"	30'-7"	28'-3"	36'-1"	33'-11"	31'-4"	39'-5"	37'-0"	34'-2"	42'-8"	40'-1"	37'-0"			
20			20	27'-4"	25'-7"	23'-7"	31'-0"	29'-1"	26'-9"	34'-4"	32'-2"	29'-8"	37'-7"	35'-2"	32'-5"	40'-8"	38'-1"	35'-1"			
Snow 115%		25	10	28'-9"	27'-2"	25'-4"	32'-7"	30'-10"	28'-9"	36'-2"	34'-2"	31'-10"	39'-6"	37'-4"	34'-10"	42'-9"	40'-5"	37'-8"			
		25	15	27'-5"	25'-10"	23'-11"	31'-1"	29'-4"	27'-2"	34'-5"	32'-6"	30'-1"	37'-8"	35'-6"	32'-11"	40'-9"	38'-5"	35'-7"			
		30	10	27'-6"	26'-0"	24'-4"	31'-2"	29'-7"	27'-7"	34'-6"	32'-9"	30'-7"	37'-9"	35'-9"	33'-5"	40'-10"	38'-9"	36'-2"			
		30	15	26'-4"	24'-10"	23'-1"	29'-10"	28'-2"	26'-3"	33'-1"	31'-3"	29'-1"	36'-2"	34'-2"	31'-9"	39'-2"	37'-0"	34'-4"			
		40	10	24'-11"	24'-0"	22'-8"	28'-4"	27'-2"	25'-9"	30'-11"	30'-0"	28'-6"	34'-4"	32'-11"	31'-2"	37'-1"	35'-8"	33'-8"			
		40	15	24'-7"	23'-3"	21'-9"	27'-9"	26'-5"	24'-8"	28'-0"	26'-11"	25'-6"	33'-9"	32'-0"	29'-10"	35'-2"	33'-10"	32'-1"			
		50	10	23'-1"	22'-2"	21'-1"	25'-7"	24'-11"	23'-11"	25'-9"	25'-2"	24'-4"	31'-3"	30'-6"	29'-0"	32'-5"	31'-8"	30'-7"			
50		15	23'-1"	22'-0"	20'-7"	23'-6"	22'-9"	21'-8"	23'-8"	22'-11"	21'-10"	28'-9"	27'-10"	26'-7"	29'-10"	28'-10"	27'-6"				



Allowable Uniform Roof Load (in pounds per linear foot [PLF])

115% and 125% Load Duration

Use of these tables should be limited to roof slopes of 3½" per foot or less.
For steeper slopes, see pages 15-18.

Span Length	BCI® 5000 1.7 Series 2" Flange Width								
	9½" BCI® 5000 1.7			11⅞" BCI® 5000 1.7			14" BCI® 5000 1.7		
	Total Load		Deflect.	Total Load		Deflect.	Total Load		Deflect.
	Snow (115%)	Non-Snow (125%)	L/240	Snow (115%)	Non-Snow (125%)	L/240	Snow (115%)	Non-Snow (125%)	L/240
6	315	343	-	338	367	-	353	383	-
7	270	294	-	289	315	-	302	329	-
8	236	257	-	253	275	-	264	287	-
9	210	228	-	225	245	-	235	255	-
10	189	205	-	202	220	-	211	230	-
11	172	187	-	184	200	-	192	209	-
12	154	167	-	169	183	-	176	191	-
13	131	142	-	156	169	-	162	177	-
14	113	123	110	144	157	-	151	164	-
15	98	107	90	126	137	-	141	153	-
16	86	94	75	110	120	-	131	142	-
17	76	82	63	98	106	-	116	126	-
18	68	70	53	87	95	-	103	112	-
19	59	59	45	78	85	74	93	101	-
20	51	51	39	71	77	64	84	91	-
21				64	70	55	76	83	-
22				58	63	48	69	75	-
23				53	55	42	63	69	62
24							58	63	55
25							53	58	49
26									
27									
28									

- Total Load values are limited by shear, moment, or deflection equal to L/180.
- Deflection values (Deflect.) are limited by live load deflection equal to L/240. Check the local building code for other deflection limits that may apply.
- Both the Total Load and Deflection columns must be checked. Where a Deflection value is not shown, the Total Load value will control.
- Table values apply to either simple or multiple span joists. Span is measured center to center of the minimum required bearing length. Analyze multiple span joists with the BC CALC® software if the length of any span is less than half the length of an adjacent span.
- Slope roof joists at least ¼ inch over 12 inches to minimize ponding.
- Table values assume minimum bearing lengths without web stiffeners for joist depths of 16 inches and less. 18 and 20 inch joists require web stiffeners.
- This table was designed to apply to a broad range of applications. It may be possible to exceed the limitations of this table by analyzing a specific application with the BC CALC® software.
- Allowable spans and loads shall be adjusted and checked for wind load as required by local building code.

Allowable Uniform Roof Load (in pounds per linear foot [PLF])

115% and 125% Load Duration

Use of these tables should be limited to roof slopes of 3½" per foot or less.
For steeper slopes, see pages 15-18.

Span Length	BCI® 6000 1.8 Series 2 ⁵ / ₁₆ " Flange Width											
	9½" BCI® 6000 1.8			11⅞" BCI® 6000 1.8			14" BCI® 6000 1.8			16" BCI® 6000 1.8		
	Total Load		Deflect.	Total Load		Deflect.	Total Load		Deflect.	Total Load		Deflect.
	Snow (115%)	Non-Snow (125%)	L/240	Snow (115%)	Non-Snow (125%)	L/240	Snow (115%)	Non-Snow (125%)	L/240	Snow (115%)	Non-Snow (125%)	L/240
6	360	392	-	375	408	-	390	424	-	398	432	-
7	309	336	-	322	350	-	334	364	-	341	371	-
8	270	294	-	281	306	-	293	318	-	298	324	-
9	240	261	-	250	272	-	260	283	-	265	288	-
10	216	235	-	225	245	-	234	254	-	238	259	-
11	196	213	-	204	222	-	213	231	-	217	236	-
12	180	196	-	187	204	-	195	212	-	199	216	-
13	166	180	159	173	188	-	180	196	-	183	199	-
14	145	158	129	161	175	-	167	182	-	170	185	-
15	126	137	106	150	163	-	156	169	-	159	173	-
16	111	115	88	140	153	-	146	159	-	149	162	-
17	97	97	74	126	137	122	137	149	-	140	152	-
18	82	82	63	112	122	103	130	141	-	132	144	-
19	70	70	53	101	110	89	120	130	-	125	136	-
20	60	60	46	91	99	76	108	117	-	119	129	-
21	52	52	40	83	87	66	98	107	97	112	122	-
22				75	76	58	89	97	85	102	111	-
23				67	67	51	82	89	75	93	101	-
24				59	59	45	75	81	66	86	93	-
25				52	52	40	69	75	58	79	86	78
26							64	68	52	73	79	70
27							59	61	47	67	73	63
28							55	55	42	63	68	56



Allowable Uniform Roof Load (in pounds per linear foot [PLF])

115% and 125% Load Duration

Use of these tables should be limited to roof slopes of 3½" per foot or less.
For steeper slopes, see pages 15-18.

Span Length	BCI® 6500 1.8 Series 2 ⁹ / ₁₆ " Flange Width											
	9½" BCI® 6500 1.8			11⅞" BCI® 6500 1.8			14" BCI® 6500 1.8			16" BCI® 6500 1.8		
	Total Load		Deflect.	Total Load		Deflect.	Total Load		Deflect.	Total Load		Deflect.
	Snow (115%)	Non-Snow (125%)	L/240	Snow (115%)	Non-Snow (125%)	L/240	Snow (115%)	Non-Snow (125%)	L/240	Snow (115%)	Non-Snow (125%)	L/240
6	360	392	-	375	408	-	390	424	-	398	432	-
7	309	336	-	322	350	-	334	364	-	341	371	-
8	270	294	-	281	306	-	293	318	-	298	324	-
9	240	261	-	250	272	-	260	283	-	265	288	-
10	216	235	-	225	245	-	234	254	-	238	259	-
11	196	213	-	204	222	-	213	231	-	217	236	-
12	180	196	-	187	204	-	195	212	-	199	216	-
13	166	180	-	173	188	-	180	196	-	183	199	-
14	154	168	141	161	175	-	167	182	-	170	185	-
15	140	152	116	150	163	-	156	169	-	159	173	-
16	123	126	97	140	153	-	146	159	-	149	162	-
17	106	106	81	132	144	-	137	149	-	140	152	-
18	90	90	69	125	135	114	130	141	-	132	144	-
19	77	77	59	112	122	97	123	134	-	125	136	-
20	66	66	51	101	110	84	117	127	-	119	129	-
21	57	57	44	91	95	73	108	118	106	113	123	-
22	50	50	38	83	83	64	99	107	92	108	118	-
23				73	73	56	90	98	81	103	112	-
24				64	64	49	83	90	72	95	103	-
25				57	57	44	76	83	64	87	95	85
26				51	51	39	71	74	57	81	88	76
27							65	67	51	75	81	68
28							60	60	46	69	76	61
29							54	54	41	65	70	55
30										60	66	50
31										57	60	45
32										53	54	41
33										50	50	38
34												
35												

- Total Load values are limited by shear, moment, or deflection equal to L/180.
- Deflection values (Deflect.) are limited by live load deflection equal to L/240. Check the local building code for other deflection limits that may apply.
- Both the Total Load and Deflection columns must be checked. Where a Deflection value is not shown, the Total Load value will control.
- Table values apply to either simple or multiple span joists. Span is measured center to center of the minimum required bearing length. Analyze multiple span joists with the BC CALC® software if the length of any span is less than half the length of an adjacent span.
- Slope roof joists at least ¼ inch over 12 inches to minimize ponding.
- Table values assume minimum bearing lengths without web stiffeners for joist depths of 16 inches and less. 18 and 20 inch joists require web stiffeners.
- This table was designed to apply to a broad range of applications. It may be possible to exceed the limitations of this table by analyzing a specific application with the BC CALC® software.
- Allowable spans and loads shall be adjusted and checked for wind load as required by local building code.

Allowable Uniform Roof Load (in pounds per linear foot [PLF])

115% and 125% Load Duration

Use of these tables should be limited to roof slopes of 3½" per foot or less.
For steeper slopes, see pages 15-18.

Span Length	BCI® 60 2.0 Series 2 ⁵ / ₁₆ " Flange Width								
	11⅞" BCI® 60 2.0			14" BCI® 60 2.0			16" BCI® 60 2.0		
	Total Load		Deflect.	Total Load		Deflect.	Total Load		Deflect.
	Snow (115%)	Non-Snow (125%)	L/240	Snow (115%)	Non-Snow (125%)	L/240	Snow (115%)	Non-Snow (125%)	L/240
6	413	449	-	413	449	-	413	449	-
7	354	385	-	354	385	-	354	385	-
8	309	336	-	309	336	-	309	336	-
9	275	299	-	275	299	-	275	299	-
10	247	269	-	247	269	-	247	269	-
11	225	245	-	225	245	-	225	245	-
12	206	224	-	206	224	-	206	224	-
13	190	207	-	190	207	-	190	207	-
14	177	192	-	177	192	-	177	192	-
15	165	179	-	165	179	-	165	179	-
16	154	168	-	154	168	-	154	168	-
17	145	158	-	145	158	-	145	158	-
18	137	149	-	137	149	-	137	149	-
19	130	141	118	130	141	-	130	141	-
20	123	133	102	123	134	-	123	134	-
21	116	116	88	118	128	-	118	128	-
22	101	101	77	112	122	-	112	122	-
23	89	89	68	107	117	99	107	117	-
24	79	79	60	103	112	88	103	112	-
25	70	70	53	99	102	78	99	107	-
26	62	62	47	91	91	69	95	103	93
27	56	56	42	81	81	62	91	99	84
28	50	50	38	73	73	56	88	96	75
29				66	66	50	85	89	68
30				60	60	46	81	81	61
31				54	54	41	73	73	56
32							67	67	51
33							61	61	46
34							56	56	43
35							51	51	39



Allowable Uniform Roof Load (in pounds per linear foot [PLF])

115% and 125% Load Duration

Use of these tables should be limited to roof slopes of 3 1/2" per foot or less.
For steeper slopes, see pages 15-18.

Span Length	BCI® 90 2.0 Series 3 1/2" Flange Width														
	11 7/8" BCI® 90 2.0			14" BCI® 90 2.0			16" BCI® 90 2.0			18" BCI® 90 2.0			20" BCI® 90 2.0		
	Total Load		Deflect.	Total Load		Deflect.	Total Load		Deflect.	Total Load		Deflect.	Total Load		Deflect.
	Snow (115%)	Non-Snow (125%)	L/240	Snow (115%)	Non-Snow (125%)	L/240	Snow (115%)	Non-Snow (125%)	L/240	Snow (115%)	Non-Snow (125%)	L/240	Snow (115%)	Non-Snow (125%)	L/240
6	507	551	-	510	555	-	514	559	-	623	677	-	646	702	-
7	434	472	-	437	476	-	441	479	-	534	581	-	553	602	-
8	380	413	-	383	416	-	385	419	-	467	508	-	484	526	-
9	338	367	-	340	370	-	343	372	-	415	451	-	430	468	-
10	304	330	-	306	333	-	308	335	-	374	406	-	387	421	-
11	276	300	-	278	302	-	280	305	-	340	369	-	352	383	-
12	253	275	-	255	277	-	257	279	-	311	338	-	323	351	-
13	234	254	-	235	256	-	237	258	-	287	312	-	298	324	-
14	217	236	-	218	238	-	220	239	-	267	290	-	276	301	-
15	202	220	-	204	222	-	205	223	-	249	271	-	258	280	-
16	190	206	-	191	208	-	192	209	-	233	254	-	242	263	-
17	178	194	-	180	196	-	181	197	-	220	239	-	228	247	-
18	169	183	-	170	185	-	171	186	-	207	225	-	215	234	-
19	160	174	-	161	175	-	162	176	-	196	214	-	204	221	-
20	152	165	148	153	166	-	154	167	-	187	203	-	193	210	-
21	144	157	129	145	158	-	147	159	-	178	193	-	184	200	-
22	138	148	113	139	151	-	140	152	-	170	184	-	176	191	-
23	130	130	100	133	144	-	134	145	-	162	176	-	168	183	-
24	115	115	88	127	138	126	128	139	-	155	169	-	161	175	-
25	103	103	78	122	133	112	123	134	-	149	162	-	155	168	-
26	92	92	70	117	128	100	118	129	-	143	156	-	149	162	-
27	82	82	63	113	118	90	114	124	-	138	150	-	143	156	-
28	74	74	56	106	106	81	110	119	109	133	145	-	138	150	-
29	67	67	51	96	96	73	106	115	98	129	140	127	133	145	-
30	60	60	46	87	87	67	102	111	89	124	135	115	129	140	-
31	55	55	42	79	79	60	99	106	81	120	131	105	125	135	-
32	50	50	38	72	72	55	96	97	74	116	125	96	121	131	120
33				66	66	50	89	89	68	113	114	88	117	127	110
34				60	60	46	81	81	62	105	105	80	114	123	101
35				56	56	42	75	75	57	97	97	74	110	120	93

- Total Load values are limited by shear, moment, or deflection equal to L/180.
- Deflection values (Deflect.) are limited by live load deflection equal to L/240. Check the local building code for other deflection limits that may apply.
- Both the Total Load and Deflection columns must be checked. Where a Deflection value is not shown, the Total Load value will control.

- Table values apply to either simple or multiple span joists. Span is measured center to center of the minimum required bearing length. Analyze multiple span joists with the BC CALC® software if the length of any span is less than half the length of an adjacent span.
- Slope roof joists at least 1/4 inch over 12 inches to minimize ponding.
- Table values assume minimum bearing lengths without web stiffeners for joist

- depths of 16 inches and less. 18 and 20 inch joists require web stiffeners.
- This table was designed to apply to a broad range of applications. It may be possible to exceed the limitations of this table by analyzing a specific application with the BC CALC® software.
- Allowable spans and loads shall be adjusted and checked for wind load as required by local building code.

BCI® Joist Series	Depth [inches]	Weight [plf]	Moment [ft-lbs]	EI x 10 ⁶ [lb-in ²]	K x 10 ⁶ [lbs]	Shear [lbs]	End Reaction [lbs]				Intermediate Reaction [lbs]			
							1½" Bearing		3½" Bearing		3½" Bearing		5¼" Bearing	
							No WS ⁽¹⁾	WS ⁽²⁾	No WS ⁽¹⁾	WS ⁽²⁾	No WS ⁽¹⁾	WS ⁽²⁾	No WS ⁽¹⁾	WS ⁽²⁾
5000 1.7	9½	2.0	2460	160	5.0	1475	950	1125	1125	1275	2100	2350	2525	2750
	11⅞	2.3	3150	265	6.0	1625	950	1425	1425	1475	2250	2850	2525	3000
	14	2.5	3735	390	8.0	1825	950	1525	1475	1725	2350	3050	2525	3200
6000 1.8	9½	2.2	3165	190	5.0	1575	1175	1375	1375	1425	2400	2650	2700	2750
	11⅞	2.5	4060	320	6.0	1675	1175	1425	1425	1475	2500	2850	2900	3000
	14	2.7	4815	470	8.0	1925	1175	1525	1525	1725	2600	3150	2925	3200
	16	2.9	5495	635	9.0	2175	1175	1625	1550	1975	2650	3350	2950	3350
6500 1.8	9½	2.3	3505	210	5.0	1575	1175	1375	1375	1425	2400	2650	2700	2750
	11⅞	2.6	4495	350	7.0	1675	1175	1425	1425	1475	2500	2850	2900	3000
	14	3.0	5330	515	8.0	1925	1175	1525	1525	1725	2600	3150	2925	3200
	16	3.2	6085	695	9.0	2175	1175	1625	1550	1975	2650	3350	2950	3350
60 2.0	11⅞	2.9	6235	430	7.0	1675	1175	1425	1425	1475	2750	2850	3200	3250
	14	3.1	7440	635	8.0	1925	1175	1525	1525	1725	2750	3450	3200	3650
	16	3.3	8520	860	9.0	2175	1175	1625	1550	1975	2750	3650	3200	3750
90 2.0	11⅞	3.9	9550	645	7.0	2150	1425	1850	1800	1950	3375	3700	4000	4300
	14	4.1	11390	940	8.0	2350	1450	1950	1850	2150	3400	3850	4100	4450
	16	4.4	13050	1275	9.0	2550	1475	2150	1900	2350	3425	4000	4200	4650
	18	4.6	14690	1660	10.0	2750	N/A ⁽³⁾	2300	N/A ⁽³⁾	2550	N/A ⁽³⁾	4150	N/A ⁽³⁾	4750
	20	4.8	16310	2100	11.0	2850	N/A ⁽³⁾	2500	N/A ⁽³⁾	2650	N/A ⁽³⁾	4300	N/A ⁽³⁾	4850

NOTES:

- (1) No web stiffeners required.
- (2) Web stiffeners required.
 - Moment, shear and reactions values based upon a load duration of 100% and may be adjusted for other load durations.
 - Design values listed are applicable for Allowable Stress Design (ASD).
 - No additional repetitive member increase allowed.

$$\Delta = \frac{5wl^4}{384EI} + \frac{wl^2}{K}$$

Δ = deflection [in]
 w = uniform load [lb/in]
 l = clear span [in]
 EI = bending stiffness [lb-in²]
 K = shear deformation coefficient [lb]

BUILDING CODE EVALUATION REPORTS

- ICC ESR 1336 (IBC, IRC)

BCI® Closest Allowable Nail Spacing

Nailing Perpendicular to Glue Lines (Wide Face)

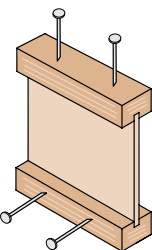

Nailing Parallel to Glue Lines (Narrow Face)

Nail Size	All BCI® Joists			
	Nailing Perpendicular to Glue Line (Wide Face)		Nailing Parallel to Glue Line (Narrow Face)	
	O.C. Spacing [inches]	End of Joist [inches]	O.C. Spacing [inches]	End of Joist [inches]
8d Box	2	1½	4	1½
8d Common	2	1½	4	3
10d & 12d Box	2	1½	4	3
16d Box	2	1½	4	3
10d & 12d Common	3	2	6	4
16d Sinker	3	2	6	4
16d Common	3	2	6	4

- If more than one row of nails is used, the rows must be offset at least ½ inch.
- Simpson Strong-Tie A35 connectors may be attached to the side of BCI® 60 & 90 joist flanges only. Use nails as specified by Simpson Strong-Tie; do not attach connectors on both sides of a flange at the same location.

BCI® Diaphragm Table ⁽¹⁾

BCI® Series	Diaphragm Capacity ⁽²⁾⁽³⁾ [lb/ft]	
	Unblocked	Blocked
5000	As permitted for 2x framing in building code	320 lb/ft for 6" o.c. nailing @ panel edges 425 lb/ft for 4" o.c. nailing, staggered, @ panel edges
6000, 6500	As permitted for 3x framing in building code	360 lb/ft for 6" o.c. nailing @ panel edges 480 lb/ft for 4" o.c. nailing, staggered @ panel edges
60, 90	As permitted for 3x framing in building code	As permitted for 3x framing in building code with nail spacing no closer than 3" o.c.

NOTES:

- (1) See table 6 of ICC ESR 1336.
- (2) BCI joists may be substituted for solid sawn framing in horizontal wood diaphragms as shown in Table 2306.3.1 of the IBC.
- (3) Limits controlled by BCI closest allowable nail spacing limits.

Boise Cascade Rimboard Product Profiles

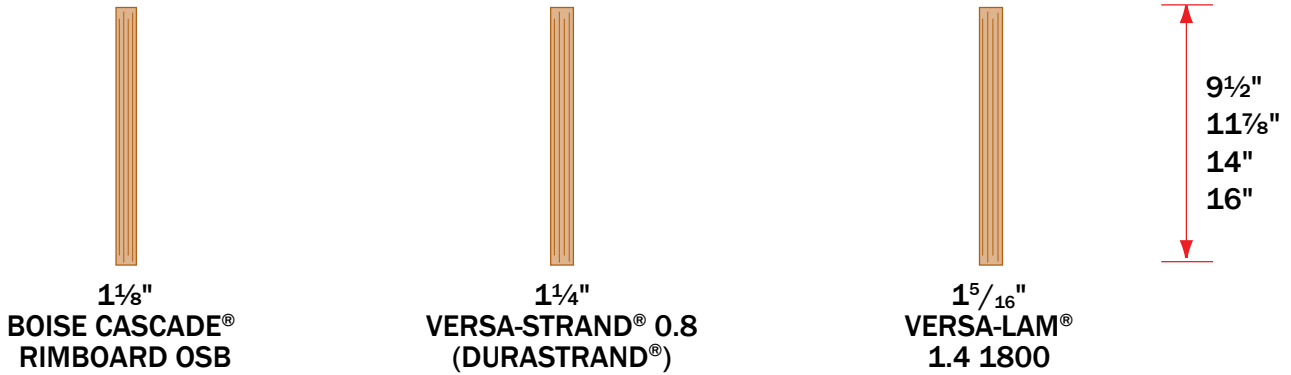

*18 inch and 20 inch deep rimboard are special order products, contact local supplier or Boise Cascade representative for product availability.

F07 **Perpendicular**
See chart for vertical load capacity.

Min. 8d nails @ 6" o.c. per IRC.
Connection per design professional of record's specification for shear transfer.

F07A **Parallel**
See chart for vertical load capacity.

Min. 8d nails @ 6" o.c. per IRC.
Connection per design professional of record's specification for shear transfer.

F56

1/2" dia through bolts (ASTM A307 Grades A&B, SAE J429 Grades 1 or 2, or higher) with washers and nuts or 1/2" dia lag screws (full penetration)
350 lb capacity for 1 1/8" & thicker rim, 300 lb capacity for 1" rim, per fastener

Exterior wood sheathing

Treated Ledger - Use only fasteners that are approved for use with corresponding wood treatment.

Boise Cascade Rimboard

Design of moisture control by others (only structural components shown above)

For information regarding connection of exterior decks to interior floor systems per the 2009 IRC, section 502.2.2.3, contact Boise Cascade EWP Engineering.

Boise Cascade Rimboard Properties

Product	Type	Vertical Load Capacity				Maximum Floor Diaphragm Lateral Capacity [lb/ft]	Specific Gravity for Lateral Nail Design	Allowable Design Values			
		Uniform [plf]		Point [lb]				Flexural Stress [lb/in ²]	Modulus of Elasticity [lb/in ²]	Horizontal Shear [lb/in ²]	Compression Perpendicular to Grain [lb/in ²]
		16" Depth & Less	18" & 20" Depth	16" Depth & Less	18" & 20" Depth						
1 1/8" BC RIM BOARD™ OSB ⁽²⁾	OSB	4850	3200	3500	3500	200	0.5	Limited span capabilities, see note 2			
1 1/4" VERSA-STRAND™ 0.8 (DURA-STRAND) ⁽³⁾	OSB	5700	3500	5900	5500	240 w/ 8d nails @ 6" o.c. 330 w/ 8d nails @ 4" o.c.	---	1130	800,000	355	1415
1 5/16" VERSA-LAM® 1.4 1800 ⁽¹⁾	LVL	6000	5450	4450	4450	Permitted per building code for all nominal 2" thick framing blocked and unblocked diaphragms (4" nail spacing & greater)	0.5	1800	1,400,000	225	525

Product	Closest Allowable Nail Spacing - Narrow Face [in]					
	8d Box	8d Common	10d & 12d Box	16d Box	10d, 12d Common & 16d Sinker	16d Common
1 1/8" BC RIM BOARD™ OSB ⁽²⁾	3	3	See note 2 for nailing information			
1 1/4" VERSA-STRAND™ 0.8 ⁽³⁾	4	4	4	4	4	6
1 5/16" VERSA-LAM® 1.4 1800 ⁽¹⁾	3	3	3	3	4	6

Notes

1. See ICC ESR 1040 for further product information.
2. See *Performance Rated Rim Boards, APA EWS #W345J* for further product information.
3. See ICC ESR 1053 for further product information.
4. Not all products and depths may be available. Check with Boise Cascade representative for product availability.

An Introduction to VERSA-LAM® Products



When you specify VERSA-LAM® laminated veneer headers/beams, you are building quality into your design. They are excellent as floor and roof framing supports or as headers for doors, windows and garage doors and columns.

Because they have no camber, VERSA-LAM® LVL products provide flatter, quieter floors, and consequently, the builder can expect happier customers with significantly fewer call backs.

VERSA-LAM® Beam Architectural Specifications

Scope: This work includes the complete furnishing and installation of all VERSA-LAM® beams as shown on the drawings, herein specified and necessary to complete the work.

Materials: Douglas Fir-Larch veneers, laminated in a press with all grain parallel with the length of the member. Glues used in lamination are phenol formaldehyde and isocyanate exterior-type adhesives which comply with ASTM D2559.

Design: VERSA-LAM® beams shall be sized and detailed to fit the dimensions and loads indicated on the plans. All designs shall be in accordance with allowable values developed in accordance with ASTM D5456 and listed in the governing code evaluation service's report and

section properties based upon standard engineering principles. Verification of design of the VERSA-LAM® beams by complete calculations shall be available upon request.

Drawings: Additional drawings showing layout and detail necessary for determining fit and placement in the buildings are (are not) to be provided by the supplier.

Fabrication: VERSA-LAM® beams shall be manufactured in a plant evaluated for fabrication by the governing code evaluation service and under the supervision of a third-party inspection agency listed by the corresponding evaluation service.

Storage and Installation: VERSA-LAM® beams, if stored prior to erection, shall be stored on stickers spaced a maximum of 15 ft. apart. Beams shall be stored on a dry, level surface and protected from the weather. They shall be handled with care so they are not damaged.

VERSA-LAM® beams are to be installed in accordance with the plans and Boise Cascade EWP's Installation Guide. Temporary construction loads which cause stresses beyond design limits are not permitted. Erection bracing shall be provided to assure adequate lateral support for the individual beams and the entire system until the sheathing material has been applied.

Codes: VERSA-LAM® beams shall be evaluated by a model code evaluation service.

Allowable Holes in VERSA-LAM® Beams

Notes

1. Square and rectangular holes are not permitted.
2. Round holes may be drilled or cut with a hole saw anywhere within the shaded area of the beam.
3. The horizontal distance between adjacent holes must be at least two times the size of the larger hole.
4. Do not drill more than three access holes in any four foot long section of beam.
5. The maximum round hole diameter permitted is:

Beam Depth	Max. Hole Diameter
5 1/2"	3/4"
7 1/4"	1"
9 1/4" and greater	2"

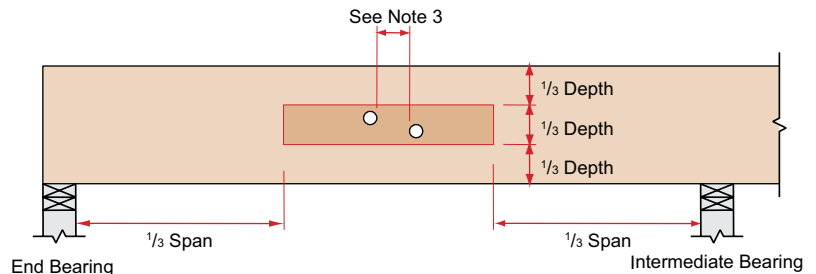

6. These limitations apply to holes drilled for plumbing or wiring access only. The size and location of holes drilled for fasteners are governed by the provisions of the *National Design Specification® for Wood Construction*.
7. Beams deflect under load. Size holes to provide clearance where required.
8. This hole chart is valid for beams supporting uniform load only. For beams supporting concentrated loads or for beams with larger holes, contact Boise Cascade EWP Engineering.

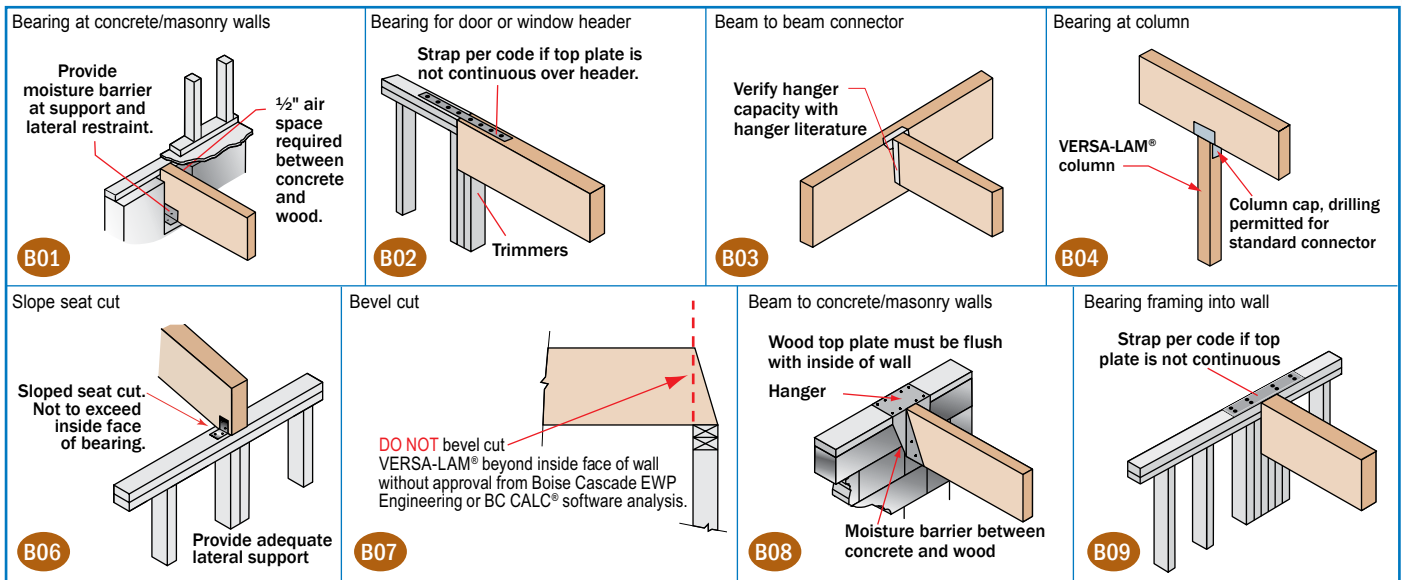

VERSA-LAM® Installation Notes

- Minimum of 1/2" air space between beam and wall pocket or adequate barrier must be provided between beam and concrete/masonry.
- Adequate bearing shall be provided. If not shown on plans, please refer to load tables in your region's Specifier Guide.
- VERSA-LAM® beams are intended for interior applications only and should be kept as dry as possible during construction.
- Continuous lateral support of top of beam shall be provided (side or top bearing framing).

Multiple Member Connectors

Side-Loaded Applications

Number of Members	Maximum Uniform Side Load [plf]							
	Nailed		1/2" Dia. Through Bolt ⁽¹⁾			5/8" Dia. Through Bolt ⁽¹⁾		
	2 rows 16d Sinkers @ 12" o.c.	3 rows 16d Sinkers @ 12" o.c.	2 rows @ 24" o.c. staggered	2 rows @ 12" o.c. staggered	2 rows @ 6" o.c. staggered	2 rows @ 24" o.c. staggered	2 rows @ 12" o.c. staggered	2 rows @ 6" o.c. staggered
1 3/4" VERSA-LAM® (Depths of 18" and less)								
2	470	705	505	1010	2020	560	1120	2245
3 ⁽²⁾	350	525	375	755	1515	420	840	1685
4 ⁽³⁾	use bolt schedule		335	670	1345	370	745	1495
3 1/2" VERSA-LAM®								
2 ⁽³⁾	use bolt schedule		855	1715	N/A	1125	2250	N/A

1. Design values apply to common bolts that conform to ANSI/ASME standard B18.21-1981 (ASTM A307 Grades A&B, SAE J429 Grades 1 or 2, or higher). A washer not less than a standard cut washer shall be between the wood and the bolt head and between the wood and the nut. The distance from the edge of the beam to the bolt holes must be at least 2" for 1/2" bolts and 2 1/2" for 5/8" bolts. Bolt holes shall be the same diameter as the bolt.
2. The nail schedules shown apply to both sides of a three member beam.
3. 7" wide beams must be top-loaded or loaded from both sides.

Top-Loaded Applications

For top-loaded beams and beams with side loads with less than those shown:			
Plies	Depth	Nailing	Maximum Uniform Load From One Side
(2) 1 3/4" plies	Depth 11 7/8" & less	2 rows 16d box/sinker nails @ 12" o.c.	400 plf
	Depth 14" - 18"	3 rows 16d box/sinker nails @ 12" o.c.	600 plf
(3) 1 3/4" plies ⁽²⁾	Depth 11 7/8" & less	2 rows 16d box/sinker nails @ 12" o.c.	300 plf
	Depth 14" - 18"	3 rows 16d box/sinker nails @ 12" o.c.	450 plf
(4) 1 3/4" plies	Depth 18" & less	2 rows 1/2" bolts @ 24" o.c., staggered	335 plf
(2) 3 1/2" plies	Depth 18" & less	2 rows 1/2" bolts @ 24" o.c., staggered	855 plf
	Depth 20" - 24"	3 rows 1/2" bolts @ 24" o.c., staggered every 8"	1285 plf

1. Beams wider than 7" must be designed by the engineer of record.
2. All values in these tables may be increased by 15% for snow-load roofs and by 25% for non-snow load roofs where the building code allows.
3. Use allowable load tables or BC CALC® software to size beams.
4. An equivalent specific gravity of 0.5 may be used when designing specific connections with VERSA-LAM®.
5. Connection values are based upon the 2005 NDS.
6. **FastenMaster TrussLok, Simpson Strong-Tie SDW or SDS, and USP WS screws may also be used to connect multiple member VERSA-LAM® beams, contact Boise Cascade EWP Engineering for further information.**

Designing Connections for Multiple VERSA-LAM® Members

When using multiple ply VERSA-LAM® beams to create a wider member, the connection of the plies is as critical as determining the beam size. When side loaded beams are not connected properly, the inside plies do not support their share of the load and thus the load-carrying capacity of the full member decreases significantly. The following is an example of how to size and connect a multiple-ply VERSA-LAM® floor beam.

Given: Beam shown below is supporting residential floor load (40 psf live load, 10 psf dead load) and is spanning 16'-0". Beam depth is limited to 14".

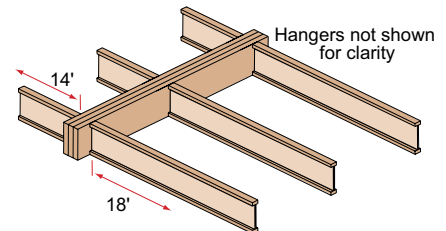

Find: A multiple 1 3/4" ply VERSA-LAM® that is adequate to support the design loads and the member's proper connection schedule.

1. Calculate the tributary width that beam is supporting:
 $14' / 2 + 18' / 2 = 16'$
2. Use PLF tables on pages 28-30 of WSG or BC CALC® to size beam.
A Triple VERSA-LAM® 2.0 2800 1 3/4" x 14" is found to adequately support the design loads.
3. Calculate the maximum plf load from one side (the right side in this case).
Max. Side Load = $(18' / 2) \times (40 + 10 \text{ psf}) = 450 \text{ plf}$
4. Go to the Multiple Member Connection Table, Side-Loaded Applications, 1 3/4" VERSA-LAM®, 3 members
5. The proper connection schedule must have a capacity greater than the max. side load:

Nailed: 3 rows 16d sinkers @ 12" o.c:
525 plf is greater than 450 plf OK
Bolts: 1/2" diameter 2 rows @ 12" staggered:
755 plf is greater than 450 plf OK

VERSA-LAM® 2.0 2800 and 2.0 3100 (100% Load Duration)

KEY TO TABLE	Top Figure	- Allowable Total Load [plf]
	Middle Figure	- Allowable Live Load [plf]
	Bottom Figures	- Minimum Required Bearing Length at End / Intermediate Supports [inches]

Span [ft]	1¾" VERSA-LAM® 2.0 2800 ⁽¹⁾						3½" VERSA-LAM® 2.0 3100						5¼" VERSA-LAM® 2.0 3100						7" VERSA-LAM® 2.0 3100							
	7½"	9½"	11¼"	14"	16" ⁽²⁾	18" ⁽²⁾	7½"	9½"	11¼"	14"	16"	18"	9½"	11¼"	14"	16"	18"	20"	11¼"	14"	16"	18"	20"	24"		
6	763	1063	1425	1796	2194	2617	1526	2127	2850	3591	4388	5234	3190	4275	5387	6583	7851	7848	5700	7183	8777	10468	10464	10457		
	762	-	-	-	-	-	1525	-	-	-	-	-	-	-	-	-	-	-	-	-	-	-	-	-		
7	1.8/4.4	2.4/6.1	3.3/8.2	4.1/10.3	5/12.6	6/15	1.8/4.4	2.4/6.1	3.3/8.2	4.1/10.3	5/12.6	6/15	2.4/6.1	3.3/8.2	4.1/10.3	5/12.6	6/15	6/15	3.3/8.2	4.1/10.3	5/12.6	6/15	6/15	6/15		
	614	877	1161	1445	1742	2074	1229	1754	2322	2889	3484	4147	2632	3483	4334	5226	6221	6723	4644	5778	6967	8295	8964	8957		
8	480	-	-	-	-	-	960	-	-	-	-	-	-	-	-	-	-	-	-	-	-	-	-	-		
	1.6/4.1	2.4/5.9	3.1/7.8	3.9/9.7	4.7/11.7	5.6/13.9	1.6/4.1	2.4/5.9	3.1/7.8	3.9/9.7	4.7/11.7	5.6/13.9	2.4/5.9	3.1/7.8	3.9/9.7	4.7/11.7	5.6/13.9	6/15	3.1/7.8	3.9/9.7	4.7/11.7	5.6/13.9	6/15	6/15		
9	470	746	979	1208	1444	1702	939	1493	1958	2416	2887	3404	2239	2938	3624	4331	5106	5879	3917	4832	5775	6808	7839	7832		
	322	724	-	-	-	-	643	1447	-	-	-	-	2171	-	-	-	-	-	-	-	-	-	-	-		
10	1.5/3.6	2.3/5.7	3/7.5	3.7/9.3	4.4/11.1	5.2/13	1.5/3.6	2.3/5.7	3/7.5	3.7/9.3	4.4/11.1	5.2/13	2.3/5.7	3/7.5	3.7/9.3	4.4/11.1	5.2/13	6/15	3/7.5	3.7/9.3	4.4/11.1	5.2/13	6/15	6/15		
	336	618	846	1038	1232	1443	671	1237	1693	2076	2465	2886	1855	2539	3113	3697	4328	5013	3386	4151	4930	5771	6684	6957		
11	226	508	-	-	-	-	452	1016	-	-	-	-	1525	-	-	-	-	-	-	-	-	-	-	-		
	1.5/3	2.1/5.3	2.9/7.3	3.6/8.9	4.3/10.6	5/12.4	1.5/3	2.1/5.3	2.9/7.3	3.6/8.9	4.3/10.6	5/12.4	2.1/5.3	2.9/7.3	3.6/8.9	4.3/10.6	5/12.4	5.8/14.4	2.9/7.3	3.6/8.9	4.3/10.6	5/12.4	5.8/14.4	6/15		
12	244	500	745	909	1075	1252	487	1000	1491	1819	2150	2504	1500	2236	2728	3225	3756	4326	2981	3638	4299	5008	5768	6257		
	165	370	724	-	-	-	329	741	1447	-	-	-	1111	2171	-	-	-	-	2894	-	-	-	-	-		
13	1.5/3	1.9/4.8	2.9/7.1	3.5/8.7	4.1/10.3	4.8/12	1.5/3	1.9/4.8	2.9/7.1	3.5/8.7	4.1/10.3	4.8/12	1.9/4.8	2.9/7.1	3.5/8.7	4.1/10.3	4.8/12	5.5/13.8	2.9/7.1	3.5/8.7	4.1/10.3	4.8/12	5.5/13.8	6/15		
	182	412	630	809	953	1105	365	825	1260	1618	1906	2211	1237	1890	2428	2858	3316	3803	2520	3237	3811	4422	5071	5684		
14	124	278	544	-	-	-	247	557	1087	-	-	-	835	1631	-	-	-	-	2175	-	-	-	-	-		
	1.5/3	1.7/4.4	2.7/6.7	3.4/8.5	4/10.1	4.7/11.7	1.5/3	1.7/4.4	2.7/6.7	3.4/8.5	4/10.1	4.7/11.7	1.7/4.4	2.7/6.7	3.4/8.5	4/10.1	4.7/11.7	5.4/13.4	2.7/6.7	3.4/8.5	4/10.1	4.7/11.7	5.4/13.4	6/15		
15	140	317	528	722	856	989	279	635	1057	1444	1711	1979	952	1585	2167	2567	2968	3393	2114	2889	3422	3958	4524	5207		
	95	214	419	686	-	-	191	429	837	1372	-	-	643	1256	2058	-	-	-	1675	2745	-	-	-	-		
16	1.5/3	1.5/3.7	2.4/6.1	3.3/8.3	3.9/9.9	4.6/11.4	1.5/3	1.5/3.7	2.4/6.1	3.3/8.3	3.9/9.9	4.6/11.4	1.5/3.7	2.4/6.1	3.3/8.3	3.9/9.9	4.6/11.4	5.2/13	2.4/6.1	3.3/8.3	3.9/9.9	4.6/11.4	5.2/13	6/15		
	109	249	449	614	776	895	218	497	899	1229	1552	1791	746	1348	1843	2328	2686	3062	1798	2458	3104	3581	4083	4803		
17	75	169	329	540	-	-	150	337	659	1079	-	-	506	988	1619	-	-	-	1317	2159	-	-	-	-		
	1.5/3	1.5/3.1	2.3/5.6	3.1/7.7	3.9/9.7	4.5/11.2	1.5/3	1.5/3.1	2.3/5.6	3.1/7.7	3.9/9.7	4.5/11.2	1.5/3.1	2.3/5.6	3.1/7.7	3.9/9.7	4.5/11.2	5.1/12.7	2.3/5.6	3.1/7.7	3.9/9.7	4.5/11.2	5.1/12.7	6/15		
18	87	198	387	529	682	817	174	396	774	1058	1363	1635	595	1160	1587	2045	2452	2789	1547	2116	2726	3270	3719	4457		
	60	135	264	432	645	-	120	270	527	864	1290	-	405	791	1296	1935	-	-	1055	1728	2580	-	-	-		
19	1.5/3	1.5/3	2.1/5.2	2.9/7.1	3.7/9.2	4.4/11	1.5/3	1.5/3	2.1/5.2	2.9/7.1	3.7/9.2	4.4/11	1.5/3	2.1/5.2	2.9/7.1	3.7/9.2	4.4/11	5/12.5	2.1/5.2	2.9/7.1	3.7/9.2	4.4/11	5/12.5	6/15		
	70	160	316	460	593	741	140	321	632	920	1186	1483	481	949	1380	1778	2224	2561	1265	1840	2371	2965	3415	4157		
20	49	110	214	351	524	-	98	220	429	703	1049	-	329	643	1054	1573	-	-	858	1405	2098	-	-	-		
	1.5/3	1.5/3	1.8/4.6	2.7/6.7	3.4/8.6	4.3/10.7	1.5/3	1.5/3	1.8/4.6	2.7/6.7	3.4/8.6	4.3/10.7	1.5/3	1.8/4.6	2.7/6.7	3.4/8.6	4.3/10.7	4.9/12.3	1.8/4.6	2.7/6.7	3.4/8.6	4.3/10.7	4.9/12.3	6/15		
21	57	131	260	403	520	651	114	263	519	807	1040	1301	394	779	1210	1560	1952	2367	1039	1614	2080	2602	3156	3894		
	40	90	177	289	432	615	80	181	353	579	864	1230	271	530	868	1296	1846	-	707	1158	1728	2461	-	-		
22	1.5/3	1.5/3	1.6/4	2.5/6.2	3.2/8	4/10	1.5/3	1.5/3	1.6/4	2.5/6.2	3.2/8	4/10	1.5/3	1.6/4	2.5/6.2	3.2/8	4/10	4.9/12.2	1.6/4	2.5/6.2	3.2/8	4/10	4.9/12.2	6/15		
	109	216	356	460	575	94	218	431	711	920	1151	327	647	1067	1380	1726	2109	862	1423	1840	2302	2812	3658			
23	75	147	241	360	513	67	151	295	483	720	1026	226	442	724	1081	1539	-	589	965	1441	2052	-	-			
	1.5/3	1.5/3.6	2.3/5.9	3/7.6	3.8/9.4	1.5/3	1.5/3	1.5/3.6	2.3/5.9	3/7.6	3.8/9.4	1.5/3	1.5/3.6	2.3/5.9	3/7.6	3.8/9.4	4.6/11.5	1.5/3.6	2.3/5.9	3/7.6	3.8/9.4	4.6/11.5	6/15			
24	91	181	299	409	512	78	182	362	597	819	1025	273	542	896	1228	1537	1878	723	1195	1638	2049	2504	3408			
	64	124	203	303	432	56	127	248	407	607	864	191	372	610	910	1296	1778	496	813	1214	1728	2371	-			
25	1.5/3	1.5/3.2	2.1/5.2	2.9/7.1	3.6/8.9	1.5/3	1.5/3	1.5/3.2	2.1/5.2	2.9/7.1	3.6/8.9	1.5/3	1.5/3.2	2.1/5.2	2.9/7.1	3.6/8.9	4.4/10.9	1.5/3.2	2.1/5.2	2.9/7.1	3.6/8.9	4.4/10.9	5.9/14.8			
	77	153	253	367	459	66	153	306	506	733	918	230	459	759	1100	1377	1683	612	1012	1467	1836	2244	3174			
26	54	105	173	258	367	48	108	211	346	516	735	162	316	519	774	1102	1512	422	691	1032	1470	2016	-			
	1.5/3	1.5/3	1.9/4.7	2.7/6.8	3.4/8.5	1.5/3	1.5/3	1.5/3	1.9/4.7	2.7/6.8	3.4/8.5	1.5/3	1.5/3	1.9/4.7	2.7/6.8	3.4/8.5	4.1/10.3	1.5/3	1.9/4.7	2.7/6.8	3.4/8.5	4.1/10.3	5.8/14.6			
27	65	130	216	325	413	55	130	261	432	649	827	196	391	648	974	1240	1516	521	864	1299	1654	2022	2860			
	46	90	148	221	315	41	93	181	296	442	630	139	271	445	664	945	1296	362	593	885	1260	1728	-			
28	1.5/3	1.5/3	1.7/4.2	2.5/6.3	3.2/8	1.5/3	1.5/3	1.5/3	1.7/4.2	2.5/6.3	3.2/8	1.5/3	1.5/3	1.7/4.2	2.5/6.3	3.2/8	3.9/9.8	1.5/3	1.7/4.2	2.5/6.3	3.2/8	3.9/9.8	5.5/13.8			
	97	161	242	340	460	96	193	321	484	681	144	290	482	726	1021	1248	386	643	969	1361	1665	2356				
29	68	111	166	237	330	70	136	223	332	473	104	204	334	499	710	974	272	445	665	947	1299	2244				
	1.5/3	1.5/3.5	2.1/5.2	2.9/7.3	1.5/3	1.5/3	1.5/3.5	2.1/5.2	2.9/7.3	1.5/3	1.5/3	1.5/3.5	2.1/5.2	2.9/7.3	3.6/8.9	1.5/3	1.5/3.5	2.1/5.2	2.9/7.3	3.6/8.9	5/12.6					
30	73	122	185	265	354	72	146	245	370	531	108	220	367	555	796	1045	293	489	739	1061	1393	1973				
	52	86	128	182	252	54	105	172	256	365	80	157	257	384	547	750	209	343	512	729	1000	1728				
31	1.5/3	1.5/3	1.8/4.4	2.5/6.3	1.5/3	1.5/3	1.5/3	1.8/4.4	2.5/6.3	1.5/3	1.5/3	1.5/3	1.8/4.4	2.5/6.3	3.3/8.2	1.5/3	1.5/3	1.8/4.4	2.5/6.3	3.3/8.2	1.5/3	1.5/3	1.8/4.4	2.5/6.3	3.3/8.2	4.6/11.5
	56	95	144	207	282	55	113	190	288	414	82	169	285	432	621	858	226	380	575	828	1144	1675				
32	41	67	101	143	201	42	82	135	201	287	63	124	202	302	430	590	165	270	403	574	787	1359				
	1.5/3	1.5/3	1.5/3.7	2.1/																						

VERSA-LAM® 2.0 2800 and 2.0 3100 (115% Load Duration)

KEY TO TABLE	Top Figure	- Allowable Total Load [plf]
	Middle Figure	- Allowable Live Load [plf]
	Bottom Figures	- Minimum Required Bearing Length at End / Intermediate Supports [inches]

Span [ft]	1¾" VERSA-LAM® 2.0 2800 ⁽¹⁾						3½" VERSA-LAM® 2.0 3100						5½" VERSA-LAM® 2.0 3100						7" VERSA-LAM® 2.0 3100					
	7¼"	9½"	11¾"	14"	16" ⁽²⁾	18" ⁽²⁾	7¼"	9½"	11¾"	14"	16"	18"	9½"	11¾"	14"	16"	18"	20"	11¾"	14"	16"	18"	20"	24"
6	878	1224	1640	2066	2524	2617	1756	2447	3279	4132	5049	5234	3671	4919	6198	7573	7851	7848	6558	8264	10098	10468	10464	10457
7	2/5	2.8/7	3.8/9.4	4.7/11.8	5.8/14.5	6/15	2/5	2.8/7	3.8/9.4	4.7/11.8	5.8/14.5	6/15	2.8/7	3.8/9.4	4.7/11.8	5.8/14.5	6/15	6/15	3.8/9.4	4.7/11.8	5.8/14.5	6/15	6/15	6/15
8	541	859	1127	1390	1661	1958	1081	1718	2254	2780	3323	3917	2577	3381	4171	4984	5875	5879	4508	5561	6645	7834	7839	7832
9	1.7/4.1	2.6/6.6	3.5/8.6	4.3/10.6	5.1/12.7	6/15	1.7/4.1	2.6/6.6	3.5/8.6	4.3/10.6	5.1/12.7	6/15	2.6/6.6	3.5/8.6	4.3/10.6	5.1/12.7	6/15	6/15	3.5/8.6	4.3/10.6	5.1/12.7	6/15	6/15	6/15
10	326	576	858	1047	1237	1441	652	1151	1716	2094	2474	2882	1727	2574	3140	3711	4323	4698	3431	4187	4949	5764	6264	6257
11	1.5/3.1	2.2/5.5	3.3/8.2	4/10	4.7/11.9	5.5/13.8	1.5/3.1	2.2/5.5	3.3/8.2	4/10	4.7/11.9	5.5/13.8	2.2/5.5	3.3/8.2	4/10	4.7/11.9	5.5/13.8	6/15	3.3/8.2	4/10	4.7/11.9	5.5/13.8	6/15	6/15
12	187	398	609	831	985	1139	375	797	1217	1663	1970	2278	1195	1826	2494	2955	3417	3906	2434	3326	3940	4556	5208	5207
13	1.5/3	1.8/4.6	2.8/7	3.8/9.6	4.5/11.3	5.2/13.1	1.5/3	1.8/4.6	2.8/7	3.8/9.6	4.5/11.3	5.2/13.1	1.8/4.6	2.8/7	3.8/9.6	4.5/11.3	5.2/13.1	6/15	2.8/7	3.8/9.6	4.5/11.3	5.2/13.1	6/15	6/15
14	117	266	446	609	785	941	234	532	891	1218	1570	1883	797	1337	1828	2355	2824	3212	1783	2437	3139	3765	4283	4457
15	1.5/3	1.5/3.6	2.4/6	3.3/8.2	4.2/10.6	5.1/12.7	1.5/3	1.5/3.6	2.4/6	3.3/8.2	4.2/10.6	5.1/12.7	1.5/3.6	2.4/6	3.3/8.2	4.2/10.6	5.1/12.7	5.8/14.4	2.4/6	3.3/8.2	4.2/10.6	5.1/12.7	5.8/14.4	6/15
16	77	177	340	465	599	749	154	353	680	930	1198	1499	530	1020	1395	1798	2248	2726	1360	1860	2397	2998	3635	3894
17	1.5/3	1.5/3	2.1/5.3	2.9/7.2	3.7/9.2	4.6/11.5	1.5/3	1.5/3	2.1/5.3	2.9/7.2	3.7/9.2	4.6/11.5	1.5/3	2.1/5.3	2.9/7.2	3.7/9.2	4.6/11.5	5.6/14	2.1/5.3	2.9/7.2	3.7/9.2	4.6/11.5	5.6/14	6/15
18	53	123	243	366	472	590	106	246	486	732	944	1181	368	728	1098	1416	1771	2164	971	1464	1888	2362	2885	3457
19	1.5/3	1.5/3	1.7/4.3	2.6/6.4	3.3/8.2	4.1/10.3	1.5/3	1.5/3	1.7/4.3	2.6/6.4	3.3/8.2	4.1/10.3	1.5/3	1.7/4.3	2.6/6.4	3.3/8.2	4.1/10.3	5/12.5	1.7/4.3	2.6/6.4	3.3/8.2	4.1/10.3	5/12.5	6/15
20	88	176	290	381	477	576	176	352	544	728	912	1096	442	884	1326	1771	2216	2661	1112	2224	3336	4448	5560	6672
22	65	131	216	314	393	477	131	262	393	524	655	786	262	524	786	1048	1310	1572	524	1048	1572	2144	2716	3288
24	99	165	249	329	409	489	198	330	498	666	834	1002	498	834	1170	1506	1842	2178	834	1390	1946	2502	3058	3614
26	77	129	194	279	364	449	154	257	386	515	644	773	308	515	723	931	1139	1347	515	723	931	1139	1347	1555
28	61	102	154	221	288	355	122	204	308	443	577	711	244	407	611	815	1019	1223	407	611	815	1019	1223	1427
30	49	81	121	172	223	274	98	163	245	327	409	491	196	327	491	655	819	983	327	491	655	819	983	1147

- (1) For 2-ply, 3-ply or 4-ply beams; double, triple or quadruple Allowable Total Load and Allowable Live Load values. Minimum Required Bearing Lengths remain the same for any number of plies.
- (2) 1¾ inch members deeper than 14 inches are to be used as multiple-member beams only.
- Total Load values are limited by shear, moment or deflection equal to L/180. Total Load values are the capacity of the beam in addition to its own weight.
- Live Load values are limited by deflection equal to L/240. Check the local building code for other deflection limits that may apply. Where a Live Load value is not shown, the Total Load value will control.
- Table values represent the most restrictive of simple or multiple span applications. Span is measured center to center of the supports. Analyze multiple span beams with the BC CALC® software if the length of any span is less than half the length of an adjacent span.
- Table values assume that lateral support is provided at each support and continuously along the compression edge of the beam.
- Table values for Minimum Required Bearing Lengths are based on the allowable compression design value perpendicular to grain for the beam and the Total Load value shown. Other design considerations, such as a weaker support material, may warrant longer bearing lengths. Table values assume that support is provided across the full width of the beam.
- This table was designed to apply to a broad range of applications. It may be possible to exceed the limitations of this table by analyzing a specific application with the BC CALC® software.

VERSA-LAM® Roof Load Tables

VERSA-LAM® 2.0 2800 and 2.0 3100 (125% Load Duration)

KEY TO TABLE		Top Figure	-	Allowable Total Load [plf]
		Middle Figure	-	Allowable Live Load [plf]
		Bottom Figures	-	Minimum Required Bearing Length at End / Intermediate Supports [inches]

Span [ft]	1 3/4" VERSA-LAM® 2.0 2800 ⁽¹⁾						3 1/2" VERSA-LAM® 2.0 3100						5 1/4" VERSA-LAM® 2.0 3100						7" VERSA-LAM® 2.0 3100					
	7 1/2"	9 1/2"	11 1/4"	14"	16" ⁽²⁾	18" ⁽²⁾	7 1/2"	9 1/2"	11 1/4"	14"	16"	18"	9 1/2"	11 1/4"	14"	16"	18"	20"	11 1/4"	14"	16"	18"	20"	24"
6	955	1330	1783	2246	2618	2617	1909	2661	3565	4492	5236	5234	3991	5348	6738	7853	7851	7848	7131	8984	10471	10468	10464	10457
	-	-	-	-	-	-	-	-	-	-	-	-	-	-	-	-	-	-	-	-	-	-	-	-
	2.2/5.5	3.1/7.6	4.1/10.2	5.1/12.9	6/15	6/15	2.2/5.5	3.1/7.6	4.1/10.2	5.1/12.9	6/15	6/15	3.1/7.6	4.1/10.2	5.1/12.9	6/15	6/15	6/15	4.1/10.2	5.1/12.9	6/15	6/15	6/15	6/15
7	769	1098	1453	1807	2179	2242	1538	2195	2905	3615	4358	4484	3293	4358	5422	6537	6726	6723	5810	7229	8716	8968	8964	8957
	-	-	-	-	-	-	-	-	-	-	-	-	-	-	-	-	-	-	-	-	-	-	-	-
	2.1/5.1	2.9/7.3	3.9/9.7	4.8/12.1	5.8/14.6	6/15	2.1/5.1	2.9/7.3	3.9/9.7	4.8/12.1	5.8/14.6	6/15	2.9/7.3	3.9/9.7	4.8/12.1	5.8/14.6	6/15	6/15	3.9/9.7	4.8/12.1	5.8/14.6	6/15	6/15	6/15
8	588	934	1225	1512	1806	1961	1176	1868	2451	3023	3613	3921	2802	3676	4535	5419	5882	5879	4901	6047	7226	7843	7839	7832
	-	-	-	-	-	-	-	-	-	-	-	-	-	-	-	-	-	-	-	-	-	-	-	-
	1.8/4.5	2.9/7.1	3.8/9.4	4.6/11.6	5.5/13.8	6/15	1.8/4.5	2.9/7.1	3.8/9.4	4.6/11.6	5.5/13.8	6/15	2.9/7.1	3.8/9.4	4.6/11.6	5.5/13.8	6/15	6/15	3.8/9.4	4.6/11.6	5.5/13.8	6/15	6/15	6/15
9	448	774	1059	1299	1542	1742	897	1548	2119	2598	3085	3484	2322	3178	3897	4627	5226	5223	4238	5195	6169	6968	6964	6957
	-	-	-	-	-	-	-	-	-	-	-	-	-	-	-	-	-	-	-	-	-	-	-	-
	1.5/3.9	2.7/6.7	3.7/9.1	4.5/11.2	5.3/13.3	6/15	1.5/3.9	2.7/6.7	3.7/9.1	4.5/11.2	5.3/13.3	6/15	2.7/6.7	3.7/9.1	4.5/11.2	5.3/13.3	6/15	6/15	3.7/9.1	4.5/11.2	5.3/13.3	6/15	6/15	6/15
10	326	626	933	1138	1345	1567	652	1252	1866	2277	2691	3134	1878	2799	3415	4036	4701	4698	3732	4554	5381	6268	6264	6257
	-	-	-	-	-	-	-	-	-	-	-	-	-	-	-	-	-	-	-	-	-	-	-	-
	1.5/3.1	2.4/6	3.6/8.9	4.4/10.9	5.2/12.9	6/15	1.5/3.1	2.4/6	3.6/8.9	4.4/10.9	5.2/12.9	6/15	2.4/6	3.6/8.9	4.4/10.9	5.2/12.9	6/15	6/15	3.6/8.9	4.4/10.9	5.2/12.9	6/15	6/15	6/15
11	244	517	789	1013	1193	1384	488	1033	1577	2026	2386	2768	1550	2366	3039	3578	4151	4268	3155	4052	4771	5535	5691	5684
	-	-	-	-	-	-	-	-	-	-	-	-	-	-	-	-	-	-	-	-	-	-	-	-
	1.5/3	2.2/5.5	3.3/8.3	4.3/10.7	5/12.6	5.8/14.6	1.5/3	2.2/5.5	3.3/8.3	4.3/10.7	5/12.6	5.8/14.6	2.2/5.5	3.3/8.3	4.3/10.7	5/12.6	5.8/14.6	6/15	3.3/8.3	4.3/10.7	5/12.6	5.8/14.6	6/15	6/15
12	187	425	662	904	1071	1239	375	849	1324	1809	2142	2478	1274	1986	2713	3214	3716	3911	2648	3617	4285	4955	5214	5207
	-	-	-	-	-	-	-	-	-	-	-	-	-	-	-	-	-	-	-	-	-	-	-	-
	1.5/3	2/4.9	3.1/7.6	4.2/10.4	4.9/12.3	5.7/14.3	1.5/3	2/4.9	3.1/7.6	4.2/10.4	4.9/12.3	5.7/14.3	2/4.9	3.1/7.6	4.2/10.4	4.9/12.3	5.7/14.3	6/15	3.1/7.6	4.2/10.4	4.9/12.3	5.7/14.3	6/15	6/15
13	147	333	563	770	972	1121	293	666	1126	1539	1944	2242	999	1690	2309	2916	3363	3608	2253	3078	3888	4485	4810	4803
	-	-	-	-	-	-	-	-	-	-	-	-	-	-	-	-	-	-	-	-	-	-	-	-
	1.5/3	1.7/4.2	2.8/7	3.8/9.6	4.8/12.1	5.6/14	1.5/3	1.7/4.2	2.8/7	3.8/9.6	4.8/12.1	5.6/14	1.7/4.2	2.8/7	3.8/9.6	4.8/12.1	5.6/14	6/15	2.8/7	3.8/9.6	4.8/12.1	5.6/14	6/15	6/15
14	117	266	485	663	854	1024	234	532	970	1325	1707	2048	797	1455	1988	2561	3071	3348	1939	2651	3415	4095	4464	4457
	-	-	-	-	-	-	-	-	-	-	-	-	-	-	-	-	-	-	-	-	-	-	-	-
	1.5/3	1.5/3.6	2.6/6.5	3.6/8.9	4.6/11.5	5.5/13.8	1.5/3	1.5/3.6	2.6/6.5	3.6/8.9	4.6/11.5	5.5/13.8	1.5/3.6	2.6/6.5	3.6/8.9	4.6/11.5	5.5/13.8	6/15	2.6/6.5	3.6/8.9	4.6/11.5	5.5/13.8	6/15	6/15
15	94	215	422	576	743	929	189	431	843	1153	1486	1857	646	1265	1729	2228	2786	3123	1687	2306	2971	3715	4164	4157
	-	-	-	-	-	-	-	-	-	-	-	-	-	-	-	-	-	-	-	-	-	-	-	-
	1.5/3	1.5/3.1	2.4/6.1	3.3/8.3	4.3/10.7	5.4/13.4	1.5/3	1.5/3.1	2.4/6.1	3.3/8.3	4.3/10.7	5.4/13.4	1.5/3.1	2.4/6.1	3.3/8.3	4.3/10.7	5.4/13.4	6/15	2.4/6.1	3.3/8.3	4.3/10.7	5.4/13.4	6/15	6/15
16	77	177	348	506	652	815	154	353	696	1012	1304	1631	530	1044	1518	1956	2446	2926	1392	2024	2608	3261	3902	3894
	-	-	-	-	-	-	-	-	-	-	-	-	-	-	-	-	-	-	-	-	-	-	-	-
	1.5/3	1.5/3	2.2/5.4	3.1/7.8	4/10	5/12.5	1.5/3	1.5/3	2.2/5.4	3.1/7.8	4/10	5/12.5	1.5/3	2.2/5.4	3.1/7.8	4/10	5/12.5	6/15	2.2/5.4	3.1/7.8	4/10	5/12.5	6/15	6/15
17	64	147	289	447	577	721	128	293	578	895	1153	1443	440	868	1342	1730	2164	2643	1157	1790	2307	2885	3524	3663
	-	-	-	-	-	-	-	-	-	-	-	-	-	-	-	-	-	-	-	-	-	-	-	-
	1.5/3	1.5/3	1.9/4.8	2.9/7.3	3.8/9.5	4.7/11.8	1.5/3	1.5/3	1.9/4.8	2.9/7.3	3.8/9.5	4.7/11.8	1.5/3	1.9/4.8	2.9/7.3	3.8/9.5	4.7/11.8	5.8/14.4	1.9/4.8	2.9/7.3	3.8/9.5	4.7/11.8	5.8/14.4	6/15
18	53	123	243	398	514	642	106	246	486	797	1027	1285	368	728	1195	1541	1927	2355	971	1594	2054	2570	3139	3457
	-	-	-	-	-	-	-	-	-	-	-	-	-	-	-	-	-	-	-	-	-	-	-	-
	1.5/3	1.5/3	1.7/4.3	2.8/6.9	3.6/8.9	4.5/11.2	1.5/3	1.5/3	1.7/4.3	2.8/6.9	3.6/8.9	4.5/11.2	1.5/3	1.7/4.3	2.8/6.9	3.6/8.9	4.5/11.2	5.4/13.6	1.7/4.3	2.8/6.9	3.6/8.9	4.5/11.2	5.4/13.6	6/15
19	104	206	339	460	576	790	90	208	411	679	920	1152	311	617	1018	1381	1727	2110	823	1358	1841	2303	2814	3273
	-	-	-	-	-	-	-	-	-	-	-	-	-	-	-	-	-	-	-	-	-	-	-	-
	1.5/3	1.5/3.8	2.5/6.3	3.4/8.5	4.2/10.6	5/13.3	1.5/3	1.5/3	1.5/3.8	2.5/6.3	3.4/8.5	4.2/10.6	1.5/3	1.5/3.8	2.5/6.3	3.4/8.5	4.2/10.6	5.2/12.9	1.5/3.8	2.5/6.3	3.4/8.5	4.2/10.6	5.2/12.9	6/15
20	88	176	290	415	519	76	177	351	580	829	1038	1285	265	527	870	1244	1557	1902	702	1160	1659	2075	2536	3107
	-	-	-	-	-	-	-	-	-	-	-	-	-	-	-	-	-	-	-	-	-	-	-	-
	1.5/3	1.5/3.4	2.3/5.6	3.2/8	4/10	5/12.5	1.5/3	1.5/3	1.5/3.4	2.3/5.6	3.2/8	4/10	1.5/3	1.5/3.4	2.3/5.6	3.2/8	4/10	4.9/12.2	1.5/3.4	2.3/5.6	3.2/8	4/10	4.9/12.2	6/15
22	65	131	216	325	427	55	131	261	433	650	855	1096	196	392	649	976	1282	1567	522	866	1301	1710	2090	2820
	-	-	-	-	-	-	-	-	-	-	-	-	-	-	-	-	-	-	-	-	-	-	-	-
	1.5/3	1.5/3	1.9/4.7	2.8/7	3.6/9.1	4.5/11.1	1.5/3	1.5/3	1.9/4.7	2.8/7	3.6/9.1	4.5/11.1	1.5/3	1.9/4.7	2.8/7	3.6/9.1	4.5/11.1	5.1/11.1	1.5/3	1.9/4.7	2.8/7	3.6/9.1	4.5/11.1	6/15
24	99	165	249	356	479	61	99	199	330	498	713	913	148	298	496	747	1069	1313	397	661	995	1426	1750	2477
	-	-	-	-	-	-	-	-	-	-	-	-	-	-	-	-	-	-	-	-	-	-	-	-
	1.5/3	1.6/3.9	2.3/5.9	3.3/8.3	4.1/10.2	5/12.5	1.5/3	1.5/3	1.6/3.9	2.3/5.9	3.3/8.3	4.1/10.2	1.5/3	1.6/3.9	2.3/5.9	3.3/8.3	4.1/10.2	5.1/11.1	1.5/3	1.6/3.9	2.3/5.9	3.3/8.3	4.1/10.2	5.8/14.4
26	77	129	194	279	379	50	76	154	257	388	557	714	114	231	386	583	836	1114	308	515	777	1115	1486	2104
	-	-	-	-	-	-	-	-	-	-	-	-	-	-	-	-	-	-	-	-	-	-	-	-
	1.5/3	1.5/3.3	2/5	2.8/7.1	3.8/9.4	4.8/12.1	1.5/3	1.5/3	1.5/3.3	2/5	2.8/7.1	3.8/9.4	1.5/3	1.5/3	1.5/3.3	2/5	2.8/7.1	3.8/9.4	1.5/3	1.5/3.3	2/5	2.8/7.1	3.8/9.4	5.3/13.3
28	61	102	154	221	291	37	61	121	203	308	443	588	88	182	305	462	664	918	242	407	616	886	1224	1809
	-	-	-	-	-	-	-	-	-	-	-	-	-	-	-	-	-	-	-	-	-	-	-	-
	1.5/3	1.5/3	1.7/4.3	2.4/6.1	3.4/8.4	4.4/11.1	1.5/3	1.5/3	1.5/3	1.7/4.3	2.4/6.1	3.4/8.4	1.5/3	1.5/3	1.5/3	1.7/4.3	2.4/6.1	3.4/8.4						

Closest Allowable Nail Spacing

Nailing Parallel to Glue Lines (Narrow Face)

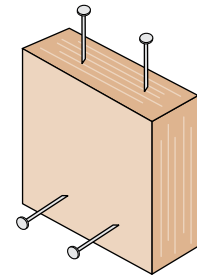

Nailing Perpendicular to Glue Lines (Wide Face)

Nailing Notes

- For 1 1/4" thickness and greater, 2 rows of nails (such as for a metal strap) are allowed (use 1/2" minimum offset between rows and stagger nails).

Nail Size	Nailing Parallel to Glue Lines (Narrow Face) ⁽¹⁾								Nailing Perpendicular to Glue Lines (Wide Face)	
	VERSA-RIM® 1 1/16"		VERSA-LAM® 1.4 1800 Rimboard 1 5/16"		VERSA-LAM® 1 3/4" & 2 5/8"		VERSA-LAM® 3 1/2" & Wider		All Products	
	O.C. [inches]	End [inches]	O.C. [inches]	End [inches]	O.C. [inches]	End [inches]	O.C. [inches]	End [inches]	O.C. [inches]	End [inches]
8d Box	3	1 1/2	3	1 1/2	2	1	2	1/2	2	1/2
8d Common	4	3	3	2	3	2	2	1	2	1
10d & 12d Box	4	3	3	2	3	2	2	1	2	1
16d Box	4	3	3	2	3	2	2	1	2	1
10d & 12d Common	6	4	4	3	4	3	2	2	2	2
16d Sinker	6	4	4	3	4	3	2	2	2	2
16d Common	6	4	6	4	6	3	2	2	2	2

- Offset and stagger nail rows from floor sheathing and wall sole plate.
- Simpson Strong-Tie A35 and LPT4 connectors may be attached to the side VERSA-LAM®/VERSA-RIM®. Use nails as specified by Simpson Strong-Tie.

VERSA-LAM® Design Values

Grade	Width [in]	Depth [in]	Weight [lb/ft]	Allowable Shear [lb]	Allowable Moment [ft-lb]	Moment of Inertia [in ⁴]	Grade	Width [in]	Depth [in]	Weight [lb/ft]	Allowable Shear [lb]	Allowable Moment [ft-lb]	Moment of Inertia [in ⁴]		
1.7 2400	1 1/2	3 1/2	1.3	998	702	5.4	2.0 3100	7	9 1/4	16.6	12303	26544	461.7		
		5 1/2	2.1	1568	1649	20.8			9 1/2	17.1	12635	27916	500.1		
		7 1/4	2.8	2066	2779	47.6			11 1/4	20.2	14963	38419	830.6		
		9 1/4	3.6	2636	4404	98.9			11 5/8	21.4	15794	42550	976.8		
		11 1/4	4.3	3206	6374	178.0			14	25.2	18620	58069	1600.7		
2.0 2800	1 3/4	5 1/2	2.5	1829	2245	24.3			16	28.8	21280	74728	2389.3		
		7 1/4	3.3	2411	3783	55.6			18	32.4	23940	93348	3402.0		
		9 1/4	4.2	3076	5994	115.4			20	36.0	26600	113904	4666.7		
		9 1/2	4.3	3159	6304	125.0			24	43.2	31920	160732	8064.0		
		11 1/4	5.1	3741	8675	207.6			VERSA-LAM® 1.4 1800 (Rimboard & Stair Stringers)	1 5/16	9 1/2	3.2	1870	3039	93.8
		11 5/8	5.3	3948	9608	244.2					11 5/8	4.0	2338	4632	183.2
		14	6.3	4655	13112	400.2					14	4.7	2756	6322	300.1
		16	7.2	5320	16874	597.3					16	5.4	3150	8136	448.0
18	8.1	5985	21079	850.5	18	6.1					3544	10163	637.9		
2.0 2800	2 5/8	5 1/2	3.7	2743	3368	36.4			20	6.7	3938	12401	875.0		
		7 1/4	4.9	3616	5675	83.4	Design Property	VERSA-LAM® Beams		VERSA-LAM® Columns	VERSA- STUD®	Rimboard / Stair Stringers			
		9 1/4	6.2	4613	8991	173.1		1 3/4" & 2 5/8"	3 1/2" & Wider						
		9 1/2	6.4	4738	9455	187.6		Grade	2.0 2800	2.0 3100	1.7 2650	1.7 2400	1.4 1800		
		11 1/4	7.6	5611	13013	311.5		Modulus of Elasticity E (x 10 ⁶ psi) ⁽¹⁾	2.0	2.0	1.7	1.7	1.4		
		11 5/8	8.0	5923	14412	366.3		Bending F _b (psi) ⁽²⁾⁽³⁾	2800	3100	2650	2400	1800		
		14	9.4	6983	19669	600.3		Horizontal Shear F _v (psi) ⁽²⁾⁽⁴⁾	285	285	285	285	225		
		16	10.8	7980	25311	896.0		Tension Parallel to Grain F _t (psi) ⁽²⁾⁽⁵⁾	1950	1950	1500	1500	1100		
18	12.1	8978	31618	1275.8	Compression Parallel to to Grain F _c (psi) ⁽²⁾	3000		3000	3000	3000	2500				
2.0 3100	3 1/2	5 1/2	4.9	3658	4971	48.5		Compression Perpendicular to Grain F _{c⊥} (psi) ⁽²⁾	750	750	750	750	525		
		7 1/4	6.5	4821	8377	111.1		Equivalent Specific Gravity for Fastener Design (SG)	0.5	0.5	0.5	0.5	0.5		
		9 1/4	8.3	6151	13272	230.8	<ol style="list-style-type: none"> This value cannot be adjusted for load duration. This value is based upon a load duration of 100% and may be adjusted for other load durations. Fiber stress bending value shall be multiplied by the depth factor, (12/d)^{1/9} where d = member depth [in]. Stress applied perpendicular to the glue lines. Tension value shall be multiplied by a length factor, (4/L)^{1/8} where L = member length [ft]. Use L = 4 for members less than four feet long. Stress applied parallel to the glue lines. 								
		9 1/2	8.5	6318	13958	250.1									
		11 1/4	10.1	7481	19210	415.3									
		11 5/8	10.7	7897	21275	488.4									
		14	12.6	9310	29035	800.3									
		16	14.4	10640	37364	1194.7									
18	16.2	11970	46674	1701.0											
20	18.0	13300	56952	2333.3											
2.0 3100	5 1/4	5 1/4	7.1	5237	6830	63.3									
		5 1/2	7.4	5486	7457	72.8									
		7 1/4	9.8	7232	12566	166.7									
		9 1/4	12.5	9227	19908	346.3									
		9 1/2	12.8	9476	20937	375.1									
		11 1/4	15.2	11222	28814	622.9									
		11 5/8	16.0	11845	31913	732.6									
		14	18.9	13965	43552	1200.5									
		16	21.6	15960	56046	1792.0									
		18	24.3	17955	70011	2551.5									
20	27.0	19950	85428	3500.0											
24	32.4	23940	120549	6048.0											

VERSA-LAM® 1.7 2650 Columns

Column Length (ft)	3½" Allowable Axial Load (lb)																	
	3½" x 3½"			3½" x 4½"			3½" x 5¼"			3½" x 5½"			3½" x 7"			3½" x 7¼"		
	100%	115%	125%	100%	115%	125%	100%	115%	125%	100%	115%	125%	100%	115%	125%	100%	115%	125%
4	14,700	16,090	16,930	18,390	20,130	21,180	22,070	24,165	25,430	23,130	25,320	26,640	29,450	32,240	33,920	30,500	33,390	35,130
5	12,270	13,150	13,660	15,350	16,440	17,090	18,425	19,740	20,515	19,300	20,680	21,490	24,580	26,330	27,365	25,460	27,270	28,340
6	10,080	10,650	10,980	12,610	13,320	13,740	15,140	15,995	16,495	15,860	16,750	17,280	20,195	21,335	22,000	20,910	22,090	22,780
7	8,310	8,705	8,930	10,400	10,890	11,170	12,480	13,075	13,415	13,080	13,700	14,050	16,650	17,435	17,890	17,250	18,060	18,530
8	6,930	7,205	7,370	8,660	9,010	9,210	10,405	10,825	11,070	10,900	11,340	11,600	13,880	14,440	14,760	14,370	14,960	15,290
9	5,840	6,050	6,160	7,300	7,560	7,710	8,770	9,080	9,260	9,190	9,510	9,700	11,700	12,115	12,350	12,120	12,540	12,790
10	4,980	5,135	5,225	6,230	6,420	6,540	7,480	7,715	7,850	7,830	8,080	8,220	9,975	10,290	10,470	10,330	10,660	10,840
11	4,290	4,410	4,480	5,360	5,520	5,600	6,445	6,625	6,730	6,750	6,940	7,050	8,595	8,835	8,975	8,900	9,150	9,300
12	3,730	3,825	3,880	4,660	4,780	4,850	5,600	5,745	5,830	5,870	6,020	6,100	7,475	7,665	7,775	7,740	7,940	8,050
13	3,270	3,350	3,390	4,090	4,190	4,240	4,915	5,030	5,095	5,150	5,270	5,340	6,555	6,710	6,795	6,790	6,950	7,040
14	2,890	2,950	2,990	3,610	3,690	3,740	4,340	4,435	4,490	4,550	4,650	4,700	5,790	5,915	5,990	6,000	6,130	6,200

Column Length (ft)	5¼" and 7" Allowable Axial Load (lb)																	
	5¼" x 5¼"			5¼" x 5½"			5¼" x 7"			5¼" x 7¼"			7" x 7"			7" x 7¼"		
	100%	115%	125%	100%	115%	125%	100%	115%	125%	100%	115%	125%	100%	115%	125%	100%	115%	125%
6	33,070	36,220	38,110	34,670	37,950	39,930												
7	29,420	31,730	33,085	30,830	33,240	34,660												
8	25,875	27,570	28,565	27,110	28,880	29,930	34,525	36,790	38,115	35,760	38,090	39,480						
9	22,690	23,970	24,715	23,770	25,110	25,900	30,275	31,985	32,980	31,360	33,130	34,160						
10	19,930	20,920	21,495	20,880	21,920	22,520	26,600	27,920	28,685	27,550	28,920	29,710						
11	17,585	18,375	18,820	18,420	19,250	19,720	23,465	24,510	25,125	24,310	25,400	26,010						
12	15,590	16,220	16,585	16,340	16,990	17,380	20,805	21,650	22,130	21,550	22,420	22,930						
13	13,895	14,410	14,700	14,560	15,100	15,400	18,545	19,225	19,620	19,210	19,920	20,320						
14	12,450	12,870	13,115	13,040	13,480	13,740	16,615	17,180	17,500	17,210	17,790	18,130	33,260	34,825	35,740	34,460	36,070	37,030
15	11,210	11,560	11,760	11,740	12,110	12,320	14,960	15,425	15,695	15,490	15,980	16,260	30,325	31,645	32,395	31,410	32,780	33,560
16	10,135	10,430	10,600	10,620	10,930	11,110	13,525	13,920	14,150	14,010	14,420	14,650	27,720	28,835	29,490	28,710	29,870	30,540
17	9,205	9,455	9,600	9,650	9,910	10,060	12,285	12,620	12,810	12,730	13,070	13,270	25,415	26,375	26,920	26,330	27,320	27,880
18	8,395	8,610	8,735	8,800	9,020	9,150	11,205	11,495	11,655	11,610	11,900	12,070	23,370	24,195	24,665	24,210	25,060	25,560
19	7,685	7,870	7,975	8,050	8,250	8,360	10,260	10,505	10,645	10,620	10,880	11,030	21,550	22,270	22,670	22,320	23,070	23,490
20	7,060	7,220	7,310	7,400	7,560	7,660	9,420	9,635	9,760	9,760	9,980	10,110	19,925	20,550	20,910	20,640	21,280	21,660
21	6,505	6,645	6,725	6,820	6,960	7,050	8,680	8,870	8,980	8,990	9,190	9,300	18,475	19,020	19,330	19,130	19,700	20,020
22													17,165	17,650	17,925	17,780	18,280	18,570
23													15,990	16,420	16,660	16,560	17,010	17,260
24													14,930	15,310	15,525	15,460	15,860	16,080

Allowable Design Stresses	
Modulus of Elasticity: $E = 1.7 \times 10^6$ psi	
Bending:	Parallel to Gluelines (Beam): $F_b = 2650 \cdot (12/d)^{1/9}$ psi
	Perp to Gluelines (Plank): $F_b = 2400 \cdot (12/d)^{1/9}$ psi
	Compression Parallel to Grain: $F_{cII} = 3000$ psi
Compression Perpendicular to Grain:	
	Parallel to Gluelines (Beam): $F_{c+} = 750$ psi
	Perp to Gluelines (Plank): $F_{c+} = 450$ psi
	Tension Parallel to Grain: $F_t = 1500$ psi

Notes

- 1) Table assumes that the column is braced at column ends only. Effective column length is equal to actual column length.
- 2) Allowable loads are based upon one-piece (solid) column members used in dry service conditions. Contact project's design professional of record or Boise EWP Engineering for multi-piece column design.
- 3) Allowable loads are based on an eccentricity value equal to 0.167 multiplied by either the column thickness or width (worst case).
- 4) Allowable loads are based on axial loaded columns using the design provisions of the National Design Specification for Wood Construction (NDS), 2005 edition. For side or other combined bending and axial loads, see provisions of NDS, 2005 edition.
- 5) Load values are not shown for short lengths due to loads exceeding common connector capacities. Load values are not shown for longer lengths if the controlling slenderness ratio exceeds 50 (per NDS).
- 6) Lateral loads (wind loading) are not considered in this table.

VERSA-STUD® 1.7 2400

Allowable Design Values

Product	Bending F_b [psi]	Compression Parallel to Grain F_c [psi]	Modulus of Elasticity E [psi]	Horizontal Shear F_v [psi]
VERSA-STUD® 1.7 2400	2400	3000	1,700,000	285
Douglas-Fir # 2 Grade	900	1350	1,600,000	180
Spruce Pine Fir (North) # 1 / 2 Grade	875	1150	1,400,000	135
Hem-Fir # 2 Grade	850	1300	1,300,000	150
Western Woods # 2 Grade	675	900	1,000,000	135

Notes:

- Design values are for loads applied to the narrow face of the studs.
- Dimension lumber values taken from 2005 Edition, *NDS Design Values for Wood Construction* (per 2006 IBC/IRC).
- Repetitive member and size factors have not been applied.
- For further information, please see VERSA-LAM® 1.7 2400 Wall Guide.



New BC FRAMER® represents a huge technological leap to help you improve the efficiency and profitability of your engineered wood products business. Boise Cascade will provide you what we believe is now the industry's best design software, offering far greater productivity than even our current version of BC FRAMER®. This new software package will help your design department work faster and accomplish more. You don't get paid to do drawings, but at least now you can do them in less time, and better.

- Shrink design time with BC FRAMER® model sharing.
- Save time & prevent mistakes with best-in-industry file integration.
- Experience the efficiencies of BC FRAMER® whole house modeling.
- Draw floor and wall plans simultaneously with BC FRAMER®.
- Check the plan every possible way with BC FRAMER® full 3-D viewer.
- Create a master plan and multiple options that can be quickly selected and exported to a plot-specific file in a few minutes – a fraction of the time it could have taken in the past.

Information can also be obtained at 1-800-405-5969 or email us at EWPSupport@BC.com.

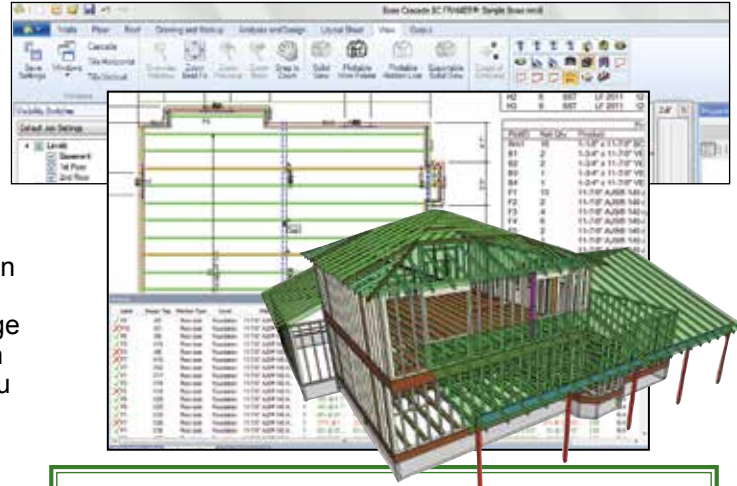

RECOMMENDED HARDWARE

- **CPU:** Quad Core 64 bit Processor
- **L2 Cache:** 3MB/Core
- **RAM:** 4.0GB to 8.0 GB
- **Video:** Full support for DirectX 9; Single monitors, 1280x1024 128MB; Dual monitor, 1280x1024 256MB (Minimum 1024x768)
- **Operating Systems:** Windows® 7 or 8 (Professional Editions 32-bit and 64-bit)

Actual specifications vary by user and will be assessed prior to installation.

BC CALC® 4.0 Sizing Software

BC CALC® is simple to use, yet robust enough to analyze most all joist, beam, and column applications. Once an analysis is run, the user may print an easy-to-read design report that displays the span and load information with the analysis results.

BC COLUMN® has now been merged into BC CALC®, allowing the sizing of joists, beams, rafters, columns, and studs all in one convenient program.

In addition to BCI® & AJS® Joists, VERSA-LAM®, and BOISE GLULAM®, BC CALC® also offers the analysis of solid sawn lumber and timber members. Thus BC CALC® is the only program needed to analyze structural wood members.



Boise Cascade has provided BC CALC® free of charge to the design community since 1994.

COMPUTER REQUIREMENTS

PC with any current version of MS Windows®, along with an internet connection. For questions regarding BC CALC®, call 1-800-405-5969 or email EWPSupport@BC.com.

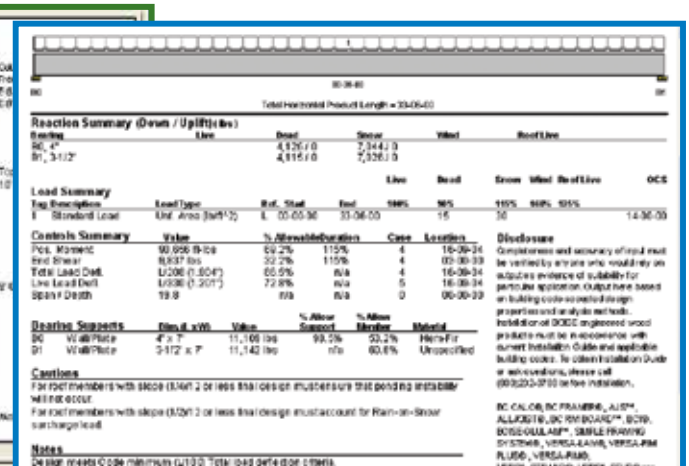
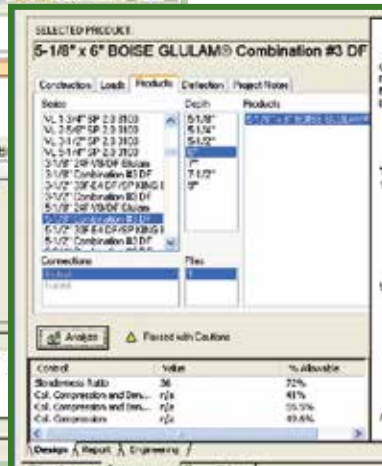

To Download BC CALC US,

<http://www.bc.com/wood/ewp/software/bccalc.html>

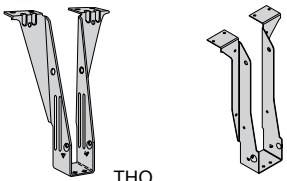
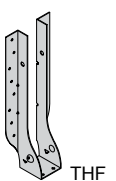
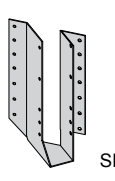
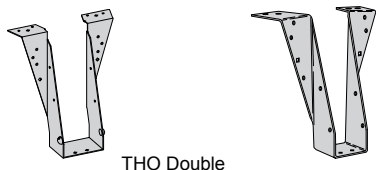

Framing Connectors - Simpson Strong-Tie

Single Joist - Top Flange						Single Joist - Face Mount						Face Mount Skewed 45° Joist Hanger					
<p>ITS MIT</p>						<p>IUS MIU</p>						<p>SUR/L</p>					
Joist Depth	BCI®	Hanger	Capacity [lbs]	Nailing		Joist Depth	BCI®	Hanger	Capacity [lbs]	Nailing		Joist Depth	BCI®	Hanger	Capacity [lbs]	Nailing	
				Header	Joist					Header	Joist					Header	Joist
9½"	5000 1.7	ITS2.06/9.5	993	6-10d	2-10dx1½"	9½"	5000 1.7	IUS2.06/9.5	935	8-10d	-	9½"	5000 1.7	<i>SUR/L2.06/9</i>	1251	14-16d	6-10dx1½"
	6000 1.8	ITS2.37/9.5	1225	6-10d	2-10dx1½"		6000 1.8	IUS2.37/9.5	935	8-10d	-		6000 1.8	<i>SUR/L2.37/9</i>	1417	14-16d	6-10dx1½"
	6500 1.8	ITS2.56/9.5	1225	6-10d	2-10dx1½"		6500 1.8	IUS2.56/9.5	935	8-10d	-		6500 1.8	<i>SUR/L2.56/9</i>	1417	14-16d	6-10dx1½"
	5000 1.7	ITS2.06/11.88	1068	6-10d	2-10dx1½"		5000 1.7	IUS2.06/11.88	1068	10-10d	-		5000 1.7	<i>SUR/L2.06/11</i>	1467	14-16d	6-10dx1½"
	6000 1.8	ITS2.37/11.88	1237	6-10d	2-10dx1½"		6000 1.8	IUS2.37/11.88	1170	10-10d	-		6000 1.8	<i>SUR/L2.37/11</i>	1467	16-16d	6-10dx1½"
	6500 1.8	ITS2.56/11.88	1237	6-10d	2-10dx1½"		6500 1.8	IUS2.56/11.88	1170	10-10d	-		6500 1.8	<i>SUR/L2.56/11</i>	1467	14-16d	2-10dx1½"
	60 2.0	ITS2.37/11.88	1210	6-10d	2-10dx1½"		60 2.0	IUS2.37/11.88	1170	10-10d	-		60 2.0	<i>SUR/L2.37/11</i>	1466	14-16d	6-10dx1½"
	90 2.0	ITS3.56/11.88	1478	6-10d	2-10dx1½"		90 2.0	IUS3.56/11.88	1405	10-10d	-		90 2.0	<i>SUR/L410</i>	1860	14-16d	6-16d
	5000 1.7	ITS2.06/14	1081	6-10d	2-10dx1½"		5000 1.7	IUS2.06/14	1081	12-10d	-		5000 1.7	<i>SUR/L2.06/11</i>	1693	18-16d	8-10dx1½"
	6000 1.8	ITS2.37/14	1262	6-10d	2-10dx1½"		6000 1.8	IUS2.37/14	1262	12-10d	-		6000 1.8	<i>SUR/L2.37/14</i>	1693	18-16d	8-10dx1½"
	6500 1.8	ITS2.56/14	1262	6-10d	2-10dx1½"		6500 1.8	IUS2.56/14	1262	12-10d	-		6500 1.8	<i>SUR/L2.56/14</i>	1693	18-16d	8-10dx1½"
	60 2.0	ITS2.37/14	1225	6-10d	2-10dx1½"		60 2.0	IUS2.37/14	1225	12-10d	-		60 2.0	<i>SUR/L2.37/14</i>	1689	18-16d	8-10dx1½"
	90 2.0	ITS3.56/14	1507	6-10d	2-10dx1½"		90 2.0	IUS3.56/14	1405	12-10d	-		90 2.0	<i>SUR/L414</i>	2035	18-16d	8-16d
	6000 1.8	ITS2.37/16	1268	6-10d	2-10dx1½"		6000 1.8	IUS2.37/16	1268	14-10d	-		6000 1.8	<i>SUR/L2.37/14</i>	1920	18-16d	8-10dx1½"
	6500 1.8	ITS2.56/16	1362	6-16d	2-10dx1½"		6500 1.8	IUS2.56/16	1268	14-10d	-		6500 1.8	<i>SUR/L2.56/14</i>	1920	18-16d	8-10dx1½"
	60 2.0	ITS2.37/16	1228	6-16d	2-10dx1½"		60 2.0	IUS2.37/16	1228	14-10d	-		60 2.0	<i>SUR/L2.37/14</i>	1912	18-16d	8-10dx1½"
	90 2.0	ITS3.56/16	1520	6-10d	2-10dx1½"		90 2.0	IUS3.56/16	1640	14-10d	-		90 2.0	<i>SUR/L414</i>	2235	18-16d	8-16d
	90 2.0	<i>MIT418</i>	2400	6-16d	2-10dx1½"		90 2.0	<i>MIU3.56/18</i>	2407	22-16d	2-10dx1½"		90 2.0	<i>SUR/L414</i>	2395	18-16d	8-16d
	90 2.0	<i>MIT420</i>	2400	6-16d	2-10dx1½"		90 2.0	<i>MIU3.56/20</i>	2564	24-16d	2-10dx1½"		90 2.0	<i>SUR/L414</i>	2395	18-16d	8-16d
Double Joist - Top Flange						Double Joist - Face Mount						Variable Pitch Joist Connector					
<p>MIT B</p>						<p>U/HU MIU</p>						<p>VPA</p>					
Joist Depth	BCI®	Hanger	Capacity [lbs]	Nailing		Joist Depth	BCI®	Hanger	Capacity [lbs]	Nailing		Joist Depth	BCI®	Hanger	Capacity [lbs]	Fastener	
				Header	Joist					Header	Joist				Top Plate	Rafter	
9½"	5000 1.7	<i>MIT4.12/9.5</i>	2305	10-16d	2-10dx1½"	9½"	5000 1.7	<i>MIU4.12/9</i>	2270	14-16d	6-10d	9½"	5000 1.7	VPA2.06	993	8-10d	2-10dx1½"
	6000 1.8	<i>MIT359.5-2</i>	2400	8-16d	2-10dx1½"		6000 1.8	<i>MIU4.75/9</i>	1860	14-16d	2-10dx1½"		6000 1.8	VPA35	1225	8-10d	2-10dx1½"
	6500 1.8	<i>MIT39.5</i>	2400	8-16d	2-10dx1½"		6500 1.8	<i>MIU5.12/9</i>	2270	14-16d	2-10dx1½"		6500 1.8	VPA3	1225	9-10d	2-10dx1½"
	5000 1.7	<i>MIT4.12/11.88</i>	2305	10-16d	2-10dx1½"		5000 1.7	<i>MIU4.12/11</i>	2840	16-16d	6-10d		5000 1.7	VPA2.06	1068	8-10d	2-10dx1½"
	6000 1.8	<i>MIT3511.88-2</i>	2000	8-16d	2-10dx1½"		6000 1.8	<i>MIU4.75/11</i>	2130	16-16d	2-10dx1½"		6000 1.8	VPA35	1230	8-10d	2-10dx1½"
	6500 1.8	<i>MIT311.88-2</i>	2400	8-16d	2-10dx1½"		6500 1.8	<i>MIU5.12/11</i>	2840	16-16d	2-10dx1½"		6500 1.8	VPA3	1230	9-10d	2-10dx1½"
	60 2.0	<i>MIT3511.88-2</i>	2000	8-16d	2-10dx1½"		60 2.0	<i>MIU4.75/11</i>	2130	16-16d	2-10dx1½"		60 2.0	VPA35	1210	9-10d	2-10dx1½"
	90 2.0	<i>B7.12/11.88</i>	3785	14-16d	6-16d		90 2.0	<i>HU412-2</i>	2145	16-16d	6-16d		90 2.0	VPA4	1230	11-10d	2-10dx1½"
	5000 1.7	<i>MIT4.12/14</i>	2305	8-16d	2-10dx1½"		5000 1.7	<i>MIU4.12/14</i>	3125	18-16d	2-10dx1½"		5000 1.7	VPA2.06	1081	9-10d	2-10dx1½"
	6000 1.8	<i>MIT3514-2</i>	2400	8-16d	2-10dx1½"		6000 1.8	<i>MIU4.75/14</i>	2395	18-16d	2-10dx1½"		6000 1.8	VPA35	1230	9-10d	2-10dx1½"
	6500 1.8	<i>MIT314-2</i>	2400	8-16d	2-10dx1½"		6500 1.8	<i>MIU5.12/14</i>	3125	18-16d	2-10dx1½"		6500 1.8	VPA3	1230	9-10d	2-10dx1½"
	60 2.0	<i>MIT3514-2</i>	2400	8-16d	2-10dx1½"		60 2.0	<i>MIU4.75/14</i>	2395	18-16d	2-10dx1½"		60 2.0	VPA35	1225	9-10d	2-10dx1½"
	90 2.0	<i>B7.12/14</i>	3800	14-16d	6-10d		90 2.0	<i>HU414-2</i>	2680	20-16d	8-16d		90 2.0	VPA4	1230	11-10d	2-10dx1½"
	6000 1.8	<i>MIT4.75/16</i>	2305	8-16d	2-10dx1½"		6000 1.8	<i>MIU4.75/16</i>	2660	20-16d	2-10dx1½"		6000 1.8	VPA35	1230	9-10d	2-10dx1½"
	6500 1.8	<i>MIT5.12/16</i>	2400	8-16d	2-10dx1½"		6500 1.8	<i>MIU5.12/16</i>	3125	20-16d	2-10dx1½"		6500 1.8	VPA3	1230	9-10d	2-10dx1½"
	60 2.0	<i>MIT4.75/16</i>	2305	3-16d	2-10dx1½"		60 2.0	<i>MIU4.75/16</i>	2660	20-16d	2-10dx1½"		60 2.0	VPA35	1228	9-10d	2-10dx1½"
	90 2.0	<i>B7.12/16</i>	3800	14-16d	6-16d		90 2.0	<i>HU414-2</i>	2680	20-16d	8-16d		90 2.0	VPA4	1230	11-10d	2-10dx1½"
	90 2.0	<i>B7.12/18</i>	3800	3-16d	6-16d		90 2.0	<i>HU414-2</i>	2680	20-16d	8-16d		90 2.0	<i>VPA4</i>	1230	11-10d	2-10dx1½"
	90 2.0	<i>B7.12/20</i>	3800	3-16d	6-16d		90 2.0	<i>HU414-2</i>	2680	20-16d	8-16d		90 2.0	<i>VPA4</i>	1230	11-10d	2-10dx1½"
Adjustable Height Joist Hanger						Field Slope and Skew Joist Hanger						<p>For more information, call Simpson Strong-Tie at 1-800-999-5099 or visit their website at www.strongtie.com</p> <p>General Notes</p> <ul style="list-style-type: none"> - Bold italic hangers require web stiffeners. - Capacities will vary with different nailing criteria and/or support conditions; contact supplier or Simpson Strong-Tie for further information. - Capacity values shown are either hanger capacity values (see support requirements below) or BCI® Joist end reaction capacities — whichever is less. - All capacity values are downward loads at 100% load duration. - Use sloped seat hangers when BCI® Joist slope exceeds ¼" per foot. - Use sloped seat hangers and beveled web stiffeners when BCI® Joist slope exceeds ¼" per foot. - Leave ⅛" clearance (⅓" maximum) between the end of the supported joist and the head of the hanger. - At max design capacity shown, hangers may exceed standard ⅓" deflection by ⅓". - For proper installation of the VPA, the 2-10dx1½" joist nails through the bend tabs must be installed at approximately a 45-degree angle. <p>Support Requirements</p> <ul style="list-style-type: none"> - Support material assumed to be VERSA-LAM® or BOISE GLULAM® or sawn lumber (Douglas fir or southern pine species). - Minimum support width for single- and double-joist top mount hangers is 3". - Minimum support width for face mount hangers with 10d and 16d nails is 1¼" and 2", respectively. 					
<p>THAI</p>						<p>LSSU</p>											
Joist Depth	BCI®	Hanger	Capacity [lbs]	Nailing		Joist Depth	BCI®	Hanger	Capacity [lbs]	Nailing		Joist Depth	BCI®	Hanger	Capacity [lbs]	Fastener	
				Header	Joist					Header	Joist				Top Plate	Rafter	
9½"	5000 1.7	<i>THAI2.06/22</i>	1181	6-10d	2-10dx1½"	9½"	5000 1.7	<i>LSSU2.06</i>	995	9-10d	7-10dx1½"	9½"	5000 1.7	<i>LSSU310</i>	995	9-10d	7-10dx1½"
	6000 1.8	<i>THAI3522</i>	1393	6-10d	2-10dx1½"		6000 1.8	<i>LSSU35</i>	995	9-10d	7-10dx1½"		6000 1.8	<i>LSSUH310</i>	1425	14-10d	12-10dx1½"
	6500 1.8	<i>THAI322</i>	1393	6-10d	2-10dx1½"		6500 1.8	<i>LSSU2.06</i>	995	9-10d	7-10dx1½"		6500 1.8	<i>LSSU35</i>	995	9-10d	7-10dx1½"
	5000 1.7	<i>THAI2.06/22</i>	1443	6-10d	2-10dx1½"		5000 1.7	<i>LSSU2.06</i>	995	9-10d	7-10dx1½"		5000 1.7	<i>LSSUH310</i>	1475	14-10d	12-10dx1½"
	6000 1.8	<i>THAI3522</i>	1443	6-10d	2-10dx1½"		6000 1.8	<i>LSSU35</i>	995	9-10d	7-10dx1½"		6000 1.8	<i>LSSU35</i>	995	9-10d	7-10dx1½"
	6500 1.8	<i>THAI322</i>	1443	6-10d	2-10dx1½"		6500 1.8	<i>LSSUH310</i>	1475	14-10d	12-10dx1½"		6500 1.8	<i>LSSU35</i>	995	9-10d	7-10dx1½"
	60 2.0	<i>THAI3522</i>	1439	6-10d	2-10dx1½"		60 2.0	<i>LSSU35</i>	995	9-10d	7-10dx1½"		60 2.0	<i>LSSUH310</i>	1625	14-16d	12-10dx1½"
	90 2.0	<i>THAI422</i>	1715	6-10d	2-10dx1½"		90 2.0	<i>LSSU410</i>	1625	14-16d	12-10dx1½"		90 2.0	<i>LSSU2.06</i>	995	9-10d	7-10dx1½"
	5000 1.7	<i>THAI2.06/22</i>	1600	6-10d	2-10dx1½"		5000 1.7	<i>LSSU2.06</i>	995	9-10d	7-10dx1½"		5000 1.7	<i>LSSU35</i>	995	9-10d	7-10dx1½"
	6000 1.8	<i>THAI3522</i>	1600	6-10d	2-10dx1½"		6000 1.8	<i>LSSU35</i>	995	9-10d	7-10dx1½"		6000 1.8	<i>LSSUH310</i>	1600	14-10d	12-10dx1½"
	6500 1.8	<i>THAI322</i>	1600	6-10d	2-10dx1½"		6500 1.8	<i>LSSU35</i>	995	9-10d	7-10dx1½"		6500 1.8	<i>LSSU35</i>	995	9-10d	7-10dx1½"
	60 2.0	<i>THAI3522</i>	1582	6-10d	2-10dx1½"		60 2.0	<i>LSSU35</i>	995	9-10d	7-10dx1½"		60 2.0	<i>LSSUH310</i>	1625	14-16d	12-10dx1½"

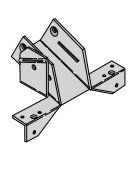
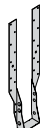
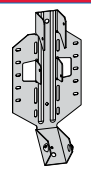
Single Joist - Top Flange						Single Joist - Face Mount						Face Mount Skewed 45° Joist Hanger								
 <p>THO TFL</p>						 <p>THF</p>						 <p>SKH</p>								
Joist Depth	BCI®	Hanger	Capacity [lbs]	Nailing		Joist Depth	BCI®	Hanger	Capacity [lbs]	Nailing		Joist Depth	BCI®	Hanger	Capacity [lbs]	Nailing				
				Header	Joist					Header	Joist					Header	Joist			
9 1/2"	5000 1.7	TFL2095	993	(6)	10d	2-10dx1 1/2"	9 1/2"	5000 1.7	THF20925	910	(8)	10d	2-10dx1 1/2"	9 1/2"	5000 1.7	SKH2020L/R	1153	(14)	10d	10-10dx1 1/2"
	6000 1.8	TFL2395	1225	(6)	10d	2-10dx1 1/2"		6000 1.8	THF23925	1275	(12)	10d	2-10dx1 1/2"		6000 1.8	SKH2320L/R	1384	(14)	10d	10-10dx1 1/2"
	6500 1.8	TFL2595	1225	(6)	10d	2-10dx1 1/2"		6500 1.8	THF26925	1275	(12)	10d	2-10dx1 1/2"		6500 1.8	SKH2520L/R	1384	(14)	10d	10-10dx1 1/2"
11 1/2"	5000 1.7	TFL20118	1068	(6)	10d	2-10dx1 1/2"	11 1/2"	5000 1.7	THF20112	910	(8)	10d	2-10dx1 1/2"	11 1/2"	5000 1.7	SKH2020L/R	1434	(16)	10d	10-10dx1 1/2"
	6000 1.8	TFL23118	1237	(6)	10d	2-10dx1 1/2"		6000 1.8	THF23118	1300	(14)	10d	2-10dx1 1/2"		6000 1.8	SKH2320L/R	1434	(16)	10d	10-10dx1 1/2"
	6500 1.8	TFL25118	1237	(6)	10d	2-10dx1 1/2"		6500 1.8	THF26112	1300	(14)	10d	2-10dx1 1/2"		6500 1.8	SKH2520L/R	1434	(16)	10d	10-10dx1 1/2"
14"	60 2.0	TFL23118	1210	(6)	10d	2-10dx1 1/2"	14"	60 2.0	THF23118	1282	(14)	10d	2-10dx1 1/2"	14"	60 2.0	SKH2320L/R	1428	(16)	10d	10-10dx1 1/2"
	90 2.0	THO35118	1558	(10)	10d	2-10dx1 1/2"		90 2.0	THF35112	1585	(16)	10d	2-10dx1 1/2"		90 2.0	SKH410L/R	1892	(16)	16d	10-16d
	5000 1.7	TFL2014	1081	(6)	10d	2-10dx1 1/2"		5000 1.7	THF20140	1081	(12)	10d	2-10dx1 1/2"		5000 1.7	SKH2024L/R	1562	(16)	10d	10-10dx1 1/2"
 <p>THO Double BPH</p>						 <p>THF Double HD</p>						 <p>TMP</p>								
Joist Depth	BCI®	Hanger	Capacity [lbs]	Nailing		Joist Depth	BCI®	Hanger	Capacity [lbs]	Nailing		Joist Depth	BCI®	Hanger	Capacity [lbs]	Fastener				
				Header	Joist					Header	Joist					Top Plate	Rafter			
9 1/2"	5000 1.7	THO20950-2	2330	(10)	16d	6-10d	9 1/2"	5000 1.7	THF20925-2	1390	(12)	10d	6-10d	9 1/2"	5000 1.7	TMP21	1125	(6)	10d	4-10dx1 1/2"
	6000 1.8	THO23950-2	2825	(10)	10d	6-10d		6000 1.8	THF23925-2	1625	(14)	10d	6-10d		6000 1.8	TMP23	1375	(6)	10d	4-10dx1 1/2"
	6500 1.8	THO25950-2	2650	(10)	16d	6-10d		6500 1.8	THF26925-2	1390	(12)	10d	6-10d		6500 1.8	TMP25	1375	(6)	10d	4-10dx1 1/2"
11 1/2"	5000 1.7	THO20118-2	2330	(10)	16d	6-10d	11 1/2"	5000 1.7	THF20112-2	1855	(16)	10d	6-10d	11 1/2"	5000 1.7	TMP21	1150	(6)	10d	4-10dx1 1/2"
	6000 1.8	THO23118-2	2925	(10)	10d	6-10d		6000 1.8	THF23118-2	1855	(16)	10d	6-10d		6000 1.8	TMP23	1425	(6)	10d	4-10dx1 1/2"
	6500 1.8	THO25118-2	2925	(10)	16d	6-10d		6500 1.8	THF26112-2	1855	(16)	10d	6-10d		6500 1.8	TMP25	1425	(6)	10d	4-10dx1 1/2"
14"	60 2.0	THO23118-2	2921	(10)	16d	6-10d	14"	60 2.0	THF23118-2	1855	(16)	10d	6-10d	14"	60 2.0	TMP23	1425	(6)	10d	4-10dx1 1/2"
	90 2.0	BPH71118	3455	(10)	16d	6-10d		90 2.0	HD7120	2255	(16)	16d	6-10d		90 2.0	TMP4	1800	(6)	10d	4-10dx1 1/2"
	5000 1.7	THO20140-2	2330	(10)	16d	6-10d		5000 1.7	THF20140-2	2320	(20)	10d	6-10d		5000 1.7	TMP21	1150	(6)	10d	4-10dx1 1/2"
 <p>MSH</p>						 <p>LSSH</p>														
Joist Depth	BCI®	Hanger	Capacity [lbs]	Nailing		Joist Depth	BCI®	Hanger	Capacity [lbs]	Nailing		Joist Depth	BCI®	Hanger	Capacity [lbs]	Nailing				
				Header	Joist					Header	Joist					Header	Joist			
9 1/2"	5000 1.7	-	-	-	-	9 1/2"	5000 1.7	LSSH20	1140	(10)	10d	7-10dx1 1/2"	9 1/2"	5000 1.7	LSSH20	1140	(10)	10d	7-10dx1 1/2"	
	6000 1.8	MSH2318	1381	(6)	10d		4-10dx1 1/2"	6000 1.8	LSSH23	1140	(10)	10d		7-10dx1 1/2"	6000 1.8	LSSH23	1140	(10)	10d	7-10dx1 1/2"
	6500 1.8	MSH318	1381	(6)	10d		4-10dx1 1/2"	6500 1.8	LSSH25	1412	(14)	10d		12-10dx1 1/2"	6500 1.8	LSSH25	1412	(14)	10d	12-10dx1 1/2"
11 1/2"	5000 1.7	-	-	-	-	11 1/2"	5000 1.7	LSSH20	1140	(10)	10d	7-10dx1 1/2"	11 1/2"	5000 1.7	LSSH20	1140	(10)	10d	7-10dx1 1/2"	
	6000 1.8	MSH2318	1431	(6)	10d		4-10dx1 1/2"	6000 1.8	LSSH23	1140	(10)	10d		7-10dx1 1/2"	6000 1.8	LSSH23	1140	(10)	10d	7-10dx1 1/2"
	6500 1.8	MSH318	1431	(6)	10d		4-10dx1 1/2"	6500 1.8	LSSH25	1462	(14)	10d		12-10dx1 1/2"	6500 1.8	LSSH25	1462	(14)	10d	12-10dx1 1/2"
14"	60 2.0	MSH2318	1425	(6)	10d	4-10dx1 1/2"	14"	60 2.0	LSSH23	1140	(10)	10d	7-10dx1 1/2"	14"	60 2.0	LSSH23	1140	(10)	10d	7-10dx1 1/2"
	90 2.0	MSH422	1850	(6)	10d	6-10d		90 2.0	LSSH35	1920	(14)	16d	12-10dx1 1/2"		90 2.0	LSSH35	1920	(14)	16d	12-10dx1 1/2"
	5000 1.7	-	-	-	-	5000 1.7		LSSH20	1140	(10)	10d	7-10dx1 1/2"	5000 1.7		LSSH20	1140	(10)	10d	7-10dx1 1/2"	
16"	6000 1.8	MSH2322	1550	(6)	10d	4-10dx1 1/2"	16"	6000 1.8	LSSH23	1140	(10)	10d	7-10dx1 1/2"	16"	6000 1.8	LSSH23	1140	(10)	10d	7-10dx1 1/2"
	6500 1.8	MSH318	1550	(6)	10d	4-10dx1 1/2"		6500 1.8	LSSH25	1675	(14)	10d	12-10dx1 1/2"		6500 1.8	LSSH25	1675	(14)	10d	12-10dx1 1/2"
	60 2.0	MSH2322	1525	(6)	10d	4-10dx1 1/2"		60 2.0	LSSH23	1140	(10)	10d	7-10dx1 1/2"		60 2.0	LSSH23	1140	(10)	10d	7-10dx1 1/2"
18"	90 2.0	BPH7118	3510	(10)	16d	6-10d	18"	90 2.0	HD7180	3920	(28)	16d	6-10d	18"	90 2.0	TMP4	1970	(6)	10d	4-10dx1 1/2"
	90 2.0	BPH7120	3510	(10)	16d	6-10d		90 2.0	HD7180	3920	(28)	16d	6-10d		90 2.0	TMP4	1970	(6)	10d	4-10dx1 1/2"
	20"	90 2.0	BPH7120	3510	(10)	16d		6-10d	20"	90 2.0	HD7180	3920	(28)		16d	6-10d	20"	90 2.0	TMP4	1970

USP STRUCTURAL CONNECTORS
A Milltek Company

For more information, contact USP Lumber Connectors at 1-800-328-5934 or www.uspconnectors.com

- General Notes**
- **Bold Italic hangers required web stiffeners.**
 - Capacities will vary with different nailing criteria and/or support conditions: contact supplier or USP Lumber Connectors for further information.
 - Capacity values shown are either hanger capacity values (see support requirements below) or BCI® Joist end reaction capacities — whichever is less.
 - All capacity values are downward loads at 100% load duration.
 - Use sloped seat hangers when BCI joist slope exceeds 1/4" per foot.
 - Use sloped seat hangers and beveled web stiffeners when BCI® Joist slope exceeds 1/4" per foot.
 - Leave 1/16" clearance (1/8" maximum) between the end of the supported joist and the head of the hanger.
- Support Requirements**
- **Support material assumed to be VERSA-LAM® or BOISE GLULAM® or sawn lumber (Douglas fir or southern pine species).**
 - Minimum support width for single- and double-joist top mount hangers is 3" (1 1/2" for THO hangers).
 - Minimum support width for face mount hangers with 10d and 16d nails is 1 1/4" and 2", respectively.



Boise Cascade has a proven track record of providing quality wood products and a nationwide building materials distribution network for our customers, helping them to enhance their own businesses.

Boise Cascade Engineered Wood Products build better homes with stronger, stiffer floors using only wood purchased in compliance with a number of green building programs. Take a moment to view our sustainability certification site at <http://www.bc.com/sustainability/certification.html> or view our green brochure at http://www.bc.com/wood/ewp/Boise_EWP_Green.html.

Boise Cascade Engineered Wood Products throughout North America can now be ordered FSC® Chain-of-Custody (COC) certified, enabling homebuilders to achieve LEED® points under U.S. Green Building Council® residential and commercial green building programs including LEED for Homes and LEED for New Construction. Boise Cascade Engineered Wood Products are available as PEFC® Chain-of-Custody certified, SFI® Chain-of-Custody certified and SFI Fiber-Sourcing certified, as well as NAHB Research Center Green Approved, enabling homebuilders to also obtain green building points through the National Green Building Standard.

Lifetime Guaranteed Quality and Performance

Boise Cascade warrants its BCI® Joist, VERSA-LAM®, and ALLJOIST® products to comply with our specifications, to be free from defects in material and workmanship, and to meet or exceed our performance specifications for the normal and expected life of the structure when correctly stored, installed and used according to our Installation Guide.

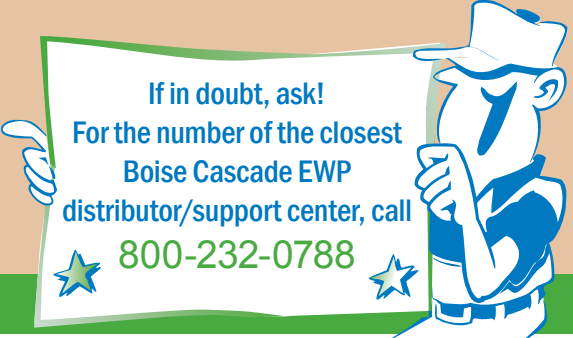

If in doubt, ask!
For the number of the closest
Boise Cascade EWP
distributor/support center, call
800-232-0788

BOISE CASCADE, TREE-IN-A-CIRCLE, BCI, BC CALC, BC COLUMN, BC FRAMER, BC RIM BOARD, BOISE GLULAM, SIMPLE FRAMING SYSTEM, VERSA-LAM, VERSA-RIM, VERSA-STRAND, and VERSA-STUD are trademarks of Boise Cascade Company or its affiliates.

For information about
Boise Cascade Engineered Wood Products,
including sales terms and conditions,
warranties and disclaimers,
visit our website at www.BCewp.com

Your Dealer is:

If no dealer is listed, call 1-800-232-0788



Boise Cascade
Engineered Wood Products

Great products are only the beginning.®