

What affects the range of a trebuchet?

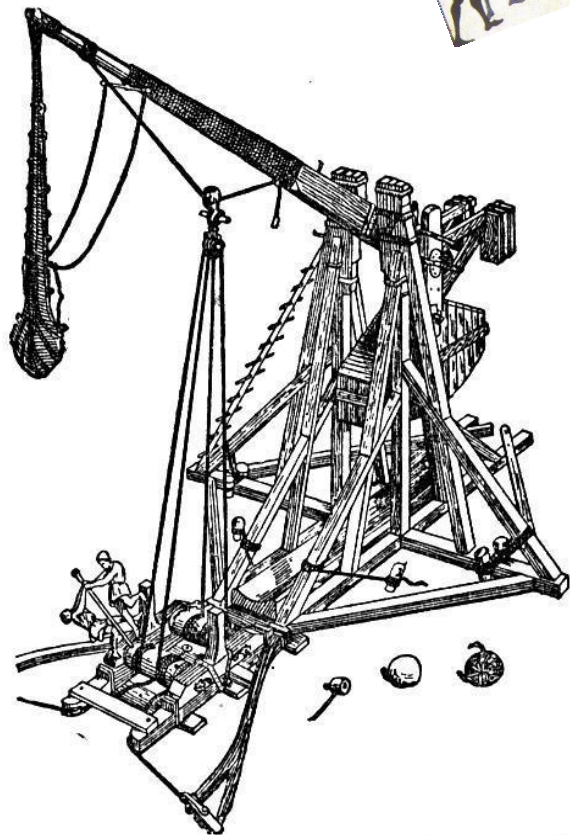
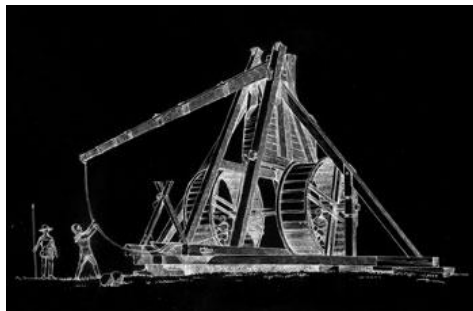
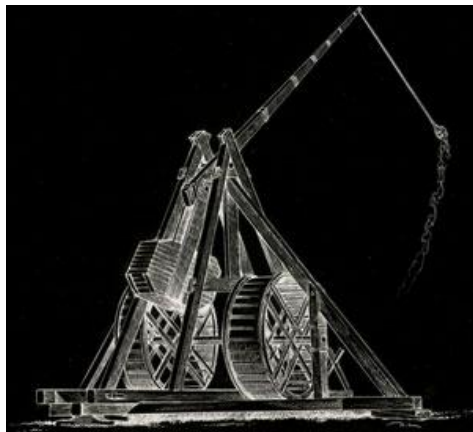
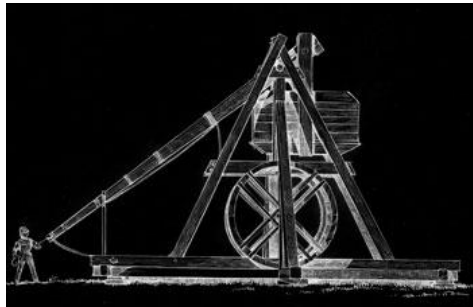

By Stephen Lucas

What affects the range of a Trebuchet?

Planning

Aim: To find which factors limit the distance travelled by a projectile fired from a small scale tabletop trebuchet, and therefore to find which conditions are necessary for optimum range.

Hypothesis

I anticipate that the greatest range of the trebuchet will be achieved when there is:

- A large ratio of counterweight mass to projectile mass – i.e. the mass of the counterweight is far greater than the mass of projectile.
- A large distance between the fulcrum and the projectile.
- A large height above the ground from which the counterweight is suspended.
- The use of aerodynamic projectiles.
- Minimum friction about the fulcrum.
- The use of a light swing arm.

Introduction

A trebuchet is a siege engine that was predominantly employed in the middle ages to smash masonry walls and to hurl objects such as diseased bodies into the castle grounds to infect the inhabitants under siege. Although trebuchets are no longer used in modern warfare due to technological advances, some are still in existence for medieval reconstructions, such as the fire ball throwing trebuchet at Warwick Castle.

Figures 1 & 2 – The trebuchet in use at Warwick Castle:



The range of the trebuchet would have been a vital piece of information both to the armies using them at the time and to those trying to reconstruct one for entertainment. A large range would have enabled the armies using them to attack castles without being in range of the enemy archers and so producing vast amounts of damage with few casualties of their own. If the range of the trebuchet was too small then the armies using them would be vulnerable, and those trying to recreate the medieval experience at historical attractions would lose the interest of an audience.

Knowing the velocity of the projectile as it leaves the swing arm of the trebuchet would have also been a crucial piece of information for those controlling them, since this could be used to accurately predict the maximum height reached by the projectile (i.e. will it get over the castle wall) and where the projectile will land, and thus with what velocity will it strike the target at (determining the potential damage it could cause).

The trebuchet I shall be constructing is designed to operate safely within a classroom so it will be relatively small and designed to hold reasonably light weights, giving a measurable distance of the range of the projectile.

In order to deduce the factors that affect the range of the trebuchet, I will be keeping the mass of the projectile constant while using increasing masses of counterweights. I will also be using varying masses for projectiles while keeping the mass of the counterweight constant and then collectively looking at these results to see which ratio of counterweight mass to projectile mass gives the maximum range.

The trebuchet arm is also drilled with three different holes, each drilled increasingly further from the end that the counterweight is suspended from. These three holes correspond to three different distances between the fulcrum and counterweight and projectile, giving three different heights above the ground level from which the counterweight will be held. By looking at these three variables individually, it should be clear as to which factors produce the greatest range.

Construction of the Trebuchet

The materials used will have to be easily obtainable, and for this reason I shall be constructing the frame of the trebuchet from MDF and the swing arm from pine wood. The arm must be able to be drilled and hammered without cracks spreading and to support weights that have more mass than itself.

Pine is suitable for this purpose as it is strong and stiff, and so will not deform when the counterweight is added and will require a large force before the arm breaks. Pine has an approximate Young Modulus of: 5.49×10^9 Pa. The MDF is not of high quality, however its purpose in terms of the trebuchet is to provide support and so it will not experience a great deal of weight or impact and so serves this purpose well. The MDF will be connected via super glue using a glue gun and small nails where necessary to increase its strength as a base.

The fulcrum will consist of a brass wire with a constant diameter of 2.9×10^{-3} m, this diameter closely matches the diameter of the holes produced by the drill, and its smooth surface will offer negligible friction to the swinging motion of the arm. The fact that the diameter closely matches the holes drilled will allow the arm to complete its circular arc without wobbling. The metal wire is light and stiff, so it will not bend as masses are added to the trebuchet or exert a great deal of force on the base.

The following apparatus was utilised for the construction of the trebuchet:

* MDF (one inch by one half inch thick):

- 12 inch length x 2
- 10 inch length x 2
- 5 inch length x 3

- Square piece of flat wood (6 inches by 6 inches)
- * Pine (Cross-sectional area of: $2.28 \times 10^{-4} \text{m}^2$):
- 16 inch length x 1
- * Glue gun with glue sticks
- * Eyehooks x 2
- * Small screws
- * Small nails
- * Hammer
- * Drill
- *Tape measure and ruler

Great care was taken when constructing the trebuchet to ensure that the trebuchet was constructed safely, and that holes were drilled in straight lines and at central points where necessary. The use of machinery to cut the wood was performed by experienced technology teachers.

Changes made to the initial design of the trebuchet after testing

The original design of the trebuchet was to have a fabric pouch in which the projectile would be stored. This pouch would be stored underneath the swing arm and swing outwards as the counterweight fell to the ground. Each end of the fabric pouch would have a piece of string coming off of it, which would be connected to one end of the trebuchet arm. One of the pieces of string would be firmly tied around the eye hook at the end of the trebuchet arm. At the end of the other string would be a metallic ring that would slot onto a hook at the same end of the trebuchet arm. As the trebuchet arm swung forward, the metallic ring would slide off the hook, releasing one of the strings, opening up the pouch and hurling the projectile forward.

Figures 3 & 4 – The original design of the trebuchet with the string and pouch:



After constructing this type of trebuchet, it proved to be unsuccessful in producing enough data to be harvested. The pouch that stored the projectile resisted releasing it as the edges of the pouch did not allow free movement. The metal ring resting on the hook also did not consistently fall off the hook, meaning that the projectile remained in the pouch or did not travel any notable distance on many attempts. In addition the background physics behind this type of trebuchet involved differentials and appeared to be too complicated for this level.



The trebuchet was then modified so that the projectile was fired every time and could easily be analysed. The fabric pouch was replaced with a plastic spoon super-glued to the top of the trebuchet arm.

At the end of the plastic spoon, blu-tack was stuck to form a vertical barrier, so that the projectile was securely held and could not fall free before being released. This type of trebuchet produced consistent launches and very rarely failed to launch the projectile.

Figure 5 – Side view of the final trebuchet:

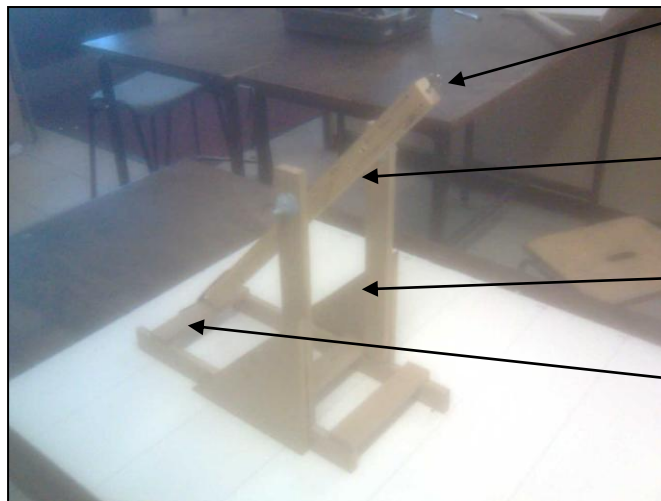

Eye hook supporting counterweight (string is thread through the eye hook and around the counterweight)

Fulcrum

Base of Trebuchet

The end of the swing arm to which the spoon is attached

Spoon – where projectile is held

Trebuchet Arm

Fulcrum

(There is Blu-tack at each end to keep the fulcrum in place)

Counterweight

Trebuchet Base

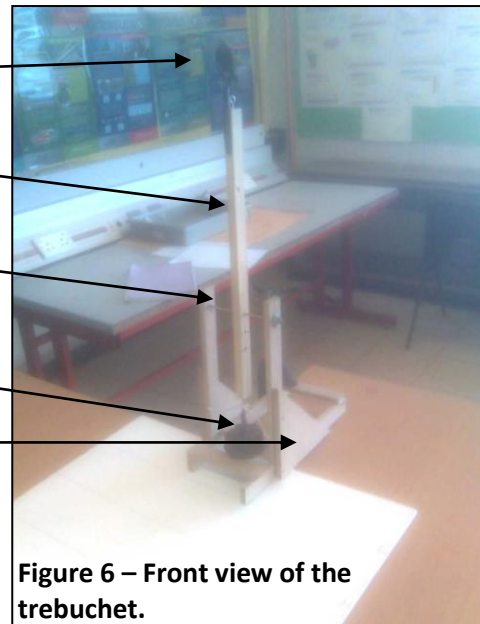

Figure 6 – Front view of the trebuchet.

Information on the final design of the Trebuchet

| | | | |
|---|-------------------------|-------|-------|
| Mass of Trebuchet (kg) | 4.9715×10^{-1} | | |
| Mass of Arm (kg) | 6.205×10^{-2} | | |
| Mass of Base (kg) | 4.351×10^{-1} | | |
| Distances from the counterweight hook to the fulcrum (m) | 0.076 | 0.103 | 0.128 |
| Distances from the projectile holder to the fulcrum (m) | 0.412 | 0.386 | 0.360 |
| Maximum height of Counterweight from ground level (m) *without string | 0.276 | 0.295 | 0.335 |
| Height of projectile before release (m) | 0.670 | 0.647 | 0.624 |
| Angle made with ground and the projectile holder before release (radians) * Rounded to 3 decimal places | 0.681 | 0.801 | 0.855 |

The previous table is the table referred to when making calculations and trying to anticipate how far the projectile will travel and with what velocity it will be released.

Projectile Motion

The distance travelled by a projectile can be calculated by resolving the vertical and horizontal components of the projectile's initial velocity. The two vertical and horizontal components of the motion are independent of each other and so can be treated separately. For simplicity I will assume that air resistance is negligible, so that the only force acting on the projectile after it leaves the swing arm of the trebuchet is gravity. Gravity gives a downward acceleration of 9.81ms^{-2} , there is no horizontal component of gravity, so the horizontal velocity remains constant – i.e. there is no horizontal acceleration. The overall effect is that the projectile will follow a parabolic trajectory through the air.

When the trebuchet launches the projectile, I anticipate that there are two possible situations:

- The projectile will be released at an angle to the horizontal (i.e. it will be released early).
- The projectile will be released horizontally, as the swing arm becomes perfectly vertical – its initial vertical velocity will be zero, it will leave with horizontal velocity only.

If we consider the first scenario, then we can deduce a formula to anticipate the distance travelled. Resolving the initial velocity into its horizontal and vertical components gives:

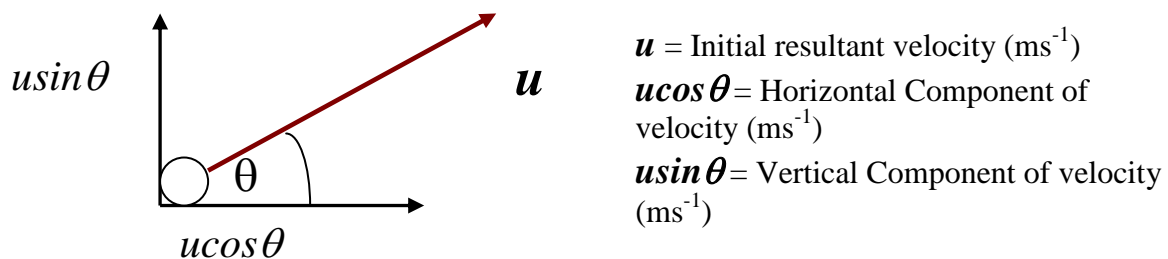

When the projectile reaches its maximum height, its vertical component of velocity equals zero. At this point, the projectile stops travelling upwards and begins to travel in the opposite direction – towards the ground.

Assuming the trajectory follows a perfect parabola and was released from ground level, the time taken to reach maximum height is half of the total time to reach the ground. Figure 7 displays the parabolic path of a projectile fired from ground level

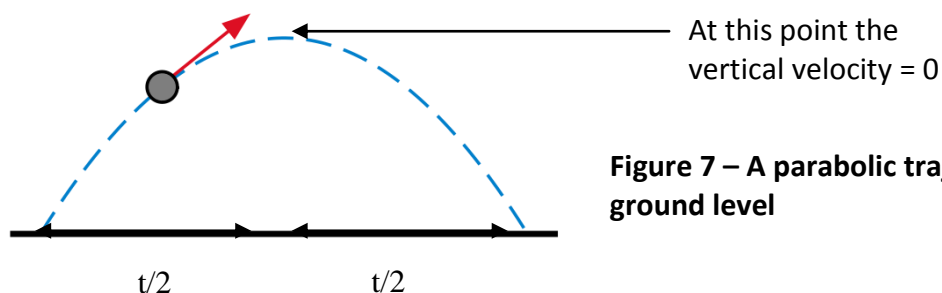

The Linear Equations of motion

$$v = u + at \quad (1)$$

$$s = \frac{1}{2}(u + v)t \quad (2)$$

$$s = ut + \frac{1}{2}at^2 \quad (3)$$

$$v^2 = u^2 + 2as \quad (4)$$

To calculate the time of flight we can use equation (3):

$$s = ut + \frac{1}{2}at^2$$

$s = 0\text{m}$ because the projectile falls back to the ground and was released from the ground.

$u =$ the initial vertical velocity, $u \sin \theta$ (ms^{-1}).

$a = g$, -9.81ms^{-2} (assuming the only acceleration is the acceleration due to gravity)

$$0 = u \sin \theta t - \frac{gt^2}{2}$$

So

$$\frac{gt^2}{2} = u \sin \theta t$$

$$t = \frac{2u \sin \theta}{g}$$

$$v = \frac{\Delta s}{\Delta t}$$

$$\text{So } \Delta s = v \Delta t$$

We know that horizontal velocity remains constant, so the horizontal displacement is therefore:

Horizontal displacement = horizontal velocity x time of flight

$$s = u \cos \theta \times \frac{2u \sin \theta}{g}$$

$$s = \frac{2u^2 \sin \theta \cos \theta}{g}$$

This formula suggests that the angle to the horizontal providing the maximum horizontal displacement is 45° . At 45° the horizontal displacement equals:

$$s = \frac{u^2}{g}$$

Increasing the angle or decreasing the angle still does not produce a value as large as $\sin 45^\circ \cos 45^\circ$ (which equals $\frac{1}{2}$). $2 \sin \theta \cos \theta$ is the same as $\sin 2\theta$ so when θ is 45 this gives the maximum value of one for $\sin 2\theta$. This formula is based on the fact that the projectile has been launched from the ground level; however for a trebuchet this will not be true.



Rearrange to get rid of the negative sign.

Divide both sides by t and multiply both sides by 2 to find the time of flight.

The swing arm is raised above the ground, supported on the fulcrum, and a distance h from the ground when it releases the projectile. The optimum angle is therefore unlikely to be 45° , and the range will be given by a new formula. There is also the shape of the projectile to consider, as well as its mass and the effects of spin and air resistance which will mean the optimum angle is less likely to be 45° .

Figure 8 – The likely path of the projectile, when released at an angle to the horizontal:

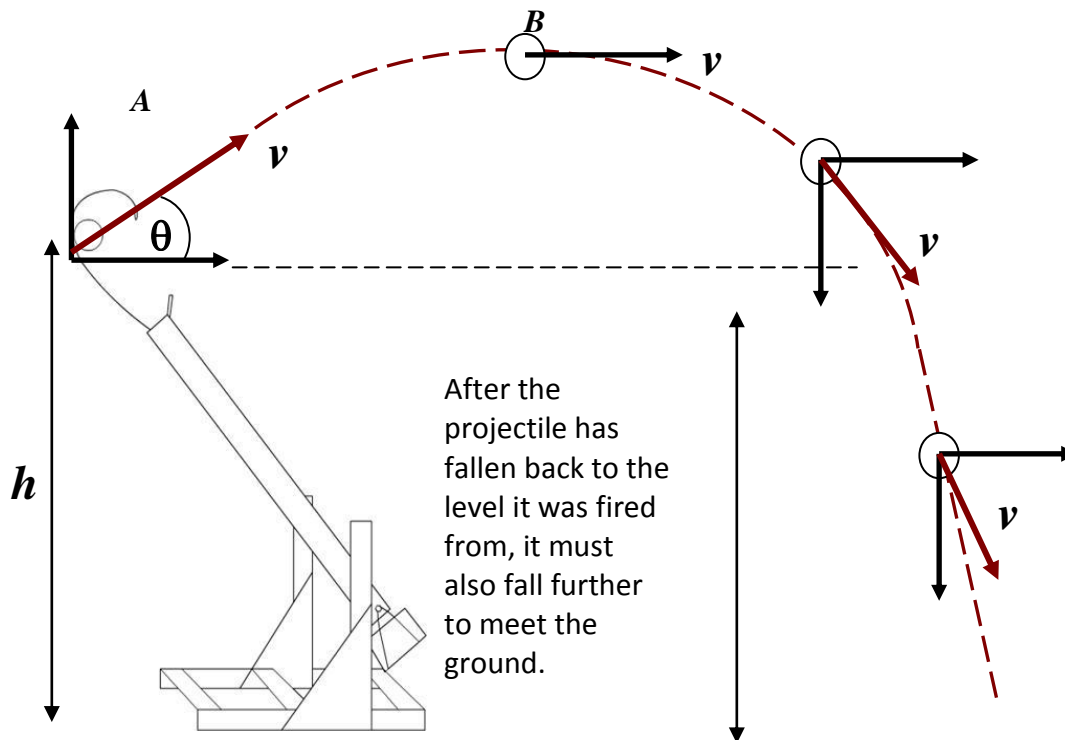

Calculating the range of the projectile if it is released early at an angle, θ , to the horizontal

To calculate the total displacement of the projectile when it is released at an angle, we need to calculate the total time of flight using the vertical components of the missile's velocity, and then multiply this by the projectile's initial horizontal component of velocity (as this remains constant).

Looking at the diagram above, when the projectile reaches point B , its vertical component of velocity is equal to 0 ms^{-1} . Beyond this point the projectile starts to fall downwards towards the ground. By looking at the vertical component of velocity up to this point, and assuming the upward motion to be positive, we can deduce the following information:

$$a = -9.81 \text{ ms}^{-2} \text{ (Acceleration due to gravity - } g\text{)}$$

$$u_v = u \sin \theta \text{ ms}^{-1} \text{ (Vertical component of velocity)}$$

$$v_B = 0 \text{ ms}^{-1} \text{ (The velocity at point } B = 0 \text{ ms}^{-1}\text{)}$$

Therefore, the time taken to reach maximum height can be described by the following formula:

$$v = u + at \quad 0 = u \sin \theta - gt$$

$$-u \sin \theta = -gt$$

Although the formula states '+ at', as we are assuming upward motion to be positive, it thus follows that the downward acceleration due to gravity is negative.

$$\frac{-u \sin \theta}{-g} = \frac{u \sin \theta}{g} = t$$

Time taken to reach maximum height: $\frac{u \sin \theta}{g}$

Once the projectile has reached maximum height it must fall through the height to which it was released from and then through the height that the trebuchet arm was above ground when it released the projectile – h . In order to be able to calculate the time taken for the projectile to fall to the ground from its maximum height, we need to know the maximum height that the projectile achieved. Aforementioned, at maximum height, the vertical component of velocity = 0ms^{-1} , and all the acceleration is assumed to be due to gravity only.

Using:

$$v^2 = u^2 + 2as$$

$$0 = u^2 \sin^2 \theta - 2gs$$

So, s , the vertical displacement is equal to:

$$s = \frac{-u^2 \sin^2 \theta}{-2g} = \frac{u^2 \sin^2 \theta}{2g}$$

Therefore the total height that the projectile will fall through from point B (see diagram) is:

$$h + \frac{u^2 \sin^2 \theta}{2g}$$

Using this information, the time taken to fall through this height can be deduced using the following formula:

$$s = ut + \frac{1}{2}at^2$$

$$\text{If } s = h + \frac{u^2 \sin^2 \theta}{2g}$$

Then:

$$h + \frac{u^2 \sin^2 \theta}{2g} = \frac{1}{2}gt^2$$

$$2(h + \frac{u^2 \sin^2 \theta}{2g}) = gt^2$$

$$2h + \frac{2u^2 \sin^2 \theta}{2g} = gt^2$$

$$2h + \frac{u^2 \sin^2 \theta}{g} = gt^2$$

$$t^2 = \frac{2h}{g} + \frac{u^2 \sin^2 \theta}{g^2}$$

$$t = \sqrt{\left(\frac{2h}{g} + \frac{u^2 \sin^2 \theta}{g^2} \right)}$$

u = initial velocity, and if we are considering the motion from maximum height, then the vertical initial velocity is equal to 0ms^{-1} so $s = ut + \frac{1}{2}at^2$ becomes $s = \frac{1}{2}at^2$.

Again, all the acceleration is assumed to be due to gravity.

Here the square root sign refers to the square root of the whole equation.

So the time taken to fall from maximum height is given by:

$$t = \sqrt{\left(\frac{2h}{g} + \frac{u^2 \sin^2 \theta}{g^2} \right)}$$

Therefore the total time of flight is:

Time to reach maximum height + Time to fall through maximum height

$$t_{\text{tot}} = \frac{u \sin \theta}{g} + \sqrt{\frac{2h}{g} + \frac{u^2 \sin^2 \theta}{g^2}}$$

So the horizontal displacement of the projectile is given by:

Horizontal velocity x time of flight = Horizontal displacement

$$\text{Horizontal distance: } u \cos \theta \left[\frac{u \sin \theta}{g} + \sqrt{\frac{2h}{g} + \frac{u^2 \sin^2 \theta}{g^2}} \right]$$

$$\text{Horizontal distance: } \frac{u^2 \sin \theta \cos \theta}{g} + u \cos \theta \sqrt{\frac{2h}{g} + \frac{u^2 \sin^2 \theta}{g^2}}$$

Horizontal distance:

This formula is quite complicated, but it suggests that the distance travelled by the projectile will be greatest when:

- The value for initial velocity is large.
- The height above the ground the projectile is released above is large.
- The angle between the horizontal and the initial velocity is 45°.

There are limitations with using this formula to deduce the range of the projectile. One such limitation is that measuring the angle made with the horizontal will require sophisticated equipment, such as a video camera which is able to record hundreds of frames per second. There is also the issue of finding a scale to measure the angle from as it would be inaccurate to simply place a protractor on the computer screen as an image of the projectile is frozen using film editing software. If the initial velocity was known and so too was the distance travelled then the angle could be calculated by rearranging the formula above. Clearly, measuring the initial velocity also presents difficulties, as it is anticipated that the projectiles will be small and moving relatively fast so light gates would have to be very sensitive to detect the rapid change in signal between the emitter and receiver making up the light gates.

If the angle of projection changed, then it could create difficulties in finding suitable places to place these light gates. The designer of a trebuchet would probably strive for a trebuchet that released the projectile at the same angle/position every time, or design it in such a way that the angle of release could be controlled for specific situations. If the angle of projection was left to chance then this would result in a lot of uncertainty in to where the projectile would actually land. The trebuchet I have constructed is very simple, and so I will have no such control.

The most likely scenario is that the projectile will be released when the trebuchet arm is perfectly vertical as there is no longer an upward reaction force from the spoon supporting it. In this scenario, it will be assumed that the projectile left with horizontal velocity only.

Key

t = time taken (s)

u sin θ = initial vertical velocity (ms⁻¹)

u cos θ = initial horizontal velocity (ms⁻¹)

g = acceleration due to gravity (9.81ms⁻²)

h = the height above the ground between from the point of release (m)

s = displacement (m)

Calculating the range of the trebuchet when the projectile is released with horizontal velocity only:

Figure 9 – Showing the path of the projectile when it leaves the trebuchet with horizontal velocity only:

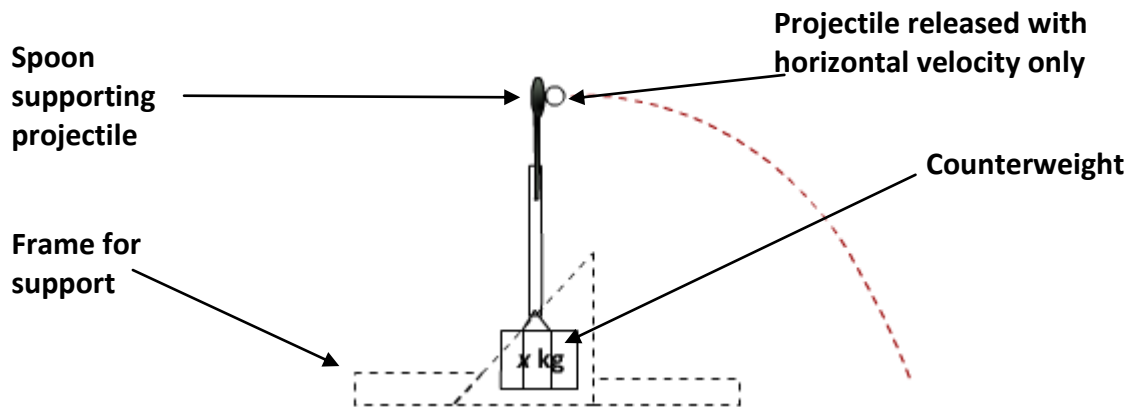

If the projectile leaves with horizontal velocity only, it will therefore have a vertical component of velocity equal to zero metres per second. It will however fall through a vertical height, with all of its downward acceleration being due to gravity, therefore we can deduce the total time of flight using:

$$s = ut + \frac{1}{2}at^2$$

If we assume that the vertical distance the projectile falls through is the height above the ground from which it is released from the arm then:

$$h = \frac{1}{2}gt^2$$

So t^2 :

$$t^2 = \frac{2h}{g}$$

g

$$t = \frac{\sqrt{2h}}{g}$$

Horizontal distance = time of flight x horizontal velocity

Because the projectile leaves with no vertical velocity, we do not need to split it up into its vertical and horizontal components, we can assume, u , the initial velocity, is just its initial horizontal velocity.

So horizontal distance = $u \frac{\sqrt{2h}}{g}$

* The square root sign refers to the square root of $(2 \times h / g)$

From this formula it is clear that, the greater the height above the ground the projectile is released from (i.e. the longer the trebuchet arm) and the greater the initial velocity, the greater the range of projectile. Knowing the time of flight also allows the velocity on impact with the ground/target to be calculated.

Looking at the interchange between gravitational potential energy of the counterweight and kinetic energy of the projectile, we can deduce theoretical values of initial velocity.

The interchange of Gravitational Potential Energy and Kinetic Energy

Figure 10 – A diagram of the set up of the trebuchet:

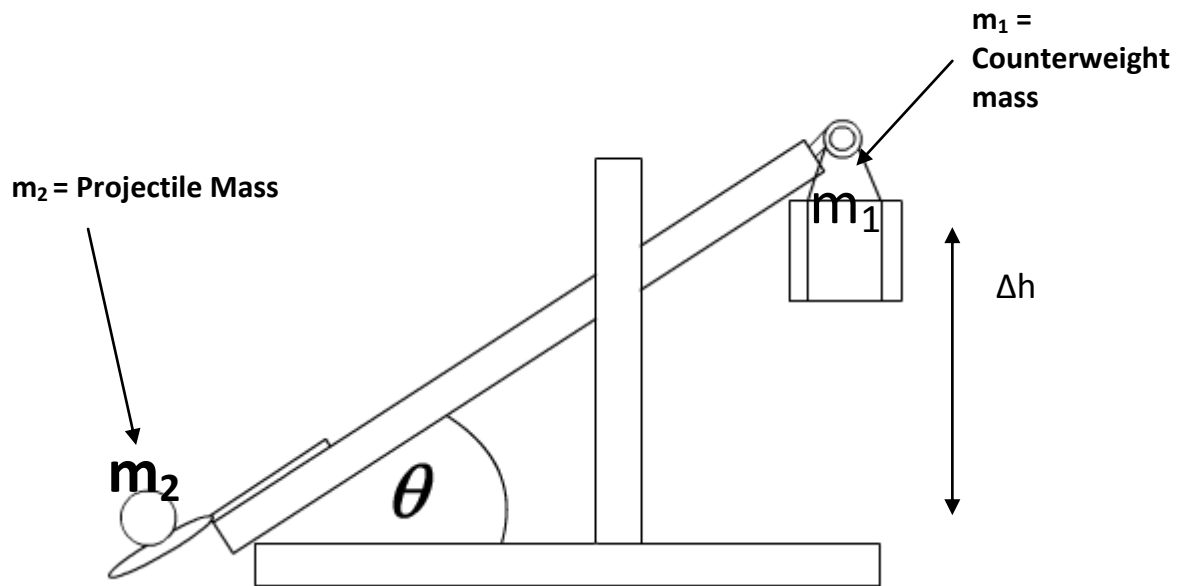

The first law of thermodynamics states that energy cannot be created or destroyed just converted from one form of energy to another. In other words, energy is always conserved. Before the projectile is fired, the counterweight is suspended a distance, h , above the ground. The counterweight therefore gains gravitational potential energy as it is lifted up against the force of gravity. Assuming the counterweight has zero potential energy at ground level, the gravitational potential energy of the counterweight in the diagram is therefore:

$$E_g = m_1 g \Delta h$$

E_g = Gravitational Potential Energy (J)
 m_1 = Counterweight mass (kg)
 Δh = The change in height (m)
 g = Acceleration due to gravity (ms^{-2})

As the counterweight falls through the height h , its gravitational potential energy is converted to the kinetic energy of the missile; its energy due to its motion, and the gravitational potential energy of the missile; the work done to raise it up from the ground against the force of gravity.

If we assumed that all of the gravitational potential energy was transferred to kinetic energy of the missile:

$$E_g = E_k$$

$$m_1 g \Delta h = \frac{1}{2} m_2 v^2$$

However, this formula does not hold true because work must be done to lift the projectile up against the force of gravity before it is fired off into the air. We can therefore say that the gravitational potential energy of the counterweight when it is suspended, h metres above the ground is equal to the increase of kinetic energy of the missile and the increase in the gravitational potential energy of the missile:

$$m_1 g \Delta h = \frac{1}{2} m_2 v^2 + m_2 g \Delta h$$

$$\text{So } v = \frac{\sqrt{2(m_1g\Delta h - m_2g\Delta h)}}{m_2}$$

Again, the square root indicates the square root of the whole equation, not just the numerator.

From this equation it is clear that the greater the gravitational potential energy of the counterweight – therefore the greater the mass of the counterweight m_1 , and the greater the height to which it is raised/ falls through h , and the smaller the mass of the projectile, m_2 , the greater the initial velocity of the projectile when it is released. If the initial velocity is increased, then aforementioned, so too will be the range of the trebuchet because velocity is directly proportional displacement.

Using the previously deduced formula, we can estimate that for a counterweight mass of 1kg, and a projectile of 10g, if the distance between the counterweight and fulcrum is 0.076m then the initial velocity will be:

$$v = \frac{\sqrt{2(1.00 \times 9.81 \times 0.276) - (0.01 \times 9.81 \times 0.670)}}{0.01}$$

$$v = 23 \text{ ms}^{-1}$$

This appears to be a reasonable value of initial velocity. In the calculations it has been assumed that the change in height of the projectile will be the same as the distance between the ground and the trebuchet arm when the arm is perfectly vertical. A projectile with a speed of 23ms^{-1} (51 miles per hour) could cause considerable damage if it were to strike somebody in the eye. For this reason I will advise any students working near me to wear goggles, and I will also corner off the area I am working in so that any stray projectiles do not become a hazard to other students.

Assuming the projectile leaves with horizontal velocity only, we can there assume that the range is given by:

$$\text{Range} = \frac{uv\sqrt{2h}}{g}$$

Therefore if the projectile leaves with an initial velocity of 23ms^{-1} , and a counterweight to fulcrum distance of 0.076m corresponds to a vertical height of the trebuchet arm being 0.670m above the ground, then the horizontal distance travelled by the projectile should be: 8.50m. This gives a long range but it could create measuring difficulties given that the length of the room in which the experiment will be performed could be shorter than 8 metres long.

The previous equation also assumes that all of the gravitational potential energy of the counterweight is transferred to the missile, whereas in actuality, the counterweight speeds up as it falls and does not stop instantaneously once it has fallen through the given height (particularly if it is attached in such a way that it does not hit the floor but continues to move in a circular arc once it has fallen through the maximum height).

The counterweight therefore retains a proportion of the system's energy in its own motion, so the equation becomes:

$$m_1g\Delta h = \frac{1}{2}m_1v_1^2 + \frac{1}{2}m_2v^2 + m_2g\Delta h$$

v_1 = the speed of the counterweight (ms^{-1})

Rearranging this equation, the velocity of the projectile is:

$$v = \sqrt{\frac{m_1 g \Delta h - m_2 g \Delta h - m_1 v_1^2}{m_2}}$$

The arm of the trebuchet is rotating about the fulcrum as the counterweight falls to the ground, it therefore has kinetic energy. However, relative to other masses involved its mass is very small and so it is assumed to be a 'massless' beam so the mass of the swing arm is not included in any of the calculations. If we assume that it has no mass, it then follows that it has no kinetic energy, although in reality it does have mass and this will affect the range of the trebuchet to some degree. For example it will be harder to swing a heavier swing arm in comparison to a lighter one, so a heavier swing arm will require a heavier counterweight to raise the projectile by the same degree.

The equation above requires many values and in particular the velocity of the counterweight after it has fallen could be quite difficult to calculate if it does not instantaneously come to rest and swings to and fro after the projectile has been released. The trebuchet I am constructing is a small scale version of the real thing designed to work in a classroom, so the height the counterweight will fall will be quite small, and measuring the time taken for the counterweight to fall this height visually with a stopwatch could be inaccurate as it will fall too quickly to measure with accuracy and simple equipment. For example, if the distance between the counterweight and the fulcrum is 10.3cm the corresponding height above the ground is 64.7cm. Taking this into account, if the mass of the counterweight is 1kg, using $s=ut + 1/2at^2$, where $u = 0\text{ms}^{-1}$ and assuming all the acceleration is due to gravity, it would take approximately 0.36 seconds to reach the ground level.

Modelling the range of the projectile on the equation that ignores the motion of the counterweight, we can produce a graph on Microsoft Excel to predict the range of the trebuchet for different masses of projectile and counterweight, as well as the different heights from the ground which the counterweight will be suspended.

Graphs 1 & 2

Mass of Counterweight: 1kg

Mass of projectiles: Varying from 0.010kg – 0.100kg

Height of counterweight above ground: 0.276m

Height of projectile above ground before release: 0.670m

Graph 1 – Projectile mass vs Initial Projectile Velocity

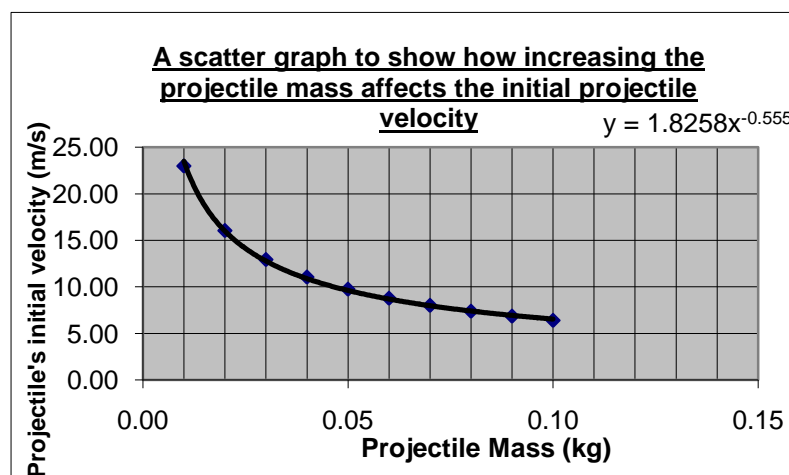

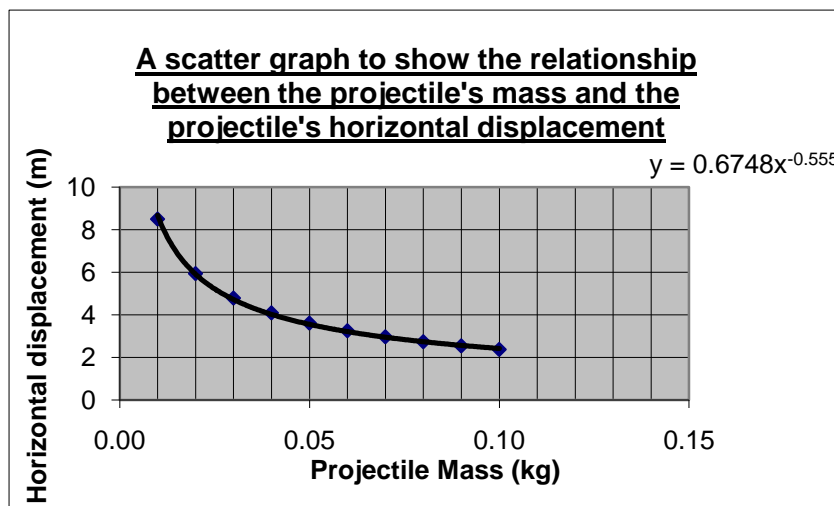
Graph 2 – Projectile mass vs horizontal displacement of the projectile**Graph 3 – Counterweight mass vs Projectile's initial velocity**

Mass of Counterweight: Varying from 0.00 – 1.00kg

Mass of projectiles: 0.010kg

Height of counterweight above ground: 0.276m

Height of projectile above ground before release: 0.670m

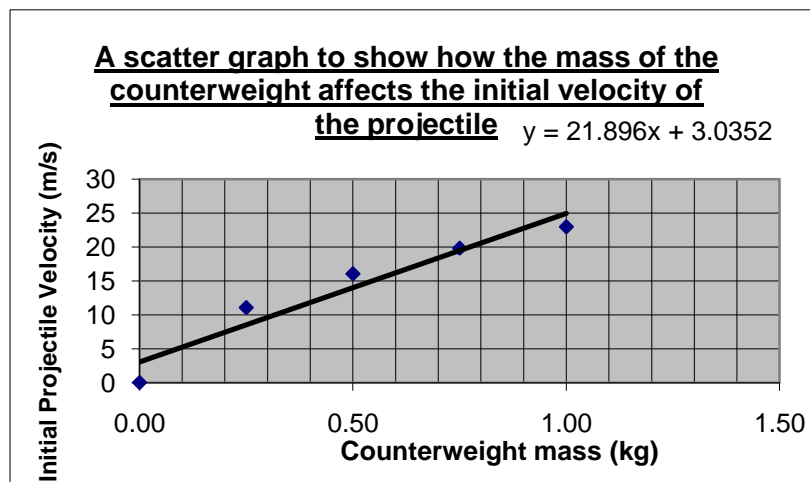
Graph 3

By modelling the initial velocity of the projectile on Microsoft Excel it is clear that as the mass of the counterweight increases, so too does the projectile's initial velocity and hence its horizontal displacement. Although the trend line added on graph 3 suggests a linear relationship, we know that $v \propto \sqrt{(m_1gh - m_2gh)}$, and since the graph of $y = \sqrt{x}$ increases relatively slowly for increasing values of x , it makes sense that there is an optimum ratio for counterweight to projectile mass. If the mass of the counterweight were too large then the fulcrum of the trebuchet would be put under too much stress and could be subject to bending or even snapping.

Looking at graphs 1 and 2, it is clear that as the mass of the projectile increases (while the mass of the counterweight is kept the same) the initial velocity and hence horizontal displacement of the projectile decreases.

The decrease in initial velocity appears to be rapid at first when increasing the weight of the projectile from 0.01 – 0.03kg; however, beyond this point the rate of decrease in the projectile's initial velocity seems to be slower and more gradual. This insinuates that after approximately 0.05kg, adding 10g masses to the projectile's mass reduces the initial velocity by a smaller amount. In other words, it has less of an impact on the projectile's initial velocity.

Graphs 1 and 2 clearly show that the initial velocity of the projectile and hence distance travelled is proportional $1/\text{projectile mass}^{1/2}$. The distance travelled is inversely proportional to the square root of the projectile mass. The graph of $y = x^{-1/2}$ shows that for very small values of x , the value of y increases very rapidly, but for very large values of x , the value of y decreases very slowly. As a result of the inverse proportionality, a graph of distance against $1/V$ (projectile mass) should produce a straight line.

The shape of the graph suggests that the relationship could be governed by a power law or an exponential decay equation. To deduce whether the relation obeys a power law I will be plotting a graph of $\log(\text{distance})$ vs $\log(\text{projectile mass})$ and seeing if the resulting graph is a straight line. If the graph of $\log(y)$ vs $\log(x)$ is a straight line then this will verify that the distance travelled by the projectile is governed by a power law, and the gradient will give the exponent. If the relationship is governed by an exponential equation then the distance travelled by the projectile should change in equal fractions for changing projectile masses, and a graph of $\ln(\text{distance})$ against projectile mass should produce a straight line.

The line of best fit and equation added to the graphs produced on excel suggest a power law is responsible for the relationship between the distance travelled and the projectile mass, however this will be determined experimentally for verification.

By plotting a graph of counterweight mass against distance travelled by the projectile, we can determine the work done on the projectile by multiplying the counterweight masses by 'g'. This gives us the force multiplied by distance. This holds true assuming there are no energy losses in the system.

In actuality, there will be energy losses in the conversion of the counterweight's gravitational potential energy into the kinetic energy of the projectile. These energy losses will arise from the energy dissipated against the resistive forces of the trebuchet such as the friction about the fulcrum and air resistance.

Efficiency of trebuchet:

$$\text{Efficiency} = \frac{\text{Kinetic Energy transferred to the projectile}}{\text{Gravitational potential energy of the counterweight}} \times 100$$

$$\text{Efficiency} = \frac{E_{\text{kprojectile}}}{E_{\text{gcounterweight}}} \times 100$$

I anticipate that the trebuchet will be at least 60% efficient at converting the gravitational potential energy of the counterweight into the kinetic energy of the missile. When the projectile has a mass that requires more energy to be lifted than is available from the gravitational potential energy of the falling counterweight, I expect to observe no movement of the trebuchet arm.

By assuming the initial velocity is governed by the formula:

$$v = \frac{\sqrt{2(m_1g\Delta h - m_2g\Delta h)}}{m_2}$$

Several errors arise. Graph 2 indicates that a projectile of mass 10g with a counterweight mass of 1kg will travel roughly 8.5 metres. This is a long range, and if I am to perform this experiment in a classroom then I want to avoid striking the walls and need the projectile to land unimpeded by anything but the air.

Other areas that highlight the limitations to this method is that the counterweight height above ground used in calculations is the height when there are no masses attached to the end of the swing arm, obviously as the masses are attached by string and have some size they will reduce the height above ground to which they are held. It is likely that the heavier masses will be larger in size and will thus reduce the value of h , yet the increase in mass should be enough to compensate for this loss. Secondly, the counterweight does not fall perfectly vertically; it falls through a circular arc, so the change in height is not quite described by simply measuring the distance between the floor and the counterweight hook.

The aforementioned formula takes no consideration for the distances between the fulcrum and the counterweight or the projectile, the angle between the ground level and the swing arm or the circular motion of the swing arm itself.

Rotational Dynamics of the Trebuchet

The path of the projectile as the counterweight falls will be somewhat similar to this diagram:

Figure 11 – The circular arc of the projectile before being released with tangential velocity:

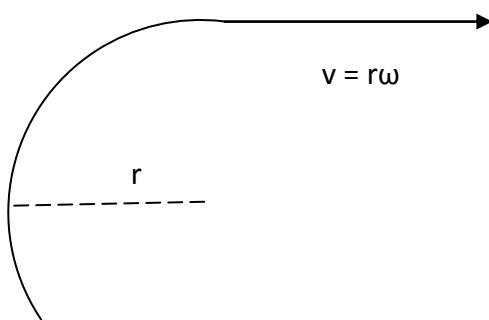

As the counterweight falls, the swing arm goes through a circular arc, releasing the projectile with tangential velocity when the arm is perpendicular to the ground. The heavier counterweight creates a torque (a turning force) about the fulcrum so the whole swing arm undergoes angular acceleration.

Torque is the rotational analog of force and is given by the equation:

$$\vec{\tau} = \vec{r} \times \vec{F}$$

Where, 'r' is the perpendicular distance from the pivot point to the line of force, and 'F' is the force applied. The trebuchet acts like a first class lever, where the effort is produced by the counterweight, and the load is the projectile, however, the trebuchet is trying to throw the load, and not just lift it. The subsequent diagram demonstrates the forces acting perpendicular to the swing arm (if the beam was level) and the pivot is shown by the black dot placed at the right end of the arm.

Figure 12 - showing the forces acting on the arm of the trebuchet:

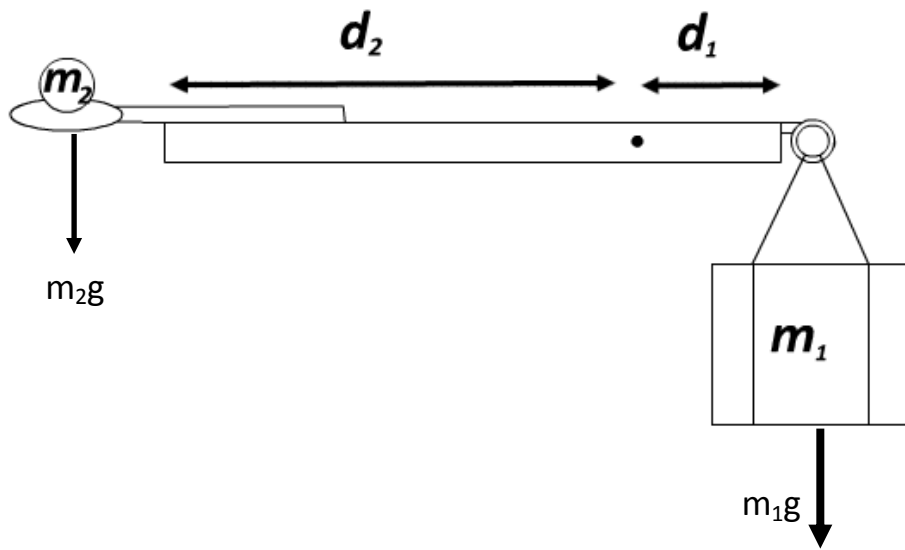

Using the formula aforementioned, the torque acting on the beam is equal to:

$$\tau = (m_1g \times d_1) - (m_2g \times d_2)$$

Note that the torque created by the projectile is subtracted from the torque created by the counterweight because they create torques in opposite directions and torque is a vector quantity. The counterweight creates a larger turning force so this is assumed to be the positive torque. The force is given by Newton's second law, $F = ma$, where 'a' is the acceleration due to gravity and 'm' is the mass of the objects involved.

The torque acting on the swing arm of the trebuchet is not perfectly explained by this simple relationship, as the beam does not begin initially horizontal and so the forces acting are not at right angles to the beam. The torque is therefore found by the equation:

$$\tau = r \times F \sin\theta$$

$$\tau = r \times F \sin\theta$$

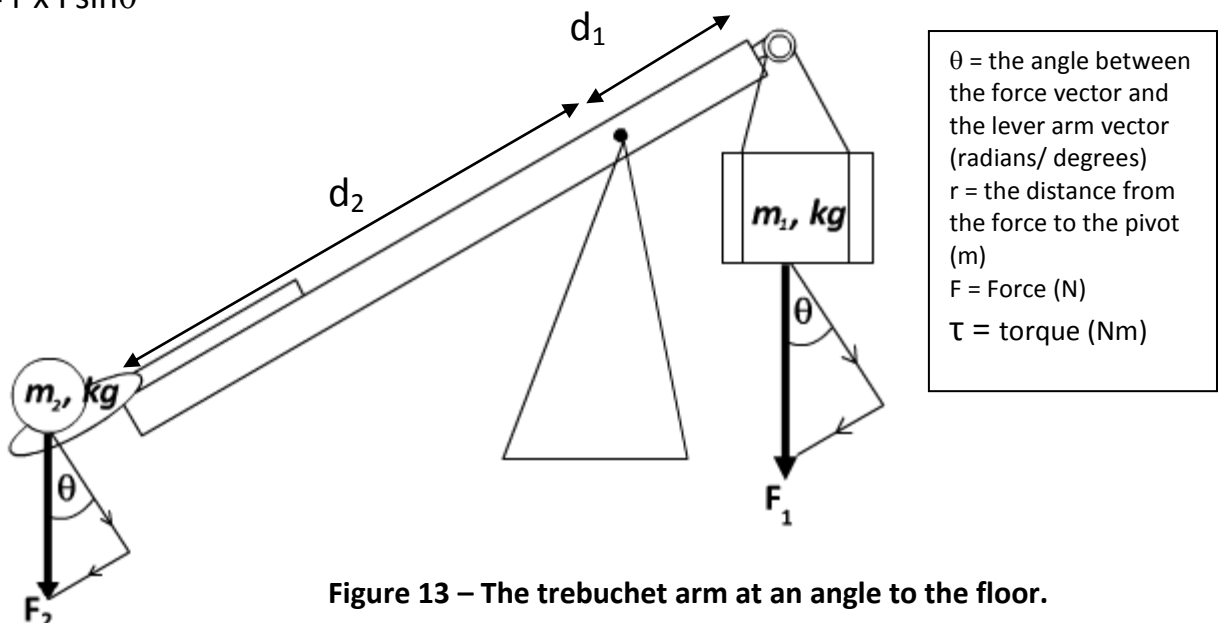

Figure 13 – The trebuchet arm at an angle to the floor.

So the Torque is now given by:

$$\tau = (d_1 \times m_1 g_1 \sin\theta) - (d_2 \times m_2 g_2 \sin\theta)$$

This formula suggests that increasing the force and making the force perpendicular to the beam maximises the value of 'r' and so a larger turning force is created. The formula also suggests that the larger the distance between the counterweight and the pivot, the larger the torque. Unfortunately there is very little to be done that can ensure that the masses experience forces that are perpendicular to the arm, the angles between the force vector and lever arm vector will probably be relatively small and hard to measure and so estimating the range from this formula could be quite difficult.

The equation for Torque can be rearranged to find the angular acceleration of the trebuchet arm and hence projectile, and therefore the angular velocity, ω , can be deduced.

If we apply a torque to a rotating body, or a body at rest, it will undergo angular acceleration (a change in angular velocity). The following relationship holds true and links torque to angular acceleration:

$$\tau = I\alpha$$

I = Moment of Inertia (kgm^2)
 α = angular acceleration (rads^{-2})
 T = torque (Nm)

All masses display inertia – a reluctance to move. For example when a train stops at a station, passengers standing up may continue to travel and therefore involuntarily walk forwards. The moment of inertia is the measure of the opposition of a rotating body to angular acceleration and can be found by the equation:

$$I = \Sigma mr^2$$

(There are various equations for different situations; however I will assume that the above equation applies to the trebuchet)

The Σ symbol refers to the 'sum of' because we assume that the trebuchet is made up of point masses, each which will have a moment of inertia. On a very simplistic scale, the point masses that make up the trebuchet are the counterweight and the projectile, since the beam is assumed to have no mass while the frame is for support and does not experience any motion. The symbol 'r' refers to the radius of the circular path and 'I' refers to the moment of inertia. The Moment of Inertia can therefore be calculated using the simple model in figure 12, modelling the trebuchet as a parallel beam:

$$I = \text{mass of counterweight} \times (\text{distance from fulcrum})^2 + \text{mass of projectile} \times (\text{distance from fulcrum})^2$$

$$I = m_1 d_1^2 + m_2 d_2^2$$

Using : $\tau = I\alpha$, the angular acceleration can be found by:

$$\frac{\tau}{I} = \alpha$$

So the angular acceleration is equal to:

$$(m_1 g \times d_1) - (m_2 g \times d_2) / m_1 d_1^2 + m_2 d_2^2 = \alpha$$

This formula suggests that the greater the mass of the counterweight, and the smaller the mass of the projectile, the greater the angular velocity that the swing arm will experience.

Having calculated the angular velocity, and knowing the angle that the projectile is rotated through, the angular velocity can be calculated using the following formula:

$$\omega_2^2 = \omega_1^2 + 2\alpha\theta$$

ω_2 = The final angular velocity (rads^{-1})

ω_1 = The initial angular velocity (rads^{-1})

α = The angular acceleration (rads^{-2})

θ = Angular displacement (rads)

The projectile is initially at rest and so the angular velocity is zero, as the projectile is not sweeping through an angle, so there is no angular displacement.

The value of theta we are concerned with is the angle that the projectile sweeps through before being released, assuming the projectile is released when the arm is perpendicular to the floor, this angle can be found by adding the angle made with the floor when the projectile is held at ground level with $\pi/2$ radians.

Figure 14 – The path angle the trebuchet arm turns through before releasing the projectile:

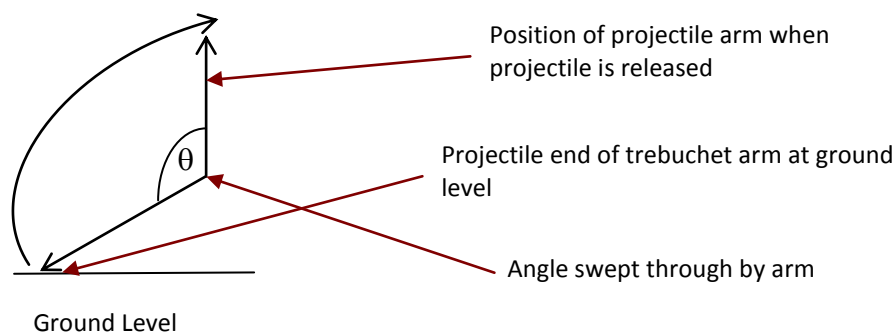

$$\omega_2^2 = 2\alpha\theta$$

$$\text{So } \omega_2 = \sqrt{2\alpha\theta}$$

And we know that the tangential velocity is given by $v=r\omega$, where r is the radius of the circular motion and ω is the angular velocity. Therefore we can calculate the tangential velocity of the projectile as it is released using the distance from the fulcrum to the projectile holder as the radius and ω as the angular velocity calculated using the moment of inertia and torque. This allows us to revert back to the equation:

$$R = \frac{\sqrt{2h} \times u}{g}$$

Where 'u' is the initial horizontal velocity, which will be calculated by $v=r\omega$. Since $v=r\omega$, it follows that the larger the radius of the circular path, and therefore the longer the distance from the projectile to the fulcrum, the greater the tangential velocity the projectile will leave with, so the greater the range of the projectile.

Predicting the launch range of the projectile

Using the information above, we can estimate the range of the trebuchet and see which factors produce the longest launch. If we assume the masses are point masses, with all of their mass concentrated at the centre, with their shape having no influence over their path taken, and assume that the beam is 'massless', then we can predict the initial velocity and hence distance travelled by the projectile.

Looking at the calculation performed using the conversion of gravitational potential energy and kinetic energy, if we have:

Counterweight mass: 1kg

Projectile Mass: 10g

Counterweight – Fulcrum distance: 0.076m

Projectile – Fulcrum distance: 0.412m

Angle made with ground: 0.681 rad

Vertical height of trebuchet arm above ground: 0.670m

Then theoretically the initial velocity of the projectile should be:

$$\tau = (1 \times 9.81 \times 0.076) - (0.01 \times 9.81 \times 0.412) = 0.705 \text{ Nm}$$

$$I = (1 \times 0.076^2) + (0.01 \times 0.412^2) = 7.47 \times 10^{-3} \text{ kgm}^2$$

$$\alpha = \frac{0.705}{7.47 \times 10^{-3}} = 94.38 \text{ rads}^{-2}$$

$$\omega = \sqrt{2 \times 0.681 \times 94.38} = 11.34 \text{ rads}^{-1}$$

$$v = 0.412 \times 11.34 = 4.67 \text{ ms}^{-1}$$

So, the range would be:

$$\text{Horizontal distance} = 4.67 \times \frac{\sqrt{2 \times 0.670}}{9.81} = 1.73 \text{ m}$$

As you can see this value is almost 7 metres different to the value calculated using the exchange between gravitational potential energy and kinetic energy. The interchange of gravitational potential energy to kinetic energy is unlikely to be a 100% efficient process, so in reality the actual initial velocity of the projectile will be slightly smaller than the anticipated value. Since each of these methods produce very different values, I will deduce which is the most accurate from the preliminary experiment and see how efficient each method is at estimating where the tray of sand should be placed.

The factors affecting the range of the trebuchet – Hypothesis Explained

Using this background information, the following variables should produce the largest range of the trebuchet:

- **A large counterweight mass to projectile mass ratio** - the larger the mass of the counterweight, the greater its gravitational potential energy when it is suspended in the air and thus the larger the amount of energy available in being converted to the kinetic energy of the missile. Moreover the heavier the counterweight is in relation to the mass of the projectile the greater the torque about the fulcrum and thus the greater angular velocity and hence the larger the tangential velocity of the projectile. The greater the initial velocity of the projectile, the further it will travel. The initial velocity and hence distance travelled by the projectile is inversely proportional to the projectile mass.

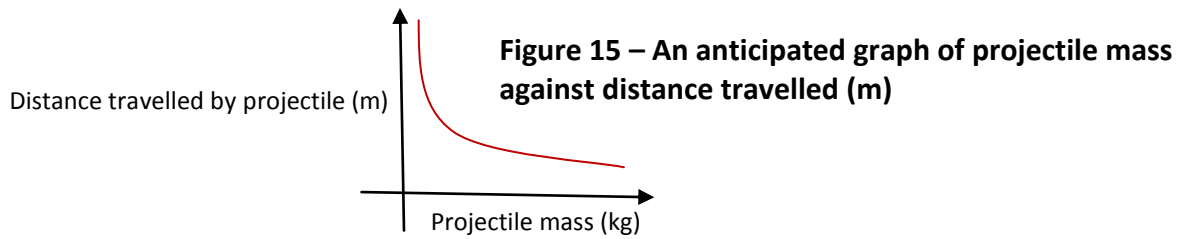

- **A relatively large height through which the counterweight will fall** - the greater the height that the counterweight is held above the ground, the greater its gravitational potential energy, which aforementioned, means an increased amount of energy available as the kinetic energy of the projectile.
- **A large angle between the trebuchet arm and the surface it is resting on** – The larger the angle made with the ground, the larger the value of angular velocity and hence tangential velocity. A large angle with ground also means that the counterweight is suspended higher above the ground.
- **A large distance between the fulcrum and the projectile** - since $v=r\omega$, the larger the radius of the circle the projectile turns through, the greater its tangential velocity, and hence the greater the distance it will travel.
- **The use of aerodynamic projectiles** - the more aerodynamic the projectiles are, the more likely the air rushing past them will flow with laminar flow, rather than turbulent flow. Turbulent flow requires more energy to move against so the distance travelled by the projectile will be reduced if they achieve turbulent flow.

Figure 17 – The difference between laminar and turbulent airflow:

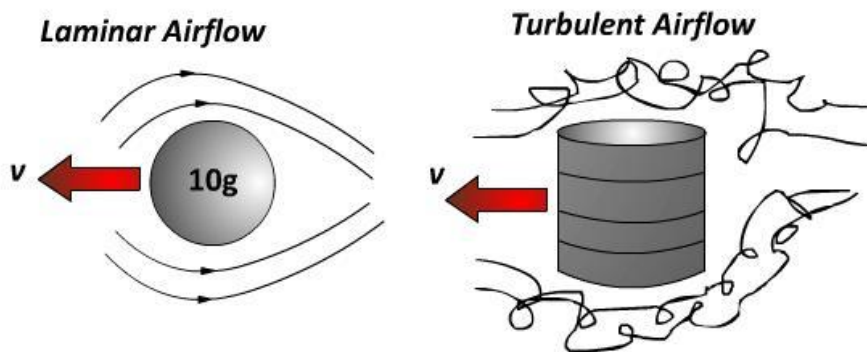

- **Minimum friction about the fulcrum** - the metal bar supporting the swing arm must offer negligible friction ($F=\mu R$). The smoother the bar the easier it will be for the swing arm to rotate about it freely, thus the faster it will move.

Taking into account this information I anticipate that the greatest range of the trebuchet will be achieved by either of the following two settings:

- The distance between the counterweight and fulcrum is 0.076m – this corresponds to a maximum available distance between projectile and fulcrum (and thus maximum radius of the circular motion). It also corresponds to the maximum height of the projectile before release.

However, this setting also corresponds to the minimum available angle made with the ground and also the minimum counterweight height above the ground.

- The distance between the counterweight and fulcrum is 0.128m – this corresponds to the maximum available height that the counterweight can fall through. It also gives the largest angle with the table thus increasing angular velocity. However, it also gives the minimum distance available between the projectile and fulcrum and the smallest height above the ground the projectile is released from.

The experimental results should verify which has most impact – the distance the counterweight falls through or the height above the ground from which the projectile is released. It is hard to strive for both, because as you drill the fulcrum hole nearer to one end, you increase one factor but decrease another affecting the range of the trebuchet. I believe that the 0.128m setting will produce the greatest range, since this gives the counterweight a greater height to fall through and thus more energy is available as the kinetic energy of the missile. The greater the height the counterweight falls through, the lower the maximum height of the point of release – therefore the less energy needed to lift the projectile up against the force of gravity and the more energy available as kinetic energy of the projectile.

Measuring the range of the trajectory

The hardest aspect of this experiment is to accurately measure the point at which the missile lands. One possible method could be to plot a velocity-time graph and calculate the area underneath the curve by counting the squares or using integration. The problem with such a method is that the velocity of the projectile at different points of its flight is not easy to measure directly and would require sophisticated video equipment and perhaps a stroboscope. Such sophisticated equipment is not readily available and so an alternative method will be sought.

As the projectile lands, it will land with some velocity and will not stop dead on impact, but rather bounce off or roll along its path. In order to measure the point of first impact with the ground as opposed to where the projectile finishes moving, the projectile will need to leave a mark on the surface to which it will land. The landing surface will consist of white card, measured out at 10cm intervals. If the projectile was to be covered in ink, then this would leave a mark on the white card, and so the point of first impact could be measured by measuring the distance to the 'blob' of ink left staining the card.

However, to improve accuracy and to reduce uncertainty, I will be taking an average of three readings for each launch of the projectile at a given counterweight mass. Theoretically the projectile should land in the same place each time, however if on one attempt the projectile lands close to a pre-existing ink stain, then this will inevitably lead to confusion as the stains merge and it becomes unclear as to which ink stain represents which projectile launch. Using ink restricts the future use of the card and allowing the projectile to land next to pre-existing landing sites.

To overcome this potential area of anomaly, I will be utilising a tray of sand as the landing site of the projectile. The sand should deform plastically (if the sand is modelled as a lump of material and not tiny grains) as the projectile strikes it and absorb some of its kinetic energy. If the projectile carries on moving after crashing into the sand it will still be clear as to where the missile landed as the crater caused by the projectile landing will be larger/deeper than

any of the other smaller craters. I will then measure the distance to the centre of the crater from the point of release of the projectile to deduce how far the projectile has travelled. Deeper craters should correspond to projectiles that have landed with greater velocity; however the depth of indentation will not be measured in this experiment. After each landing of the projectile, the sand will be smoothed over using the end of a ruler to prevent any previous craters being confused with more current ones. Any large grains of sand or hard rocks present in the sand will be ground down into fine particles, as these lumps/rocks will be harder than the rest of the sand and so resist indentation, making the position of indentation harder to find.

Controlling Variables and Improving Accuracy

During this investigation the following parameters will remain constant:

- The material and dimensions of the bar supporting the swing arm.
- The dimensions of the trebuchet base and the material from which it is made.
- The temperature of the equipment.
- The material that the projectile will land on.
- The total length of the swing arm.

The variables that will be altered during the procedure consist of:

- The mass of the counterweight.
- The mass of the projectile.
- The distance between the fulcrum and the counterweight.
- The distance between the fulcrum and the projectile.

**The latter two correspond to different heights above ground for the counterweight*

While each of these variables is being investigated, all others will remain the same. For example – when measuring the effect of increasing the mass of the projectile; the counterweight mass, distance between the fulcrum and counterweight, and the fulcrum and the projectile will all remain constant.

The specifications for the trebuchet are taken with permission from an internet source (see bibliography) and so the dimensions of the trebuchet are not a variable that needs be measured with unprecedented accuracy. The distances for the drilled holes of the fulcrum were measured both vertically and horizontally using a ruler. Where the two lines crossed the hole was then drilled. The role of the base of the trebuchet is to merely act as support, really having no influence over the motion of the projectile. Despite measuring out the wood accurately with a tape measure, the dimensions of the trebuchet base should have little impact on the projectile's range.

The only possible way in which the base of the trebuchet could influence the motion of the projectile was that if it was too light then it could obtain some of the kinetic energy of the system causing the whole trebuchet to be thrown forward by the swinging counterweight. I anticipate however that this will not happen, and will address this issue in the preliminary experiment if needed. Once the trebuchet has been built, the calculations involving the exchange between kinetic and potential energy, as well as the rotational dynamics involved will require accurate measurements in order to produce viable results.

Obtaining the measurements for predicting the range with formulae

In order to measure the distance between the fulcrum and each end of the swing arm, the trebuchet was disassembled and the trebuchet arm was laid horizontally. A ruler graduated with millimetre marks was then used to measure the distance between the centre of the drilled hole and the two ends of the swing arm. Each length was measured twice for accuracy and each time the ruler was checked to ensure that it was perfectly straight horizontally. Although the spoon was curved, the distance between the projectile and the fulcrum (the drilled hole) was taken as the distance between the drilled hole and the centre of the spoon's dip, seeing as the projectile would not sit right at the end of the spoon but in its curved centre.

It was assumed that the counterweight would hang vertically at the end of the trebuchet arm so the distance between the fulcrum and the counterweight was taken as the full length between the drilled hole and the end of the hook to which the string supporting the counterweight would be attached.

The height of the trebuchet arm when it is perfectly vertical above the ground was measured using a metre stick that was also graduated with millimetre marks. In order to reduce any parallax error the measurements were taken at eye level and repeated twice to check that the same recording was noted each time.

The angle between the trebuchet arm and the ground level was measured with a protractor. This method was also carried out at eye level. Unfortunately because the swing arm is so much larger than the small protractors that the school had available this method lacked accuracy. In order to compensate for this lack of accuracy, the angle was measured again by an alternative method using Pythagoras. By measuring the vertical and horizontal distances accurately with a ruler, the angle, θ , was found by performing the inverse tan function of the vertical length divided by the horizontal length. This produced an angle similar to the visually obtained value and so a mean value was taken from the two results.

The firing of the projectile and measuring its distance accurately**Table displaying all the variables that will be used in the investigation**

*All values of have been rounded to 3 decimal places

| Counterweight masses being investigated (kg) | Projectile masses being investigated (kg) | Distances between the fulcrum and counterweight being investigated (m) | Distances between the fulcrum and projectile being investigated (m) |
|--|---|--|---|
| 0.500 | 0.010 | 0.076 | 0.412 |
| 1.000 | 0.020 | 0.103 | 0.386 |
| | 0.030 | 0.128 | 0.360 |
| | 0.040 | | |
| | 0.050 | | |
| | 0.060 | | |
| | 0.090 | | |
| | 0.100 | | |

The table above displays all of the masses of counterweight and projectile that will be tested as well as the different distances between the fulcrum and either end of the swing arm. This table is a list of all the variables that will be measured; the table does not refer to a counterweight mass of 500g, with a projectile mass of 10g having a distance of 10.2cm between the fulcrum and the counterweight. Each column is independent of the other. The last two columns do not have nice rounded numbers because the specification for the construction of the trebuchet was in inches and not centimetres.

Although using masses of counterweights that increase in intervals of 0.1 kg or 0.25kg would produce more results and lead to more accurate conclusions, I have decided to opt for using just 500g and 1kg. The reason for this is that with three repeats of each launch, and having three different distances between the fulcrum and counterweight, using four or ten different counterweight masses would be time consuming and potentially produce more data than is manageable in the amount of time available. I anticipate that each experiment will take 40 minutes, therefore if I were to use four different counterweight masses, bearing in mind repeating each experiment with different fulcrum distance settings; this would amount to 8 hours.

In reality, a 900g weight would be unavailable and a weight comprising one 500g and four 100g weights tied together would be too bulky and close to the ground for it to really fall very far. It would therefore not obtain much gravitational potential energy and produce short ranges when realistically, a smaller sized weight of 900g would produce a further range than smaller masses with greater heights above the ground.

Unfortunately, the weights available for use as counterweights are not all of the same size, for example, 500g is somewhat smaller than the 1kg weight available. The effect of this is that the height above the ground which the counterweight is suspended will be different for different masses. The 1kg weight is thicker than the 500g weight and so it will appear to be closer to the ground therefore having a reduced value of gravitational potential energy.

Figures 18 & 19 – The difference in size between larger weights:



The height above the ground each counterweight is suspended will be checked with a ruler graduated with millimetre marks observed at eye level. The string will be tied as tightly as possible so that all counterweights are held at their maximum possible height. This value of height will be noted, and theoretical distances will be compared with actual distances to see the percentage error of the predictions.

** The term 'weights' refers to the objects used as masses, not the product of their mass and the acceleration due to gravity. 'g' refers to grams not gravity.*

Likewise, the weights available as projectiles do not share the same shape or thickness. For example, the 0.5 Newton weight is thicker than the individual 10g masses. The metal weights available are small slotted masses similar in appearance to coins. These weights consist of small coins each with mass 10g, and also slightly thicker coins with a mass of 50g. To minimise the size of the projectile and hence reduce the air resistance it will experience, for weights below 50g, the projectiles will consist of 10g masses joined by sellotape, since sellotape will have negligible mass in comparison to blu-tack or the glue from a glue gun. When using masses of 50g, one 50g coin will be used. To obtain a projectile of a mass below 100g, a combination of 10g and a 50g masses will be used. The combination of these different masses allows the masses to be made progressively larger without becoming very tall unstable towers of metal coins.

In order to make sure that each projectile is launched under the same conditions as the next I will exert as little pressure as possible when pulling the projectile down and raising the counterweight. This also applies to releasing the projectile as I do not intend to give it any extra motion, only the motion caused by the falling of the counterweight.

The swing arm will also be placed directly in the centre of the fulcrum so that the projectile follows as straight a path as possible and does not fly off at an angle missing the tray of sand.

The fulcrum within the wooden frame is 16.50cm long. Using blu-tack on the outer edges of the frame where the metal bar threads through will ensure that this length of fulcrum about which the swing arm can slide across stays constant, and each time the swing arm will be positioned at the 8.25cm mark. Each path of the projectile will be assumed to be a straight line.

To keep the procedure as a fair test, the duration for which the projectile is held down to ground level will also be approximately 5 seconds. This measure is to prevent the swing arm experiencing too much stress (force per unit area) and potentially extending or breaking at some point in the experiment. Although the swing arm is stiff, durable and has a relatively large cross-sectional area, any extension or plastic deformation in the swing arm would alter the height above the ground the counterweight is held and also change the distances between the fulcrum and either end of the swing arm. This in turn would alter the initial velocity of the projectile and hence alter its distance travelled. The hook holding the string tied around the counterweight has a small cross-sectional area and so will experience greater stress. If the swing arm, or hook holding the string attached to the counterweight extended then anomalous results could occur as heavier masses could travel further due to the increased height above the ground they are now suspended. When the trebuchet is not in use, the counterweight will be removed to limit any chances of creeping or adding any further unnecessary stress.

The calculations used to predict the range of the trebuchet rely on the assumption that air resistance is negligible. Despite air resistance being unavoidable, the experiment will be performed indoors so that any wind does not interfere with the path of the projectile. Similarly, the room in which this experiment will be performed, will be well ventilated and kept at a constant temperature to prevent any warping of the wood, or expansion and contraction of the metal parts.

Tables will be drawn up prior to the experiment to allow the harvesting of data to be as quick and efficient as possible.

Precision of data collection and sensitivity of equipment

The horizontal distance of the projectile will be measured visually using measured out card and two rulers. The card will be measured at 10cm intervals using metre sticks that possess both centimetre and millimetre marks to improve the sensitivity of the measurements taken. While each piece of card is being measured, great care will be taken to ensure that the metre stick is perfectly horizontal. To certify that the card has been measured out correctly, metre sticks will be held down next to them, to make sure each line goes exactly through its desired point. These pieces of card will then be laid end to end, measuring out a uniform length of 6.30m.

To ensure that each piece of card is laid down perfectly horizontally, the floor will be cleaned and sellotape will be used at each point where two pieces of card meet. This will reduce the chances of two neighbouring pieces of card moving away from each other therefore disturbing the validity of the measurements taken. The edges will be checked to be aligned and then the card will be sellotaped to the floor, restricting any movement that could be induced by the projectile striking it or by the tray of sand being closer to one end of the card and thus causing the other end to lift up. A spirit level will be placed upon each piece of card, ensuring that the bubble remains exactly in the centre of the fluid – thus indicating that the card is perfectly straight. The positioning of the trebuchet will be adjusted so that the arm is perfectly vertical at the 0.00cm mark.

A large source of experimental error is likely to arise from the projectile not following a perfect straight line as it is released. If the trebuchet arm is not placed perfectly straight at the exact centre of the fulcrum, or if the counterweight falls at an angle rather than perfectly vertically, the projectile could be released with some sideways velocity as well as forwards. There is also the possibility that any friction about fulcrum or bending of it will cause the arm to swing around in an unpredictable way. If the drilled hole in which the fulcrum sits becomes worn away then the arm could wobble as it sweeps forwards. To reduce the likelihood of the projectile not following a straight path, a spirit level will be mounted to the fulcrum to ensure that it is perfectly horizontally straight. Aforementioned, the swing arm will be placed at 8.25cm mark (once the length of the fulcrum has been confirmed/adjusted as 16.50m). Friction of the fulcrum is assumed to be negligible for now but will be addressed if it appears to be a problem.

Once the projectile has struck the sand, two rulers will be used – one to give the vertical distance to the first point of indentation, and the second to give the horizontal distance from the nearest mark on the measured out card (see figure 20). The point of indentation is unlikely to be a perfect circle and so the distance from the centre of the crater to the trebuchet's point of release will have to be taken as the most likely centre of indentation. This will obviously lead to experimental uncertainty due to the potential human error of my observations and assumptions. Had a video camera been available, I could have filmed the trajectory and found the point of first impact by looking at the individual frames using computer software. This equipment was not available to me, but had it been, it would need to be able to show the measured out card clearly. To reduce uncertainty, I shall be launching each projectile three times. Repeating each projectile launch three times should show up any inconsistent results.

Figures 20 - Measuring the distance to the crater (Aerial view)

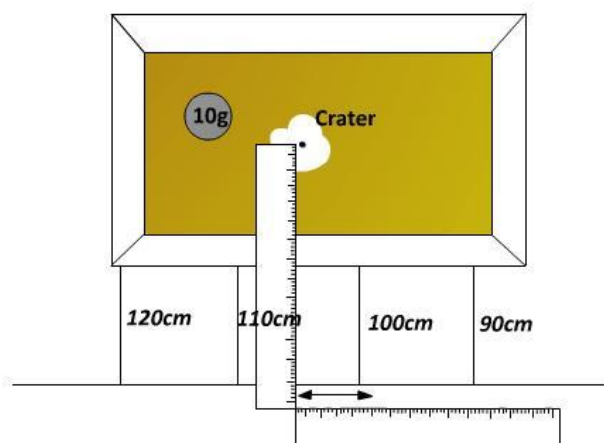
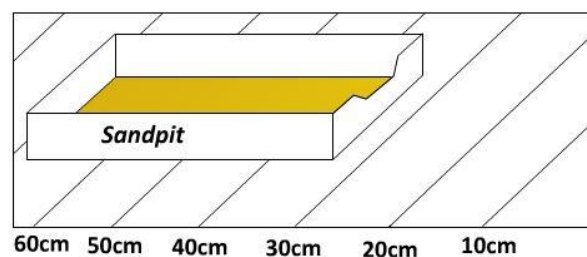

Figure 21 - Side view of the sand pit on the measured out card



In the diagram above, the black dot represents the centre of the crater. I anticipate an inaccuracy of $\pm 1.00\text{cm}$ in measuring the distance to the centre of the crater in the sand from the point of release of the projectile. This may sound quite large, but seeing as a length of 6m is being used, this equates to a percentage error of just 0.17% ($1/600$). However for shorter horizontal displacements of the projectile – i.e. 90cm, this equates to a percentage error of 1.11%, and so has a larger effect on the inaccuracy of the data. If the projectile only travels 20cm, then this amounts to a percentage error of 5%, implying that the results are relatively inaccurate and not concordant.

An unlikely source of error is to be the masses of the projectiles and counterweights. Although the masses of the weights are stated on them, these will be checked with sensitive scales that are capable of detecting masses within one hundredth of a gram. For any masses that produce different readings on the scale to the mass they are labelled with, these masses will be swapped for ones that give their labelled mass on the sensitive scales. The sensitive scales will be first calibrated before use by placing a known mass of material on them and checking that it detects the correct mass. The scales will also be wiped clean before use to ensure there is no additional mass affecting the readings.

Safety Precautions

Although safety measures have already been mentioned, to minimise hazards to myself, those working around me and the room I shall be working in, I shall adopt the following procedures:

- Goggles will be worn by myself and those working in the room to prevent any unexpected trajectories causing eye damage. The use of goggles will also prevent any sand that could be sprayed into the air as the projectile hits the tray from entering other worker's eyes.
- The side of the room I am performing the experiment on will be sealed off from the rest of the room – i.e. I will ensure that all other students are not close enough to be at risk of being hit by any projectiles. If the experiment is carried out on the floor then there will be a high barrier as the unit containing sinks, plug sockets and gas taps will provide a relatively uniform barrier, protecting the other side of the room.

- The projectile will be fired in a direction that does not have any windows or valuables that could be broken if the projectile went too far or in an unexpected direction. All projectiles will be fired in a straight line in a direction that has a blank wall at the end of the room.
- Great care will be taken when loading the sand into the tray as this could result in a 'smoke' of sand rising upwards from the tray, which would not be particularly healthy to breathe in. The sand will be poured into the tray slowly and covered to prevent any from escaping.

Plan of Action

To manage my time more efficiently I have devised the following plan of action to allocate when and where my experiment shall be performed.

| | Date | | | |
|---------------------------------------|--|---|---|---|
| | Thursday 12th March 2009 | Thursday 19th March 2009 | Friday 20th March 2009 | Thursday 26th March 2009 |
| Time | Period 4 | Period 1 | Period 4 | Period 1 |
| Experiment | Preliminary experiment | Counterweight mass: 500g Distance from counterweight to fulcrum: 0.076m Varying projectile masses | Counterweight mass: 500g Distance from counterweight to fulcrum: 0.103m Varying projectile masses | Counterweight mass: 500g Distance from counterweight to fulcrum: 0.128m Varying projectile masses |
| Estimated time taken (minutes) | 45 minutes | 45 minutes | 45 minutes | 45 minutes |
| Location | S7 | S7 | S7 | S7 |

| | Date | | |
|---------------------------------------|--|--|--|
| | Monday 30th March 2009 | Tuesday 31st March 2009 | Wednesday 1st April 2009 |
| Time | Afterschool | Lunch | Afterschool |
| Experiment | Counterweight mass: 1kg Distance from counterweight to fulcrum: 0.076m Varying projectile masses | Counterweight mass: 1kg Distance from counterweight to fulcrum: 0.103m Varying projectile masses | Counterweight mass: 1kg Distance from counterweight to fulcrum: 0.128m Varying projectile masses |
| Estimated time taken (minutes) | 45 minutes | 45 minutes | 45 minutes |
| Location | S7 | S7 | S7 |

*Note: Performing the experiment at lunch time and afterschool will mean that fewer people (if any) will be working near to me, therefore the chances of a stray projectile becoming hazardous to those working around me will be somewhat reduced.

The Preliminary Experiment

Figure 22 – The set up of the preliminary experiment

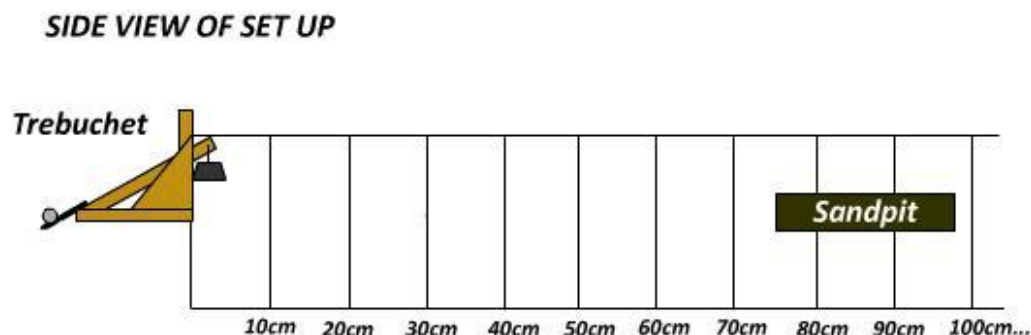

In order to check that the devised experiment worked and produced accurate results, I carried out a pilot experiment. The preliminary experiment provided practice for the final experiment and highlighted any potential sources of error that could be tackled before proceeding with the final experiment.

The apparatus used for the preliminary experiment:

- **The fully assembled trebuchet** - This fired the projectiles their given distance.
- **10g – 100g masses** – These were used as projectiles as they were the lightest masses available.
- **500g mass** – This mass was used as the counterweight mass, the falling of this mass through a height h provided the gravitational potential energy which would be converted to the kinetic energy of the missile.
- **6 pieces of measured out card** – These gave a measured out length of just over 6m when laid end to end and sellotaped down. This card was used to give reference points when the projectile had landed (i.e. instead of measuring 5.25m, a ruler was used at the 5.20m mark and the distance found).
- **Spirit level** – To check that the card was laid perfectly horizontal and to check that the fulcrum was also perfectly horizontal.
- **Sellotape** – Used to hold the pieces of card together and restrict movement.
- **Scissors** – Used to cut the sellotape and to cut lengths of string that would allow the counterweight to be held at its maximum possible height above the ground.
- **String** – This was used to thread through the eye hook and the loop of the 500g mass so that the trebuchet arm could support the counterweight mass.
- **3 Rulers** – One to give a straight vertical distance to the crater and the second to measure the horizontal distance to the crater from the nearest reference point. The third ruler was used to smooth over the sand after each landing of the projectile.
- **Tray** – To store the sand so that it could be collected and transported easily.
- **Sand** – Used to detect where the projectile landed.
- **Floor** – Used as the surface on which all of the equipment was laid.

- **Metre Sticks** – To check that the card was measured accurately. The metre sticks were also used in case the projectile went further than the measured out length of card.

As the diagram shows, the trebuchet was placed at the start of the first piece of card so that the arm was perfectly vertical at the 0.00cm mark. Once the counterweight had been tied to the eye hook at the end of the trebuchet arm, the arm was positioned at the centre of the fulcrum and the arm was held down as the projectile was then placed on the plastic spoon. The finger used to hold down the trebuchet arm to suspend the counterweight in the air was then removed as quickly and gently as possible, to prevent the finger interrupting the motion of the swing arm.

An anticipated value of distance was worked out using the formulae mentioned in the rotational dynamics and conservation of energy part in the background information section of this project. If the projectile did not land in the estimated position, the tray of sand was then adjusted so that the projectile consistently landed in the tray of sand. After each landing of the projectile, the distance to the crater was noted and the sand smoothed over for the next trial. The projectile was wiped clean to remove any sand that had become attached to the projectile, and each projectile mass was launched three times so that an average distance could be taken.

Results of the preliminary experiment

Distance from counterweight to fulcrum: 0.076m

Maximum vertical height of trebuchet arm: 0.670m

Height of counterweight above ground with 500g mass: 0.230m

| Mass of Counterweight (kg) | Mass of Projectile (kg) | Distance travelled by projectile (m) | | | Mean distance travelled (m) |
|----------------------------|-------------------------|--------------------------------------|---------|---------|-----------------------------|
| | | Trial 1 | Trial 2 | Trial 3 | |
| 0.500 | 0.010 | 2.260 | 2.210 | 2.156 | 2.212 |
| 0.500 | 0.020 | 1.615 | 1.675 | 1.673 | 1.654 |
| 0.500 | 0.030 | 1.181 | 1.115 | 1.145 | 1.147 |
| 0.500 | 0.040 | 0.800 | 0.775 | 0.800 | 0.792 |
| 0.500 | 0.050 | 0.620 | 0.618 | 0.616 | 0.618 |
| 0.500 | 0.060 | 0.610 | 0.605 | 0.600 | 0.605 |
| 0.500 | 0.070 | 0.428 | 0.428 | 0.429 | 0.428 |
| 0.500 | 0.080 | 0.275 | 0.270 | 0.273 | 0.273 |
| 0.500 | 0.090 | - | - | - | - |
| 0.500 | 0.100 | - | - | - | - |

**All values are rounded to 3 d.p. The symbol '-' means that the counterweight did not lift the projectile, there was no movement of the trebuchet arm.*

Scatter graph showing the results of the preliminary experiment

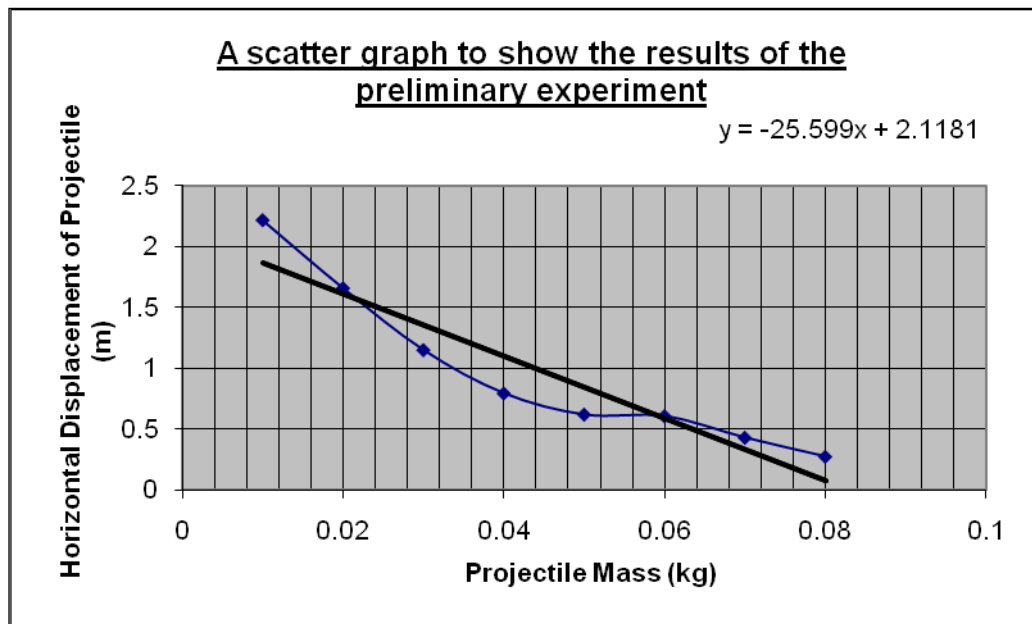

As can be seen from these results, there is a negative gradient suggesting that as projectile mass increases (the independent variable), the displacement of the projectile decreases (the dependent variable). The distance travelled by the projectile is inversely proportional to the mass of the projectile. A line of best fit has been added to show the general trend however the shape of the graph suggests the two variables are not directly negatively proportional and are thus not related by a linear relationship.

The equation of the trend line suggests that the maximum horizontal displacement of the projectile is about 2.12m, however as the results have shown this is not true.

The shape of this graph is very similar to the graph drawn from theoretical values using the conversion of gravitational potential energy to kinetic energy; however the actual values of displacement are very different. Assuming that the transfer of gravitational potential energy of the counterweight to the gravitational potential energy of the projectile and the kinetic energy of the projectile is 100% efficient then this predicts a value of approximately 5.40m for a projectile with a mass of 10g. As the actual results show, on average the projectile travelled 2.212m, giving a difference of 3.188m between the actual value and the theoretical value.

If the percentage error is taken as:

$$\frac{\text{Actual distance} - \text{Theoretical distance}}{\text{Actual distance}} \times 100$$

Then this amounts to a huge percentage error of approximately 144%. If we take the value obtained by the rotational dynamics method then we get a theoretical horizontal displacement of 1.52m. This is incorrect by 0.692m giving a percentage error of 32.64%. This value is much closer but is still far enough out to not provide an accurate place as to where the tray of sand should be placed.

Likewise, there is still a large percentage error between the anticipated values and actual values for increasing projectile masses. This will be looked at further in the evaluation section of this project.

Looking at the individual results in the results table, it appears that for lighter projectile masses there is a greater difference between the distances obtained for each of the three trials. Highlighted in yellow, these results could be perceived as anomalous as the projectile should land in the same place every time. If we consider the 10g mass, this produced distances: 2.260, 2.210, and 2.156. The maximum difference between these distances is just over 10 centimetres. Although 10 centimetres may not appear to be a large difference over a scale of 3 metres, it would make all the difference to those trying to use them during war or for entertainment. If the trebuchet was scaled up to the size of the trebuchets being used in medieval warfare, then a difference of 10cm for a small trebuchet, could result in a difference of metres for the real thing.

These anomalies could have stemmed from the fact that the base of the trebuchet also acquired movement during the firing of the projectile. While observing each launch, it was noticed that the trebuchet base swung forward and rocked after releasing each projectile. This was particularly true when the trebuchet fired light projectiles. The movement of the base meant that the base of the trebuchet was acquiring some of the gravitational potential energy of the counterweight, and thus less energy was available as kinetic energy of the projectiles. This could have also explained the vast difference between the theoretical distances and the actual distances noted.

The base is strong but very light, and as it moves it could be more likely to alter the trajectory of the projectile or weaken the base as it moves against the floor. Another potential cause for the movement of the trebuchet base may have been due to the momentum of the trebuchet. Momentum is always conserved provided no external force acts, and if the projectile leaves with velocity forwards, it therefore follows that the trebuchet base must move backwards in the opposite direction to conserve momentum. Usually the mass of the trebuchet would be much larger than the mass of the projectile, so this backward velocity would be very small, however since the MDF used was light, this could have produced a noticeable movement as the base moves in the opposite direction to the projectile.

To prevent this unwanted movement that could lead to anomalous results and potential breaking of the trebuchet, the trebuchet will be mounted on a table and held in position by two G-clamps. These G-clamps will be tightened to a degree that gives the trebuchet no movement when releasing projectiles, but not too tight as to add stress to the base causing it to deform or reach its ultimate tensile stress. It follows that if the trebuchet is mounted to the table, then the pieces of card used to detect the distance travelled must also be mounted onto tables. If the card was not to be added to the tables and be in line with the trebuchet, then this would give the projectiles an additional height to fall through and make the whole situation slightly more complicated.

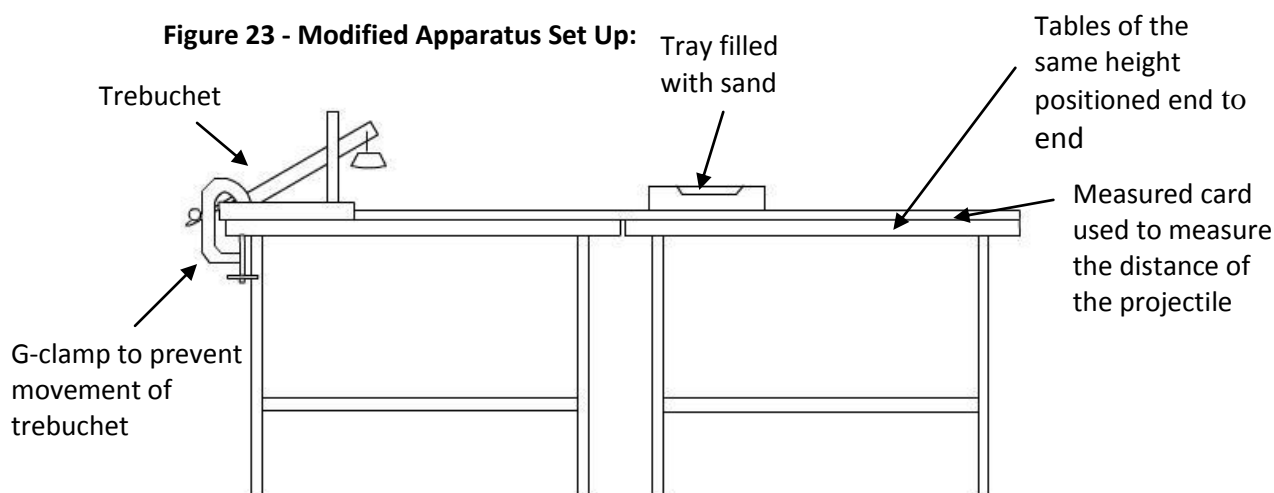

Apparatus

- **Fully assembled Trebuchet** – Used to fire the projectiles into the sandpit. The metal bar supporting the trebuchet arm (the fulcrum) can be removed and be inserted into one of the three holes of the trebuchet arm. This gives three different counterweight heights above ground, as well as three different angles made with the table and three different maximum heights of the trebuchet arm when it is perfectly vertical.
- **Blu-tack** – To keep the fulcrum in position.
- **6 pieces of measured out card each 1.05m in length** – To accurately measure the distance travelled by the projectile without excessive use of metre sticks.
- **Spirit level** – To check that each piece of card is laid down perfectly horizontally and the fulcrum of the trebuchet is also perfectly horizontal.
- **Sellotape** – Used to keep the pieces of card held together, as well as firmly supported on the table and to restrict any potential movement.
- **Sand** – Used to mark where the projectile lands, which is given by the point of indentation.
- **Tray** – An object to store the sand and allow it to be stored and transported easily between experiments.
- **Hammer** – If the sand available doesn't consist of fine particles but rather large solid chunks, then these will be hammered down into fine particles giving the tray of sand a uniform texture and hardness.
- **G-Clamp x 2** – To restrict unwanted movement of the trebuchet base during the firing of projectiles.
- **30cm Rulers x 3** – One ruler will be used to smooth over the sand after each projectile landing distance has been noted to prevent any left craters causing confusion. Another will be used to give the vertical distance to the card, while an additional ruler will be used to measure the horizontal distance from the nearest reference point.
- **0.1 – 1.0 Newton weights** - These give increasing projectile masses in equal 10g intervals.
- **5 & 10 Newton weights** – These provide heavier masses that can be used as counterweights. Each weight has a loop attached that can be used to thread string through and attach the weight to the trebuchet arm.

- **String** – Of no particular length, just in enough quantity that can be cut many times to attach the counterweight to the eyehook of the trebuchet arm.
- **Scissors** – To cut the string to a length that gives the counterweight its maximum possible height above the ground. Scissors will also be used to cut pieces of sellotape.
- **Sensitive Scales measuring 0.00 – 3.00 kg** – To confirm that the selected masses were of the correct mass.
- **Tables x 7** – Used as a surface on which the trebuchet would be mounted. The use of G-clamps requires the trebuchet to be placed near the edge of a table, so the following table layout will be used (this is an aerial view):

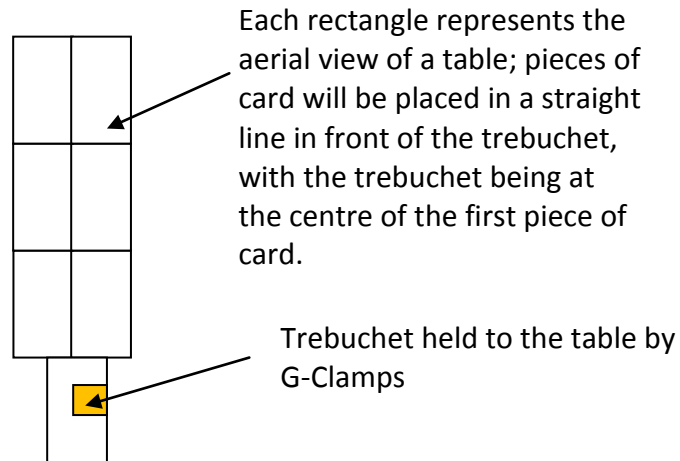
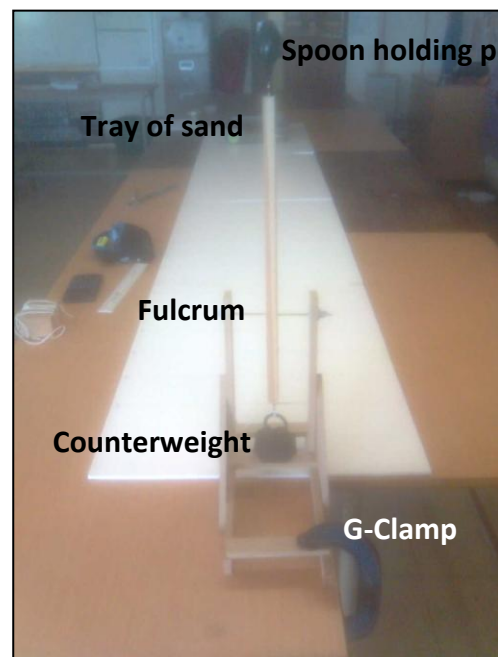
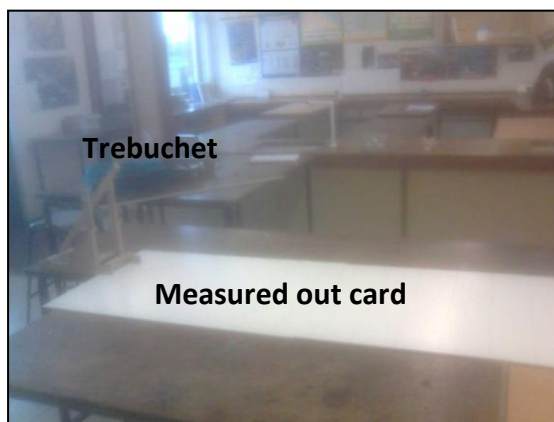

Figure 25 - Photos showing how Apparatus will be set up:



Method

- 1) Having collected all of the necessary equipment, the side of the room I was working on was cleared and sealed off. The tables required were first moved and positioned until the desired layout had been achieved. The moving of these tables was carried out with the help of another student, to reduce the chances of obtaining a back injury or creating any unwanted noise as the table legs were dragged across the floor. Any students working close by were encouraged to wear goggles and keep a distance of about 2 metres from the experiment.
- 2) After sweeping the tables clean of any unwanted material (to prevent the card from being raised in places and not others), the 6 pieces of card were then laid end to end in a straight line spanning a length of just over 6 metres. The pieces of card were pushed together and sellotaped to the tables so that there were no gaps between neighbouring pieces of card. The card was then checked with a spirit level to certify that it had been laid perfectly horizontally, if the bubble of the spirit level did not sit exactly in the central point then the card was adjusted until the bubble of the spirit level sat in the centre of the two markings.

Bubble of spirit level in the centre of the two markings.



Figure 26 – The bubble indicating the surface is level.

- 3) The trebuchet was then assembled. The metal bar used as the fulcrum was threaded through the desired hole in the trebuchet arm and adjusted until it gave a length of 16.50cm between the two vertical strips of wood holding the bar in place. Blu-tack was then wrapped around the ends of the metal bar to hold the bar in place.
- 4) Following the choice of which counterweight-fulcrum distance was going to be used, the trebuchet was then positioned at the start of the first piece of card so that the point at which the arm became perfectly vertical was aligned with the 0.00cm mark. This was checked with a ruler. Once the trebuchet had been positioned correctly, and was in perfect alignment with the table and card, G-clamps were used to hold the trebuchet in place. One G-clamp was used towards the front of the trebuchet and the second towards the back of the trebuchet so that the force exerted on the trebuchet base was relatively spread out and not concentrated in one area. The G-clamps were then tightened until it became difficult to tighten them any further.

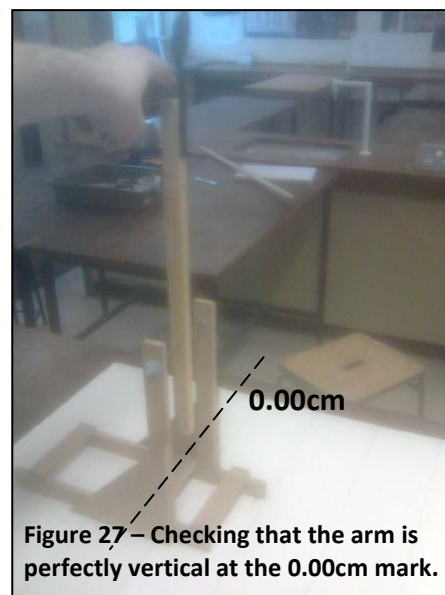

- 5) The sand was then slowly poured into the tray and any large chunks were broken down into fine particles by a hammer. Any large noticeable rocks in the sand were then removed. The sand was then shaken until the tray had a uniform surface of sand with it all being spread equally in the tray. The tray of sand was then placed to one side.

- 6) Projectile masses were then selected depending on which measurement was being noted. For projectile masses that couldn't be formed from a single 0.1 or 0.5 Newton weight, weights were joined together by sellotape 12cm in length. The same length of sellotape was used when joining different projectile mass combinations so that the additional mass and air resistance that the sellotape added was the same for all projectiles.



Figure 28 – Positioning the sand

- 7) Once the projectile mass had been formed, it was then checked on a set of calibrated sensitive scales to check that it was the same as the sum of the masses stated on the weights themselves. If there was discrepancy between the reading on the scales and the labels on the masses, then newer masses were sought (as these would have been less likely to have been broken over time etc). When the sensitive scales detected the correct the mass then this projectile was used.
- 8) Similarly, having selected which counterweight mass would be used; this too was checked on the sensitive scales. If the counterweight labelled mass did not correspond to the sensitive scale reading then the counterweight was replaced until the two readings matched.
- 9) Using the available string, a length approximately 10cm was cut using scissors. This string was thread through the loop of the counterweight and through the eye hook at the end of the trebuchet arm. A double knot was tied to ensure that the counterweight was attached securely and would not come undone at any point of the experiment. To support the weight and prevent adding early stress to the trebuchet, the weight was supported with my hand during the attaching process.
- 10) Knowing that the counterweight was held firmly in place, the arm was released and the counterweight fell towards the floor. The trebuchet arm was then held down, raising the counterweight into the air, and adjusted so that it was positioned exactly in the centre of the fulcrum and not leaning slightly on one side. Before this step was taken, a small spirit level was used to make sure that the fulcrum sat perfectly horizontally. The height of the counterweight above the ground was then noted as this would be used to test the validity of the predicted distance using the interchange between gravitational potential energy and kinetic energy.
- 11) With the trebuchet arm perfectly central and thus most likely to fire the projectile in a perfect straight line, the projectile mass was inserted into the spoon. During this process the trebuchet was still held down using my fingers. The projectile was inserted into the spoon horizontally every time so that each projectile was fired under the same conditions.
- 12) Having checked that the trebuchet arm was perfectly straight and at the centre of the fulcrum, I released my fingers quickly and gently allowing the projectile to be fired towards the measured out card. Watching where the projectile landed, the tray of sand was then positioned lengthways at the area where the projectile had

previously landed. Placing the tray lengthways meant that the greatest horizontal distance could be covered by the tray compared to if it was placed horizontally on the card. Calculations using the background physics of the trebuchet proved to be too inaccurate at determining where the tray of sand should be placed.

13) The previous step was then repeated but with the tray of sand positioned at a likely landing site. Any projectiles that hit the edges of the tray and bounced off, or did not land on the tables were ignored as these distances could not be measured. If the projectile did not land a measurable distance then the launch was repeated until the distance could be measured.

14) When the projectile landed in the tray of sand, the distance from the centre of the crater to the nearest reference point was then measured using two rulers. One to measure the vertical distance from the centre of the crater to the card, and the second to measure the horizontal distance to the nearest millimetre from the vertical ruler to the nearest 10cm reference point mark on the card. For craters that were not perfect circles, the centre of the crater was estimated.

15) After the distance had been noted in tables drawn prior the experiment, the sand was smoothed over with a ruler until it was as flat as possible and the previous crater was no longer visible. Each projectile mass was launched three times into the tray of sand so that an average distance for each projectile mass could be calculated any inconsistencies could be removed. For increasing projectile masses, the distance travelled decreased, and so the tray of sand was moved progressively closer to the trebuchet. After the projectile had landed in the sand, any sand attached to the projectile was wiped clean to prevent adding any unwanted additional mass.

16) Before processing the data in Microsoft Excel or manually, anomalous results were identified and investigated for a potential cause. For example, if the projectile was released too early due to falling off the spoon then the experiment for this projectile mass was repeated. If this problem was persistent then the blu-tack at the end of the spoon designed to prevent this from happening would be made more vertical. If a particular projectile continually flew in an unpredictable manner then the root to this would be investigated and the experiment modified to prevent these anomalies from re-occurring. If any obvious anomalous data arose that had no obvious source or cause, then these were excluded from the calculations of the mean results.

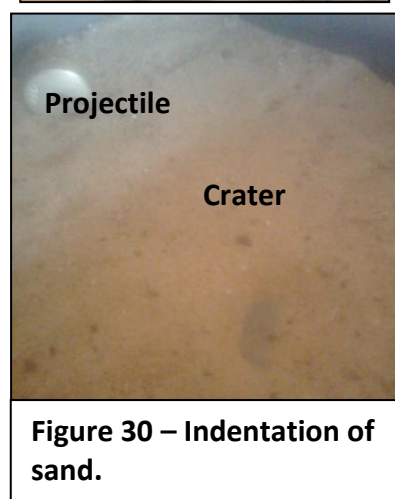
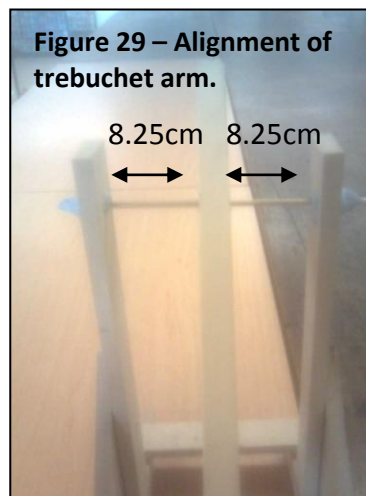

Although there were no major anomalies in the experiment, had there been, the experiment would have been repeated to overcome these or different equipment would have been sought after.

- 17) Finally, as all the data had been harvested, the data was then displayed graphically and analysed to see which factors produced the greatest range of the projectile. The projectile mass was assigned to the x-axis and the distance travelled was assigned to the y-axis. The results were then manipulated to see if the relationship between the projectile mass was governed by a linear relationship or power law. The percentage error of the experiment was also deduced and conclusions were drawn from the data obtained.

Results

Highlighted Yellow = Potential Anomalies – A difference of 10 or more cm with the other distances noted or data that does not fit with the general trend

Experiment 1

Counterweight – Fulcrum distance: 0.076m

Projectile – Fulcrum distance: 0.412m

Maximum vertical height of trebuchet arm above ground: 0.670m

Height of counterweight above ground: 0.230m

| Mass of Counterweight (kg) | Mass of Projectile (kg) | Distance travelled by projectile (m) | | | Mean distance travelled (m) |
|----------------------------|-------------------------|--------------------------------------|---------|---------|-----------------------------|
| | | Trial 1 | Trial 2 | Trial 3 | |
| 0.500 | 0.010 | 2.245 | 2.255 | 2.240 | 2.247 |
| 0.500 | 0.020 | 1.680 | 1.675 | 1.673 | 1.676 |
| 0.500 | 0.030 | 1.181 | 1.176 | 1.188 | 1.182 |
| 0.500 | 0.040 | 0.800 | 0.775 | 0.800 | 0.792 |
| 0.500 | 0.050 | 0.620 | 0.618 | 0.616 | 0.618 |
| 0.500 | 0.060 | 0.610 | 0.607 | 0.600 | 0.606 |
| 0.500 | 0.070 | 0.428 | 0.428 | 0.398 | 0.418 |
| 0.500 | 0.080 | 0.275 | 0.282 | 0.273 | 0.277 |
| 0.500 | 0.090 | - | - | - | - |
| 0.500 | 0.100 | - | - | - | - |

**Note: The G-clamps appear to have reduced the differences between each distance measured in each trial. This can be seen by comparing the distances travelled by 0.010 – 0.030kg projectile masses with the distances travelled by these same masses in the preliminary experiment. For example, the maximum difference between the distances of the 0.010g projectile is now 1.5 centimetres. I was methodological in collecting data, using projectile masses in ascending order. There are no readings for a projectile mass of 0.00kg because this would not be obtainable or travel a given distance. The swing arm would rotate forwards very quickly but would have nothing to throw.*

Experiment 2

Counterweight – Fulcrum distance: 0.103m

Projectile – Fulcrum distance: 0.386m

Maximum vertical height of trebuchet arm above ground: 0.647m

Height of counterweight above ground: 0.245m

| Mass of Counterweight (kg) | Mass of Projectile (kg) | Distance travelled by projectile (m) | | | Mean distance travelled (m) |
|----------------------------|-------------------------|--------------------------------------|---------|---------|-----------------------------|
| | | Trial 1 | Trial 2 | Trial 3 | |
| 0.500 | 0.010 | 2.753 | 2.740 | 2.785 | 2.759 |
| 0.500 | 0.020 | 2.272 | 2.335 | 2.374 | 2.293 |
| 0.500 | 0.030 | 1.946 | 1.895 | 1.884 | 1.908 |
| 0.500 | 0.040 | 1.400 | 1.460 | 1.429 | 1.430 |
| 0.500 | 0.050 | 1.039 | 1.052 | 1.050 | 1.047 |
| 0.500 | 0.060 | 0.810 | 0.800 | 0.789 | 0.800 |
| 0.500 | 0.070 | 0.625 | 0.615 | 0.610 | 0.617 |
| 0.500 | 0.080 | 0.605 | 0.620 | 0.600 | 0.608 |
| 0.500 | 0.090 | 0.590 | 0.585 | 0.587 | 0.587 |
| 0.500 | 0.100 | 0.541 | 0.540 | 0.542 | 0.541 |

Experiment 3

Counterweight – Fulcrum distance: 0.128m

Projectile – Fulcrum distance: 0.360m

Maximum vertical height of trebuchet arm above ground: 0.624m

Height of counterweight above ground: 0.244m

| Mass of Counterweight (kg) | Mass of Projectile (kg) | Distance travelled by projectile (m) | | | Mean distance travelled (m) |
|----------------------------|-------------------------|--------------------------------------|---------|---------|-----------------------------|
| | | Trial 1 | Trial 2 | Trial 3 | |
| 0.500 | 0.010 | 2.737 | 2.780 | 2.716 | 2.744 |
| 0.500 | 0.020 | 2.508 | 2.563 | 2.595 | 2.555 |
| 0.500 | 0.030 | 2.327 | 2.210 | 2.279 | 2.272 |
| 0.500 | 0.040 | 1.900 | 1.881 | 1.876 | 1.886 |
| 0.500 | 0.050 | 1.601 | 1.614 | 1.527 | 1.581 |
| 0.500 | 0.060 | 1.245 | 1.284 | 1.279 | 1.269 |
| 0.500 | 0.070 | 1.013 | 0.984 | 0.990 | 0.966 |
| 0.500 | 0.080 | 0.680 | 0.794 | 0.810 | 0.761 |
| 0.500 | 0.090 | 0.638 | 0.600 | 0.636 | 0.625 |
| 0.500 | 0.100 | 0.485 | 0.491 | 0.505 | 0.494 |

Experiment 4

Counterweight – Fulcrum distance: 0.076m

Projectile – Fulcrum distance: 0.412m

Maximum vertical height of trebuchet arm above ground: 0.670m

Height of counterweight above ground: 0.182m

| Mass of Counterweight (kg) | Mass of Projectile (kg) | Distance travelled by projectile (m) | | | Mean distance travelled (m) |
|----------------------------|-------------------------|--------------------------------------|---------|---------|-----------------------------|
| | | Trial 1 | Trial 2 | Trial 3 | |
| 1.000 | 0.010 | 3.231 | 3.196 | 3.195 | 3.207 |
| 1.000 | 0.020 | 2.892 | 2.980 | 2.971 | 2.948 |
| 1.000 | 0.030 | 2.688 | 2.510 | 2.630 | 2.609 |
| 1.000 | 0.040 | 2.356 | 2.334 | 2.278 | 2.323 |
| 1.000 | 0.050 | 1.988 | 2.086 | 2.000 | 2.025 |
| 1.000 | 0.060 | 1.946 | 1.837 | 1.862 | 1.882 |
| 1.000 | 0.070 | 1.540 | 1.571 | 1.480 | 1.530 |
| 1.000 | 0.080 | 1.335 | 1.312 | 1.321 | 1.323 |
| 1.000 | 0.090 | 1.095 | 1.034 | 1.076 | 1.068 |
| 1.000 | 0.100 | 0.811 | 0.855 | 0.886 | 0.851 |

Experiment 5

Counterweight – Fulcrum distance: 0.103m

Projectile – Fulcrum distance: 0.386m

Maximum vertical height of trebuchet arm above ground: 0.647m

Height of counterweight above ground: 0.196

| Mass of Counterweight (kg) | Mass of Projectile (kg) | Distance travelled by projectile (m) | | | Mean distance travelled (m) |
|----------------------------|-------------------------|--------------------------------------|---------|---------|-----------------------------|
| | | Trial 1 | Trial 2 | Trial 3 | |
| 1.000 | 0.010 | 3.200 | 3.185 | 3.145 | 3.177 |
| 1.000 | 0.020 | 3.055 | 3.001 | 2.964 | 3.007 |
| 1.000 | 0.030 | 2.764 | 2.667 | 2.672 | 2.701 |
| 1.000 | 0.040 | 2.650 | 2.681 | 2.584 | 2.638 |
| 1.000 | 0.050 | 2.439 | 2.472 | 2.480 | 2.464 |
| 1.000 | 0.060 | 2.379 | 2.171 | 2.250 | 2.267 |
| 1.000 | 0.070 | 2.325 | 2.209 | 2.121 | 2.218 |
| 1.000 | 0.080 | 1.875 | 1.891 | 1.894 | 1.887 |
| 1.000 | 0.090 | 1.713 | 1.685 | 1.741 | 1.713 |
| 1.000 | 0.100 | 1.325 | 1.314 | 1.342 | 1.327 |

Experiment 6

Counterweight – Fulcrum distance: 0.128m

Projectile – Fulcrum distance: 0.360m

Maximum vertical height of trebuchet arm above ground: 0.624m

Height of counterweight above ground: 0.240m

| Mass of Counterweight (kg) | Mass of Projectile (kg) | Distance travelled by projectile (m) | | | Mean distance travelled (m) |
|----------------------------|-------------------------|--------------------------------------|---------|---------|-----------------------------|
| | | Trial 1 | Trial 2 | Trial 3 | |
| 1.000 | 0.010 | 4.408 | 4.385 | 4.436 | 4.410 |
| 1.000 | 0.020 | 4.225 | 3.948 | 4.136 | 4.103 |
| 1.000 | 0.030 | 3.257 | 3.219 | 3.304 | 3.260 |
| 1.000 | 0.040 | 2.735 | 2.867 | 2.719 | 2.774 |
| 1.000 | 0.050 | 2.546 | 2.674 | 2.686 | 2.635 |
| 1.000 | 0.060 | 2.470 | 2.410 | 2.509 | 2.463 |
| 1.000 | 0.070 | 2.441 | 2.466 | 2.310 | 2.406 |
| 1.000 | 0.080 | 2.174 | 2.221 | 2.146 | 2.180 |
| 1.000 | 0.090 | 1.997 | 2.016 | 2.009 | 2.007 |
| 1.000 | 0.100 | 1.710 | 1.684 | 1.723 | 1.706 |

*Note: During experiment 6 'creaking' could be heard as the trebuchet arm was pulled down before firing the projectile. This meant that repeating anomalies became increasingly risky as the trebuchet was likely to break at any particular time. It was also noticed that the metal bar being used as the fulcrum had started to bend, so this was removed immediately and replaced with another metal bar of the same material and same dimensions.

For experiments 5 and 6, the 1kg mass struck the base as it fell but it did not for experiment 4. This was because the vertical height of the trebuchet arm as it became perfectly vertical was smaller for these experiments. For experiments 1-4 the counterweight fell the given height but did not hit the floor, and continued to rock backward and forward after releasing the projectile.

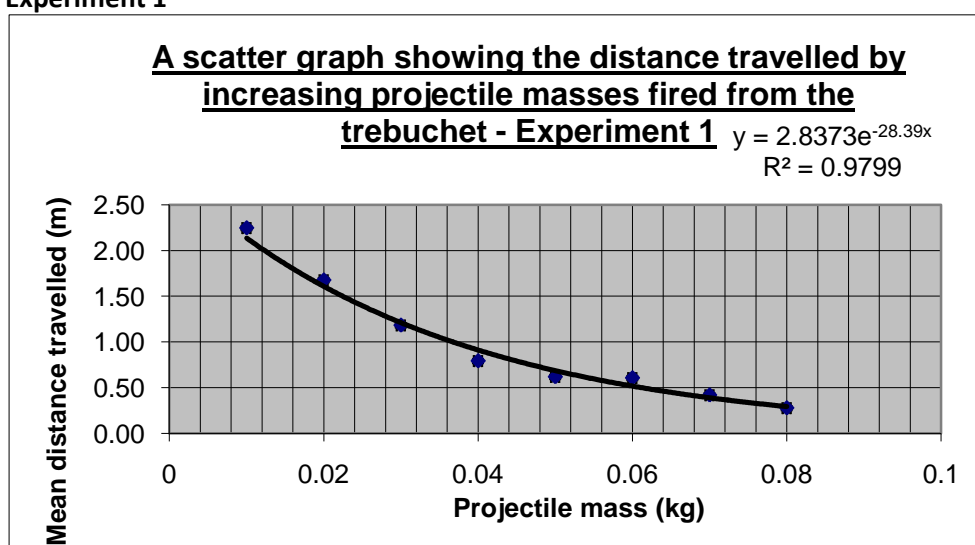
Graphs drawn by Microsoft Excel**Experiment 1**

Experiment 2

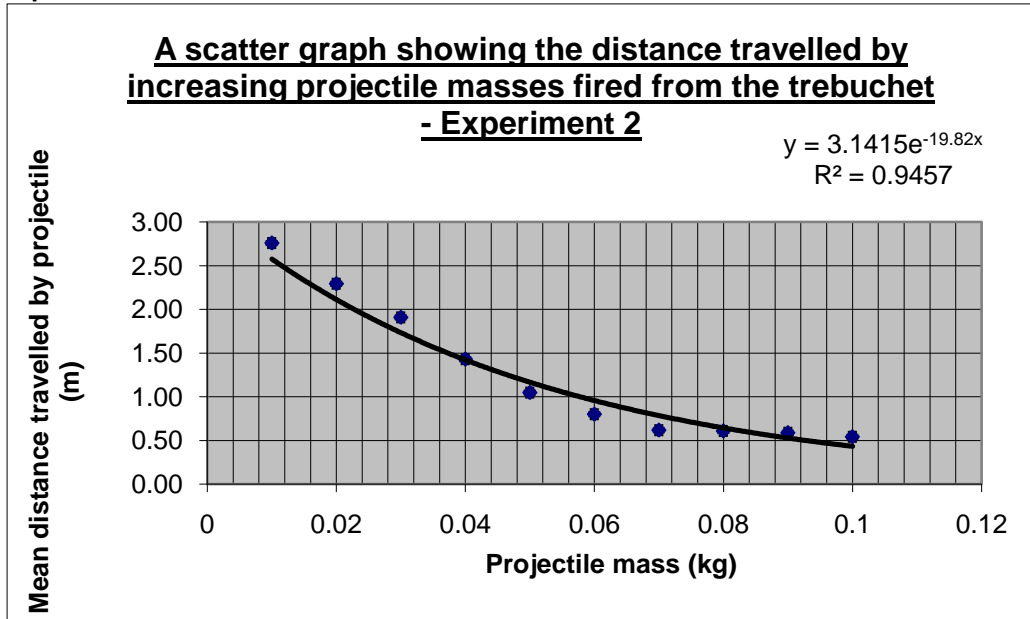

Experiment 3

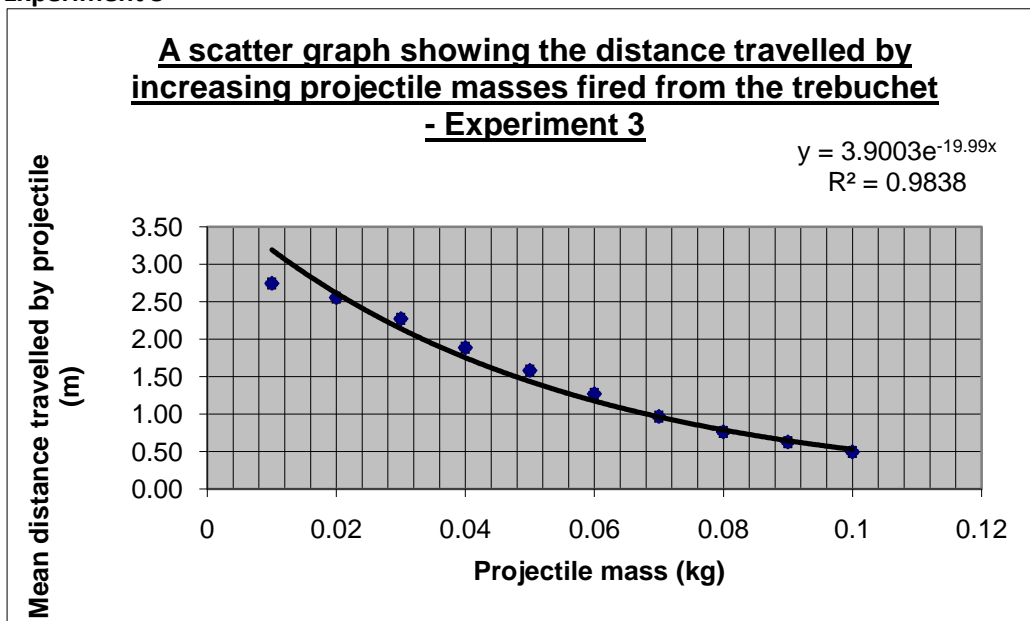

Experiment 4

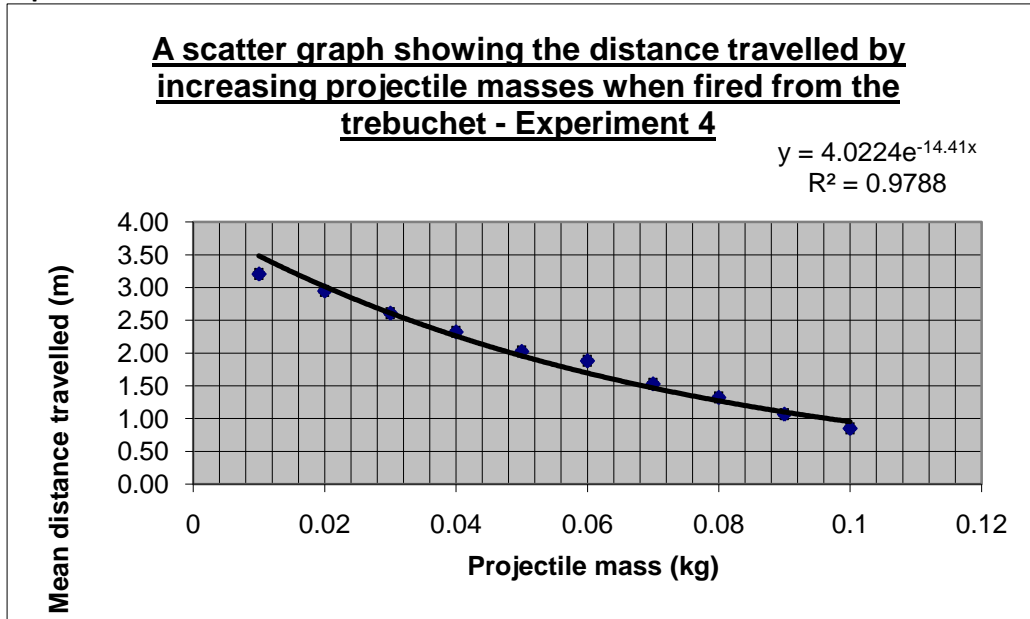

Experiment 5

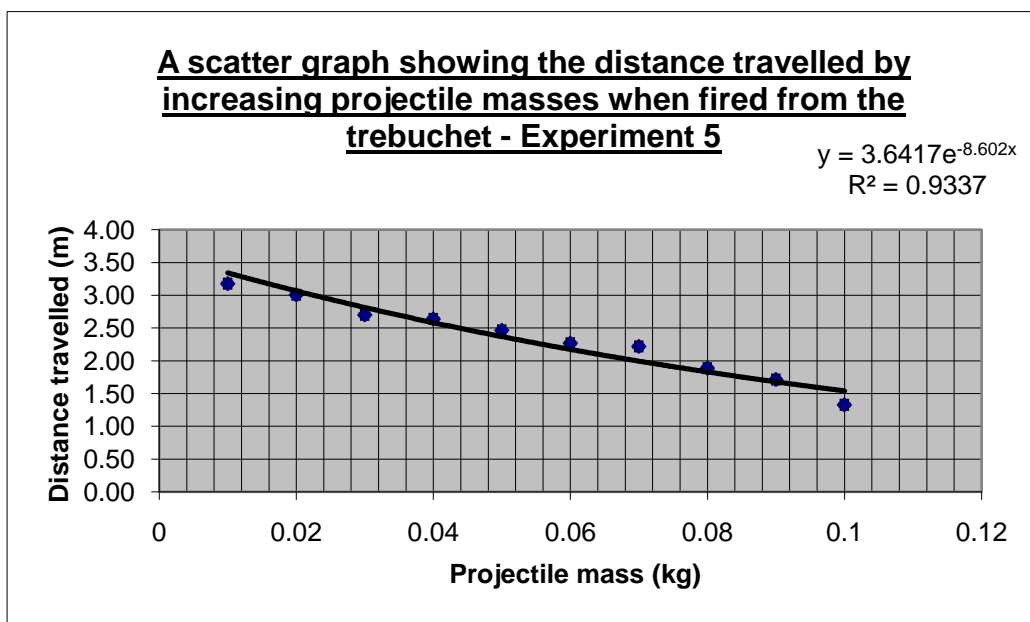

Experiment 6

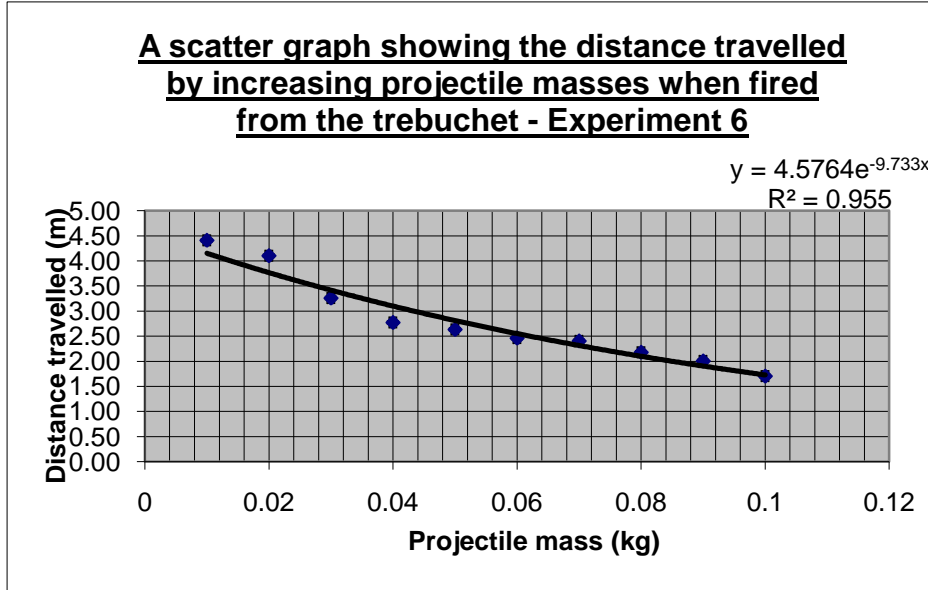

Analysis

A scatter graph showing a direct comparison of the distances achieved by the projectiles in experiments 1 - 6

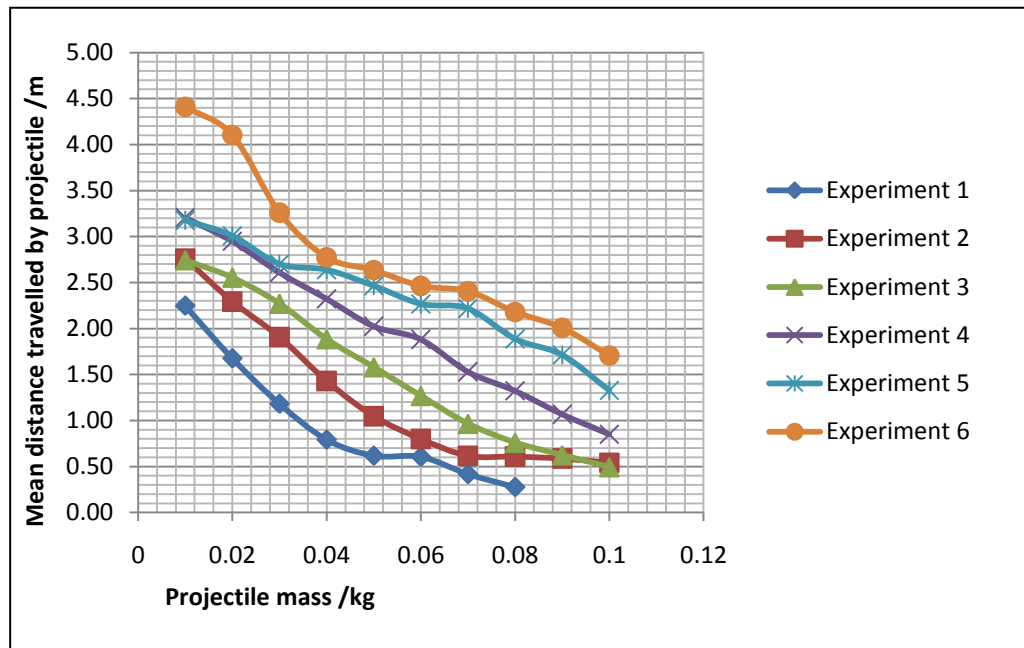

It is clear from the synoptic graph above that the greatest mean distance travelled by the projectiles was achieved in experiment 6. The average distances travelled by the projectiles then decreases for descending experiment numbers, with experiment 1 producing the shortest average distances. Each of the lines of best fit show that there is negative correlation between projectile mass and the maximum distance achieved by the projectile. The graph above also indicates that there is positive correlation between the distance travelled by the projectile and the mass of the counterweight being used. For example in experiment 1 using a counterweight mass of 0.500kg gives an average distance of 2.247m for 10g, while in experiment 4, where all conditions are the same, except for the counterweight having a mass of 1kg, gives an average distance of 3.195m – almost 1 metre further. However, as foreseen in planning, the relationship between projectile mass and distance travelled when fired from the trebuchet is not perfectly described by negative linear correlation.

For experiments 1 and 2 there seems to be a distinct trend between projectile mass and the distance travelled when fired from the trebuchet. For projectile masses of 0.01 – 0.04kg there is a steeper gradient compared with the other plots of data. For these masses, the distance travelled seems to decrease by approximately 45cm as the mass of the projectile increases by 10g. Beyond projectile masses of 40g, the gradient of the graph seems to decrease and almost level out. This can be seen especially for experiment 2 where there is only a change of approximately 1 – 2cm in the distance travelled by the projectile, despite the fact that the projectile mass has still increased by 10g. The fact that this trend is only apparent for experiment 2 could suggest that there was an error in that particular procedure, however no obvious error seems to be identifiable and the fact that each launch was repeated three times should have eradicated any inconsistent results.

Looking at the individual graphs of experiments 1 – 3, it is clear that the relationship between the two variables is not linear.

Drawing a straight line for the line of best fit would be inaccurate as it would not pass through enough points and would suggest that heavier masses had negative displacement (were fired backwards), when in actuality they would be fired a very small distance forwards, if at all.

The shapes of the curves drawn for experiments 1, 2, 3 and 6 are somewhat similar to the anticipated graphs deduced from calculating the initial velocity using the gravitational potential energy calculations. Using the information in the planning section, this states that:

$$v = \frac{\sqrt{2(m_1 g \Delta h - m_2 g \Delta h)}}{m_2}$$

And as $v \propto s$

$$s \propto \frac{\sqrt{2(m_1 g \Delta h - m_2 g \Delta h)}}{m_2}$$

$$\text{So: } s^2 \propto \frac{1}{m_2}$$

s = horizontal displacement of projectile (m)
 $\sqrt{\quad}$ refers to the square root of the whole equation
 m_2 = projectile mass (kg)
 m_1 = Counterweight mass (kg)
 Δh = Change in height (m)

Therefore, if this is true, a graph of distance travelled² against the reciprocal of projectile mass should produce a straight line. Plotting these two variables for experiment 1 produces the following graph:

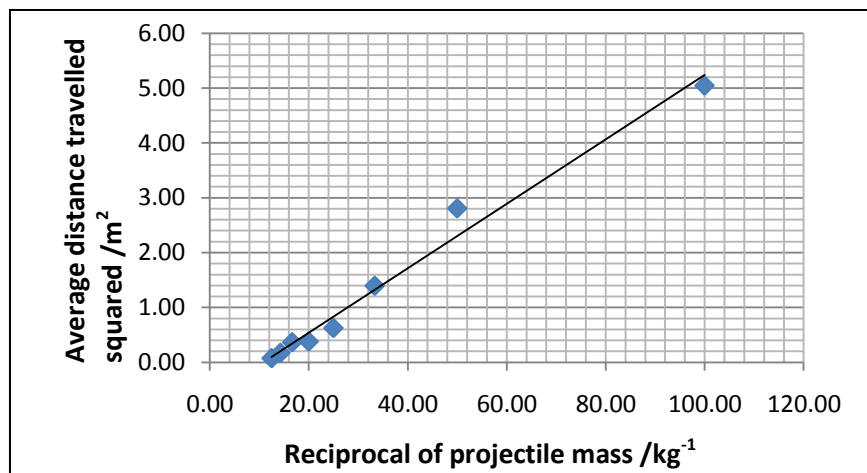

The graph above clearly shows that the reciprocal of the projectile mass is proportional to the square of the average distance travelled. However, as you can see, the two variables are not directly proportional as the line of best fit does not pass through the point (0,0) and a few of the plots of the data deviate from the line of best fit (particularly when the reciprocal of the projectile mass is equal to 50kg⁻¹). It could be argued that a projectile mass of 0.00kg should not travel any distance when fired from the trebuchet as it does not exist, therefore the line of best fit should go through the origin at (0,0). Using the formula for kinetic energy $E = \frac{1}{2}mv^2$, if $m = 0$, then the object would not have any kinetic energy and would thus not move. On the other hand, it could be argued that if an object with no mass did exist, then it would go infinitely far since lighter projectiles are fired further and if $a = F/m$ acceleration would go to infinity.

A scatter graph showing the relationship between the reciprocal of projectile mass and square of the mean distance travelled for experiment 5:

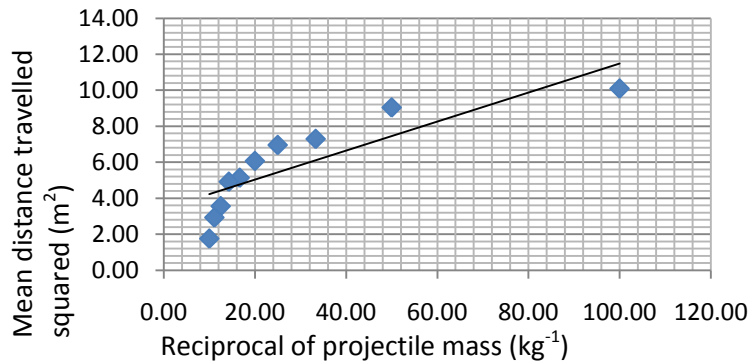

As you can see, the plots of data do not form a straight line which can be used to plot a line of best fit. The graph is somewhat similar to $y = vx$. The fact that not all experiments produce a graph where the square of the mean distance travelled is proportional to the reciprocal of the projectile mass shows there must be a large source error somewhere in the method. These errors will be identified in the evaluation and quantified. If there were no errors in the procedure, then this would suggest that the relationship of: $v = \sqrt{2(m_1g\Delta h - m_2g\Delta h)/m_2}$ is not true, however there is a lot of evidence to suggest that this relationship does apply to the trebuchet.

If we compare the actual distances recorded with the theoretical distances that the background physics predicts using the conservation of energy, then we can see that these values did not accurately predict the distance the projectile would travel. If we compare the actual distances travelled in experiment 3 to the distances the formulae predict we can approximate the efficiency of the formulae (rounded to 2 decimal places).

| Mass of Counterweight (kg) | Mass of Projectile (kg) | Mean distance travelled (m) | Theoretical distance formulae predict (m) | Efficiency (%) [actual value/ theoretical value x 100] |
|----------------------------|-------------------------|-----------------------------|---|--|
| 0.500 | 0.010 | 2.744 | 5.375 | 51.05 |
| 0.500 | 0.020 | 2.555 | 3.697 | 69.11 |
| 0.500 | 0.030 | 2.272 | 2.931 | 77.52 |
| 0.500 | 0.040 | 1.886 | 2.461 | 76.64 |
| 0.500 | 0.050 | 1.581 | 2.129 | 74.26 |
| 0.500 | 0.060 | 1.269 | 1.876 | 67.64 |
| 0.500 | 0.070 | 0.966 | 1.671 | 57.81 |
| 0.500 | 0.080 | 0.761 | 1.500 | 50.73 |
| 0.500 | 0.090 | 0.625 | 1.351 | 46.26 |
| 0.500 | 0.100 | 0.494 | 1.220 | 40.49 |

The calculations are most efficient for projectile with masses 0.020 – 0.060kg

This table shows that on average, the formulae were 61.15% efficient at predicting the distance the projectile would travel. These calculations have been performed on the assumption that the projectile leaves with horizontal velocity only.

As the table indicates, the formulae are most efficient at predicting the range of the projectile for projectiles with masses 0.020 – 0.060kg. The most efficient prediction is found for the projectile with a mass of 0.030kg, giving 77.52% efficiency.

Although this sounds like a high value of efficiency, it is still not efficient enough at accurately predicting where the projectile would land.

If we look at the value where the efficiency is greatest, the formulae predict a distance of 2.931m, whereas the actual distance was 2.272m. This gives a difference of roughly 66 centimetres. 66 centimetres may seem a relatively small distance to be out on a scale of almost 3 metres; however, bearing in mind how small the trebuchet was, this was still not accurate enough to anticipate where the tray of sand should be placed. As previously mentioned, if the trebuchet and its counterweight were to be scaled up in size by a factor of 10 could this give a difference of 6.6 metres between the anticipated distance and the actual distance a given projectile would achieve? If this was the case then the armies using them during battle would always be 6.6 metres too short of hitting their enemy army or target, and would so run the risk of having to get closer.

From projectile masses of 0.06kg onwards, the efficiency of the calculations decreases by about 6% for each increase in projectile mass by 10g. As a result, the least efficient prediction appears to be for the projectile with a mass of 100g, giving an efficiency of just 40.49%. This suggests that for heavier projectile masses, the formulae involving the conservation of energy are less accurate at predicting the distance travelled by the projectiles. The reason for this is most likely to stem from the fact that the heavier projectiles are larger in size and therefore will experience greater air resistance as it is harder for air to flow past their less aerodynamic shape. If the projectiles experience greater air resistance, then their motion forwards will be impeded and hence they will not travel as far as expected.

Although the efficiency of the formulae involving the conservation of energy is likely to vary between experiments, I would anticipate that all distances measured in the experiments are in the region of about 55 – 65% at efficiently being predicted using the conversion of the counterweight's gravitational potential energy into the gravitational potential energy of the projectile and its kinetic energy as it leaves the swing arm. This is because in general, each experiment follows the same trend and appears to be of a similar shape to the graphs anticipated by the formulae. Experiments 4 and 5 however, appear to have a more linear correlation between the projectile mass and distance travelled so the formulae may be less efficient at predicting the range of the projectiles fired in these experiments. Looking at the efficiency of the predictions for experiment 4 however, we get a similar situation:

| Mass of Counterweight (kg) | Mass of Projectile (kg) | Mean distance travelled (m) | Theoretical distance formulae predict (m) | Efficiency (%) [actual value/ theoretical value x 100] |
|----------------------------|-------------------------|-----------------------------|---|---|
| 0.500 | 0.010 | 3.207 | 6.854 | 46.79 |
| 0.500 | 0.020 | 2.948 | 4.753 | 62.02 |
| 0.500 | 0.030 | 2.609 | 3.803 | 68.60 |
| 0.500 | 0.040 | 2.323 | 3.225 | 72.03 |
| 0.500 | 0.050 | 2.025 | 2.821 | 71.78 |
| 0.500 | 0.060 | 1.882 | 2.517 | 74.77 |
| 0.500 | 0.070 | 1.530 | 2.274 | 67.28 |
| 0.500 | 0.080 | 1.323 | 2.074 | 63.79 |
| 0.500 | 0.090 | 1.068 | 1.904 | 56.09 |
| 0.500 | 0.100 | 0.851 | 1.756 | 48.46 |

As you can see, although the shapes of the graphs in experiments 3 and 4 are somewhat different, on average the formulae predict the displacement of the projectiles with an efficiency of approximately 63.16%. This average efficiency is greater than the average efficiency of experiment 3 by just 2.01%, so it is a fair assumption that the efficiency of the predictions is somewhere between 55 – 65% for all experiments. I would perform the calculations for each experiment however that would require a lot of time and paper and using experiments 3 and 4 gives an example of the kinds of efficiency involved with the calculations. As can be seen with both experiments, the most efficient predictions are for projectile masses in the range of 0.03 – 0.07kg.

Similarly, an alternative method of anticipating the distance travelled by the projectile when fired from the trebuchet would be to consider the torque produced by the counterweight causing the angular acceleration of the trebuchet arm. Again, comparing the actual distances travelled by projectiles in experiment 3 to the theoretical distances the formulae using the rotational dynamics of the trebuchet predict (see pages 16 -20) we get the following table:

| Mass of Counterweight (kg) | Mass of Projectile (kg) | Mean distance travelled (m) | Theoretical distance formulae predict (m) | Efficiency (%) |
|----------------------------|-------------------------|-----------------------------|---|----------------|
| 0.500 | 0.010 | 2.744 | 1.184 | 43.15 |
| 0.500 | 0.020 | 2.555 | 1.077 | 42.15 |
| 0.500 | 0.030 | 2.272 | 0.985 | 43.35 |
| 0.500 | 0.040 | 1.886 | 0.904 | 47.93 |
| 0.500 | 0.050 | 1.581 | 0.831 | 52.56 |
| 0.500 | 0.060 | 1.269 | 0.765 | 60.28 |
| 0.500 | 0.070 | 0.966 | 0.704 | 72.88 |
| 0.500 | 0.080 | 0.761 | 0.646 | 84.89 |
| 0.500 | 0.090 | 0.625 | 0.592 | 94.72 |
| 0.500 | 0.100 | 0.494 | 0.540 | 91.48 |

Efficiency increases as projectile mass increases and distance travelled decreases.

The efficiency of the calculations involving the rotational dynamics of the trebuchet appears on average to be very similar in efficiency to the calculations involving the conservation of energy, giving an average efficiency of 63.34%. However in relation as to where the predictions are most efficient is almost the reverse of the calculations involving the conservation of energy. Generally the efficiency of the calculations increases as the mass of the projectile increases excluding the projectile mass with mass 0.1kg. The most efficient prediction occurs when the projectile mass is 0.090kg, giving an efficiency of 94.72%. The formulae anticipate a distance of 0.592m, which is just 3.3 centimetres short of the actual distance. It can therefore be said that this method is far more accurate when determining the distance travelled for larger projectile masses, compared with the calculations requiring the exchange of potential and kinetic energies.

However, this method is less accurate at determining the distances that lighter projectiles would travel, as for projectile masses 0.01 – 0.05kg the efficiency of the calculations ranges from 43.15 – 52.56%. This suggests that this method predicts half the actual distance for lighter projectiles, implying that the use of such formulae is very inaccurate. The efficiency of the same projectile masses for calculations involving the conservation of energy gives efficiency of approximately 51.05- 74.26%, suggesting that this method is more reliable.

A comparison of the actual distances recorded in experiment 3 and the anticipated distances recorded using the background physics

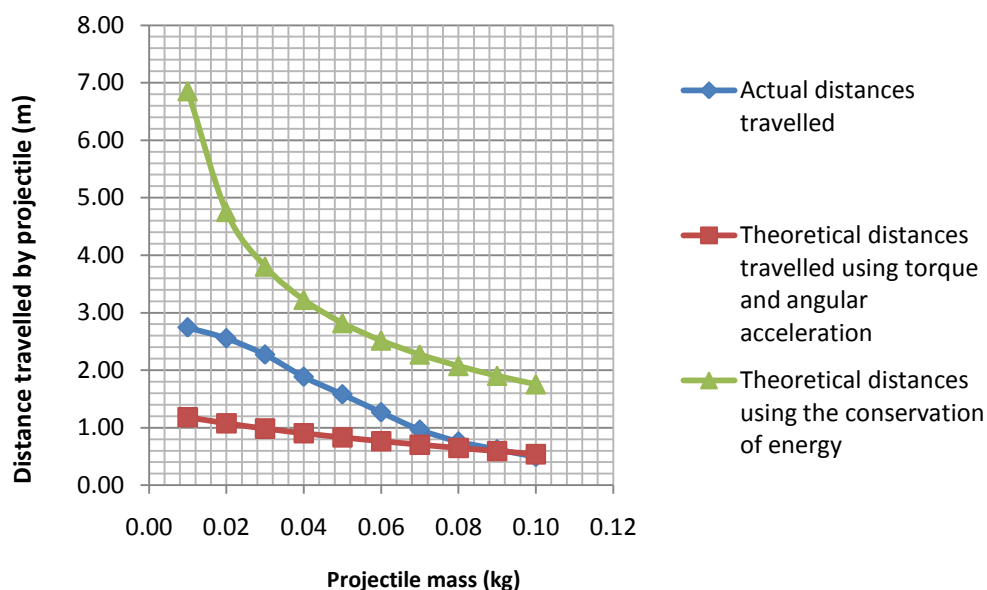

Plotting a graph of the theoretical distances each method predicts alongside the actual distances travelled in experiment 3 shows that using the torque produced by the counterweight appears to be a more reliable method. The graph plotted using the rotational dynamics of the trebuchet is closer to the curve of the actual results, particularly for masses 0.08kg onwards. However, there is still a relatively large gap for masses 0.01-0.04kg which implies the method lacks accuracy for lighter projectile masses.

The graph plotted using the conservation of energy is generally further from the actual results, showing that this method is less efficient at predicting the range of the trebuchet. This is particularly the case for the projectile mass of 0.01kg. Nevertheless, the shape of this curve from 0.03kg onwards is more reflective of the shape of the curve produced by the actual results compared to the almost straight line graph produced using the rotational dynamics method. The fact that the shapes of the graph for the actual results and the graph using the conservation of energy are so similar, suggests that the relationship between projectile mass is governed by the previously mentioned equation, however the transfer of energy is not 100% efficient and so the initial velocity of the projectiles and hence the distances travelled in reality are considerably lower.

In summary, assuming the efficiency of the calculations applies for all experiments, it can be said that for lighter projectile masses, using the conservation of energy provides a more accurate estimate of the distance travelled, but for heavier projectile masses, using the torque and angular acceleration gives a more accurate estimate of the distance the projectile will travel. However, neither method gives a consistent accurate prediction and is therefore unreliable in trying to predict how far the projectile will go.

The reasons for the calculations being so far off at predicting the distance travelled by the projectile can be linked to several factors.

One such limitation of these calculations stems from the fact that in reality, the beam used as the trebuchet arm is not 'massless' and does possess mass which will effect its moment of inertia and potentially obtain some kinetic energy of its own as the counterweight falls.

If the beam has mass, work must be done to lift it, as well as the projectile it holds, up against the force of gravity, meaning that the amount of gravitational potential energy available from the counterweight to the projectile is reduced and not quite explained by the formulae previously mentioned in this analysis. The mass of the trebuchet arm was in fact: $6.205 \times 10^{-2} \text{kg}$, therefore taking into consideration the mass of the trebuchet arm into the conservation of energy calculations and assuming the trebuchet arm is lifted the same height above the ground as the height when the arm is perfectly vertical, looking at experiment 4 with a projectile mass of 20g, this predicts:

$$m_1 g \Delta h = m_2 g \Delta h + \frac{1}{2} m_2 v^2 + m_3 g \Delta h$$

$$v^2 = \frac{2(m_1 g \Delta h - m_2 g \Delta h - m_3 g \Delta h)}{m_2}$$

$$m_1 = 1 \text{kg}$$

$$m_2 = 0.02 \text{kg}$$

$$m_3 = 6.205 \times 10^{-2} \text{kg}$$

Maximum vertical height of arm above ground: 0.670m

Height of counterweight above ground: 0.182m

$$v^2 = \frac{2(1.79 - 0.13 - 0.41)}{0.02}$$

$$v^2 = 125 \text{m}^2 \text{s}^{-2}$$

$$v = 11.18 \text{ms}^{-1}$$

$$\text{Displacement} = \frac{u\sqrt{2h}}{g} = 11.18 \times \frac{\sqrt{(2 \times 0.67)}}{9.81} = 4.13 \text{m}$$

If we then refer to the table of results for experiment 4, we can see that in actuality, the projectile of mass 20g travelled 2.948m. Although this value of distance is closer to the real distance compared to the value found that ignored the mass of the trebuchet arm, it is still inaccurate by just over a metre, which is a large inaccuracy considering that the maximum distance travelled in experiment 4 was 3.07m.

Additionally, another factor that limits the use of these formulae is the fact these formulae are designed to work in 'perfect' conditions – i.e. where there is no air resistance acting on the projectile or friction resisting the movement of the trebuchet arm around the fulcrum. The formulae involving the conservation of energy apply to situations in which energy transfer is 100% efficient and where the counterweight falls perfectly vertically. If we take a random piece of data, we can try and calculate the efficiency of the trebuchet. Looking at experiment 5, for a mass of 0.07kg, the mean distance travelled was measured as 2.218m. Assuming that the projectile left with horizontal velocity only, we can work backwards to find its initial velocity using:

$$s = \frac{u\sqrt{2h}}{g}$$

$$2.218 = \frac{u\sqrt{2 \times 0.647}}{9.81}$$

$$4.920 = u^2 (0.132)$$

$$u^2 = 37.30$$

$$u = 6.107 \text{ms}^{-1}$$

If the efficiency of the trebuchet is equal to:

$$\text{Efficiency} = \frac{E_{\text{projectile}}}{E_{\text{counterweight}}} \times 100$$

m_1 = Counterweight mass (kg)
 m_2 = Projectile mass (kg)
 m_3 = Trebuchet arm mass (kg)
 s = Displacement of projectile (m)
 u = Initial horizontal velocity (ms^{-1})

Mass of projectile: 0.07kg

$$E_k = \frac{1}{2} 0.07 \times 6.107^2 = 1.305\text{J}$$

Mass of counterweight: 1kg

$$E_g = 1.00 \times 9.81 \times 0.196 = 1.923\text{ J}$$

$$\text{Efficiency} = \frac{1.305\text{J}}{1.923\text{ J}} \times 100 = 67.86\%$$

This implies that roughly 32% of the gravitational potential energy of the counterweight is not being transferred to the projectile and is potentially being dissipated as heat energy due to air resistance or friction. This is likely to be the reason as to why the anticipated distances were consistently higher than the actual distances.

The rotational dynamics formulae have been used on the assumption that the trebuchet is a parallel beam, made up of point masses being supported at perfect right angles to the trebuchet arm and the formula $I = \sum mr^2$ applies to the trebuchet situation. In reality, the trebuchet arm starts at an angle to the ground and the counterweight and projectile are not supported at perfect right angles to the trebuchet arm. Therefore these angles will have some influence over how far the projectile flies. My knowledge on how to apply the moment of inertia is also relatively limited, so it is possible that there is a more specific equation that applies to the trebuchet.

Looking at the results for experiments 4 and 5, we can see that the trend is more linear in comparison to the other experiments. Although the reasoning behind this is not entirely known, it is possible that as the trebuchet became increasingly used, the holes used to thread the metal bar through the trebuchet arm became worn away at the edges and became less smooth and circular. This in turn would have meant that there could have been increased friction acting on the trebuchet arm and the arm would be less likely to follow a smooth circular arc as the counterweight fell to the floor. Using the hand drawn graphs for experiments 4 and 5, I have deduced an equation of the line of best fit, which allows me to predict the distances travelled by projectile masses that were not tested in these experiments. Looking at experiment 4, the equation of the line predicts that a projectile of mass 5g will travel 3.604m. However, each experiment should have produced the same shaped graph, so therefore all graphs should be able to be described by a single equation, because a straight line, line of best fit is not suitable for all experiments.

After consulting the table of results in experiment 1, we can see that the projectiles with mass 90g and 100g were not lifted. Using the calculations involving the conservation of energy, this anticipates the projectile will travel a distance of 1.28m. The fact that the projectiles did not move indicates the error of these calculations. Using the formula for torque however shows that there was only a resultant torque of 0.0316Nm. The fact that this torque is so small could explain why there was no observed movement.

The general trend for each experiment is that the distance travelled by the projectile decreases rapidly at first for increasing projectile masses and then more slowly. The relationship is not described by a power law because a graph of $\log(\text{distance})$ vs $\log(\text{projectile mass})$ does not produce a straight line.

If we divide the mean distance travelled by a projectile of mass $m + 10m$, by the mean distance travelled by a projectile of mass m , we can see that the changing fraction for each distance is very close for each changing quantity of projectile mass. Therefore, similar to the discharge of a capacitor or decay of a radioactive isotope, the line of best fit can be better described by an exponential decay equation. If we plot a graph of $\ln(\text{distance})$ against projectile mass then we should get a straight line and the gradient should be equal to the decay constant k . This is true because:

$$\text{If } y = Ae^{-kx}$$

$$\text{Then } \ln(y) = \ln(A) - kx$$

$$\text{So if distance travelled by projectile} = Ae^{-k \times \text{projectile mass}}$$

If we consider the equation of a line as $y = mx + c$ then the gradient gives k and $\ln(A)$ is equal to the y intercept.

Drawing up a table of $\ln(\text{distance})$ against projectile mass for experiment 1 gives:

| $\ln(\text{distance travelled by projectile})$ | Projectile mass (kg) |
|--|-----------------------------|
| 0.81 | 0.01 |
| 0.52 | 0.02 |
| 0.17 | 0.03 |
| -0.24 | 0.04 |
| -0.48 | 0.05 |
| -0.49 | 0.06 |
| -0.87 | 0.07 |
| -1.27 | 0.08 |

Looking at the hand drawn graph, we can see that a graph of $\ln(\text{distance})$ against projectile mass does produce a relatively straight line (although not a perfect straight line) which suggests the relationship between projectile mass and distance travelled by the projectile could be better explained by an exponential decay equation rather than a straight line, line of best fit. If the gradient is equal to the decay constant and the y-intercept gives the value of $\ln(A)$, then the equation of the line is: distance travelled = $3.00e^{-29.58\text{projectile mass}}$. This derived equation is similar to the equation given by Excel, suggesting that this method is relatively accurate.

Adding error bars to the graph for experiment 1 when the line of best fit is a straight line shows that the line of best fit still does not travel through enough points, however because of the large scale of distances travelled these error bars are very small and very difficult to see:

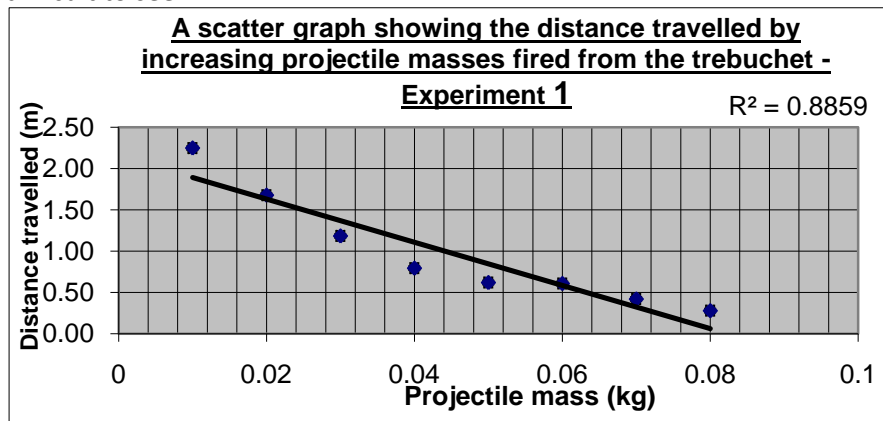

As this graph demonstrates, even with the use of error bars, the relationship between the two variables is not best described by the use of a straight line graph. I have added the regression parameter using Excel, which gives a measure of the reliability of the linear relationship between the x and y values. The closer the value of R^2 is to 1.00, the stronger the reliability of the linear relationship. As we can see the value of R^2 (the square of the product moment correlation coefficient) gives a value of 0.8859, which is relatively close to 1. However, if we describe the same graph with an exponential decay equation we produce the following graph:

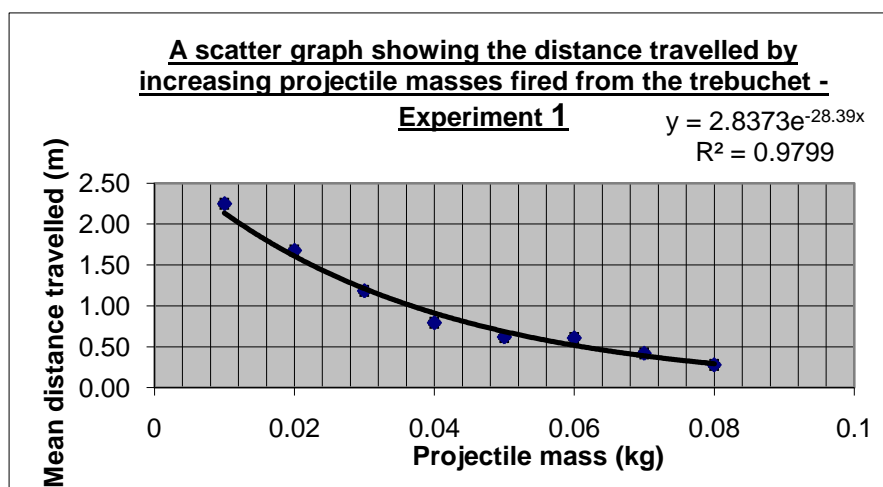

The graph above clearly shows that with the addition error bars and an exponential curve, the curve goes through more points and gives a value of R^2 much closer to 1.00.

Looking at each graph and the value given for the regression parameter it can be seen that these values range from 0.9337 – 0.9838 which indicates a strong correlation with the curve drawn. This is particularly true for experiment 3 where the value of regression is given as 0.9838. It can therefore be said with some certainty that the relationship between projectile mass and distance travelled is better described by an exponential decay equation, and this has been found to be true for all experiments, which is why in the results section, an exponential equation has been given as the equation of the line for all experiments rather than a straight line.

Other than the relationship between projectile mass and distance travelled, there is also a clear relationship between counterweight mass and distance travelled, as well as distance between fulcrum and counterweight and distance travelled. The further the counterweight is from the fulcrum, the shorter the distance between the projectile and the fulcrum, which therefore means a reduced radius of the circular arc the projectile turns through, so this should in theory mean a reduced value of tangential velocity since $v = r\omega$. However, counteracting this, the larger the distance between the counterweight and the fulcrum, the higher the counterweight is suspended above the ground and the larger the angle between the ground and the trebuchet arm. As a result of this the counterweight has more gravitational potential energy, and thus more energy available as the kinetic energy of the projectile. The larger the value of the angle made with the surface, the larger the value of its angular velocity.

Unfortunately, due to time restraints, only two counterweight masses were tested, so plotting a graph of counterweight mass against distance travelled by a projectile of constant mass would be inaccurate as it would only consist of two points.

However, if we look at a graph of distance between counterweight and fulcrum against the distance travelled by a projectile of a particular mass we can see that the further the counterweight is from the fulcrum, and thus the higher it is suspended above the ground, the further the projectile will be thrown. Looking at experiments 1, 2 and 3 for a projectile mass of 50g and a counterweight mass of 0.500kg we get the following graph:

A scatter graph showing the relationship between counterweight – fulcrum distance and the distance travelled by a projectile with 50g in experiments 1-3 where the counterweight mass is 500g

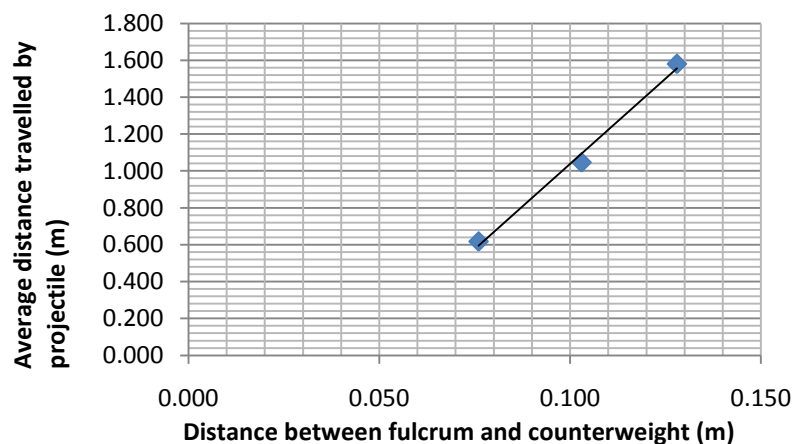

Although there are only three plots of data, it is still clear that as the distance between the counterweight and fulcrum increases, so too does the average distance travelled by the projectile. The synoptic graph also verifies this claim, because for experiments 1 – 3 and 4 – 6, we can see an increase in average distance travelled for ascending experiment numbers – because the distance between the counterweight and fulcrum has been increased for each experiment while counterweight mass has remained constant.

If I were to be given the opportunity to repeat this experiment, then I would utilise more distances between the fulcrum and counterweight to see if there was a point at which the radius of the circular arc was reduced enough to start reducing the effect of the increased counterweight height above the ground. The formula for torque suggests that the greater the distance between the counterweight and fulcrum, the greater the torque (turning force) produced, and therefore the greater the angular acceleration and hence initial tangential velocity of the projectile. However the radius of the circular arc, and the maximum height above the ground at which the projectile leaves the arm of the trebuchet also affects the distance travelled. The higher the projectile is above ground when it leaves the trebuchet, the greater the distance it will travel, however, having the counterweight closer to the fulcrum reduces the maximum vertical height of the trebuchet arm. Perhaps there is an optimum distance between counterweight and fulcrum which could be investigated further, but in this experiment a distance of 0.128m was found to be best distance to produce the greatest range of the projectile.

Conclusion

Having analysed the results it is clear that the following properties give the trebuchet its maximum range:

- **The use of light projectiles** – In all experiments it was found that the 10g projectile consistently travelled furthest, implying the maximum ratio of counterweight mass to projectile mass was 1:100. The average distance travelled in each experiment then reduces gradually as the projectile mass increases, and the distance travelled usually decreases by a smaller amount after a projectile mass of 0.07kg.

The reason that lighter projectiles travel further is because less work needs to be done to lift them up against the force of gravity, $E_g = mg\Delta h$, therefore if mass is reduced, then less of the gravitational potential energy of the counterweight needs to be converted to the gravitational potential energy of the projectile as it is lifted up above the ground, so more energy is available as the kinetic energy of the projectile.

Additionally, the smaller the projectile, the smaller the torque created in the opposite direction to the torque created by the mass of the counterweight, therefore there is a smaller resistance to the turning force of the counterweight so the trebuchet arm can undergo greater angular acceleration. Similarly, the smaller the mass of the projectile, the smaller the moment of inertia and as angular acceleration is inversely proportional to the moment of inertia, using a lighter projectile mass gives a greater angular acceleration. The angular velocity is proportional to the square root of the product of the angular velocity and the angle turned through multiplied by two, so a greater angular acceleration means a greater angular velocity and hence tangential velocity.

Although air resistance was assumed to be negligible, the larger projectile masses were more 'bulky' as they consisted of slotted masses sellotaped together. The larger the stack of coins, the less aerodynamic they became, and hence the more likely it is their motion was impeded by air resistance. Smaller masses were more aerodynamic as figure 11 displays, and were thus less impeded by air resistance as they achieved laminar flow (no abrupt change in speed or direction of the air rushing past them and only mixing between layers on a molecular level) of air past them. Given the opportunity to repeat this experiment, masses of constant size and shape would have been sought, so that all masses would have been affected by air resistance equally.

The formulae involved at predicting how far the projectile will travel all imply that the lighter the projectile the further the distance it will travel when fired from the trebuchet. However perhaps there is an optimum ratio of counterweight mass to projectile mass beyond 10g, and after a certain mass the projectile no longer travels any further. This is a variable I would investigate further if more time was available.

- **The use of a heavier counterweight** – Experiments 4 -6 show on average a greater distance travelled by the projectile in comparison to experiments 1 -3, the main difference between these experiment groups was that experiments 4 – 6 utilised a counterweight with a mass of 1kg rather than a mass of 500g. The greater the mass of the counterweight, the greater its gravitational potential energy as it is suspended in the air before being released.

Aforementioned, $E_g = mg\Delta h$, so an increase in m , means an increase in gravitational potential energy of the counterweight. It is this gravitational potential energy of the counterweight that is eventually converted to the kinetic energy of the projectile, so an increase in this gravitational potential energy means an increase in the kinetic energy of the projectile.

If the counterweight mass is doubled, for example from 500g, to 1kg then the gravitational potential energy of the counterweight is also doubled assuming all other factors remain the same (although the 1kg mass is larger than the 500g mass so the height above the ground it is suspended is decreased somewhat). However, doubling counterweight mass does not double the initial velocity of the projectile and therefore double the distance travelled by the projectile. In most experiments it can be seen that when the fulcrum-counterweight distance is kept the same, and only the mass of the counterweight is doubled, the distance travelled by the projectile increases by about 1 metre. The theoretical calculations also predict an increase of approximately 2 metres. This is because $v \propto \sqrt{2(m_c g \Delta h)}$, so doubling the counterweight mass from 500g to 1kg, increases the initial velocity by a factor of roughly $\sqrt{2}$. The main problem with investigating this variable was that because of the 10N weight being so much larger than the 5N weight; it was extremely difficult to suspend both masses equal distances above the ground. This was noticeable in experiments 2 & 3, where the extension of the string meant that the 500g counterweight was suspended at a lower height in experiment 3 in comparison to experiment 2.

In terms of the rotational dynamics of the trebuchet, increasing the counterweight mass increases the torque created about the fulcrum, so as a result there is larger turning force acting on the trebuchet arm so it undergoes greater angular acceleration.

However, the greater the mass of the counterweight, the greater its moment of inertia, which would therefore reduce the angular acceleration; however the increase in torque by a larger factor counteracts this. The formula for moment of inertia used in the calculations has been: $I = m_1d_1^2 + m_2d_2^2$, and because of the relatively short distance between the counterweight and fulcrum, and the fact that this distance is squared, the effect of the increase in mass of the counterweight reducing the angular acceleration is far less in comparison to the factor by which the torque increases the angular acceleration.

- **A greater distance between the fulcrum and counterweight** – As a result of the construction of the trebuchet, there was only one possible place on the trebuchet base where the metal bar supporting the trebuchet arm could be placed despite the fact that there were three holes drilled in the trebuchet arm giving three different distances between this metal bar and the counterweight. Looking at each individual experiment where the counterweight mass is constant, it can be seen from the synoptic graph that increasing the distance from the counterweight to fulcrum each time, increases the average distance travelled by the projectile. This is because increasing the distance between the fulcrum and the counterweight increased the height above the ground to which the counterweight was held; therefore increasing its gravitational potential energy (you can demonstrate this by running your finger down a pen and seeing that one end gets pushed higher up).

Moreover, increasing the distance between the counterweight and fulcrum also increases the torque, since torque is given by force \times distance. However, as can be seen from photos of the trebuchet, the distance between the projectile and fulcrum was always larger than the distance between the fulcrum and the counterweight. The reason for this is because although increasing the distance between the fulcrum and counterweight gives a greater height above the ground to which the counterweight is held, it is also antagonistic in the way that it reduces the maximum vertical height of the trebuchet arm above ground and reduces the radius of the circular path through which the projectile is turned through before release. Although increasing the distance between the counterweight and fulcrum consistently increased the distance travelled by the projectile despite the decrease in maximum vertical height above the ground at which the projectile is released, there must be some form of balance to ensure that the two counteracting properties do not cancel each other out.

As the lever bar of the trebuchet rotates, the distance each end moves through in any given period of time is proportional to its distance from the fulcrum. Therefore, the end with the missile moves further each second than the end with the counterweight – in other words the end with the missile moves faster than the end with the counterweight attached. If the counterweight to fulcrum – distance were too large, then each end of the arm would turn through the same distance in the same amount of time, so the initial velocity of the projectile would be reduced and there would be no mechanical advantage.

One possible way to overcome the fact that increasing the distance between the fulcrum and the counterweight reduces the radius of the circular arc through which the projectile is turned through, could be to modify the original design in which the projectile is attached to the trebuchet arm via a pouch and string.

The pouch is stored underneath the trebuchet arm and swings out as the counterweight falls, therefore giving a larger radius than the wooden arm of the trebuchet can give alone. This also increases the angle through which the projectile turns through, therefore increasing its angular velocity. If its angular velocity is increased then so too is the tangential velocity. The use of a string and pouch could also potentially give the projectile an earlier release, for example at an angle of 45° to the horizontal. This in turn would increase the range of the trebuchet as it reaches a greater maximum height before falling to the ground.

Similarly a longer trebuchet arm should also increase the distance a thrown projectile will achieve as this will increase the radius of the circular arc. However this was not possible to investigate due to time constraints and the fact that the metal bar could not really support a longer trebuchet arm without it abruptly hitting the table.

- **A large angle made with the surface and the trebuchet arm** – As the distance between the counterweight and fulcrum increases, so too does the angle made with the surface and the projectile end of the trebuchet arm. In all cases an angle of 0.855 radians appeared to give the largest range, however only three different angles were tested, and with an increased angle came an increased height above the ground for the counterweight, so it cannot be said with a great deal of certainty that the angle made with the table had a great impact on the range of the trebuchet. However, since $\omega_2 = \sqrt{2\theta\alpha}$ it would make sense that an increase in angle, increases the angular velocity and thus tangential velocity of the projectile as it leaves the arm of the trebuchet. A greater variety of angles would be tested if the experiment were to be repeated so that this relationship could be investigated further, and to see if there is an optimum angle before the projectile starts being released too early or too late.

The friction of the fulcrum and aero dynamicity of the projectiles was not really investigated in the experiments due to the metal bar being kept the same throughout the experiments and the projectiles having to vary in size and shape because of the lack of availability of projectiles of constant dimensions with only their mass increasing. We therefore have no comparison and so cannot concur conclusions from the projectiles and fulcrums used. However it is quite obvious, that the lower the friction of the metal bar, the easier it will be for the trebuchet arm to swing around with its motion unimpeded, and thus the greater its velocity, and hence velocity of the projectile. Air resistance was assumed to be negligible, and in medieval times, it is likely that sharp jagged rocks that weren't particularly aerodynamic were thrown in order to cause the most damage, so the air resistance of the projectiles may have been of less importance to those using trebuchets at the time. The use of extremely light projectiles would have also been less likely to destroy a castle or its walls. For example, it would take a long time to cut down a tree using the bullets from a handgun.

In summary, although the results obtained for each experiment do not show an identical pattern between projectile mass and distance travelled, it can be said with some certainty that in order for a trebuchet to achieve its maximum range there must be the use of projectiles much lighter than the counterweight (100 times lighter), a large height at which the counterweight is suspended above the ground, a large angle through which the projectile turns through and a large vertical height above the ground from which the projectile is released at.

Evaluation

There are several areas of experimental uncertainty in this experiment, which in turn effect the reliability of the data harvested. I would estimate the results are overall 7-15% inaccurate, and this percentage error of inaccuracy stems from several aspects of the experiment.

Firstly, despite measuring the distance travelled by the projectile to the nearest millimetre, it is estimated that when assuming where the centre of the crater was positioned, this could have been out by a maximum of $\pm 0.01\text{m}$. In many cases the crater was not a perfect circle but a small unsymmetrical dent in the sand. If the assumed centre of the crater was incorrect then, as a result, the distance travelled by the projectile noted would also have been incorrect by $\pm 0.01\text{m}$.

Figure 31 – An example of a crater left in the sand by the projectile



As you can see, the craters left by the projectiles were not perfect circles, and so the centre of the crater had to be estimated.

Figure 32 – Potential errors caused by the increase in height of the sand above the ground:

As well as the human error arising from trying to estimate where the centre of the crater was there is also the possibility that because of the sand being raised above ground, this reduced the total distance travelled by the projectile by a small amount. For example, where the ruler had measured 2 metres 78 centimetres, had there been no sand this could have read 2.785 metres. The height of the sand was so small however, that this should not have reduced the distance travelled by the projectiles by a large amount.

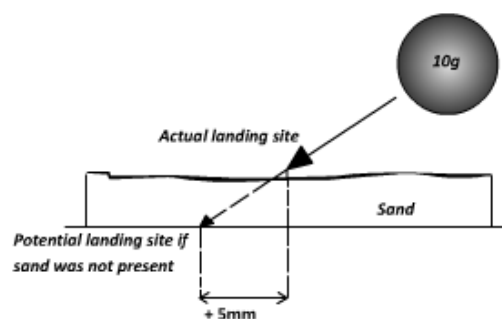

In addition, experimental uncertainty is also likely to arise from parallax error when observing the measurements and marking them up with a ruler. The edges of the tray prevented the ruler being used to measure the vertical distance to the card from being placed flat on the crater and so had to be suspended slightly above it. Due to the angle of observation it is possible that measurements were misread and therefore lacked accuracy. I would say however, in total, it is unlikely that the measurement of distance travelled was incorrect by any more than ± 2.00 centimetres.

If we consider the results for each experiment then we can deduce the total maximum percentage error overall for measuring the distance travelled by the projectile. All values have been rounded to 3 decimal places.

| Experiment 1 | | |
|----------------------|--|---|
| Projectile mass (kg) | Average distance travelled by projectile (m) | Maximum percentage error (%) [0.02/distance (m) x 100] |
| 0.010 | 2.247 | 0.890 |
| 0.020 | 1.676 | 1.193 |
| 0.030 | 1.182 | 1.692 |
| 0.040 | 0.792 | 2.525 |
| 0.050 | 0.618 | 3.236 |
| 0.060 | 0.606 | 3.300 |
| 0.070 | 0.418 | 4.785 |
| 0.080 | 0.277 | 7.220 |

| Experiment 3 | | |
|--------------------------------------|--|---|
| Projectile mass (kg) | Average distance travelled by projectile (m) | Maximum percentage error (%) [0.02/distance (m) x 100] |
| 0.010 | 2.744 | 0.729 |
| 0.020 | 2.555 | 0.783 |
| 0.030 | 2.272 | 0.880 |
| 0.040 | 1.886 | 1.060 |
| 0.050 | 1.581 | 1.625 |
| 0.060 | 1.269 | 1.576 |
| 0.070 | 0.966 | 2.070 |
| 0.080 | 0.761 | 2.628 |
| 0.090 | 0.625 | 3.200 |
| 0.100 | 0.494 | 4.049 |
| Average maximum percentage error (%) | | 1.824 |
| Average maximum percentage error (%) | | 3.105 |

| Experiment 2 | | |
|--------------------------------------|--|---|
| Projectile mass (kg) | Average distance travelled by projectile (m) | Maximum percentage error (%) [0.02/distance (m) x 100] |
| 0.010 | 2.759 | 0.725 |
| 0.020 | 2.293 | 0.872 |
| 0.030 | 1.908 | 1.048 |
| 0.040 | 1.430 | 1.399 |
| 0.050 | 1.047 | 1.910 |
| 0.060 | 0.800 | 2.500 |
| 0.070 | 0.617 | 3.241 |
| 0.080 | 0.608 | 3.289 |
| 0.090 | 0.587 | 3.407 |
| 0.100 | 0.541 | 3.697 |
| Average maximum percentage error (%) | | 2.209 |

| Experiment 4 | | |
|--------------------------------------|--|---|
| Projectile mass (kg) | Average distance travelled by projectile (m) | Maximum percentage error (%) [0.02/distance (m) x 100] |
| 0.010 | 3.207 | 0.624 |
| 0.020 | 2.948 | 0.678 |
| 0.030 | 2.609 | 0.767 |
| 0.040 | 2.323 | 0.861 |
| 0.050 | 2.025 | 0.988 |
| 0.060 | 1.882 | 1.063 |
| 0.070 | 1.530 | 1.307 |
| 0.080 | 1.323 | 1.512 |
| 0.090 | 1.068 | 1.873 |
| 0.100 | 0.851 | 2.350 |
| Average maximum percentage error (%) | | 1.202 |

| Experiment 5 | | |
|---|--|---|
| Projectile mass (kg) | Average distance travelled by projectile (m) | Maximum percentage error (%) [0.02/distance (m) x 100] |
| 0.010 | 3.177 | 0.630 |
| 0.020 | 3.007 | 0.665 |
| 0.030 | 2.701 | 0.740 |
| 0.040 | 2.638 | 0.758 |
| 0.050 | 2.464 | 0.812 |
| 0.060 | 2.267 | 0.882 |
| 0.070 | 2.218 | 0.902 |
| 0.080 | 1.887 | 1.060 |
| 0.090 | 1.713 | 1.168 |
| 0.100 | 1.327 | 1.507 |
| Average maximum percentage error (%) | | 0.912 |

| Experiment 6 | | |
|---|--|---|
| Projectile mass (kg) | Average distance travelled by projectile (m) | Maximum percentage error (%) [0.02/distance (m) x 100] |
| 0.010 | 4.410 | 0.454 |
| 0.020 | 4.103 | 0.487 |
| 0.030 | 3.260 | 0.613 |
| 0.040 | 2.774 | 0.721 |
| 0.050 | 2.635 | 0.759 |
| 0.060 | 2.463 | 0.812 |
| 0.070 | 2.406 | 0.831 |
| 0.080 | 2.180 | 0.917 |
| 0.090 | 2.007 | 0.997 |
| 0.100 | 1.706 | 1.172 |
| Average maximum percentage error (%) | | 0.776 |

As these tables show, the maximum percentage error is greater for smaller projectile distances, therefore insinuating that these recordings are less accurate than the measurements taken when the projectile had travelled further. The inaccuracy of $\pm 0.02\text{m}$ has less of an impact for larger projectile distances; for example, in experiment 1, the projectile with mass 0.030kg could have landed anywhere between 1.202 metres or 1.162 metres .

However looking at the projectile mass of 0.080kg for the same experiment, the percentage error suggests that the projectile could have landed anywhere between 0.257 metres or 0.297 metres . This gives a larger percentage difference on the smaller spectrum of distance travelled.

The highest value for maximum percentage error of the data resulted with a 7.22% percentage error for experiment 1 using the 0.08kg mass. This maximum percentage error is quite reasonable considering the simplicity of the experiment. On average, taking into account all of the average maximum percentage errors for each experiment, the average maximum percentage error of recording the distance travelled by the projectile was equal to: 1.67% . This suggests that the recording of the distance of the projectile was somewhat accurate; however clearly there are more accurate ways to do this.

Given the opportunity to perform this experiment differently, there are several changes I would make to improve the accuracy of measuring how far the projectile travelled. One possibility could be to use electronic timers to control when the trebuchet arm is released and to measure how long the projectile takes to hit the ground. This would have to involve some kind of mechanism in which the trebuchet arm is held down, perhaps by a metal wire or piece of string. As the wire or string is pulled away, this triggers the timer placed a given distance away from the trebuchet to begin timing. When the projectile hits the device timing, this causes the timer to stop timing.

The time recorded is then used as the time of flight and multiplying this by the horizontal velocity gives the total distance travelled. The horizontal velocity could be deduced using light gates placed at the point of release of the projectile.

There are obvious difficulties with such a set up. Firstly, the likelihood of the projectile hitting the timing device seems to be rather unlikely, unless the timing device was very large. On the other hand, the timing device could be small but also sensitive to vibrations (perhaps a piezoelectric crystal), so that as the projectile hits the ground/table, the vibrations of the impact are converted to an alternating voltage signal and then using the time taken for this signal to be generated the distance could be calculated.

The major flaw in this design however, is that I do not know how to construct such a circuit or where to obtain such equipment. The 'log-it' data loggers that the school has available can be used as light gates, so this could be used in future experiments to measure the initial velocity of the projectile as it leaves the trebuchet arm. How effective the light gates will be for such small sized masses moving at high speeds though is not known. The use of these light gates however would allow a more direct measure of the efficiency of the trebuchet as it is unlikely that the projectile constantly left the arm of the trebuchet with just horizontal velocity.

Although the manual measuring of the crater left by the projectile and thus its distance travelled appeared to have a relatively small percentage error, it is thought that the firing of the projectiles themselves is the largest source of error. Although as much was done as possible to ensure that the trebuchet arm was perfectly aligned and as straight as possible, it was noticed that the counterweight did not always fall with a perfect vertical drop and the projectile released was more than often not released in a straight line. In most cases the tray of sand had to be positioned slightly to the left of the trebuchet rather than directly in front of it, suggesting that the projectiles were not being fired in straight lines.

Projectiles that would have been fired in a straight line would have travelled further than those that were fired at a slight angle, which may explain why some of the graphs produced don't show perfect curves or straight lines. Although the measuring of the distance may have been correct, the actual firing of the projectiles perfectly straight forward was not, and so the measured results may have been slightly less than if the projectile had left with forward horizontal velocity only. This could have also explained why the anticipated values of distance were so far from the actual values of distance – although this is thought to have stemmed from the fact that the projectiles might not have left the trebuchet arm with just horizontal velocity and that the transfer of energy was not 100% efficient.

The structural flaws of the trebuchet are the most likely sources of anomalous data. The counterweight did not always strike the floor for each experiment. As the distance between the counterweight and fulcrum increased, the maximum vertical height of the trebuchet arm decreased so this meant the counterweight hit the floor for experiments 5 and 6. For counterweights that did not hit the floor, it was more likely that the counterweight obtained some of the energy of the system, thus meaning there was less available as kinetic energy of the missile so the projectiles did not fly as far. In summary, I would accredit the firing of projectiles in a straight line an inaccuracy of approximately 10%.

In medieval times, many trebuchets were designed so that the counterweight was constrained to fall vertically by forcing it to fall in a vertical slot, reducing the to-and-fro movement of it during a launch.

Perhaps if I had forced the counterweight to fall perfectly vertically through a slot, rather than allowing it to swing to-and-fro, this would have reduced the amount of energy being wasted as the kinetic energy of the counterweight, and the results would have produced a much more distinct trend. This would have improved the efficiency of the trebuchet and perhaps reduced the difference between the theoretical results and the actual results.

Other causes for a less than 100% energy transfer from counterweight gravitational potential energy to projectile kinetic energy could be due to energy being dissipated as heat energy as the trebuchet arm moved against the frictional forces of the air and the metal bar making up the fulcrum. Carrying out the experiment in a vacuum would be impractical but to reduce the frictional forces of the metal bar, lubricant, such as oil could be applied to the metal surface. Using many different materials for the fulcrum could also give a comparison on which metal surface has the lowest coefficient of friction and this would be another variable that would be investigated if more time was available.

Many medieval trebuchets also adopted wheels into their design. The use of wheels provides support as the falling counterweight shakes the base. As was noticed without the use of G-clamps, the trebuchet base lurched forward as the projectile was fired forward. Although using G-clamps restricted this movement, the trebuchet would still have tried to move against the g-clamps, which could be a potential reason as to why the trebuchet started creaking in the final experiment. The addition of wheels to the trebuchet would have allowed the trebuchet to move as it fired projectiles, without slamming against the floor or moving up against the G-clamps. This in turn would have meant that the base of the trebuchet would experience less stress and work for a longer amount of time.

Since the rolling wheels prevent the trebuchet from being thrown forwards and crashing back into the ground, the energy of the counterweight is more smoothly channelled into the trebuchet's arm and missile.

The wheels add power as the trebuchet rolls forward, the forward motion adds velocity to the projectile and in general it has been found that the projectile can be launched up to 33% further when wheels are incorporated into the design. The rolling back and forth of the wheeled counterweight also allows it to fall in a straighter line, giving it the most efficient way to respond to gravity. If the counterweight falls in a straight line, then the initial velocity of the projectile is increased and hence so too is the distance travelled by the projectile.

If I were to be given the opportunity to perform this experiment again, then the use of wheels would have been a variable I would have investigated to see to what extent this affects the range of the trebuchet. I could have then compared the distances achieved by two trebuchets under the same conditions, with one of them having wheels and the other one not to see if the use of wheels really does improve the range by 33%.

Another area I would like to investigate would be to see if other siege engines produced further ranges than the trebuchet. For example, does the extension of a spring using catapult, give a more efficient transfer of elastic potential energy into the kinetic energy of the projectile?

Due to the simplicity of the experiment, the only other variable being measured was the masses being used as projectiles and counterweights. The sensitive scales could detect a mass 0.01 of a gram; they therefore had an uncertainty of $\pm 5 \times 10^{-6}$ kg, this uncertainty is so small that it can be assumed as negligible.

Unfortunately, not all of the masses were of the same size and shape, so air resistance could not really be analysed. This is another source of further potential investigation if more time was available. The use of many different shaped projectiles all with the same mass, would have allowed myself to see which shape of projectile is most aerodynamic and hence travels further. As previously mentioned, if the experiment were to be repeated, then an even greater range of masses would be utilised, to see if there are any differences in the general trend, and to generally improve the accuracy of the experiments and drawing smooth curves when plotting the graph.

If I had the opportunity to do the experiment again, an alternative distance measuring method could involve the use of a video camera with a high number of frames per second. After watching the footage back in slow motion, and recording how far the projectile travelled, I could have taken stills of the footage and then analysed those. I could have also made use of a stroboscope to improve the accuracy of my results. This instrument would have caused the projectile and trebuchet arm to appear slow-moving or stationary. Electronic stroboscopes emit brief and rapid flashes of light, the frequency of the flash is adjusted so that it matches or is a unit fraction below the objects cyclic speed. This makes the object appear stationary. Using this I could have deduced the speed of the trebuchet arm by finding the frequency of flashes of light that make it appear to be stationary. This could have then been used to more accurately deduce the initial velocity of the projectile. The use of a stroboscope would have to be used with the video camera, as the projectiles would be travelling too fast for the stroboscope to be of any use by visual observation. There would also be the safety issue regarding any epileptic students.

Generally, although my results are by no means 100% accurate, looking at the graphs and the results obtained, I think it can be said with certainty that as the projectile mass decreases, and counterweight increases, the distance travelled by the projectile increases. In addition, the greater the height above the ground the counterweight is held, and the greater the angle through which the projectile turns through, the greater the displacement of the projectile. Overall, I would give my experiment a percentage error of 11.67% and despite this relatively large percentage error; I believe I have proved my hypothesis and fulfilled the aim of the experiment.

Bibliography

Images

Figures 1-

http://media.photobucket.com/image/warwick%20castle%20trebuchet/smerk_au/SarahsCD097.jpg

Figure 2 -

http://farm1.static.flickr.com/31/38544665_93bc8f1ef8.jpg?v=0

All other figures have been drawn as diagrams by myself using macromedia flash player or using the camera on my phone for photos of the apparatus.

Information

Trebuchet background information - <http://en.wikipedia.org/wiki/Trebuchet>

Trebuchet Physics - Physics Review Magazine , Volume 14, Number 4, April 2005, pages 26 - 29

Projectile Motion – AS Salters Horners Advanced Physics, pages 48 – 49

Rotational Dynamics of the trebuchet – adapted from http://www.antonine-education.co.uk/Physics_A2/Options/Module_7/Topic_1/topic_1_rotational_dynamics.htm

Trebuchets with wheels -

<http://www.pbs.org/wgbh/nova/lostepires/trebuchet/wheels.html>

Construction of trebuchet specifications

<http://www.stormthecastle.com/trebuchet/how-to-build-a-trebuchet.htm>