





What Fuji Motor Control Do I Need?

There are four basic motor control options available: Basic contactors, traditional starters, manual motor starters, or combination starters. Follow these 3 steps to choose the best fit.

1 What does the application require?

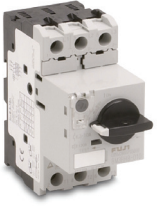
Basic Contactors Only	Traditional Starters	Manual Motor Starters	Combination Starters
			
<p>Contactor</p> <p>Typical applications:</p> <ul style="list-style-type: none"> • Electronic switching • Lighting • Resistive loads • Non-motor-related inductive loads • Disconnect switches • VFD bypass/isolation 	<p>Contactor and overload relay</p> <p>Typical applications:</p> <ul style="list-style-type: none"> • Inductive motor starting and control • NEC 430 and 409 fulfillment • Nm starter replacement/retrofit 	<p>Manual motor starter (MMS)</p> <p>Typical applications:</p> <ul style="list-style-type: none"> • Inductive motor starting and manual control • NEC 430 fulfillment • Lockout/tagout • UL 508, type E • Not AC-4 rated 	<p>Manual motor starter, contactor, link module, and base plate</p> <p>Typical applications:</p> <ul style="list-style-type: none"> • Inductive motor starting and control • NEC 430 and 409 fulfillment • Lockout/tagout • UL 508, type F

2 Consider these factors when selecting components:

- Load type: Resistive (AC-1) or inductive (AC-3)
- Duty cycle: One direction, reversing, plugging (AC-4); Refer to IEC Utilization Chart on page 17-117
- Horsepower (HP) and full load amperage (FLA); Refer to motor data plate information.

3 Select your components.

<p>Duo Series</p> <p>SC-E Contactor See page 17-32</p> <ul style="list-style-type: none"> • 1/2 to 100 hp @ 480 V • 9-150 A (AC3) <p>Odyssey Series</p> <p>3N Contactor See page 17-79</p> <ul style="list-style-type: none"> • 60 to 300 hp • 180-361 A (AC3) 	<p>Duo Series</p> <p>SC-E Contactor See page 17-32</p> <p>TK-E Overload relay See page 17-48</p> <ul style="list-style-type: none"> • 1/2 to 100 hp @ 480 V <p>Odyssey Series</p> <p>3N Contactor See page 17-79</p> <p>3N Overload relay See page 17-82</p> <ul style="list-style-type: none"> • 60 to 300 hp 	<p>Duo Series</p> <p>BM3 Manual motor starter See page 17-55</p> <ul style="list-style-type: none"> • 1/2 to 40 hp @ 480 V 	<p>Duo Series</p> <p>BM3 Manual motor starter See page 17-55</p> <p>SC-E Contactor See page 17-32</p> <p>BZOL link module See page 17-70</p> <p>BZOBP base plate</p> <ul style="list-style-type: none"> • 1/2 to 40 hp @ 480 V
--	--	--	--

Fuji Duo Series SC-E Contactors

Features

- 5 to 100 hp at 480 VAC
- cULus and CSA approval, CE mark, meets JIS and IEC standards.
- Models SC-E02-xxx to SC-E4-xxx have 3-pole main circuits and come in three sizes with widths of 43 mm, 54 mm, and 67 mm.
- Models SC-E1-xxx to SC-E7-xxx employ a box terminal structure; allowing wires to be connected directly to the main circuit.
- Has a finger-protection terminal structure that prevents the exposure of live parts.
- Models SC-E5-xxx to SC-E7-xxx use a SUPERMAGNET™ (AC-input/DC-output operation) for high operating reliability and requires no surge suppressor.

Small Size

- SC-E02-xxx to E05-xxx: 43mm wide
- SC-E1-xxx to E2S-xxx: 54mm wide
- SC-E3-xxx, E4-xxx: 67mm wide
- SC-E5-xxx: 88mm wide



SC-E2S



SC-E7

Safety

- Terminals with finger-touch protection (DIN 57106/VDE 0106 Teil1.00)

Utility

- Box lug terminal construction
- Long electrical life
- Easy to wire

Environmental

- Low power consumption
- Recycled thermoplastic resin used for plastic parts.
- The names of materials are indicated on all major parts to facilitate recycling

Standards & Approvals

- UL listed, file E42419, Standard UL 508
- cUL listed, file E42419, Standard CSA C 22.2 No.14
- VDE 0660
- JIS C 8201-4-1
- IEC 60947-4-1 / EN 60947-4-1
- CE compliant

Optional accessories

- Auxiliary contact blocks
- Coil surge suppression units
- Replacement coils for contactor sizes SC-E5 and larger

SC-E Series Contactors Specifications - UL and CSA													
Model	Price	Nominal Coil Voltage	Rated Capacity (HP)						Rated AC-3 Current (A) [note 1]	Rated AC-1 Thermal Current (A) [note 2]	SCCR Ratings (KA)	Rated Insulation Voltage (V)	Frame Width (mm)
			3-Phase Motor				1-Phase Motor						
			200V	220-240V	440-480V	550-600V	100-120V	220-240V					
SC-E02-24VAC	\$15.00	24VAC	2	2	5	5	1/3	1	9	20	690	43	
SC-E02-110VAC	\$15.00	110VAC											
SC-E02-220VAC	\$15.00	220VAC											
SC-E02-440VAC	\$15.00	440-480VAC											
SC-E02-500VAC	\$15.00	500-550VAC											
SC-E02G-24VDC	\$17.00	24VDC	3	3	7.5	7.5	1/2	2	12	20	690	43	
SC-E03-24VAC	\$19.50	24VAC											
SC-E03-110VAC	\$19.50	110VAC											
SC-E03-220VAC	\$19.50	220VAC											
SC-E03-440VAC	\$19.50	440-480VAC											
SC-E03-500VAC	\$19.50	500-550VAC											
SC-E03G-24VDC	\$27.50	24VDC	5	5	10	10	1	3	18	25	690	43	
SC-E04-24VAC	\$24.00	24VAC											
SC-E04-110VAC	\$24.00	110VAC											
SC-E04-220VAC	\$24.00	220VAC											
SC-E04-440VAC	\$24.00	440-480VAC											
SC-E04-500VAC	\$24.00	500-550VAC											
SC-E04G-24VDC	\$33.00	24VDC	5	7.5	15	15	2	3	25	32	690	43	
SC-E05-24VAC	\$30.50	24VAC											
SC-E05-110VAC	\$30.50	110VAC											
SC-E05-220VAC	\$30.50	220VAC											
SC-E05-440VAC	\$30.50	440-480VAC											
SC-E05-500VAC	\$30.50	500-550VAC											
SC-E05G-24VDC	\$40.00	24VDC											

TABLE CONTINUED NEXT PAGE

Notes: 1. AC3 type loads consist of squirrel cage three-phase motors; occasional, limited jogging duty.
 2. AC1 non-inductive or slightly inductive loads. Typically resistive loads (i.e. furnaces, ovens, etc.)

Fuji Duo Series SC-E Contactors



Company Information

Drives

Soft Starters

Motors

Power Transmission

Motion: Servos and Steppers

Motor Controls

Sensors: Proximity

Sensors: Photoelectric

Sensors: Encoders

Sensors: Limit Switches

Sensors: Current

Sensors: Pressure

Sensors: Temperature

Sensors: Level

Sensors: Flow Switches

Pushbuttons and Lights

Stacklights

Signal Devices

Process

Relays and Timers

Pneumatics: Air Prep

Pneumatics: Directional Control Valves

Pneumatics: Cylinders

Pneumatics: Tubing

Pneumatics: Air Fittings

Appendix Book 2

Terms and Conditions

SC-E Series Contactors Specifications - UL and CSA													
Model	Price	Nominal Coil Voltage	Rated Capacity (HP)						Rated AC-3 Current (A) [note 1]	Rated AC-1 Thermal Current (A) [note 2]	SCCR Ratings (KA)	Rated Insulation Voltage (V)	Frame Width (mm)
			3-Phase Motor				1-Phase Motor						
			200V	220-240V	440-480V	550-600V	100-120V	220-240V					
SC-E1-24VAC	\$37.50	24VAC	7.5	10	25	25	2	3	32	50	54		
SC-E1-110VAC	\$37.50	110VAC											
SC-E1-220VAC	\$37.50	220VAC											
SC-E1-440VAC	\$37.50	440-480VAC											
SC-E1-500VAC	\$37.50	500-550VAC											
SC-E1G-24VDC	\$44.50	24VDC	10	15	30	30	3	5	40	60			
SC-E2-24VAC	\$52.50	24VAC											
SC-E2-110VAC	\$52.50	110VAC											
SC-E2-220VAC	\$52.50	220VAC											
SC-E2-440VAC	\$52.50	440-480VAC											
SC-E2-500VAC	\$52.50	500-550VAC											
SC-E2G-24VDC	\$63.50	24VDC	15	20	30	30	3	10	50	65	5		
SC-E2S-24VAC	\$63.50	24VAC											
SC-E2S-110VAC	\$63.50	110VAC											
SC-E2S-220VAC	\$63.50	220VAC											
SC-E2S-440VAC	\$63.50	440-480VAC											
SC-E2S-500VAC	\$63.50	500-550VAC											
SC-E2SG-24VDC	\$75.50	24VDC	20	25	50	50	5	15	65	100			
SC-E3-24VAC	\$72.00	24VAC											
SC-E3-110VAC	\$72.00	110VAC											
SC-E3-220VAC	\$72.00	220VAC											
SC-E3-440VAC	\$72.00	440-480VAC											
SC-E3-500VAC	\$72.00	500-550VAC											
SC-E3G-24VDC	\$89.00	24VDC	25	30	50	50	5	15	80	105			
SC-E4-24VAC	\$74.00	24VAC											
SC-E4-110VAC	\$74.00	110VAC											
SC-E4-220VAC	\$74.00	220VAC											
SC-E4-440VAC	\$74.00	440-480VAC											
SC-E4-500VAC	\$74.00	500-550VAC											
SC-E4G-24VDC	\$92.00	24VDC	30	30	60	75	7.5	15	105	150			
SC-E5-24V	\$184.00	24VAC/VDC											
SC-E5-100V	\$184.00	110VAC/VDC											
SC-E5-200V	\$184.00	220VAC/VDC											
SC-E5-400V	\$184.00	380-450VAC											
SC-E5-500V	\$184.00	460-575VAC											
SC-E6-24V	\$234.50	24VAC/VDC	40	40	75	100	10	20	125	150	10		
SC-E6-100V	\$234.50	110VAC/VDC											
SC-E6-200V	\$234.50	220VAC/VDC											
SC-E6-400V	\$234.50	380-450VAC											
SC-E6-500V	\$234.50	460-575VAC											
SC-E7-24V	\$273.00	24VAC/VDC	50	50	100	125	15	25	150	200			
SC-E7-100V	\$273.00	110VAC/VDC											
SC-E7-200V	\$273.00	220VAC/VDC											
SC-E7-400V	\$273.00	380-450VAC											
SC-E7-500V	\$273.00	460-575VAC											

Notes: 1. AC3 type loads consist of squirrel cage three-phase motors; occasional, limited jogging duty.
 2. AC1 non-inductive or slightly inductive loads. Typically resistive loads (i.e. furnaces, ovens, etc.)

Fuji Duo Series SC-E Contactors



SC-E Series Contactors Specifications - IEC												
Contactor Type	Rated Capacity (kW)				Rated Operating Current (A)						Rated Thermal Current (A)	Internal Auxiliary Contact Arrangement
	3-Phase Motor AC-3 / AC-4				3-Phase Motor AC-3 / AC-4				Resistive Load AC-1			
	200-240V	380-440V	500-550V	600-690V	200-240V	380-440V	500-550V	600-690V	200-240V	380-440V		
SC-E02(G)-xxx	2.2 / 2.2	4 / 4	4 / NA	4 / NA	9 / 9	9 / 9	7 / NA	5 / NA	20	20	20	-
SC-E03(G)-xxx	3 / 3	5.5 / 5.5	5.5 / NA	5.5 / NA	12 / 12	12 / 12	9 / NA	7 / NA	20	20	20	-
SC-E04(G)-xxx	4 / 4	7.5 / 7.5	7.5 / NA	7.5 / NA	18 / 18	18 / 18	13 / NA	9 / NA	25	25	25	-
SC-E05(G)-xxx	5.5 / 4	11 / 7.5	11 / NA	7.5 / NA	25 / 18	25 / 18	17 / NA	9 / NA	32	32	32	-
SC-E1(G)-xxx	7.5 / 7.5	15 / 15	15 / NA	11 / NA	32 / 32	32 / 32	24 / NA	15 / NA	50	50	50	-
SC-E2(G)-xxx	11 / 11	18.5 / 18.5	18.5 / NA	15 / NA	40 / 40	40 / 40	29 / NA	19 / NA	60	60	60	-
SC-E2S(G)-xxx	15 / 11	22 / 18.5	25 / NA	22 / NA	50 / 40	50 / 40	38 / NA	26 / NA	65	65	65	-
SC-E3(G)-xxx	18.5 / 18.5	30 / 30	37 / NA	30 / NA	68 / 68	65 / 65	60 / NA	38 / NA	100	100	100	-
SC-E4(G)-xxx	22 / 18.5	40 / 30	37 / NA	37 / NA	80 / 68	80 / 65	60 / NA	44 / NA	105	105	105	-
SC-E5-xxx	30 / 30	55 / 55	5 5 / NA	55 / NA	105 / 105	105 / 105	85 / NA	64 / NA	150	150	150	2NO+2NC
SC-E6-xxx	37 / 37	60 / 60	6 0 / NA	60 / NA	125 / 125	125 / 125	90 / NA	72 / NA	150	150	150	2NO+2NC
SC-E7-xxx	45 / 45	75 / 75	75 / NA	90 / NA	150 / 150	150 / 150	120 / NA	103 / NA	200	200	200	2NO+2NC

Internal Auxiliary Contact Ratings

Internal Auxiliary Contact Ratings - UL and CSA						
Frame Size <small>(note 1)</small>	Rated Insulation Voltage (V)	NEMA ICS 5-2000 Ratings <small>(note 2)</small>				
		AC Ratings			DC Ratings	
		Designation	Making VA	Breaking VA	Designation	Making/Breaking VA
E5 to E7-xxx	690	A600	7200	720	Q300	69

Notes:

- E02(G) to E4(G) do not have internal auxiliary contact.
- NEMA ICS 5-2000. For more information, refer to Control Circuit Contact Electrical Ratings, see page 116.

Internal Auxiliary Contact Ratings - IEC, JIS									
Based on IEC 60974-4-1, EN 60947-4-1, JIS C 8201-4-1									
Frame Size <small>(note 1)</small>	Rated Insulation Voltage (V)	Rated Thermal Current (A)	Making and Breaking Capacity (A)		Rated Operational Current (A)			Minimum Operating Voltage and Current	
			AC Voltage	Amps	AC Voltage	AC-15 (Ind. load)	DC Voltage		DC-13 (Ind. load)
E5 to E7-xxx	690	10	120V	60	120V	6	24V	3	5VDC, 3mA
			220V	30	220V	3	48V	1.5	
			440V	15	440V	1.5	110V	0.55	
			600V	12	600V	1.2	220V	0.27	

Note 1: E02(G) to E4(G) do not have internal auxiliary contact.

Fuji Odyssey Series 3N Contactors



Description

- 180 - 361A rating (AC3)
- Provides higher current and horsepower capabilities than SC-E series. Designed for reliable use in applications requiring constant switching, reduced coil energy consumption, and increased horsepower capabilities.
- Available in 154 mm and 169 mm frame widths
- SUPERMAGNET™ for high operating reliability.
- Use with Odyssey 3N series overload relays.

Features

- Equipped with 2 N.O. and 2 N.C. auxiliary contacts
- Chatter-free operation eliminates contact welding and coil burning
- SUPERMAGNET™ coil operates on either AC or DC voltage
- Wire Terminal Connection Type: Crimp ring Terminal



3NC4H0122

Agency approvals

- UL listed file E42419, Standard UL508
- cUL listed file E42419, Standard CSA C22.2 No. 14
- CE: Meets LVD EN60947-4-1
- SEMI F47-0200

Optional accessories

- Replacement coils
- Terminal covers

Ecology

- Low power consumption
- Recycled thermoplastic resin used for plastic parts.
- The names of materials are indicated on all major parts to facilitate recycling.

Odyssey 3N Series Contactors 180–361 Amps

Part Number	Fuji Type	Price	Coil Voltage	Rated Motor Capacity (HP)						Rated AC-3 Current (A) [note 1]	Rated AC-1 Thermal Current (A) [note 2]	Quantity of Auxiliary Contacts		SCCR Ratings (KA)	Frame Width (mm)
				3-Phase				1-Phase				NO	NC		
				200–208V	220–240V	440–480V	550–600V	100–120V	220–240V						
3NC4Q0E22	SC-N8	\$361.50	24–25VAC / 24VDC	60	60	150	150	180	260	2	2	10	138		
3NC4Q0122		\$361.50	100–127VAC / 100–120VDC												
3NC4Q0222		\$361.50	200–250VAC / 200–240VDC												
3NC4Q0Q22		\$361.50	380–450VAC												
3NC4Q0422		\$361.50	460–575VAC												
3NC4H0E22	SC-N10	\$428.00	24–25VAC / 24VDC	75	75	150	200	221	260	2	2	10	138		
3NC4H0122		\$428.00	100–127VAC / 100–120VDC												
3NC4H0222		\$428.00	200–250VAC / 200–240VDC												
3NC4H0Q22		\$428.00	380–450VAC												
3NC4H0422		\$428.00	460–575VAC												
3NC5F0E22	SC-N11	\$558.00	24–25VAC / 24VDC	100	100	200	250	285	350	2	2	18	148		
3NC5F0122		\$558.00	100–127VAC / 100–120VDC												
3NC5F0222		\$558.00	200–250VAC / 200–240VDC												
3NC5F0Q22		\$558.00	380–450VAC												
3NC5F0422		\$558.00	460–575VAC												
3NC5H0E22	SC-N12	\$612.00	24–25VAC / 24VDC	125	150	300	350	361	450	2	2	18	148		
3NC5H0122		\$612.00	100–127VAC / 100–120VDC												
3NC5H0222		\$612.00	200–250VAC / 200–240VDC												
3NC5H0Q22		\$612.00	380–450VAC												
3NC5H0422		\$612.00	460–575VAC												

Notes: 1. AC3 type loads consist of squirrel cage three-phase motors; occasional, limited jogging duty.
2. AC1 non-inductive or slightly inductive loads. Typically resistive loads (i.e. furnaces, ovens, etc.)

Contactors Coil Characteristics - AC Input

Part Number	Power Consumption (VA)		Pick-up Voltage (V)	Drop-out Voltage (V)	Operating Time (ms)	
	Inrush	Sealed			Coil ON to Contact ON	Coil OFF to Contact OFF
3NC4Qxxxx, 3NC4Hxxxx	277	5.4	70-80	35-50	35-41	37-45
3NC5Fxxxx, 3NC5Hxxxx	265	5.9	70-80	35-50	40-47	36-43

NOTE: This data is based on 100-120V SUPERMAGNET™ coil, tested at 120VAC, 60Hz.

Fuji Odyssey Series 3N Contactors

Contactor Coil Characteristics - DC Input - 110VDC						
Part Number	Power Consumption (watts)		Pick-up Voltage (V)	Drop-out Voltage (V)	Operating Time (ms)	
	Inrush	Sealed			Coil ON to Contact ON	Coil OFF to Contact OFF
3NC4Qxxxx, 3NC4Hxxxx	324	4.1	77-88	28-44	35-41	37-45
3NC5Fxxxx, 3NC5Hxxxx	340	4.5	77-88	28-44	40-47	36-43

NOTE: This data is based on 100-120V SUPERMAGNET™ coil, tested at 110VDC.

Contactor Coil Characteristics - DC Input - 24VDC						
Part Number	Power Consumption (watts)		Pick-up Voltage (V)	Drop-out Voltage (V)	Operating Time (ms)	
	Inrush	Sealed			Coil ON to Contact ON	Coil OFF to Contact OFF
3NC4Qxxxx, 3NC4Hxxxx	250	5.9	17-19.2	6-12	35-41	37-45

NOTE: This data is based on 100-120V SUPERMAGNET™ coil, tested at 110VDC.

Contactor Auxiliary Contact Ratings					
NEMA ICS 5-2000 Ratings (note 1)					
AC Ratings			DC Ratings		
Designation	Making VA	Breaking VA	Designation	Making/Breaking VA	
A600	7200	720	Q300	69	

Note 1: NEMA ICS 5-2000. For more information, refer to Control Circuit Contact Electrical Ratings, page 17-116.

Contactor Terminal Tightening Torque Chart				
Part Number	Terminal Size	Cable Size Maximum	Applicable Max. Width for Ring Terminal	Tightening Torque
3NC4Q0XXX	M10	300MCM (152mm ²)	36.5mm	133-177 in.-lbs. 15-20 Nm
3NC4H0XXX	M10	300MCM (152mm ²)	36.5mm	133-177 in.-lbs. 15-20 Nm
3NC5F0XXX 3NC5H0XXX	M12	400MCM (203mm ²)	44.5mm	310-399 in.-lbs. 35-45 Nm

Contactor Life Expectancy Performance Data				
Model	Current Capacity Make/Break	Operating Cycles per Hour	Life Expectancy (million operations)	
			Electrical	Mechanical
3NC4Qxxxx through 3NC5Fxxxx	12xle/10xle	1200	1	5
3NC5Hxxxx	12xle/10xle	1200	0.5	5

Note: Rated operational current. Electrical life test: Conforming to IEC947-4-1, AC3. The endurance test complies with the requirements of international standard IEC, JIS and JEM.

Note: Super Magnet Coils on 3NC4 and 3NC5 series contactors have internal surge suppression. See diagram below.

Optional accessories

Terminal covers

Prevent contact with electrified terminals.



SZ-N8T



SZ-N11T

Replacement contactor coils



SZ-GSN11-100

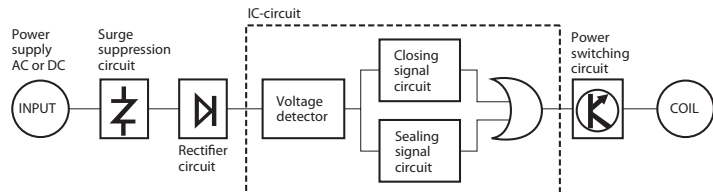

Odyssey Series Contactor Terminal Covers			
Part Number	Price	Description	Applicable Contactors
SZ-N8T	\$45.00	Terminal cover for line or load side. Prevents contact with electrified contactor terminals.	3NC4Qxxxx, 3NC4Hxxxx contactors
SZ-N11T	\$55.00		3NC5Fxxxx, 3NC5Hxxxx contactors

Odyssey Series Replacement Contactor Coils			
Part Number	Price	Applicable Contactors	Coil Voltage
SZ-GSN8-100	\$148.50	3NC4Q0122, 3NC4H0122	100-127VAC/100-120VDC
SZ-GSN11-100	\$163.50	3NC5F0122, 3NC5H0122	100-127VAC/100-120VDC
SZ-GSN8-24	\$148.50	3NC4Q0E22, 3NC4H0E22	24-25VAC/24VDC
SZ-GSN11-24	\$163.50	3NC5F0E22, 3NC5H0E22	24-25VAC/24VDC

Replacement coils are not available for coil codes Q and 4 (380-450VAC and 460-575VAC).

Fuji Duo Series TK-E Overload Relays

TK-E series thermal overload relays with open-phase protective device

Features

- This relay protects motor windings from burning due to overloads, locked rotor current, or open-phases
- Maintenance and inspection safety has been improved by employing a finger protection mechanism to cover exposed terminals (conforms to DIN 57106, VDE 0106 Teil 100)
- Isolated NO and NC contacts can be used with different potentials
- A high-precision scale for the current adjustment dial enables easy and exact current setting
- The operating status can be visually checked with ease
- The relays can be manually tripped. A trip-free mechanism is also provided
- Base unit can be added to enable separate mounting of the TK-E02, E2, and E3-xxx models

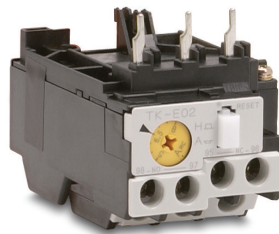

TK-E02-900



TK-E3-5000



TK-E2-800



TK-E5-3600

Standards

UL listed, file E44592, Standard UL 508
 cUL listed, file E44592, CSA C22.2 No. 14
 IEC 60947-4-1, EN60947-4-1
 VDE 0660, JIS C 8201-4-1
 CE Compliant



TK-E6-6500

TK-E Series Overloads			
Part Number	Price	Amperage Adjustment Range (A)	Frame Width/ Contactor
TK-E02-15	\$25.00	0.1 - 0.15	53mm SC-E02(G) through SC-E05(G) For separate mounting, use with optional base unit SZ-HCE on page 17-53
TK-E02-20	\$25.00	0.13 - 0.2	
TK-E02-24	\$25.00	0.15 - 0.24	
TK-E02-30	\$25.00	0.2 - 0.3	
TK-E02-36	\$25.00	0.24 - 0.36	
TK-E02-54	\$25.00	0.36 - 0.54	
TK-E02-72	\$25.00	0.48 - 0.72	
TK-E02-96	\$25.00	0.64 - 0.96	
TK-E02-120	\$25.00	0.8 - 1.2	
TK-E02-145	\$25.00	0.95 - 1.45	
TK-E02-220	\$25.00	1.4 - 2.2	
TK-E02-260	\$25.00	1.7 - 2.6	
TK-E02-340	\$25.00	2.2 - 3.4	
TK-E02-420	\$25.00	2.8 - 4.2	
TK-E02-600	\$25.00	4.0 - 6.0	
TK-E02-800	\$25.00	5.0 - 8.0	
TK-E02-900	\$25.00	6.0 - 9.0	
TK-E02-1100	\$25.00	7.0 - 11.0	
TK-E02-1300	\$25.00	9.0 - 13.0	
TK-E02-1800	\$25.00	12 - 18	
TK-E02-2200	\$25.00	16 - 22	
TK-E02-2500	\$25.00	20 - 25	

TK-E Series Overloads (continued)			
Part Number	Price	Amperage Adjustment Range (A)	Frame Width/ Contactor
TK-E2-600	\$40.00	4 - 6	54mm SC-E1(G) through SC-E2S(G) For separate mounting, use with optional base unit SZ-HDE on page 17-53
TK-E2-800	\$40.00	5 - 8	
TK-E2-900	\$40.00	6 - 9	
TK-E2-1100	\$40.00	7 - 11	
TK-E2-1300	\$40.00	9 - 13	
TK-E2-1800	\$40.00	12 - 18	
TK-E2-2600	\$40.00	18 - 26	
TK-E2-3600	\$40.00	24 - 36	
TK-E2-4200	\$40.00	32 - 42	
TK-E2-5000	\$40.00	40 - 50	
TK-E2-5400	\$40.00	44 - 54	
TK-E3-1100	\$49.00	7 - 11	68mm SC-E3(G) through SC-E4(G) For separate mounting, use with optional base unit SZ-HEE on page 17-53
TK-E3-1300	\$49.00	9 - 13	
TK-E3-1800	\$49.00	12 - 18	
TK-E3-2600	\$49.00	18 - 26	
TK-E3-3600	\$49.00	24 - 36	
TK-E3-4000	\$49.00	28 - 40	
TK-E3-5000	\$49.00	34 - 50	
TK-E3-6500	\$49.00	45 - 65	
TK-E3-6800	\$49.00	48 - 68	
TK-E3-8000	\$49.00	64 - 80	

TK-E Series Overloads (continued)				
Part Number	Price	Amperage Adjustment Range (A)	Frame Width/ Contactor	
TK-E5-2600	\$26.75	18 - 26	76.5mm SC-E5	
TK-E5-3600	\$55.00	24 - 36		
TK-E5-4000	\$55.00	28 - 40		
TK-E5-5000	\$26.75	34 - 50		
TK-E5-6500	\$55.00	45 - 65		
TK-E5-9500	\$55.00	65 - 95		
TK-E5-10500	\$55.00	85 - 105		
TK-E6-6500	\$94.50	45 - 65		100mm SC-E6 SC-E7
TK-E6-8000	\$94.50	53 - 80		
TK-E6-9500	\$94.50	65 - 95		
TK-E6-12500	\$94.50	85 - 125		
TK-E6-16000	\$94.50	110 - 160		

Fuji Duo Series Contactor and Overload Relay Selection Tables

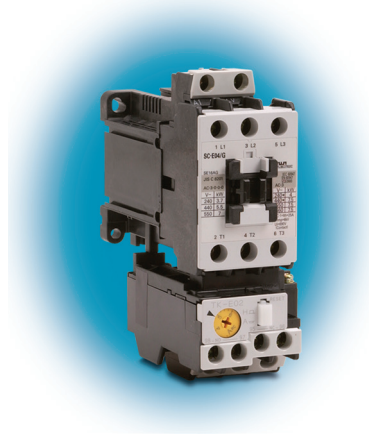
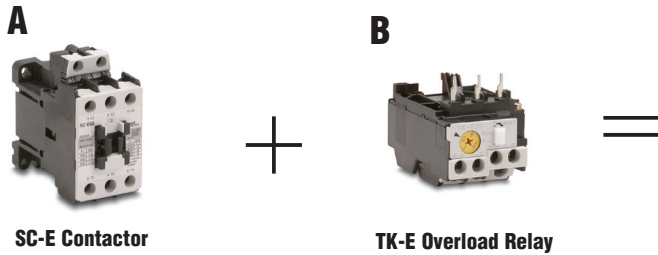

100-240V Single Phase Motor (1/3 to 25 hp)

Step 1. Select a contactor from page 17-32 based on motor voltage and horsepower.

Step 2. Select an overload relay from page 17-48 based on motor full load current.

Check the data plate on the motor for the hp, volts and full-rated amps.



Motor				
HP	5	Volts	460	Phase 3
RPM	1725	Amps	7.6	Hz 60
Design	B	AMB	40°C	Insul Class F
Duty	Cont	Encl	TEFC	Code K

Motor horsepower (points to HP 5)
 Motor voltage (points to Volts 460)
 Motor full-load rated amperage (FLA) (points to Amps 7.6)

Three Phase Motors - Refer to tables on following page

Step 1. Select a SC-E contactor from Column A based on motor voltage, and horsepower.

Step 2. Select a TK-E overload relay from Column B to work with the SC-E contactor selected in Step 1. The motor full load current (FLA) should be within the adjustable current range of the overload relay.

Fuji Duo Series Overload Relay Selection Tables

220-240V 3-Phase Motor (0.5 to 50 hp)¹

Overload Relay Selection for 220–240V 3-phase motors				
Motor Rating		A	B	
Motor HP	Motor Full Load Amperage (FLA) ²	Contactor	Overload Relay	
			Part Number	Adjustable Current Range
1/2	2.2	SC-E02-xxxx	TK-E02-260	1.7 to 2.6 Amps
3/4	3.5		TK-E02-420	2.8 to 4.2 Amps
1	4.2		TK-E02-600	4 to 6 Amps
1-1/2	6		TK-E02-800	5 to 8 Amps
2	6.8		TK-E02-900	6 to 9 Amps
3	9.6	SC-E03-xxxx	TK-E02-1300	9 to 13 Amps
5	15.2	SC-E04-xxxx	TK-E02-1800	12 to 18 Amps
7-1/2	22	SC-E05-xxxx	TK-E02-2500	20 to 25 Amps
10	28	SC-E1-xxxx	TK-E2-3600	24 to 36 Amps
15	42	SC-E2-xxxx	TK-E2-4200	32 to 42 Amps
20	54	SC-E3-xxxx	TK-E3-6500	45 to 65 Amps
25	68	SC-E4-xxxx	TK-E3-6800	48 to 68 Amps
30	80	SC-E5-xxxx	TK-E5-9500	65 to 95 Amps
40	104	SC-E6-xxxx	TK-E6-12500	85 to 125 Amps
50	130	SC-E7-xxxx	TK-E6-16000	110 to 160 Amps

Note 1: For 220-240 V three-phase motors up to 150 hp refer to the Fuji Odyssey series.
Note 2: Per NEC 2005 table 430.250

440-480V 3-Phase Motor (0.5 to 100 hp)¹

Overload Relay Selection for 440–480V 3-phase motors				
Motor Rating		A	B	
Motor HP	Motor Full Load Amperage (FLA) ²	Contactor	Overload Relay	
			Part Number	Adjustable Current Range
1/2	1.1	SC-E02-xxxx	TK-E02-145	0.95 to 1.45 Amps
3/4	1.6	SC-E02-xxxx	TK-E02-220	1.4 to 2.2 Amps
1	2.1	SC-E02-xxxx	TK-E02-260	1.7 to 2.6 Amps
1-1/2	3.0	SC-E02-xxxx	TK-E02-420	2.8 to 4.2 Amps
2	3.4	SC-E02-xxxx	TK-E02-420	2.8 to 4.2 Amps
3	4.8	SC-E02-xxxx	TK-E02-600	4 to 6 Amps
5	7.6	SC-E02-xxxx	TK-E02-900	6 to 9 Amps
7 1/2	11	SC-E03-xxxx	TK-E02-1300	9 to 13 Amps
10	14	SC-E04-xxxx	TK-E02-1800	12 to 18 Amps
15	21	SC-E05-xxxx	TK-E02-2500	20 to 25 Amps
20	27	SC-E1-xxxx	TK-E2-3600	24 to 36 Amps
25	34	SC-E1-xxxx	TK-E2-4200	32 to 42 Amps
30	40	SC-E2-xxxx	TK-E2-4200	32 to 42 Amps
40	52	SC-E3-xxxx	TK-E3-6500	45 to 65 Amps
50	65	SC-E4-xxxx	TK-E3-6800	48 to 68 Amps
60	77	SC-E5-xxxx	TK-E5-9500	65 to 95 Amps
75	96	SC-E6-xxxx	TK-E6-12500	85 to 125 Amps
100	124	SC-E7-xxxx	TK-E6-16000	110 to 160 Amps

Note 1: For 440-480 V three-phase motors up to 300 hp refer to the Fuji Odyssey series.
Note 2: Per NEC 2005 table 430.250

Fuji Duo Series Manual Motor Starters

BM3RHB-xxx Specifications



General Specifications: 45 mm Frame Width - BM3RHB-XXX Series												
Part Number	Price	Adjustable Current Range <i>I_e</i> : Min.-Max. (A)	UL/CSA 3-Phase HP Rating ¹				Instantaneous Trip Current (A)	UL/CSA Short Circuit Current Rating (kA) ²			Max. Listed Branch Circuit Protection - Fuse or MCCB (A) ²	
			200-208VAC	220-240VAC	440-480VAC	550-600VAC		240VAC	480VAC	600VAC		
BM3RHB-P16	\$49.50	0.1-0.16	Rated to motor full-load amperage				In accordance with motor full-load current	2.1	100	50	10	500
BM3RHB-P25	\$49.50	0.16-0.25						3.3	100	50	10	500
BM3RHB-P40	\$49.50	0.25-0.4						5.2	100	50	10	500
BM3RHB-P63	\$49.50	0.4-0.63						8.2	100	50	10	500
BM3RHB-001	\$49.50	0.63-1						1/2	13	100	50	10
BM3RHB-1P6	\$49.50	1-1.6	3/4	3/4	20.8	100	50	10	500			
BM3RHB-2P5	\$49.50	1.6-2.5	1/2	1/2	1	1-1/2	32.5	100	50	10	500	
BM3RHB-004	\$49.50	2.5-4	3/4	3/4	2	3	52	100	50	10	500	
BM3RHB-6P3	\$49.50	4-6.3	1	1-1/2	3	5	81.9	100	50	10	500	
BM3RHB-010	\$52.50	6.3-10	2	3	5	7-1/2	130	100	50	10	500	
BM3RHB-013	\$52.50	9-13	3	3	7-1/2	10	169	100	50	10	500	
BM3RHB-016	\$52.50	11-16	3	5	10	10	208	100	50	10	500	
BM3RHB-020	\$52.50	14-20	5	5	10	15	260	100	50	10	500	
BM3RHB-025	\$62.50	19-25	7-1/2	7-1/2	15	20	325	100	50	10	500	
BM3RHB-032	\$79.50	24-32	10	10	20	30	416	100	50	10	500	

Note 1: BM3RHB-xxx are cUL listed as HP rated motor controllers. Note 2: BM3RHB-xxx are cUL listed for group installation per NEC430-53(C).

General Specifications: 45 mm Frame Width - BM3RHB-XXX Series - continued		
Features	Adjustable thermal-magnetic trip type	
Number of Poles	3	
Handle Type	Rotary	
Rated Current <i>I_e</i> (A)	0.16 to 32	
Rated Operational Voltage <i>U_e</i> (V)	200 to 690	
Rated Frequency (Hz)	50/60	
Rated insulation Voltage <i>U_i</i> (V)	690	
Rated Impulse Withstand Voltage <i>U_{imp}</i> (kV)	6	
Utilization Category	IEC 60947-2 Circuit Breaker IEC 60947-4-1 Motor Starter	
Trip Class IEC 60947-4-1	10	
Instantaneous Trip Characteristic	13 x <i>I_e</i> max.	
Power Loss (total of 3-pole)	7W: <i>I_n</i> =0.16 to 25A 8.5W: <i>I_n</i> =32A	
Mechanical Durability (operations)	100,000: <i>I_n</i> =0.16 to 25A 70,000: <i>I_n</i> =32A	
Electrical Durability (operations)	100,000: <i>I_n</i> =0.16 to 25A 70,000: <i>I_n</i> =32A	
Max. Operations per Hour (motor start-up)	25	
Phase-loss Protection	Provided	
Trip Indicator	Provided	
Test Trip Function	Provided	
Dimensions (mm) WxHxD	45x90x79	
Weight (oz/g)	13.05 / 370	
Optional Accessories	Auxiliary Contact Block	Yes
	Alarm Contact Block	Yes
	Auxiliary and Alarm Contact Block	Yes
	Short-Circuit Alarm Contact Block	Yes
	Shunt Trip Device	Yes
	Undervoltage Trip Device	Yes
	External Operating Handle	Yes
Standards & Agency Approvals	IEC 60947-1, 60947-2, 60947-4-1, UL 508 file E163944, CSA C22.2 No.14 file 20479	

Fuji Duo Series Manual Motor Starters

BM3VHB-xxx Specifications

General Specifications: 55 mm Frame Width - BM3VHB-XXX Series											
Part Number	Price	Adjustable Current Range <i>I_e</i> : Min.-Max. (A)	UL/CSA 3-Phase hp Rating ¹				Instantaneous Trip Current (A)	UL/CSA Short Circuit Current Rating (kA) ²			Max. Listed Branch Circuit Protection - Fuse or MCCB (A) ³
			200-208VAC	220-240VAC	440-480VAC	550-600VAC		240VAC	480VAC	600VAC	
BM3VHB-010	\$122.50	6.3-10	2	3	5	7-1/2	130	100	50	10	600
BM3VHB-013	\$122.50	9-13	3	3	7-1/2	10	169	100	50	10	600
BM3VHB-016	\$122.50	11-16	3	5	10	10	208	100	50	10	600
BM3VHB-020	\$122.50	14-20	5	5	10	15	260	100	50	10	600
BM3VHB-025	\$142.00	19-25	7-1/2	7-1/2	15	20	325	100	50	10	600
BM3VHB-032	\$150.50	24-32	10	10	20	30	416	100	50	10	600
BM3VHB-040	\$150.50	28-40	10	10	30	30	520	100	50	10	600
BM3VHB-050	\$157.00	35-50	15	15	30	40	650	100	50	10	600
BM3VHB-063	\$157.00	45-63	20	20	40	60	819	100	50	10	600

Note 1: BM3VHB-xxx are cUL listed as HP rated motor controllers. **Note 2:** BM3VHB-xxx are cUL listed for group installation per NEC430-53(C).

General Specifications: 55 mm Frame Width - BM3VHB-XXX Series - continued		
Features	Adjustable thermal-magnetic trip type	
Number of Poles	3	
Handle Type	Rotary	
Rated Current <i>I_e</i> (A)	10 to 63	
Rated Operational Voltage <i>U_e</i> (V)	200 to 690	
Rated Frequency (Hz)	50/60	
Rated Insulation Voltage <i>U_i</i> (V)	1,000	
Rated Impulse Withstand Voltage <i>U_{imp}</i> (kV)	8	
Utilization Category	IEC 60947-2 Circuit Breaker Cat. A IEC 60947-4-1 Motor Starter AC-3	
Trip Class IEC 60947-4-1	10	
Instantaneous Trip Characteristic	13 x <i>I_e</i> max.	
Power Loss (total of 3-pole)	11W: <i>I_n</i> = 10 to 32A 15W: <i>I_n</i> = 40 to 50A 17W: <i>I_n</i> = 63A	
Mechanical Durability (operations)	50,000	
Electrical Durability (operations)	25,000	
Max. Operations per Hour (motor start-up)	25	
Phase-Loss Protection	Provided	
Trip Indicator	Provided	
Test Trip Function	Provided	
Dimensions (mm) WxHxD	55x110x96	
Weight (oz/g)	27.51 / 780	
Optional Accessories	Auxiliary Contact Block	Yes
	Alarm Contact Block	Yes
	Auxiliary and Alarm Contact Block	Yes
	Short-Circuit Alarm Contact Block	Yes
	Shunt Trip Device	Yes
	Undervoltage Trip Device	Yes
External Operating Handle	Yes	
Standards & Agency Approvals	IEC 60947-1, 60947-2, 60947-4-1, UL 508 file E163944, CSA C22.2 No.14 file 20479	

Fuji Duo Series Manual Motor Starters

DIN-rail mounting

The MMS can be mounted to a 35 mm DIN rail. Secure the rail with screws at mounting pitch of less than 400 mm for the BM3R type and less than 300 mm for the BM3V type.

Applicable rail:

Use a 15 mm-high DIN rail, such as our DN-R35HS1, which conforms to EN-50022 and IEC715.

The standard DIN rail mounting direction is horizontal. When using the MMS on vertically mounted DIN rail, use end clamps.

Screw mounting

The separately sold push-in lug (BZOSET) is required for screw mounting the BM3R frame. The BM3V frame can be screw mounted directly to the panel.

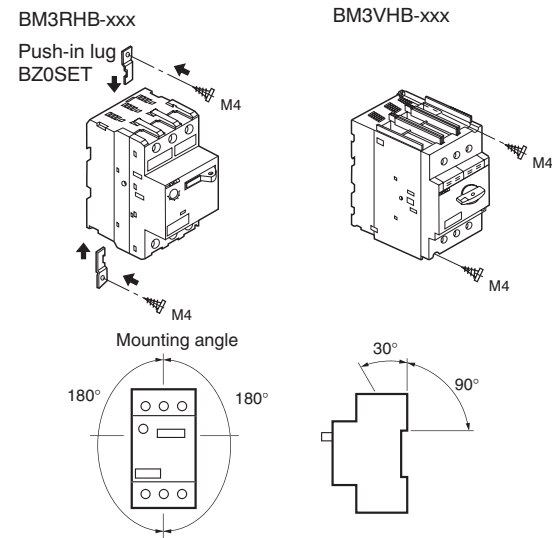
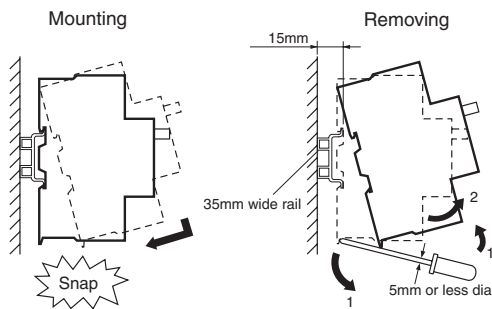

Wiring

While pressing the wire with a screwdriver, tighten the screw to the specified tightening torque.

Environmental Specifications		
Ambient Temperature	Operating: -5 to +55°C Storage: -40 to +65°C	No sudden temperature changes resulting in condensation or icing.
Humidity	45 to 85%RH	
Altitude	2000m or lower	
Atmosphere	No excessive dust, smoke, corrosive gases, flammable gases, steam or salt.	
Vibration	10 to 55Hz 15m/s2	No abnormal shock or vibration.
Shock	50m/s2	

Wiring Specifications

Wire Size and Tightening Torque			
Type	BM3RHB-XXX	BM3VHB-XXX	BZO Accessories
Solid Wire (mm)	1.6 to 2.6 dia.	1.6 to 2.6 dia.	1 to 1.6 dia.
Stranded Wire (mm²)	Single-wire 1 to 10 1 to 6	Single-wire 1 to 25 1 to 16	2-wire 0.5 to 2.5 0.5 to 2.5
AWG	Single-wire 18 to 8 18 to 10	2-wire 18 to 4 18 to 4	18 to 14 18 to 14
Sheath Stripping Length (mm)	Approx.10	Approx.13	Approx.10
Terminal Screw	Pan head screw (PZ2) M4	Pan head screw (PZ2) M6	Pan head screw (PZ2) M3.5
Tightening Torque (N·m)	2	4	0.8

Note: There is no need for a crimp terminal or any other terminal on the end of the connection wire.

Arc Space Requirements

Arc Space Requirements			
Part Number	Rated operational voltage Ue (V)	Minimum distance to grounded metal (mm)	
		A,B	C,D
BM3RHB-XXX	Up to 500	15	30
	Up to 690	40	50
BM3VHB-XXX	Up to 500	15	40
	Up to 690	40	50

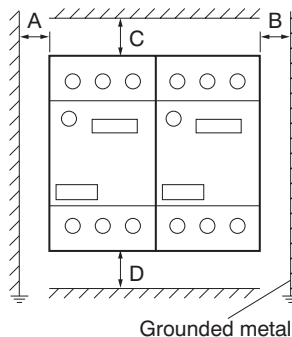

When frames are mounted side-by-side, operating conditions such as a high ambient temperature or using the maximum setting for continuous carrying current may cause slight changes in operating characteristics due to temperature rises. Under such conditions, it is recommended that the frames be separated by at least 5mm.

Fuji Duo Series Combination Starter Selection Table - 45 mm

Use this selection table to select 45 mm frame width (A) Manual Motor Starter, (B) Contactor, (C) Link Module, and (D) Base Plate for a Combination Starter

Combination Starter Selection Table - 45 mm										
Three Phase Motor				Manual Motor Starter Adjustable Current Range (A)	A	B	C	D	SCCR at 480Y/277 VAC (kA) type F coordination	
220-240 Volt		440-480 Volt								
Motor Horsepower (hp) See Note 1 below	Motor Full-Load Amperage (FLA) See Note 4 below	Motor Horsepower (hp) See Note 1 below	Motor Full-Load Amperage (FLA) See Note 4 below		Manual Motor Starter See Note 2 below for UL Type E applications.	Contactor The contactor part number needs the coil voltage suffix. See Note 3 below.	Link Module	Base Plate		
-	-	-	-	0.1 to 0.16	BM3RHB-P16	SC-E02-110VAC SC-E02G-24VDC	BZOLRE22AA BZOLRE22GA	BZ0BPRE22A	65	
-	-	-	-	0.16 to 0.25	BM3RHB-P25	SC-E02-110VAC SC-E02G-24VDC	BZOLRE22AA BZOLRE22GA		65	
-	-	-	-	0.25 to 0.4	BM3RHB-P40	SC-E02-110VAC SC-E02G-24VDC	BZOLRE22AA BZOLRE22GA		65	
-	-	-	-	0.4 to 0.63	BM3RHB-P63	SC-E02-110VAC SC-E02G-24VDC	BZOLRE22AA BZOLRE22GA		65	
-	-	-	-	0.63 to 1.0	BM3RHB-001	SC-E02-110VAC SC-E02G-24VDC	BZOLRE22AA BZOLRE22GA		65	
-	-	0.75	1.6	1.0 to 1.6	BM3RHB-1P6	SC-E02-110VAC SC-E02G-24VDC	BZOLRE22AA BZOLRE22GA		65	
0.5	2.2	1	2.1	1.6 to 2.5	BM3RHB-2P5	SC-E02-110VAC SC-E02G-24VDC	BZOLRE22AA BZOLRE22GA		65	
0.75	3.2	2	3.4	2.5 to 4.0	BM3RHB-004	SC-E02-110VAC SC-E02G-24VDC	BZOLRE22AA BZOLRE22GA		65	
1.5	6	3	4.8	4.0 to 6.3	BM3RHB-6P3	SC-E02-110VAC SC-E02G-24VDC	BZOLRE22AA BZOLRE22GA		65	
-	-	5	7.6	6.3 to 10	BM3RHB-010	SC-E02-110VAC SC-E02G-24VDC	BZOLRE22AA BZOLRE22GA		65	
3	9.6	7.5	11	9 to 13	BM3RHB-013	SC-E03-110VAC SC-E03G-24VDC	BZOLRE22AA BZOLRE22GA		65	
5	15.2	10	14	11 to 16	BM3RHB-016	SC-E04-110VAC SC-E04G-24VDC	BZOLRE22AA BZOLRE22GA		65	
5	15.2	10	14	14 to 20	BM3RHB-020	SC-E04-110VAC SC-E04G-24VDC	BZOLRE22AA BZOLRE22GA		65	
7.5	22	15	21	19 to 25	BM3RHB-025	SC-E05-110VAC SC-E05G-24VDC	BZOLRE22AA BZOLRE22GA		50	
10	28	20	27	24 to 32	BM3RHB-032	SC-E1-110VAC SC-E1G-24VDC	BZOLRE32AA BZOLRE32GA		BZ0BPRE32A	50

Note 1: When a horsepower rating is listed on two rows, the motor full-load amperage must be known so you can select the MMS with the best adjustable current range for your application. For example, if you have a 230V, 5 hp, 15.2A motor, you can select a MMS with either a 11-16A range or a 14-20A range. Consult the motor data plate or motor manufacturer.

Note 2: When using BM3RHB-xxx MMS in a UL Type E application, you must also use part numbers BZ0TKUAB (short-circuit contact block) and BZ0TCRE (line side terminal cover).

Note 3: For AC coil voltages other than 110VAC, substitute the "110VAC" in the part number with "220VAC" for 220/240VAC coils or "24VAC" for 24VAC coils. For example, if the table lists a SC-E02-110VAC contactor for your application and you need a contactor with a 220VAC coil, use contactor SC-E02-220VAC.

Note 4: Per NEC 2005 Table 430.250

Fuji Duo Series Combination Starter Selection Table - 55 mm



Use this selection table to select 55 mm frame width (A) Manual Motor Starter, (B) Contactor, (C) Link Module, and (D) Base Plate for a Combination Starter

Combination Starter Selection Table - 55 mm																	
Three Phase Motor					A	B	C	D									
220-240 Volt		440-480 Volt															
Motor horsepower (hp) See Note 1 below	Motor Full-Load Amperage (FLA) See Note 4 below	Motor Horsepower (hp) See Note 1 below	Motor Full-Load Amperage (FLA) See Note 4 below	Manual Motor Starter Adjustable Current Range (A)	Manual Motor Starter See Note 2 below for UL Type E applications.	Contactor The contactor part number needs the coil voltage suffix. See Note 3 below.	Link Module	Base Plate	SCCR at 480Y/277 VAC (kA) type F coordination								
3	9.6	5	7.6	6.3 to 10	BM3VHB-010	SC-E1-110VAC	BZ0LVE51AA	BZ0BPVE51A	65								
						SC-E1G-24VDC				BZ0LVE51GA							
3	9.6	7.5	11	9 to 13	BM3VHB-013	SC-E1-110VAC	BZ0LVE51AA			BZ0BPVE51A	65						
						SC-E1G-24VDC						BZ0LVE51GA					
5	15.2	10	14	11 to 16	BM3VHB-016	SC-E1-110VAC	BZ0LVE51AA					BZ0BPVE51A	65				
						SC-E1G-24VDC								BZ0LVE51GA			
5	15.2	10	14	14 to 20	BM3VHB-020	SC-E1-110VAC	BZ0LVE51AA							BZ0BPVE51A	65		
						SC-E1G-24VDC										BZ0LVE51GA	
7.5	22	15	21	19 to 25	BM3VHB-025	SC-E1-110VAC	BZ0LVE51AA									BZ0BPVE51A	65
						SC-E1G-24VDC											
10	28	20	27	24 to 32	BM3VHB-032	SC-E1-110VAC	BZ0LVE51AA	BZ0BPVE51A	65								
						SC-E1G-24VDC											
10	28	30	40	28 to 40	BM3VHB-040	SC-E2-110VAC	BZ0LVE51AA			BZ0BPVE51A	65						
						SC-E2G-24VDC											
15	42	30	40	35 to 50	BM3VHB-050	SC-E2S-110VAC	BZ0LVE51AA					BZ0BPVE51A	65				
						SC-E2SG-24VDC											
20	54	40	52	45 to 63	BM3VHB-063	SC-E3-110VAC	BZ0LVE65AA							BZ0BPVE65A	65		
						SC-E3G-24VDC											

Note 1: When a horsepower rating is listed on two rows, the motor full-load amperage must be known so you can select the MMS with the best adjustable current range for your application. For example, if you have a 230V, 10 hp, 28A motor, you can select a MMS with either a 24-32A range or a 28-40A range. Consult the motor data plate or motor manufacturer.

Note 2: When using BM3VHB-xxx MMS in a UL Type E application, you must also use part number BZ0TKUAB (short-circuit contact block).

Note 3: For AC coil voltages other than 110VAC, substitute the "110VAC" in the part number with "220VAC" for 220/240VAC coils or "24VAC" for 24VAC coils. For example, if the table lists a SC-E1-110VAC contactor for your application and you need a contactor with a 220VAC coil, use contactor SC-E1-220VAC.

Note 4: Per NEC 2005 Table 430.250