

# 8086 assembler tutorial for beginners (part 1)

This tutorial is intended for those who are not familiar with assembler at all, or have a very distant idea about it. of course if you have knowledge of some other programming language (basic, c/c++, pascal...) that may help you a lot. but even if you are familiar with assembler, it is still a good idea to look through this document in order to study `emu8086` syntax. It is assumed that you have some knowledge about number representation (hex/bin), if not it is highly recommended to study [numbering systems tutorial](#) before you proceed.

## what is assembly language?

assembly language is a low level programming language. you need to get some knowledge about computer structure in order to understand anything. the simple computer model as i see it:

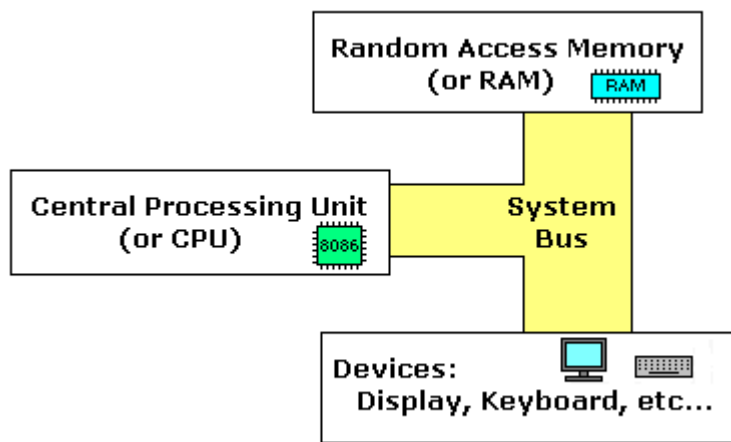

the **system bus** (shown in yellow) connects the various components of a computer.

the **CPU** is the heart of the computer, most of computations occur inside the **CPU**.

**RAM** is a place to where the programs are loaded in order to be executed.

## inside the cpu

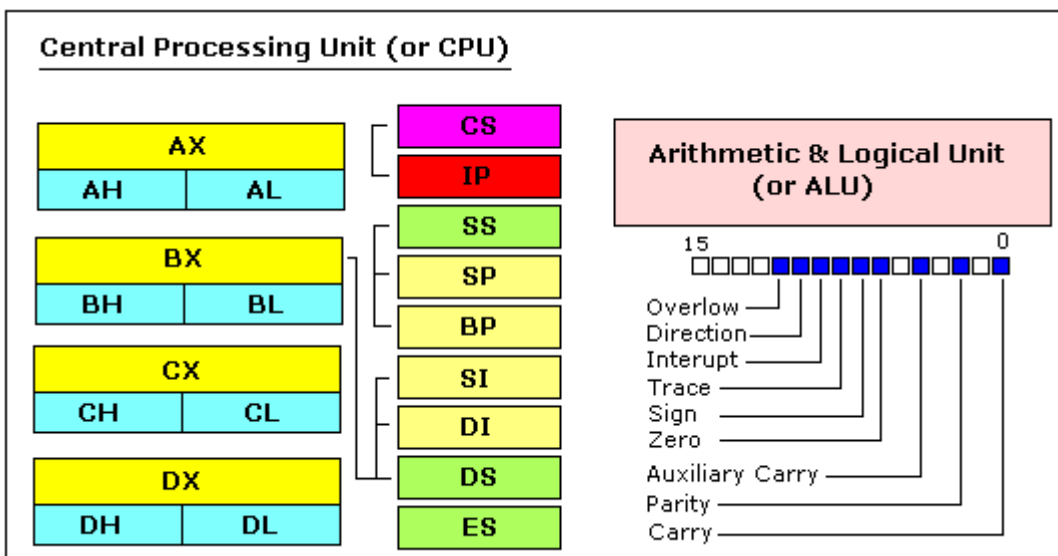

## general purpose registers

8086 CPU has 8 general purpose registers, each register has its own name:

- **AX** - the accumulator register (divided into **AH / AL**).
- **BX** - the base address register (divided into **BH / BL**).
- **CX** - the count register (divided into **CH / CL**).
- **DX** - the data register (divided into **DH / DL**).
- **SI** - source index register.
- **DI** - destination index register.
- **BP** - base pointer.
- **SP** - stack pointer.

despite the name of a register, it's the programmer who determines the usage for each general purpose register. the main purpose of a register is to keep a number (variable). the size of the above registers is 16 bit, it's something like: **0011000000111001b** (in binary form), or **12345** in decimal (human) form.

4 general purpose registers (AX, BX, CX, DX) are made of two separate 8 bit registers, for example if AX= **0011000000111001b**, then AH=**00110000b** and AL=**00111001b**. therefore, when you modify any of the 8 bit registers 16 bit register is also updated, and vice-versa. the same is for other 3 registers, "H" is for high and "L" is for low part.

because registers are located inside the CPU, they are much faster than memory. Accessing a memory location requires the use of a system bus, so it takes much longer. Accessing data in a register usually takes no time. therefore, you should try to keep variables in the registers. register sets are very small and most registers have special purposes which limit their use as variables, but they are still an excellent place to store temporary data of calculations.

## segment registers

- **CS** - points at the segment containing the current program.
- **DS** - generally points at segment where variables are defined.
- **ES** - extra segment register, it's up to a coder to define its usage.
- **SS** - points at the segment containing the stack.

although it is possible to store any data in the segment registers, this is never a good idea. the segment registers have a very special purpose - pointing at accessible blocks of memory.

segment registers work together with general purpose register to access any memory value. For example if we would like to access memory at the physical address **12345h** (hexadecimal), we should set the **DS = 1230h** and **SI = 0045h**. This is good, since this way we can access much more memory than with a single register that is limited to 16 bit values.

CPU makes a calculation of physical address by multiplying the segment register by 10h and adding general purpose register to it ( $1230h * 10h + 45h$ )

= 12345h):

$$\begin{array}{r} 12300 \\ + 0045 \\ \hline 12345 \end{array}$$

the address formed with 2 registers is called an **effective address**.

by default **BX**, **SI** and **DI** registers work with **DS** segment register;

**BP** and **SP** work with **SS** segment register.

other general purpose registers cannot form an effective address!

also, although **BX** can form an effective address, **BH** and **BL** cannot.

### special purpose registers

- **IP** - the instruction pointer.
- **flags register** - determines the current state of the microprocessor.

**IP** register always works together with **CS** segment register and it points to currently executing instruction.

**flags register** is modified automatically by CPU after mathematical operations, this allows to determine the type of the result, and to determine conditions to transfer control to other parts of the program.

generally you cannot access these registers directly, the way you can access AX and other general registers, but it is possible to change values of system registers using some tricks that you will learn a little bit later.

# Memory Access

to access memory we can use these four registers: **BX, SI, DI, BP**. combining these registers inside [ ] symbols, we can get different memory locations. these combinations are supported (addressing modes):

[BX + SI] [BX + DI] [BP + SI] [BP + DI]	[SI] [DI] d16 (variable offset only) [BX]	[BX + SI + d8] [BX + DI + d8] [BP + SI + d8] [BP + DI + d8]
[SI + d8] [DI + d8] [BP + d8] [BX + d8]	[BX + SI + d16] [BX + DI + d16] [BP + SI + d16] [BP + DI + d16]	[SI + d16] [DI + d16] [BP + d16] [BX + d16]

**d8** - stays for 8 bit signed immediate displacement (for example: 22, 55h, -1, etc...)

**d16** - stays for 16 bit signed immediate displacement (for example: 300, 5517h, -259, etc...).

displacement can be a immediate value or offset of a variable, or even both. if there are several values, assembler evaluates all values and calculates a single immediate value..

displacement can be inside or outside of the [ ] symbols, assembler generates the same machine code for both ways.

displacement is a **signed** value, so it can be both positive or negative.

generally the compiler takes care about difference between **d8** and **d16**, and generates the required machine code.

for example, let's assume that **DS = 100, BX = 30, SI = 70**.

The following addressing mode: **[BX + SI] + 25**

is calculated by processor to this physical address: **100 \* 16 + 30 + 70 + 25 = 1725**.

by default **DS** segment register is used for all modes except those with **BP** register, for these **SS** segment register is used.

there is an easy way to remember all those possible combinations using this chart:

BX	SI	+ disp
BP	DI	

you can form all valid combinations by taking only one item from each column or skipping the column by not taking anything from it. as you see **BX** and **BP** never go together. **SI** and **DI** also don't go together. here are an examples of a valid addressing modes: **[BX+5]** , **[BX+SI]** , **[DI+BX-4]**

---

the value in segment register (CS, DS, SS, ES) is called a **segment**, and the value in purpose register (BX, SI, DI, BP) is called an **offset**. When DS contains value **1234h** and SI contains the value **7890h** it can be also recorded as **1234:7890**. The physical address will be  $1234h * 10h + 7890h = 19BD0h$ .

if zero is added to a decimal number it is multiplied by 10, however **10h = 16**, so if zero is added to a hexadecimal value, it is multiplied by 16, for example:

7h = 7  
70h = 112

---

in order to say the compiler about data type, these prefixes should be used:

**byte ptr** - for byte.  
**word ptr** - for word (two bytes).

for example:

byte ptr [BX] ; byte access.  
or  
word ptr [BX] ; word access.

assembler supports shorter prefixes as well:

**b.** - for **byte ptr**  
**w.** - for **word ptr**

in certain cases the assembler can calculate the data type automatically.

---

# MOV instruction

- copies the **second operand** (source) to the **first operand** (destination).
- the source operand can be an immediate value, general-purpose register or memory location.
- the destination register can be a general-purpose register, or memory location.
- both operands must be the same size, which can be a byte or a word.

these types of operands are supported:

MOV REG, memory  
MOV memory, REG  
MOV REG, REG  
MOV memory, immediate  
MOV REG, immediate

**REG:** AX, BX, CX, DX, AH, AL, BL, BH, CH, CL, DH, DL, DI, SI, BP, SP.

**memory:** [BX], [BX+SI+7], variable, etc...

**immediate:** 5, -24, 3Fh, 10001101b, etc...

for segment registers only these types of **MOV** are supported:

MOV SREG, memory  
MOV memory, SREG  
MOV REG, SREG  
MOV SREG, REG

**SREG:** DS, ES, SS, and only as second operand: CS.

**REG:** AX, BX, CX, DX, AH, AL, BL, BH, CH, CL, DH, DL, DI, SI, BP, SP.

**memory:** [BX], [BX+SI+7], variable, etc...

The **MOV** instruction cannot be used to set the value of the **CS** and **IP** registers.

here is a short program that demonstrates the use of **MOV** instruction:

```
ORG 100h      ; this directive required for a simple 1 segment .com program.
MOV AX, 0B800h ; set AX to hexadecimal value of B800h.
MOV DS, AX    ; copy value of AX to DS.
MOV CL, 'A'   ; set CL to ASCII code of 'A', it is 41h.
MOV CH, 1101_1111b ; set CH to binary value.
MOV BX, 15Eh  ; set BX to 15Eh.
MOV [BX], CX ; copy contents of CX to memory at B800:015E
RET          ; returns to operating system.
```

you can **copy & paste** the above program to emu8086 code editor, and press [**Compile and Emulate**] button (or press **F5** key on your keyboard).

the emulator window should open with this program loaded, click [**Single Step**] button and watch the register values.

how to do **copy & paste**:

1. select the above text using mouse, click before the text and drag it down until everything is selected.
2. press **Ctrl + C** combination to copy.
3. go to emu8086 source editor and press **Ctrl + V** combination to paste.

as you may guess, ";" is used for comments, anything after ";" symbol is ignored by compiler.

you should see something like that when program finishes:

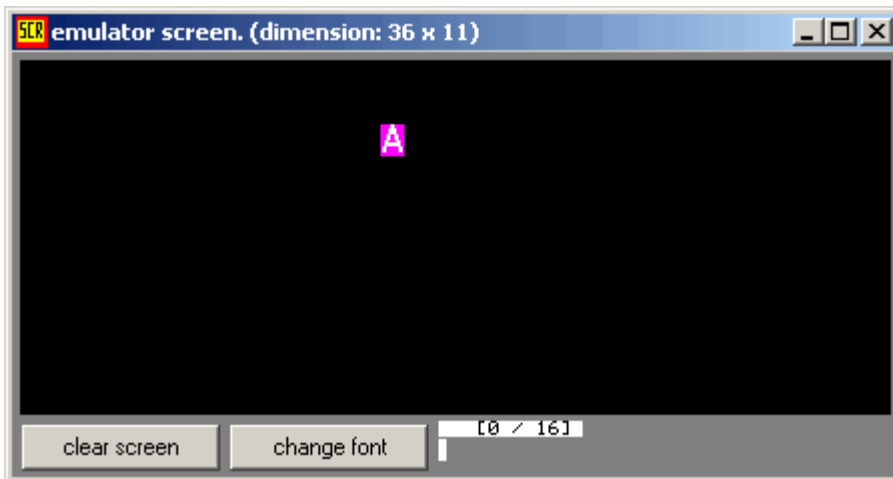

actually the above program writes directly to video memory, so you may see that **MOV** is a very powerful instruction

# Variables

---

Variable is a memory location. For a programmer it is much easier to have some value be kept in a variable named "**var1**" then at the address 5A73:235B, especially when you have 10 or more variables.

Our compiler supports two types of variables: **BYTE** and **WORD**.

Syntax for a variable declaration:

*name* **DB** *value*

*name* **DW** *value*

**DB** - stays for Define Byte.

**DW** - stays for Define Word.

*name* - can be any letter or digit combination, though it should start with a letter. It's possible to declare unnamed variables by not specifying the name (this variable will have an address but no name).

*value* - can be any numeric value in any supported numbering system (hexadecimal, binary, or decimal), or "?" symbol for variables that are not initialized.

As you probably know from *part 2* of this tutorial, **MOV** instruction is used to copy values from source to destination.

Let's see another example with **MOV** instruction:

```
ORG 100h

MOV AL, var1
MOV BX, var2

RET ; stops the program.

VAR1 DB 7
var2 DW 1234h
```

Copy the above code to emu8086 source editor, and press **F5** key to compile and load it in the emulator. You should get something like:



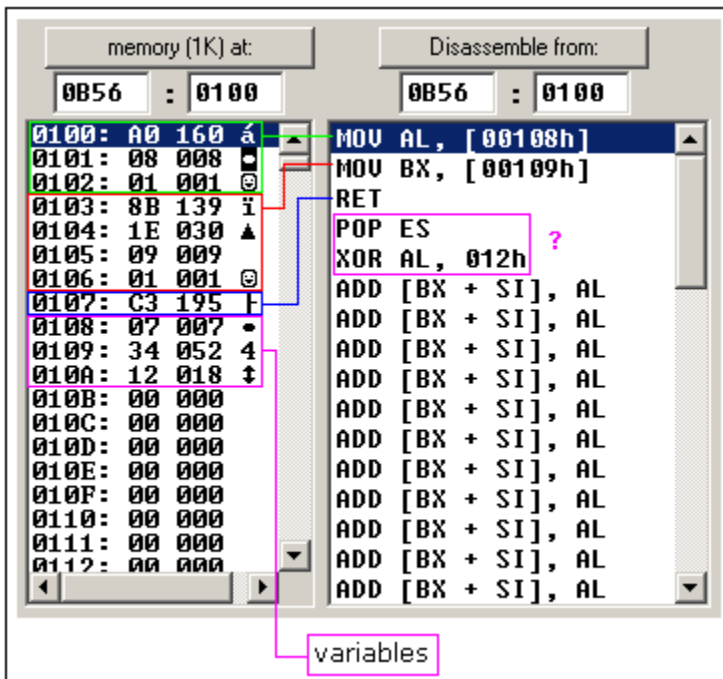

As you see this looks a lot like our example, except that variables are replaced with actual memory locations. When compiler makes machine code, it automatically replaces all variable names with their **offsets**. By default segment is loaded in **DS** register (when **COM** files is loaded the value of **DS** register is set to the same value as **CS** register - code segment).

In memory list first row is an **offset**, second row is a **hexadecimal value**, third row is **decimal value**, and last row is an **ASCII** character value.

Compiler is not case sensitive, so "**VAR1**" and "**var1**" refer to the same variable.

The offset of **VAR1** is **0108h**, and full address is **0B56:0108**.

The offset of **var2** is **0109h**, and full address is **0B56:0109**, this variable is a **WORD** so it occupies **2 BYTES**. It is assumed that low byte is stored at lower address, so **34h** is located before **12h**.

You can see that there are some other instructions after the **RET** instruction, this happens because disassembler has no idea about where the data starts, it just processes the values in memory and it understands them as valid 8086 instructions (we will learn them later).

You can even write the same program using **DB** directive only:

```
ORG 100h ; just a directive to make a simple .com file
(expands into no code).
```

```
DB 0A0h
DB 08h
DB 01h
```

```
DB 8Bh
DB 1Eh
DB 09h
DB 01h

DB 0C3h

DB 7

DB 34h
DB 12h
```

Copy the above code to emu8086 source editor, and press **F5** key to compile and load it in the emulator. You should get the same disassembled code, and the same functionality!

As you may guess, the compiler just converts the program source to the set of bytes, this set is called **machine code**, processor understands the **machine code** and executes it.

**ORG 100h** is a compiler directive (it tells compiler how to handle the source code). This directive is very important when you work with variables. It tells compiler that the executable file will be loaded at the **offset** of 100h (256 bytes), so compiler should calculate the correct address for all variables when it replaces the variable names with their **offsets**. Directives are never converted to any real **machine code**.

Why executable file is loaded at **offset** of **100h**? Operating system keeps some data about the program in the first 256 bytes of the **CS** (code segment), such as command line parameters and etc.

Though this is true for **COM** files only, **EXE** files are loaded at offset of **0000**, and generally use special segment for variables. Maybe we'll talk more about **EXE** files later.

---

## Arrays

Arrays can be seen as chains of variables. A text string is an example of a byte array, each character is presented as an ASCII code value (0..255).

Here are some array definition examples:

```
a DB 48h, 65h, 6Ch, 6Ch, 6Fh, 00h
b DB 'Hello', 0
```

*b* is an exact copy of the *a* array, when compiler sees a string inside quotes it automatically converts it to set of bytes. This chart shows a part of the memory where these arrays are declared:

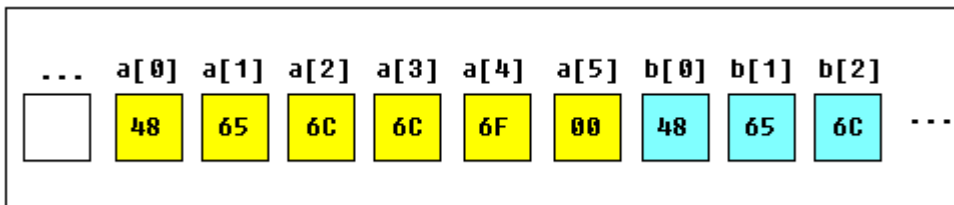

You can access the value of any element in array using square brackets, for example:

```
MOV AL, a[3]
```

You can also use any of the memory index registers **BX, SI, DI, BP**, for example:

```
MOV SI, 3
MOV AL, a[SI]
```

If you need to declare a large array you can use **DUP** operator. The syntax for **DUP**:

number DUP ( value(s) )  
number - number of duplicate to make (any constant value).  
value - expression that DUP will duplicate.

for example:

```
c DB 5 DUP(9)
```

is an alternative way of declaring:

```
c DB 9, 9, 9, 9, 9
```

one more example:

```
d DB 5 DUP(1, 2)
```

is an alternative way of declaring:

```
d DB 1, 2, 1, 2, 1, 2, 1, 2, 1, 2
```

Of course, you can use **DW** instead of **DB** if it's required to keep values larger than 255, or smaller than -128. **DW** cannot be used to declare strings.

## Getting the Address of a Variable

There is **LEA** (Load Effective Address) instruction and alternative **OFFSET** operator. Both **OFFSET** and **LEA** can be used to get the offset address of the variable.

**LEA** is more powerful because it also allows you to get the address of an indexed variables. Getting the address of the variable can be very useful in some situations, for example when you need to pass parameters to a procedure.

## Reminder:

In order to tell the compiler about data type, these prefixes should be used:

**BYTE PTR** - for byte.

**WORD PTR** - for word (two bytes).

For example:

BYTE PTR [BX] ; byte access.

or

WORD PTR [BX] ; word access.

emu8086 supports shorter prefixes as well:

**b.** - for **BYTE PTR**

**w.** - for **WORD PTR**

in certain cases the assembler can calculate the data type automatically.

---

Here is first example:

```
ORG 100h

MOV AL, VAR1 ; check value of VAR1 by
moving it to AL.

LEA BX, VAR1 ; get address of VAR1 in BX.

MOV BYTE PTR [BX], 44h ; modify the contents of
VAR1.

MOV AL, VAR1 ; check value of VAR1 by
moving it to AL.

RET

VAR1 DB 22h

END
```

Here is another example, that uses **OFFSET** instead of **LEA**:

```
ORG 100h

MOV AL, VAR1 ; check value of VAR1 by
moving it to AL.

MOV BX, OFFSET VAR1 ; get address of VAR1
in BX.

MOV BYTE PTR [BX], 44h ; modify the contents of
VAR1.
```

```
MOV AL, VAR1 ; check value of VAR1 by
moving it to AL.

RET

VAR1 DB 22h

END
```

Both examples have the same functionality.

These lines:

```
LEA BX, VAR1
```

```
MOV BX, OFFSET VAR1
```

are even compiled into the same machine code: `MOV BX, num`  
*num* is a 16 bit value of the variable offset.

Please note that only these registers can be used inside square brackets (as memory pointers): **BX, SI, DI, BP!**  
(see previous part of the tutorial).

---

## Constants

Constants are just like variables, but they exist only until your program is compiled (assembled). After definition of a constant its value cannot be changed. To define constants **EQU** directive is used:

```
name EQU < any expression >
```

For example:

```
k EQU 5

MOV AX, k
```

The above example is functionally identical to code:

```
MOV AX, 5
```

---

You can view variables while your program executes by selecting "**Variables**" from the "**View**" menu of emulator.

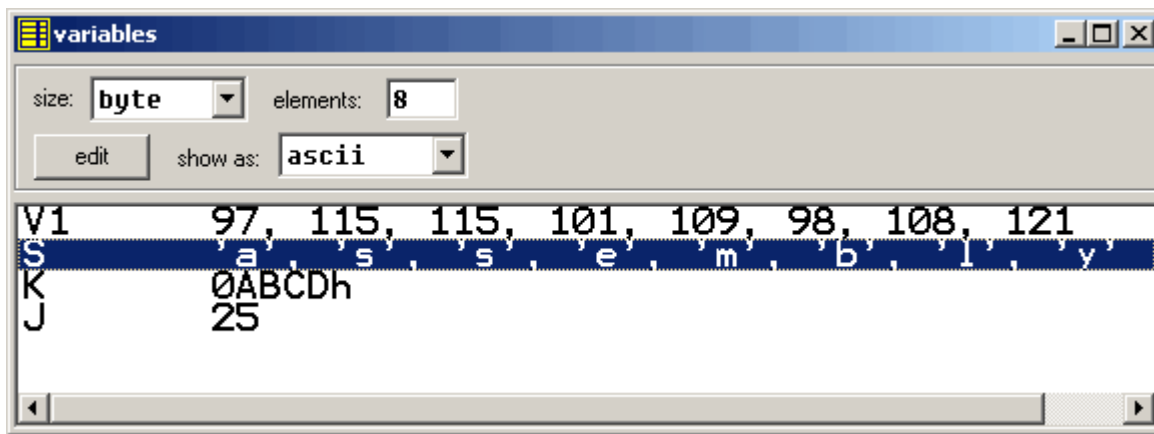

To view arrays you should click on a variable and set **Elements** property to array size. In assembly language there are not strict data types, so any variable can be presented as an array.

Variable can be viewed in any numbering system:

- **HEX** - hexadecimal (base 16).
- **BIN** - binary (base 2).
- **OCT** - octal (base 8).
- **SIGNED** - signed decimal (base 10).
- **UNSIGNED** - unsigned decimal (base 10).
- **CHAR** - ASCII char code (there are 256 symbols, some symbols are invisible).

You can edit a variable's value when your program is running, simply double click it, or select it and click **Edit** button.

It is possible to enter numbers in any system, hexadecimal numbers should have "**h**" suffix, binary "**b**" suffix, octal "**o**" suffix, decimal numbers require no suffix. String can be entered this way:

**'hello world', 0**

(this string is zero terminated).

Arrays may be entered this way:

**1, 2, 3, 4, 5**

(the array can be array of bytes or words, it depends whether **BYTE** or **WORD** is selected for edited variable).

Expressions are automatically converted, for example:

when this expression is entered:

**5 + 2**

it will be converted to **7** etc...

# Interrupts

---

Interrupts can be seen as a number of functions. These functions make the programming much easier, instead of writing a code to print a character you can simply call the interrupt and it will do everything for you. There are also interrupt functions that work with disk drive and other hardware. We call such functions **software interrupts**.

Interrupts are also triggered by different hardware, these are called **hardware interrupts**. Currently we are interested in **software interrupts** only.

To make a **software interrupt** there is an **INT** instruction, it has very simple syntax:

## **INT value**

Where **value** can be a number between 0 to 255 (or 0 to 0FFh), generally we will use hexadecimal numbers.

You may think that there are only 256 functions, but that is not correct. Each interrupt may have sub-functions.

To specify a sub-function **AH** register should be set before calling interrupt. Each interrupt may have up to 256 sub-functions (so we get  $256 * 256 = 65536$  functions). In general **AH** register is used, but sometimes other registers maybe in use. Generally other registers are used to pass parameters and data to sub-function.

The following example uses **INT 10h** sub-function **0Eh** to type a "Hello!" message. This functions displays a character on the screen, advancing the cursor and scrolling the screen as necessary.

```
ORG 100h ; directive to make a simple .com file.
```

```
; The sub-function that we are using  
; does not modify the AH register on  
; return, so we may set it only once.
```

```
MOV AH, 0Eh ; select sub-function.
```

```
; INT 10h / 0Eh sub-function  
; receives an ASCII code of the
```

```
; character that will be printed
; in AL register.

MOV AL, 'H' ; ASCII code: 72
INT 10h ; print it!

MOV AL, 'e' ; ASCII code: 101
INT 10h ; print it!

MOV AL, 'l' ; ASCII code: 108
INT 10h ; print it!

MOV AL, 'l' ; ASCII code: 108
INT 10h ; print it!

MOV AL, 'o' ; ASCII code: 111
INT 10h ; print it!

MOV AL, '!' ; ASCII code: 33
INT 10h ; print it!

RET ; returns to operating system.
```

Copy & paste the above program to emu8086 source code editor, and press [**Compile and Emulate**] button. Run it!

See [list of supported interrupts](#) for more information about interrupts.

## Library of common functions - emu8086.inc

---

To make programming easier there are some common functions that can be included in your program. To make your program use functions defined in other file you should use the **INCLUDE** directive followed by a file name. Compiler automatically searches for the file in the same folder where the source file is located, and if it cannot find the file there - it searches in **Inc** folder.

Currently you may not be able to fully understand the contents of the **emu8086.inc** (located in **Inc** folder), but it's OK, since you only need to understand what it can do.

To use any of the functions in **emu8086.inc** you should have the following line in the beginning of your source file:

```
include 'emu8086.inc'
```

---

**emu8086.inc** defines the following **macros**:



- **PUTC char** - macro with 1 parameter, prints out an ASCII char at current cursor position.
- **GOTOXY col, row** - macro with 2 parameters, sets cursor position.
- **PRINT string** - macro with 1 parameter, prints out a string.
- **PRINTN string** - macro with 1 parameter, prints out a string. The same as PRINT but automatically adds "carriage return" at the end of the string.
- **CURSOROFF** - turns off the text cursor.
- **CURSORON** - turns on the text cursor.

To use any of the above macros simply type its name somewhere in your code, and if required parameters, for example:

```
include emu8086.inc

ORG 100h

PRINT 'Hello World!'

GOTOXY 10, 5

PUTC 65      ; 65 - is an ASCII code for 'A'
PUTC 'B'

RET          ; return to operating system.
END          ; directive to stop the compiler.
```

When compiler process your source code it searches the **emu8086.inc** file for declarations of the macros and replaces the macro names with real code. Generally macros are relatively small parts of code, frequent use of a macro may make your executable too big (procedures are better for size optimization).

---

**emu8086.inc** also defines the following **procedures**:

- **PRINT\_STRING** - procedure to print a null terminated string at current cursor position, receives address of string in **DS:SI** register. To use it declare: **DEFINE\_PRINT\_STRING** before **END** directive.
- **PTHIS** - procedure to print a null terminated string at current cursor position (just as PRINT\_STRING), but receives address of string from Stack. The ZERO TERMINATED string should be defined just after the CALL instruction. For example:

```
CALL PTHIS
db 'Hello World!', 0
```

To use it declare: **DEFINE\_PTHIS** before **END** directive.

- **GET\_STRING** - procedure to get a null terminated string from a user, the received string is written to buffer at **DS:DI**, buffer size should be in **DX**. Procedure stops the input when 'Enter' is pressed. To use it declare: **DEFINE\_GET\_STRING** before **END** directive.
- **CLEAR\_SCREEN** - procedure to clear the screen, (done by scrolling entire screen window), and set cursor position to top of it. To use it declare: **DEFINE\_CLEAR\_SCREEN** before **END** directive.
- **SCAN\_NUM** - procedure that gets the multi-digit SIGNED number from the keyboard, and stores the result in **CX** register. To use it declare: **DEFINE\_SCAN\_NUM** before **END** directive.
- **PRINT\_NUM** - procedure that prints a signed number in **AX** register. To use it declare: **DEFINE\_PRINT\_NUM** and **DEFINE\_PRINT\_NUM\_UNS** before **END** directive.
- **PRINT\_NUM\_UNS** - procedure that prints out an unsigned number in **AX** register. To use it declare: **DEFINE\_PRINT\_NUM\_UNS** before **END** directive.

To use any of the above procedures you should first declare the function in the bottom of your file (but before the **END** directive), and then use **CALL** instruction followed by a procedure name. For example:

```
include 'emu8086.inc'

ORG 100h

LEA SI, msg1 ; ask for the number
CALL print_string ;
CALL scan_num ; get number in CX.

MOV AX, CX ; copy the number to AX.

; print the following string:
CALL pthis
DB 13, 10, 'You have entered: ', 0

CALL print_num ; print number in AX.

RET ; return to operating system.

msg1 DB 'Enter the number: ', 0

DEFINE_SCAN_NUM
DEFINE_PRINT_STRING
```

```
DEFINE_PRINT_NUM
DEFINE_PRINT_NUM_UNS ; required for print_num.
DEFINE_PTHIS
```

```
END ; directive to stop the compiler.
```

First compiler processes the declarations (these are just regular the macros that are expanded to procedures). When compiler gets to **CALL** instruction it replaces the procedure name with the address of the code where the procedure is declared. When **CALL** instruction is executed control is transferred to procedure. This is quite useful, since even if you call the same procedure 100 times in your code you will still have relatively small executable size. Seems complicated, isn't it? That's ok, with the time you will learn more, currently it's required that you understand the basic principle.

# Arithmetic and logic instructions

---

Most Arithmetic and Logic Instructions affect the processor status register (or **Flags**)

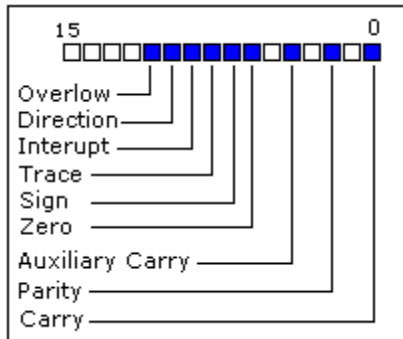

As you may see there are 16 bits in this register, each bit is called a **flag** and can take a value of **1** or **0**.

- **Carry Flag (CF)** - this flag is set to **1** when there is an **unsigned overflow**. For example when you add bytes **255 + 1** (result is not in range 0...255). When there is no overflow this flag is set to **0**.
  - **Zero Flag (ZF)** - set to **1** when result is **zero**. For none zero result this flag is set to **0**.
  - **Sign Flag (SF)** - set to **1** when result is **negative**. When result is **positive** it is set to **0**. Actually this flag take the value of the most significant bit.
  - **Overflow Flag (OF)** - set to **1** when there is a **signed overflow**. For example, when you add bytes **100 + 50** (result is not in range - 128...127).
  - **Parity Flag (PF)** - this flag is set to **1** when there is even number of one bits in result, and to **0** when there is odd number of one bits. Even if result is a word only 8 low bits are analyzed!
  - **Auxiliary Flag (AF)** - set to **1** when there is an **unsigned overflow** for low nibble (4 bits).
  - **Interrupt enable Flag (IF)** - when this flag is set to **1** CPU reacts to interrupts from external devices.
  - **Direction Flag (DF)** - this flag is used by some instructions to process data chains, when this flag is set to **0** - the processing is done forward, when this flag is set to **1** the processing is done backward.
-

There are 3 groups of instructions.

---

First group: **ADD, SUB, CMP, AND, TEST, OR, XOR**

These types of operands are supported:

REG, memory

memory, REG

REG, REG

memory, immediate

REG, immediate

**REG:** AX, BX, CX, DX, AH, AL, BL, BH, CH, CL, DH, DL, DI, SI, BP, SP.

**memory:** [BX], [BX+SI+7], variable, etc...

**immediate:** 5, -24, 3Fh, 10001101b, etc...

After operation between operands, result is always stored in first operand.

**CMP** and **TEST** instructions affect flags only and do not store a result (these instructions are used to make decisions during program execution).

These instructions affect these flags only:

**CF, ZF, SF, OF, PF, AF.**

- **ADD** - add second operand to first.
- **SUB** - Subtract second operand to first.
- **CMP** - Subtract second operand from first **for flags only**.
- **AND** - Logical AND between all bits of two operands. These rules apply:

1 AND 1 = 1

1 AND 0 = 0

0 AND 1 = 0

0 AND 0 = 0

As you see we get **1** only when both bits are **1**.

- **TEST** - The same as **AND** but **for flags only**.
- **OR** - Logical OR between all bits of two operands. These rules apply:

1 OR 1 = 1

1 OR 0 = 1

0 OR 1 = 1

0 OR 0 = 0

As you see we get **1** every time when at least one of the bits is **1**.

- **XOR** - Logical XOR (exclusive OR) between all bits of two operands. These rules apply:

1 XOR 1 = 0

1 XOR 0 = 1

0 XOR 1 = 1

0 XOR 0 = 0

As you see we get **1** every time when bits are different from each other.

---

Second group: **MUL, IMUL, DIV, IDIV**

These types of operands are supported:

REG

memory

**REG:** AX, BX, CX, DX, AH, AL, BL, BH, CH, CL, DH, DL, DI, SI, BP, SP.

**memory:** [BX], [BX+SI+7], variable, etc...

**MUL** and **IMUL** instructions affect these flags only:

**CF, OF**

When result is over operand size these flags are set to **1**, when result fits in operand size these flags are set to **0**.

For **DIV** and **IDIV** flags are undefined.

- **MUL** - Unsigned multiply:

when operand is a **byte**:

AX = AL \* operand.

when operand is a **word**:

(DX AX) = AX \* operand.

- **IMUL** - Signed multiply:

when operand is a **byte**:

AX = AL \* operand.

when operand is a **word**:

(DX AX) = AX \* operand.

- **DIV** - Unsigned divide:

when operand is a **byte**:

AL = AX / operand

AH = remainder (modulus). .

when operand is a **word**:

AX = (DX AX) / operand

DX = remainder (modulus). .

- **IDIV** - Signed divide:

when operand is a **byte**:

AL = AX / operand

AH = remainder (modulus). .

when operand is a **word**:

AX = (DX AX) / operand

DX = remainder (modulus). .

---

Third group: **INC, DEC, NOT, NEG**

These types of operands are supported:

REG

memory

**REG**: AX, BX, CX, DX, AH, AL, BL, BH, CH, CL, DH, DL, DI, SI, BP, SP.

**memory**: [BX], [BX+SI+7], variable, etc...

**INC, DEC** instructions affect these flags only:

**ZF, SF, OF, PF, AF.**

**NOT** instruction does not affect any flags!

**NEG** instruction affects these flags only:

**CF, ZF, SF, OF, PF, AF.**

- **NOT** - Reverse each bit of operand.
- **NEG** - Make operand negative (two's complement). Actually it reverses each bit of operand and then adds 1 to it. For example 5 will become -5, and -2 will become 2.

# program flow control

---

Controlling the program flow is a very important thing, this is where your program can make decisions according to certain conditions.

- **unconditional jumps**

The basic instruction that transfers control to another point in the program is **JMP**.

The basic syntax of **JMP** instruction:

```
JMP label
```

To declare a *label* in your program, just type its name and add ":" to the end, label can be any character combination but it cannot start with a number, for example here are 3 legal label definitions:

```
label1:  
label2:  
a:
```

Label can be declared on a separate line or before any other instruction, for example:

```
x1:  
MOV AX, 1  
  
x2: MOV AX, 2
```

here's an example of **JMP** instruction:

```
org 100h  
  
mov ax, 5 ; set ax to 5.  
mov bx, 2 ; set bx to 2.  
  
jmp calc ; go to 'calc'.  
  
back: jmp stop ; go to 'stop'.  
  
calc:  
add ax, bx ; add bx to ax.  
jmp back ; go 'back'.  
  
stop:  
  
ret ; return to operating system.
```



Of course there is an easier way to calculate the some of two numbers, but it's still a good example of **JMP** instruction.

As you can see from this example **JMP** is able to transfer control both forward and backward. It can jump anywhere in current code segment (65,535 bytes).

- **Short Conditional Jumps**

Unlike **JMP** instruction that does an unconditional jump, there are instructions that do a conditional jumps (jump only when some conditions are in act). These instructions are divided in three groups, first group just test single flag, second compares numbers as signed, and third compares numbers as unsigned.

**Jump instructions that test single flag**

Instruction	Description	Condition	Opposite Instruction
JZ , JE	Jump if Zero (Equal).	ZF = 1	JNZ, JNE
JC , JB, JNAE	Jump if Carry (Below, Not Above Equal).	CF = 1	JNC, JNB, JAE
JS	Jump if Sign.	SF = 1	JNS
JO	Jump if Overflow.	OF = 1	JNO
JPE, JP	Jump if Parity Even.	PF = 1	JPO
JNZ , JNE	Jump if Not Zero (Not Equal).	ZF = 0	JZ, JE
JNC , JNB, JAE	Jump if Not Carry (Not Below, Above Equal).	CF = 0	JC, JB, JNAE
JNS	Jump if Not Sign.	SF = 0	JS
JNO	Jump if Not Overflow.	OF = 0	JO
JPO, JNP	Jump if Parity Odd (No Parity).	PF = 0	JPE, JP

- 

as you may already notice there are some instructions that do that same thing, that's correct, they even are assembled into the same machine code, so it's good to remember that when you compile **JE** instruction - you will get it disassembled as: **JZ**, **JC** is assembled the same as **JB** etc...

different names are used to make programs easier to understand, to code and most importantly to remember. very offset dissembler has no clue what the original instruction was look like that's why it uses the most common name.

if you emulate this code you will see that all instructions are assembled into **JNB**, the operational code (opcode) for this instruction is **73h** this instruction has fixed length of two bytes, the second byte is number of bytes to add to the **IP** register if the condition is true. because the instruction has only 1 byte to keep the offset it is limited to pass control to -128 bytes back or 127 bytes forward, this value is always signed.

- 
- `jnc a`
- `jnb a`
- `jae a`
- 
- `mov ax, 4`
- `a: mov ax, 5`
- `ret`
- 
- 

### Jump instructions for signed numbers

Instruction	Description	Condition	Opposite Instruction
JE , JZ	Jump if Equal (=). Jump if Zero.	ZF = 1	JNE, JNZ
JNE , JNZ	Jump if Not Equal ( $\neq$ ). Jump if Not Zero.	ZF = 0	JE, JZ
JG , JNLE	Jump if Greater ( $>$ ). Jump if Not Less or Equal ( <b>not</b> $\leq$ ).	ZF = 0 and SF = OF	JNG, JLE
JL , JNGE	Jump if Less ( $<$ ). Jump if Not Greater or Equal ( <b>not</b> $\geq$ ).	SF $\neq$ OF	JNL, JGE
JGE , JNL	Jump if Greater or Equal ( $\geq$ ). Jump if Not Less ( <b>not</b> $<$ ).	SF = OF	JNGE, JL
JLE , JNG	Jump if Less or Equal ( $\leq$ ). Jump if Not Greater ( <b>not</b> $>$ ).	ZF = 1 or SF $\neq$ OF	JNLE, JG

- 
- $\neq$  - sign means not equal.

## Jump instructions for unsigned numbers

Instruction	Description	Condition	Opposite Instruction
JE , JZ	Jump if Equal (=). Jump if Zero.	ZF = 1	JNE, JNZ
JNE , JNZ	Jump if Not Equal (<>). Jump if Not Zero.	ZF = 0	JE, JZ
JA , JNBE	Jump if Above (>). Jump if Not Below or Equal ( <b>not</b> <=).	CF = 0 and ZF = 0	JNA, JBE
JB , JNAE, JC	Jump if Below (<). Jump if Not Above or Equal ( <b>not</b> >=). Jump if Carry.	CF = 1	JNB, JAE, JNC
JAE , JNB, JNC	Jump if Above or Equal (>=). Jump if Not Below ( <b>not</b> <). Jump if Not Carry.	CF = 0	JNAE, JB
JBE , JNA	Jump if Below or Equal (<=). Jump if Not Above ( <b>not</b> >).	CF = 1 or ZF = 1	JNBE, JA

- 

Generally, when it is required to compare numeric values **CMP** instruction is used (it does the same as **SUB** (subtract) instruction, but does not keep the result, just affects the flags).

The logic is very simple, for example:  
it's required to compare 5 and 2,  
 $5 - 2 = 3$   
the result is not zero (Zero Flag is set to 0).

Another example:  
it's required to compare 7 and 7,  
 $7 - 7 = 0$   
the result is zero! (Zero Flag is set to 1 and **JZ** or **JE** will do the jump).

here's an example of **CMP** instruction and conditional jump:

- 

- `include "emu8086.inc"`

-

- `org 100h`
- 
- `mov al, 25 ; set al to 25.`
- `mov bl, 10 ; set bl to 10.`
- 
- `cmp al, bl ; compare al - bl.`
- 
- `je equal ; jump if al = bl (zf = 1).`
- 
- `putc 'n' ; if it gets here, then al < bl,`
- `jmp stop ; so print 'n', and jump to stop.`
- 
- `equal: ; if gets here,`
- `putc 'y' ; then al = bl, so print 'y'.`
- 
- `stop:`
- 
- `ret ; gets here no matter what.`
- 
- 

try the above example with different numbers for **AL** and **BL**, open flags by clicking on flags button, use single step and see what happens. you can use **F5** hotkey to recompile and reload the program into the emulator.

## loops

instruction	operation and jump condition	opposite instruction
LOOP	decrease cx, jump to label if cx not zero.	DEC CX and JCXZ
LOOPE	decrease cx, jump to label if cx not zero and equal (zf = 1).	LOOPNE
LOOPNE	decrease cx, jump to label if cx not zero and not equal (zf = 0).	LOOPE
LOOPNZ	decrease cx, jump to label if cx not zero and zf = 0.	LOOPZ
LOOPZ	decrease cx, jump to label if cx not zero and zf = 1.	LOOPNZ
JCXZ	jump to label if cx is zero.	OR CX, CX and JNZ

loops are basically the same jumps, it is possible to code loops without using the loop instruction, by just using conditional jumps and compare, and this is just what loop does. all loop instructions use **CX** register to

count steps, as you know CX register has 16 bits and the maximum value it can hold is 65535 or FFFF, however with some agility it is possible to put one loop into another, and another into another two, and three and etc... and receive a nice value of 65535 \* 65535 \* 65535 ....till infinity.... or the end of ram or stack memory. it is possible store original value of cx register using **push cx** instruction and return it to original when the internal loop ends with **pop cx**, for example:

- 
- `org 100h`
- 
- `mov bx, 0 ; total step counter.`
- 
- `mov cx, 5`
- `k1: add bx, 1`
- `mov al, '1'`
- `mov ah, 0eh`
- `int 10h`
- `push cx`
- `mov cx, 5`
- `k2: add bx, 1`
- `mov al, '2'`
- `mov ah, 0eh`
- `int 10h`
- `push cx`
- `mov cx, 5`
- `k3: add bx, 1`
- `mov al, '3'`
- `mov ah, 0eh`
- `int 10h`
- `loop k3 ; internal in internal loop.`
- `pop cx`
- `loop k2 ; internal loop.`
- `pop cx`
- `loop k1 ; external loop.`
- 
- `ret`
- 

- bx counts total number of steps, by default emulator shows values in hexadecimal, you can double click the register to see the value in all available bases.

just like all other conditional jumps loops have an opposite companion that can help to create workarounds, when the address of desired location is too far assemble automatically assembles reverse and long jump instruction, making total of 5 bytes instead of just 2, it can be seen in disassembler as well.

for more detailed description and examples refer to [complete 8086 instruction set](#)

- 
- - All conditional jumps have one big limitation, unlike **JMP** instruction they can only jump **127** bytes forward and **128** bytes backward (note that

most instructions are assembled into 3 or more bytes).

We can easily avoid this limitation using a cute trick:

- Get an opposite conditional jump instruction from the table above, make it jump to *label\_x*.
- Use **JMP** instruction to jump to desired location.
- Define *label\_x*: just after the **JMP** instruction.

*label\_x*: - can be any valid label name, but there must not be two or more labels with the same name.

here's an example:

```
include "emu8086.inc"

org 100h

mov al, 5
mov bl, 5

cmp al, bl ; compare al - bl.

; je equal ; there is only 1 byte

jne not_equal ; jump if al <> bl (zf = 0).
jmp equal
not_equal:

add bl, al
sub al, 10
xor al, bl

jmp skip_data
db 256 dup(0) ; 256 bytes
skip_data:

putc 'n' ; if it gets here, then al <> bl,
jmp stop ; so print 'n', and jump to stop.

equal: ; if gets here,
putc 'y' ; then al = bl, so print 'y'.

stop:

ret
```

Note: the latest version of the integrated 8086 assembler automatically creates a workaround by replacing the conditional jump with the opposite, and adding big unconditional jump. To check if you have the latest version of emu8086 click **help-> check for an update** from the menu.

---

Another, yet rarely used method is providing an immediate value instead of label. When immediate value starts with \$ relative jump is performed, otherwise compiler calculates instruction that jumps directly to given offset. For example:

```
org 100h

; unconditional jump forward:
; skip over next 3 bytes + itself
; the machine code of short jmp instruction takes 2 bytes.
jmp $3+2
a db 3 ; 1 byte.
b db 4 ; 1 byte.
c db 4 ; 1 byte.

; conditional jump back 5 bytes:
mov bl,9
dec bl ; 2 bytes.
cmp bl,0 ; 3 bytes.
jne $-5 ; jump 5 bytes back

ret
```

# Procedures

---

Procedure is a part of code that can be called from your program in order to make some specific task. Procedures make program more structural and easier to understand. Generally procedure returns to the same point from where it was called.

The syntax for procedure declaration:

name PROC

    ; here goes the code  
    ; of the procedure ...

RET

name ENDP

name - is the procedure name, the same name should be in the top and the bottom, this is used to check correct closing of procedures.

Probably, you already know that **RET** instruction is used to return to operating system. The same instruction is used to return from procedure (actually operating system sees your program as a special procedure).

**PROC** and **ENDP** are compiler directives, so they are not assembled into any real machine code. Compiler just remembers the address of procedure.

**CALL** instruction is used to call a procedure.

Here is an example:

```
ORG 100h  
  
CALL m1  
  
MOV AX, 2  
  
RET ; return to operating system.  
  
m1 PROC  
MOV BX, 5  
RET ; return to caller.  
m1 ENDP  
  
END
```

The above example calls procedure **m1**, does **MOV BX, 5**, and returns to the next instruction after **CALL: MOV AX, 2**.



There are several ways to pass parameters to procedure, the easiest way to pass parameters is by using registers, here is another example of a procedure that receives two parameters in **AL** and **BL** registers, multiplies these parameters and returns the result in **AX** register:

```
ORG 100h

MOV AL, 1
MOV BL, 2

CALL m2
CALL m2
CALL m2
CALL m2

RET ; return to operating system.

m2 PROC
MUL BL ; AX = AL * BL.
RET ; return to caller.
m2 ENDP

END
```

In the above example value of **AL** register is update every time the procedure is called, **BL** register stays unchanged, so this algorithm calculates **2** in power of **4**, so final result in **AX** register is **16** (or 10h).

---

Here goes another example, that uses a procedure to print a *Hello World!* message:

```
ORG 100h

LEA SI, msg ; load address of msg to SI.

CALL print_me

RET ; return to operating system.

;
=====
; this procedure prints a string, the string should be null
; terminated (have zero in the end),
; the string address should be in SI register:
print_me PROC

next_char:
CMP b.[SI], 0 ; check for zero to stop
JE stop ;
```

```
MOV AL, [SI] ; next get ASCII char.

MOV AH, 0Eh ; teletype function number.
INT 10h ; using interrupt to print a char in AL.

ADD SI, 1 ; advance index of string array.

JMP next_char ; go back, and type another char.
```

```
stop:
RET ; return to caller.
print_me ENDP
;
```

---

```
msg DB 'Hello World!', 0 ; null terminated string.
```

```
END
```

**"b."** - prefix before [SI] means that we need to compare bytes, not words. When you need to compare words add **"w."** prefix instead. When one of the compared operands is a register it's not required because compiler knows the size of each register

# The Stack

---

Stack is an area of memory for keeping temporary data. Stack is used by **CALL** instruction to keep return address for procedure, **RET** instruction gets this value from the stack and returns to that offset. Quite the same thing happens when **INT** instruction calls an interrupt, it stores in stack flag register, code segment and offset. **IRET** instruction is used to return from interrupt call.

We can also use the stack to keep any other data, there are two instructions that work with the stack:

**PUSH** - stores 16 bit value in the stack.

**POP** - gets 16 bit value from the stack.

Syntax for **PUSH** instruction:

PUSH REG  
PUSH SREG  
PUSH memory  
PUSH immediate  
**REG:** AX, BX, CX, DX, DI, SI, BP, SP.

**SREG:** DS, ES, SS, CS.

**memory:** [BX], [BX+SI+7], 16 bit variable, etc...

**immediate:** 5, -24, 3Fh, 10001101b, etc...

Syntax for **POP** instruction:

POP REG  
POP SREG  
POP memory  
**REG:** AX, BX, CX, DX, DI, SI, BP, SP.

**SREG:** DS, ES, SS, (except CS).

**memory:** [BX], [BX+SI+7], 16 bit variable, etc...

Notes:

- **PUSH** and **POP** work with 16 bit values only!
- Note: **PUSH immediate** works only on 80186 CPU and later!

The stack uses **LIFO** (Last In First Out) algorithm, this means that if we push these values one by one into the stack:

**1, 2, 3, 4, 5**

the first value that we will get on pop will be **5**, then **4, 3, 2**, and only then **1**.

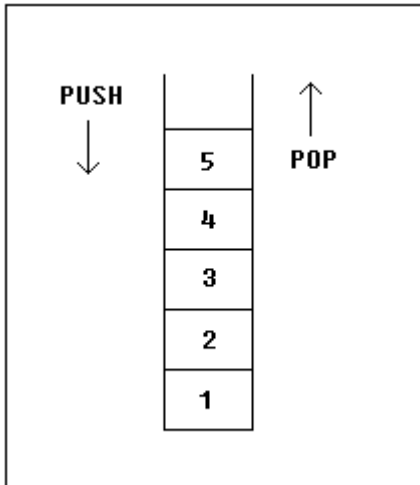

It is very important to do equal number of **PUSHs** and **POPs**, otherwise the stack maybe corrupted and it will be impossible to return to operating system. As you already know we use **RET** instruction to return to operating system, so when program starts there is a return address in stack (generally it's 0000h).

**PUSH** and **POP** instruction are especially useful because we don't have too much registers to operate with, so here is a trick:

- Store original value of the register

## The Stack

---

Stack is an area of memory for keeping temporary data. Stack is used by **CALL** instruction to keep return address for procedure, **RET** instruction gets this value from the stack and returns to that offset. Quite the same thing happens when **INT** instruction calls an interrupt, it stores in stack flag register, code segment and offset. **IRET** instruction is used to return from interrupt call.

We can also use the stack to keep any other data, there are two instructions that work with the stack:

**PUSH** - stores 16 bit value in the stack.

**POP** - gets 16 bit value from the stack.

Syntax for **PUSH** instruction:

PUSH REG

PUSH SREG

PUSH memory

PUSH immediate

**REG:** AX, BX, CX, DX, DI, SI, BP, SP.

**SREG:** DS, ES, SS, CS.

**memory:** [BX], [BX+SI+7], 16 bit variable, etc...

**immediate:** 5, -24, 3Fh, 10001101b, etc...

Syntax for **POP** instruction:

POP REG

POP SREG

POP memory

**REG:** AX, BX, CX, DX, DI, SI, BP, SP.

**SREG:** DS, ES, SS, (except CS).

**memory:** [BX], [BX+SI+7], 16 bit variable, etc...

Notes:

- **PUSH** and **POP** work with 16 bit values only!
- Note: **PUSH immediate** works only on 80186 CPU and later!

The stack uses **LIFO** (Last In First Out) algorithm,  
this means that if we push these values one by one into the stack:

**1, 2, 3, 4, 5**

the first value that we will get on pop will be **5**, then **4, 3, 2**, and only then **1**.

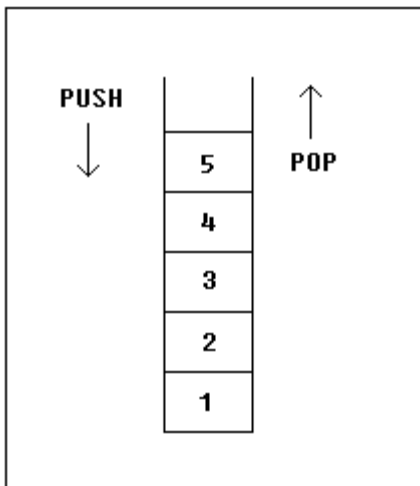

It is very important to do equal number of **PUSH**s and **POP**s, otherwise the stack maybe corrupted and it will be impossible to return to operating system. As you already know we use **RET** instruction to return to operating system, so when program starts there is a return address in stack (generally it's 0000h).

**PUSH** and **POP** instruction are especially useful because we don't have too much registers to operate with, so here is a trick:

- Store original value of the register in stack (using **PUSH**).
- Use the register for any purpose.
- Restore the original value of the register from stack (using **POP**).

Here is an example:

```

ORG 100h

MOV AX, 1234h
PUSH AX ; store value of AX in stack.

MOV AX, 5678h ; modify the AX value.

POP AX ; restore the original value of AX.

RET

END

```

Another use of the stack is for exchanging the values, here is an example:

```

ORG 100h

```

```
MOV  AX, 1212h ; store 1212h in AX.
MOV  BX, 3434h ; store 3434h in BX

PUSH AX      ; store value of AX in stack.
PUSH BX      ; store value of BX in stack.

POP  AX      ; set AX to original value of BX.
POP  BX      ; set BX to original value of AX.

RET

END
```

The exchange happens because stack uses **LIFO** (Last In First Out) algorithm, so when we push **1212h** and then **3434h**, on pop we will first get **3434h** and only after it **1212h**.

---

The stack memory area is set by **SS** (Stack Segment) register, and **SP** (Stack Pointer) register. Generally operating system sets values of these registers on program start.

"**PUSH source**" instruction does the following:

- Subtract **2** from **SP** register.
- Write the value of **source** to the address **SS:SP**.

"**POP destination**" instruction does the following:

- Write the value at the address **SS:SP** to **destination**.
- Add **2** to **SP** register.

The current address pointed by **SS:SP** is called **the top of the stack**.

For **COM** files stack segment is generally the code segment, and stack pointer is set to value of **OFFFEh**. At the address **SS:OFFFEh** stored a return address for **RET** instruction that is executed in the end of the program.

You can visually see the stack operation by clicking on [**Stack**] button on emulator window. The top of the stack is marked with "<" sign.

# Macros

---

Macros are just like procedures, but not really. Macros look like procedures, but they exist only until your code is compiled, after compilation all macros are replaced with real instructions. If you declared a macro and never used it in your code, compiler will simply ignore it. [emu8086.inc](#) is a good example of how macros can be used, this file contains several macros to make coding easier for you.

Macro definition:

```
name  MACRO [parameters,...]
    <instructions>
ENDM
```

Unlike procedures, macros should be defined above the code that uses it, for example:

```
MyMacro  MACRO p1, p2, p3
    MOV AX, p1
    MOV BX, p2
    MOV CX, p3
ENDM

ORG 100h

MyMacro 1, 2, 3

MyMacro 4, 5, DX

RET
```

The above code is expanded into:

```
MOV AX, 00001h
MOV BX, 00002h
MOV CX, 00003h
MOV AX, 00004h
MOV BX, 00005h
MOV CX, DX
```



Some important facts about **macros** and **procedures**:

- When you want to use a procedure you should use **CALL** instruction, for example:

```
CALL MyProc
```

- When you want to use a macro, you can just type its name. For example:

```
MyMacro
```

- Procedure is located at some specific address in memory, and if you use the same procedure 100 times, the CPU will transfer control to this part of the memory. The control will be returned back to the program by **RET** instruction. The **stack** is used to keep the return address. The **CALL** instruction takes about 3 bytes, so the size of the output executable file grows very insignificantly, no matter how many time the procedure is used.
- Macro is expanded directly in program's code. So if you use the same macro 100 times, the compiler expands the macro 100 times, making the output executable file larger and larger, each time all instructions of a macro are inserted.
- You should use **stack** or any general purpose registers to pass parameters to procedure.
- To pass parameters to macro, you can just type them after the macro name. For example:

```
MyMacro 1, 2, 3
```

- To mark the end of the macro **ENDM** directive is enough.
- To mark the end of the procedure, you should type the name of the procedure before the **ENDP** directive.

Macros are expanded directly in code, therefore if there are labels inside the macro definition you may get "Duplicate declaration" error when macro is used for twice or more. To avoid such problem, use **LOCAL** directive followed by names of variables, labels or procedure names. For example:

```
MyMacro2  MACRO
    LOCAL label1, label2

    CMP AX, 2
    JE label1
    CMP AX, 3
    JE label2
    label1:
        INC AX
    label2:
        ADD AX, 2
ENDM
```

```
ORG 100h  
MyMacro2  
MyMacro2  
RET
```

If you plan to use your macros in several programs, it may be a good idea to place all macros in a separate file. Place that file in **Inc** folder and use **INCLUDE *file-name*** directive to use macros. See [Library of common functions - emu8086.inc](#) for an example of such file.

---

## making your own operating system

---

Usually, when a computer starts it will try to load the first 512-byte sector (that's Cylinder **0**, Head **0**, Sector **1**) from any diskette in your **A:** drive to memory location **0000h:7C00h** and give it control. If this fails, the BIOS tries to use the MBR of the first hard drive instead.

This tutorial covers booting up from a floppy drive, the same principles are used to boot from a hard drive. But using a floppy drive has several advantages:

- you can keep your existing operating system intact (windows, dos, linux, unix, be-os...).
- it is easy and safe to modify the boot record of a floppy disk.

example of a simple floppy disk boot program:

```
; directive to create BOOT file:  
#make_boot#  
  
; Boot record is loaded at 0000:7C00,  
; so inform compiler to make required  
; corrections:  
ORG 7C00h
```

```

PUSH CS ; make sure DS=CS
POP DS

; load message address into SI register:
LEA SI, msg

; teletype function id:
MOV AH, 0Eh

print: MOV AL, [SI]
      CMP AL, 0
      JZ done
      INT 10h ; print using teletype.
      INC SI
      JMP print

; wait for 'any key':
done:  MOV AH, 0
      INT 16h

; store magic value at 0040h:0072h:
; 0000h - cold boot.
; 1234h - warm boot.
MOV AX, 0040h
MOV DS, AX
MOV w.[0072h], 0000h ; cold boot.

JMP 0FFFFh:0000h ; reboot!

new_line EQU 13, 10

msg DB 'Hello This is My First Boot Program!'
    DB new_line, 'Press any key to reboot', 0

```

copy the above example to the source editor and press **emulate**. the emulator automatically loads **.bin** file to **0000h:7C00h** (it uses supplementary **.binf** file to know where to load).

you can run it just like a regular program, or you can use the **virtual drive** menu to **write 512 bytes at 7c00h to boot sector** of a virtual floppy drive (it's "**FLOPPY\_0**" file in c:\emu8086). after your program is written to the virtual floppy drive, you can select **boot from floppy** from **virtual drive** menu.

**.bin** files for boot records are limited to 512 bytes (sector size). if your new operating system is going to grow over this size, you will need to use a boot program to load data from other sectors (just like *micro-os\_loader.asm* does). an example of a tiny operating system can be found in c:\emu8086\examples and "**online**":

[micro-os\\_loader.asm](#)  
[micro-os\\_kernel.asm](#)

To create extensions for your Operating System (over 512 bytes), you can use additional sectors of a floppy disk. It's recommended to use ".bin" files for this purpose (to create ".bin" file select "**BIN Template**" from "**File**" -> "**New**" menu).

To write ".bin" file to virtual floppy, select "**Write .bin file to floppy...**" from "**Virtual drive**" menu of emulator, you should write it anywhere but the boot sector (which is Cylinder: **0**, Head: **0**, Sector: **1**).

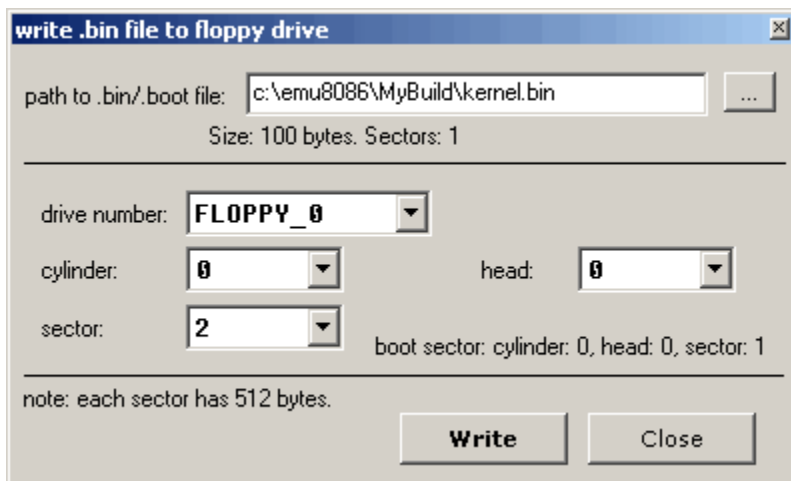

you can use this utility to write .bin files to virtual floppy disk ("**FLOPPY\_0**" file), instead of "**write 512 bytes at 7c00h to boot sector**" menu. however, you should remember that .bin file that is designed to be a boot record should always be written to cylinder: **0**, head: **0**, sector: **1**

Boot Sector Location:  
Cylinder: 0  
Head: 0  
Sector: 1

to write .bin files to real floppy disk use writebin.asm, just compile it to com file and run it from command prompt. to write a boot record type: **writebin loader.bin** ; to write kernel module type: **writebin kernel.bin /k** /k - parameter tells the program to write the file at sector 2 instead of sector 1. it does not matter in what order you write the files onto floppy drive, but it does matter where you write them.

---

**note:** this boot record is not MS-DOS/Windows compatible boot sector, it's not even Linux or Unix compatible, operating system may not allow you to

read or write files on this diskette until you re-format it, therefore make sure the diskette you use doesn't contain any important information. however you can write and read anything to and from this disk using low level disk access interrupts, it's even possible to protect valuable information from the others this way; even if someone gets the disk he will probably think that it's empty and will reformat it because it's the default option in windows operating system... such a good type of self destructing data carrier :)

---

idealized floppy drive and diskette structure:

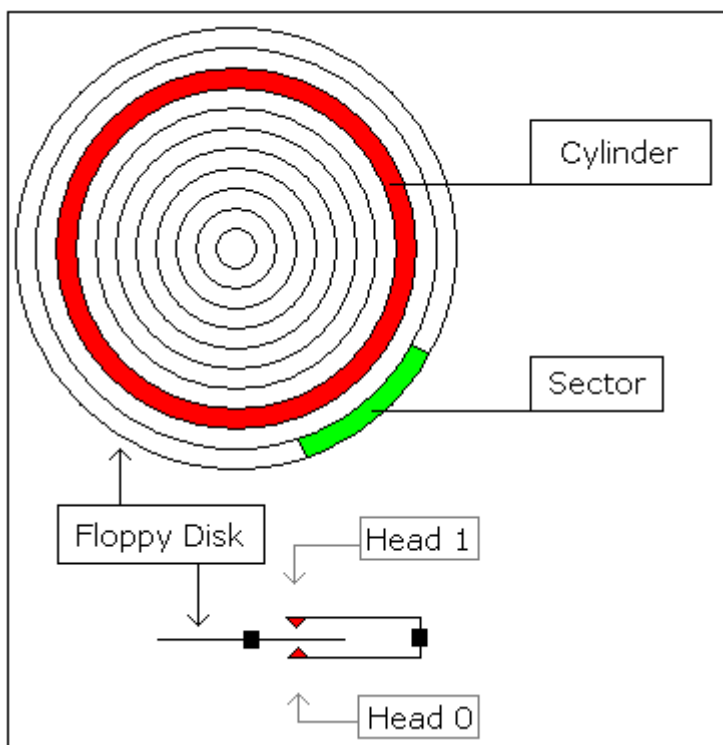

for a **1440 kb** diskette:

- floppy disk has 2 sides, and there are 2 heads; one for each side (**0..1**), the drive heads move above the surface of the disk on each side.
- each side has 80 cylinders (numbered **0..79**).
- each cylinder has 18 sectors (**1..18**).
- each sector has **512** bytes.
- total size of floppy disk is:  $2 \times 80 \times 18 \times 512 = \mathbf{1,474,560}$  bytes.

note: the MS-DOS (windows) formatted floppy disk has slightly less free space on it (by about 16,896 bytes) because the operating system needs place to store file names and directory structure (often called FAT or file system allocation table). more file names - less disk space. the most efficient way to

store files is to write them directly to sectors instead of using file system, and in some cases it is also the most reliable way, if you know how to use it.

to read sectors from floppy drive use **INT 13h / AH = 02h**.

## Controlling External Devices

There are 7 devices attached to the emulator: traffic lights, stepper-motor, LED display, thermometer, printer, robot and simple test device. You can view devices when you click "**Virtual Devices**" menu of the emulator.

For technical information refer to **I/O ports** section of emu8086 reference.

In general, it is possible to use any x86 family CPU to control all kind of devices, the difference maybe in base I/O port number, this can be altered using some tricky electronic equipment. Usually the ".bin" file is written into the Read Only Memory (ROM) chip, the system reads program from that chip, loads it in RAM module and runs the program. This principle is used for many modern devices such as micro-wave ovens and etc...

### Traffic Lights

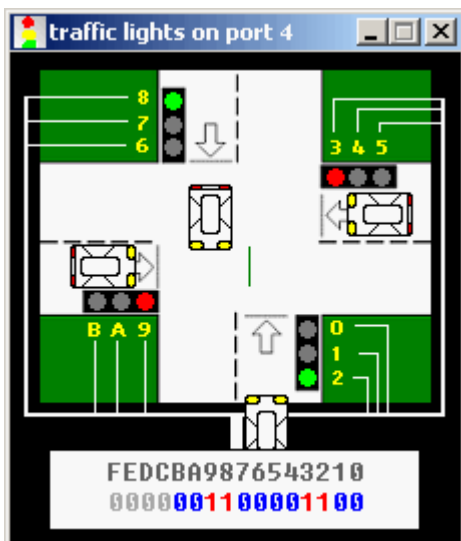

Usually to control the traffic lights an array (table) of values is used. In certain periods of time the value is read from the array and sent to a port. For example:

```
; controlling external device with 8086 microprocessor.  
; realistic test for c:\emu8086\devices\Traffic_Lights.exe
```

```

#start=Traffic_Lights.exe#

name "traffic"

mov ax, all_red
out 4, ax

mov si, offset situation

next:
mov ax, [si]
out 4, ax

; wait 5 seconds (5 million microseconds)
mov cx, 4Ch ; 004C4B40h = 5,000,000
mov dx, 4B40h
mov ah, 86h
int 15h

add si, 2 ; next situation
cmp si, sit_end
jb next
mov si, offset situation
jmp next

; FEDC_BA98_7654_3210
situation dw 0000_0011_0000_1100b
s1 dw 0000_0110_1001_1010b
s2 dw 0000_1000_0110_0001b
s3 dw 0000_1000_0110_0001b
s4 dw 0000_0100_1101_0011b
sit_end = $

all_red equ 0000_0010_0100_1001b

```

---

## Stepper-Motor

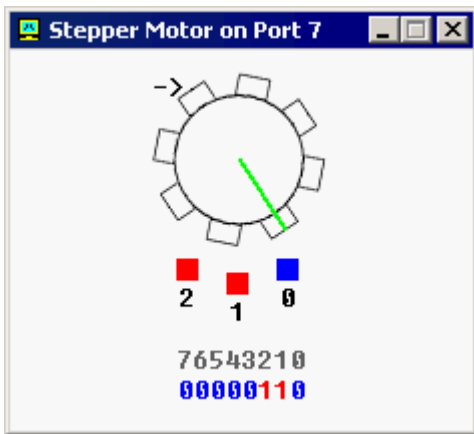

The motor can be half stepped by turning on pair of magnets, followed by a single and so on.

The motor can be full stepped by turning on pair of magnets, followed by another pair of magnets and in the end followed by a single magnet and so on. The best way to make full step is to make two half steps.

Half step is equal to **11.25** degrees.  
Full step is equal to **22.5** degrees.

The motor can be turned both clock-wise and counter-clock-wise.

See [stepper\\_motor.asm](#) in c:\emu8086\examples\

See also [I/O ports](#) section of emu8086 reference.

---

**Robot**



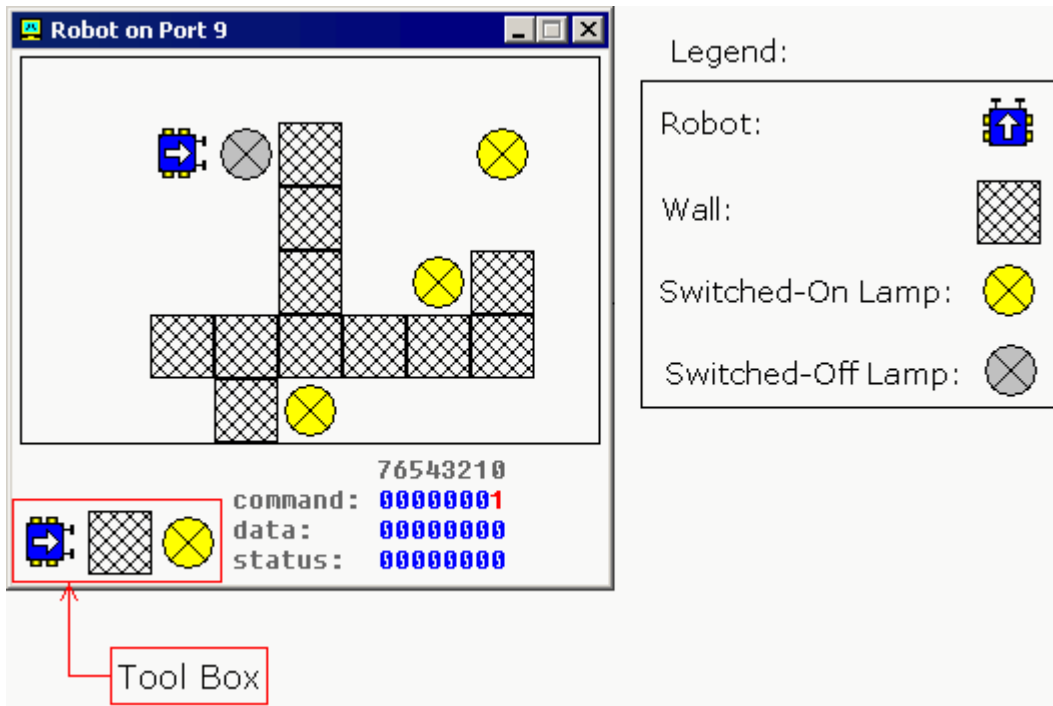

Complete list of robot instruction set is given in **I/O ports** section of emu8086 reference.

To control the robot a complex algorithm should be used to achieve maximum efficiency. The simplest, yet very inefficient, is random moving algorithm, see **robot.asm** in c:\emu8086\examples\

It is also possible to use a data table (just like for Traffic Lights), this can be good if robot always works in the same surroundings.

## Complete 8086 instruction set

---

Quick reference:

AAA	CMPSB	JAE	JNBE	JPO	MOV	RCR	SCASB
AAD	CMPSW	JB	JNC	JS	MOVSB	REP	SCASW
AAM	CWD	JBE	JNE	JZ	MOVSW	REPE	SHL
AAS	DAA	JC	JNG	LAHF	MUL	REPNE	SHR
ADC	DAS	JCXZ	JNGE	LDS	NEG	REPZ	STC
ADD	DEC	JE	JNL	LEA	NOP	REPZ	STD
AND	DIV	JG	JNLE	LES	NOT	RET	STI
CALL	HLT	JGE	JNO	LODSB	OR	RETF	STOSB
CBW	IDIV	JL	JNP	LODSW	OUT	ROL	STOSW
CLC	IMUL	JLE	JNS	LOOP	POP	ROR	SUB
CLD	IN	JMP	JNZ	LOOPE	POPA	SAHF	TEST

CLI	INC	JNA	JO	LOOPNE	POPF	SAL	XCHG
CMC	INT	JNAE	JP	LOOPNZ	PUSH	SAR	XLATB
CMP	INTO	JNB	JPE	LOOPZ	PUSHA	SBB	XOR
	IRET				PUSHF		
	JA				RCL		

Operand types:

**REG:** AX, BX, CX, DX, AH, AL, BL, BH, CH, CL, DH, DL, DI, SI, BP, SP.

**SREG:** DS, ES, SS, and only as second operand: CS.

**memory:** [BX], [BX+SI+7], variable, etc...(see [Memory Access](#)).

**immediate:** 5, -24, 3Fh, 10001101b, etc...

Notes:

- When two operands are required for an instruction they are separated by comma. For example:

REG, memory

- When there are two operands, both operands must have the same size (except shift and rotate instructions). For example:

AL, DL

DX, AX

m1 DB ?

AL, m1

m2 DW ?

AX, m2

- Some instructions allow several operand combinations. For example:

memory, immediate

REG, immediate

memory, REG

REG, SREG

- Some examples contain macros, so it is advisable to use **Shift + F8** hot key to *Step Over* (to make macro code execute at maximum speed set **step delay** to zero), otherwise emulator will step through each instruction of a macro. Here is an example that uses PRINTN macro:

- 
- 
- 

```
include 'emu8086.inc'
```

- ORG 100h
  - MOV AL, 1
  - MOV BL, 2
  - PRINTN 'Hello World!' ; macro.
  - MOV CL, 3
  - PRINTN 'Welcome!' ; macro.
- RET



These marks are used to show the state of the flags:



- 1** - instruction sets this flag to **1**.
- 0** - instruction sets this flag to **0**.
- r** - flag value depends on result of the instruction.
- ?** - flag value is undefined (maybe **1** or **0**).



**Some instructions generate exactly the same machine code, so disassembler may have a problem decoding to your original code. This is especially important for Conditional Jump instructions (see "[Program Flow Control](#)" in Tutorials for more information).**





Instructions in alphabetical order:



Instruction	Operands	Description
AAA	No operands	<p>ASCII Adjust after Addition. Corrects result in AH and AL after addition when working with BCD values.</p> <p>It works according to the following Algorithm:</p> <p>if low nibble of AL &gt; 9 or AF = 1 then:</p> <ul style="list-style-type: none"> <li>• AL = AL + 6</li> <li>• AH = AH + 1</li> <li>• AF = 1</li> <li>• CF = 1</li> </ul> <p>else</p> <ul style="list-style-type: none"> <li>• AF = 0</li> <li>• CF = 0</li> </ul>

		 in both cases: clear the high nibble of AL.  <b>Example:</b> MOV AX, 15 ; AH = 00, AL = 0Fh AAA ; AH = 01, AL = 05 RET <table border="1" data-bbox="555 398 746 488"> <tr><td>C</td><td>Z</td><td>S</td><td>O</td><td>P</td><td>A</td></tr> <tr><td>r</td><td>?</td><td>?</td><td>?</td><td>?</td><td>r</td></tr> </table>	C	Z	S	O	P	A	r	?	?	?	?	r
C	Z	S	O	P	A									
r	?	?	?	?	r									
AAD	No operands	 ASCII Adjust before Division. Prepares two BCD values for division.  <b>Algorithm:</b> <ul style="list-style-type: none"> <li>• <math>AL = (AH * 10) + AL</math></li> <li>• <math>AH = 0</math></li> </ul> <b>Example:</b> MOV AX, 0105h ; AH = 01, AL = 05 AAD ; AH = 00, AL = 0Fh (15) RET <table border="1" data-bbox="555 1003 746 1093"> <tr><td>C</td><td>Z</td><td>S</td><td>O</td><td>P</td><td>A</td></tr> <tr><td>?</td><td>r</td><td>r</td><td>?</td><td>r</td><td>?</td></tr> </table>	C	Z	S	O	P	A	?	r	r	?	r	?
C	Z	S	O	P	A									
?	r	r	?	r	?									
AAM	No operands	 ASCII Adjust after Multiplication. Corrects the result of multiplication of two BCD values.  <b>Algorithm:</b> <ul style="list-style-type: none"> <li>• <math>AH = AL / 10</math></li> <li>• <math>AL = \text{remainder}</math></li> </ul> <b>Example:</b> MOV AL, 15 ; AL = 0Fh AAM ; AH = 01, AL = 05 RET <table border="1" data-bbox="555 1603 746 1693"> <tr><td>C</td><td>Z</td><td>S</td><td>O</td><td>P</td><td>A</td></tr> <tr><td>?</td><td>r</td><td>r</td><td>?</td><td>r</td><td>?</td></tr> </table>	C	Z	S	O	P	A	?	r	r	?	r	?
C	Z	S	O	P	A									
?	r	r	?	r	?									
AAS	No operands	<b>ASCII Adjust after Subtraction.</b> Corrects result in AH and AL after subtraction when working with BCD values.  <b>Algorithm:</b>  if low nibble of AL > 9 or AF = 1 then:												



		<ul style="list-style-type: none"> <li>• AL = AL - 6</li> <li>• AH = AH - 1</li> <li>• AF = 1</li> <li>• CF = 1</li> </ul>  else <ul style="list-style-type: none"> <li>• AF = 0</li> <li>• CF = 0</li> </ul> <p>in both cases: clear the high nibble of AL.</p> <p><b>Example:</b> MOV AX, 02FFh ; AH = 02, AL = 0FFh AAS ; AH = 01, AL = 09 RET</p> <table border="1" data-bbox="555 770 746 864"> <tr><td>C</td><td>Z</td><td>S</td><td>O</td><td>P</td><td>A</td></tr> <tr><td>r</td><td>?</td><td>?</td><td>?</td><td>?</td><td>r</td></tr> </table>	C	Z	S	O	P	A	r	?	?	?	?	r
C	Z	S	O	P	A									
r	?	?	?	?	r									
ADC	REG, memory memory, REG REG, REG memory, immediate REG, immediate	 Add with Carry. <p><b>Algorithm:</b></p> $\text{operand1} = \text{operand1} + \text{operand2} + \text{CF}$ <p><b>Example:</b> STC ; set CF = 1 MOV AL, 5 ; AL = 5 ADC AL, 1 ; AL = 7 RET</p> <table border="1" data-bbox="555 1330 746 1424"> <tr><td>C</td><td>Z</td><td>S</td><td>O</td><td>P</td><td>A</td></tr> <tr><td>r</td><td>r</td><td>r</td><td>r</td><td>r</td><td>r</td></tr> </table>	C	Z	S	O	P	A	r	r	r	r	r	r
C	Z	S	O	P	A									
r	r	r	r	r	r									
ADD	REG, memory memory, REG REG, REG memory, immediate REG, immediate	 Add. <p><b>Algorithm:</b></p> $\text{operand1} = \text{operand1} + \text{operand2}$ <p><b>Example:</b> MOV AL, 5 ; AL = 5 ADD AL, -3 ; AL = 2 RET</p> <table border="1" data-bbox="555 1854 746 1948"> <tr><td>C</td><td>Z</td><td>S</td><td>O</td><td>P</td><td>A</td></tr> <tr><td>r</td><td>r</td><td>r</td><td>r</td><td>r</td><td>r</td></tr> </table>	C	Z	S	O	P	A	r	r	r	r	r	r
C	Z	S	O	P	A									
r	r	r	r	r	r									
AND	REG, memory	Logical AND between all bits of two operands. Result is stored in												



	<p>memory, REG REG, REG memory, immediate REG, immediate</p>	<p> operand1.</p> <p>These rules apply:</p> <p>1 AND 1 = 1 1 AND 0 = 0 0 AND 1 = 0 0 AND 0 = 0</p> <p>Example: MOV AL, 'a' ; AL = 01100001b AND AL, 11011111b ; AL = 01000001b ('A') RET</p> <table border="1" data-bbox="555 622 715 712"> <tr><td>C</td><td>Z</td><td>S</td><td>O</td><td>P</td></tr> <tr><td>0</td><td>r</td><td>r</td><td>0</td><td>r</td></tr> </table>	C	Z	S	O	P	0	r	r	0	r		
C	Z	S	O	P										
0	r	r	0	r										
CALL	<p>procedure name label 4-byte address</p>	<p> Transfers control to procedure, return address is (IP) is pushed to stack. 4-byte address may be entered in this form: 1234h:5678h, first value is a segment second value is an offset (this is a far call, so CS is also pushed to stack).</p> <p>Example:</p> <p>ORG 100h ; directive to make simple .com file.</p> <p>CALL p1</p> <p>ADD AX, 1</p> <p>RET ; return to OS.</p> <p>p1 PROC ; procedure declaration. MOV AX, 1234h RET ; return to caller. p1 ENDP</p> <table border="1" data-bbox="555 1424 746 1514"> <tr><td>C</td><td>Z</td><td>S</td><td>O</td><td>P</td><td>A</td></tr> <tr><td colspan="6">unchanged</td></tr> </table>	C	Z	S	O	P	A	unchanged					
C	Z	S	O	P	A									
unchanged														
CBW	<p>No operands</p>	<p>Convert byte into word.</p> <p>Algorithm:</p> <p>if high bit of AL = 1 then:</p> <ul style="list-style-type: none"> <li>AH = 255 (0FFh)</li> </ul> <p>else</p> <ul style="list-style-type: none"> <li>AH = 0</li> </ul>												



		 <b>Example:</b> MOV AX, 0 ; AH = 0, AL = 0 MOV AL, -5 ; AX = 000FBh (251) CBW ; AX = 0FFFBh (-5) RET <table border="1" data-bbox="555 331 746 427"> <tr> <td>C</td> <td>Z</td> <td>S</td> <td>O</td> <td>P</td> <td>A</td> </tr> <tr> <td colspan="6">unchanged</td> </tr> </table>	C	Z	S	O	P	A	unchanged					
C	Z	S	O	P	A									
unchanged														
CLC	No operands	 Clear Carry flag. Algorithm: CF = 0 <table border="1" data-bbox="555 701 592 797"> <tr> <td>C</td> </tr> <tr> <td>0</td> </tr> </table>	C	0										
C														
0														
CLD	No operands	 Clear Direction flag. SI and DI will be incremented by chain instructions: CMPSB, CMPSW, LODSB, LODSW, MOVSB, MOVSW, STOSB, STOSW. Algorithm: DF = 0 <table border="1" data-bbox="555 1137 592 1234"> <tr> <td>D</td> </tr> <tr> <td>0</td> </tr> </table>	D	0										
D														
0														
CLI	No operands	 Clear Interrupt enable flag. This disables hardware interrupts. Algorithm: IF = 0 <table border="1" data-bbox="555 1541 592 1637"> <tr> <td>I</td> </tr> <tr> <td>0</td> </tr> </table>	I	0										
I														
0														
CMC	No operands	Complement Carry flag. Inverts value of CF. Algorithm: if CF = 1 then CF = 0 if CF = 0 then CF = 1 <table border="1" data-bbox="555 1966 592 2063"> <tr> <td>C</td> </tr> <tr> <td>r</td> </tr> </table>	C	r										
C														
r														





														
CMP	REG, memory memory, REG REG, REG memory, immediate REG, immediate	 Compare. Algorithm: operand1 - operand2 result is not stored anywhere, flags are set (OF, SF, ZF, AF, PF, CF) according to result. Example: MOV AL, 5 MOV BL, 5 CMP AL, BL ; AL = 5, ZF = 1 (so equal!) RET <table border="1" data-bbox="555 734 746 831"> <tr><td>C</td><td>Z</td><td>S</td><td>O</td><td>P</td><td>A</td></tr> <tr><td>r</td><td>r</td><td>r</td><td>r</td><td>r</td><td>r</td></tr> </table>	C	Z	S	O	P	A	r	r	r	r	r	r
C	Z	S	O	P	A									
r	r	r	r	r	r									
CMPSB	No operands	Compare bytes: ES:[DI] from DS:[SI]. Algorithm: <ul style="list-style-type: none"> <li>• DS:[SI] - ES:[DI]</li> <li>• set flags according to result: OF, SF, ZF, AF, PF, CF</li> <li>• if DF = 0 then <ul style="list-style-type: none"> <li>○ SI = SI + 1</li> <li>○ DI = DI + 1</li> </ul> </li> </ul> else  <ul style="list-style-type: none"> <li>○ SI = SI - 1</li> <li>○ DI = DI - 1</li> </ul> Example: see <a href="#">cmpsb.asm</a> in c:\emu8086\examples\ <table border="1" data-bbox="555 1541 746 1637"> <tr><td>C</td><td>Z</td><td>S</td><td>O</td><td>P</td><td>A</td></tr> <tr><td>r</td><td>r</td><td>r</td><td>r</td><td>r</td><td>r</td></tr> </table>	C	Z	S	O	P	A	r	r	r	r	r	r
C	Z	S	O	P	A									
r	r	r	r	r	r									
CMPSW	No operands	Compare words: ES:[DI] from DS:[SI]. Algorithm: <ul style="list-style-type: none"> <li>• DS:[SI] - ES:[DI]</li> <li>• set flags according to result: OF, SF, ZF, AF, PF, CF</li> <li>• if DF = 0 then <ul style="list-style-type: none"> <li>○ SI = SI + 2</li> <li>○ DI = DI + 2</li> </ul> </li> </ul>												







		 else <ul style="list-style-type: none"> <li>○ SI = SI - 2</li> <li>○ DI = DI - 2</li> </ul> <p>Example: see <a href="#">cmpsw.asm</a> in c:\emu8086\examples\.</p> <table border="1" data-bbox="555 443 746 539"> <tr><td>C</td><td>Z</td><td>S</td><td>O</td><td>P</td><td>A</td></tr> <tr><td>r</td><td>r</td><td>r</td><td>r</td><td>r</td><td>r</td></tr> </table>	C	Z	S	O	P	A	r	r	r	r	r	r
C	Z	S	O	P	A									
r	r	r	r	r	r									
CWD	No operands	<p>Convert Word to Double word.</p> <p>Algorithm:</p> <p>if high bit of AX = 1 then:</p> <ul style="list-style-type: none"> <li>• DX = 65535 (0FFFFh)</li> </ul> <p>else</p> <ul style="list-style-type: none"> <li>• DX = 0</li> </ul>  Example: MOV DX, 0 ; DX = 0 MOV AX, 0 ; AX = 0 MOV AX, -5 ; DX AX = 00000h:0FFFBh CWD ; DX AX = 0FFFFh:0FFFBh RET <table border="1" data-bbox="555 1272 746 1368"> <tr><td>C</td><td>Z</td><td>S</td><td>O</td><td>P</td><td>A</td></tr> <tr><td colspan="6">unchanged</td></tr> </table>	C	Z	S	O	P	A	unchanged					
C	Z	S	O	P	A									
unchanged														
DAA	No operands	<p>Decimal adjust After Addition. Corrects the result of addition of two packed BCD values.</p> <p>Algorithm:</p> <p>if low nibble of AL &gt; 9 or AF = 1 then:</p> <ul style="list-style-type: none"> <li>• AL = AL + 6</li> <li>• AF = 1</li> </ul> <p>if AL &gt; 9Fh or CF = 1 then:</p> <ul style="list-style-type: none"> <li>• AL = AL + 60h</li> <li>• CF = 1</li> </ul> <p>Example: MOV AL, 0Fh ; AL = 0Fh (15)</p>												

		 <pre>DAA      ; AL = 15h RET</pre> <table border="1" data-bbox="619 241 810 338"> <tr><td>C</td><td>Z</td><td>S</td><td>O</td><td>P</td><td>A</td></tr> <tr><td>r</td><td>r</td><td>r</td><td>r</td><td>r</td><td>r</td></tr> </table>	C	Z	S	O	P	A	r	r	r	r	r	r
C	Z	S	O	P	A									
r	r	r	r	r	r									
DAS	No operands	<p>Decimal adjust After Subtraction. Corrects the result of subtraction of two packed BCD values.</p> <p>Algorithm:</p> <p>if low nibble of AL &gt; 9 or AF = 1 then:</p> <ul style="list-style-type: none"> <li>AL = AL - 6</li> <li>AF = 1</li> </ul> <p> if AL &gt; 9Fh or CF = 1 then:</p> <ul style="list-style-type: none"> <li>AL = AL - 60h</li> <li>CF = 1</li> </ul> <p>Example: MOV AL, 0FFh ; AL = 0FFh (-1) DAS      ; AL = 99h, CF = 1 RET</p> <table border="1" data-bbox="555 1077 746 1173"> <tr><td>C</td><td>Z</td><td>S</td><td>O</td><td>P</td><td>A</td></tr> <tr><td>r</td><td>r</td><td>r</td><td>r</td><td>r</td><td>r</td></tr> </table>	C	Z	S	O	P	A	r	r	r	r	r	r
C	Z	S	O	P	A									
r	r	r	r	r	r									
DEC	REG memory	 Decrement. <p>Algorithm:</p> <p>operand = operand - 1</p> <p>Example: MOV AL, 255 ; AL = 0FFh (255 or -1) DEC AL      ; AL = 0FEh (254 or -2) RET</p> <table border="1" data-bbox="555 1599 715 1695"> <tr><td>Z</td><td>S</td><td>O</td><td>P</td><td>A</td></tr> <tr><td>r</td><td>r</td><td>r</td><td>r</td><td>r</td></tr> </table> <p>CF - unchanged!</p>	Z	S	O	P	A	r	r	r	r	r		
Z	S	O	P	A										
r	r	r	r	r										
DIV	REG memory	<p>Unsigned divide.</p> <p>Algorithm:</p> <p>when operand is a <b>byte</b>: AL = AX / operand AH = remainder (modulus)</p> <p>when operand is a <b>word</b>: AX = (DX AX) / operand</p>												



		 DX = remainder (modulus) <b>Example:</b> MOV AX, 203 ; AX = 00CBh MOV BL, 4 DIV BL ; AL = 50 (32h), AH = 3 RET <table border="1" data-bbox="555 365 746 456"> <tr><td>C</td><td>Z</td><td>S</td><td>O</td><td>P</td><td>A</td></tr> <tr><td>?</td><td>?</td><td>?</td><td>?</td><td>?</td><td>?</td></tr> </table>	C	Z	S	O	P	A	?	?	?	?	?	?
C	Z	S	O	P	A									
?	?	?	?	?	?									
HLT	No operands	 Halt the System. <b>Example:</b> MOV AX, 5 HLT <table border="1" data-bbox="555 701 746 792"> <tr><td>C</td><td>Z</td><td>S</td><td>O</td><td>P</td><td>A</td></tr> <tr><td colspan="6">unchanged</td></tr> </table>	C	Z	S	O	P	A	unchanged					
C	Z	S	O	P	A									
unchanged														
IDIV	REG memory	 Signed divide. Algorithm: when operand is a <b>byte</b> : AL = AX / operand AH = remainder (modulus) when operand is a <b>word</b> : AX = (DX AX) / operand DX = remainder (modulus) <b>Example:</b> MOV AX, -203 ; AX = 0FF35h MOV BL, 4 IDIV BL ; AL = -50 (0CEh), AH = -3 (0FDh) RET <table border="1" data-bbox="555 1350 746 1442"> <tr><td>C</td><td>Z</td><td>S</td><td>O</td><td>P</td><td>A</td></tr> <tr><td>?</td><td>?</td><td>?</td><td>?</td><td>?</td><td>?</td></tr> </table>	C	Z	S	O	P	A	?	?	?	?	?	?
C	Z	S	O	P	A									
?	?	?	?	?	?									
IMUL	REG memory	Signed multiply. Algorithm: when operand is a <b>byte</b> : AX = AL * operand. when operand is a <b>word</b> : (DX AX) = AX * operand. <b>Example:</b> MOV AL, -2 MOV BL, -4 IMUL BL ; AX = 8 RET <table border="1" data-bbox="555 1933 746 2024"> <tr><td>C</td><td>Z</td><td>S</td><td>O</td><td>P</td><td>A</td></tr> <tr><td>r</td><td>?</td><td>?</td><td>r</td><td>?</td><td>?</td></tr> </table>	C	Z	S	O	P	A	r	?	?	r	?	?
C	Z	S	O	P	A									
r	?	?	r	?	?									

		 CF=OF=0 when result fits into operand of IMUL.														
IN	AL, im.byte AL, DX AX, im.byte AX, DX	Input from port into <b>AL</b> or <b>AX</b> . Second operand is a port number. If required to access port number over 255 - <b>DX</b> register should be used.  Example: IN AX, 4 ; get status of traffic lights. IN AL, 7 ; get status of stepper-motor. <table border="1" data-bbox="560 495 746 584"> <tr><td>C</td><td>Z</td><td>S</td><td>O</td><td>P</td><td>A</td></tr> <tr><td colspan="6">unchanged</td></tr> </table>	C	Z	S	O	P	A	unchanged							
C	Z	S	O	P	A											
unchanged																
INC	REG memory	 Increment. Algorithm: operand = operand + 1  Example: MOV AL, 4 INC AL ; AL = 5 RET <table border="1" data-bbox="560 981 715 1070"> <tr><td>Z</td><td>S</td><td>O</td><td>P</td><td>A</td></tr> <tr><td>r</td><td>r</td><td>r</td><td>r</td><td>r</td></tr> </table> CF - unchanged!	Z	S	O	P	A	r	r	r	r	r				
Z	S	O	P	A												
r	r	r	r	r												
INT	immediate byte	 Interrupt numbered by immediate byte (0..255). Algorithm: Push to stack: <ul style="list-style-type: none"> <li>○ flags register</li> <li>○ CS</li> <li>○ IP</li> <li>• IF = 0</li> <li>• Transfer control to interrupt procedure</li> </ul> Example: MOV AH, 0Eh ; teletype. MOV AL, 'A' INT 10h ; BIOS interrupt. RET <table border="1" data-bbox="560 1738 775 1827"> <tr><td>C</td><td>Z</td><td>S</td><td>O</td><td>P</td><td>A</td><td>I</td></tr> <tr><td colspan="6">unchanged</td><td>0</td></tr> </table>	C	Z	S	O	P	A	I	unchanged						0
C	Z	S	O	P	A	I										
unchanged						0										
INTO	No operands	Interrupt 4 if Overflow flag is 1. Algorithm:														





		 if OF = 1 then INT 4 <b>Example:</b> ; -5 - 127 = -132 (not in -128..127) ; the result of SUB is wrong (124), ; so OF = 1 is set: MOV AL, -5 SUB AL, 127 ; AL = 7Ch (124) INTO ; process error. RET												
IRET	No operands	 Interrupt Return. <b>Algorithm:</b> Pop from stack: <ul style="list-style-type: none"> <li>○ IP</li> <li>○ CS</li> <li>○ flags register</li> </ul> <table border="1" data-bbox="555 891 746 987"> <tr> <td>C</td> <td>Z</td> <td>S</td> <td>O</td> <td>P</td> <td>A</td> </tr> <tr> <td colspan="6">popped</td> </tr> </table>	C	Z	S	O	P	A	popped					
C	Z	S	O	P	A									
popped														
JA	label	 Short Jump if first operand is Above second operand (as set by CMP instruction). Unsigned. <b>Algorithm:</b> if (CF = 0) and (ZF = 0) then jump <b>Example:</b> include 'emu8086.inc'  ORG 100h MOV AL, 250 CMP AL, 5 JA label1 PRINT 'AL is not above 5' JMP exit label1: PRINT 'AL is above 5' exit: RET <table border="1" data-bbox="555 1659 746 1756"> <tr> <td>C</td> <td>Z</td> <td>S</td> <td>O</td> <td>P</td> <td>A</td> </tr> <tr> <td colspan="6">unchanged</td> </tr> </table>	C	Z	S	O	P	A	unchanged					
C	Z	S	O	P	A									
unchanged														
JAE	label	Short Jump if first operand is Above or Equal to second operand (as set by CMP instruction). Unsigned. <b>Algorithm:</b> if CF = 0 then jump <b>Example:</b>												



		 <pre>include 'emu8086.inc' ORG 100h MOV AL, 5 CMP AL, 5 JAE label1 PRINT 'AL is not above or equal to 5' JMP exit label1: PRINT 'AL is above or equal to 5' exit: RET</pre> <table border="1" data-bbox="560 546 746 640"> <tr> <td>C</td><td>Z</td><td>S</td><td>O</td><td>P</td><td>A</td> </tr> <tr> <td colspan="6">unchanged</td> </tr> </table>	C	Z	S	O	P	A	unchanged					
C	Z	S	O	P	A									
unchanged														
JB	label	 <p>Short Jump if first operand is Below second operand (as set by CMP instruction). Unsigned.</p> <p>Algorithm:</p> <p>if CF = 1 then jump</p> <p>Example:</p> <pre>include 'emu8086.inc' ORG 100h MOV AL, 1 CMP AL, 5 JB label1 PRINT 'AL is not below 5' JMP exit label1: PRINT 'AL is below 5' exit: RET</pre> <table border="1" data-bbox="560 1314 746 1408"> <tr> <td>C</td><td>Z</td><td>S</td><td>O</td><td>P</td><td>A</td> </tr> <tr> <td colspan="6">unchanged</td> </tr> </table>	C	Z	S	O	P	A	unchanged					
C	Z	S	O	P	A									
unchanged														
JBE	label	<p>Short Jump if first operand is Below or Equal to second operand (as set by CMP instruction). Unsigned.</p> <p>Algorithm:</p> <p>if CF = 1 or ZF = 1 then jump</p> <p>Example:</p> <pre>include 'emu8086.inc' ORG 100h MOV AL, 5 CMP AL, 5 JBE label1 PRINT 'AL is not below or equal to 5' JMP exit label1: PRINT 'AL is below or equal to 5' exit:</pre>												



		 RET <table border="1" data-bbox="619 210 807 300"> <tr> <td>C</td> <td>Z</td> <td>S</td> <td>O</td> <td>P</td> <td>A</td> </tr> <tr> <td colspan="6">unchanged</td> </tr> </table>	C	Z	S	O	P	A	unchanged					
C	Z	S	O	P	A									
unchanged														
JC	label	 Short Jump if Carry flag is set to 1. Algorithm: if CF = 1 then jump <b>Example:</b> include 'emu8086.inc'  ORG 100h MOV AL, 255 ADD AL, 1 JC label1 PRINT 'no carry.' JMP exit label1: PRINT 'has carry.' exit: RET <table border="1" data-bbox="555 947 743 1037"> <tr> <td>C</td> <td>Z</td> <td>S</td> <td>O</td> <td>P</td> <td>A</td> </tr> <tr> <td colspan="6">unchanged</td> </tr> </table>	C	Z	S	O	P	A	unchanged					
C	Z	S	O	P	A									
unchanged														
JCXZ	label	Short Jump if CX register is 0. Algorithm: if CX = 0 then jump <b>Example:</b> include 'emu8086.inc'  ORG 100h MOV CX, 0 JCXZ label1 PRINT 'CX is not zero.' JMP exit label1: PRINT 'CX is zero.' exit: RET <table border="1" data-bbox="555 1653 743 1742"> <tr> <td>C</td> <td>Z</td> <td>S</td> <td>O</td> <td>P</td> <td>A</td> </tr> <tr> <td colspan="6">unchanged</td> </tr> </table>	C	Z	S	O	P	A	unchanged					
C	Z	S	O	P	A									
unchanged														
JE	label	Short Jump if first operand is Equal to second operand (as set by CMP instruction). Signed/Unsigned. Algorithm: if ZF = 1 then jump <b>Example:</b>												



		 <pre>include 'emu8086.inc' ORG 100h MOV AL, 5 CMP AL, 5 JE label1 PRINT 'AL is not equal to 5.' JMP exit label1: PRINT 'AL is equal to 5.' exit: RET</pre> <table border="1" data-bbox="560 546 746 640"> <tr> <td>C</td><td>Z</td><td>S</td><td>O</td><td>P</td><td>A</td> </tr> <tr> <td colspan="6">unchanged</td> </tr> </table>	C	Z	S	O	P	A	unchanged					
C	Z	S	O	P	A									
unchanged														
JG	label	<p>Short Jump if first operand is Greater then second operand (as set by CMP instruction). Signed.</p> <p>Algorithm:</p> <p>if (ZF = 0) and (SF = OF) then jump</p> <p>Example:</p> <pre>include 'emu8086.inc' ORG 100h MOV AL, 5 CMP AL, -5 JG label1 PRINT 'AL is not greater -5.' JMP exit label1: PRINT 'AL is greater -5.' exit: RET</pre>  <table border="1" data-bbox="560 1312 746 1406"> <tr> <td>C</td><td>Z</td><td>S</td><td>O</td><td>P</td><td>A</td> </tr> <tr> <td colspan="6">unchanged</td> </tr> </table>	C	Z	S	O	P	A	unchanged					
C	Z	S	O	P	A									
unchanged														
JGE	label	<p>Short Jump if first operand is Greater or Equal to second operand (as set by CMP instruction). Signed.</p> <p>Algorithm:</p> <p>if SF = OF then jump</p> <p>Example:</p> <pre>include 'emu8086.inc' ORG 100h MOV AL, 2 CMP AL, -5 JGE label1 PRINT 'AL &lt; -5' JMP exit label1: PRINT 'AL &gt;= -5' exit:</pre>												







		 <pre>RET C Z S O P A unchanged</pre>
JL	label	<p>Short Jump if first operand is Less then second operand (as set by CMP instruction). Signed.</p> <p>Algorithm:</p> <p style="padding-left: 40px;">if SF <math>\neq</math> OF then jump</p> <p>Example:</p> <pre>include 'emu8086.inc'  ORG 100h MOV AL, -2 CMP AL, 5 JL label1 PRINT 'AL &gt;= 5.' JMP exit label1: PRINT 'AL &lt; 5.' exit: RET</pre>  <pre>C Z S O P A unchanged</pre>
JLE	label	 <p>Short Jump if first operand is Less or Equal to second operand (as set by CMP instruction). Signed.</p> <p>Algorithm:</p> <p style="padding-left: 40px;">if SF <math>\neq</math> OF or ZF = 1 then jump</p> <p>Example:</p> <pre>include 'emu8086.inc'  ORG 100h MOV AL, -2 CMP AL, 5 JLE label1 PRINT 'AL &gt; 5.' JMP exit label1: PRINT 'AL &lt;= 5.' exit: RET</pre>  <pre>C Z S O P A unchanged</pre>
JMP	label 4-byte address	<p>Unconditional Jump. Transfers control to another part of the program. <i>4-byte address</i> may be entered in this form: 1234h:5678h, first value is a segment second value is an offset.</p>



		<p><b>Algorithm:</b></p> <p>always jump</p> <p><b>Example:</b> include 'emu8086.inc'</p> <pre> ORG 100h MOV AL, 5 JMP label1 ; jump over 2 lines! PRINT 'Not Jumped!' MOV AL, 0 label1: PRINT 'Got Here!' RET </pre>  <table border="1" data-bbox="555 645 746 734"> <tr> <td>C</td><td>Z</td><td>S</td><td>O</td><td>P</td><td>A</td> </tr> <tr> <td colspan="6">unchanged</td> </tr> </table>	C	Z	S	O	P	A	unchanged					
C	Z	S	O	P	A									
unchanged														
JNA	label	 Short Jump if first operand is Not Above second operand (as set by CMP instruction). Unsigned. <p><b>Algorithm:</b></p> <p>if CF = 1 or ZF = 1 then jump</p> <p><b>Example:</b> include 'emu8086.inc'</p> <pre> ORG 100h MOV AL, 2 CMP AL, 5 JNA label1 PRINT 'AL is above 5.' JMP exit label1: PRINT 'AL is not above 5.' exit: RET </pre>  <table border="1" data-bbox="555 1413 746 1503"> <tr> <td>C</td><td>Z</td><td>S</td><td>O</td><td>P</td><td>A</td> </tr> <tr> <td colspan="6">unchanged</td> </tr> </table>	C	Z	S	O	P	A	unchanged					
C	Z	S	O	P	A									
unchanged														
JNAE	label	<p>Short Jump if first operand is Not Above and Not Equal to second operand (as set by CMP instruction). Unsigned.</p> <p><b>Algorithm:</b></p> <p>if CF = 1 then jump</p> <p><b>Example:</b> include 'emu8086.inc'</p> <pre> ORG 100h MOV AL, 2 CMP AL, 5 JNAE label1 PRINT 'AL &gt;= 5.' JMP exit </pre>												



		 <pre> label1: PRINT 'AL &lt; 5.' exit: RET </pre> <div style="border: 1px solid black; padding: 2px; display: inline-block;"> C Z S O P A  unchanged </div>
JNB	label	 <p>Short Jump if first operand is Not Below second operand (as set by CMP instruction). Unsigned.</p> <p>Algorithm:</p> <p style="padding-left: 40px;">if CF = 0 then jump</p> <p>Example:</p> <pre> include 'emu8086.inc'  ORG 100h MOV AL, 7 CMP AL, 5 JNB label1 PRINT 'AL &lt; 5.' JMP exit label1: PRINT 'AL &gt;= 5.' exit: RET </pre> <div style="border: 1px solid black; padding: 2px; display: inline-block;"> C Z S O P A  unchanged </div>
JNBE	label	 <p>Short Jump if first operand is Not Below and Not Equal to second operand (as set by CMP instruction). Unsigned.</p> <p>Algorithm:</p> <p style="padding-left: 40px;">if (CF = 0) and (ZF = 0) then jump</p> <p>Example:</p> <pre> include 'emu8086.inc'  ORG 100h MOV AL, 7 CMP AL, 5 JNBE label1 PRINT 'AL &lt;= 5.' JMP exit label1: PRINT 'AL &gt; 5.' exit: RET </pre> <div style="border: 1px solid black; padding: 2px; display: inline-block;"> C Z S O P A  unchanged </div>
JNC	label	Short Jump if Carry flag is set to 0.

		 <b>Algorithm:</b> <p style="padding-left: 40px;">if CF = 0 then jump</p> <b>Example:</b> include 'emu8086.inc'  ORG 100h MOV AL, 2 ADD AL, 3 JNC label1 PRINT 'has carry.' JMP exit label1: PRINT 'no carry.' exit: RET <table border="1" style="margin-left: 40px;"> <tr> <td>C</td><td>Z</td><td>S</td><td>O</td><td>P</td><td>A</td> </tr> <tr> <td colspan="6" style="text-align: center;">unchanged</td> </tr> </table>	C	Z	S	O	P	A	unchanged					
C	Z	S	O	P	A									
unchanged														
JNE	label	 <b>Short Jump if first operand is Not Equal to second operand (as set by CMP instruction). Signed/Unsigned.</b>  <b>Algorithm:</b> <p style="padding-left: 40px;">if ZF = 0 then jump</p> <b>Example:</b> include 'emu8086.inc'  ORG 100h MOV AL, 2 CMP AL, 3 JNE label1 PRINT 'AL = 3.' JMP exit label1: PRINT 'AI <> 3.' exit: RET <table border="1" style="margin-left: 40px;"> <tr> <td>C</td><td>Z</td><td>S</td><td>O</td><td>P</td><td>A</td> </tr> <tr> <td colspan="6" style="text-align: center;">unchanged</td> </tr> </table>	C	Z	S	O	P	A	unchanged					
C	Z	S	O	P	A									
unchanged														
JNG	label	<b>Short Jump if first operand is Not Greater than second operand (as set by CMP instruction). Signed.</b>  <b>Algorithm:</b> <p style="padding-left: 40px;">if (ZF = 1) and (SF &lt;&gt; OF) then jump</p> <b>Example:</b> include 'emu8086.inc'  ORG 100h MOV AL, 2 CMP AL, 3 JNG label1												

		 <pre> PRINT 'AL &gt; 3.' JMP exit label1: PRINT 'Al &lt;= 3.' exit: RET </pre> <table border="1" data-bbox="560 365 746 456"> <tr> <td>C</td><td>Z</td><td>S</td><td>O</td><td>P</td><td>A</td> </tr> <tr> <td colspan="6">unchanged</td> </tr> </table>	C	Z	S	O	P	A	unchanged					
C	Z	S	O	P	A									
unchanged														
JNGE	label	 <p>Short Jump if first operand is Not Greater and Not Equal to second operand (as set by CMP instruction). Signed.</p> <p>Algorithm:</p> <p>if SF <math>\neq</math> OF then jump</p> <p>Example:</p> <pre> include 'emu8086.inc'  ORG 100h MOV AL, 2 CMP AL, 3 JNGE label1 PRINT 'AL &gt;= 3.' JMP exit label1: PRINT 'Al &lt; 3.' exit: RET </pre> <table border="1" data-bbox="560 1133 746 1225"> <tr> <td>C</td><td>Z</td><td>S</td><td>O</td><td>P</td><td>A</td> </tr> <tr> <td colspan="6">unchanged</td> </tr> </table>	C	Z	S	O	P	A	unchanged					
C	Z	S	O	P	A									
unchanged														
JNL	label	<p>Short Jump if first operand is Not Less than second operand (as set by CMP instruction). Signed.</p> <p>Algorithm:</p>  <p>if SF = OF then jump</p> <p>Example:</p> <pre> include 'emu8086.inc'  ORG 100h MOV AL, 2 CMP AL, -3 JNL label1 PRINT 'AL &lt; -3.' JMP exit label1: PRINT 'Al &gt;= -3.' exit: RET </pre> <table border="1" data-bbox="560 1899 746 1991"> <tr> <td>C</td><td>Z</td><td>S</td><td>O</td><td>P</td><td>A</td> </tr> <tr> <td colspan="6">unchanged</td> </tr> </table>	C	Z	S	O	P	A	unchanged					
C	Z	S	O	P	A									
unchanged														



JNLE	label	 Short Jump if first operand is Not Less and Not Equal to second operand (as set by CMP instruction). Signed. <b>Algorithm:</b> if (SF = OF) and (ZF = 0) then jump <b>Example:</b> include 'emu8086.inc'  ORG 100h MOV AL, 2 CMP AL, -3 JNLE label1 PRINT 'AL <= -3.' JMP exit label1: PRINT 'Al > -3.' exit: RET <table border="1" data-bbox="555 770 746 864"> <tr> <td>C</td><td>Z</td><td>S</td><td>O</td><td>P</td><td>A</td> </tr> <tr> <td colspan="6">unchanged</td> </tr> </table>	C	Z	S	O	P	A	unchanged					
C	Z	S	O	P	A									
unchanged														
JNO	label	<b>Short Jump if Not Overflow.</b> <b>Algorithm:</b> if OF = 0 then jump <b>Example:</b> ; -5 - 2 = -7 (inside -128..127) ; the result of SUB is correct,  ; so OF = 0:  include 'emu8086.inc'  ORG 100h MOV AL, -5 SUB AL, 2 ; AL = 0F9h (-7) JNO label1 PRINT 'overflow!' JMP exit label1: PRINT 'no overflow.' exit: RET <table border="1" data-bbox="555 1630 746 1724"> <tr> <td>C</td><td>Z</td><td>S</td><td>O</td><td>P</td><td>A</td> </tr> <tr> <td colspan="6">unchanged</td> </tr> </table>	C	Z	S	O	P	A	unchanged					
C	Z	S	O	P	A									
unchanged														
JNP	label	<b>Short Jump if No Parity (odd). Only 8 low bits of result are checked. Set by CMP, SUB, ADD, TEST, AND, OR, XOR instructions.</b> <b>Algorithm:</b> if PF = 0 then jump <b>Example:</b>												



		 <pre>include 'emu8086.inc'  ORG 100h MOV AL, 00000111b ; AL = 7 OR AL, 0 ; just set flags. JNP label1 PRINT 'parity even.' JMP exit label1: PRINT 'parity odd.' exit: RET</pre> <table border="1" data-bbox="560 546 746 640"> <tr> <td>C</td><td>Z</td><td>S</td><td>O</td><td>P</td><td>A</td> </tr> <tr> <td colspan="6">unchanged</td> </tr> </table>	C	Z	S	O	P	A	unchanged					
C	Z	S	O	P	A									
unchanged														
JNS	label	<p>Short Jump if Not Signed (if positive). Set by CMP, SUB, ADD, TEST, AND, OR, XOR instructions.</p> <p>Algorithm:</p> <p>if SF = 0 then jump</p> <p><b>Example:</b></p>  <pre>include 'emu8086.inc'  ORG 100h MOV AL, 00000111b ; AL = 7 OR AL, 0 ; just set flags. JNS label1 PRINT 'signed.' JMP exit label1: PRINT 'not signed.' exit: RET</pre> <table border="1" data-bbox="560 1317 746 1411"> <tr> <td>C</td><td>Z</td><td>S</td><td>O</td><td>P</td><td>A</td> </tr> <tr> <td colspan="6">unchanged</td> </tr> </table>	C	Z	S	O	P	A	unchanged					
C	Z	S	O	P	A									
unchanged														
JNZ	label	<p>Short Jump if Not Zero (not equal). Set by CMP, SUB, ADD, TEST, AND, OR, XOR instructions.</p> <p>Algorithm:</p> <p>if ZF = 0 then jump</p> <p><b>Example:</b></p> <pre>include 'emu8086.inc'  ORG 100h MOV AL, 00000111b ; AL = 7 OR AL, 0 ; just set flags. JNZ label1 PRINT 'zero.' JMP exit label1: PRINT 'not zero.' exit:</pre>												



		 RET <table border="1" data-bbox="619 210 807 302"> <tr> <td>C</td> <td>Z</td> <td>S</td> <td>O</td> <td>P</td> <td>A</td> </tr> <tr> <td colspan="6">unchanged</td> </tr> </table>	C	Z	S	O	P	A	unchanged					
C	Z	S	O	P	A									
unchanged														
JO	label	<p>Short Jump if Overflow.</p> <p>Algorithm:</p> <p>if OF = 1 then jump</p> <p>Example:</p> <pre>; -5 - 127 = -132 (not in -128..127) ; the result of SUB is wrong (124), ; so OF = 1 is set:</pre> <pre>include 'emu8086.inc' org 100h MOV AL, -5 SUB AL, 127 ; AL = 7Ch (124) JO label1 PRINT 'no overflow.' JMP exit label1: PRINT 'overflow!' exit: RET</pre> <table border="1" data-bbox="560 1070 748 1162"> <tr> <td>C</td> <td>Z</td> <td>S</td> <td>O</td> <td>P</td> <td>A</td> </tr> <tr> <td colspan="6">unchanged</td> </tr> </table>	C	Z	S	O	P	A	unchanged					
C	Z	S	O	P	A									
unchanged														
JP	label	 Short Jump if Parity (even). Only 8 low bits of result are checked. Set by CMP, SUB, ADD, TEST, AND, OR, XOR instructions.												
		<p>Algorithm:</p> <p>if PF = 1 then jump</p> <p>Example:</p> <pre>include 'emu8086.inc'  ORG 100h MOV AL, 00000101b ; AL = 5 OR AL, 0 ; just set flags. JP label1 PRINT 'parity odd.' JMP exit label1: PRINT 'parity even.' exit: RET</pre> <table border="1" data-bbox="560 1868 748 1960"> <tr> <td>C</td> <td>Z</td> <td>S</td> <td>O</td> <td>P</td> <td>A</td> </tr> <tr> <td colspan="6">unchanged</td> </tr> </table>	C	Z	S	O	P	A	unchanged					
C	Z	S	O	P	A									
unchanged														





JPE	label	<p>Short Jump if Parity Even. Only 8 low bits of result are checked. Set by CMP, SUB, ADD, TEST, AND, OR, XOR instructions.</p> <p>Algorithm:</p> <p style="padding-left: 40px;">if PF = 1 then jump</p> <p>Example:</p> <pre>include 'emu8086.inc'  ORG 100h MOV AL, 00000101b ; AL = 5 OR AL, 0 ; just set flags. JPE label1 PRINT 'parity odd.' JMP exit label1: PRINT 'parity even.' exit: RET</pre> <table border="1" style="margin-left: 40px;"> <tr> <td>C</td><td>Z</td><td>S</td><td>O</td><td>P</td><td>A</td> </tr> <tr> <td colspan="6" style="text-align: center;">unchanged</td> </tr> </table>	C	Z	S	O	P	A	unchanged					
C	Z	S	O	P	A									
unchanged														
JPO	label	<p> Short Jump if Parity Odd. Only 8 low bits of result are checked. Set by CMP, SUB, ADD, TEST, AND, OR, XOR instructions.</p> <p>Algorithm:</p> <p style="padding-left: 40px;">if PF = 0 then jump</p> <p>Example:</p> <pre>include 'emu8086.inc'  ORG 100h MOV AL, 00000111b ; AL = 7 OR AL, 0 ; just set flags. JPO label1 PRINT 'parity even.' JMP exit label1: PRINT 'parity odd.' exit: RET</pre> <table border="1" style="margin-left: 40px;"> <tr> <td>C</td><td>Z</td><td>S</td><td>O</td><td>P</td><td>A</td> </tr> <tr> <td colspan="6" style="text-align: center;">unchanged</td> </tr> </table>	C	Z	S	O	P	A	unchanged					
C	Z	S	O	P	A									
unchanged														
JS	label	<p>Short Jump if Signed (if negative). Set by CMP, SUB, ADD, TEST, AND, OR, XOR instructions.</p> <p>Algorithm:</p> <p style="padding-left: 40px;">if SF = 1 then jump</p> <p>Example:</p> <pre>include 'emu8086.inc'  ORG 100h</pre>												

		<pre>MOV AL, 10000000b ; AL = -128 OR AL, 0 ; just set flags.</pre>  <pre>JS label1 PRINT 'not signed.' JMP exit  label1: PRINT 'signed.' exit: RET</pre> <table border="1" data-bbox="560 454 746 546"> <tr> <td>C</td><td>Z</td><td>S</td><td>O</td><td>P</td><td>A</td> </tr> <tr> <td colspan="6">unchanged</td> </tr> </table>	C	Z	S	O	P	A	unchanged					
C	Z	S	O	P	A									
unchanged														
JZ	label	 Short Jump if Zero (equal). Set by CMP, SUB, ADD, TEST, AND, OR, XOR instructions. <p>Algorithm:</p> <p>if ZF = 1 then jump</p> <p>Example:</p> <pre>include 'emu8086.inc'  ORG 100h MOV AL, 5 CMP AL, 5 JZ label1 PRINT 'AL is not equal to 5.' JMP exit  label1: PRINT 'AL is equal to 5.' exit: RET</pre> <table border="1" data-bbox="560 1223 746 1314"> <tr> <td>C</td><td>Z</td><td>S</td><td>O</td><td>P</td><td>A</td> </tr> <tr> <td colspan="6">unchanged</td> </tr> </table>	C	Z	S	O	P	A	unchanged					
C	Z	S	O	P	A									
unchanged														
LAHF	No operands	 Load AH from 8 low bits of Flags register. <p>Algorithm:</p> <p>AH = flags register</p> <p>AH bit: 7 6 5 4 3 2 1 0  [SF] [ZF] [0] [AF] [0] [PF] [1] [CF]  bits 1, 3, 5 are reserved.</p> <table border="1" data-bbox="560 1711 746 1803"> <tr> <td>C</td><td>Z</td><td>S</td><td>O</td><td>P</td><td>A</td> </tr> <tr> <td colspan="6">unchanged</td> </tr> </table>	C	Z	S	O	P	A	unchanged					
C	Z	S	O	P	A									
unchanged														
LDS	REG, memory	<p>Load memory double word into word register and DS.</p> <p>Algorithm:</p> <ul style="list-style-type: none"> <li>REG = first word</li> </ul>												

		 <ul style="list-style-type: none"> <li>• DS = second word</li> </ul> <p>Example:</p> <pre>ORG 100h LDS AX, m RET m DW 1234h   DW 5678h END</pre> <p>AX is set to 1234h, DS is set to 5678h.</p> <table border="1" data-bbox="560 779 746 869"> <tr> <td>C</td><td>Z</td><td>S</td><td>O</td><td>P</td><td>A</td> </tr> <tr> <td colspan="6">unchanged</td> </tr> </table>	C	Z	S	O	P	A	unchanged					
C	Z	S	O	P	A									
unchanged														
LEA	REG, memory	 Load Effective Address. <p>Algorithm:</p> <ul style="list-style-type: none"> <li>• REG = address of memory (offset)</li> </ul> <p>Example:</p> <pre>MOV BX, 35h MOV DI, 12h LEA SI, [BX+DI] ; SI = 35h + 12h = 47h</pre> <p>Note: The integrated 8086 assembler automatically replaces <b>LEA</b> with a more efficient <b>MOV</b> where possible. For example:</p> <pre>org 100h LEA AX, m ; AX = offset of m RET m dw 1234h END</pre> <table border="1" data-bbox="560 1715 746 1805"> <tr> <td>C</td><td>Z</td><td>S</td><td>O</td><td>P</td><td>A</td> </tr> <tr> <td colspan="6">unchanged</td> </tr> </table>	C	Z	S	O	P	A	unchanged					
C	Z	S	O	P	A									
unchanged														
LES	REG, memory	<p>Load memory double word into word register and ES.</p> <p>Algorithm:</p> <ul style="list-style-type: none"> <li>• REG = first word</li> </ul>												

		 <ul style="list-style-type: none"> <li>• ES = second word</li> </ul> <p>Example:</p> <pre>ORG 100h LES AX, m RET m DW 1234h   DW 5678h END</pre> <p>AX is set to 1234h, ES is set to 5678h.</p> <table border="1" data-bbox="555 775 746 869"> <tr> <td>C</td><td>Z</td><td>S</td><td>O</td><td>P</td><td>A</td> </tr> <tr> <td colspan="6">unchanged</td> </tr> </table>	C	Z	S	O	P	A	unchanged					
C	Z	S	O	P	A									
unchanged														
LODSB	No operands	<p>Load byte at DS:[SI] into AL. Update SI.</p> <p>Algorithm:</p> <ul style="list-style-type: none"> <li>• AL = DS:[SI]</li> <li>• if DF = 0 then <ul style="list-style-type: none"> <li>○ SI = SI + 1</li> </ul> </li> <li>else <ul style="list-style-type: none"> <li>○ SI = SI - 1</li> </ul> </li> </ul> <p>Example:</p>  <pre>ORG 100h LEA SI, a1 MOV CX, 5 MOV AH, 0Eh  m: LODSB INT 10h LOOP m  RET  a1 DB 'H', 'e', 'l', 'l', 'o'</pre> <table border="1" data-bbox="555 1816 746 1910"> <tr> <td>C</td><td>Z</td><td>S</td><td>O</td><td>P</td><td>A</td> </tr> <tr> <td colspan="6">unchanged</td> </tr> </table>	C	Z	S	O	P	A	unchanged					
C	Z	S	O	P	A									
unchanged														
LODSW	No operands	Load word at DS:[SI] into AX. Update SI.												

		<p> Algorithm:</p> <ul style="list-style-type: none"> <li>• AX = DS:[SI]</li> <li>• if DF = 0 then <ul style="list-style-type: none"> <li>○ SI = SI + 2</li> </ul> </li> <li>else <ul style="list-style-type: none"> <li>○ SI = SI - 2</li> </ul> </li> </ul> <p><b>Example:</b></p> <pre>ORG 100h  LEA SI, a1 MOV CX, 5  REP LODSW ; finally there will be 555h in AX.  RET  a1 dw 111h, 222h, 333h, 444h, 555h</pre> <table border="1" data-bbox="560 887 746 981"> <tr> <td>C</td><td>Z</td><td>S</td><td>O</td><td>P</td><td>A</td> </tr> <tr> <td colspan="6">unchanged</td> </tr> </table>	C	Z	S	O	P	A	unchanged					
C	Z	S	O	P	A									
unchanged														
LOOP	label	<p>Decrease CX, jump to label if CX not zero.</p> <p>Algorithm:</p> <p></p> <ul style="list-style-type: none"> <li>• CX = CX - 1</li> <li>• if CX &lt;&gt; 0 then <ul style="list-style-type: none"> <li>○ jump</li> </ul> </li> <li>else <ul style="list-style-type: none"> <li>○ no jump, continue</li> </ul> </li> </ul> <p><b>Example:</b></p> <pre>include 'emu8086.inc'  ORG 100h MOV CX, 5 label1: PRINTN 'loop!' LOOP label1 RET</pre> <table border="1" data-bbox="560 1742 746 1836"> <tr> <td>C</td><td>Z</td><td>S</td><td>O</td><td>P</td><td>A</td> </tr> <tr> <td colspan="6">unchanged</td> </tr> </table>	C	Z	S	O	P	A	unchanged					
C	Z	S	O	P	A									
unchanged														
LOOPE	label	<p>Decrease CX, jump to label if CX not zero and Equal (ZF = 1).</p> <p>Algorithm:</p>												



- $CX = CX - 1$
- if  $(CX > 0)$  and  $(ZF = 1)$  then
  - jump

else

- no jump, continue

**Example:**

; Loop until result fits into AL alone,  
; or 5 times. The result will be over 255  
; on third loop (100+100+100),  
; so loop will exit.

```
include 'emu8086.inc'
```

```
ORG 100h
MOV AX, 0
MOV CX, 5
```

label1:

```
PUTC '*'
ADD AX, 100
CMP AH, 0
LOOPE label1
RET
```

C	Z	S	O	P	A
unchanged					

Decrease CX, jump to label if CX not zero and Not Equal (ZF = 0).

**Algorithm:**

- $CX = CX - 1$
- if  $(CX > 0)$  and  $(ZF = 0)$  then
  - jump

else

- no jump, continue

**Example:**

; Loop until '7' is found,  
; or 5 times.

```
include 'emu8086.inc'
```



```
ORG 100h
MOV SI, 0
MOV CX, 5
```



label1:

```
PUTC '*'
MOV AL, v1[SI]
INC SI ; next byte (SI=SI+1).
CMP AL, 7
LOOPNE label1
```



LOOPNE



label



		 <pre> RET v1 db 9, 8, 7, 6, 5 </pre> <table border="1" data-bbox="619 241 807 331"> <tr> <td>C</td><td>Z</td><td>S</td><td>O</td><td>P</td><td>A</td> </tr> <tr> <td colspan="6">unchanged</td> </tr> </table>	C	Z	S	O	P	A	unchanged					
C	Z	S	O	P	A									
unchanged														
LOOPNZ	label	<p>Decrease CX, jump to label if CX not zero and ZF = 0.</p> <p>Algorithm:</p> <ul style="list-style-type: none"> <li>• CX = CX - 1</li> <li>• if (CX &gt; 0) and (ZF = 0) then <ul style="list-style-type: none"> <li>◦ jump</li> </ul> </li> </ul> <p>else</p> <ul style="list-style-type: none"> <li>◦ no jump, continue</li> </ul> <p> Example:</p> <pre> ; Loop until '7' is found, ; or 5 times.  include 'emu8086.inc'  ORG 100h MOV SI, 0 MOV CX, 5 label1: PUTC '*' MOV AL, v1[SI] INC SI ; next byte (SI=SI+1). CMP AL, 7 LOOPNZ label1 RET v1 db 9, 8, 7, 6, 5 </pre> <table border="1" data-bbox="560 1346 748 1435"> <tr> <td>C</td><td>Z</td><td>S</td><td>O</td><td>P</td><td>A</td> </tr> <tr> <td colspan="6">unchanged</td> </tr> </table>	C	Z	S	O	P	A	unchanged					
C	Z	S	O	P	A									
unchanged														
LOOPZ	label	<p>Decrease CX, jump to label if CX not zero and ZF = 1.</p> <p>Algorithm:</p> <ul style="list-style-type: none"> <li>• CX = CX - 1</li> <li>• if (CX &gt; 0) and (ZF = 1) then <ul style="list-style-type: none"> <li>◦ jump</li> </ul> </li> </ul> <p>else</p> <ul style="list-style-type: none"> <li>◦ no jump, continue</li> </ul> <p>Example:</p> <pre> ; Loop until result fits into AL alone, ; or 5 times. The result will be over 255 ; on third loop (100+100+100), </pre>												



		 ; so loop will exit. include 'emu8086.inc'  ORG 100h MOV AX, 0 MOV CX, 5 label1: PUTC '*' ADD AX, 100 CMP AH, 0 LOOPZ label1 RET <table border="1" data-bbox="560 577 746 667"> <tr><td>C</td><td>Z</td><td>S</td><td>O</td><td>P</td><td>A</td></tr> <tr><td colspan="6">unchanged</td></tr> </table>	C	Z	S	O	P	A	unchanged					
C	Z	S	O	P	A									
unchanged														
MOV	REG, memory memory, REG REG, REG memory, immediate REG, immediate  SREG, memory memory, SREG REG, SREG SREG, REG	 Copy operand2 to operand1. The MOV instruction <u>cannot</u> : <ul style="list-style-type: none"> <li>• set the value of the CS and IP registers.</li> <li>• copy value of one segment register to another segment register (should copy to general register first).</li> <li>• copy immediate value to segment register (should copy to general register first).</li> </ul> Algorithm: operand1 = operand2 Example: ORG 100h MOV AX, 0B800h ; set AX = B800h (VGA memory). MOV DS, AX ; copy value of AX to DS. MOV CL, 'A' ; CL = 41h (ASCII code). MOV CH, 01011111b ; CL = color attribute. MOV BX, 15Eh ; BX = position on screen. MOV [BX], CX ; w.[0B800h:015Eh] = CX. RET ; returns to operating system. <table border="1" data-bbox="560 1525 746 1615"> <tr><td>C</td><td>Z</td><td>S</td><td>O</td><td>P</td><td>A</td></tr> <tr><td colspan="6">unchanged</td></tr> </table>	C	Z	S	O	P	A	unchanged					
C	Z	S	O	P	A									
unchanged														
MOVSB	No operands	Copy byte at DS:[SI] to ES:[DI]. Update SI and DI. Algorithm: <ul style="list-style-type: none"> <li>• ES:[DI] = DS:[SI]</li> <li>• if DF = 0 then <ul style="list-style-type: none"> <li>○ SI = SI + 1</li> <li>○ DI = DI + 1</li> </ul> </li> </ul> else												











		<ul style="list-style-type: none"> <li>○ SI = SI - 1</li> <li>○ DI = DI - 1</li> </ul>  Example: ORG 100h  CLD LEA SI, a1 LEA DI, a2 MOV CX, 5 REP MOVSB  RET  a1 DB 1,2,3,4,5 a2 DB 5 DUP(0) <table border="1" data-bbox="555 712 746 801"> <tr> <td>C</td><td>Z</td><td>S</td><td>O</td><td>P</td><td>A</td> </tr> <tr> <td colspan="6">unchanged</td> </tr> </table>	C	Z	S	O	P	A	unchanged					
C	Z	S	O	P	A									
unchanged														
MOVSW	No operands	 Copy <b>word</b> at DS:[SI] to ES:[DI]. Update SI and DI. Algorithm:  <ul style="list-style-type: none"> <li>• ES:[DI] = DS:[SI]</li> <li>• if DF = 0 then <ul style="list-style-type: none"> <li>○ SI = SI + 2</li> <li>○ DI = DI + 2</li> </ul> </li> <li>else <ul style="list-style-type: none"> <li>○ SI = SI - 2</li> <li>○ DI = DI - 2</li> </ul> </li> </ul> Example: ORG 100h  CLD LEA SI, a1 LEA DI, a2 MOV CX, 5 REP MOVSW  RET  a1 DW 1,2,3,4,5 a2 DW 5 DUP(0) <table border="1" data-bbox="555 1787 746 1877"> <tr> <td>C</td><td>Z</td><td>S</td><td>O</td><td>P</td><td>A</td> </tr> <tr> <td colspan="6">unchanged</td> </tr> </table>	C	Z	S	O	P	A	unchanged					
C	Z	S	O	P	A									
unchanged														
MUL	REG memory	Unsigned multiply. Algorithm:												

		 when operand is a <b>byte</b> : $AX = AL * \text{operand}$ . when operand is a <b>word</b> : $(DX AX) = AX * \text{operand}$ . <b>Example:</b> MOV AL, 200 ; AL = 0C8h MOV BL, 4 MUL BL ; AX = 0320h (800) RET <table border="1" data-bbox="555 465 746 555"> <tr><td>C</td><td>Z</td><td>S</td><td>O</td><td>P</td><td>A</td></tr> <tr><td>r</td><td>?</td><td>?</td><td>r</td><td>?</td><td>?</td></tr> </table> CF=OF=0 when high section of the result is zero.	C	Z	S	O	P	A	r	?	?	r	?	?
C	Z	S	O	P	A									
r	?	?	r	?	?									
NEG	REG memory	 Negate. Makes operand negative (two's complement). <b>Algorithm:</b> <ul style="list-style-type: none"> <li>Invert all bits of the operand</li> <li>Add 1 to inverted operand</li> </ul> <b>Example:</b> MOV AL, 5 ; AL = 05h NEG AL ; AL = 0FBh (-5) NEG AL ; AL = 05h (5) RET <table border="1" data-bbox="555 1032 746 1122"> <tr><td>C</td><td>Z</td><td>S</td><td>O</td><td>P</td><td>A</td></tr> <tr><td>r</td><td>r</td><td>r</td><td>r</td><td>r</td><td>r</td></tr> </table>	C	Z	S	O	P	A	r	r	r	r	r	r
C	Z	S	O	P	A									
r	r	r	r	r	r									
NOP	No operands	 No Operation. <b>Algorithm:</b> <ul style="list-style-type: none"> <li>Do nothing</li> </ul> <b>Example:</b> ; do nothing, 3 times: NOP NOP NOP RET <table border="1" data-bbox="555 1597 746 1686"> <tr><td>C</td><td>Z</td><td>S</td><td>O</td><td>P</td><td>A</td></tr> <tr><td colspan="6">unchanged</td></tr> </table>	C	Z	S	O	P	A	unchanged					
C	Z	S	O	P	A									
unchanged														
NOT	REG memory	Invert each bit of the operand. <b>Algorithm:</b> <ul style="list-style-type: none"> <li>if bit is 1 turn it to 0.</li> <li>if bit is 0 turn it to 1.</li> </ul> <b>Example:</b>												



		 <pre>MOV AL, 00011011b NOT AL ; AL = 11100100b RET</pre> <table border="1" data-bbox="560 271 746 360"> <tr> <td>C</td><td>Z</td><td>S</td><td>O</td><td>P</td><td>A</td> </tr> <tr> <td colspan="6">unchanged</td> </tr> </table>	C	Z	S	O	P	A	unchanged					
C	Z	S	O	P	A									
unchanged														
OR	REG, memory memory, REG REG, REG memory, immediate REG, immediate	 <p>Logical OR between all bits of two operands. Result is stored in first operand.</p> <p>These rules apply:</p> <pre>1 OR 1 = 1 1 OR 0 = 1 0 OR 1 = 1 0 OR 0 = 0</pre> <p>Example:  MOV AL, 'A' ; AL = 01000001b  OR AL, 00100000b ; AL = 01100001b ('a')  RET</p> <table border="1" data-bbox="560 920 746 1010"> <tr> <td>C</td><td>Z</td><td>S</td><td>O</td><td>P</td><td>A</td> </tr> <tr> <td>0</td><td>r</td><td>r</td><td>0</td><td>r</td><td>?</td> </tr> </table>	C	Z	S	O	P	A	0	r	r	0	r	?
C	Z	S	O	P	A									
0	r	r	0	r	?									
OUT	im.byte, AL im.byte, AX DX, AL DX, AX	 <p>Output from <b>AL</b> or <b>AX</b> to port.  First operand is a port number. If required to access port number over 255 - <b>DX</b> register should be used.</p> <p>Example:  MOV AX, 0FFFh ; Turn on all  OUT 4, AX ; traffic lights.</p> <p>MOV AL, 100b ; Turn on the third  OUT 7, AL ; magnet of the stepper-motor.</p> <table border="1" data-bbox="560 1413 746 1503"> <tr> <td>C</td><td>Z</td><td>S</td><td>O</td><td>P</td><td>A</td> </tr> <tr> <td colspan="6">unchanged</td> </tr> </table>	C	Z	S	O	P	A	unchanged					
C	Z	S	O	P	A									
unchanged														
POP	REG SREG memory	<p>Get 16 bit value from the stack.</p> <p>Algorithm:</p> <ul style="list-style-type: none"> <li>operand = SS:[SP] (top of the stack)</li> <li>SP = SP + 2</li> </ul> <p>Example:  MOV AX, 1234h  PUSH AX  POP DX ; DX = 1234h  RET</p> <table border="1" data-bbox="560 2007 746 2051"> <tr> <td>C</td><td>Z</td><td>S</td><td>O</td><td>P</td><td>A</td> </tr> </table>	C	Z	S	O	P	A						
C	Z	S	O	P	A									

		 <div style="border: 1px solid black; padding: 2px; display: inline-block;">unchanged</div>												
POPA	No operands	 <p>Pop all general purpose registers DI, SI, BP, SP, BX, DX, CX, AX from the stack. SP value is ignored, it is Popped but not set to SP register).</p> <p>Note: this instruction works only on <b>80186</b> CPU and later!</p> <p>Algorithm:</p> <ul style="list-style-type: none"> <li>• POP DI</li> <li>• POP SI</li> <li>• POP BP</li> <li>• POP xx (SP value ignored)</li> <li>• POP BX</li> <li>• POP DX</li> <li>• POP CX</li> <li>• POP AX</li> </ul> <div style="border: 1px solid black; padding: 2px; display: inline-block; margin-top: 10px;"> <table style="border-collapse: collapse;"> <tr> <td style="border: 1px solid black; padding: 2px;">C</td> <td style="border: 1px solid black; padding: 2px;">Z</td> <td style="border: 1px solid black; padding: 2px;">S</td> <td style="border: 1px solid black; padding: 2px;">O</td> <td style="border: 1px solid black; padding: 2px;">P</td> <td style="border: 1px solid black; padding: 2px;">A</td> </tr> <tr> <td colspan="6" style="border: 1px solid black; padding: 2px;">unchanged</td> </tr> </table> </div>	C	Z	S	O	P	A	unchanged					
C	Z	S	O	P	A									
unchanged														
POPF	No operands	 <p>Get flags register from the stack.</p> <p>Algorithm:</p> <ul style="list-style-type: none"> <li>• flags = SS:[SP] (top of the stack)</li> <li>• SP = SP + 2</li> </ul> <div style="border: 1px solid black; padding: 2px; display: inline-block; margin-top: 10px;"> <table style="border-collapse: collapse;"> <tr> <td style="border: 1px solid black; padding: 2px;">C</td> <td style="border: 1px solid black; padding: 2px;">Z</td> <td style="border: 1px solid black; padding: 2px;">S</td> <td style="border: 1px solid black; padding: 2px;">O</td> <td style="border: 1px solid black; padding: 2px;">P</td> <td style="border: 1px solid black; padding: 2px;">A</td> </tr> <tr> <td colspan="6" style="border: 1px solid black; padding: 2px;">popped</td> </tr> </table> </div>	C	Z	S	O	P	A	popped					
C	Z	S	O	P	A									
popped														
PUSH	REG SREG memory immediate	<p>Store 16 bit value in the stack.</p> <p>Note: <b>PUSH immediate</b> works only on 80186 CPU and later!</p> <p>Algorithm:</p> <ul style="list-style-type: none"> <li>• SP = SP - 2</li> <li>• SS:[SP] (top of the stack) = operand</li> </ul> <p>Example: MOV AX, 1234h PUSH AX POP DX ; DX = 1234h RET</p> <div style="border: 1px solid black; padding: 2px; display: inline-block; margin-top: 10px;"> <table style="border-collapse: collapse;"> <tr> <td style="border: 1px solid black; padding: 2px;">C</td> <td style="border: 1px solid black; padding: 2px;">Z</td> <td style="border: 1px solid black; padding: 2px;">S</td> <td style="border: 1px solid black; padding: 2px;">O</td> <td style="border: 1px solid black; padding: 2px;">P</td> <td style="border: 1px solid black; padding: 2px;">A</td> </tr> <tr> <td colspan="6" style="border: 1px solid black; padding: 2px;">unchanged</td> </tr> </table> </div>	C	Z	S	O	P	A	unchanged					
C	Z	S	O	P	A									
unchanged														



														
PUSHA	No operands	 Push all general purpose registers AX, CX, DX, BX, SP, BP, SI, DI in the stack. Original value of SP register (before PUSHA) is used.  Note: this instruction works only on <b>80186</b> CPU and later!  Algorithm:  <ul style="list-style-type: none"> <li>• PUSH AX</li> <li>• PUSH CX</li> <li>• PUSH DX</li> <li>• PUSH BX</li> <li>• PUSH SP</li> <li>• PUSH BP</li> <li>• PUSH SI</li> <li>• PUSH DI</li> </ul> <div style="border: 1px solid black; padding: 2px; display: inline-block; margin-top: 10px;"> <table style="border-collapse: collapse;"> <tr> <td style="padding: 2px 5px;">C</td> <td style="padding: 2px 5px;">Z</td> <td style="padding: 2px 5px;">S</td> <td style="padding: 2px 5px;">O</td> <td style="padding: 2px 5px;">P</td> <td style="padding: 2px 5px;">A</td> </tr> <tr> <td colspan="6" style="padding: 2px 5px;">unchanged</td> </tr> </table> </div>	C	Z	S	O	P	A	unchanged					
C	Z	S	O	P	A									
unchanged														
PUSHF	No operands	 Store flags register in the stack.  Algorithm:  <ul style="list-style-type: none"> <li>• SP = SP - 2</li> <li>• SS:[SP] (top of the stack) = flags</li> </ul> <div style="border: 1px solid black; padding: 2px; display: inline-block; margin-top: 10px;"> <table style="border-collapse: collapse;"> <tr> <td style="padding: 2px 5px;">C</td> <td style="padding: 2px 5px;">Z</td> <td style="padding: 2px 5px;">S</td> <td style="padding: 2px 5px;">O</td> <td style="padding: 2px 5px;">P</td> <td style="padding: 2px 5px;">A</td> </tr> <tr> <td colspan="6" style="padding: 2px 5px;">unchanged</td> </tr> </table> </div>	C	Z	S	O	P	A	unchanged					
C	Z	S	O	P	A									
unchanged														
RCL	memory, immediate REG, immediate  memory, CL REG, CL	Rotate operand1 left through Carry Flag. The number of rotates is set by operand2. When <b>immediate</b> is greater than 1, assembler generates several <b>RCL xx, 1</b> instructions because 8086 has machine code only for this instruction (the same principle works for all other shift/rotate instructions).  Algorithm:  shift all bits left, the bit that goes off is set to CF and previous value of CF is inserted to the right-most position.  Example: STC ; set carry (CF=1). MOV AL, 1Ch ; AL = 00011100b RCL AL, 1 ; AL = 00111001b, CF=0. RET <div style="border: 1px solid black; padding: 2px; display: inline-block; margin-top: 10px;"> <table style="border-collapse: collapse;"> <tr> <td style="padding: 2px 5px;">C</td> <td style="padding: 2px 5px;">O</td> </tr> </table> </div>	C	O										
C	O													





		 <p>OF=0 if first operand keeps original sign.</p>
RCR	<p>memory, immediate REG, immediate</p> <p>memory, CL REG, CL</p>	 <p>Rotate operand1 right through Carry Flag. The number of rotates is set by operand2.</p> <p>Algorithm:</p> <p style="padding-left: 40px;">shift all bits right, the bit that goes off is set to CF and previous value of CF is inserted to the left-most position.</p> <p>Example:</p> <p>STC ; set carry (CF=1).  MOV AL, 1Ch ; AL = 00011100b  RCR AL, 1 ; AL = 10001110b, CF=0.  RET</p>  <p>OF=0 if first operand keeps original sign.</p>
REP	chain instruction	 <p>Repeat following MOVSB, MOVSW, LODSB, LODSW, STOSB, STOSW instructions CX times.</p> <p>Algorithm:</p> <p>check_cx:</p> <p>if CX &lt;&gt; 0 then</p> <ul style="list-style-type: none"> <li>• do following <u>chain instruction</u></li> <li>• CX = CX - 1</li> <li>• go back to check_cx</li> </ul> <p>else</p> <ul style="list-style-type: none"> <li>• exit from REP cycle</li> </ul> 
REPE	chain instruction	<p>Repeat following CMPSB, CMPSW, SCASB, SCASW instructions while ZF = 1 (result is Equal), maximum CX times.</p> <p>Algorithm:</p> <p>check_cx:</p> <p>if CX &lt;&gt; 0 then</p> <ul style="list-style-type: none"> <li>• do following <u>chain instruction</u></li> <li>• CX = CX - 1</li> <li>• if ZF = 1 then: <ul style="list-style-type: none"> <li>○ go back to check_cx</li> </ul> </li> </ul>



		<p>else</p> <ul style="list-style-type: none"> <li>○ exit from REPE cycle</li> </ul> <p>else</p> <ul style="list-style-type: none"> <li>• exit from REPE cycle</li> </ul> <p>Example: see <b>cmpsb.asm</b> in c:\emu8086\examples\.</p> <div style="border: 1px solid black; padding: 2px; display: inline-block;"> Z r </div>
REPNE	chain instruction	 Repeat following CMPSB, CMPSW, SCASB, SCASW instructions while ZF = 0 (result is Not Equal), maximum CX times. <p>Algorithm:</p> <p>check_cx:</p> <p>if CX &gt; 0 then</p> <ul style="list-style-type: none"> <li>• do following <u>chain instruction</u></li> <li>• CX = CX - 1</li> <li>• if ZF = 0 then: <ul style="list-style-type: none"> <li>○ go back to check_cx</li> </ul> </li> </ul> <p>else</p> <ul style="list-style-type: none"> <li>○ exit from REPNE cycle</li> </ul> <p>else</p> <ul style="list-style-type: none"> <li>• exit from REPNE cycle</li> </ul> <div style="border: 1px solid black; padding: 2px; display: inline-block;"> Z r </div>
REPZ	chain instruction	<p>Repeat following CMPSB, CMPSW, SCASB, SCASW instructions while ZF = 0 (result is Not Zero), maximum CX times.</p> <p>Algorithm:</p> <p>check_cx:</p> <p>if CX &gt; 0 then</p> <ul style="list-style-type: none"> <li>• do following <u>chain instruction</u></li> <li>• CX = CX - 1</li> <li>• if ZF = 0 then:</li> </ul>





		 <ul style="list-style-type: none"> <li>○ go back to check_cx</li> </ul> <p>else</p> <ul style="list-style-type: none"> <li>○ exit from REPZ cycle</li> </ul> <p>else</p> <ul style="list-style-type: none"> <li>• exit from REPZ cycle</li> </ul> <div style="border: 1px solid black; padding: 2px; display: inline-block;"> Z r </div>
REPZ	chain instruction	 Repeat following CMPSB, CMPSW, SCASB, SCASW instructions while ZF = 1 (result is Zero), maximum CX times. <p>Algorithm:</p> <p>check_cx:</p> <p>if CX &gt; 0 then</p> <ul style="list-style-type: none"> <li>• do following <u>chain instruction</u></li> <li>• CX = CX - 1</li> <li>• if ZF = 1 then: <ul style="list-style-type: none"> <li>○ go back to check_cx</li> </ul> </li> </ul> <p>else</p> <ul style="list-style-type: none"> <li>○ exit from REPZ cycle</li> </ul> <p>else</p> <ul style="list-style-type: none"> <li>• exit from REPZ cycle</li> </ul> <div style="border: 1px solid black; padding: 2px; display: inline-block;"> Z r </div>
RET	No operands or even immediate	Return from near procedure. <p>Algorithm:</p> <ul style="list-style-type: none"> <li>• Pop from stack: <ul style="list-style-type: none"> <li>○ IP</li> </ul> </li> <li>• if <u>immediate</u> operand is present: SP = SP + operand</li> </ul> <p>Example:</p> <p>ORG 100h ; for COM file.</p> <p>CALL p1</p>









		 ADD AX, 1 RET ; return to OS. p1 PROC ; procedure declaration. MOV AX, 1234h RET ; return to caller. p1 ENDP <table border="1" data-bbox="555 456 746 546"> <tr><td>C</td><td>Z</td><td>S</td><td>O</td><td>P</td><td>A</td></tr> <tr><td colspan="6">unchanged</td></tr> </table>	C	Z	S	O	P	A	unchanged					
C	Z	S	O	P	A									
unchanged														
RETf	No operands or even immediate	 Return from Far procedure. Algorithm: <ul style="list-style-type: none"> <li>• Pop from stack: <ul style="list-style-type: none"> <li>◦ IP</li> <li>◦ CS</li> </ul> </li> <li>• if <u>immediate</u> operand is present: SP = SP + operand</li> </ul> <table border="1" data-bbox="555 931 746 1021"> <tr><td>C</td><td>Z</td><td>S</td><td>O</td><td>P</td><td>A</td></tr> <tr><td colspan="6">unchanged</td></tr> </table>	C	Z	S	O	P	A	unchanged					
C	Z	S	O	P	A									
unchanged														
ROL	memory, immediate REG, immediate  memory, CL REG, CL	 Rotate operand1 left. The number of rotates is set by operand2. Algorithm: shift all bits left, the bit that goes off is set to CF and the same bit is inserted to the right-most position. Example: MOV AL, 1Ch ; AL = 00011100b ROL AL, 1 ; AL = 00111000b, CF=0. RET <table border="1" data-bbox="555 1451 628 1541"> <tr><td>C</td><td>O</td></tr> <tr><td>r</td><td>r</td></tr> </table> OF=0 if first operand keeps original sign.	C	O	r	r								
C	O													
r	r													
ROR	memory, immediate REG, immediate  memory, CL REG, CL	Rotate operand1 right. The number of rotates is set by operand2. Algorithm: shift all bits right, the bit that goes off is set to CF and the same bit is inserted to the left-most position. Example: MOV AL, 1Ch ; AL = 00011100b ROR AL, 1 ; AL = 00001110b, CF=0. RET <table border="1" data-bbox="555 1980 628 2024"> <tr><td>C</td><td>O</td></tr> </table>	C	O										
C	O													

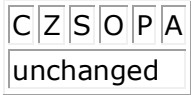

		 <p>OF=0 if first operand keeps original sign.</p>												
SAHF	No operands	 <p>Store AH register into low 8 bits of Flags register.</p> <p>Algorithm:</p> <p>flags register = AH</p> <p>AH bit: 7 6 5 4 3 2 1 0 [SF] [ZF] [0] [AF] [0] [PF] [1] [CF] bits 1, 3, 5 are reserved.</p> <table border="1" data-bbox="555 622 746 721"> <tr><td>C</td><td>Z</td><td>S</td><td>O</td><td>P</td><td>A</td></tr> <tr><td>r</td><td>r</td><td>r</td><td>r</td><td>r</td><td>r</td></tr> </table>	C	Z	S	O	P	A	r	r	r	r	r	r
C	Z	S	O	P	A									
r	r	r	r	r	r									
SAL	memory, immediate REG, immediate  memory, CL REG, CL	 <p>Shift Arithmetic operand1 Left. The number of shifts is set by operand2.</p> <p>Algorithm:</p> <ul style="list-style-type: none"> <li>Shift all bits left, the bit that goes off is set to CF.</li> <li>Zero bit is inserted to the right-most position.</li> </ul> <p>Example: MOV AL, 0E0h ; AL = 11100000b SAL AL, 1 ; AL = 11000000b, CF=1. RET</p> <table border="1" data-bbox="555 1191 625 1290"> <tr><td>C</td><td>O</td></tr> <tr><td>r</td><td>r</td></tr> </table> <p>OF=0 if first operand keeps original sign.</p>	C	O	r	r								
C	O													
r	r													
SAR	memory, immediate REG, immediate  memory, CL REG, CL	 <p>Shift Arithmetic operand1 Right. The number of shifts is set by operand2.</p> <p>Algorithm:</p> <ul style="list-style-type: none"> <li>Shift all bits right, the bit that goes off is set to CF.</li> <li>The sign bit that is inserted to the left-most position has the same value as before shift.</li> </ul> <p>Example: MOV AL, 0E0h ; AL = 11100000b SAR AL, 1 ; AL = 11110000b, CF=0.  MOV BL, 4Ch ; BL = 01001100b SAR BL, 1 ; BL = 00100110b, CF=0.  RET</p> <table border="1" data-bbox="555 1908 625 2007"> <tr><td>C</td><td>O</td></tr> <tr><td>r</td><td>r</td></tr> </table> <p>OF=0 if first operand keeps original sign.</p>	C	O	r	r								
C	O													
r	r													

SBB	REG, memory memory, REG REG, REG memory, immediate REG, immediate	 Subtract with Borrow. Algorithm: $operand1 = operand1 - operand2 - CF$ <b>Example:</b> STC MOV AL, 5 SBB AL, 3 ; $AL = 5 - 3 - 1 = 1$ RET <table border="1" data-bbox="555 555 746 651"> <tr><td>C</td><td>Z</td><td>S</td><td>O</td><td>P</td><td>A</td></tr> <tr><td>r</td><td>r</td><td>r</td><td>r</td><td>r</td><td>r</td></tr> </table>	C	Z	S	O	P	A	r	r	r	r	r	r
C	Z	S	O	P	A									
r	r	r	r	r	r									
SCASB	No operands	 Compare bytes: AL from ES:[DI]. Algorithm: <ul style="list-style-type: none"> <li>• ES:[DI] - AL</li> <li>• set flags according to result: OF, SF, ZF, AF, PF, CF</li> <li>• if DF = 0 then <ul style="list-style-type: none"> <li>○ DI = DI + 1</li> </ul> </li> </ul> else <ul style="list-style-type: none"> <li>○ DI = DI - 1</li> </ul> <table border="1" data-bbox="555 1193 746 1290"> <tr><td>C</td><td>Z</td><td>S</td><td>O</td><td>P</td><td>A</td></tr> <tr><td>r</td><td>r</td><td>r</td><td>r</td><td>r</td><td>r</td></tr> </table>	C	Z	S	O	P	A	r	r	r	r	r	r
C	Z	S	O	P	A									
r	r	r	r	r	r									
SCASW	No operands	 Compare words: AX from ES:[DI]. Algorithm: <ul style="list-style-type: none"> <li>• ES:[DI] - AX</li> <li>• set flags according to result: OF, SF, ZF, AF, PF, CF</li> <li>• if DF = 0 then <ul style="list-style-type: none"> <li>○ DI = DI + 2</li> </ul> </li> </ul> else <ul style="list-style-type: none"> <li>○ DI = DI - 2</li> </ul> <table border="1" data-bbox="555 1836 746 1933"> <tr><td>C</td><td>Z</td><td>S</td><td>O</td><td>P</td><td>A</td></tr> <tr><td>r</td><td>r</td><td>r</td><td>r</td><td>r</td><td>r</td></tr> </table>	C	Z	S	O	P	A	r	r	r	r	r	r
C	Z	S	O	P	A									
r	r	r	r	r	r									
SHL	memory,	Shift operand1 Left. The number of shifts is set by operand2.												

	<p>immediate REG, immediate</p> <p>memory, CL REG, CL</p>	 Algorithm: <ul style="list-style-type: none"> <li>Shift all bits left, the bit that goes off is set to CF.</li> <li>Zero bit is inserted to the right-most position.</li> </ul> <p>Example: MOV AL, 11100000b SHL AL, 1 ; AL = 11000000b, CF=1.</p> <p>RET</p> <table border="1" data-bbox="555 539 627 629"> <tr><td>C</td><td>O</td></tr> <tr><td>r</td><td>r</td></tr> </table> <p>OF=0 if first operand keeps original sign.</p>	C	O	r	r
C	O					
r	r					
SHR	<p>memory, immediate REG, immediate</p> <p>memory, CL REG, CL</p>	<p>Shift operand1 Right. The number of shifts is set by operand2.</p> <p>Algorithm:</p> <ul style="list-style-type: none"> <li>Shift all bits right, the bit that goes off is set to CF.</li> <li>Zero bit is inserted to the left-most position.</li> </ul>  Example: MOV AL, 00000111b SHR AL, 1 ; AL = 00000011b, CF=1. <p>RET</p> <table border="1" data-bbox="555 1106 627 1196"> <tr><td>C</td><td>O</td></tr> <tr><td>r</td><td>r</td></tr> </table> <p>OF=0 if first operand keeps original sign.</p>	C	O	r	r
C	O					
r	r					
STC	No operands	 Set Carry flag. <p>Algorithm:</p> <p>CF = 1</p> <table border="1" data-bbox="555 1473 595 1570"> <tr><td>C</td></tr> <tr><td>1</td></tr> </table>	C	1		
C						
1						
STD	No operands	 Set Direction flag. SI and DI will be decremented by chain instructions: CMPSB, CMPSW, LODSB, LODSW, MOVSB, MOVSW, STOSB, STOSW. <p>Algorithm:</p> <p>DF = 1</p> <table border="1" data-bbox="555 1906 595 2002"> <tr><td>D</td></tr> <tr><td>1</td></tr> </table>	D	1		
D						
1						

STI	No operands	 Set Interrupt enable flag. This enables hardware interrupts. Algorithm: IF = 1 
STOSB	No operands	Store byte in AL into ES:[DI]. Update DI.  Algorithm: <ul style="list-style-type: none"> <li>• ES:[DI] = AL</li> <li>• if DF = 0 then <ul style="list-style-type: none"> <li>○ DI = DI + 1</li> </ul> </li> <li>else <ul style="list-style-type: none"> <li>○ DI = DI - 1</li> </ul> </li> </ul> Example: ORG 100h LEA DI, a1 MOV AL, 12h MOV CX, 5 REP STOSB RET a1 DB 5 dup(0) 
STOSW	No operands	Store word in AX into ES:[DI]. Update DI. Algorithm: <ul style="list-style-type: none"> <li>• ES:[DI] = AX</li> <li>• if DF = 0 then <ul style="list-style-type: none"> <li>○ DI = DI + 2</li> </ul> </li> <li>else <ul style="list-style-type: none"> <li>○ DI = DI - 2</li> </ul> </li> </ul> Example: ORG 100h

		 LEA DI, a1 MOV AX, 1234h MOV CX, 5  REP STOSW  RET  a1 DW 5 dup(0) <table border="1" data-bbox="555 456 746 546"> <tr><td>C</td><td>Z</td><td>S</td><td>O</td><td>P</td><td>A</td></tr> <tr><td colspan="6">unchanged</td></tr> </table>	C	Z	S	O	P	A	unchanged					
C	Z	S	O	P	A									
unchanged														
SUB	REG, memory memory, REG REG, REG memory, immediate REG, immediate	 Subtract. Algorithm:  operand1 = operand1 - operand2  Example: MOV AL, 5 SUB AL, 1 ; AL = 4  RET <table border="1" data-bbox="555 976 746 1066"> <tr><td>C</td><td>Z</td><td>S</td><td>O</td><td>P</td><td>A</td></tr> <tr><td>r</td><td>r</td><td>r</td><td>r</td><td>r</td><td>r</td></tr> </table>	C	Z	S	O	P	A	r	r	r	r	r	r
C	Z	S	O	P	A									
r	r	r	r	r	r									
TEST	REG, memory memory, REG REG, REG memory, immediate REG, immediate	 Logical AND between all bits of two operands for flags only. These flags are effected: <b>ZF, SF, PF</b> . Result is not stored anywhere.  These rules apply:  1 AND 1 = 1 1 AND 0 = 0 0 AND 1 = 0 0 AND 0 = 0  Example: MOV AL, 0000101b TEST AL, 1 ; ZF = 0. TEST AL, 10b ; ZF = 1. RET <table border="1" data-bbox="555 1688 715 1778"> <tr><td>C</td><td>Z</td><td>S</td><td>O</td><td>P</td></tr> <tr><td>0</td><td>r</td><td>r</td><td>0</td><td>r</td></tr> </table>	C	Z	S	O	P	0	r	r	0	r		
C	Z	S	O	P										
0	r	r	0	r										
XCHG	REG, memory memory, REG REG, REG	Exchange values of two operands.  Algorithm:  operand1 < - > operand2												

		 <p>Example:  MOV AL, 5  MOV AH, 2  XCHG AL, AH ; AL = 2, AH = 5  XCHG AL, AH ; AL = 5, AH = 2  RET</p> <table border="1" data-bbox="560 365 746 456"> <tr> <td>C</td><td>Z</td><td>S</td><td>O</td><td>P</td><td>A</td> </tr> <tr> <td colspan="6">unchanged</td> </tr> </table>	C	Z	S	O	P	A	unchanged					
C	Z	S	O	P	A									
unchanged														
XLATB	No operands	 <p>Translate byte from table.  Copy value of memory byte at DS:[BX + unsigned AL] to AL register.</p> <p>Algorithm:  AL = DS:[BX + unsigned AL]</p> <p>Example:  ORG 100h  LEA BX, dat  MOV AL, 2  XLATB ; AL = 33h</p> <p>RET</p> <p>dat DB 11h, 22h, 33h, 44h, 55h</p> <table border="1" data-bbox="560 1106 746 1198"> <tr> <td>C</td><td>Z</td><td>S</td><td>O</td><td>P</td><td>A</td> </tr> <tr> <td colspan="6">unchanged</td> </tr> </table>	C	Z	S	O	P	A	unchanged					
C	Z	S	O	P	A									
unchanged														
XOR	REG, memory memory, REG REG, REG memory, immediate REG, immediate	 <p>Logical XOR (Exclusive OR) between all bits of two operands. Result is stored in first operand.</p> <p>These rules apply:</p> <p>1 XOR 1 = 0  1 XOR 0 = 1  0 XOR 1 = 1  0 XOR 0 = 0</p> <p>Example:  MOV AL, 00000111b  XOR AL, 00000010b ; AL = 00000101b  RET</p> <table border="1" data-bbox="560 1756 746 1848"> <tr> <td>C</td><td>Z</td><td>S</td><td>O</td><td>P</td><td>A</td> </tr> <tr> <td>0</td><td>r</td><td>r</td><td>0</td><td>r</td><td>?</td> </tr> </table>	C	Z	S	O	P	A	0	r	r	0	r	?
C	Z	S	O	P	A									
0	r	r	0	r	?									

## emu8086 Assembler - Frequently Asked Questions The Microprocessor Emulator and 8086 Integrated Assembler

Please make sure you have the latest version of **EMU8086**  
(if unsure click **help -> check for an update...** from the menu)  
The solutions may not work in previous versions of the emulator/assembler.

### General recommendation for Windows XP users:

- **1.** click Start.
- **2.** click Run.
- **3.** type "explorer"
- **4.** select from the menu "Tools" -> "Folder Options".
- **5.** click "View" tab.
- **6.** select "Show hidden files and folders".
- **7. uncheck** "Hide extensions for known file types".

To step forward press **F8** key, to run forward press **F9** or press and hold **F8**. To step backward press **F6** key, to run backward press and hold **F6**. The maximum number of steps-back can be set in **emu8086.ini**. For example:

**MAXIMUM\_STEPS\_BACK=default** ; by default it is set to 200 for a better performance.

or

**MAXIMUM\_STEPS\_BACK=1000** ; this value should not be over 32767.

### Question:

Why this code doesn't work?

```
org 100h

    myArray dw 2, 12, 8, 52, 108

    mov si, 0
    mov ax, myArray[si]

ret
```

---

### Solution:

There should be a jump over the variables/array declaration:

```
org 100h

jmp code

    myArray dw 2, 12, 8, 52, 108

code: mov si, 0
      mov ax, myArray[si]
```



```
ret
```

For the computer all bytes look the same, it cannot determine if it's an instruction or a variable. Here is an example of **MOV AL, 5** instruction that can be coded with simple variable declarations:

```
org 100h
```

```
byte1 db 176  
byte2 db 5
```

```
ret
```

When you run this program in emulator you can see that bytes **176** and **5** are actually assembled into:

**MOV AL, 5**

This is very typical for [Von Neumann Architecture](#) to keep data and instructions in the same memory, It's even possible to write complete program by using only **DB** (define byte) directive.

```
org 100h
```

```
db 235 ; jump...  
db 6 ; 6 - six bytes forward (need to skip characters)  
db 72 ; ascii code of 'H'  
db 101 ; ascii code of 'e'  
db 108 ; ascii code of 'l'  
db 108 ; ascii code of 'l'  
db 111 ; ascii code of 'o'  
db 36 ; ascii code of '$' - DOS function prints untill dollar.  
db 186 ; mov DX, .... - DX is word = two bytes  
db 2 ; 02 - little end  
db 1 ; 01 - big end  
db 180 ; mov AH, ....  
db 9 ; 09  
db 205 ; int ...  
db 33 ; 21h - 33 is 21h (hexadecimal)  
db 195 ; ret - stop the program.
```

8086 and all other Intel's microprocessors store the least significant byte at a lower address. **102h** is the address of 'H' character = **org 100h + 2 bytes** (jmp instruction). The above assembly code produces identical machine code to this little program:

```
org 100h
```

```
jmp code
```

```
msg db 'Hello$'
```

```
code: mov DX, offset msg  
mov AH, 9  
int 21h
```

```
ret
```

If you open the produced ".com" file in any hex editor you can see hexadecimal values, every byte takes two hexadecimal digits, for example 235 = **EB**, etc... memory window of the emulator shows both [hexadecimal and decimal](#) values.

### Problem:

The screen fonts are too small or too big?...

---

**Solution:**

The latest version of the emulator uses Terminal font by default and it is MSDOS/ASCII compatible. It is also possible to set the screen font to **Fixedsys** from the **options**. For other controls the font can be changed from c:\emu8086\emu8086.ini configuration file. It is well known that on some localized versions of Windows XP the Terminal font may be shown significantly smaller than in original English version. The latest version automatically changes default font to 12 unless it is set in emu8086.ini: **FIX\_SMALL\_FONTS=false**. The Fixedsys font is reported to be shown equally on all systems. It is reported that for small Terminal font D and 0 (zero) look very alike.

Starting from version 4.00-Beta-8 the integrated assembler of emu8086 can be used from command line. The switch is **/a** followed by a full path to assembly source code files. The assembler will assemble all files that are in source folder into **MyBuild** directory.

For example:

**emu8086 /a c:\emu8086\examples**

Note: any existing files in c:\emu8086\MyBuild\ subdirectory are to be overwritten. The assembler does not print out the status and error messages to console, instead it prints out everything to this file:

**c:\emu8086\MyBuild\\_emu8086\_log.txt**

Do not run several instances of the assembler under the same path until <END> appears in the file. You may see if emu8086 is running by pressing the Ctrl+Alt+Del combination, or by just opening and reopening **\_emu8086\_log.txt** file in Notepad to see if the file is written completely. This can be checked automatically by another program (the file must be opened in shared mode).

The assembler does not save files with extensions **.com**, **.exe**, or **.bin**, instead it uses these extensions: **.com\_**, **.exe\_**, or **.bin\_** (there is underline in the end). If you'd like to run the file for real just rename **.com\_** to **.com** etc.

For batch rename just type:

**ren \*.com\_ \*.com**

Theoretically it's possible to make a high level compiler that will use emu8086 as an assembler to generate the byte code. Maybe even C or C++ compiler. The example of a basic compiler program written in pure 8086 code may be available in the future.

To disable little status window in the lower right corner, set **SILENT\_ASSEMBLER=true** in emu8086.ini

For the emulator physical drive **A:** is this file **c:\emu8086\FLOPPY\_0** (for BIOS interrupts: INT 13h and boot).

For DOS interrupts (INT 21h) drive **A:** is emulated in this subdirectory:

**c:\emu8086\vdive\a\**

- assembler - the one who assembles, what ever in what ever, we generally refer to bytes and machine code.
- integrated - not disintegrated, i.e. all parts work together and supplement each other.
- compiler - the one who compiles bytes, it may use the assembler to make its job easier

and faster.

**Question:**

How do I print a result of a sum of two numbers?

---

**Solution:**

There are two general solutions to this task, small and **big**.

Short "Macro Assembly" solution:

; it is a much shorter solution, because procedures are hidden inside the include file.

```
include "emu8086.inc"
```

```
ORG 100h
```

```
MOV AX, 27
```

```
MOV BX, 77
```

```
ADD AX, BX
```

;now I will print the result which is in AX register

```
CALL PRINT_NUM
```

```
ret
```

```
DEFINE_PRINT_NUM
```

```
DEFINE_PRINT_NUM_UNS
```

```
end
```

For more information about macro definitions check out [tutorial 5](#).

(source code of emu8086.inc is available - click [here](#) to study)

**emu8086.inc** is an open source library, you can dismantle, modify and use its procedures directly

in your code instead of using **include** directives and tricky macro definitions.

The procedure that prints the simple numeric value can take several hundreds of lines, you can use this library as a short-cut; you can find actual assembly language code that does the printing

if you open **emu8086.inc** and search for DEFINE\_PRINT\_NUM and DEFINE\_PRINT\_NUM\_UNS inside of it,

they look exactly as the first example, the advantage of macros is that many programs can use it keeping

their code relatively small.

**Question:**

How to calculate the number of elements in array?

---

**Solution:** The following code calculates the array size:

```

jmp start:
array db 17,15,31,16,1,123, 71

array_byte_size = $ - offset array

```

```

start:
MOV AX, array_byte_size

```

\$ is the location counter, it is used by the assembler to calculate locations of labels and variables.

note: this solution may not work in older versions of emu8086 integrated assembler, you can download an update [here](#). the result is always in bytes. If you declare an array of words you need to divide the result by two, for example:

```

jmp start:
array dw 12,23,31,15,19,431,17

array_byte_size = $ - offset array

```

```

start:
MOV AX, array_byte_size / 2

```

the remainder is always zero, because the number of bytes is even.

### Question:

How can I do a far call, or is it not supported in the emulator?

```

mov bx,0h ;set es:bx to point to int 10h vector in ivt
mov es,bx
mov bx,40h
mov ah,0eh ; set up int 10h params
mov al, 1 ; ASCII code of a funny face
pushf
call es:[bx] ; do a far call to int10h vector ( wrong )
ret
end

```

---

### Solution:

```

mov bx,0h ; set es:bx to point to int 10h vector in ivt
mov es,bx
mov bx,40h
mov ah,0eh ; set up int 10h params
mov al, 1 ; ASCII code of a funny face.
pushf
call far es:[bx] ; do a far call to int10h vector
ret
end

```

Without **far** prefix the microprocessor sets a word value (2 bytes) that is pointed by es:[BX] to IP register; with **far** prefix microprocessor sets the word value that is pointed by es:[BX] to IP register, and the word at es:[BX+2] is set to CS register.

### Question:

Is there another way to achieve the same result without using DD variables?

---

## Solution:

DD definitions and far jumps are supported in the latest version, for example:

```
jmp far addr  
addr dd 1235:5124h
```

If you are using earlier version of emu8086 you can use a workaround, because double words are really two 16 bit words, and words are really two bytes or 8 bits, it's possible to code without using any other variables but bytes. In other words, you can define two DW values to make a DD.

For example:

```
ddvar dw 0  
dw 0
```

Long jumps are supported in the latest version (**call far**). For previous versions of emu8086 there is another workaround:

This code is compiled perfectly by all versions:

```
jmp 1234h:4567h  
and it is assembled into byte sequence:
```

```
EA 67 45 34 12
```

It can be seen in memory window and in **emulator -> debug**.

Therefore, you can define in your code something similar to this code:

```
db 0EAh ; long jump instruction opcode.  
oft dw 4567h ; jump offset  
sg dw 1234h ; jump segment
```

The above code is assembled into the same machine code, but allows you to modify the jump values easily and even replace them if required, for example:

```
mov cs:oft, 100h  
when executed the above instruction modifies the upper code into:
```

```
jmp 1234h:100h
```

this is just a tiny example of self-modifying code, it's possible to do anything even without using DD (define double word) and segment overrides, in fact it is possible to use DB (define byte) only, because DW (define word) is just two DBs. it is important to remember that Intel architecture requires the little end of the number to be stored at the lower address, for example the value **1234h** is combined of two bytes and it is stored in the memory as **3412**.

```
org 100h  
  
mov ax, 0  
mov es, ax  
  
mov ax, es:[40h]  
mov word_offset, ax  
  
mov ax, es:[40h+2]  
mov word_segment, ax
```

```

mov ah,0eh ; set up parameters for int 10h
mov al,1 ; ASCII code of a funny face.

; do same things as int does
pushf
push cs
mov bx, rr
push bx

opcode db 0EAh ; jmp word_segment:word_offset
word_offset dw ?
word_segment dw ?

rr:
mov ax, 1 ; return here

ret

end

```

### Question:

It would be very useful to have the option of invoking a DOS shell at the build directory from the compile finished dialogue.

---

### Solution:

The latest version of emu8086 has external button that allows to launch command prompt or debug.exe with preloaded executable and it also allows to run executables in real environment. for previous versions of emu8086 you can download Microsoft utility called **command prompt here**, after the compilation click **browse...**, to open **C:\emu8086\MyBuild** folder in file manager, then **right-click** this folder and select "**open command prompt here**" from the pop-up menu.

### Question:

Is it possible to set a break point?

---

### Answer:

Yes, it's possible to click the instruction line and click **Set break point** from **Debug** menu of the emulator.

It is also possible to keep a log similar to **debug** program, if you click **View -> Keep Debug Log**.

The break point is set to currently selected address (segment:offset).

The emulator will stop running when the physical address of CS:IP registers is equivalent to break point address (note: several effective address may represent the same physical address, for example **0700:114A = 0714:000A**)

Another way to set a break point is to click **debug -> stop on condition** and set value of IP register. The easiest way to get IP values is from the listing under LOC column. To get listing click **debug -> listing**

In addition it's possible to the emulator to stop on condition **AX = 1234h** and to put the following lines in several places of your code:

```

MOV AX, 1234h
MOV AX, 0

```

## Question:

I am aware that 8086 is limited to 32,767 for positive and to -32,768 for negative. I am aware that this is the 16-bit processor, that was used in earlier computer systems, but even in 8-bit Atari 2600 score counts in many games went into the 100,000s, way beyond 32,000.

---

## Solution:

Here is the example that calculates and displays the sum of two 100-bit values (30 digits). 32 bits can store values up to: 4,294,967,296 because  $2^{32} = 4294967296$  (this is only 10 decimal digits).

100 bits can hold up to 31 decimal digits because  $2^{100} =$   
**1267650600228229401496703205376**

(31 decimal digits = 100 binary digits = 100 bits)

; this example shows how to add huge unpacked BCD numbers (BCD is binary coded decimal).

; this allows to overcome the 16 bit and even 32 bit limitation.

; because 32 digit decimal value holds over 100 bits!

; the number of digits in num1 and num2 can be easily increased.

```
ORG 100h
```

```
; skip data:
```

```
JMP code
```

```
; the number of digits in numbers:
```

```
; it's important to reserve 0 as most significant digit, to avoid overflow.
```

```
; so if you need to operate with 250 digit values, you need to declare len = 251
```

```
len EQU 32
```

```
; every decimal digit is stored in a separate byte.
```

```
; first number is: 423454612361234512344535179521
```

```
num1 DB 0,0,4,2,3,4,5,4,6,1,2,3,6,1,2,3,4,5,1,2,3,4,4,5,3,5,1,7,9,5,2,1
```

```
; second number is: 712378847771981123513137882498
```

```
num2 DB 0,0,7,1,2,3,7,8,8,4,7,7,7,1,9,8,1,1,2,3,5,1,3,1,3,7,8,8,2,4,9,8
```

```
; we will calculate this:
```

```
; sum = num1 + num2
```

```
; 423454612361234512344535179521 + 712378847771981123513137882498 =
```

```
; = 1135833460133215635857673062019
```

```
sum DB len dup(0) ; declare array to keep the result.
```

```
; you may check the result on paper, or click Start, then Run, then type "calc" and hit enter key.
```

```
code: nop ; the entry point.
```

```
; digit pointer:
```

```
XOR BX, BX
```

```
; setup the loop:
```

```
MOV CX, len
```

```
MOV BX, len-1 ; point to least significant digit.
```

```
next_digit:
```

```

; add digits:
MOV  AL, num1[BX]
ADC  AL, num2[BX]

; this is a very useful instruction that
; adjusts the value of addition
; to be string compatible
AAA

; AAA stands for ASCII ADD ADJUST.
; --- algorithm behind AAA ---
; if low nibble of AL > 9 or AF = 1 then:
;   AL = AL + 6
;   AH = AH + 1
;   AF = 1
;   CF = 1
; else
;   AF = 0
;   CF = 0
;
; in both cases: clear the high nibble of AL.
; --- end of AAA logic ---

; store result:
MOV  sum[BX], AL

; point to next digit:
DEC  BX

LOOP next_digit

; include carry in result (if any):
ADC  sum[BX], 0

; print out the result:
MOV  CX, len

; start printing from most significant digit:
MOV  BX, 0

print_d:
MOV  AL, sum[BX]
; convert to ASCII char:
OR   AL, 30h

MOV  AH, 0Eh
INT  10h

INC  BX

LOOP print_d

RET

END

```

With some more diligence it's possible to make a program that inputs 200 digit values and prints out their sum.

**Question:**



I'm making an interrupt counter; for that I am using 1 phototransister and sdk-86 board at college. I am not having this kit at home so I have a problem to see the output. here is issue.: when light on phototransister is on and off pulse is generated, this pulse comes just like the harwarded iterrupt. my program must to count these pulses continuously; for that I am using 8255kit and SDK-86kit at college, but at home I don't have this equempent at home. Am I able to emulate the output of real system? Perchanps, I have to developpe 8255 device as an external device in emu8086; but how can I prog this device in vb? I am using ports: 30h, 31h, 32h, and 33h. I dont know vb...

---

**Answer:**

You don't have to know vb, but you have to know any real programming language apart from html/javascript. the programming language must allow the programmer to have complete control over the file input/output operations, then you can just open the file **c:\emu8086.io** in shared mode and read values from it like from a real i/o port. byte at offset 30h corresponds to port 30h, word at offset 33h corresponds to port 33h. the operating system automatically caches files that are accessed frequently, this makes the interaction between the emulator and a virtual device just a little bit slower than direct memory-to-memory to communication. in fact, you can create 8255 device in 16 bit or even in 32 bit assembly language.

Note: the latest version supports hardware interrupts: **c:\emu8086.hw**, setting a none-zero value to any byte in that file triggers a hardware interrupt. the emulator must be running or step button must be pressed to process the hardware interrupt. For example:

```
idle:
    nop
    jmp idle
```

**Question:**

I want to know about memory models and segmentation and memory considerations in embedded systems.

---

**Answer:**

You may find these links helpful:

- [A feel for things.](#)
- [Advanced Embedded X86 Programming: Protection and Segmentation.](#)
- [Embedded X86 Programming: Protected Mode.](#)
- [Micro Minis.](#)
- [RISCy Business.](#)
- [In search of a common API for connected devices.](#)
- [Taming the x86 beast.](#)
- [Intel 8086 Family Architecture.](#)

**Question:**

What physical address corresponds to DS:103Fh if DS=94D0h

---

**Answer:**

$94D0h * 10h + 103Fh = 95D3Fh$   
and it's equivalent to effective address: 95D3h:000Fh

it's possible to use emu8086 integrated calculator to make these calculations (set *show result* to hex).

note: 10h = 16

**Question:**

I would like to print out the assembly language program as well as the corresponding machine language code. How can I do so ?

**Solution:**

It is not possible to print out the source code directly from emu8086, but you may click **file** -> **export to HTML...** and print it from the browser or even upload it to the server preserving true code colors and allowing others just to copy & paste it.

The corresponding machine code can be opened and then printed out by clicking **view** -> **listing** right after the successful assembling/compilation or from the emulator's menu.

**Question:**

Can we use breakpoint int 03h with emu 8086?

**Answer:**

It is possible to overwrite the default stub address for int 03h in interrupt vector table with a custom function. And it is possible to insert **CC** byte to substitute the first byte of any instruction, however the easiest way to set a break point is to click an instruction and then click **debug** -> **set break point** from the menu.

Editor hints:

- To repeat a successful text search press F3 key.
- To cut a line press **Ctrl + Y** simultaneously.
- Free positioning of the text cursor can be turned off from the options by checking **confine caret to text**.

**65535** and **-1** are the same 16 bit values in binary representation: 1111111111111111b as **254** and **-2** have the same binary code too: 11111110b

**Question:**

It is good that emu8086 supports virtual devices for emulating the io commands. But how does the IO work for real? (Or: How do I get the Address of a device e.g. the serial port)

---

**Answer:**

It is practically the same. The device controlling is very simple. You may try searching for "**PC PhD: Inside PC Interfacing**". The only problem is the price. It's good if you can afford to buy real devices or a CPU workbench and experiment with the real things. However, for academic and educational purposes, the emulator is much cheaper and easier to use, plus you cannot nor burn nor shortcut it. Using emu8086 technology anyone can make free additional hardware devices. Free hardware easy - in any programming language.

**Question:**

How do I set the output screen to 40\*25, so I don't have to resize it everytime it runs.

---

**Answer:**

```
mov ax, 0  
int 10h
```

It's possible to change the colours by clicking the "options" button. The latest version uses yellow color to select lines of bytes when the instruction in disassembled list is clicked, it shows exactly how many bytes the instruction takes. The yellow background is no longer recommended to avoid the confusion.

Instead of showing the offset the emulator shows the physical address now. You can easily calculate the offset even without the calculator, because the loading segment is always 0700 (unless it's a custom .bin file), so if physical address is 07100 then the offset is 100 and the segment is 700.

The file system emulation is still undergoing heavy checks, there are a few new but undocumented interrupts. INT 21h/4Eh and INT 21h/4Fh. These should allow to get the directory file list.

**Question:**

What is **org 100h** ?

---

**Answer:**

First of all, it's a directive which instructs the assembler to build a simple **.com** file. Unlike instructions, this directive is not converted into any machine code. **com** files are compatible with DOS and they can run in Windows command prompt, and it's the most tiny executable format that is available.

Literally this directive sets the **location counter** to 256 (100h). Location counter is represented in source code as dollar. This is an example of how location counter value can be accessed: **MOV AX, \$** the execution of this instruction will make **AX** contain the address of instruction that put this address in it.... but usually, it's not something to worry about, just remember that **org 100h** must be the first line if you want to make a tiny single segment executable file. note: dollar inside "\$" or '\$' is not a location counter, but an ASCII character.

Location counter has nothing to do with string terminating "\$" that is historically used by MS-DOS print functions.

### Question:

What is **org 7c00h** ?

---

### Answer:

It is very similar to **org 100h**. This directive instructs the assembler to add **7C00h** to all addresses of all variables that are declared in your program. It operates exactly the same way as **ORG 100h** directive, but instead of adding **100h** (or 256 bytes) it adds **7C00h**.

For example if you write this code:

```
mov ax, var1
```

and the address of **var1** is **10h**

without **ORG 100h** directive assembler produces the following machine code:

```
mov ax, [10h]
```

however with **ORG 100h** directive assembler automatically updates the machine code to:

```
mov ax, [10h+100h]
```

and it is equivalent to this code:

```
mov ax, [110h]
```

**org 7C00h** directive must be used because the computer loads boot records into the memory at address **0000:7C00**.

If program is not using variable names and only operates directly with numeric address values (such as [**2001h**] or [**0000:1232h**]... etc, and not **var1, var2...**) and it does not use any labels then there is no practical use for **ORG** directive. generally it's much more convenient to use names for specific memory locations (variables), for these cases **ORG** directive can save a lot of time for the programmer, by calculating the correct offset automatically.

Notes:

- **ORG** directive does not load the program into specific memory area.
- Misuse of **ORG** directive can cause your program not to operate correctly.
- The area where the boot module of the operating system is loaded is defined on hardware level by the computer system/BIOS manufacture.
- When **.com** files are loaded by DOS/prompt, they are loaded at any available segment, but offset is always 100h (for example 12C9:0100).

### Question:

Where is a numeric Table of Opcodes?

---

### Answer:

A list of all 8086 CPU compatible instructions is published [here](#) (without numeric opcodes). Only those instructions that appear both in Pentium<sup>®</sup> manuals and in this reference may be used for 8086 microprocessor. For a complete set of opcodes and encoding tables please check

out:

---

## The Greatest Resources

---

# IA-32 Intel<sup>®</sup> Architecture Software Developer Manuals

- **Basic Architecture:**
- Instruction Set Summary, 16-bit Processors and Segmentation (1978), System Programming Guide
- <http://download.intel.com/design/Pentium4/manuals/25366517.pdf>
- 
- **System Programming Guide:**
- 8086 Emulation, Real-Address Mode:
- <http://download.intel.com/design/Pentium4/manuals/25366817.pdf>
- 
- **Instruction Set Reference:**
- Only 16 bit instructions may run on the original 8086 microprocessor.
- Part 1, Instruction Format, Instructions from A to M:
- <http://download.intel.com/design/Pentium4/manuals/25366617.pdf>
- Part 2, Instructions from N to Z, Opcode Map, Instruction Formats and Encodings:
- <http://download.intel.com/design/Pentium4/manuals/25366717.pdf>
- 

---

# AMD64<sup>®</sup> Architecture Programmer Manuals

- **Application Programming:**
- Overview of the AMD64 Architecture:
- Memory Model and Memory Organization, Registers, Instruction Summary:
- [http://www.amd.com/us-en/assets/content\\_type/white\\_papers\\_and\\_tech\\_docs/24592.pdf](http://www.amd.com/us-en/assets/content_type/white_papers_and_tech_docs/24592.pdf)
- 
- **System Programming:**
- Figures, Tables, x86 and AMD64 Operating Modes, Memory Model:
- [http://www.amd.com/us-en/assets/content\\_type/white\\_papers\\_and\\_tech\\_docs/24593.pdf](http://www.amd.com/us-en/assets/content_type/white_papers_and_tech_docs/24593.pdf)
-

- **General-Purpose Instructions and System Instructions:**
- Only 16 bit instructions are compatible with the original 8086 CPU.
- Instruction Byte Order, General-Purpose Instruction Reference, Opcode and Operand Encodings,
- [http://www.amd.com/us-en/assets/content\\_type/white\\_papers\\_and\\_tech\\_docs/24594.pdf](http://www.amd.com/us-en/assets/content_type/white_papers_and_tech_docs/24594.pdf)
- 

### Notes about I/O port emulation for c:\emu8086.io

It is not recommended to use two neighbouring 16 bit ports, for example port 0 and port 1. Every port has a byte length (8 bit), two byte port (16 bit word) is emulated using 2 bytes or 2 byte ports.

When the emulator outputs the second word it overwrites the high byte of the first word.

; For example:

MOV AL, 34h

OUT 25, AL

MOV AL, 12h

OUT 26, AL

; is equivalent to:

MOV AX, 1234h

OUT 25, AX

### Question:

; I am trying to compile the following:

org 256

mov dx, bugi

ret

bugi db 55

; The variable `_bugi_` is a byte while DX is

; a word but the integrated assembler does not complain. Why?

### Answer:

To make the integrated assembler to generate more errors you may set:

**STRICT\_SYNTAX=true**

in this file:

### **C:\emu8086\emu8086.ini**

By default it is set to false to enable coding a little bit faster without the necessity to use "**byte ptr**" and "**word ptr**" in places where it is clear without these long constructions (i.e. when one of the operands is a register).

Note: the settings in emu8086.ini do not apply to fasm (flat assembler). To use fasm add **#fasm#** or any valid **format** directive (valid for emu8086 version 4.00-Beta-15 and above)

For differences between the integrated assembler (MASM/TASM compatible) and FASM see [fasm\\_compatibility.asm](#)

FASM does not require the **offset** directive. By default all textual labels are offsets (even if defined with DB/DW)

To specify a variable [ ] must be put around it.

To avoid conflicts between 8086 integrated assembler and fasm, it is recommended to place this directive on top of all files that are designed for flat assembler:

**#fasm#**

### **Question:**

I've installed emu8086 on several computers in one of my electronics labs. Everything seems to work correctly when I am logged onto any of the PC's but, when any of the students log on, the virtual device programs controlled by the example ASM programs do not respond. ex; using LED\_display\_test.ASM.

The lab is set up with Windows XP machines on a domain. I have admin privileges but the students do not. I tried setting the security setting of **C:\emu8086** so all users have full privileges but it did not help. Are there other folders that are in play when the program is running?

---

### **Solution:**

In order for virtual devices to work correctly, it is required to set READ/WRITE privileges for these files that are created by the emulator in the root folder of the drive C:

**C:\emu8086.io**

**c:\emu8086.hw**

These files are used to communicate between the virtual devices and the emulator, and it should be allowed for programs that run under students' login to create, read and write to and from these files freely.

To see simulated memory - click emulator's "aux" button and then select "memory" from the popup menu.

## 1\_sample.asm

name "hi-world"

; this example prints out "hello world!"  
; by writing directly to video memory.  
; in vga memory: first byte is ascii character, byte that follows is character attribute.  
; if you change the second byte, you can change the color of  
; the character even after it is printed.  
; character attribute is 8 bit value,  
; high 4 bits set background color and low 4 bits set foreground color.

; hex	bin	color
; 0	0000	black
; 1	0001	blue
; 2	0010	green
; 3	0011	cyan
; 4	0100	red
; 5	0101	magenta
; 6	0110	brown
; 7	0111	light gray
; 8	1000	dark gray
; 9	1001	light blue
; a	1010	light green
; b	1011	light cyan
; c	1100	light red
; d	1101	light magenta
; e	1110	yellow
; f	1111	white

org 100h

; set video mode  
**mov ax, 3** ; text mode 80x25, 16 colors, 8 pages (ah=0, al=3)  
**int 10h** ; do it!



```
; cancel blinking and enable all 16 colors:
```

```
mov ax, 1003h
```

```
mov bx, 0
```

```
int 10h
```

```
; set segment register:
```

```
mov ax, 0b800h
```

```
mov ds, ax
```

```
; print "hello world"
```

```
; first byte is ascii code, second byte is color code.
```

```
mov [02h], 'h'
```

```
mov [04h], 'e'
```

```
mov [06h], 'l'
```

```
mov [08h], 'l'
```

```
mov [0ah], 'o'
```

```
mov [0ch], ','
```

```
mov [0eh], 'w'
```

```
mov [10h], 'o'
```

```
mov [12h], 'r'
```

```
mov [14h], 'l'
```

```
mov [16h], 'd'
```

```
mov [18h], 'l'
```

```
; color all characters:
```

```
mov cx, 12 ; number of characters.
```

```
mov di, 03h ; start from byte after 'h'
```

```
c: mov [di], 11101100b ; light red(1100) on yellow(1110)
```

```
add di, 2 ; skip over next ascii code in vga memory.
```

```
loop c
```

```
; wait for any key press:
```

```
mov ah, 0
```

```
int 16h
```

## 2\_sample.asm

```
name "add-sub"
```

```
org 100h
```

```
mov al, 5    ; bin=00000101b  
mov bl, 10   ; hex=0ah or bin=00001010b
```

```
; 5 + 10 = 15 (decimal) or hex=0fh or bin=00001111b  
add bl, al
```

```
; 15 - 1 = 14 (decimal) or hex=0eh or bin=00001110b  
sub bl, 1
```

```
; print result in binary:
```

```
mov cx, 8
```

```
print: mov ah, 2 ; print function.
```

```
    mov dl, '0'
```

```
    test bl, 10000000b ; test first bit.
```

```
    jz zero
```

```
    mov dl, '1'
```

```
zero: int 21h
```

```
    shl bl, 1
```

```
loop print
```

```
; print binary suffix:
```

```
mov dl, 'b'
```

```
int 21h
```

```
; wait for any key press:
```

```
mov ah, 0
```

```
int 16h
```

```
ret
```

