

MECHANICAL TRANSMISSION REPAIR MANUAL

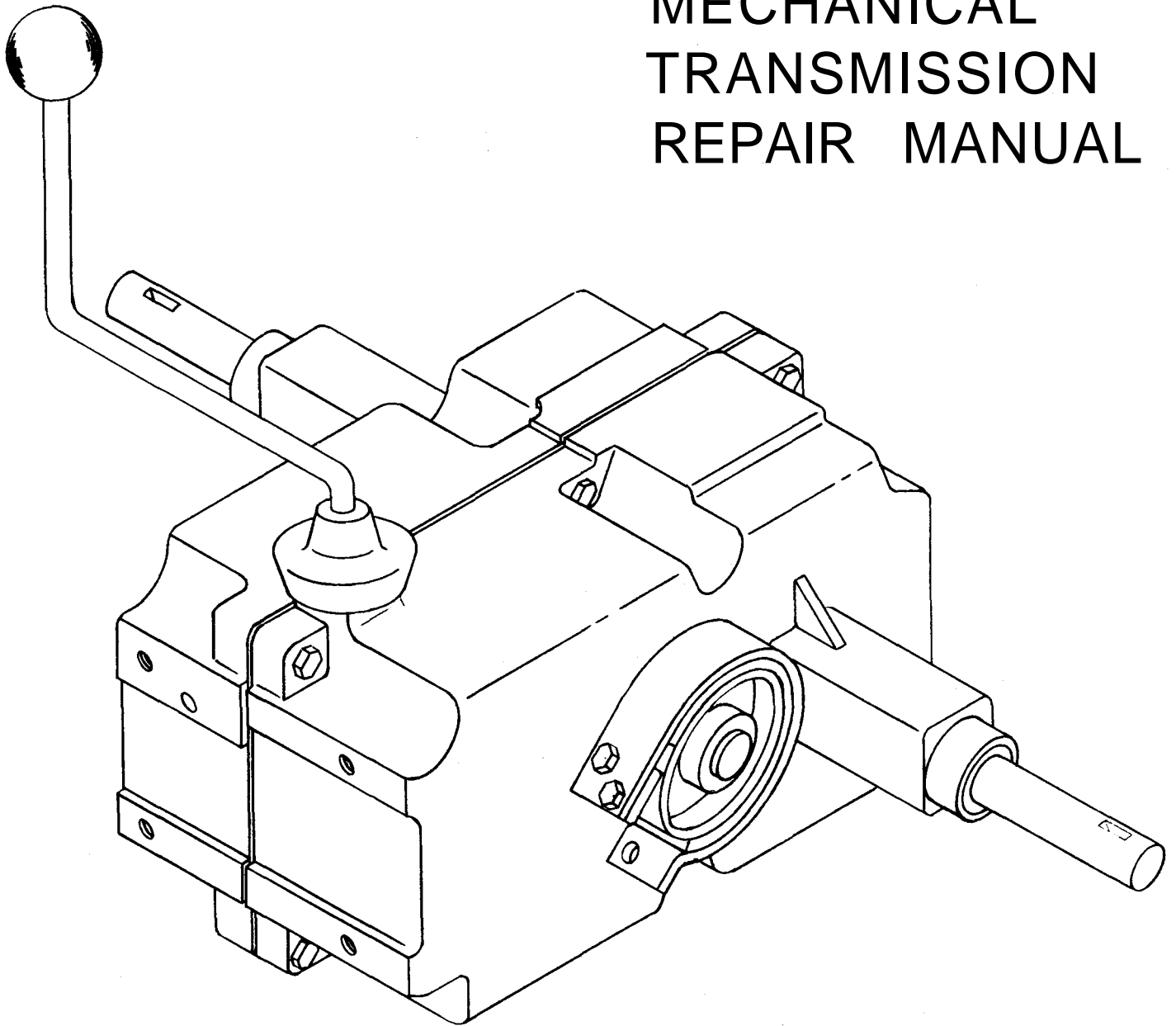

WHEEL HORSE

lawn & garden tractors

WHEEL HORSE PRODUCTS, INC. 515 West Ireland Road. P.O. Box 2649 South Bend, Indiana 46680
PRINTED IN U.S. A. 0482 Revision

FORM NO. A-1392

P/N 492-4004

FOREWORD

This service and repair manual has been compiled to provide authorized Wheel Horse service personnel with the proper procedures and techniques for servicing Wheel Horse mechanical transmissions.

The following index lists all areas covered. It is advisable to read all of the introductory sections first to gain a proper understanding of the Wheel Horse mechanical transmission used in each model.

The transmission is a sophisticated piece of machinery. Maintain strict cleanliness control during all stages of service and repair. Even a small amount of dirt or other contamination can severely damage the components.

Product information and specifications are shown herein as of the time of printing. Wheel Horse Products, Inc. reserves the right to change product specifications, designs and standard equipment without notice and without incurring obligation.

CONTENTS

	Page		Page
TRANSMISSION USAGE CHART.	4	SECTION III	
SECTION I		5060 6-SPEED TRANSMISSION.	27-36
5003 - 5010 TRANSMISSIONS.	5-14	Description.	27
Removal.	5	Removal.	27
Installation.	5	Installation.	27
Disassembly.	6-8	Disassembly.	28-29
Cleaning, Inspection, Bearing and		Cluster Gear.	29
Oil Seal Replacement	8	Cleaning, Inspection, Bearing and	
Assembly.	8-9	Oil Seal Replacement	29
DIFFERENTIAL OVERHAUL	10-11	Assembly.	30-32
Disassembly.	10	LIMITED SLIP DIFFERENTIAL	32-34
Cleaning, Inspection, Parts Replacement	10	Disassembly.	32-33
Assembly.	11	Assembly.	33-34
5003 AND 5010 SERVICE NOTES.	12	EXPLODED VIEW.	35
EXPLODED VIEW.	13	PARTS LIST.	36
PARTS LIST.	14	SECTION IV	
SECTION II		4-SPEED UNIDRIVE TRANSMISSION	37-44
5053 - 5058 3-SPEED UNIDRIVE.	15-26	Description.	37
Description.	15	Removal.	37
Removal.	15	Installation.	37
Replacement.	16-17	Disassembly.	37-40
Disassembly.	16-18	Cleaning, Inspection, Bearing and	
Cleaning, Inspection, Bearing and		Oil Seal Replacement	40
Oil Seal Replacement	18	Assembly.	40-41
Assembly.	19-20	DIFFERENTIAL OVERHAUL	42-43
Assembly of 5058 Series with		Disassembly.	42
Bevel Gear Differential.	21	Assembly.	42-43
DIFFERENTIAL OVERHAUL	21-22	EXPLODED VIEW.	43
Disassembly (Standard Differential)	21	PARTS LIST.	44
Assembly (Standard Differential).	22	SECTION V	
Disassembly (Bevel Gear Differential)	22	8-SPEED TRANSMISSION.	45-53
Assembly (Bevel Gear Differential)	22	Description.	45
EXPLODED VIEW (5053 TRANSMISSION)	23	Removal.	45
PARTS UST (5053 TRANSMISSION)	24	Installation.	45
EXPLODED VIEW (5058 TRANSMISSION)	25	Disassembly.	45-47
PARTS LIST (5058 TRANSMISSION)	26	Needle Bearing Replacement	47
		Cluster Gear.	47
		Cleaning, Inspection, Bearing and	
		Oil Seal Replacement	47
		Assembly.	47-50
		8-PINION DIFFERENTIAL	50
		Disassembly.	50
		Assembly.	50
		EXPLODED VIEWS.	51-52
		PARTS LIST.	53

TRANSMISSION USAGE

YEAR	TRACTOR MODEL	TRANSMISSION USED	MANUAL SECTION	
1958 1959	RJ-58 RJ-59	5003	I	
1960	Suburban "400" &"500"	5010	I	
1961	401	5010	I	
	551, 701	5007	II	
1962	502, 552, 702, 32E, 32R	5025	II	
1963	33E, 33R, 603, 633, 653, 753	5025	II	
	953	5045	II	
1964	34E, 34R, 604, 654, 704	5046	II	
	854	5025	II	
	1045	5025	II	
	1054	5047	II	
1965	L-105, L-155	5048*	II	
	605, 655, 855, 1055	5049	II	
	1054A	5051	II	
1966	L-106, L-156, 606, 656, 1046,	5053	II	
	1056, 856	5053	II	
1967	L-107, L-157, 607, 657, 857	5053	II	
	867, 1067, 1267	5060	III	
	1057, 1257	5058	II	
1968	Lawn Ranger	1-2631 Electric	5053	II
	Lawn Ranger	1-1631 Recoil	5053	II
	"500" Special	1-3631	5053	II
	Commando 6	1-4631	5053	II
	Commando 8	1-4831	5053	II
	Raider 9, 10	1-6931 - 1-6041	5060	III
	Raider 12	1-6231 - 1-6241	5060	III
1969	Workhorse "700"	1-3745 - 1-3741	5053	II
	Raider 10	1-6041	5071	III
	Raider 12	1-6241	5071	III
1970	Raider 10	1-6051	5073	V
	Raider 12	1-6251	5073	V
	Raider 12	1-6253	5073	V
1971	Workhorse "800"	1-0100	5080	IV
	Raider 10	1-0300	5073	V
	Raider 12	1-0310	5073	V
1972	Raider 8	1-0330	5086	V
	Raider 10	1-0301	5086	V
	Raider 12	1-0311	5073	V
	Raider 14	1-0320	5073	V
	Commando "800"	1-0110	5085	IV
1973	8 HP Eight Speed	1-0370	5086	V
	10 HP Eight Speed	1-0360	5086	V
	12 HP Eight Speed	1-0350	5073	V
	14 HP Eight Speed	1-0340	5073	V
	8 HP Four Speed	1-0120	5085	IV
1974	B-80 4 Speed	1-0140	5080, 5084	IV
	C-100 8 Speed	1-0390	5091	V
	C-120 8 Speed	1-0353	5091	V
	C-160 8 Speed	1-0380	5091	V
1975	B-80 4 Speed	1-0141	5084	IV
	C-100 8 Speed	1-0391	5091	V
	C-160 8 Speed	1-0381	5091	V

Up-date 5048 to 5053 with 7168 kit.

TRANSMISSION USAGE

YEAR	TRACTOR MODEL	VIN NUMBER	TRANSMISSION USED	MANUAL SECTION
1976	B-60 8-Speed	61-07K801	5091	V
	B-80 8-Speed	61-08K801, 61-08K802 & 61-08K804	5091	V
	B-80 8-Speed	61-08K803	103907	V
	B-100 8-Speed	61-10K801, 61-10K802 & 61-10K804	5091	V
	B-100 8-Speed	61-10K803	103907	V
	C-120 8-Speed	61-12K801, 61-12K802 & 61-12K804	5091	V
	C-120 8-Speed	61-12K803	103907	V
	C-160 8-Speed	61-16K801, 61-16K802 & 61-16K804	5091	V
	C-160 8-Speed	61-16K803	103907	V
	1977	B-60 8-Speed	71-07K801	103907
B-80 8-Speed		71-08K801	103907	V
B-100 8-Speed		71-10K801	103907	V
C-120 8-Speed		71-12K801	103907	V
C-160 8-Speed		71-16K801 & 71-16K802	103907	V
1978	C-81 8-Speed	81-08K801	103916	V
	C-101 8-Speed	81-10K801	103916	V
	C-121 8-Speed	81-12K801	103916	V
	C-141 8-Speed	81-14K801	103916	V
	C-161 8-Speed	81-16K801	103916	V
	C-161 Twin 8-Speed	81-16B801	103916	V
1979	C-81 8-Speed	91-08K801 & 91-08K802	103916	V
	C-101 8-Speed	91-10K801 & 91-10K802	103916	V
	C-111 8-Speed	91-11B801	103916	V
	C-121 8-Speed	91-12K801 & 91-12K802	103916	V
	C-141 8-Speed	91-14K801 & 91-14K802	103916	V
	C-161 8-Speed	91-16K801	103916	V
	C-161 Twin 8-Speed	91-16B801 & 91-16B802	103916	V

TRANSMISSION USAGE

YEAR	TRACTOR MODEL	VIN NUMBER	TRANSMISSION USED	MANUAL SECTION
1980	C-85 8-Speed	01-08K801 & 01-08K802	103916	V
	C-105 8-Speed	01-10K801	103916	V
	1100 Special	01-11B803	5086	V
	C-125 8-Speed	01-12K801	103916	V
	C-145 8-Speed	01-14K801	103916	V
	C-165 8-Speed	01-16K801	103916	V
	C-175 Twin 8-Speed	01-17K802	103916	V
	E-141 8-Speed	01-14E801	103918	V
1981	C-85 8-Speed	01-08K802	103916	V
	C-105 8-Speed	01-10K802	103916	V
	C-125 8-Speed	01-12K802	103916	V
	C-145 8-Speed	01-14K802	103916	V
	C-165 8-Speed	01-16K802	103916	V
	C-175 Twin 8-Speed	01-17K802	103916	V
	E-141 8-Speed	01-14E801	103918	V
	GT-2500 8-Speed	01-11B804	5086	V
1982	C-85 8-Speed	01-08K803	103916	V
	C-105 8-Speed	01-10K803	103916	V
	C-125 8-Speed	01-12K803	103916	V
	C-175 Twin 8-Speed	01-17K803	103916	V
	E-141 8-Speed	01-14E801	103916	V
	GT-1142 8-Speed	AI-114201	5086	V
	GT-1642 8-Speed	AI-164201	5086	V
	SB-421 8-Speed	01-11BH01	5086	V
SK-486 8-Speed	01-16KH01	5086	V	

Section I

5003 - 5010 TRANSMISSIONS

DESCRIPTION

The 5003 and 5010 transmissions are readily identified by their removable steel side covers which are bolted to a one piece cast iron case. The transmissions are of the sliding gear type and provide three speeds forward and one speed in reverse.

All shafts operate on needle or ball bearings supported by the steel side covers.

The differential is of the spur pinion type. On all original equipment transmissions, the ring gear is an integral part of the differential case. The service replacement, however, consists of a case and gear assembly in which the gear is bolted to the differential case.

RATIOS

1st gear.66.8 to 1
2nd gear.42.4 to 1
3rd gear.24.6 to 1
Reverse.51.5 to 1

REMOVAL AND REPLACEMENT

Removal:

Remove any mid-mounted or trailing attachment which might interfere with transmission removal. Provide some support under the tractor frame ahead of the transmission.

Remove the seat, fender and tool box assembly if so equipped, belt guard, belt, and clutch rod. Disconnect the lift cable and remove the hitch.

Remove three bolts at each transmission side cover and frame side rail. Move transmission assembly away from the tractor. Remove the wheels and hubs, clutch and idler arm assembly, and transmission input pulley.

Drain lubricant and clean case as necessary before disassembling.

Installation:

Install clutch and idler arm assembly, brake rod, and input pulley. Install wheels and hubs and move assembly into place on the tractor. Install three bolts through holes in each transmission side cover and corresponding holes in frame side rails. Tighten nuts securely.

Install drive belt and belt guard. Connect clutch rod. Lay lift cable in place along top of transmission, install hitch and connect lift cable.

Install fender and tool box assembly if so equipped, and install seat. Remove support from beneath tractor frame.

5003-5010 3-SPEED TRANSMISSION

Disassembly:

The transmission should be mounted in a vise or suitable fixture as shown in Figure 1, with the left cover up and the gear shift lever and top of the case toward the mechanic working on the unit.

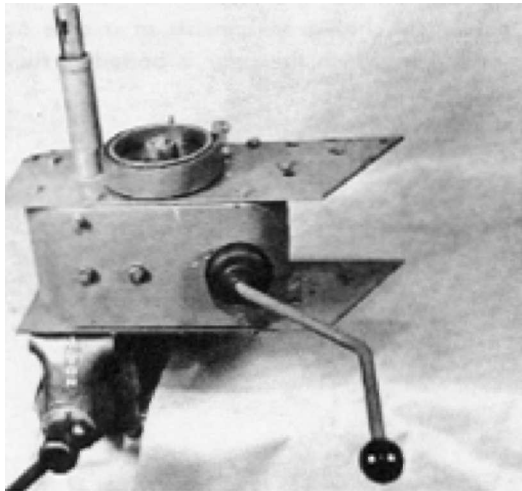

FIGURE 1

The following steps are for complete disassembly with the transmission in the vise, as shown in Figure 1.

1. Lift the rubber shift lever boot and loosen the shift lever set screw and lock nut, and remove the shift lever.
2. Remove the two bolts that hold the brake band to the side cover bracket and remove the brake band.
3. Remove the snap ring (some models may have a set screw) from the brake shaft and remove the drum using a suitable puller as required. Remove the Woodruff key from the brake shaft.

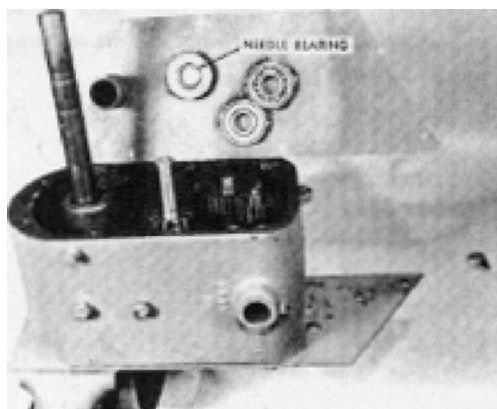

FIGURE 2

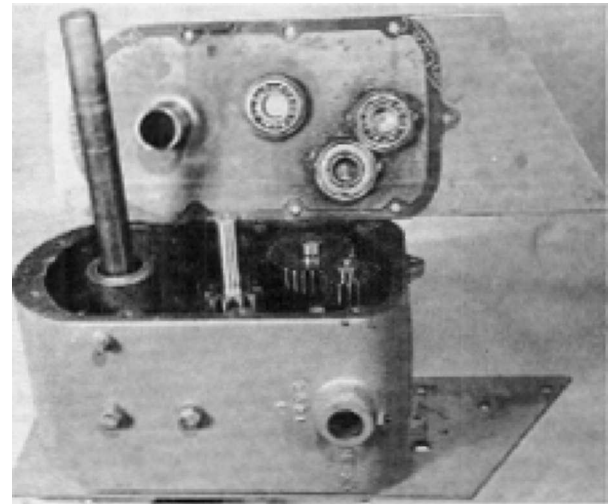

FIGURE 3

4. Clean and remove all burrs from both axle shafts and brake shaft and remove both axle seals.
5. Remove the nine left cover retaining bolts and lift off the cover. NOTE: Figures 2 and 3 show the two types of covers used on these transmissions, one with a ball bearing and one with a needle bearing at the brake shaft location. Replacement information for each type is given in Service Notes 1 and 2, Page 12.

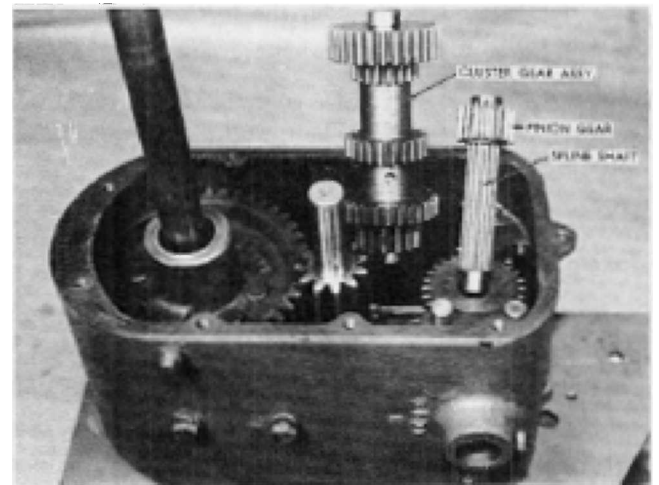

FIGURE 4

6. Remove the spline shaft and pinion gear. See Figure 4. NOTE: The shaft and matching gears in some transmissions have 10 splines while later models have 11 splines. For details and ordering information, refer to Service Note 3, Page 12.
7. Remove the bolts from the right cover and break the case loose from the cover gasket. This will allow the case to shift sufficiently to let the cluster gear assembly to be worked loose and re-

moved, as shown in Figure 4. The cluster gear may be disassembled as shown in Figure 5. Disassemble and assemble carefully to avoid damage to the Woodruff keys and bushings. The cluster gear bushings may be removed and installed using suitable arbors.

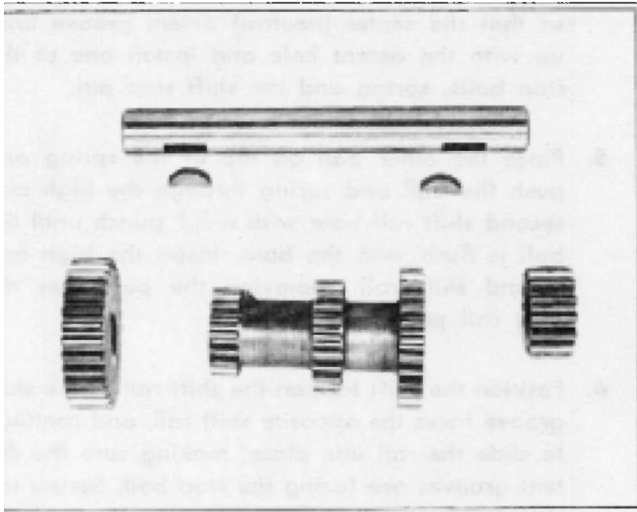

FIGURE 5

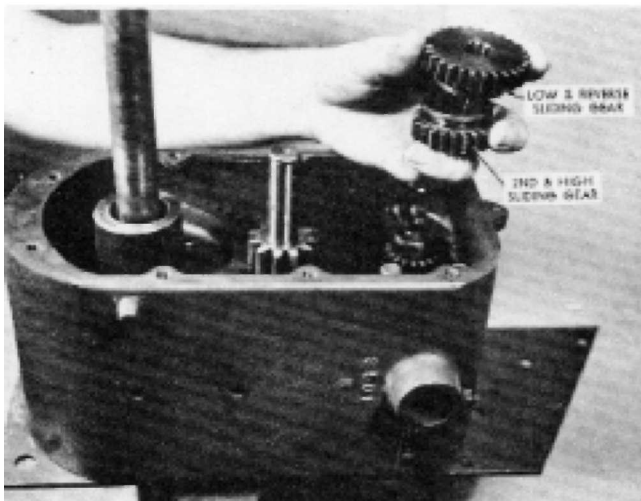

FIGURE 6

8. Remove the low and reverse, and the high and second sliding gears. If either gear is to be replaced, refer to Service Note 3, Page 9.
9. Lift the brake shaft gear slightly, and rotate the transmission case to the right and upward, over the top of the input gear. Position the case so that the differential ring gear is centered between the two seat spring bosses. The case may now be removed by working it up over the differential ring gear.

10. Remove the differential and axle assembly, the broke shaft gear and the input gear and shaft. See Figure 7. Remove the input shaft seal.

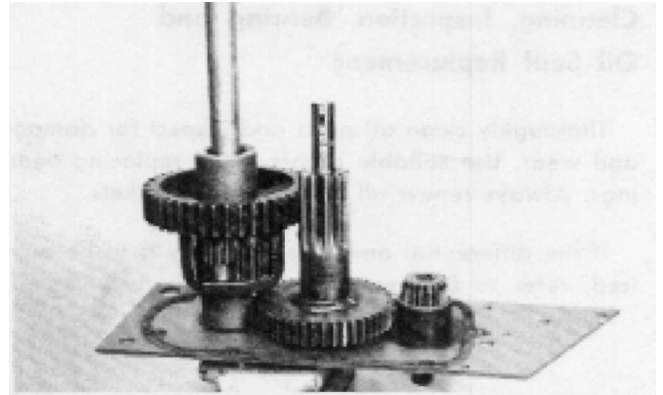

FIGURE 7

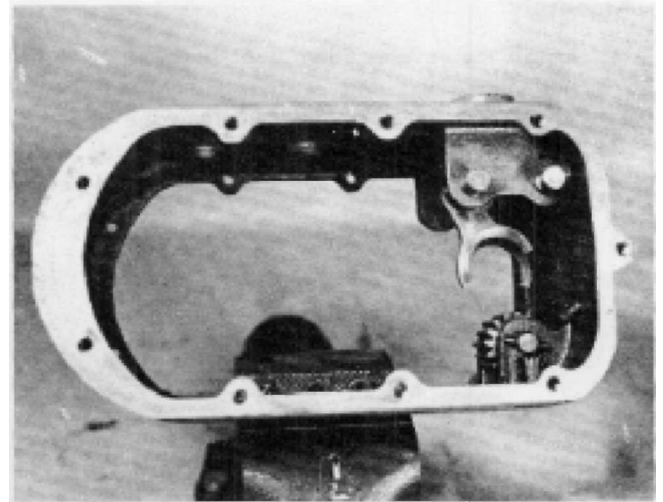

FIGURE 8

11. To remove the reverse idler gear, drive out the roll pin from the idler gear pin and remove the pin and gear. See Figure 8. (Early models used a roll pin at each end of the idler gear pin.)
12. Before removing the shift forks and shift rails, mating parts should be marked or scribed so they may be reassembled properly. The shift fork retaining roll pins may be removed by driving them out with a 1/8" punch inserted through the shift lever tower. Remove the shift rails making sure to catch the two balls, spring and stop pin as they are released. NOTE: Although the shift forks are identical, the shift rails differ. The low and reverse shift rail (located nearest

the end of the case) has three equally spaced detent grooves. The high and second shift rail has two of the three detent grooves closely spaced.

Cleaning, Inspection, Bearing and Oil Seal Replacement

Thoroughly clean all parts and inspect for damage and wear. Use suitable arbors when replacing bearings. Always renew all oil seals and gaskets.

If the differential and axle assembly is to be serviced, refer to Differential Overhaul Section.

5003-5010 3-SPEED TRANSMISSION

Assembly:

1. Install the reverse idler gear in position so that the chamfered end of the gear faces the left side of the case. This will position the gear with the straight edge toward the right side of the case, as shown in Figure 9. Install the reverse idler pin and secure with a roll pin.

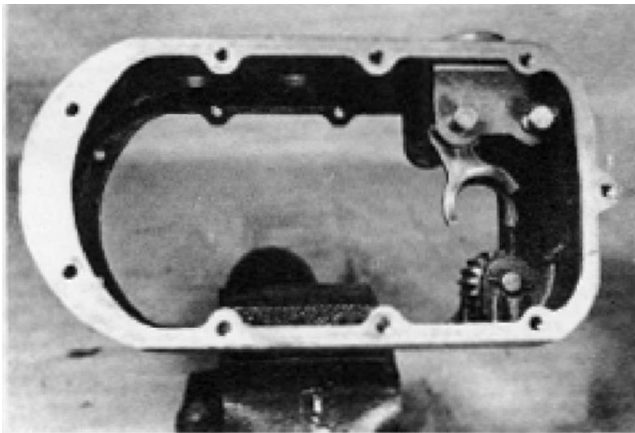

FIGURE 9

2. Position the low and reverse shift fork (the one nearest the end of the case) between the shift rail supports so that the shift lever groove points toward the opposite shift rail.
3. Insert the low and reverse shift rail (the one with the equally spaced detent grooves) and

slide into position, making sure the detent grooves are toward the opposite shift rail. Secure the shift fork to the shift rail with a 1/8" x 1" roll pin.

4. Position the low and reverse shift rail assembly so that the center (neutral) detent groove lines up with the detent hole and install one of the stop balls, spring and the shift stop pin.
5. Place the other ball on top of the spring and push the ball and spring through the high and second shift rail bore with a punch until the ball is flush with the bore. Insert the high and second shift rail, removing the punch as the shift rail passes the ball.
6. Position the shift fork on the shift rail so the shift groove faces the opposite shift rail, and continue to slide the rail into place, making sure the detent grooves are facing the stop ball. Secure the shift fork to the shift rail with a 1/8" x 1" roll pin.

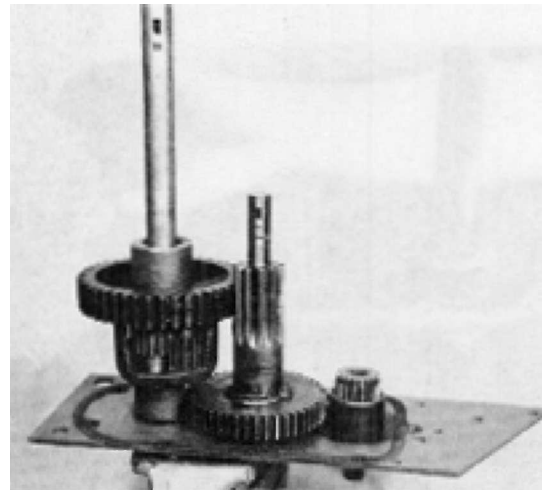

FIGURE 10

7. Place the right side cover in a vise. Install the input gear and shaft assembly. See Figure 10.
8. Install the side cover gasket using gasket sealer to hold in position.
9. Install the brake shaft gear.
10. Install the differential and axle assembly. See Figure 10 showing the input gear, brake shaft gear and differential assembly in position.

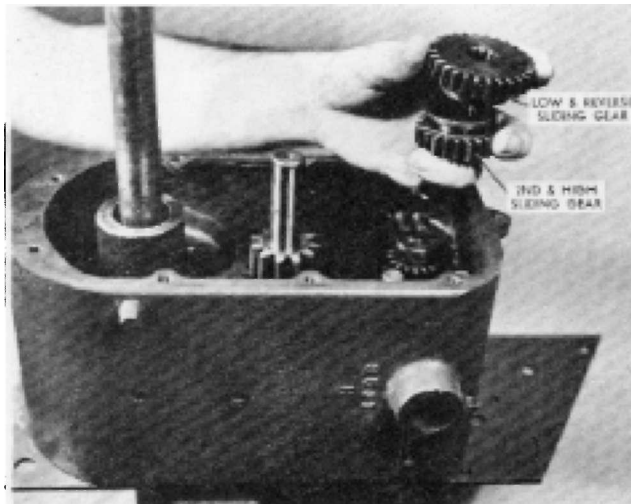

FIGURE 11

11. Before installing transmission case make sure that it is positioned properly in relation to the right side cover. This will place the shift lever tower to the front and toward you, as in Figure 11.
12. To install the case, work it down over the differential ring gear, lift the brake shaft gear slightly, and seat case in position. Make sure the brake shaft gear and differential assembly are seated.
13. Position the high and second sliding gear (the smaller one) on the lower shift fork. Position the low and reverse (the larger one) on the upper shift fork. When properly installed the shift fork grooves will be adjacent to each other. See Figure 11.
14. Install the cluster gear assembly. See Figure 12.
15. Install the spline shaft and pinion gear and seat in position.
16. Install the right side cover bolts. Do not tighten at this time.
17. Make sure shift forks are in neutral position and insert shift lever and secure with the retaining set screw and lock nut. Do not tighten set screw too tight, as it may bind the shift lever.
18. Install the shift lever rubber boot.

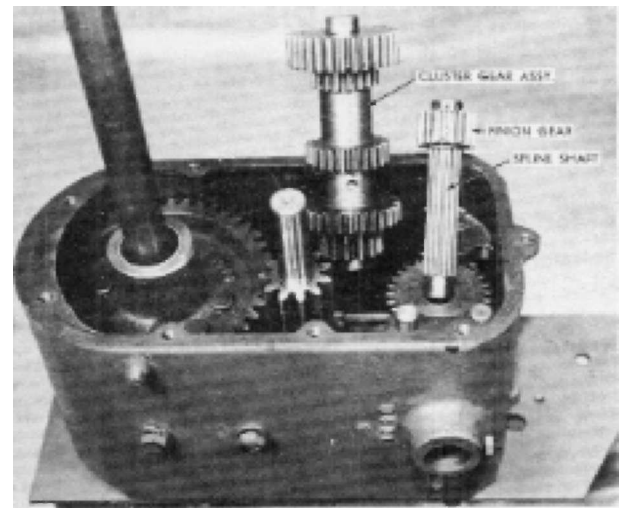

FIGURE 12

19. Turn input shaft and shift transmission into all ranges to determine if the unit has been properly assembled.
20. Install gasket on left side cover using gasket sealer to hold in place.
21. Install left side cover over the axle and brake shaft and tap gently into position, making sure that all bearings and shafts are properly seated.
22. Install left side cover retaining bolts and torque all bolts on both side covers evenly.
23. Check transmission for proper operation and for a free neutral.
24. Carefully install all new oil seals and again check for free operation.
25. Install the brake shaft Woodruff key and install the brake drum. Secure the brake drum with the snap ring. Install the brake band and fasten to the anchor bracket with the two bolts.
26. Fill transmission to check plug level with lubricant. The fill plug is located on top of the case. The check plug is on the right side cover next to the axle tube.

5003-5010 DIFFERENTIAL OVERHAUL

For removal of differential assembly, see Transmission Disassembly Section.

Disassembly:

1. Drive the roll pins from the end of the differential pins, remove the pins (early models used roll pins at each end of the differential pins) and remove the spider gears. See Figure 1.

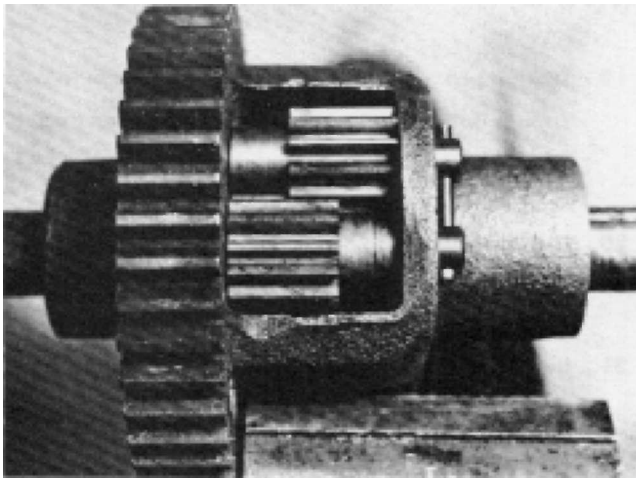

FIGURE 1

2. Drive the roll pins out of the axles and pull the axles from the axle gears. See Figure 2.

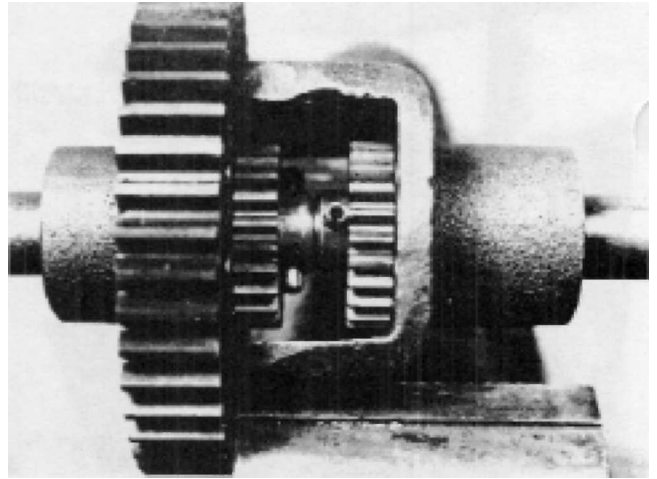

FIGURE 2

3. Lift the axle gears out of the case. Remove the Woodruff keys from the axles.

Cleaning, Inspection, Parts Replacement

Thoroughly clean all parts and inspect for damage and wear. Use a suitable arbor when replacing bushings. If replacement of the differential case or gear is required, refer to Service Note 5, Page 12.

Figure 3 shows a breakdown of the entire differential assembly.

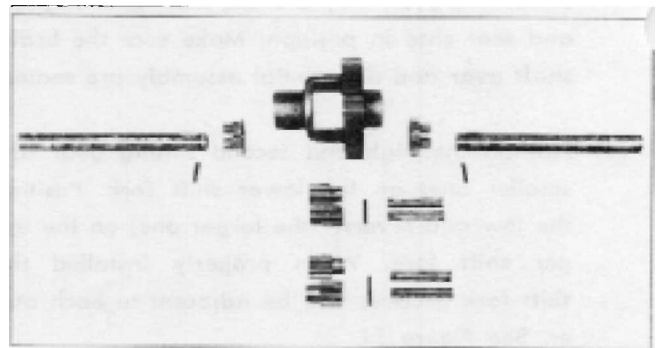

FIGURE 3

5003-5010 DIFFERENTIAL

Assembly:

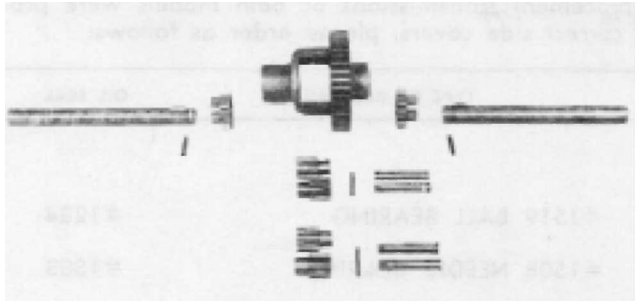

FIGURE 4

1. To assemble the differential (see breakdown Figure 4) place the axle gears in the differential case, insert the Woodruff keys in the axles, slide the axles into the axle gears and drive in the retaining roll pins. (Figure 5 shows the axles, gears and roll pins assembled.) If the axles will not slide freely into the axle gears, place a spacer between the two axle gears, which will hold them apart enabling the axles to be driven into position.

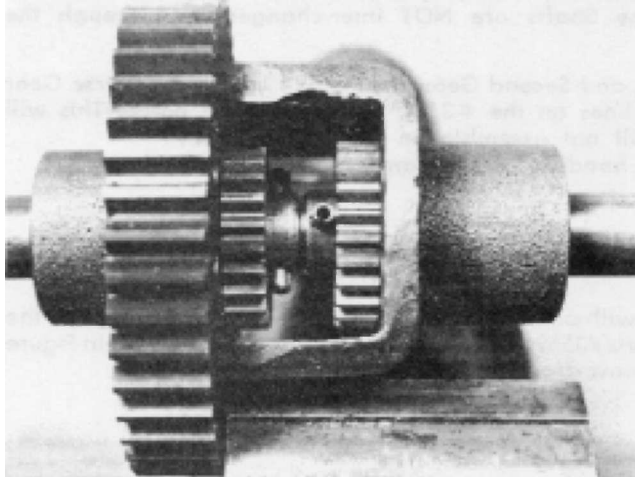

FIGURE 5

2. Place the spider gears in position, as shown in Figure 6, slide the differential pins into position through the spiders and secure with roll pins.

NOTE: The spiders must be placed in position as shown, and the diagonally opposite spiders should be in the same direction. Check for proper operation.

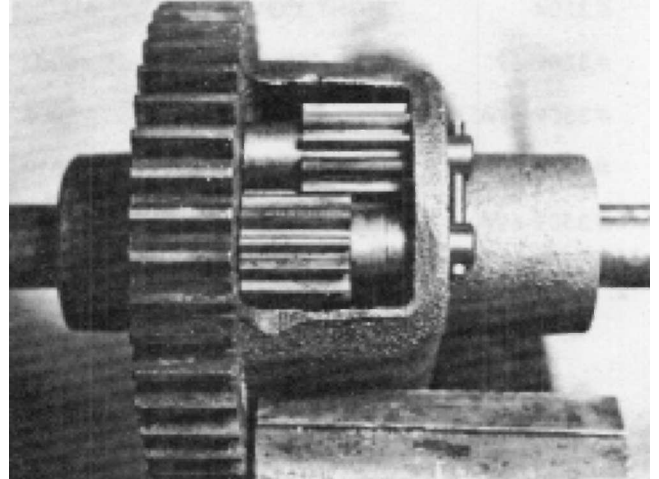

FIGURE 6

For installation in transmission case, the Transmission Assembly Section.

5003 AND 5010 SERVICE NOTES

1. TRANSMISSION COVERS

All #5003 production transmissions and the early #5010 transmissions were equipped with ball bearings on the brake shaft. Late #5010 transmissions and replacement transmissions of both models were produced with needle bearings. To insure receiving the correct side covers, please order as follows:

PART NO.	DESCRIPTION	USED ON	TYPE OF BEARING	OIL SEAL
#3504	RIGHT COVER	ALL		
#3509-59	LEFT COVER	#5003	#1519 BALL BEARING	#1234
#3509-59A	LEFT COVER	#5003	#1508 NEEDLE BEARING	#1303
#3509-60	LEFT COVER	#5010	#1519 BALL BEARING	#1234
#3509-60A	LEFT COVER	#5010	#1508 NEEDLE BEARING	#1303

2. #3559 BRAKE SHAFTS

- A. Original equipment brake shafts used in ball bearing type transmissions cannot be used with needle bearing side covers.
- B. Presently stocked brake shafts and those used in needle bearing transmissions are interchangeable. To install in ball bearing transmissions, use four 1197 Shim Washers between the brake shaft gear and the left side cover plate.

3. SPLINE SHAFT AND MATCHING GEARS

All tractors and replacement transmissions produced previous to tractor Serial No. 11628, contain Part No. 3521 Spline Shafts with 10 straight sides splines and matching gears, Part Nos. 3523, 3524 and 3526.

All tractors and replacement transmissions produced after tractor serial number 11628, contain Part No. 3521 Spline Shafts with 11 involute tooth form splines and matching gears, Part Nos. 3523, 3524 and 3526. The matching gears for the two types of Spline Shafts are NOT inter-changeable, although the part numbers are identical.

It is suggested that, when ordering the #3523 High and Second Gear, the #3524 Low and Reverse Gear or the #3526 Splined Pinion Gear, the number of Splines on the #3521 Spline Shaft be noted. This will eliminate the possibility of receiving gears which will not assemble on the Spline Shaft. The ordering of the #3521 Spline Shafts should be handled in the same manner.

4. #3559 BRAKE SHAFT

The original #3559 brake shaft has been replaced with a new design. The new shaft has more strength and able to carry more load.

- 5. The #3502 differential case and gear has been replaced with part #7243 and #3559 (See Figure A). If **either** the original #3559 or #3502 are required, order **both** new parts #3559 and #7243. The new parts are shown in Figure A. The original construction is shown in the exploded view drawing.

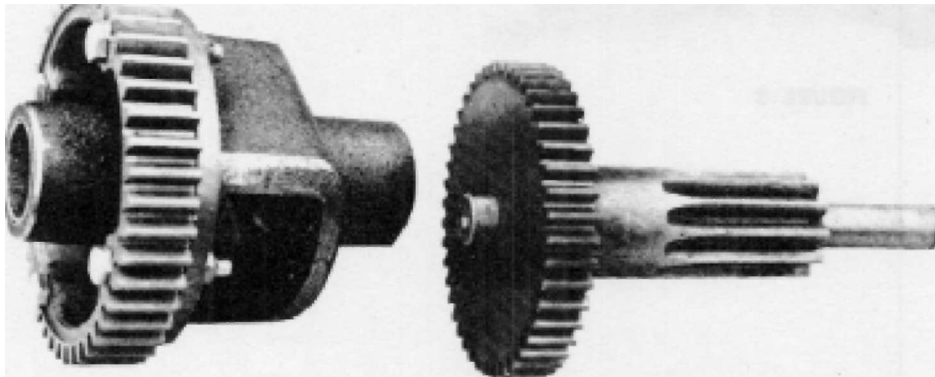
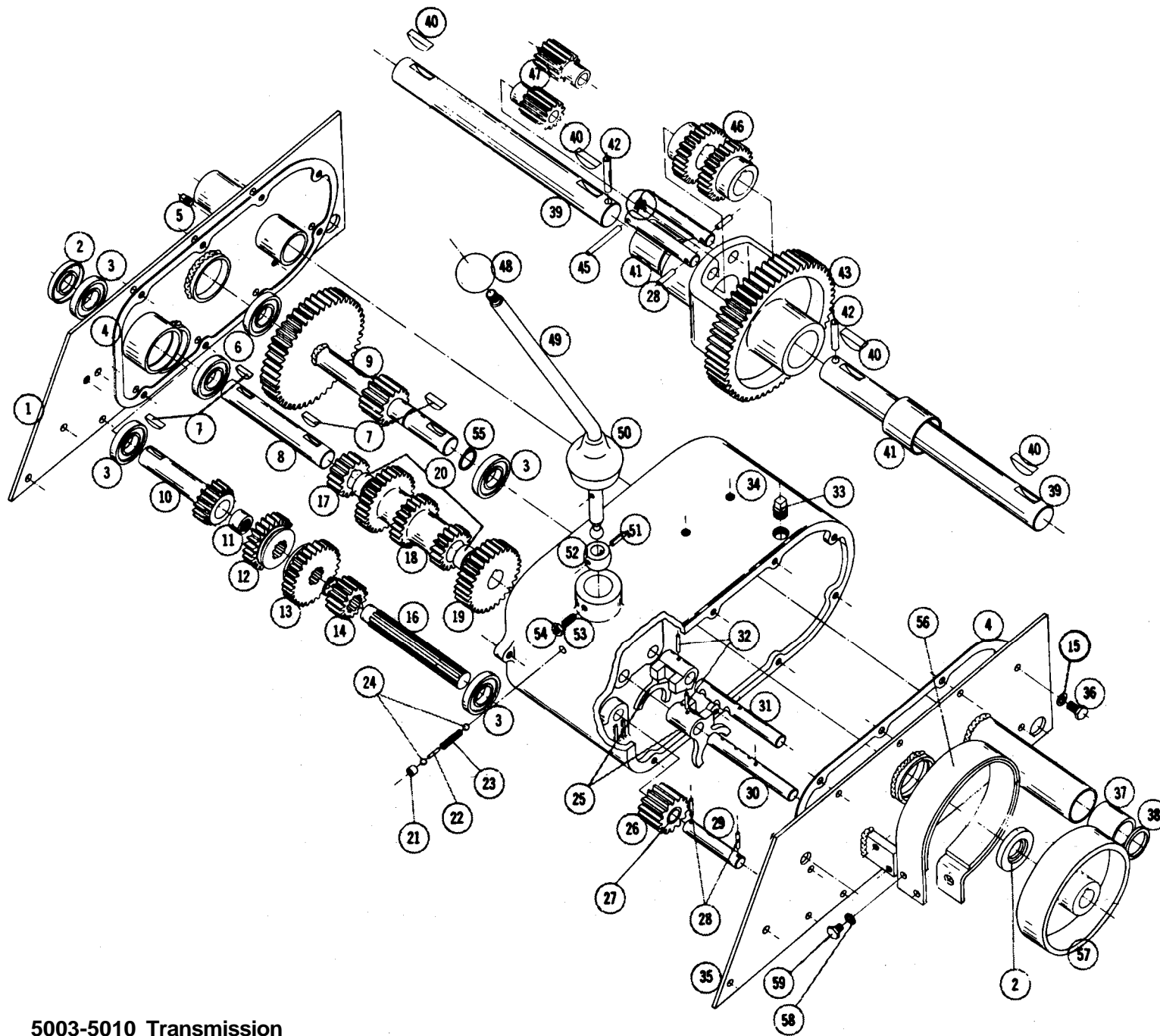

FIGURE A



5003-5010 Transmission

5003-5010 TRANSMISSION

When ordering parts always list Part No. and name of part.

(Specifications subject to change without notice.)

Ref. No.	Part No.	Description	No. Req'd.	Ref. No.	Part No.	Description	No. Req'd.
** 1	3504	Right Transmission Cover	1	31	3516	Shift Rail — Rear	1
2	1234	Oil Seal	2	32	933156	Roll Pin 1/8 x 1	2
** 3	1519	Ball Bearing	4	33	1013	Pipe Plug	1
4	3536	Gasket Transmission	2	34	3501	Transmission Housing	1
5	1108	Pipe Plug 1/8"	1	** 35	3509	Left Transmission Cover	1
6	1502	Ball Bearing	3	36	908016-4	Hex Bolt 5/16-18 x 5/8	18
7	1122	No. 9 Woodruff Key	4	37	1503	Bronze Bearing	2
8	3533	Cluster Shaft	1	is	1257	Oil Seal	2
*** P	3559	Brake Shaft and Gear	1	39	3532	Axle	2
10	3522	Input Gear	1	40	937022	Key - Woodruff No. 15	4
11	1518	Needle Bearing	1	41	1517	Bronze Bearing	2
• 12	3523	Hi & Second Gear	1	42	933217	Roll Pin 1/4 x 1 1/2	2
* 13	3524	Low & Reverse Gear	1	... 43	3502	Differential Case and Gear	1
• 14	3526	Splined Pinion	1	44	3535	Differential Pins	4
15	920082-4	Lockwasher 5/16 Dia.	18	45	933194	Roll Pin 3/16 x 1 3/4	2
• 16	3521	Spline Shaft	1	46	3530	Axle Gear — Differential	2
17	3528	Cluster Shaft Reduction Pinion	1	47	3531	Spider Gear — Differential	4
18	3525	Cluster Gear	1	48	1001	Knob	1
19	3527	Cluster Shaft Reduction Gear	1	49	3538	Lever — Shift	1
20	1504	Bronze Bearing		50	3577	Boot — Shift Lever	1
21	1243	Cup Plug 5/16	1	51	933168	Roll Pin 5/32x 1316	
22	3573	Pin — Shift Stop	1	52	3514	Collar — Shift Lever	1
23	3518	Spring — Shift Stop	1	53	1239	1/4-20 x 3/4, Dog Point Set Screw	1
24	3517	Ball — Stop		54	915111-6	Nut - Hex 1/4-20	1
25	3503	Shift Fork		55	936125	Snap Ring 3/4" Truarc	1
26	3520	Reverse Idler Gear with Bearing	1	56	3543	Brake Band with Liner	1
27	1516	Bearing — Reverse Idler Gear	1	57	3540	Brake Drum	1
28	933188	Roll Pin 3/16 x 1		58	920081-4	Lockwasher 1/4 Dia.	2
29	3519	Reverse Idler Pin	1	59	908002-4	Hex Bolt 1/4-20 x 5/8	2
30	3515	Shift Rail — Front	1				

*See Service Note #3

" See Service Note #1

** See Service Note #2 & 4

**** See Service Note #5

Section II

5053-5058 3-SPEED UNIDRIVE

DESCRIPTION

The 3-speed unidrive transmission is an all-gear transmission utilizing sliding gears and splined shafts for easy shifting. All shafts operate on needle or ball bearings supported by the transmission case. The transmission case consists of R.H. and L.H. cast iron case halves which are dowelled for alignment and bolted securely together.

Model 5053 covers all standard models (5007, 5025, 5046, 5048, 5049, and 5053) equipped with the spur gear differential.

Model 5058 covers all heavy duty models (5045, 5047, 5051, 5059, and 5058) incorporating the bevel gear differential.

The model numbers 5053 and 5058 used in this section stand for the full line of unidrive transmissions produced since 1961.

RATIOS

1st gear.66.8 to 1
2nd gear.42.4 to 1
3rd gear.24.6 to 1
Reverse.51.5 to 1

REMOVAL AND REPLACEMENT

Removal:

These basic instructions apply to all tractors equipped with Unidrive transmissions. Deviate from them as necessary for any particular tractor.

Remove mid-mounted or trailing attachments, or hitches which might interfere with transmission removal. Support the tractor frame ahead of the transmission just enough that the rear wheels no longer carry any weight.

Remove the R.H. foot rest, if so equipped, belt guard, and belt. Disconnect the brake rod or remove the brake band from the anchor bracket. On most models, remove the fender and seat assembly. If

necessary to gain clearance, remove the dust cover and instruction plate located just ahead of the shift lever.

Remove two cap screws that fasten through the bottom of the tool box into the top of the transmission. Remove four cap screws that go through the frame butt plate into the front of the transmission. Lower the front of the transmission, guide the shift lever down between the frame rails, and roll the transmission and wheel assembly free of the tractor.

Drain lubricant, remove wheels, and clean transmission as necessary before disassembling.

Installation:

NOTE: It is recommended that two pilot studs be used to facilitate transmission installation. To make the studs, cut the heads off of two 3/8"-16 x 2" hex head or carriage bolts. Grind a taper on the unthreaded end of each bolt. Screw one stud into one of the upper holes in the front of the transmission

case. Put the other one in the diagonally opposite lower hole.

Install input pulley, axle hubs and wheels. Move the transmission assembly into place and guide the shift lever up between the frame rails. Align the pilot

studs with the corresponding holes in the frame butt plate and push the transmission firmly in place against the plate. Install cap screws in the top of the transmission and the open holes in the front, and tighten them until snug. Remove the pilot studs one at a time, replacing them with cap screws. Tighten all six cap screws securely.

Connect brake linkage. Install dust cover, instruction plate, fender and seat assembly, drive belt, belt guard, foot rest, etc.

Fill the transmission to proper level with S.A.E. 90 gear oil. Remove support from beneath tractor frame. Test tractor operation.

UNIDRIVE TRANSMISSION 5053 - 5058

Disassembly:

These instructions apply to all unidrive models unless indicated. A section applying only to specific models will be so identified.

1. Remove axle hubs and input pulley.
2. Place the transmission assembly in a vise or suitable holding fixture, as shown in Figure 1.

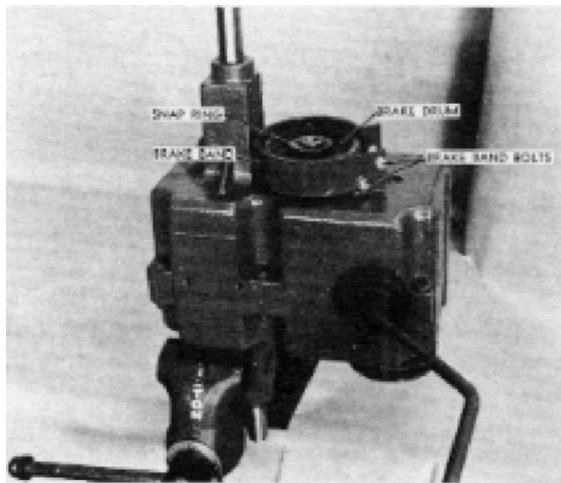

FIGURE 1

3. Place the gear shift lever in neutral and pull the gear shift lever rubber boot away from the transmission boss. Loosen the gear shift lever retaining lock nut and set screw and remove the gear shift lever.
4. Remove the two (2) brake band retaining bolts and remove the brake band.
5. Remove the brake drum retaining ring and remove the brake drum using a suitable puller as required. See Figure 2.
6. Remove the six (6) $\frac{3}{8}$ " x 16 bolts and nuts that retain the right hand and left hand cases.

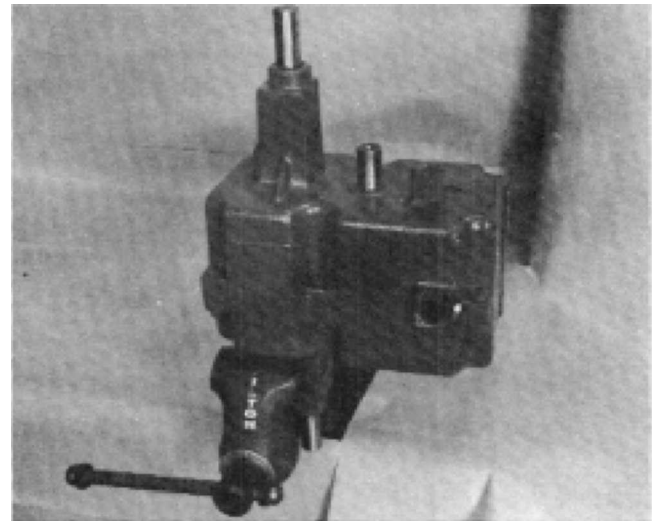

FIGURE 2

7. Remove paint and burrs from both axle shafts, brake shaft, and the input shaft.
8. Remove the left hand case, as shown in Figure 3.

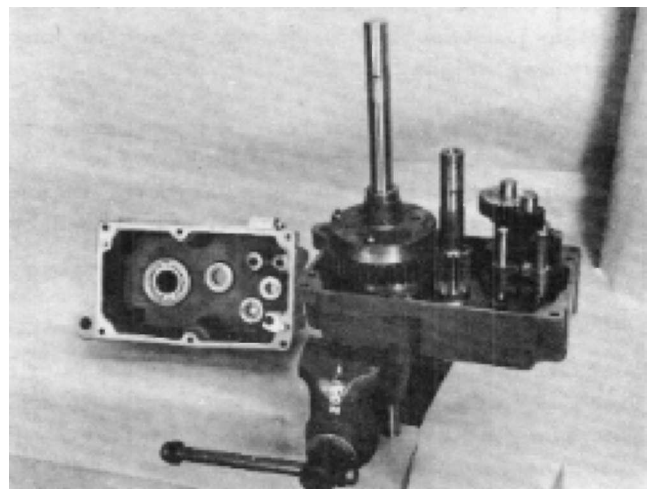

FIGURE 3

9. Lift out the axle and differential assembly. Figure 4. Note: If only the differential is to be overhauled the transmission need not be further disassembled. See Differential Overhaul Section.
10. Shift the 2nd and high shift fork assembly up into the 2nd speed position. See Figure 4.

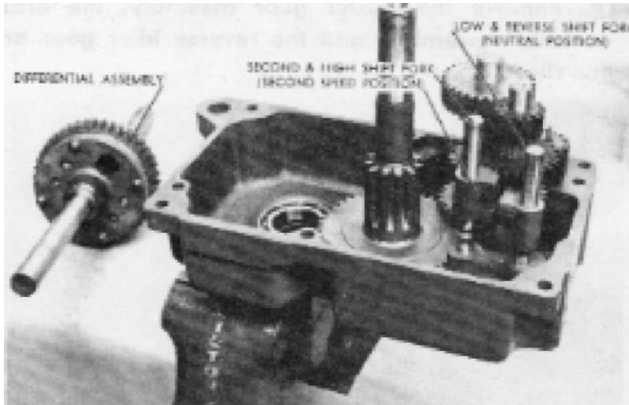

FIGURE 4

The following steps 11 through 17 apply to all unidrive models except 5058 and 5059. For models 5058 and 5059 follow steps 1A through 7A.

11. Remove the splined pinion shaft and gear. At the same time the cluster gear assembly may be removed. See Figure 5.



FIGURE 5

12. Remove the brake shaft gear assembly and the reverse idler gear. See Figure 6.
13. Remove the 2nd and high sliding gear and the low and reverse sliding gear, as shown in Figure 7.



FIGURE 6



FIGURE 7

14. Place the shift forks in neutral and remove first the low and reverse shift rail and fork assembly, then the 2nd and high rail and fork assembly, being careful not to lose the two stop balls, spring and stop pin as they are released. Figure 8.



FIGURE 8

15. Remove the reverse idler shaft and the input shaft and gear. See Figure 9. Note: The reverse idler shaft may sometimes stick in the left hand case.



FIGURE 9

16. If it is desired to replace the case bearings they may easily be removed and installed with suitable arbors. When replacing bearings they should be pressed in so that they are flush with the inside of the case, as shown in Figure 10.

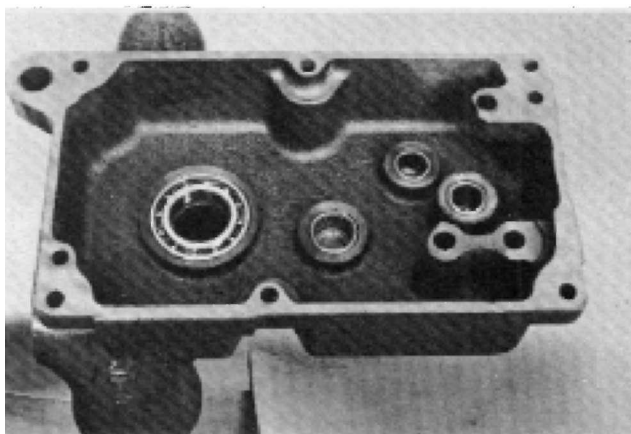

FIGURE 10

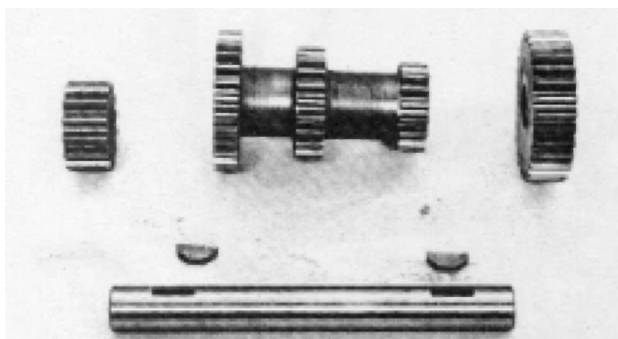

FIGURE 11

17. The cluster gear may be disassembled, as shown in Figure 11. Disassemble and assemble carefully to avoid damage to the woodruff keys and bushings. The cluster gear bushings may be removed and installed using suitable arbors.

The following steps 1A through 7A apply to Uni-drive models 5058 and 5059 only.

- 1A. Remove the cluster gear assembly, the brake shaft assembly, and the reverse idler gear and shaft.



FIGURE 12

- 2A. Remove the splined pinion gear from the input shaft.
- 3A. Place the shift fork in neutral and remove the low and reverse shift rail and fork assembly (the one nearest the end of the case) together with the low and reverse sliding gear making sure to catch the stop ball as the shift rail is removed. See Figure 12.
- 4A. Remove the 2nd and high shift rail and fork assembly together with the 2nd and high sliding gear.
- 5A. Remove the remaining stop ball, spring and stop pin.
- 6A. Remove the input shaft and gear assembly.
- 7A. Refer to step 17 if cluster is to be overhauled.

Cleaning, Inspection, Bearing and Oil Seal Replacement

Thoroughly clean all parts and inspect for damage and wear. Use suitable arbors when replacing bearings. Always renew all oil seals and gaskets.

UNIDRIVE TRANSMISSION 5053 - 5058

Assembly:

Place the right hand case in a vise or other suitable fixture for assembly, as shown in Figure 13.

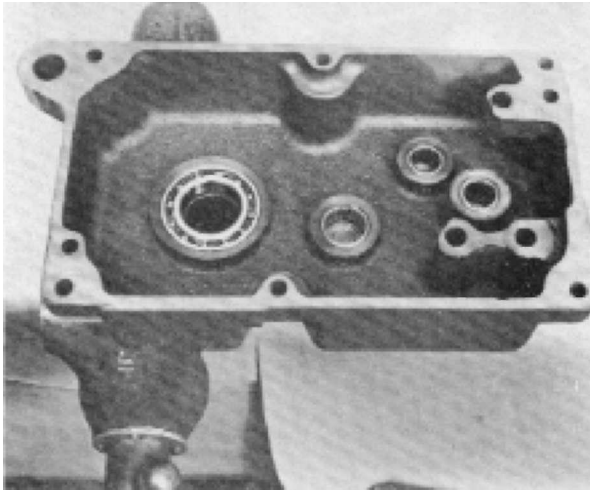

FIGURE 13

The following steps apply to all unidrive models except 5058 and 5059. For these models, follow steps 1B through 17B.

1. Install the input shaft and gear, and reverse idler shaft, as shown in Figure 14.

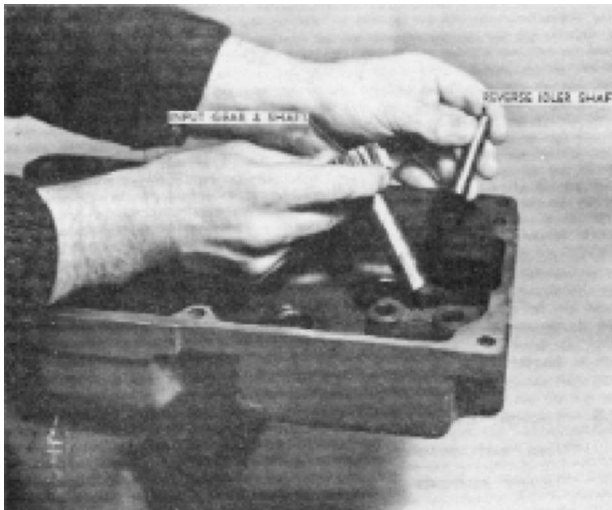

FIGURE 14

2. Install the 2nd and high shift rail and fork assembly (the one with the unequally spaced detent grooves.) See Figure 16.
3. Install one stop ball, spring and stop pin. Refer to detent drawing and Figure 15.

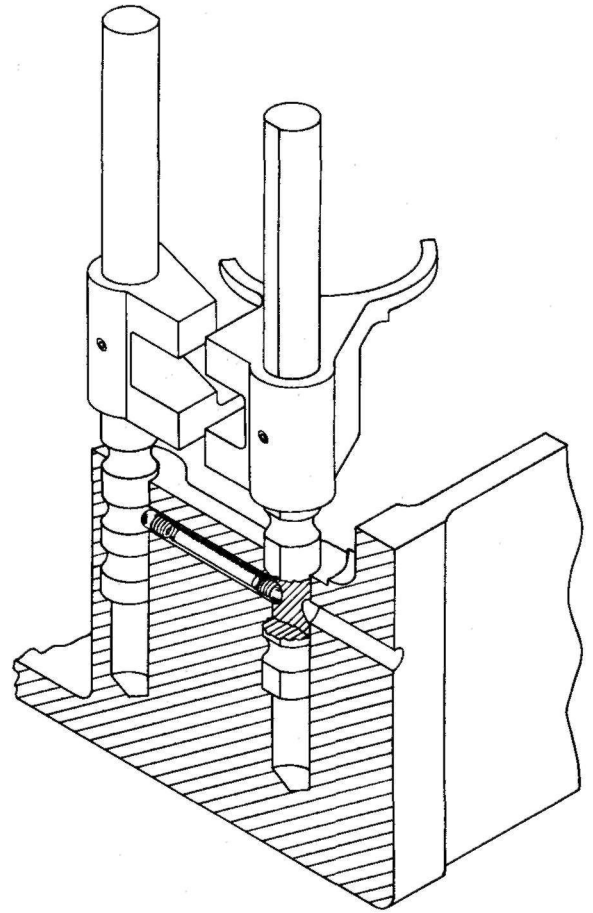

FIGURE 15

4. Install the 2nd stop ball and using a punch push the ball in against the spring. Move the 2nd & high shift rail into the neutral position and continue to push on the punch until the ball is flush with the shift rail bore. At the same time insert the low and reverse shift rail and fork assembly, removing the punch, as the shift rail passes the ball. See Detent Drawing. Figure 15 and 16.



FIGURE 16

- Shift the 2nd and high shift fork into the 2nd speed position and install the 2nd and high sliding gear, and the low and reverse sliding gear in position on their respective forks. Figure 17. Note that the shift fork grooves of the sliding gears face each other, and that the smaller of the two gears is the 2nd and high gears which goes on the bottom.

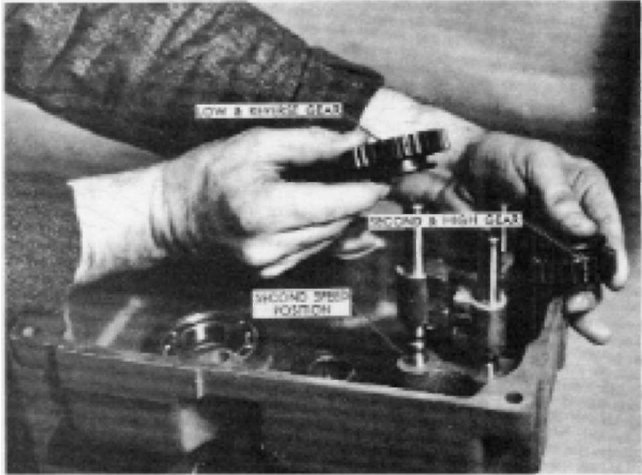

FIGURE 17

- Install the reverse idler and the brake shaft, as shown in Figure 18, making sure that the flanged end on the reverse idler goes down.
- Install the splined shaft and gear through the two splined sliding gears seating the bottom end of the shaft into the input gear bearing. See Figure 19. Install the cluster gear assembly carefully seating it in its bearing and meshing it with its related gears.
- Install the differential and axle assembly, as shown in Figure 20, making sure that four (4) nuts are up toward the L. H. case.



FIGURE 18

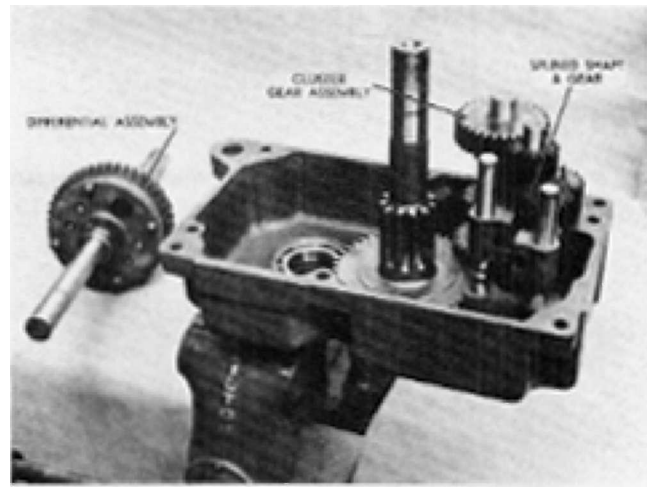

FIGURE 19

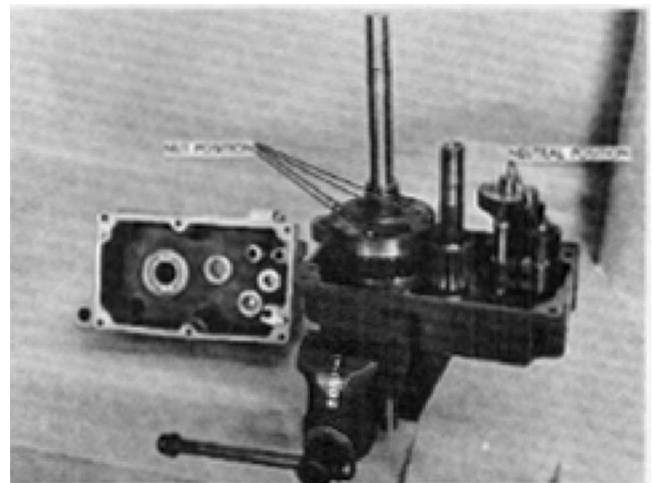

FIGURE 20

- Place shift forks in neutral position and check for a free neutral and proper operation in all gears.
- Install a new case gasket holding it in place with gasket sealer and install the left hand case.
- Install the six (6) 3/8" x 16 bolts and nuts and tighten all bolts evenly to avoid distortion.
- Install the shift lever assembly and retain with the set screw and lock nut. Install gear shift lever rubber boot.
- Check again for a free neutral and operation in all gears.
- Install the brake shaft Woodruff key and install the brake drum. Install the brake drum retaining snap ring.
- Install the brake band and secure with the two retaining bolts.

Assembly of 5058 Series With Bevel Gear Differential

- 1B. Install the input shaft and gear assembly.
- 2B. Install the 2nd and high shift rail and fork assembly (the one with the unequally spaced detent grooves) together with the 2nd and high sliding gear (the smaller of the two sliding gears). The sliding gear fits down over the input shaft with the shift fork groove up. See Figure 21.
- 3B. Install one stop ball, spring and stop pin. See drawing Figure 15.
- 4B. Install the 2nd stop ball and using a punch push the ball in against the spring. Move the 2nd & high shift rail into the neutral position and continue to push on the punch until the ball is flush with the shift rail bore. At the same time insert the low and reverse shift rail and fork assembly together with the low and reverse sliding gear, removing the punch as the shift rail passes the ball. (See detent drawing Figure 15.) Note: The low and reverse gear fits down over the input shaft with the shift fork groove down. See Figure 21.

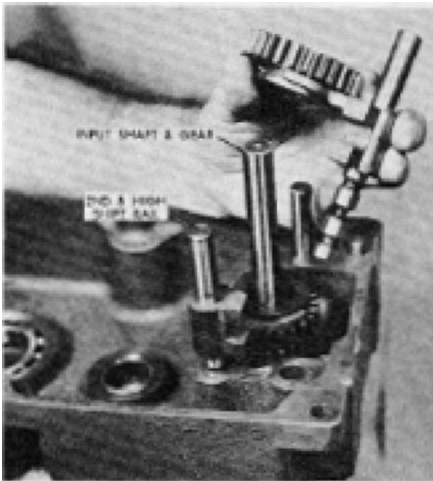

FIGURE 21

- 5B. Install the splined pinion shaft gear down over the input shaft gear and through the two sliding gears.
- 6B. Shift the 2nd and high shift rail and fork assembly in to 2nd speed position.
- 7B. Install the reverse idler gear shaft and gear assembly making sure that the shoulder of the gear goes down.
- 8B. Install the brake shaft gear.
- 9B. Install the cluster gear assembly.
- 10B. Install the differential and axle assembly with the differential bolt heads down. This will place the left hand differential case with the threaded bolt holes up.
- 11B. Place shift forks in neutral position. Check for a free neutral and proper operation in all ranges.

- 12B. Install a new case gasket holding it in place with gasket sealer and install the left hand case.
- 13B. Install the six (6) 3/8 x 16 bolts and nuts and tighten all bolts evenly to avoid distortion.
- 14B. Install the shift lever assembly and retain with the set screw and lock nut. Install gear shift lever rubber boot.
- 15B. Check again for a free neutral and operation in all ranges.
- 16B. Install the brake shaft Woodruff key and install the brake drum. Install the brake drum retaining snap ring.
- 17B. Install the brake band and secure with the two retaining bolts.

DIFFERENTIAL OVERHAUL STANDARD DIFFERENTIAL

Disassembly:

1. Remove the four (4) retaining bolts and nuts.
2. Lift off the differential side case together with the axle shaft and gear.
3. Remove the axle shaft and gear from the case.
4. Remove the differential bull gear.
5. Note position of the four (4) pinions. Adjacent pinions are installed in opposite directions, which make the position of the diagonally opposite pinions the same. See Figure 1.

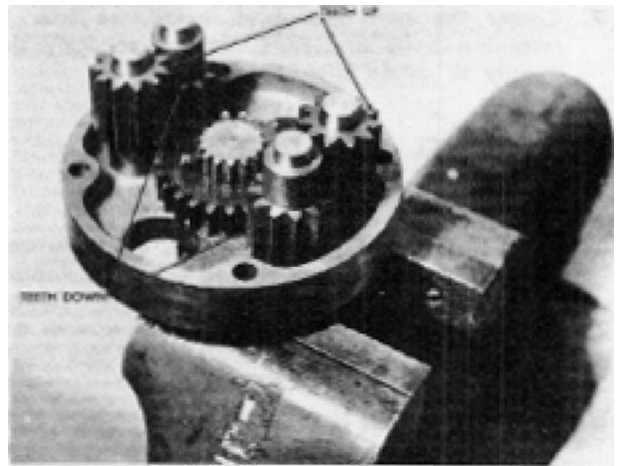

FIGURE 1

6. Remove the pinions and shafts and remove the remaining axle shaft and gear from the case.
7. The axle shaft gears may easily be removed by driving out the roll pins.

Figure 2 is an exploded view of the complete standard differential assembly.

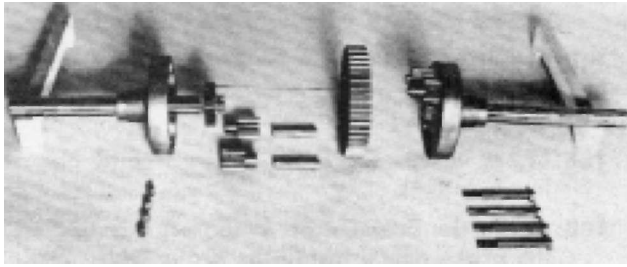

FIGURE 2

STANDARD DIFFERENTIAL

Assembly:

1. If the axle gears were removed install them on the axles and install the retaining roll pins.
2. Install one of the axle and gear assemblies in the differential case and install the four (4) pinion shafts.
3. Install two (2) pinions with their teeth up diagonally opposite each other, and install the other two (2) pinions with their teeth down diagonally opposite each other. See Figure 1.
4. Install the differential bull gear.
5. Install the remaining axle and gear assembly in the remaining differential case.
6. Position the axle and gear, and differential case over the pinion shafts, mesh the gears and seat the case against the ring gear.
7. Center the bull gear and install the four (4) retaining bolts and nuts. Tighten securely and evenly to avoid distortion.

BEVEL GEAR DIFFERENTIAL

Disassembly:

1. Install differential assembly in a vise, the case with the threaded holes should be down. Remove the four (4) bolts and lock washers and remove one of the axle shafts, gear, thrust washer and differential case half as an assembly. See Figure 3.
2. Remove the bull gear, differential pinion shaft, differential gears and differential blocks as an assembly.
3. Slide the differential blocks and gears toward the center and remove the assembly from the bull gear. The differential blocks and gears may now be removed from the shaft.
4. The axle shafts, gears and thrust washers may now be removed from the differential case.
5. The axle gears may be removed from the axle shafts by removing the roll pins. A break down of the parts is shown in Figure 4.

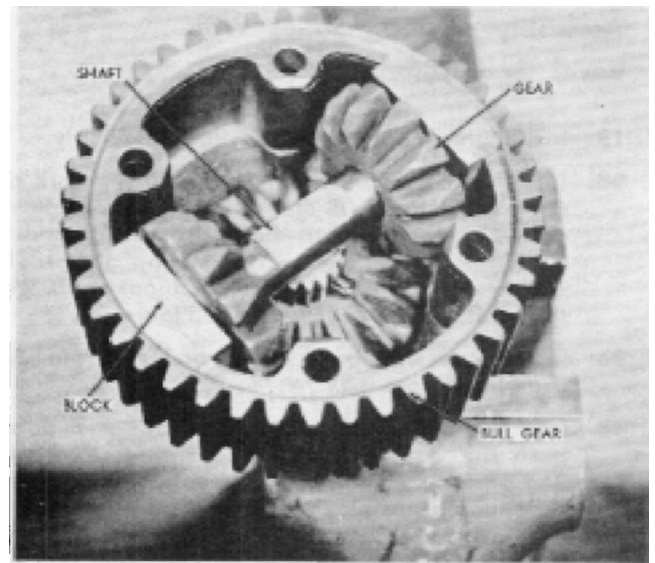
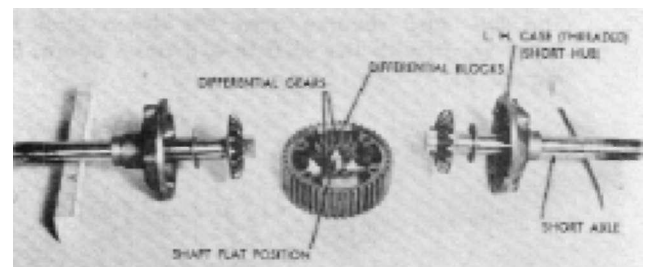

FIGURE 3



BEVEL GEAR DIFFERENTIAL

Assembly:

1. If the axle gears have been removed from the axles install the gears and retain with the roll pins.
2. Install a thrust washer on each axle next to the gear.
3. Install the short axle, gear and thrust washer assembly into the threaded left hand differential case.
4. Install differential shaft, gears and blocks as an assembly into the bull gear and push the gears and blocks outward, seating the blocks into position in the bull gear.

Install the bull gear, differential shaft, gears and blocks as an assembly onto the differential case seating the differential block and bull gear. See Figure 3.
5. Install the right hand (long) axle gear, and thrust washer assembly into the right hand differential case.

Install the right hand case and axle assembly onto the bull gear and center over the differential blocks. Secure with the 4-3/8" bolts and washers. Tighten evenly making sure the assemblies seat properly.

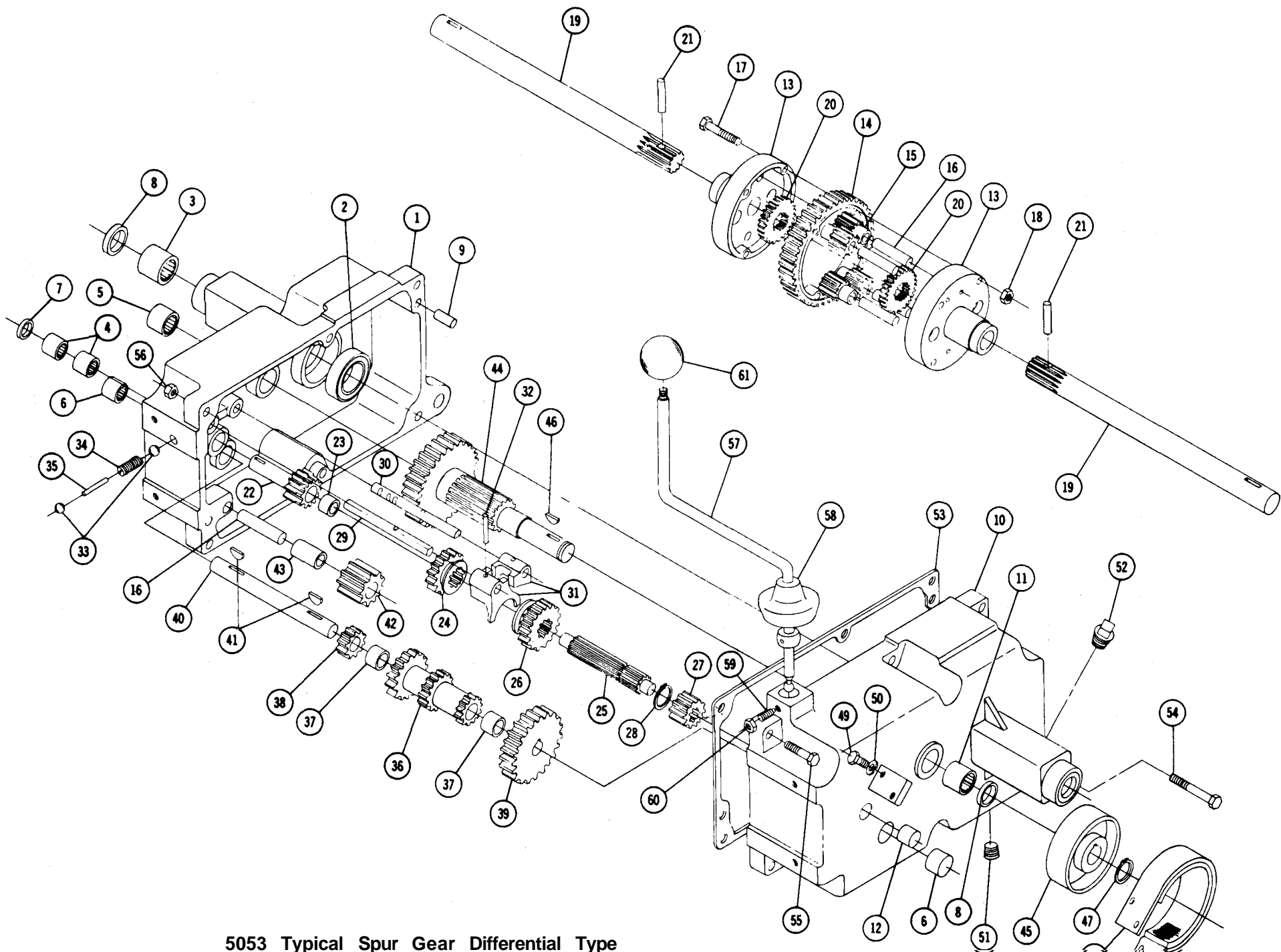

5053 Typical Spur Gear Differential Type

5053 TRANSMISSION PARTS LIST

When ordering parts always list Part No. and name of part.

(Specifications subject to change without notice.)

Item No.	Part No.	Description	No. Req'd.	Item No.	Part No.	Description	No. Req'd.
1	3900	Case R.H.	1	32	933156	Roll Pin 1/8 x 1	2
2	1533	Bearing — Ball 1 1/2 I.D.	2	33	3517	Ball — Shift Stop	2
3	1528	Bearing — Needle	2	34	3518	Spring — Shift Stop	1
4	1508	Bearing — Needle 3/4 I.D.	2	35	5614	Pin — Shift Stop	1
5	1532	Bearing — Needle 1" I.D.	1	36	3525	Gear — Cluster	1
6	1529	Bearing — Needle 3/4 I.D.	1	37	1504	Bearing — Bronze 3/4 I.D.	2
7	1303	Seal - Oil 3/4 Shaft	1	38	3528	Gear — Reduction Pinion	1
8	1232	Seal - Oil 1" Shaft	3	39	3527	Gear — Reduction	1
9	3915	Pin — Dowel	2	40	3910	Shaft — Cluster Gear	1
10	3901	Case L.H.	1	41	937014	Key #9 Woodruff	2
11	1530	Bearing — Needle 1" I.D.	1	42	4204	Gear — Reverse Idler	1
12	1531	Bearing — Needle 5/8 I.D.	1	43	1516	Bushing — Bronze 1/2 I.D.	1
13	3905	Case — Differential	2	44	3903	Gear — Brake Shaft	1
14	3906	Gear — Differential Bull	1	45	3902	Drum — Brake	1
15	4235	Gear — Differential Pinion	4	46	937022	Key #15 Woodruff	1
16	3909	Shaft	5	47	936131	Snap Ring 1" Shaft	1
17	908146	Bolt Hex 5/16-18 x 3 1/4	4	48	7376	Ass'y- Brake Band & Lining	1
18	1316	Nut Huglock 5/16-18	4	49	908002-4	Bolt Hex 1/4-20 x 5/8	2
19	3904	Axle — Rear	2	50	920081-4	Lockwasher 1/4 Dia.	2
20	3908	Gear — Axle	2	51	943460	Plug 1/4 Pipe	1
21	933217	Roll Pin 1/4 x 1 1/2	2	52	943420	Plug 3/8 Pipe	1
22	3522	Gear — Input	1	53	3912	Gasket	1
23	1518	Bearing — Needle 5/8 I.D.	1	54	908043-4	Bolt Hex 3/8-16 x 3 1/2	1
24	3523	Gear Hi & 2nd	1	55	908038-4	Bolt Hex 3/8-16 x 2	5
25	3907	Shaft Spline	1	56	915113-6	Nut Hex 3/8-16 Nylok	6
26	3524	Gear — Low & Reverse	1	*57	5632	Ass'y- Shift Stick	1
27	3526	Gear — Pinion — Splined	1	*58	3577	Boot — Shift Stick	1
28	936125	Snap Ring 3/4 Truarc		*59	1239	Set Screw Dog Point 1/4-20x3/4	1
29	5615	Rail — Front Shift		*60	915111-6	Nut Hex 1/4-20 Nylok	1
30	5616	Rail — Rear Shift		*61	1001	Knob	1
31	3503	Fork — Shift	2				

*Not included in No. 5053 Assembly.

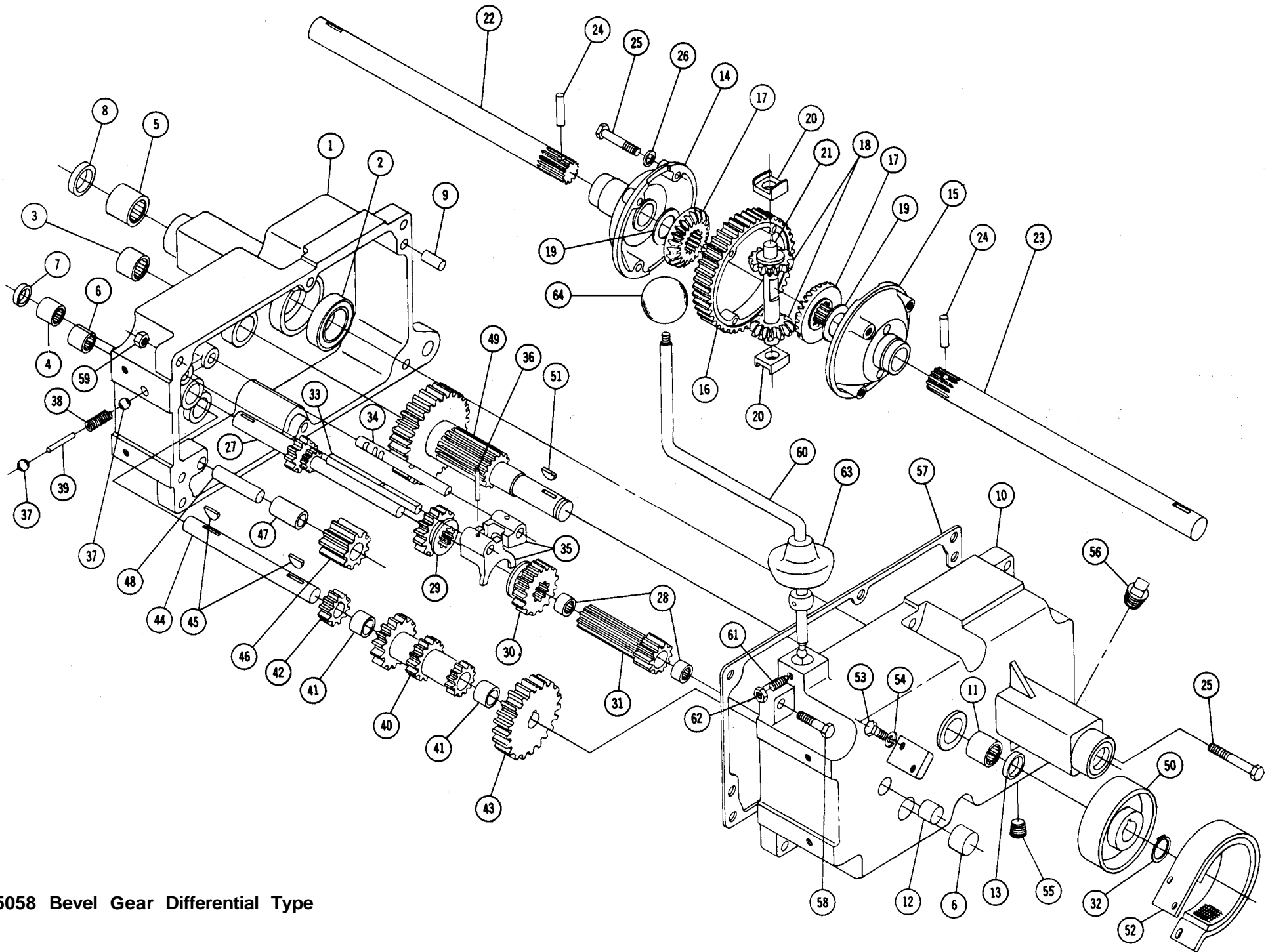

5058 Bevel Gear Differential Type

5058 TRANSMISSION PARTS LIST

When ordering parts always list Part No. and name of part.

(Specifications subject to change without notice.)

Item No.	Part No.	Description	No. Req'd.	Item No.	Part No.	Description	No. Req'd.
1	6940	Case R.H.	1	33	5615	Rail — Front Shift	1
2	1533	Ball Bearing 1 1/2 I.D.	2	34	5616	Rail — Rear Shift	1
3	1532	Bearing — Needle 1" I.D.	1	35	3503	Fork - Shift	2
4	1508	Bearing — Needle 3/4" I.D.	1	36	933156	Roll Pin 1/8 x 1	2
5	1526	Bearing — Needle 1 1/8 I.D.	2	37	3517	Ball — Shift Stop	2
6	1529	Bearing — Needle 3/4" I.D.	2	38	3528	Spring — Shift Stop	1
7	1303	Seal - Oil 3/4 Shaft	1	39	5614	Pin — Shift Stop	1
8	1213	Seal - Oil 1 1/8 Shaft	2	40	3525	Gear — Cluster	1
9	3915	Pin — Dowel	2	41	1504	Bearing — Bronze 3/4 I.D.	2
10	6941	Case L.H.	1	42	3528	Gear — Reduction Pinion	1
11	1530	Bearing - Needle 1" I.D.	1	43	3527	Gear — Reduction	1
12	1531	Bearing — Needle 5/8" I.D.	1	44	3910	Shaft — Cluster Gear	1
13	1232	Seal - Oil 1" Shaft - Brake	1	45	937014	Key #9 Woodruff	2
14	2822	Case — Differential R.H.	1	46	4204	Gear — Reverse Idler	1
15	6446	Case — Differential L.H.	1	47	1516	Bushing — Bronze 1/2 I.D.	1
16	2821	Gear — Differential — Bull	1	48	3909	Shaft	1
17	2820	Gear — Axle	2	49	4166	Gear — Brake Shaft	1
18	2819	Gear — Differential Pinion	2	50	3902	Drum — Brake	1
19	2828	Washer — Thrust	2	51	937022	Key #15 Woodruff	1
20	2826	Block — Differential	2	52	4437	Ass'y. Brake Band & Lining	1
21	2827	Shaft — Differential Pinion	1	53	908002-4	Bolt - Hex 1/4-20 x 5/8	2
22	6450	Axle — Rear — R.H.	1	54	920081-4	Lockwasher 1/4 Dia.	2
23	6451	Axle - Rear — L.H.	1	55	943460	Plug — 1/4 Pipe	1
24	933217	Roll Pin 1/4 x 1 1/2	2	56	943420	Plug 3/8 Pipe	1
25	908043-4	Bolt - Hex 3/8-16 x 3 1/2	5	57	3912	Gasket	1
26	920156-4	Washer—Internal Shakeproof 3/8 Dia.	4	58	908038-4	Bolt - Hex 3/8-16 x 2	5
27	5176	Gear — Input	1	59	915113-6	Nut — Hex 3/8-16 Nylok	6
28	1518	Bearing — Needle 5/8 I.D.	2	*60	5632	Ass'y- Shift Stick	1
29	5173	Gear — Hi & 2nd	1	*61	1239	Set Screw Dog Point 1/4-20 x 3/4	1
30	5174	Gear — Low & Reverse	1	*62	915111-6	Nut - Hex 1/4-20 Nylok	1
31	5175	Gear — Pinion — Splined	1	*63	3577	Boot	1
32	936131	Snap Ring — 1" Shaft	1	*64	1001	Knob	1

*Not included in 5058 Assembly.

Section III

5060 6-SPEED TRANSMISSION

DESCRIPTION

The 6-speed transmission is an all-gear transmission utilizing sliding gears and splined shafts for easy shifting. All shafts operate on needle or ball bearings supported by the transmission case, which consists of R.H. and L.H. cast iron case halves, dowelled for alignment and bolted securely together.

The transmission features high and low range selection. Low range provides an additional 4 to 1 reduction in each of the 3 speeds forward and also reverse.

RATIOS

Gear	High Range	Low Range
1st gear	66.8 to 1	267.2 to 1
2nd gear	42.4 to 1	169.6 to 1
3rd gear	24.6 to 1	98.4 to 1
Reverse	51.5 to 1	206.0 to 1

The 6-speed transmission also incorporates a spur gear type of limited slip differential. The limited slip feature provides increased traction under those con-

ditions in which normal differential action would transfer power to the wheel with least traction.

REMOVAL AND REPLACEMENT

Removal:

These basic instructions apply to all tractors equipped with 6-speed transmissions. Deviate from them as necessary for any particular tractor.

Remove mid-mounted or trailing attachments, or hitches which might interfere with transmission removal. Support the tractor frame ahead of the transmission just enough that the rear wheels no longer carry any weight.

Remove the R.H. foot rest, if so equipped, belt guard and belt. Disconnect the brake rod or remove the brake band from the anchor bracket. On most

models, remove the fender and seat assembly, the dust cover and instruction plate located just ahead of the shift levers.

Remove the cap screws that fasten through the bottom of the tool box into the top of the transmission. Remove four cap screws that go through the frame butt plate into the front of the transmission. Lower the front of the transmission, guide the shift levers down between the frame rails, and roll the transmission and wheel assembly free of the tractor. Drain lubricant, remove wheels, and clean the transmission as necessary before disassembling.

Installation:

NOTE: It is recommended that two pilot studs be used to facilitate transmission installation. To make the studs, cut the heads off of two 3/8"-16 x 2" hex head or carriage bolts. Grind a taper on the unthreaded end of each bolt. Screw the studs into diagonally opposite upper and lower tapped holes in the front of the transmission case.

Install input pulley, axle hubs and wheels. Move the transmission assembly into place and guide the shift levers up between the frame rails. Align the pilot studs with the corresponding holes in the frame butt plate and push the transmission firmly against

the plate. Install cap screws in the top of the transmission and the open holes at the front and tighten them until snug.

Remove the pilot studs one at a time, replacing them with cap screws. Tighten all six cap screws securely. Connect brake linkage. Install dust cover, instruction plate, fender and seat assembly, drive belt, belt guard, foot rest, etc.

Fill the transmission to proper level with S.A.E. 90 gear oil. Remove support from beneath tractor frame. Test tractor operation.

5060 6-SPEED TRANSMISSION

Disassembly:

1. Remove axle hubs and input pulley.
2. Place the transmission assembly in a vise or suitable holding fixture, as shown in Figure 1 (shown with levers, brake band, brake drum, hubs, and input pulley removed).

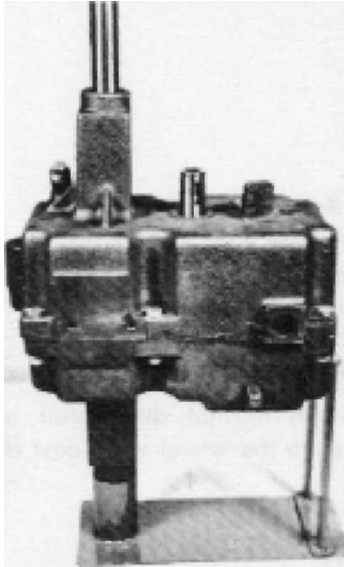

FIGURE 1

3. Place the shift lever in neutral and pull the shift lever rubber boot from the transmission boss. Loosen the shift lever retaining lock nut and set screw and remove the shift lever.
4. Remove the roll pin and remove the high-low range lever.
5. Remove the two (2) brake band retaining bolts and remove the brake band.

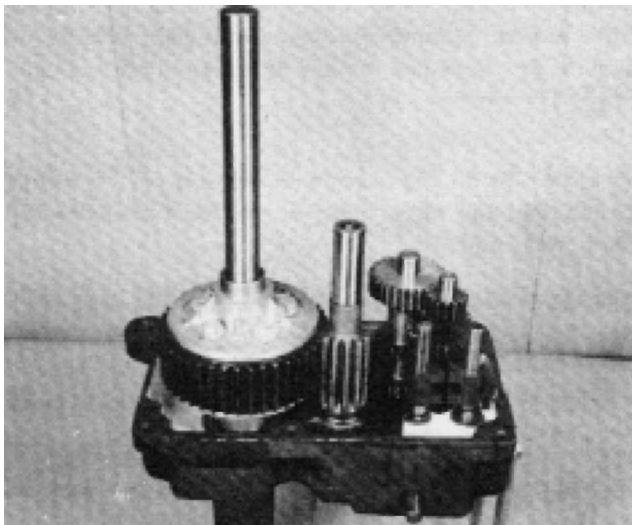

FIGURE 2

6. Remove the brake drum retaining ring and remove the brake drum using a suitable puller as required.
7. Remove paint and burrs from both axle shafts, brake shaft and the input shaft.
8. Remove the six (6) 3/8" x 16 bolts and nuts that retain the right hand and left hand cases.
9. Remove the left hand case leaving all gears intact, as shown in Figure 2.
10. Lift out the axle and differential assembly. Note: If only the differential is to be overhauled, the transmission section need not be further disassembled. Refer to Differential Overhaul Section.
11. Shift the 2nd and high shift fork assembly up into the 2nd speed position. See Figure 3.

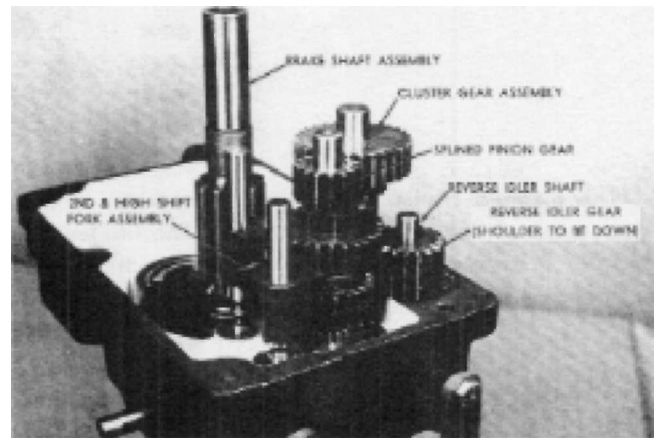

FIGURE 3

12. Remove the cluster gear assembly, the brake shaft assembly and the reverse idler gear and shaft.
13. Remove the splined pinion gear from the input shaft.
14. With a screw driver or other suitable tool remove the plug from the detent passage, as shown in Figure 4.

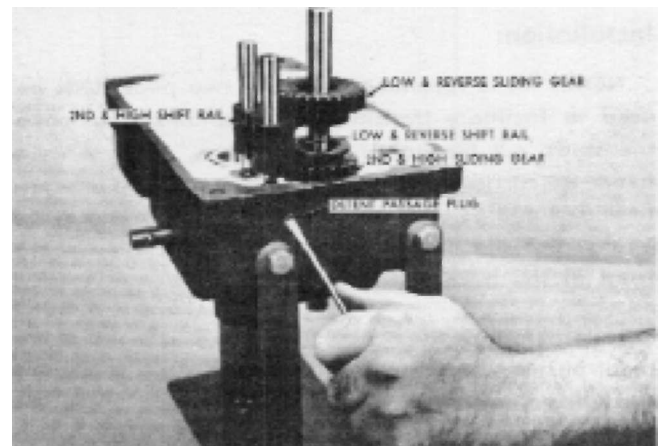

FIGURE 4

15. Place the shift forks in neutral and remove the low and reverse shift rail and fork assembly (the one nearest the end of the case) together with the low and reverse sliding gear, making sure to catch the stop ball and other detent parts as the shift rail is removed.
16. Remove the 2nd and high shift rail and fork assembly together with the 2nd and high sliding gears.
17. Remove the remaining detent parts—ball, spring and stop pin from the detent passage.
18. Remove the gear and spline assembly from the input shaft. Figure 5.

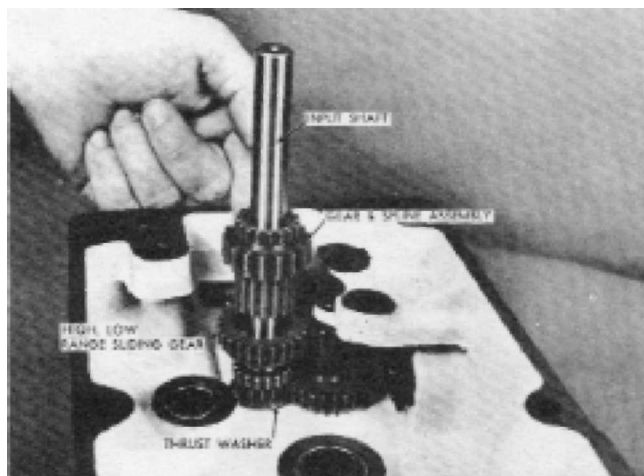

FIGURE 5

19. Remove the input shaft. Figure 5.
20. Remove the sliding gear from the high-low range shift fork assembly. Figure 6.
21. Remove the input shaft to case thrust washer.

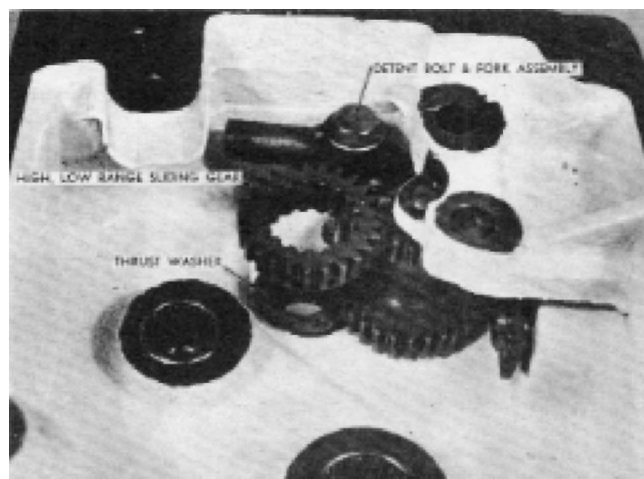

FIGURE 6

22. Remove the high-low range detent bolt and shift fork assembly. Figure 6.

23. Remove the detent bolt from the shift fork being careful to catch the stop ball and spring.
24. Remove the reduction gear shaft (Figure 7) by driving it out toward the inside of the case, and remove the reduction gear.
25. Remove the high-low range shift lever and shaft assembly from the inside of the case.

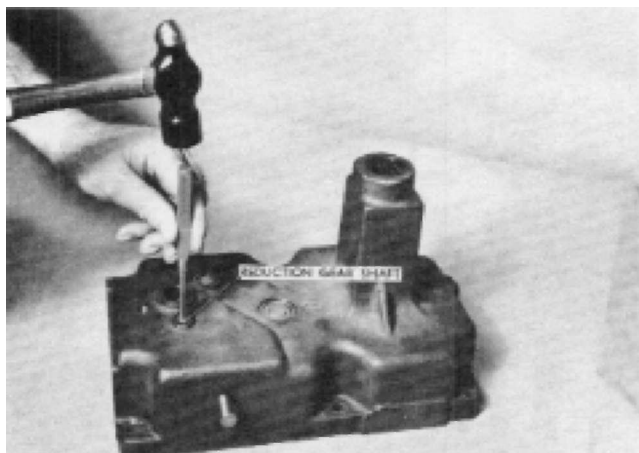

FIGURE 7

Needle Bearing Replacement:

If needle bearings are to be replaced they should be removed and installed with suitable arbors.

Cluster Gear:

The cluster gear may be disassembled as shown in Figure 8. Disassemble and assemble carefully to avoid damage to the Woodruff keys and bushings. The cluster gear bushings may be removed and installed using suitable arbors.

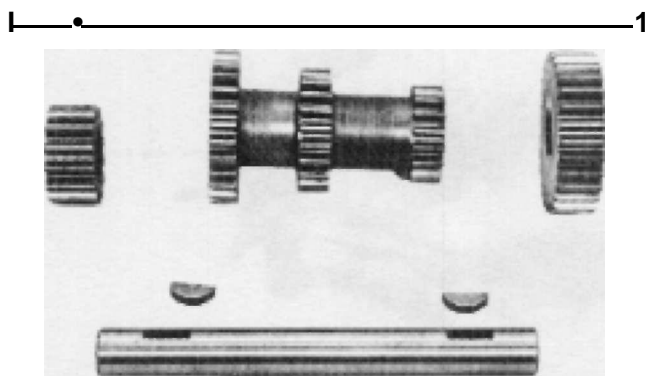

FIGURE 8

Cleaning, Inspection, Bearing and Oil Seal Replacement

Thoroughly clean all parts and inspect for damage and wear. Use suitable arbors when replacing bearings. Always renew all oil seals and gaskets.

5060 6-SPEED TRANSMISSION

Assembly:

1. Install the high-low range shift lever (Figure 9) in the hole of the right case below the shift rail supports.

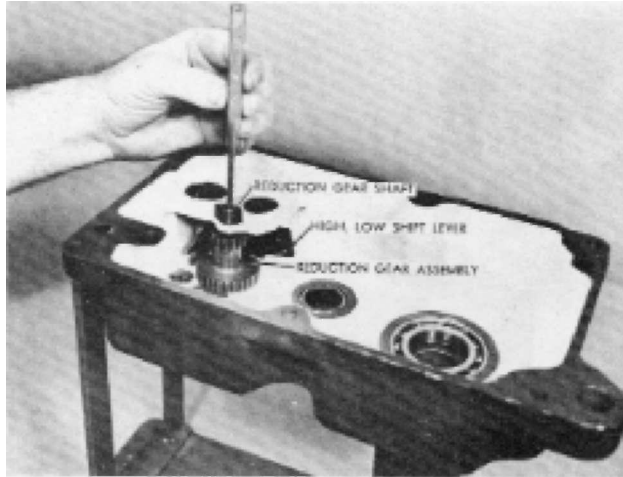

FIGURE 9

2. Position the reduction gear assembly in place with the large gear down and insert the reduction gear shaft, driving it in place from the inside of the case, as shown in Figure 9.
3. Assemble the high and low range shift fork assembly (Figure 10) by inserting the spring and ball in the detent hole. Using a 3/16" punch, press on the ball, compressing the spring. At the same time insert the detent bolt, withdrawing the punch as the bolt slides in place.

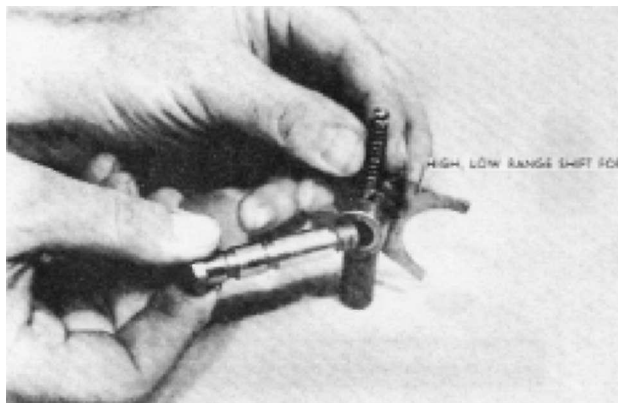

FIGURE 10

Position the detent bolt and shift fork so that the slot of the high and low range shift lever engages the shift fork (Figure 11) and thread the bolt in place until it seats securely against the shoulder. Torque the detent bolt to 12-17 ft. lbs.

Using a punch to move the high-low range shift lever, check the operation of the detent and fork assembly.

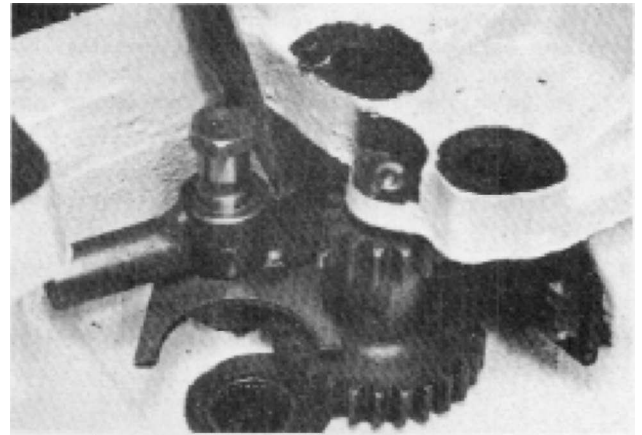

FIGURE 11

6. Lift up on the reduction gear and slide the input shaft thrust washer into position. Figure 12.
7. Install the sliding gear into the high-low range fork with the groove down. Figure 12.

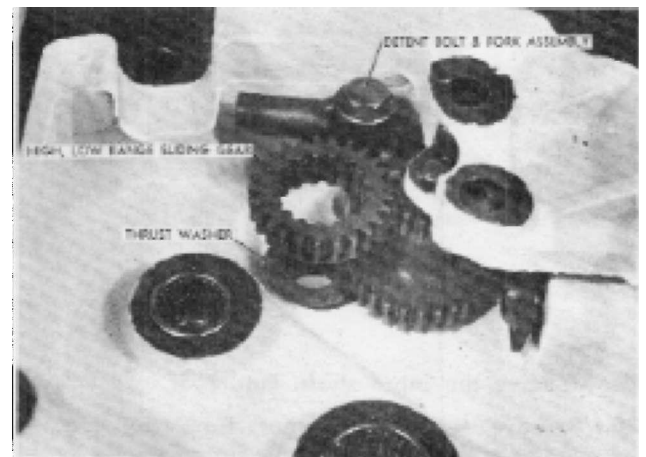

FIGURE 12

Install the input shaft, sliding it down through the high-low range sliding gear and thrust washer. Figure 13.

Install the gear and spline assembly over the input shaft, sliding the spline down through the sliding gear. Figure 13.

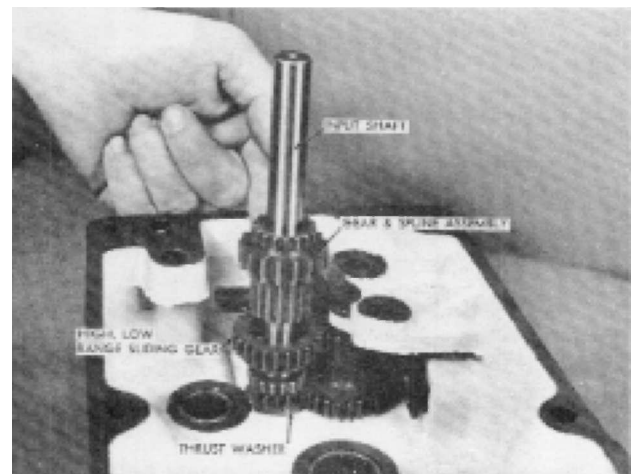

FIGURE 13

10. Install the 2nd and high shift rail and fork assembly (the one with the unequally spaced detent grooves) together with the 2nd and high sliding gear (the smaller of the two sliding gears). The sliding gear fits down over the input shaft with the shift fork groove up.
11. Install one of the stop balls, stop spring and stop pin into the detent passage.

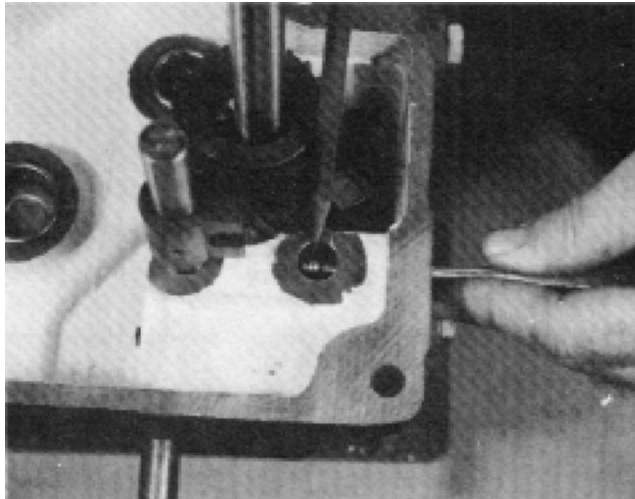

FIGURE 14

12. Install the 2nd stop ball and using a punch, push the ball in against the spring. Move the installed shift rail into the neutral position and continue to push on the punch (Figure 14) until the ball is flush with the shift rail bore. At the same time insert the low and reverse shift rail and fork assembly together with the low and reverse sliding gear, (Figure 15) removing the punch as the shift rail passes the ball. See detent drawing Figure 17. Note: The low and reverse gear fits down over the input shaft with the shift fork groove down.

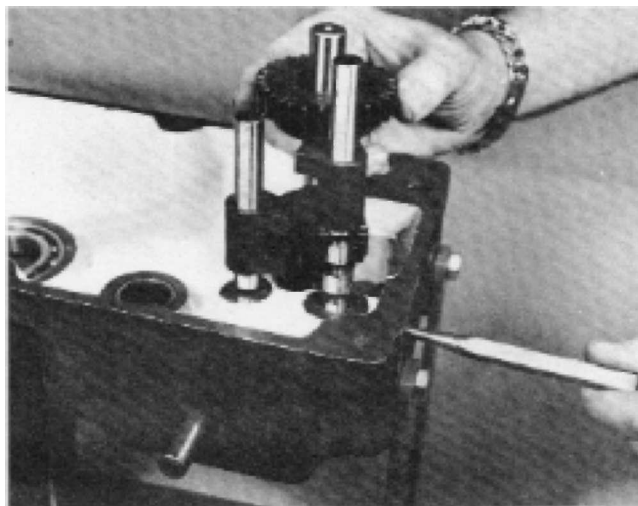

FIGURE 15

13. Install the splined pinion gear.

14. Shift the 2nd and high shift rail and fork assembly into 2nd speed position.
15. Install the reverse idler gear shaft and gear assembly making sure the shoulder of the gear goes down. Figure 16.

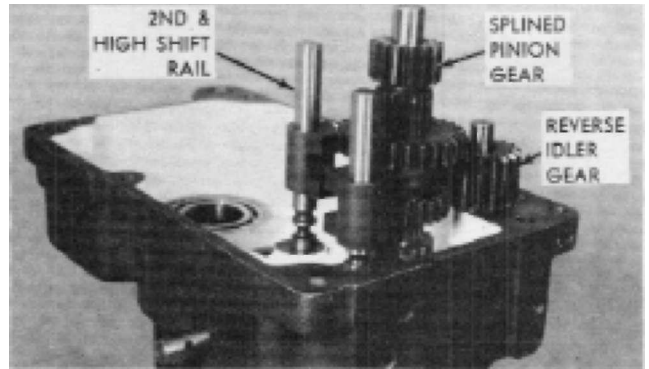

FIGURE 16

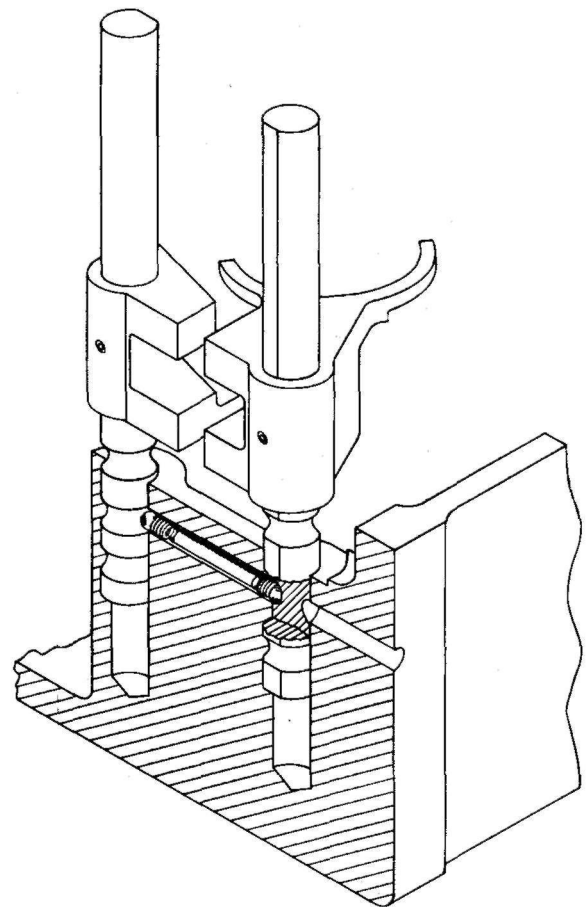

FIGURE 17

16. Install the brake shaft gear.

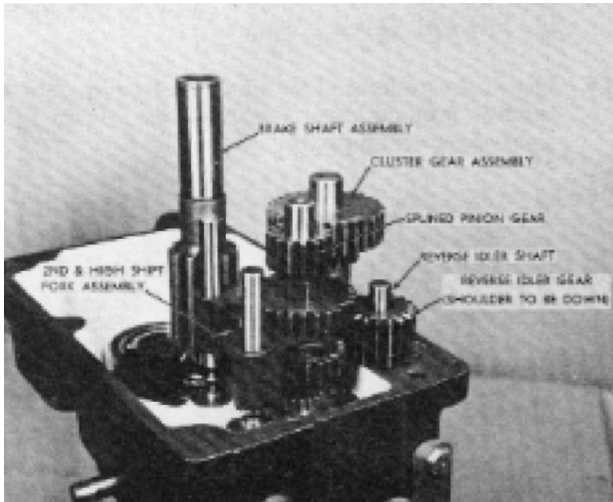

FIGURE 18

17. Install the cluster gear assembly. See Figure 18.
18. Install the differential and axle assembly with the long end cap and the retaining bolt nuts **down** into the right hand case. Figure 19.
19. Recheck for proper assembly, a free neutral and proper operation in all gears in both ranges. Place the shift forks in neutral position.
20. Install a new case gasket holding it in place with gasket sealer and install the left hand case.
21. Install the six (6) 3/8" x 16 bolts and nuts and tighten all bolts evenly to avoid distortion.
22. Install the shift lever assembly and retain with the set screw and lock nut. Install gear shift lever rubber boot.

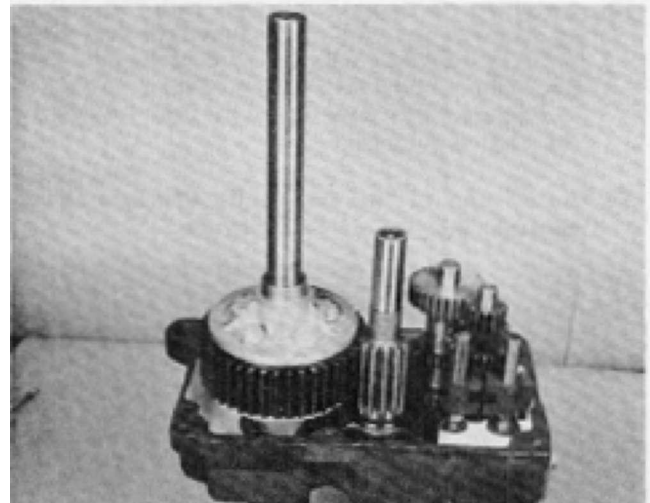

FIGURE 19

23. Install the high-low range selector lever and retain with the 3/16" roll pin.
24. Recheck for a free neutral and proper operation in all gears and ranges.
25. Install a new plug to seal the detent passage and drive it in flush with the case.
26. Install the brake shaft Woodruff key and install the brake drum. Install the brake drum retaining snap ring.
27. Install the brake band and secure with the two retaining bolts.

LIMITED SLIP DIFFERENTIAL

NOTE

See Service Bulletin number 252 for conversion of limited slip differential to 8-pinion differential.

Disassembly:

1. Remove the five (5) bolts, nuts and flat washers that retain the end caps to the differential ring gear. Note that the nuts are on the right hand side next to the right hand end cap. Note also that the right hand end cap and right hand axle are longer than the left hand end cap and left hand axle.

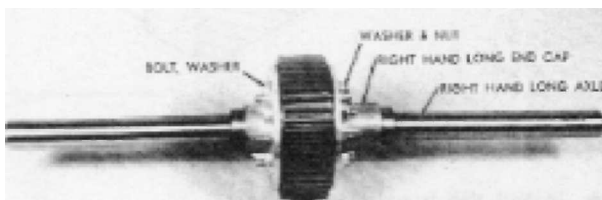

FIGURE 1

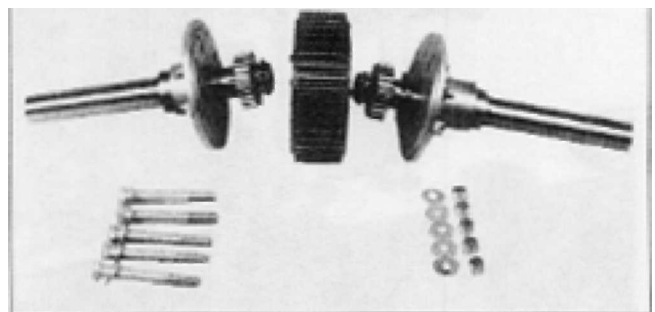

FIGURE 2

2. Remove the axles and end caps by pulling the axles in and out to free the end caps from the roll pins. **Caution**, do not pry under the edge of the end caps.
3. Remove the ten (10) differential pinions and the cylindrical spring from the differential bodies.
4. Press the two (2) differential bodies from the differential ring gear.

The right and left differential bodies are identical with roll pins located next to two (2) bolt holes. Figure 4.

The matching roll pin holes in the left hand end cap are also located **next to the bolt holes**, but in the right hand end cap they are **between bolt holes** as shown in Figure 6.

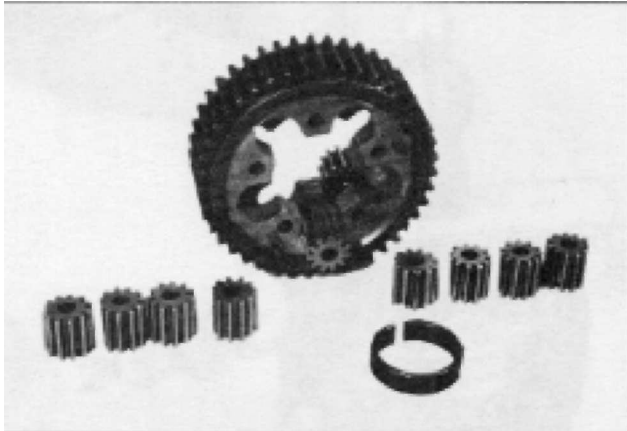

FIGURE 3

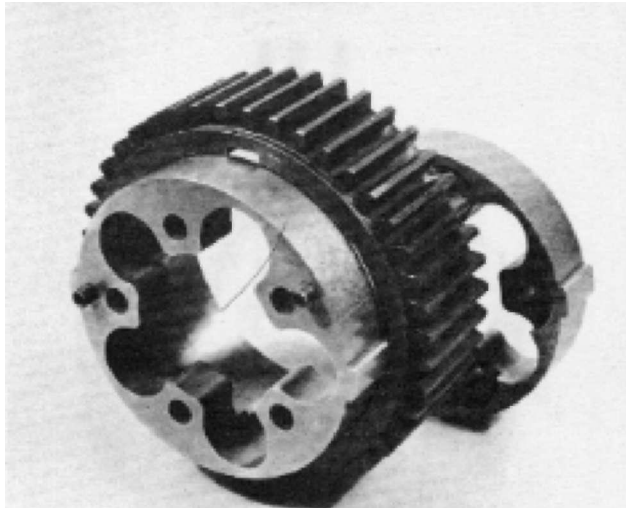

FIGURE 4

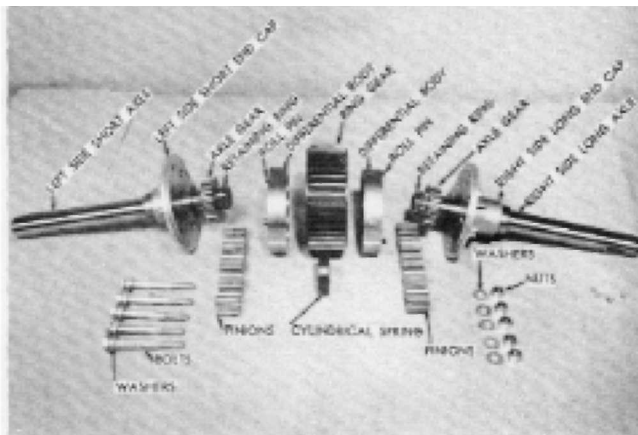

FIGURE 5

5. Remove the end caps and thrust washers from each axle.
6. The axle gears may be removed after removing the retaining snap rings.

FIGURE 5 shows the differential parts in relation to each other. Note, that the right hand end cap and axle is noticeably longer than the left hand end cap and axle.

LIMITED SLIP DIFFERENTIAL

Assembly:

1. Install the axle gears on the axles and install the retaining snap rings.
2. Place the axle gear to end cap thrust washers on the axles next to the axle gears and install the respective end caps on the axles. Note that the right hand axle and the hub of the right hand end cap is longer than the left hand axle and left hand end cap.
3. Using the left hand case as a workstand, place the right hand (long) axle and right hand end cap (long) assembly in the axle housing. Figure 6.

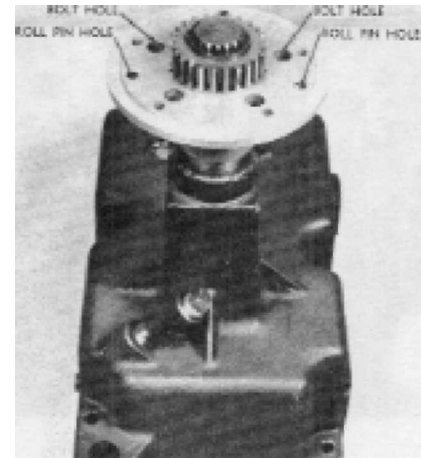

FIGURE 6

4. Align the roll pins with their respective holes and seat one of the bodies in place on the end cap. Refer to Figure 7.
5. Install the ten (10) differential pinions in their respective bores. Refer to Figure 7.
6. Hold the cylindrical spring with suitable pliers, as shown in Figure 7 and compress the spring, inserting it in the center of the pinions, seating it down against the axle gear.
7. Position the differential ring gear over the body. After careful alignment press the gear down over the body until it seats on the end cap. Figure 8.

8. With the roll pins up, align the remaining body with the pinions and using a plastic hammer or hard wood block carefully tap the body into the differential ring gear until it seats against the other body. Figure 9.

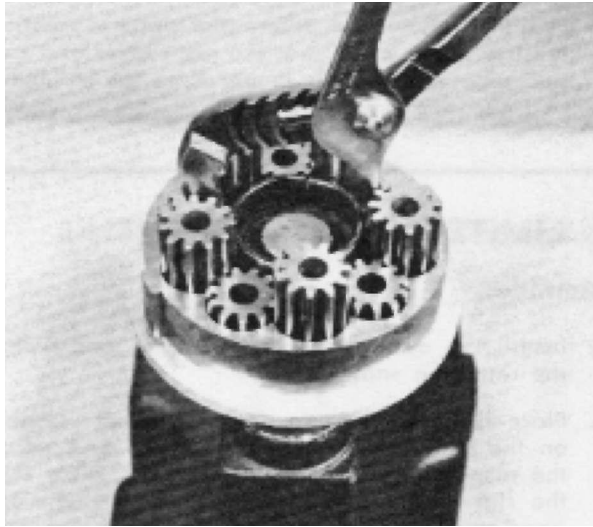

FIGURE 7

10. Install the five (5) remaining bolts and nuts, placing a flat washer next to each end cap, placing the nuts on the side of the long end cap. Figure 10.

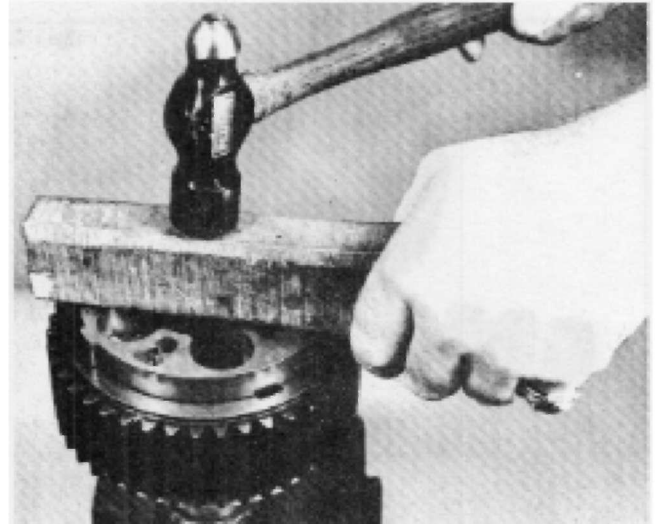

FIGURE 9

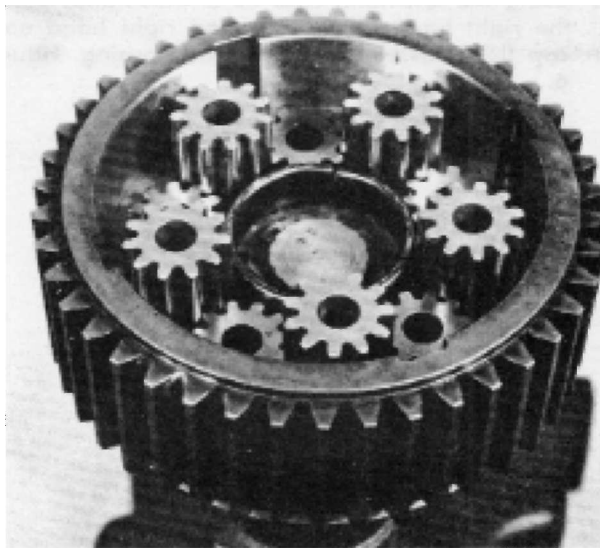

FIGURE 8

9. Align the roll pins and insert the left hand axle and end cap assembly, seating it in the differential ring gear.

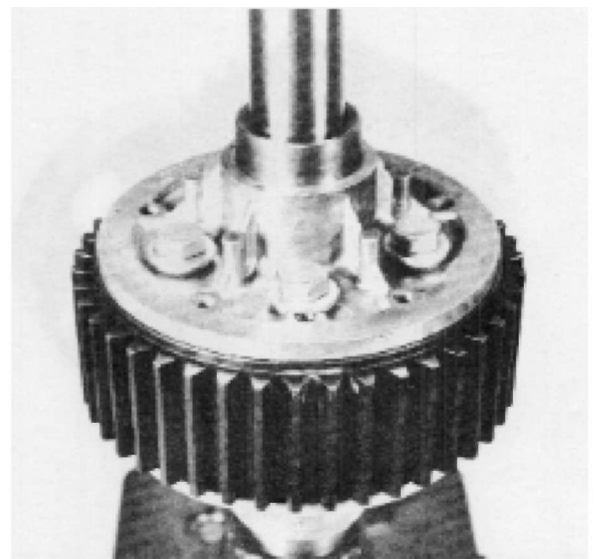
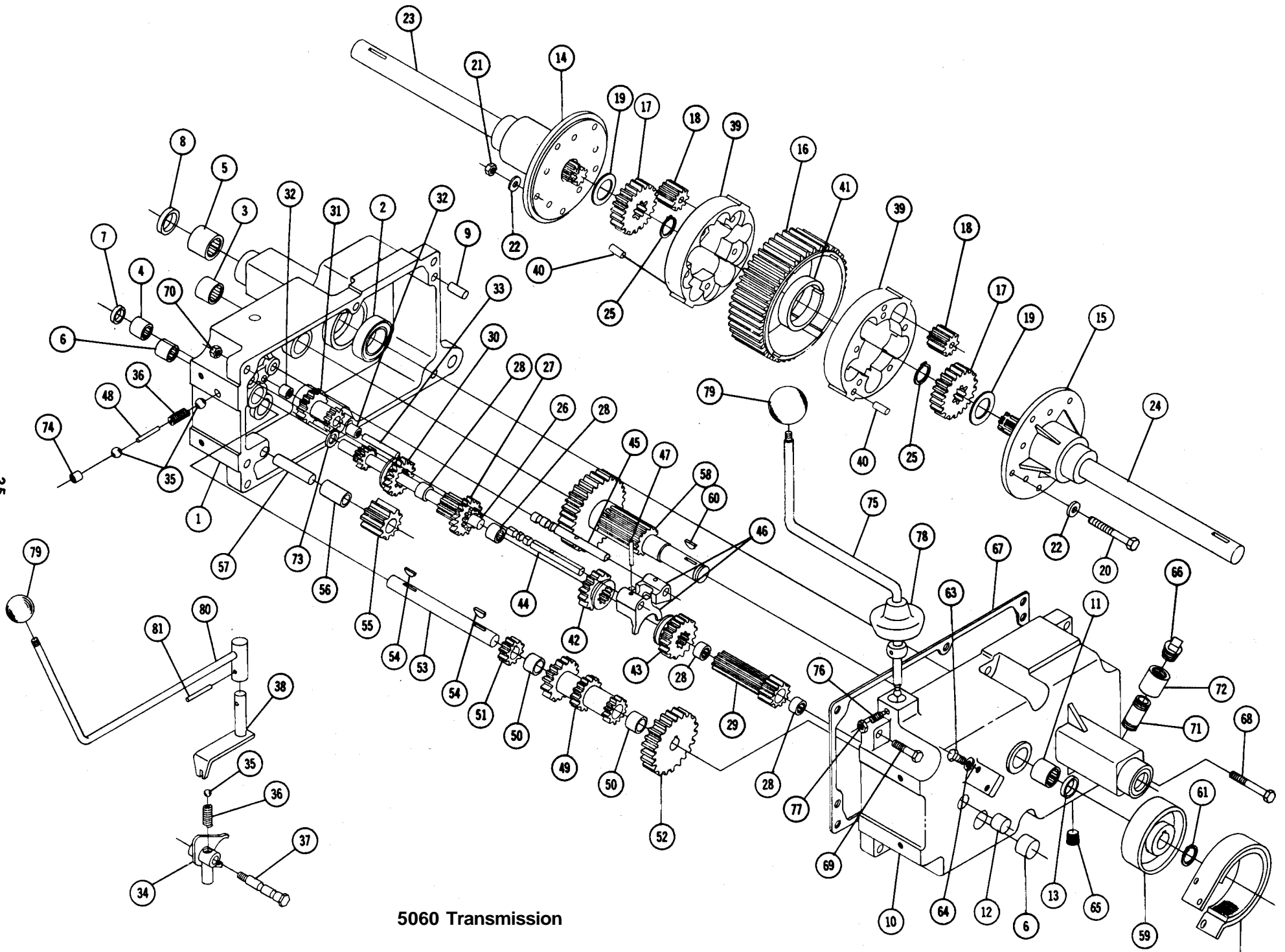

FIGURE 10

11. Torque bolts evenly to avoid distortion of the end caps. Torque to 20 ft. lbs.



5060 Transmission

5060 TRANSMISSION PARTS LIST

When ordering parts always list Part No. and name of part.

(Specifications subject to change without notice.)

Item No.	Part No.	Description	No. Req'd.	Item No.	Part No.	Description	No. Req'd.
1	7066	Case — R.H.	1	42	5173	Gear — Hi and 2nd	1
2	1533	Bearing Ball 1 1/2 I.D.	2	43	5174	Gear — Low and Reverse	1
3	1532	Bearing - Needle 1" I.D.	1	44	5615	Rail — Front Shift	1
4	1542	Bearing — Needle 5/8" I.D.	1	45	5616	Rail — Rear Shift	1
5	1526	Bearing — Needle 1 1/8" I.D.	2	46	3503	Fork - Shift	
6	1529	Bearing — Needle 3/4 I.D.	2	47	933156	Roll Pin 1/8 x 1	
7	1461	Seal - Oil 5/8 Shaft	1	48	5614	Pin — Shift Stop	1
8	1213	Seal Oil 1 1/8 Shaft	2	49	3525	Gear — Cluster	1
9	3915	Pin — Dowel	2	50	1504	Bearing — Bronze 3/4 I.D.	
10	6941	Case - L.H.	1	51	3528	Gear — Reduction Pinion	1
11	1530	Bearing — Needle 1" I.D.	1	52	3527	Gear — Reduction	1
12	1531	Bearing — Needle 5/8 I.D.	1	53	3910	Shaft — Cluster Gear	1
13	1232	Seal - Oil 1" Shaft - Brake	1	54	937014	Key #9 Woodruff	
14	7194	End Cap R.H.	1	55	4204	Gear — Reverse Idler	1
15	7195	End Cap L.H.	1	56	1516	Bushing — Bronze 1/2" I.D.	1
16	7196	Gear — Differential Ring	1	57	3909	Shaft	1
17	7197	Gear — Axle	2	58	4166	Gear — Brake Shaft	1
18	7198	Gear — Differential Pinion	10	59	3902	Drum — Brake	1
19	7199	Washer — Thrust	2	60	937022	Key #15 Woodruff	1
20	908138-4	Bolt 3/8-16 x 3 1/4	5	61	936131	Snapping 1" Shaft	1
21	915663-4	Nut — Elastic Stop 3/8-16	5	62	7376	Ass'y. Brake Band & Lining	1
22	920009-4	Washer - Flat 3/8 SAE	10	63	908002-4	Bolt - Hex 1/4-20 x 5/8	
23	7202	Axle — Rear R.H.	1	64	920081-4	Lockwasher 1/4" Dia.	
24	7203	Axle - Rear L.H.		65	943460	Plug 1/4 Pipe	1
25	7169	Snap Ring — Heavy Duty — External		66	943420	Plug 3/8 Pipe	
26	7201	Shaft — Input	1	67	3912	Gasket	
27	7204	Gear & Spline	1	68	908043-4	Bolt Hex 3/8-16 - 3 1/2	1
28	1518	Bearing — Needle 5/8 I.D.		69	908038-4	Bolt Hex 3/8-16 x 2	
29	5175	Pinion Gear & Spline		70	915113-6	Nut 3/8-16 Nylok	
30	7205	Gear — Sliding	1	71	943322	Nipple 3/8 Pipe x 1	
31	7206	Gear — Reduction	1	72	943003	Coupling 3/8 Pipe	
32	7207	Bearing — Needle 3/8 I.D.		73	7418	Thrust Washer	1
33	7208	Shaft — Reduction Gear	1	74	1243	Plug	
34	7209	Ass'y- Shift Fork		75	5632	Ass'y. Shift Stick	
35	3517	Ball — Stop		76	1239	Set Screw 1/4-20 x 3/4 Dog Point	
36	3518	Spring — Stop		77	915111-4	Nut Hex 1/4-20	1
37	7213	Bolt — Detent	1	78	3577	Boot	1
38	7214	lever — Shift	1	79	1001	Knob	
39	7200	Body	2	80	7217	Ass'y. Handle — Shift	1
40	933209	Roll Pin	4	81	933184	Roll Pin 3/16 x 3/4	1
41	7235	Spring — Cylindrical	1				

*Not Included in No. 5060 Assembly.

Section IV

4-SPEED UNIDRIYE

DESCRIPTION

The 4-speed unidrive transmission is an all-gear transmission utilizing sliding gears and splined shafts for easy shifting. All shafts operate on needle or ball bearings supported by the transmission case. The transmission case consists of R.H. and L.H. cast iron case halves which are dowelled for alignment and bolted securely together.

RATIOS

1st gear.66.8 to 1
2nd gear.42.4 to 1
3rd gear.24.6 to 1
Reverse.51.5 to 1

REMOVAL AND REPLACEMENT

Removal:

These basic instructions apply to all tractors equipped with Unidrive transmissions. Deviate from them as necessary for any particular tractor.

Remove mid-mounted or trailing attachments, or hitches which might interfere with transmission removal. Support the tractor frame ahead of the transmission just enough that the rear wheels no longer carry any weight.

Remove the R.H. foot rest, if so equipped, belt guard, and belt. Disconnect the brake rod or remove the brake band from the anchor bracket. On most models, remove the fender and seat assembly. If necessary to gain clearance, remove the dust cover and instruction plate located just ahead of the shift lever.

Remove two cap screws that fasten through the bottom of the tool box into the top of the transmission. Remove four cap screws that go through the frame butt plate into the front of the transmission. Lower the front of the transmission, guide the shift lever down between the frame rails, and roll the transmission and wheel assembly free of the tractor.

Drain lubricant, remove wheels, and clean transmission as necessary before disassembling.

Installation:

NOTE: It is recommended that two pilot studs be used to facilitate transmission installation. To make the studs, cut the heads off of two 3/8"-16 x 2" hex head or carriage bolts. Grind a taper on the unthreaded end of each bolt. Screw one stud into one of the upper holes in the front of the transmission case. Put the other one in the diagonally opposite lower hole.

Install input pulley, axle hubs and wheels. Move the transmission assembly into place and guide the shift lever up between the frame rails. Align the pilot studs with the corresponding holes in the frame butt plate and push the transmission firmly in place against the plate. Install cap screws in the top of the transmission and the open holes in the front, and tighten them until snug. Remove the pilot studs one at a time, replacing them with cap screws. Tighten all six cap screws securely.

Connect brake linkage. Install dust cover, instruction plate, fender and seat assembly, drive belt, belt guard, foot rest, etc.

Fill the transmission to proper level with S.A.E. 140 A.P.I. Service GL-5 gear oil. Remove support from beneath tractor frame. Test tractor operation.

4-SPEED UNIDRIYE TRANSMISSION

Disassembly:

These instructions apply to all unidrive models unless indicated. A section applying only to specific models will be so identified.

1. Remove axle hubs and input pulley.
2. Place the transmission assembly in a vise or suitable holding fixture, as shown in Figure 1.

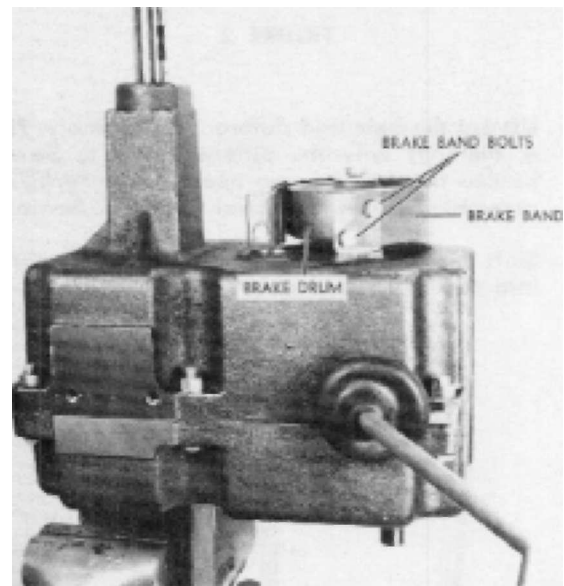

FIGURE 1

3. Place the gear shift lever in neutral and pull the gear shift lever rubber boot away from the transmission boss. Loosen the gear shift lever retaining lock nut and set screw and remove the gear shift lever.
4. Remove the two (2) brake band retaining bolts and remove the brake band.
5. Remove the brake drum retaining bolt and washer, and remove the brake drum. (See Figure 2).
6. Remove the six (6) 3/8" x 16 bolts and nuts that retain the right hand and left hand cases.
7. Remove paint and burrs from both axle shafts, brake shaft, and the input shaft.
8. Remove the left hand case, as shown in Figure 3.

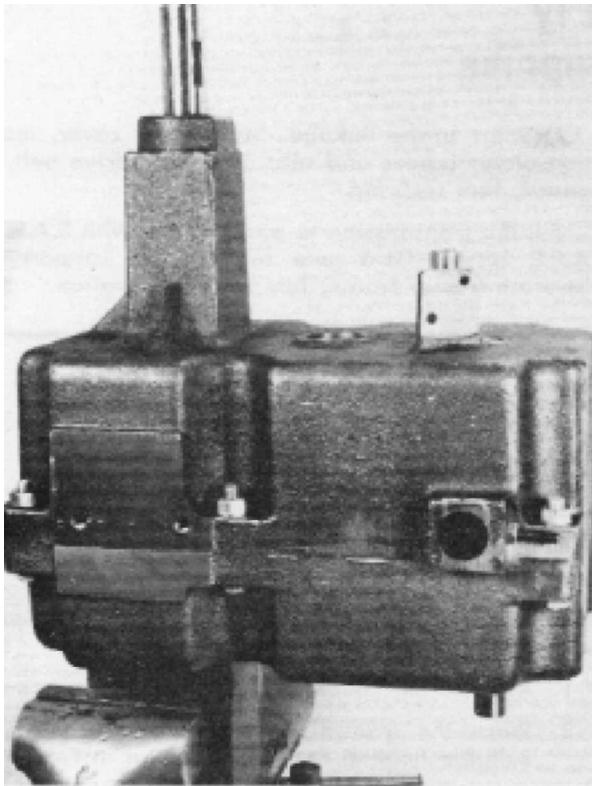

FIGURE 3

9. Lift out the axle and differential assembly. Figure 4. Note: If only the differential is to be overhauled the transmission need not be further disassembled. See Differential Overhaul Section.
10. Shift the 2nd and high shift fork assembly up into the 2nd speed position. See Figure 5.

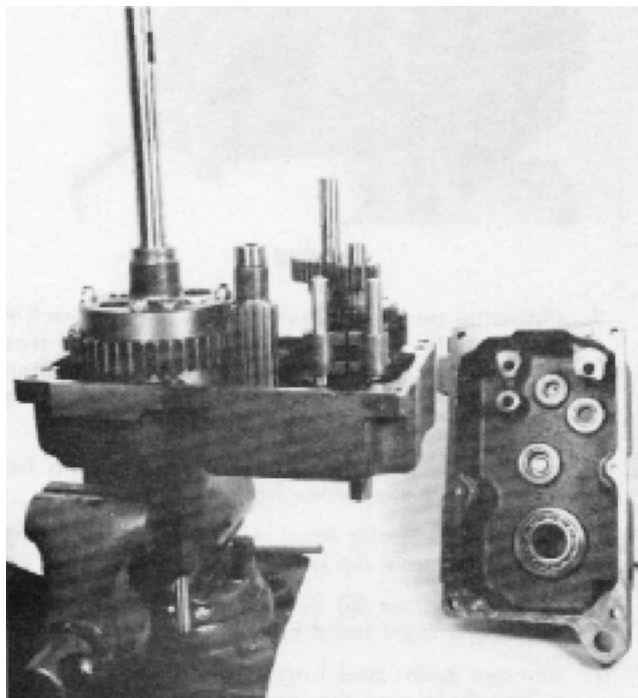

FIGURE 4

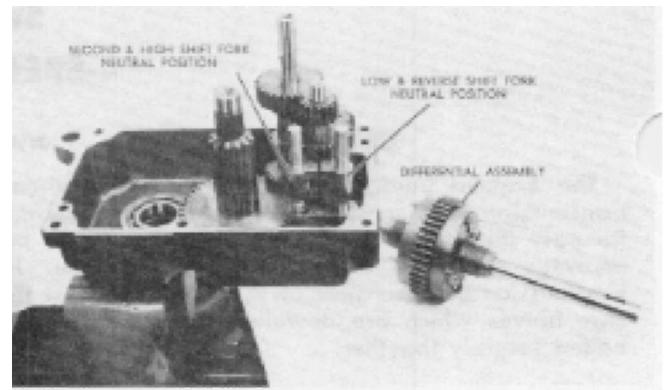

FIGURE 5

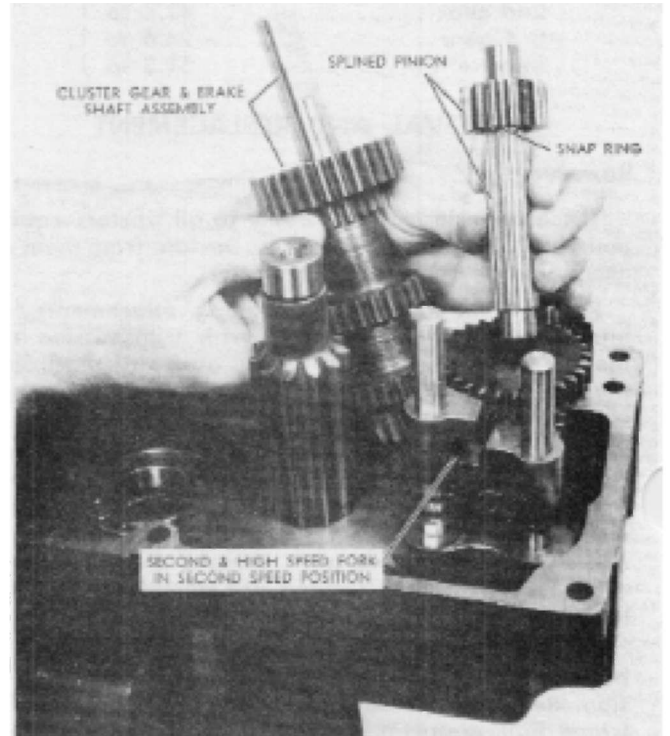

FIGURE 6

11. Remove the splined pinion shaft and gear. At the same time the cluster gear and brake shaft assembly may be removed. See Figure 5.
12. Remove the large pinion and reduction gear assembly, (and the thrust washer if used) and the reverse idler gear. See Figure 6.

NOTE: Prior to 1973 models the pinion reduction gear and thrust washer was welded together and was serviced as one part.

Starting with the 1973 models the pinion, reduction gear and thrust washer are serviced separately. The thrust washer goes on the stub shaft next to the big gear.

The pinion may be pressed in and out of the gear with a suitable arbor press.

13. Remove the 2nd and high sliding gear and the low and reverse sliding gear, as shown in Figure 7.

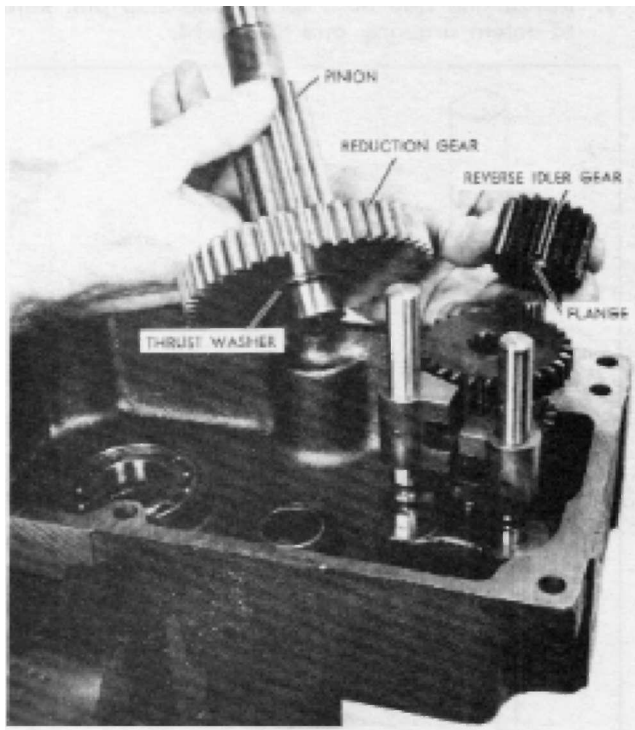

FIGURE 6

14. Place the shift forks in neutral and remove first the low and reverse shift rail and fork assembly, then the 2nd and high shift rail and fork assembly, being careful not to lose the two stop balls, spring and stop pin as they are released. Figure 8.
15. Remove the reverse idler shaft and the input shaft and gear. See Figure 9. Note: The reverse idler shaft may sometimes stick in the left hand case.

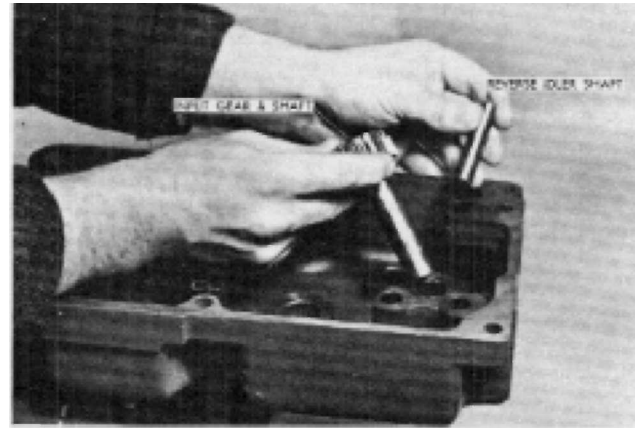

FIGURE 9

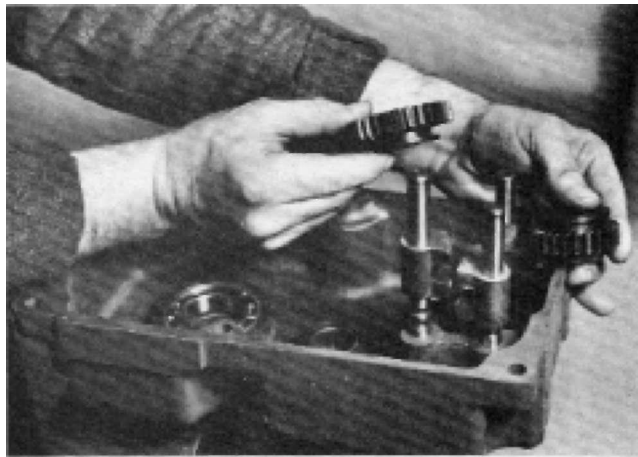

FIGURE 7

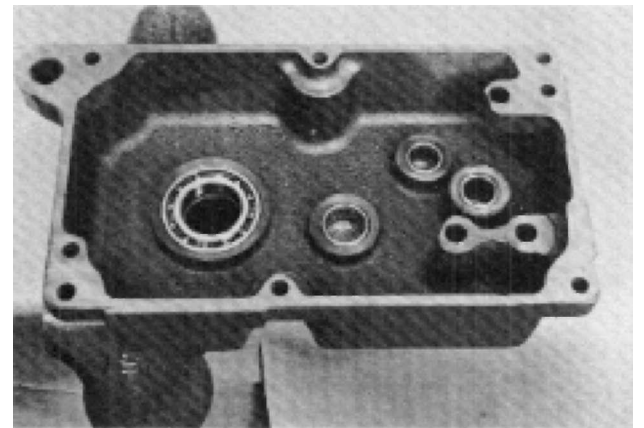

FIGURE 10

16. If it is desired to replace the case bearings they may easily be removed and installed with suitable arbors. When replacing bearings they should be pressed in so that they are flush with the inside of the case, as shown in Figure 10.



FIGURE 8

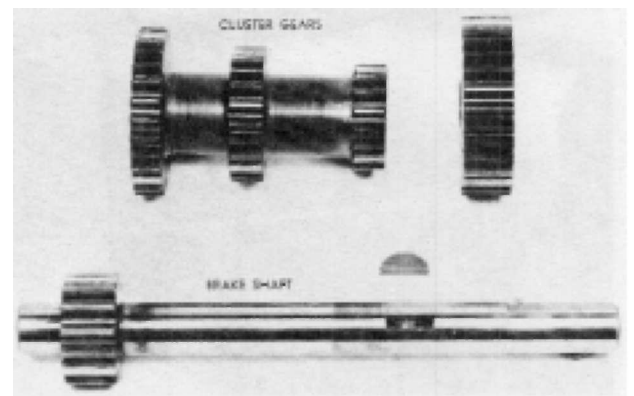

FIGURE 11

17. The cluster gear and brake shaft assembly may be disassembled, as shown in Figure 11. Disassemble and assemble carefully to avoid damage to the woodruff key and bushings. The cluster gear bushings may be removed and installed using suitable arbors.
18. With a screwdriver or other suitable tool remove the plug from the end of the detent passage.

Cleaning, Inspection, Bearing and Oil Seal Replacement

Thoroughly clean all parts and inspect for damage and wear. Use suitable arbors when replacing bearings. Always renew all oil seals and gaskets.

Assembly:

Place the right hand case in a vise or other suitable fixture for assembly, as shown in Figure 12.

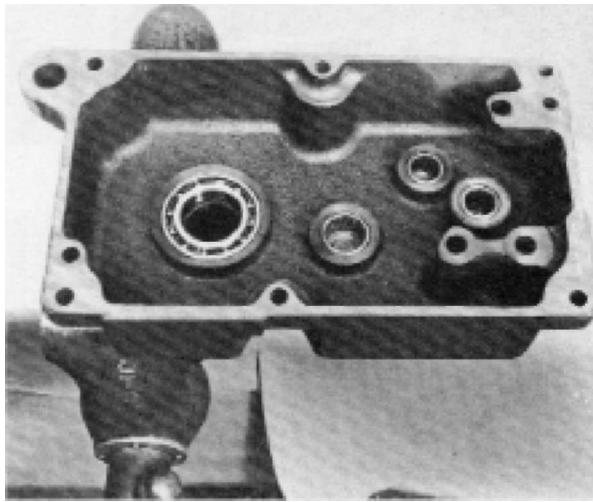

FIGURE 12

1. Install the input shaft and gear, and reverse idler shaft, as shown in Figure 13.
2. Install the 2nd and high shift rail and fork assembly (the one with the unequally spaced detent grooves.) See Figure 15.

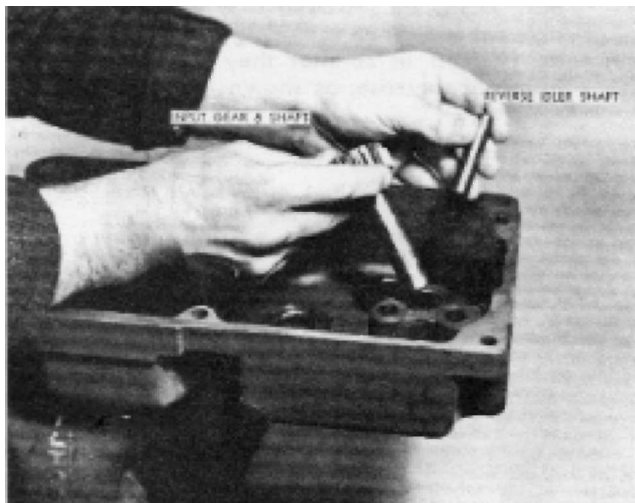

FIGURE 13

3. Install one stop ball, spring and stop pin. Refer to detent drawing and Figure 14.

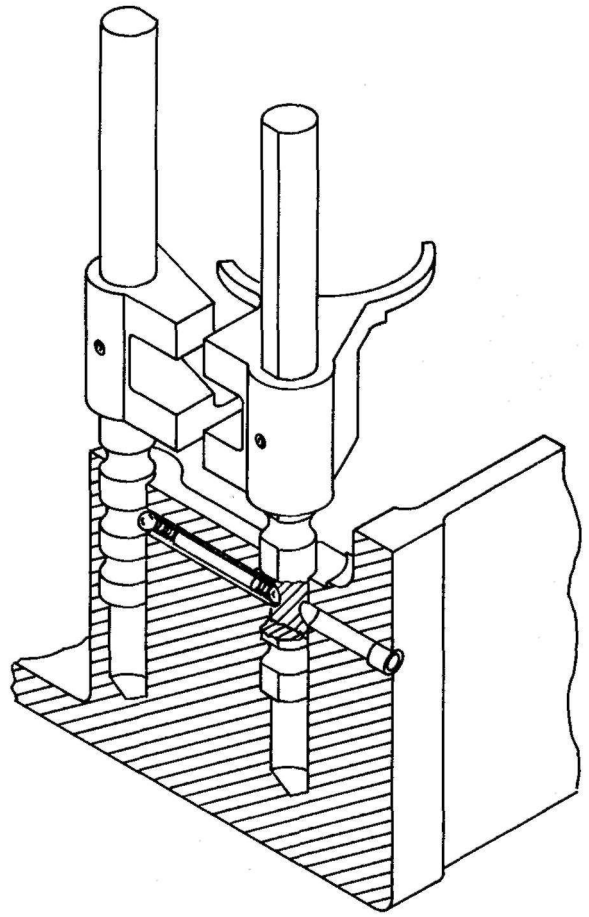

FIGURE 14

4. Install the 2nd stop ball and using a punch push the ball in against the spring. Move the 2nd & high shift rail into the neutral position and continue to push on the punch until the ball is flush with the shift rail bore. At the same time insert the low and reverse shift rail and fork assembly, removing the punch, as the shift rail passes the ball. **See Detent Drawing.** Figure 14 and 15.

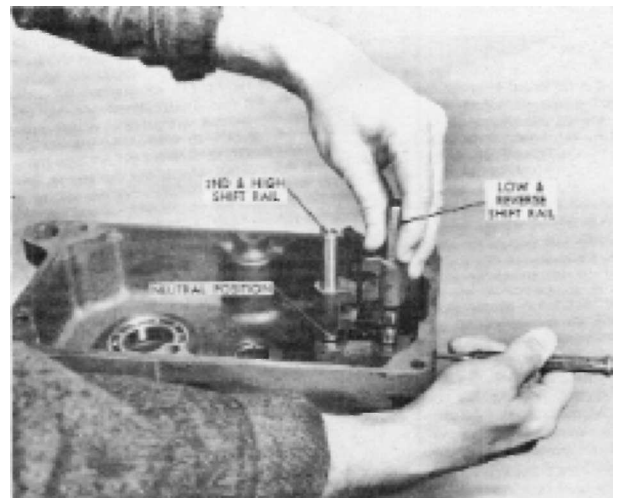

FIGURE 15

- Shift the 2nd and high shift fork into the 2nd speed position and install the 2nd and high sliding gear, and the low and reverse sliding gear in position on their respective forks, Figure 16. Note that the shift fork grooves of the sliding gears face each other, and that the smaller of the two gears is the 2nd and high gears which goes on the bottom.

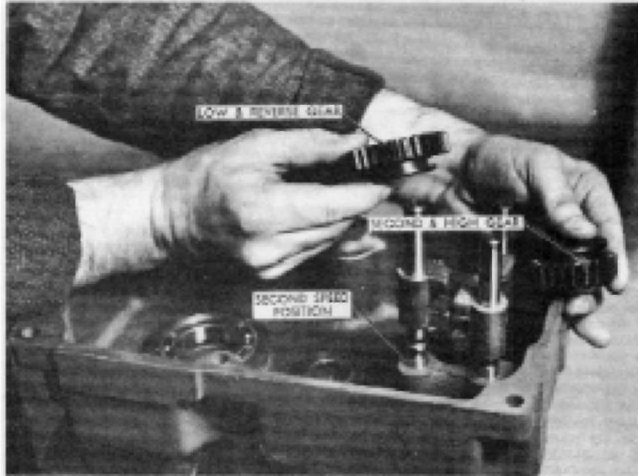

FIGURE 16

- Install the reverse idler and the large pinion and reduction gear assembly (and the thrust washer if used), as shown in Figure 17, making sure that the flanged end on the reverse idler goes down.
- Install the splined shaft and gear through the two splined sliding gears seating the bottom end of the shaft into the input gear bearing. See Figure 18. Install the cluster gear and brake shaft assembly carefully seating it in its bearing and meshing it with its related gears.
- Install the differential and axle assembly, as shown in Figure 19, making sure that four (4) nuts are up toward the L.H. case.

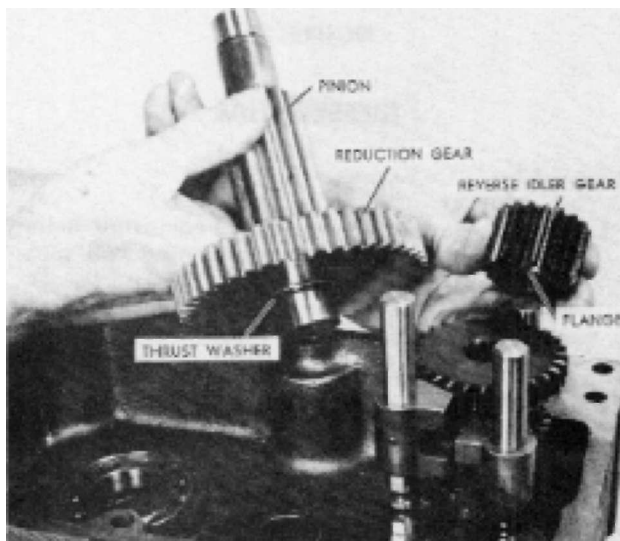

FIGURE 17

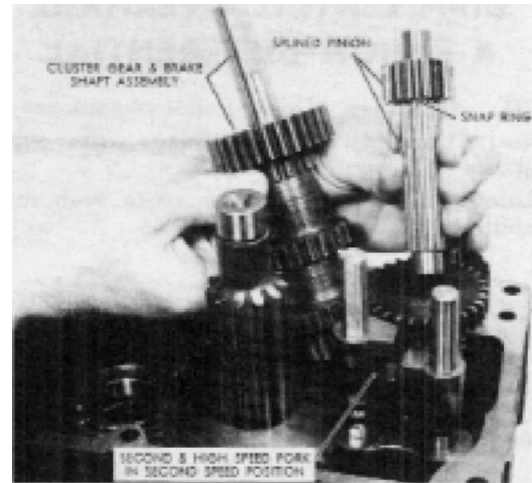

FIGURE 18

- Place shift forks in neutral position and check for a free neutral and proper operation in all gears.
- Install a new case gasket holding it in place with gasket sealer and install the left hand case.
- Install the six (6) 3/8" x 16 bolts and nuts and tighten all bolts evenly to avoid distortion.
- Install the shift lever assembly and retain with the set screw and lock nut. Install gear shift lever rubber boot.

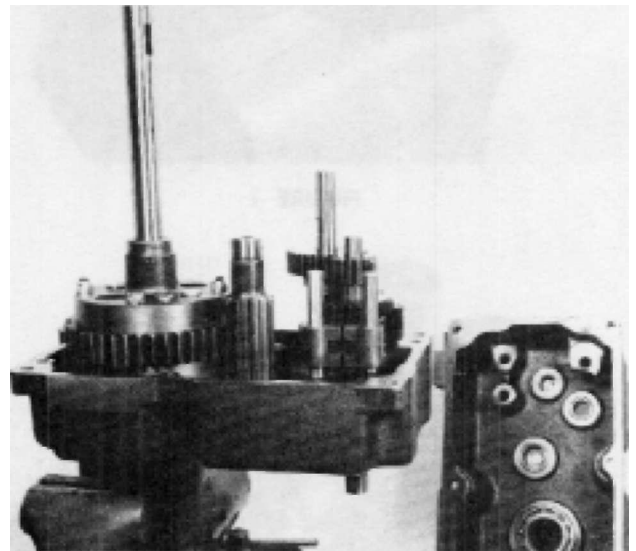

FIGURE 19

- Check again for a free neutral and operation in all gears.
- Install the brake drum and secure with the bolt and washer.
- Install the brake band and secure with the two retaining bolts.
- Install a new plug to seal the detent passage and drive it in flush with the case.

DIFFERENTIAL OVERHAUL

4 PINION DIFFERENTIAL

NOTE: Two types of differential pinions are used:

1. Early type use hollow pinions with separate shafts. See Figure 1 and 2.
2. Late type pinions are one piece with integral shafts. See Figure 1A and 2A.

1. Early type axles incorporate roll pin holes and use roll pins to secure the axle gears. See Figure 1 and 2.
2. Late type axles incorporate snap ring grooves and use snap rings to secure the axle gears. See Figure 1A and 2A.

Disassembly:

1. Remove the four (4) retaining bolts and nuts.
2. Lift off the differential side case together with the axle shaft and gear.

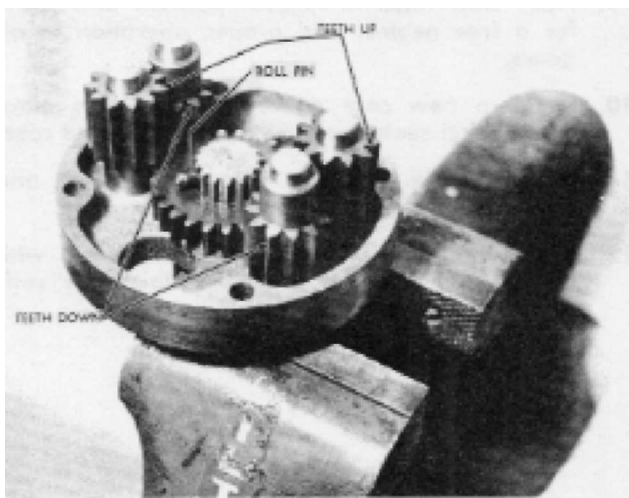

FIGURE 1

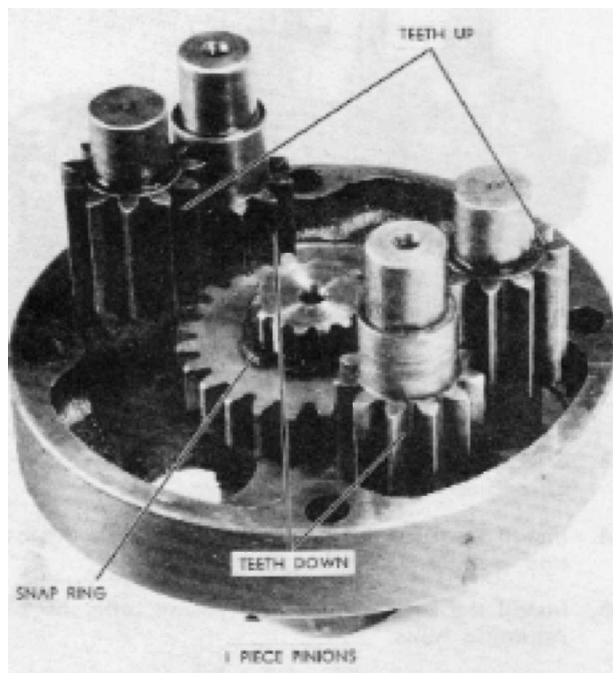

FIGURE 1A

3. Remove the axle shaft and gear from the case.
4. Remove the differential bull gear.
5. Note position of the four (4) pinions. Adjacent pinions are installed in opposite directions, which make the position of the diagonally opposite pinions the same. See Figure 1 and 1A.
6. Remove the pinions (and shafts on the early type), and remove the remaining axle shaft and gear from the case.
7. The axle shaft gears may easily be removed by driving out the roll pins or removing the snap rings as required.

Figure 2 & 2A are exploded views of the complete 4 pinion differential assembly.

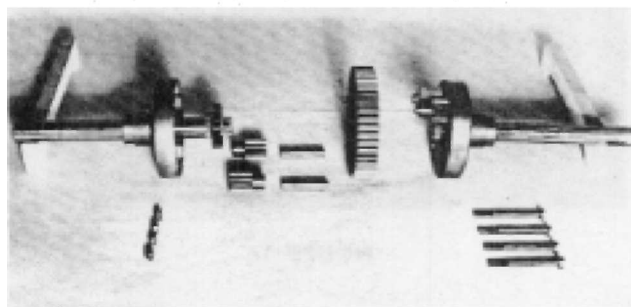

FIGURE 2

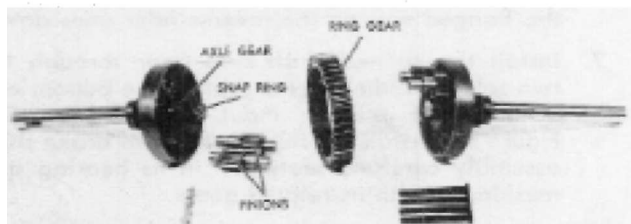

FIGURE 2A

DIFFERENTIAL

Assembly:

1. If the axle gears were removed install them on the axles and install the retaining roll pins or snap rings as required.
Note: Install the snap rings with the sharp side of the snap ring toward the inner end of the axles.
2. Install one of the axle and gear assemblies in the differential case and on the early type install the four (4) pinion shafts.
3. Install two (2) pinions with their teeth up diagonally opposite each other, and install the other two (2) pinions with their teeth down diagonally opposite each other. See Figure 1 and 1A.

4. Install the differential bull gear.
5. Install the remaining axle and gear assembly in the remaining differential case.
6. Position the axle and gear, and differential case

over the pinion shafts, mesh the gears and seat the case against the ring gear.

7. Center the bull gear and install the four (4) retaining bolts, and nuts. Tighten securely and evenly to avoid distortion.

4-SPEED TRANSMISSION

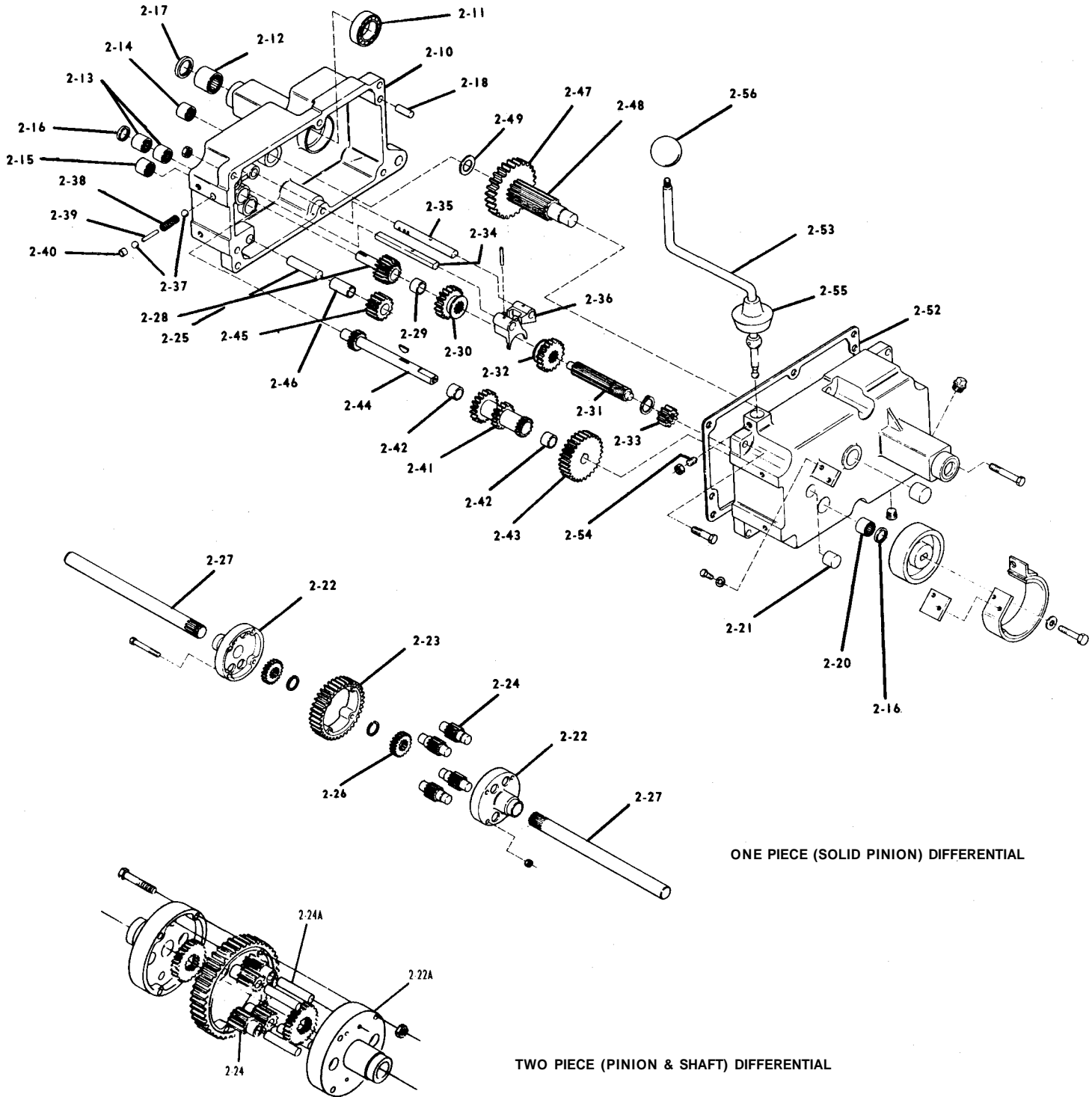

4-SPEED TRANSMISSION

ITEM NO.	DESCRIPTION
2-10	R. H. Case L. H. Case
2-11	Ball Bearing, 1 1/2" I.D.
2-12	Needle Bearing, 1" 1. D.
2-13	Needle Bearing, 3/4" 1. D.
2-14	Needle Bearing, 1" 1. D.
2-15	Needle Bearing, 3/4" 1. D.
2-16	Oil Seal, 3/4 Shaft
2-17	Oil Seal, 1" Shaft
2-18	Dowel Pin
2-20	Needle Bearing, 3/4" 1. D.
2-21	Needle Bearing, 5/8" 1. D.
2-22	Differential Case
2-22A	Differential Case
2-23	Differential Bull Gear
2-24	Differential Pinion Gear
2-24A	Differential Pinion Gear
2-25	Shaft
2-26	Axle Gear
2-27	Axle Axle Snap Ring
2-28	Input Gear
2-29	Needle Bearing, 5/8" 1. D.
2-30	Hi and 2nd Gear
2-31	Spline Shaft Snap Ring, 3/4"
2-32	Low and Reverse Gear
2-33	Splined Pinion Gear
2-34	Front Shift Rail
2-35	Rear Shift Rail
2-36	Shift Fork
2-37	Shift Stop Ball
2-38	Shift Stop Spring
2-39	Shift Stop Pin
2-40	Cup Plug
2-41	Cluster Gear
2-42	Bronze Bearing, 3/4 1. D.
2-43	Reduction Gear
2-44	Cluster Gear/Brake Shaft
2-45	Reverse Idler Gear
2-46	Bronze Bushing, 1/2" 1. D.
2-47	Gear, 44 Teeth
2-48	Gear, 11 Teeth
2-49	Thrust Washer, 1" 1. D.
2-52	Case Gasket
2-53	Shift Stick Assembly
2-54	Set Screw, 1/4-20 x 3/4
2-55	Boot
2-56	Knob

Section V

8-SPEED TRANSMISSION

DESCRIPTION

The 8-speed transmission is an all-gear transmission utilizing sliding gears and splined shafts for easy shifting. All shafts operate on needle or ball bearings supported by the transmission case, which consists of R.H. and L.H. cast iron case halves, dowelled for alignment and bolted securely together.

The transmission features high and low range selection. Low range provides an additional 4 to 1 reduction in each of the 3 speeds forward and also reverse.

RATIOS

Gear	High Range	Low Range
1st gear	66.8 to 1	267.2 to 1
2nd gear	42.4 to 1	169.6 to 1
3rd gear	24.6 to 1	98.4 to 1
Reverse	51.5 to 1	206.0 to 1

REMOVAL AND REPLACEMENT

Removal:

These basic instructions apply to all tractors equipped with 8-speed transmissions. Deviate from them as necessary for any particular tractor.

Remove mid-mounted or trailing attachments, or hitches which might interfere with transmission removal. Support the tractor frame ahead of the transmission just enough that the rear wheels no longer carry any weight.

Remove the R.H. foot rest, belt guard and belt. Disconnect the brake rod or remove the brake band from the anchor bracket. Remove the fender and seat assembly, the dust cover and instruction plate located just ahead of the shift levers.

Remove the cap screws that fasten through the bottom of the tool box into the top of the transmission. Remove four cap screws that go through the frame butt plate into the front of the transmission. Lower the front of the transmission, guide the shift levers down between the frame rails, and roll the transmission and wheel assembly free of the tractor. Drain lubricant, remove wheels, and clean the transmission as necessary before disassembling.

Installation:

NOTE: It is recommended that two pilot studs be used to facilitate transmission installation. To make the studs, cut the heads off of two 3/8"-16 x 2" hex head or carriage bolts. Grind a taper on the unthreaded end of each bolt. Screw the studs into diagonally opposite upper and lower tapped holes in the front of the transmission case.

Install input pulley, axle hubs and wheels. Move the transmission assembly into place and guide the shift levers up between the frame rails. Align the pilot studs with the corresponding holes in the frame butt plate and push the transmission firmly against the plate. Install cap screws in the top of the transmission and the open holes at the front and tighten them until snug.

Remove the pilot studs one at a time, replacing them with cap screws. Tighten all six cap screws securely. Connect brake linkage. Install dust cover, instruction plate, fender and seat assembly, drive belt, belt guard, foot rest, etc.

Fill the transmission to proper level with S.A.E. 140 A.P.I. Service GL-5 gear oil. Remove support from beneath tractor frame. Test tractor operation.

8-SPEED TRANSMISSION

Disassembly:

1. Remove axle hubs and input pulley.
2. Place the transmission assembly in a vise or suitable holding fixture, as shown in Figure 1 (shown with levers, brake band, brake drum, hubs, and input pulley removed).

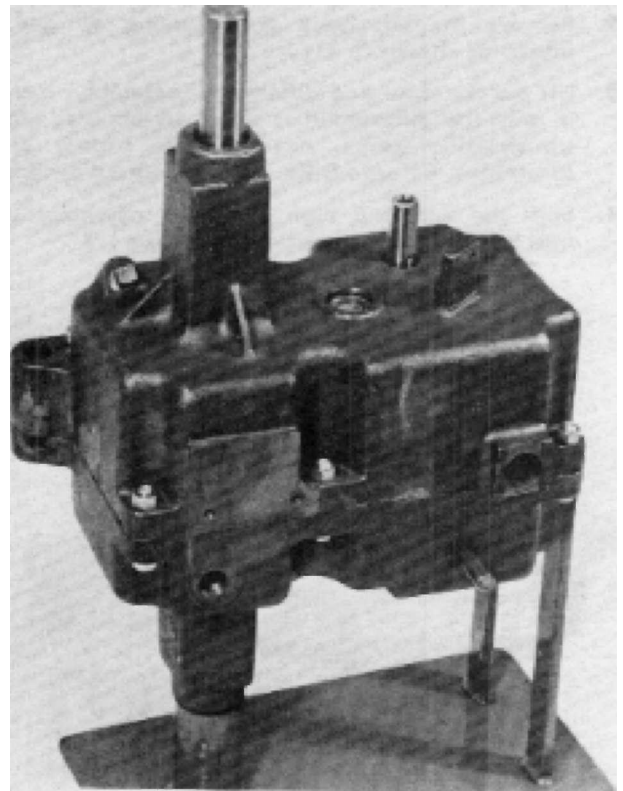

FIGURE 1

3. Place the shift lever in neutral and pull the shift lever rubber boot from the transmission boss. Loosen the shift lever retaining lock nut and set screw and remove the shift lever.
4. Remove the roll pin and remove the high-low range lever.
5. Remove the two (2) brake band retaining bolts and remove the brake band.

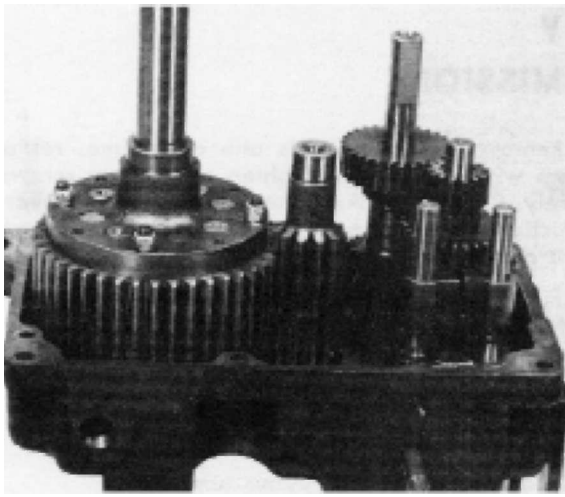

FIGURE 2

6. Remove the brake drum retaining bolt and washer, and remove the brake drum using a suitable puller as required.
7. Remove paint and burrs from both axle shafts, brake shaft and the input shaft.
8. Remove the six (6) 3/8" x 16 bolts and nuts that retain the right hand and left hand cases.
9. Remove the left hand case leaving all gears intact, as shown in Figure 2.
10. Lift out the axle and differential assembly. Note: If only the differential is to be overhauled, the transmission section need not be further disassembled. Refer to Differential Overhaul Section.
11. Shift the 2nd and high shift fork assembly into the 2nd speed position. See Figure 3.

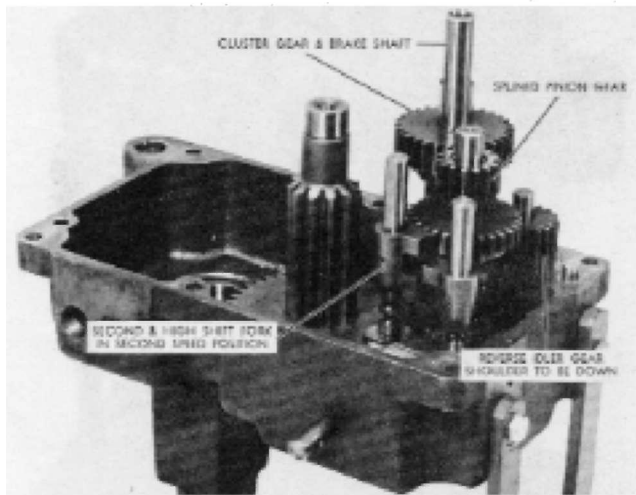

FIGURE 3

12. Remove the cluster gear and brake shaft assembly, and the reverse idler gear and shaft.
13. Remove the large reduction gear assembly.

NOTE: Prior to 1973 models the pinion reduction gear and thrust washer was welded together and was serviced as one part.

Starting with the 1973 models the pinion, reduction gear and thrust washer are serviced sepa-

ately. The thrust washer goes on the stub shaft next to the big gear. The gear and pinion may be pressed in and out of the gear with a suitable arbor press.

14. Remove the splined pinion gear from the input shaft.
15. With a screw driver or other suitable tool remove the plug from the detent passage, as shown in Figure 4.

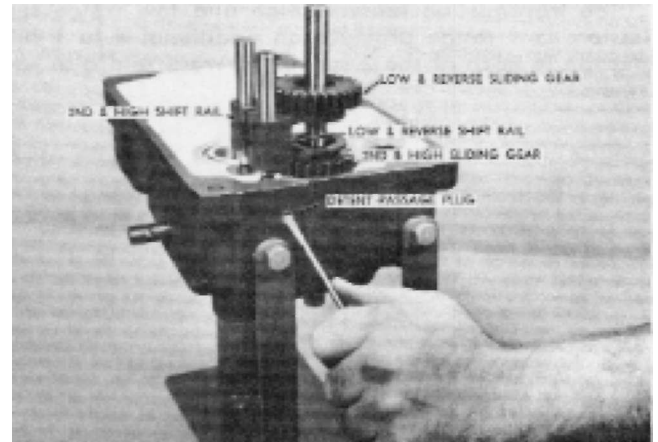

FIGURE 4

16. Place the shift forks in neutral and remove the low and reverse shift rail and fork assembly (the one nearest the end of the case) together with the low and reverse sliding gear, making sure to catch the stop ball and other detent parts as the shift rail is removed.
17. Remove the 2nd and high shift rail and fork assembly together with the 2nd and high sliding gears.
18. Remove the remaining detent parts — ball, spring and stop pin from the detent passage.
19. Remove the gear and spline assembly from the input shaft. Figure 5.

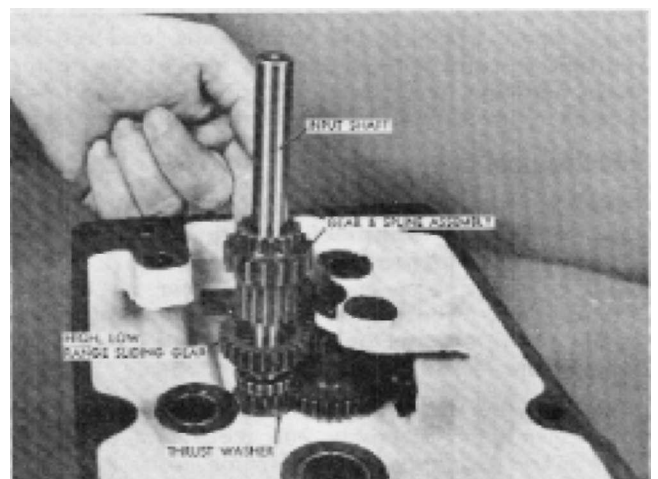

FIGURE 5

20. Remove the input shaft. Figure 5.

21. Remove the sliding gear from the high-low range shift fork assembly. Figure 6.
22. Remove the input shaft to case thrust washer.

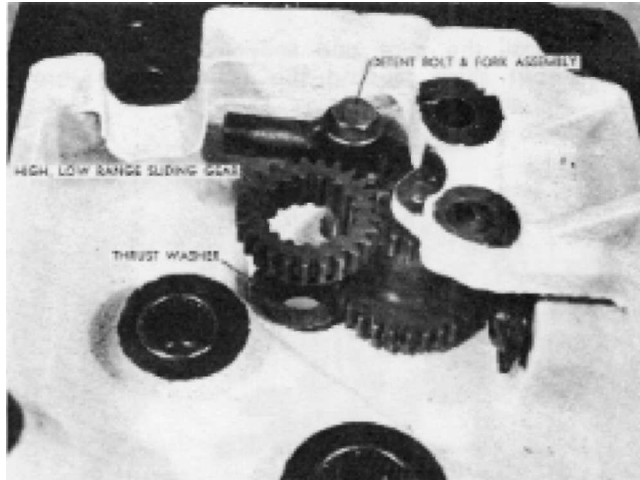

FIGURE 6

23. Remove the high-low range detent bolt and shift fork assembly. Figure 6.
24. Remove the detent bolt from the shift fork being careful to catch the stop ball and spring.
25. Remove the reduction gear shaft (Figure 7) by driving it out toward the inside of the case, and remove the reduction gear.
26. Remove the high-low range shift lever and shaft assembly from the inside of the case.

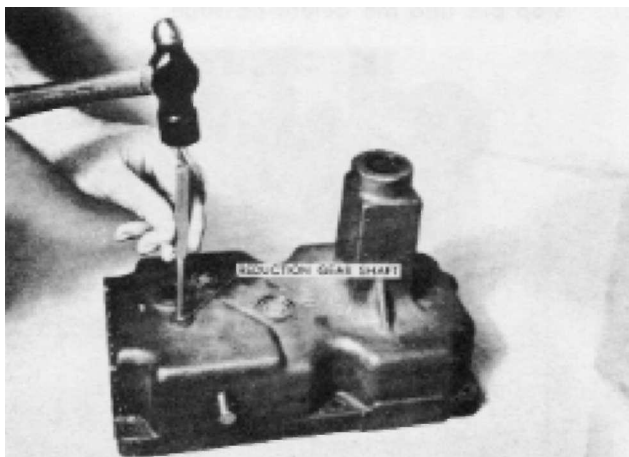

FIGURE 7

Needle Bearing Replacement:

If needle bearings are to be replaced they should be removed and installed with suitable arbors.

Cluster Gear:

The cluster gear and brake shaft assembly may be disassembled as shown in Figure 8. Disassemble and assemble carefully to avoid damage to the Woodruff key and bushings. The cluster gear bushings may be removed and installed using suitable arbors.

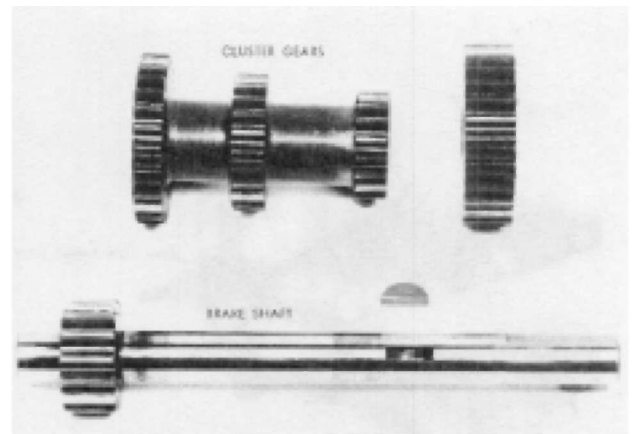

FIGURE 8

Cleaning, Inspection, Bearing and Oil Seal Replacement

Thoroughly clean all parts and inspect for damage and wear. Use suitable arbors when replacing bearings. Always renew all oil seals and gaskets.

8-SPEED TRANSMISSION

Assembly:

1. Install the high-low range shift lever (Figure 9) in the hole of the right case below the shift rail supports.

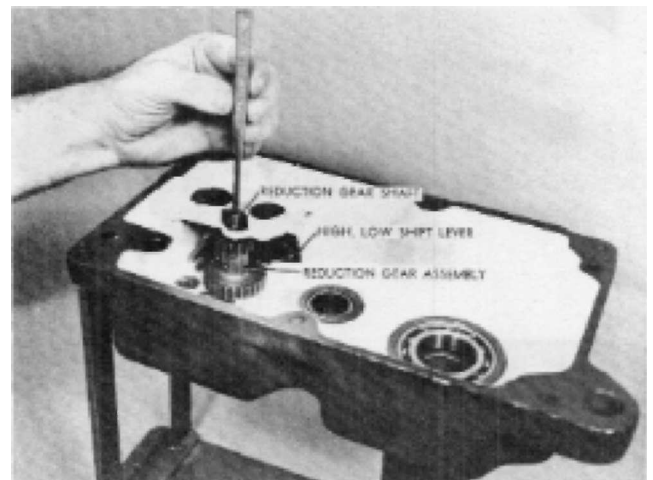

FIGURE 9

Position the reduction gear assembly in place with the large gear down and insert the reduction gear shaft, driving it in place from the inside of the case, as shown in Figure 9.

3. Assemble the high and low range shift fork assembly (Figure 10) by inserting the spring and ball in the detent hole. Using a punch, press on the ball, compressing the spring. At the same time insert the detent bolt, withdrawing the punch as the bolt slides in place.

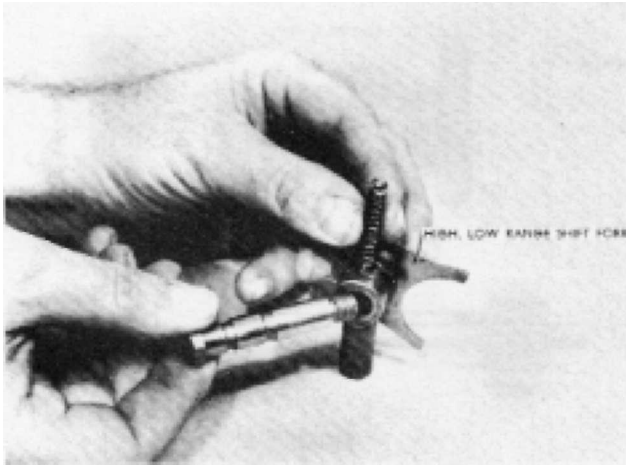

FIGURE 10

4. Position the detent bolt and shift fork so that the slot of the high and low range shift lever engages the shift fork (Figure 11) and thread the bolt in place until it seats securely against the shoulder. Torque the detent bolt to 12-17 ft. lbs.
5. Using a punch to move the high-low range shift lever, check the operation of the detent and fork assembly.
6. Lift up on the reduction gear and slide the input shaft thrust washer into position. Figure 12.

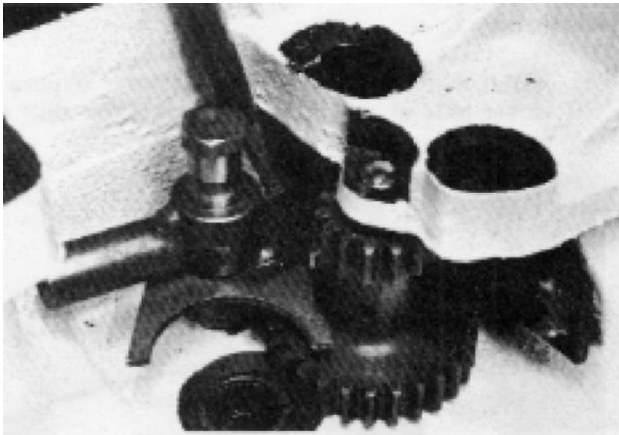

FIGURE 11

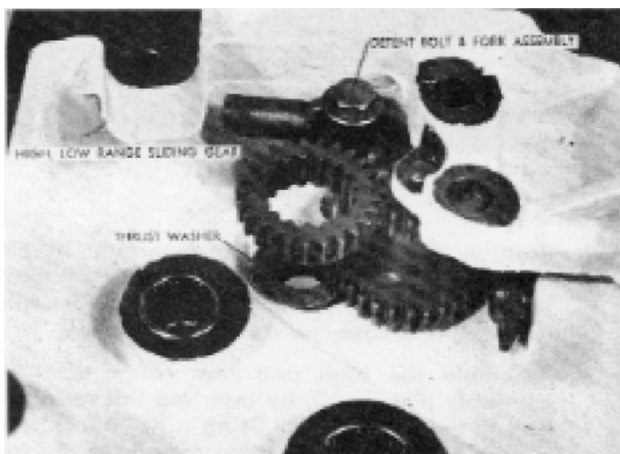

FIGURE 12

7. Install the sliding gear into the high-low range fork with the groove down. Figure 12.
8. Install the input shaft, sliding it down through the high-low range sliding gear and thrust washer. Figure 13.
9. Install the gear and spline assembly over the input shaft, sliding the spline down through the sliding gear. Figure 13.

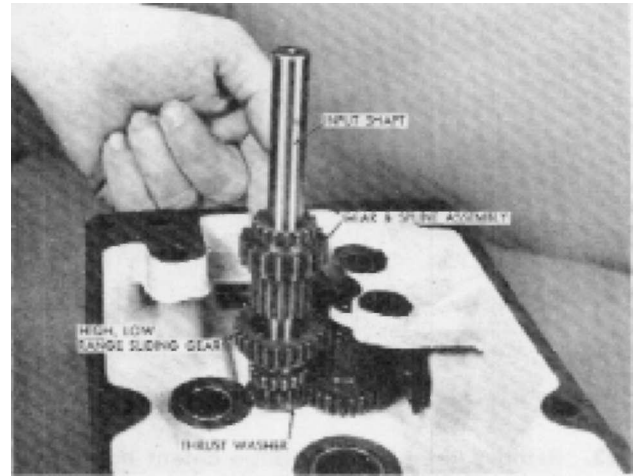

FIGURE 13

10. Install the 2nd and high shift rail and fork assembly (the one with the unequally spaced detent grooves) together with the 2nd and high sliding gear (the smaller of the two sliding gears). The sliding gear fits down over the input shaft with the shift fork groove up.
11. Install one of the stop balls, stop spring and stop pin into the detent passage.

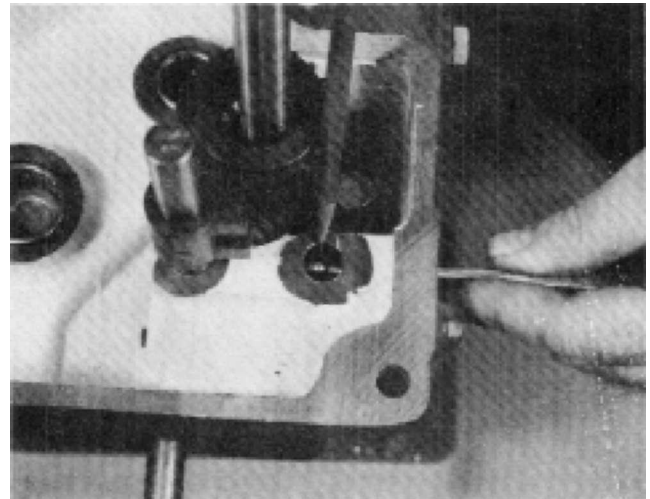

FIGURE 14

12. Install the 2nd stop ball and using a punch, push the ball in against the spring. Move the installed shift rail into the neutral position and continue to push on the punch (Figure 14) until the ball is flush with the shift rail bore. At the same time insert the low and reverse shift rail and fork assembly together with the low and reverse sliding gear, (Figure 15) removing the punch as the shift rail passes the ball. See de-

tent drawing Figure 17. Note: The low and reverse gear fits down over the input shaft with the shift fork groove down.

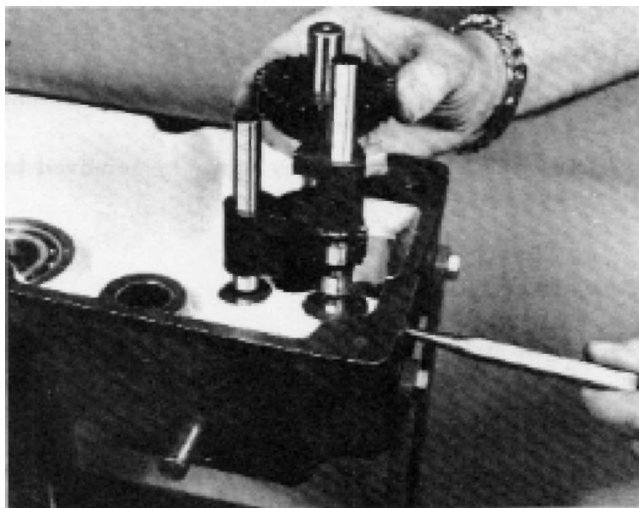

FIGURE 15

13. Install the splined pinion gear.
14. Shift the 2nd and high shift rail and fork assembly into 2nd speed position.
15. Install the large pinion and reduction gear assembly (and the thrust washer if used).
16. Install the reverse idler gear shaft and gear assembly making sure the shoulder of the gear goes down. Figure 16.

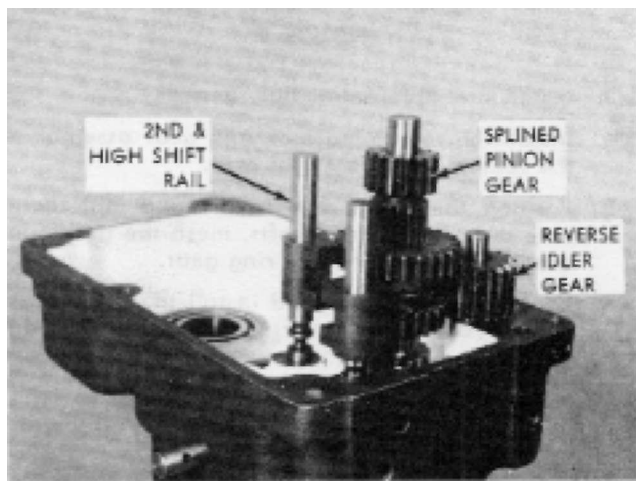

FIGURE 16

17. Install the cluster gear and brake shaft assembly. See Figure 18.
18. Install the differential and axle assembly with the retaining bolt nuts **up** toward the left hand case. Figure 19.
19. Recheck for proper assembly, a free neutral and proper operation in all gears in both ranges. Place the shift forks in neutral position.
20. Install a new case gasket holding it in place with gasket sealer and install the left hand case.

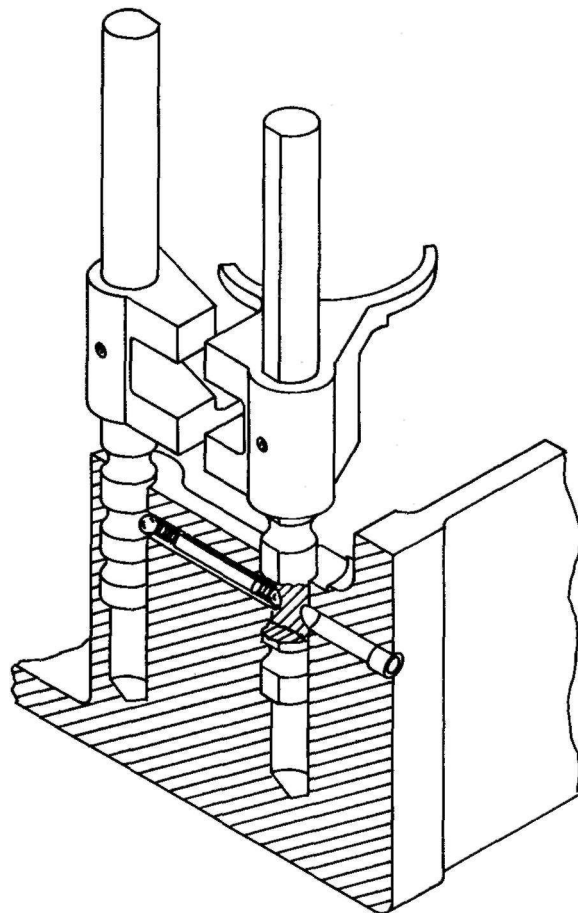

FIGURE 17

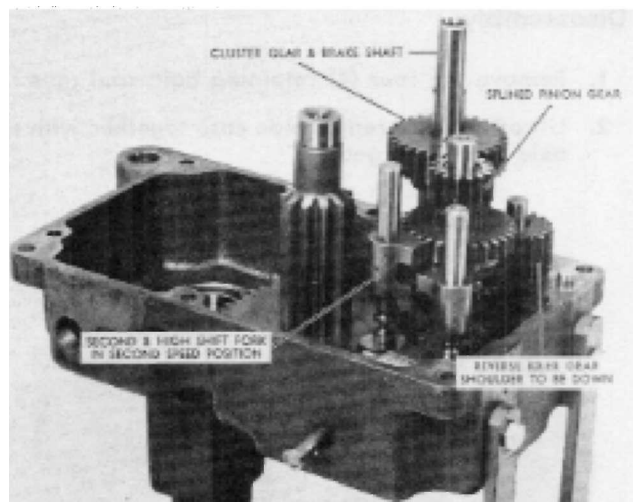

FIGURE 18

21. Install the six (6) 3/8" x 16 bolts and nuts and tighten all bolts evenly to avoid distortion.
22. Install the shift lever assembly and retain with the set screw and lock nut. Install gear shift lever rubber boot.
23. Install the high-low range selector lever and retain with the roll pin.
24. Recheck for a free neutral and proper operation in all gears and ranges.

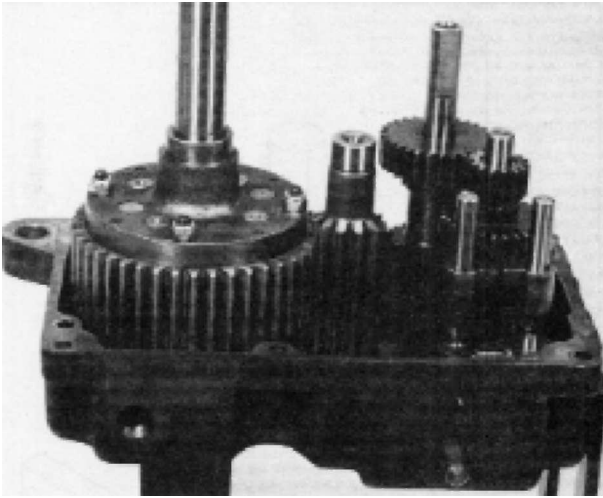

FIGURE 19

25. Install a new plug to seal the detent passage and drive it in flush with the case.
26. Install the brake drum and secure with the retaining bolt and washer.
27. Install the brake band and secure with the two retaining bolts.

8 PINION DIFFERENTIAL

NOTE

See Service Bulletin numbers 174 & 273 for important information on differential bolts.

Disassembly:

1. Remove the four (4) retaining bolts and nuts.
2. Lift off the differential side case together with the axle shaft and gear.

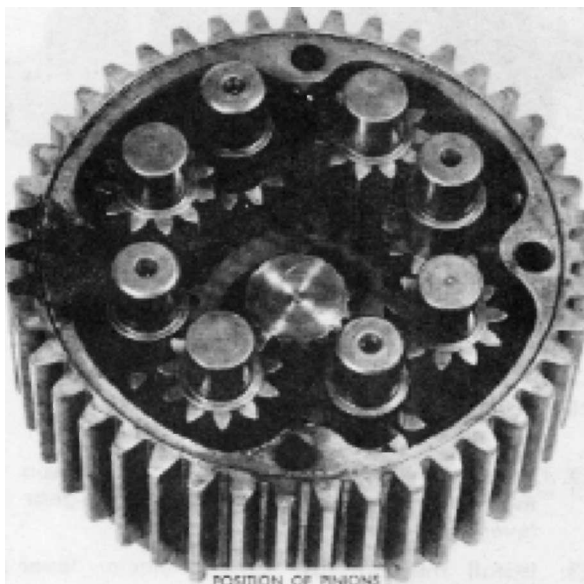

FIGURE 1

3. Remove the axle shaft and gear from the case.
4. Remove the differential bull gear.
5. Note position of the eight (8) pinions. Adjacent pinions are installed in opposite directions, which make the position of the diagonally opposite pinions the same. See Figure 1.
6. Remove the pinions and remove the remaining axle shaft and gear from the case.
7. The axle shaft gears may easily be removed by removing the snap rings.

Assembly:

1. If the axle gears were removed, install them on the axles and **install the snap rings with the sharp side of the snap ring toward the inner end of the axle.**
2. Install one of the axle and gear assemblies in the differential case and install the eight (8) pinions, as shown in Figure 1. Properly installed each axle gear will mesh with four pinions.

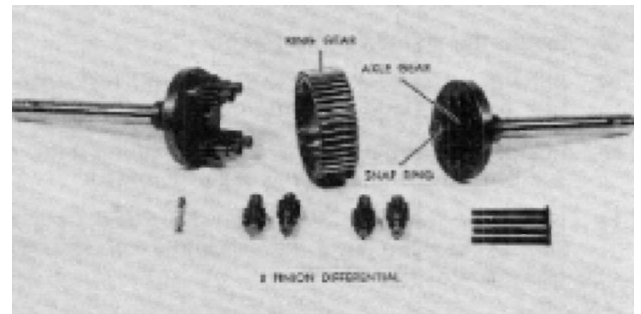
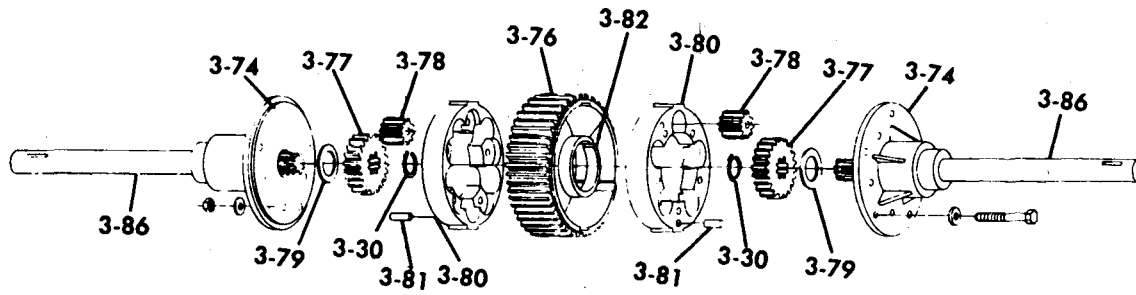

FIGURE 2

3. Install the differential bull gear.
4. Install the remaining axle and gear assembly in the remaining differential case.
5. Position the other axle, gear, and differential case over the pinion shafts, mesh the gears and seat the case against the ring gear.
6. Center the bull gear and install the four (4) retaining bolts and nuts. Tighten securely and evenly to avoid distortion.

8-SPEED, TO PINION LIMITED SLIP DIFFERENTIAL

(Used in 5073 Transmission)



ITEM NO.	DESCRIPTION
3-30	Snap Ring
3-74	R. H. End Cap
3-74	L. H. End Cap
3-76	Ring Gear
3-77	Axle Gear
3-78	Differential Pinion Gear
3-79	Thrust Washer
3-80	Body
3-81	Roll Pin
3-82	Spring
3-86	R. H. Axle
3-86	L. H. Axle

NOTE

See Service Bulletin number 252 for conversion off limited slip differential to 8-pinion differential.

8-SPEED. 4 PINION DIFFERENTIAL 1" AXLES

(Used in 5086 Transmission)

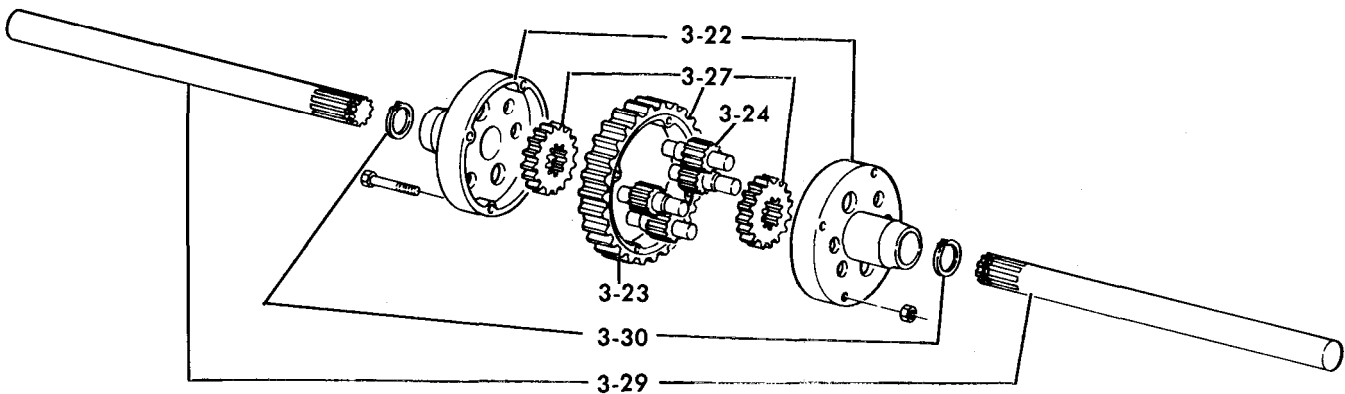

ITEM NO.	DESCRIPTION
3-22	Differential Case
3-23	Ring Gear
3-24	Differential Pinion Gear
3-27	Axle Gear
3-29	Axle
3-30	Snap Ring

8-SPEED, 8 PINION DIFFERENTIAL 1-1/8" AXLES

(Used in 5091, 103907, 103916 4V 103918 Transmissions)

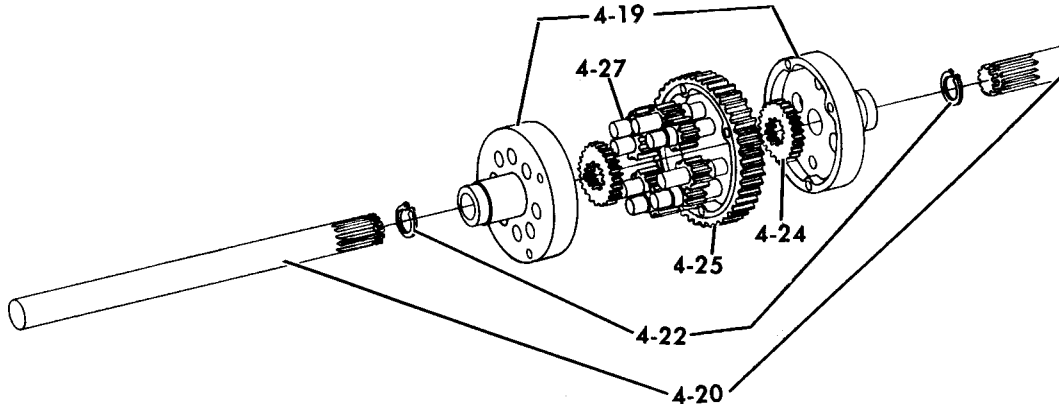

ITEM NO.	DESCRIPTION
4-19	Differential Case
4-20	Axle
4-22	Snap Ring
4-24	Axle Gear
4-25	Ring Gear
4-27	Differential Pinion Gear

8-SPEED TRANSMISSION

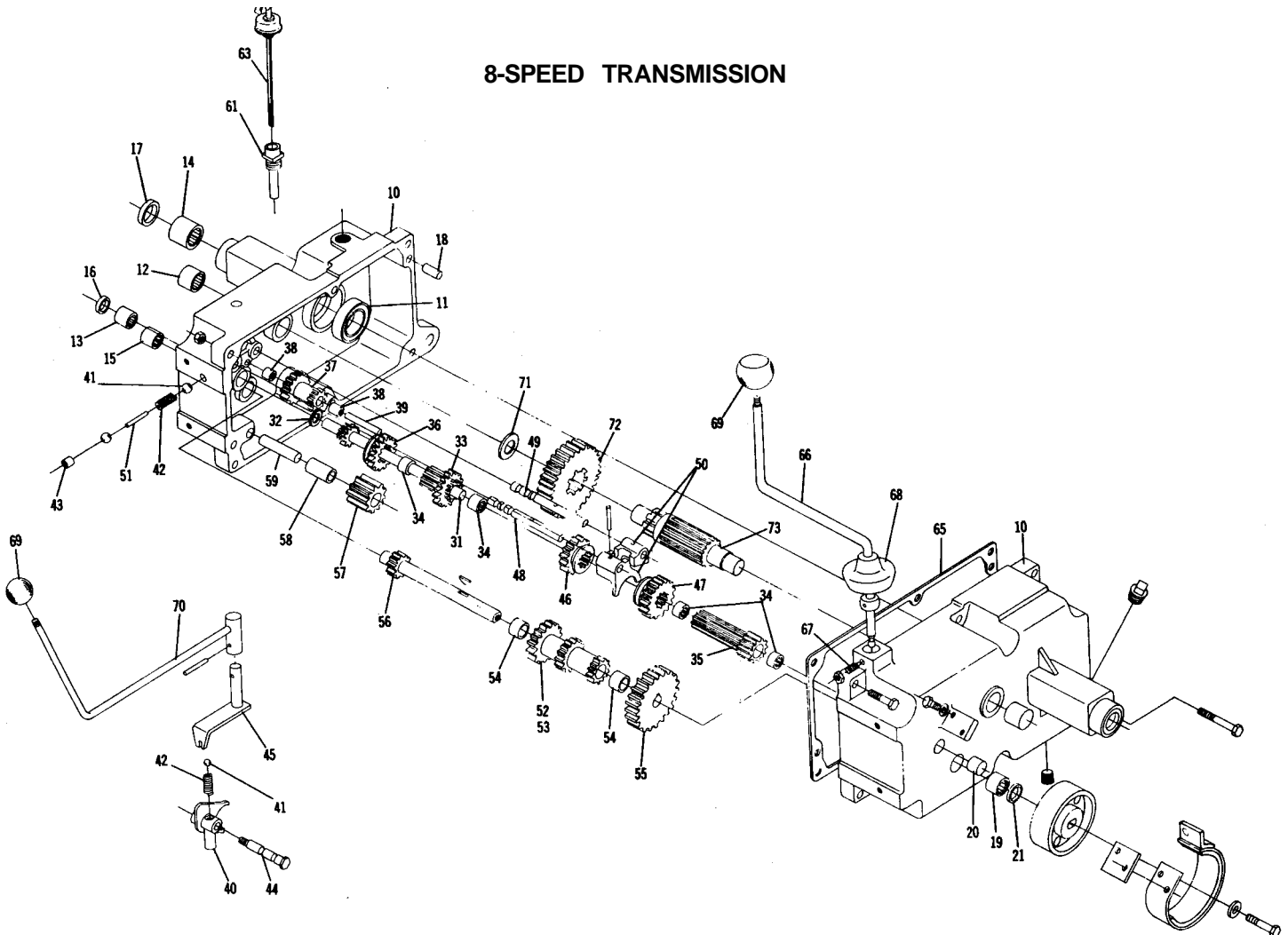

8-SPEED TRANSMISSION

ITEM NO.	DESCRIPTION
3-10	Case — R. H. Case - L. H.
3-11	Ball Bearing 1 1/2 I. D.
3-12	Needle Bearing 1" 1. D.
3-13	Needle Bearing 5/8" 1. D.
3-14	Needle Bearing 1 1/8 1. D.
3-15	Needle Bearing 3/4" 1. D.
3-16	Seal — 5/8 Shaft
3-17	Seal - 1 1/8" Axle
3-18	Dowel Pin
3-19	Needle Bearing 3/4" 1. D.
3-20	Needle Bearing 5/8" 1. D.
3-21	Seal — Brake Shaft Differential Case
3-31	Input Shaft
3-32	Thrust Washer
3-33	Gear and Spline
3-34	Needle Bearing 5/8" 1. D.
3-35	Gear and Spline Pinion
3-36	Sliding Gear
3-37	Reduction Gear
3-38	Needle Bearing 3/8" 1. D. x 1/2
3-39	Reduction Shaft
3-40	Shift Fork
3-41	Stop Ball
3-42	Stop Spring
3-43	Plug
3-44	Detent Bolt
3-45	Shift Lever
3-46	Gear — Hi and 2nd
3-47	Gear — Low and Reverse
3-48	Front Shift Rail
3-49	Rear Shift Rail
3-50	Shift Fork Roll Pin, 1/8 x 1"
3-51	Shift Stop Pin
3-52	Gear and Bearing, Complete
3-53	Cluster Gear
3-54	Bronze Bearing 3/4" I. D.
3-55	Reduction Gear
3-56	Cluster Gear and Brake Shaft #9 Woodruff Key
3-57	Reverse Idler Gear
3-58	Bronze Bushing 1/2" 1. D.
3-59	Shaft
3-61	Nipple
3-63	Dipstick
3-65	Case Gasket
3-66	Shift Stick
3-67	Set Screw — Dog Point — 1/4-20x 3/4 Nut, 1/4-20
3-68	Boot
3-69	Knob
3-70	Shift Handle Roll Pin 3/16 x 3/4
3-71	Thrust Washer
3-72	Gear Assembly
3-73	Gear 11T Gear 44T



WHEEL HORSE PRODUCTS, INC.
PRINTED IN U.S. A. 0482 Revision

515 West Ireland Road. P.O. Box 2649
FORM

South Bend. Indiana 46680
NO. A-1392

P/N 492-4004