

IS-5 September 1993
(Supersedes HS-5 1/90
which still can be used)

HAZARDOUS MATERIALS: A CITIZEN'S ORIENTATION



Federal Emergency Management Agency



U.S. Environmental Protection Agency



U.S. Department of Transportation

TABLE OF CONTENTS

Forward -----III
Introduction-----V
Pretest-----VII

Unit 1: Hazardous Materials and Human Health

Hazardous Materials in the United States -----1-1
What are Hazardous Materials?-----1-3
How Hazardous Materials Harm the Body -----1-4
Pathways of Exposure -----1-6
Assessing Risk -----1-6
Toxic Materials in the Body -----1-8
Studies of Toxic Effects -----1-11
Hazardous Materials in the Environment -----1-12
Summary -----1-17
Haz mat Teaser -----1-18
Check Your Memory -----1-20

Unit 2: Hazardous Materials Regulation

Hazardous Materials Legislation -----2-1
Responsibilities of Key Federal Agencies -----2-5
The Emergency Planning and Community Right -to-Know Act (Title III) -----2-7
Reducing Risks from Hazardous Materials Releases -----2-11
When Laws are Not Obeyed -----2-13
Summary -----2-13
Haz Mat Teaser -----2-15
Check Your Memory -----2-18

Unit 3: Identifying Hazardous Materials

Detecting the Presence of a Hazard -----3-1
Hazardous Materials Production and Storage -----3-2
Reading a Material Safety Data Sheet (MSDS) -----3-3
The NFPA 704M System -----3-7
Hazardous Materials Transportation -----3-8
Hazardous Materials Waste Sites -----3-10
Hazardous Materials in Rural Areas -----3-12
Summary -----3-13
Haz Mat Teaser -----3-14
Sample Material Safety Data Sheet (MSDS) -----3-16
Check Your Memory -----3-18

Hazardous Materials: A Citizen's Orientation / Table of Contents

Unit 4: Preparing for Hazardous Materials Incidents

Is Your Community Prepared for a Hazardous Materials Incident? -----4-1
Roles in Incident Response -----4-5
Protection Yourself in a Toxic Incident -----4-11
What Citizens Can Do to Enhance Local Preparedness -----4-16
Summary -----4-17
Is Your Community Prepared for a Hazardous Materials Emergency? -----4-18
Haz Mat Teaser -----4-20
Check Your Memory -----4-22

Unit 5: Hazardous Materials in Your Home

Common Household Hazardous Materials -----5-1
Using and Storing Household Hazardous Materials -----5-6
First Aid -----5-9
Hazardous Waste Disposal -----5-10
Summary -----5-16
Haz Mat Teaser -----5-17
Check Your Memory -----5-18

Glossary -----G-1

Resources

Member Agencies of the National Response Team -----R-1
Organizations to Write for More Information-----R-2
Recommended Reading -----R-5
Computer Networks Open to the Public-----R-9
Hazardous Materials Hotlines and Other Telephone Services -----R-12

Answer Key

Haz Mat Teasers -----A-1
Pretest -----A-4
Check Your Memory -----A-4

Final Examination -----E-1

Grateful acknowledgement is given to the Genium Publishing Corporation of Schenectady, New York for providing the sample Material Safety Data Sheet (MSDS) that appears in Unit 3, and to Environmental Health Watch, whose "Citizen Fact Sheets" provided the basis for two tables included in Unit 5.

FOREWORD

COURSE SPONSORS

Three Federal agencies have contributed to the development of this home study course: the Federal Emergency Management Agency (FEMA), the Environmental Protection Agency (EPA), and the Department of Transportation (DOT). All three agencies have responsibilities related to the protection of the public from hazards posed by the manufacture, transport, and disposal of hazardous materials.

The Department of Transportation is charged with the development and oversight of the Nation's transportation policy, including the regulation of interstate hazardous materials transportation. The Environmental Protection Agency is the primary agency responsible for protecting our environment, including funding cleanup operations at thousands of abandoned hazardous waste disposal sites and oversight of programs to regulate disposal of hazardous wastes identified by certain legislation. The Federal Emergency Management Agency is the central point of contact within the Federal government for a wide range of emergency management activities in both peace and war. That responsibility includes the design, delivery, coordination, and monitoring of hazardous materials training in cooperation with the members of the National Response Team (NRT).

FEMA's training program is managed by its Office of Training, which includes two schools: The National Fire Academy (NFA) and the Emergency Management Institute (EMI). Both the National Fire Academy and the Emergency Management Institute offer courses, workshops, and seminars on the campus at Emmitsburg, Maryland and nationwide through the Emergency Management Training program and State fire service training programs. Although most training activities are directed at State and local government officials with emergency management or fire protection responsibilities, some are also provided to private sector audiences as well as to the general public, whose support is necessary for an effective, comprehensive emergency management program. The National Fire Academy and the Emergency Management Institute actively support each other's training activities. While the Emergency Management Institute had the primary role for coordinating the development of this course, the National Fire Academy provided support through technical assistance.

Home Study Courses

The home study program is one of the delivery channels the Emergency Management Institute uses to deploy emergency management training to the general public and to selected emergency management audiences. The Emergency Management Institute's home study program currently consists of five courses:

- Emergency Program Manager (HS-1)
- Emergency Management USA (HS-2)
- Radiological Emergency Management (HS-3)
- Preparedness Planning for a Nuclear Crisis (HS-4)

This course, "Hazardous Materials: A Citizen's Orientation," is the fifth in the series. These home study courses are geared toward both the general public and persons who have local government responsibilities for emergency management. All courses are suitable for either individual or group enrollment, and are available at no charge. Courses include a final examination, and persons who score 75% or better on the examination are issued a certificate of completion by EM 1.

For information about these courses, contact your local or State Office of Emergency Management or write to:

FEMA Home Study Program
Administration Office
Emergency Management Institute
16825 S. Seton Avenue
Emmitsburg, MD 21727

In addition to the courses available through the Emergency Management Institute's home study program, the National Fire Academy offers a home study course entitled, "Wildland/Urban Interface Fire Protection." The course is designed to provide individuals with the skills needed to assess local wildland/urban interface fire problems, recognize proven protection strategies, and put solutions to work protecting community and wildlands. This course may be purchased through the National AudioVisual Center, 8700 Edgeworth Drive, Capitol Heights, MD 20743-3701, (301) 763-1896.

INTRODUCTION

As hazardous materials and hazardous wastes become more and more commonplace, accumulating in our earth, air, and water, it is vitally important that citizens are well-informed about the challenges posed by these substances. American communities are facing policy decisions that can dramatically affect their population's well-being: Should hazardous materials traffic be regulated? What is the community's role in preparing for the possibility of a serious hazardous materials accident? What should be done with household hazardous wastes? Concerned community members willing to take the time to learn more about such issues can help protect their own health and contribute to their community—for just as surely as there are thorny problems associated with hazardous materials, there are creative minds at work seeking and testing solutions.

This home study course is intended to provide interested members of the general public with a general introduction to hazardous materials that can serve as a foundation for more specific research. No prior knowledge of the subject is assumed. At the end of the course, the reader should be able to:

- Recognize the dangers posed by hazardous materials
- List places where hazardous materials are likely to be encountered
- Identify when a hazard may exist
- Contact the appropriate persons or agencies to give or receive specific hazardous materials information
- Identify procedures to minimize personal and community exposure to hazardous materials.

The course has five units:

Unit 1: Hazardous Materials and Human Health introduces many of the basic terms used to discuss hazardous materials problems, and explains how hazardous materials enter and move through the body and the environment.

Unit 2: Hazardous Materials Regulation explains the roles of Federal, State, and local governments in reducing hazardous materials risks, and reviews the key provisions of critical Federal legislation.

Unit 3: Identifying Hazardous Materials provides an overview of locations in which these materials are commonly found and discusses ways of determining what particular chemicals, with what health effects, exist in these locations.

Unit 4: Preparing for Hazardous Materials Incidents shows what local communities can do to increase their preparedness to respond to hazardous materials accidents of any size. It also identifies steps individuals can take to protect themselves in an incident.

Unit 5: Hazardous Materials in the Home presents the hazards associated with common household hazardous materials and reviews procedures for handling and discarding such materials safely at both the household and community level.

How to Complete the Course

You will remember the material best if you do not rush through it. Often there is white space next to the text where you can make notes. (The more you *interact* with the material, the better you will remember it!) Take a break at the end of each unit and give yourself time to think about the material. Then, go back and take the quiz at the end of the unit, reviewing the relevant material if you missed any questions.

Hazardous Materials: A Citizen's Orientation/Introduction

The course contains a pretest, five units, a glossary, a resource section to help you continue learning, and a final examination. You should take the **pretest** to test your knowledge **before** you begin the course. You can score the pretest yourself, using the pretest answer key, to determine how much you know before you begin studying the course.

The **glossary**, located after the final unit, contains definitions of terms related to hazardous materials. The glossary may be consulted while you are reading the units, or may be read separately.

A **resource section** is included to help you continue learning after you have completed the course. This section features listings of organizations that can supply additional information relevant to course objectives, recommended reading, computer networks accessible to the public, and telephone services that supply information on specific hazardous materials issues.

The **final examination**, located at the **end** of the course booklet, will test the knowledge you have gained from the course. An answer sheet is supplied with the course materials. Mail the completed answer sheet to the address on the form; your test will be evaluated and results will be mailed to you within a few weeks. If your score is 75% or above, a certificate of completion will be mailed to you. Interested students successfully completing the course may apply for one semester hour of college credit through the FEMA Home Study Program Office.

How to Take the Pretest

The following pretest is designed to evaluate your current knowledge of hazardous materials. Read each question carefully, and select the one answer that best applies. Circle the letter corresponding to the answer you have chosen. Complete all the questions **without** looking ahead to the course materials, as your pretest score will be a useful measure only if the questions are answered before you begin the course.

When you have completed the pretest, check your answers against the answer key provided. As you begin each unit, watch for discussions of the questions you missed.

The pretest should take you approximately 15 minutes to complete. Find a quiet spot where you will not be interrupted, and begin. When you have finished, and all of your answers have been checked against the key, begin reading Unit 1.

PRETEST

(answers on page A-4)

1. The medium through which a chemical reaches us (air, surface water, groundwater, or soil) is irrelevant in determining the risk it poses to our health.
 - a. True
 - b. False
2. Which of the following is a means by which you can become contaminated?
 - a. Touching a contaminated object
 - b. Eating contaminated food
 - c. Breathing contaminated air
 - d. All of the above
3. Teratogens, carcinogens, and mutagens are all substances that produce this type of effect:
 - a. Irritation of the stomach
 - b. Tumors
 - c. Acute symptoms, such as coughing
 - d. Changes in the genetic code (DNA)
4. Asphyxiants are chemicals that:
 - a. Inflame living tissue
 - b. Deaden the nervous system
 - c. Starve cells of oxygen
 - d. Affect specific organ systems
5. Exposure to a toxic chemical over a long period is called _____ exposure.
 - a. Acute
 - b. Toxic
 - c. Lethal
 - d. Marginal
 - e. Chronic
6. Title III of the 1986 Superfund law provides for citizen rights relating to:
 - a. Community right-to-know information processes
 - b. Pre-planning for chemical emergencies
 - c. Worker training standards
 - d. Both a and b
 - e. None of the above
7. Under Superfund, the **primary** agency for planning, preparedness and related training for hazardous materials emergency management is:
 - a. FEMA
 - b. EPA
 - c. DOT
 - d. OSHA
 - e. USDA
8. Under the Hazardous Materials Transportation Act, which agency is primarily responsible for standards and regulations relating to the **interstate** transport of hazardous materials?
 - a. FEMA
 - b. OSHA
 - c. DOT
 - d. FBI
 - e. EPA

9. Which agency has primary regulatory responsibility for standards and rules relating to workplace safety?
- a. FEMA c. DOT e. EPA
b. OSHA d. FBI
10. Title III of the new Superfund law requires, **for the first time**, that stated quantities of certain commonly used and widely distributed chemicals of which industry be reported to designated government agencies?
- a. Manufacturing c. Agricultural e. Retail merchandising
b. Construction d. Mining
11. The most commonly transported class of hazardous materials in the United States is:
- a. Acids and caustics
b. **Etiological** agents
c. Nuclear fuels
d. Compressed gases
e. Flammable and combustible liquids
12. The measure of a chemical's risk to living tissue is usually related to a recommended standard expressed in:
- a. Liters (l.)
b. Ounces (oz.)
c. Square inches (sq. in.)
d. Cubic centimeters (cc)
e. Parts per million (ppm)
13. The U.S. Department of Transportation (DOT) applies its definition of "any substance that poses an unreasonable risk to public safety and health" when transported to:
- a. Hazardous materials c. Chemical substitutes
b. Hazardous waste d. Elementary particles
14. The **least dependable** and most potentially dangerous method to use for identifying the presence of hazardous materials is:
- a. Container shape and size
b. **Labelling** and marking
c. Sense of smell or taste
d. Discoloration of materials
15. The United Nations (U. N.) placarding and **labelling** system is designed for and used in marking the presence and nature of hazardous materials in:
- a. Fixed-site locations
b. Transportation modes
c. **Both**
d. Neither

16. The on-scene Incident Commander at a hazardous materials incident in **most** States and jurisdictions is likely to be from:
- a. The local public works department
 - b. The local fire service
 - c. The local law enforcement department
 - d. The State medical examiner
 - e. EMS or EMT personnel
17. One thing an untrained and unauthorized citizen should **not** do at the scene of a hazardous materials incident is:
- a. Observe all posted exclusion zones
 - b. In absence of any clear direction, move to a location that is uphill and upwind of the suspected risk area
 - c. Attempt to help authorities by approaching the on-scene command post with information
 - d. Avoid the path of incoming equipment
 - e. Listen for public announcements on radio and TV
18. In a hazardous materials incident, as in any emergency or disaster situation, the outcome is dependent primarily on the efforts of which level of government?
- a. Local
 - b. State
 - c. Federal
 - d. International
19. Hazardous materials releases can involve materials which often are odorless, colorless, and tasteless, as well as gases that are heavier than air. Therefore, a citizen who is not qualified to personally determine the presence of hazardous materials threats should:
- a. Act according to personal perception
 - b. Rely on home testing units
 - c. Increase air circulation in the home
 - d. Act according to official advisories
 - e. Use a home gas mask protection unit
20. A hazardous materials Incident Commander has great problems with on-scene civilian personnel who "volunteer" their help and assistance, because such volunteers usually do not have appropriate training and safety awareness.
- a. True
 - b. False
21. Which of the chemicals listed below can cause brain damage (among other effects) if ingested in large quantities? This chemical is found in some older residential piping systems, and can contaminate drinking water.
- a. Asbestos
 - b. Formaldehyde
 - c. Lead
 - d. Radon
22. Inhaling organic solvents in sufficient quantity can cause nausea, headaches, muscular weakness, and impaired motor response (among other effects). Three of the following are organic solvents. Which one is a non-organic solvent?
- a. Paint thinner
 - b. Spot remover
 - c. Drain opener
 - d. Floor polish

Hazardous Materials: A Citizen's Orientation/Pretest

23. Which of the following is a good way to dispose of a significant quantity of a common household hazardous material?
- a. Give it to someone who can use it up properly
 - b. Flush it down the toilet
 - c. Put it in the garbage
 - d. Pour it in your septic tank
24. Product package labels for hazardous materials in shipment utilize three words that express the level of threat posed by that material. Arranged from the **most to least** serious threat, these labels are:
- a. Warning, Danger, Caution
 - b. Warning, Caution, Danger
 - c. Danger, Caution, Warning
 - d. Danger, Warning, Caution
 - e. Caution, Warning, Danger
25. If you are in a position to assist someone who has just splashed a toxic chemical in an eye, the **first** thing you should do is:
- a. Begin flushing the eye with water
 - b. Call the Poison Control Center
 - c. Call a neighbor to ask for advice
 - d. Take the person to the hospital

Unit 1:

HAZARDOUS MATERIALS AND HUMAN HEALTH

In this unit, you will learn:

- Why hazardous materials are a concern
- What hazardous materials are
- How hazardous materials affect the body
- How hazardous materials enter and move through the environment

HAZARDOUS MATERIALS IN THE UNITED STATES

In the years since World War II, new technologies have developed at a stunning pace. Nearly every household in our consumer society has grown accustomed to daily use of manufactured products that offer us increased convenience and efficiency. Detergents. Toilet bowl cleaners. Air fresheners. Specialized glues. Caulks. Insecticides.

Many of these products make use of materials that do not exist in nature. This year alone, over 1,000 new synthetic chemicals will enter our communities. Some will require careful handling during manufacture, transport, storage, use, and disposal in order to avoid causing harm to people, other living things, and the environment.

Many of these chemicals are not "biodegradable" (that is, able to be broken down into their components by microorganisms); for such chemicals in particular, the potential for adverse health effects can continue for decades or even centuries.

We are becoming increasingly aware of the limited space that our planet has to offer for the disposal of toxic products. According to 1987 data based on industry reports of toxic discharges compiled by EPA, over seven billion pounds of toxic substances were released directly into our environment (air, land, and water) by industry manufacturers alone. Numerous small businesses, such as printing industries and vehicle maintenance shops, also released

While hazardous materials attract us by promising to make our lives easier, they often confront us with complex problems—many of which have no easy or immediate solutions.



toxic chemicals not included in these estimates. Few communities are eager to have hazardous waste deposited in their "backyard." A lone barge loaded with garbage made headlines in 1987 as it sailed the seas seeking a place to leave its unwanted cargo. It seemed an apt expression of our country's dilemma.

Naturally occurring toxic substances can also pose problems. For example, ponds near a wildlife refuge in California became contaminated by selenium, an element commonly found in alkaline desert soil. The high level of selenium was the result of irrigation methods used at nearby farms. Water removed the selenium from the soil, dissolved it, and carried enough of the element to non-farm portions of the refuge to threaten wildlife. As waterfowl ingested (ate) the selenium, deformities were found more frequently in developing embryos. Naturally occurring substances have sometimes led to expensive cleanup operations comparable to those required for human-created hazardous waste.

Sometimes, the challenge posed by hazardous materials glares at us in headlines and stories like these:

- In Bhopal, India, 44 tons of methyl isocyanate gas spewed into the atmosphere, killing at least 1,700 persons and injuring tens of thousands.
- In a small Kentucky community, tank cars containing toxic substances derailed and burned. The fire caused a column of toxic smoke 3,000 feet high that forced 7,500 area residents to evacuate.
- In Florida, vandals broke the valves of chemical tanks at a local swimming pool supply company. The chemicals mixed to form a toxic acid, and a poisonous cloud of vapors sent 45 persons to the hospital.
- In Louisiana, up to 41,000 pounds of hydrobromic acid fouled part of the Mississippi River after two ships collided.
- In Pennsylvania, a garbage truck operator found his load on fire and dumped it in a residential driveway: mixed chemicals, discarded by a high school science department, released cyanide vapors that sent 100 persons to the hospital.
- Two New Jersey workers were killed and five injured by vapors inhaled as they cleaned a chemical mixing vat at a local company.

Often, however, problems posed by hazardous materials are less clear-cut. Many of the effects attributed to toxic substances, such as certain types of cancer, have multiple causes. In any single case of illness or death, it is difficult to point the finger at a specific instance of exposure to a particular hazardous material. In fact, one study found traces of over two hundred industrial chemicals and

pesticides in members of an American sample group. Determining at what exposure level each of these common substances becomes harmful to human health is not only a scientific question but also a social, political, and economic issue.

Our legal system seeks to control these materials at every level of government—Federal, State and local—but it is hampered by funding imitations, debates over emerging technology, lack of definitive research in certain areas, and competing rights and interests. Laws and regulations at all three levels of government address various aspects of the hazardous materials problem by specifying how chemicals must be stored, what employees are told about chemicals they handle at work, how chemicals are labelled, what containers are needed to transport specific chemicals, and what emissions levels are acceptable from industries. In each instance, the local government's role in regulating its own hazardous materials problems is critical.

In 1986 the Emergency Planning and Community Right-to-Know Act made history by requiring a local farm, industry, or small business that stores a certain quantity of "extremely hazardous substances," as defined by an EPA list, to report them to the State Emergency Response Commission (SERC). This law, also known as the Superfund Amendments and Reauthorization Act of 1986, or just "Title III," includes provisions intended to help local-level planners work with industry to identify and reduce risks from toxic chemicals, and, if necessary, to seek corrective action through legal remedies. It also creates new opportunities for citizens to identify and alter potentially hazardous conditions in their communities. It is based on the assumption that the more citizens know about local chemical hazards, the better equipped they and their local governments will be to make wise decisions about how risks associated with hazardous materials are managed in their communities.

But the hazardous materials challenge facing our country is not posed simply by chemicals released into the environment (intentionally or accidentally) by industries. Each individual household creates hazardous waste which, when combined with that from other homes in the same community, presents local government with a potentially serious threat to the local environment and public health. Furthermore, automobiles emit nitrous oxides (one source of "acid rain") and several air toxics. By becoming informed about hazardous materials laws, issues, and protective actions, local citizens can contribute to reducing their community's hazardous materials threat.

WHAT ARE HAZARDOUS MATERIALS?

Hazardous materials, as discussed in this course, maybe defined as follows:

Substances or materials which, because of their chemical,



Because Americans are exposed to toxic substances from so many sources, it is often difficult to trace a health effect to a particular source.

physical, or biological nature, pose a potential risk to life, health, or property if they are released.

A "release" may occur by spilling, leaking, emitting toxic vapors, or any other process that enables the material to escape its container, enter the environment, and create a potential hazard. Hazards are classified in many different ways. The following introduces several common terms:



Absorption and injection are two routes of entry that occur through direct skin contact with a hazardous material.

1. **Explosive** substances release pressure, gas and heat suddenly when they are subjected to shock, heat or high pressure. Fourth of July celebrations use many types of explosive substances that require careful storage and handling to avoid injury.
2. **Flammable** and **combustible** substances are easy to ignite. Paint thinners, charcoal lighter fluid, and silver polish are all highly flammable. Related hazards are posed by **oxidizers**, which will lend oxygen readily to support a fire, and **reactive** materials, which are unstable and may react violently if mishandled.
3. **Poisons** (or toxic materials) can cause injury or death when they enter the bodies of living things. Such substances can be classified by chemical nature (for example, heavy metals and cyanides) or by toxic action (such as irritants, which inflame living tissue, and corrosives, which destroy or irreversibly change it). One special group of poisons includes **etiologicial** (biological) **agents**. These are live microorganisms, or toxins produced by these microorganisms, that are capable of producing a disease.
4. **Radioactive materials** are a category of hazardous materials that release harmful radiation. They are not addressed specifically in this course.

These categories are not mutually exclusive. For example, acids and bases are listed as corrosive materials, but can also act as poisons.

HOW HAZARDOUS MATERIALS HARM THE BODY

Toxic substances can enter our bodies in any of four ways, called **routes of entry**. These are:

- Absorption
- Ingestion
- injection
- Inhalation

1. Absorption (through the skin or eye)

If a child were to walk barefoot through contaminated soil, the contaminant would contact the skin of the foot. This could cause mild skin irritation, or more serious problems like burns,

sores, or ulcers on the outer layers of the skin. Contact with a substance may also occur by spilling it on the skin or brushing against a contaminated object.

Depending on the substance and the condition of the skin, the contaminant might also be absorbed through the skin and poison the body. While some chemicals are not absorbed easily unless the skin is cut, others are absorbed quite readily regardless of the skin's condition. When you are using a material that bears instructions recommending the use of gloves, this is to prevent skin contact or absorption through the skin (also called **dermal** exposure).

When you work with chemicals, it is particularly important never to put your hand to your eye. Eyes are particularly sensitive to toxic substances: since capillaries are near the surface, the substance can enter the bloodstream more readily. Eye contact with toxic substances can cause irritation, pain, or even blindness.

2. Injection

The most familiar example of injection is that of shots given to administer medicine, in which the skin is punctured with needles so that a substance can enter the body. Injection can also occur accidentally. For example, if the skin were cut by a contaminated can or a piece of glass that had been in contact with a contaminant, the contaminated substance could be injected into the body. This is a very powerful means of exposure because the contaminant enters the bloodstream **immediately**.

3. Ingestion

If we eat a substance that contains a harmful material, that substance enters our bodies by means of our digestive system. An example of inadvertent ingestion is a battery factory employee who eats lunch in the work area and ingests inorganic lead that has contaminated a sandwich. A more common instance is the child who puts a toxic substance in his or her mouth out of curiosity. We may also ingest residue from chemicals that have been added to our food to kill germs or parasites.

4. Inhalation

It is also possible to be contaminated by toxic substances when we breathe them into our lungs. The amount of air inhaled in a workday can be extremely large, so if we work or live in a contaminated area, we can be exposed to significant quantities of a substance in this way.

Some chemicals have excellent warning properties that let us

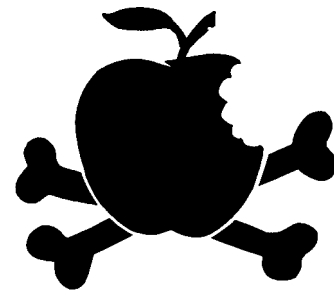

INGESTION

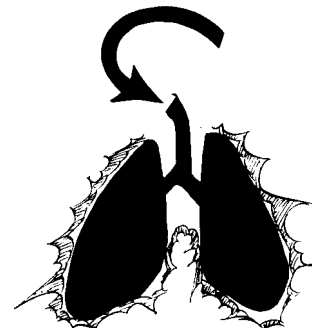

INHALATION

When we ingest (eat) or inhale a substance, the body tries to filter it out through interns/defenses. If there is enough of the substance, these filters are overwhelmed.

know when they are in the atmosphere. There is the well-known "rotten egg" smell of hydrogen sulfide, for example. But at high concentrations of this gas, our sense of smell is quickly lost. Many toxic substances, such as carbon monoxide, are both colorless and odorless, providing us with no sensory clues that we are being exposed to anything unusual.

PATHWAYS OF EXPOSURE

if we consider these routes of entry, it is possible to think of a number of ways in which contaminants escaping into the environment from their **source** may reach a living plant or animal, or **receptor**. Each specific route a chemical might travel from a source to a receptor is called an **exposure pathway**.

The pathway may be either **direct or indirect**. If an open toxic waste dump were near you, you could inhale the vapors from the toxic material, or your skin could contact toxic contaminants if you walked through the substance. These are **direct** means of exposure. The substance can also reach you by **indirect** pathways. For example, toxic vapors or particles from a site at which hazardous waste has been illegally discarded could be carried in the air to a cornfield and deposited on the crop as it rains. You ingest some of the toxic chemical as you eat the corn; or perhaps a farm animal eats the corn and you later eat meat from that animal.

Another pathway might be through drinking water. When rain falls and passes through polluted soil, it carries chemicals deeper into the earth as well as horizontally across the surface of the soil. If they are able to move far enough—which depends on the geology of that particular area—they could contaminate the groundwater. The contaminants could also be carried along the land by means of **surface runoff**, water that moves along the top of the soil, until they reach a recreational pond where children swim. Now there would be another opportunity for dermal contact.

ASSESSING RISK

How much risks associated with any particular source depends on the characteristics of the source, the availability of pathways for it to reach the receptor, and the characteristics of the receptors. No single piece of information alone is sufficient, and incomplete information can be highly misleading. Among the key questions that must be asked in determining risk are the following:

1. What are the **hazardous properties** of the substance? What effects can it have on living things or on the environment? (To answer this question it is often necessary to consider the state of research on the substance, and how much is really known about it.)
2. How **much** of the substance exists at the source, and in what

concentration? A higher quantity or concentration of a toxic substance is more dangerous. However, the risk posed by a highly concentrated toxic substance entering the environment depends on the pathways available to it, and to what extent the concentration is reduced by the time it reaches receptors.

3. In what **form** is the substance? Whether the substance is in large blocks or tiny particles, or whether it is a liquid or a vapor, **will** be important in determining not only how it might travel, but also how it could contact and enter the body.

4. What are the **chemical and physical characteristics** of the substance? These characteristics determine in what environmental pathways it is likely to move and how rapidly. They include, for example, whether the substance can easily dissolve in water.

5. How is the substance **contained**? If the chemical is in old, rusting containers that can leak, the danger is clearly greater than if the container is solid and appropriate to the substance.

6. What **pathways of exposure** exist? When scientists study the risk in any particular situation, they look at all the ways a contaminant could reach the population at risk and make measurements to see how much of it is moving through each identified path. For example, if the source is near a stream, water samples would be taken at several places to see what level of contamination exists at different distances from the source.

7. Where is the population **located** in relation to the source? Distance is a critical factor. For example, if you are far downstream from a place where toxic waste is entering a waterway, you may have little risk because the substance is so diluted. Closer to the source there might be a high enough concentration to pose a real problem.

8. What are the **characteristics** of people who are at risk? The susceptibility of any individual to a toxic substance varies depending on age, weight, sex, and individual sensitivity.

9. How long does the exposure to the chemical last? Its **duration** is another key factor in determining risk. Are receptors exposed for only a few hours at a high level (such as when a contaminated air plume passes over a home), or at a low level over a number of years (such as when groundwater supplying a well becomes contaminated)?

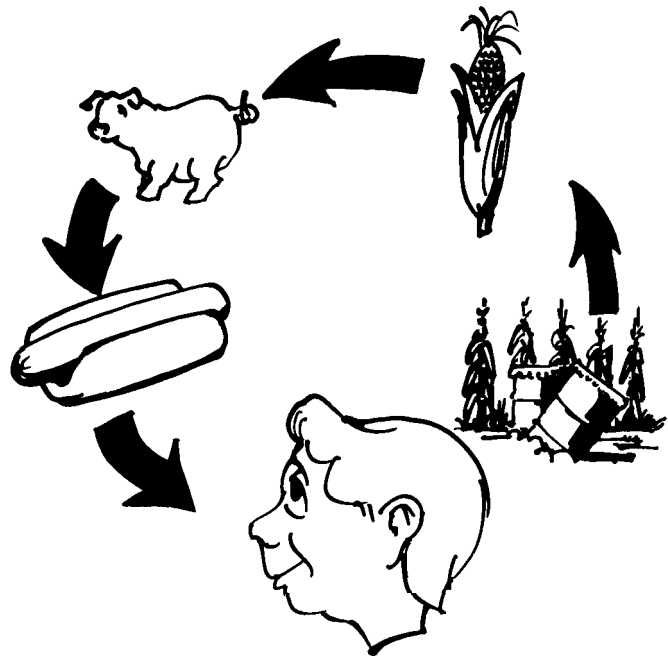

A possible exposure pathway involving the food chain: toxic fumes and particles from a waste dump are carried through the air to a cornfield; corn grown in this field is fed to an animal which is later processed for human consumption.

The analysis of a situation to determine the level of risk inherent in that situation is called **risk assessment**. A risk assessment is conducted by scientists from many different disciplines and uses data about a chemical's effects combined with research into the particular situation to get a clear picture of the risk posed. A decision will then be made as to what action, if any, is needed to remedy the situation. This is called **risk management**.

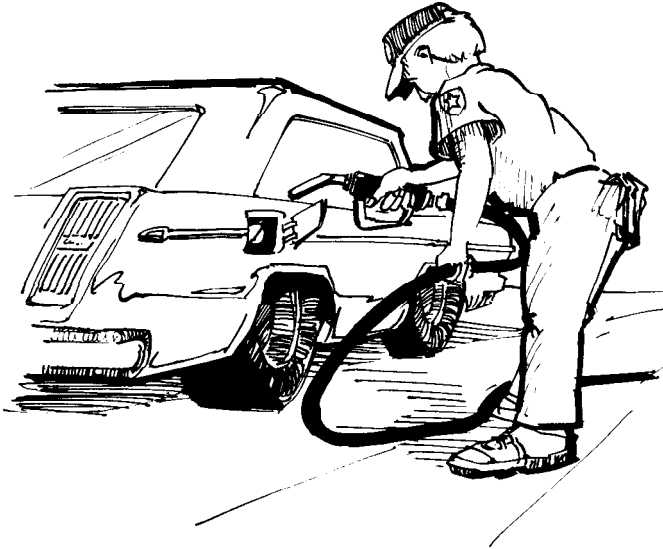

TOXIC MATERIALS IN THE BODY

A poison, or toxic substance, may be defined as **a chemical that, in relatively small amounts, produces injury when it comes in contact with susceptible tissue**. Clearly, the phrase "relatively small amounts" is less than precise, but this uncertainty is necessary because of the wide variance in the amount of each chemical needed to have an effect. A substance is generally not thought of as toxic if it is unreasonable to expect that a person would be exposed to the amount necessary to cause injury. A "susceptible" tissue is defined as that part of the body which is injured after exposure to that particular substance.

Chronic exposure is the exposure to a hazardous substance over a long period of time.

Toxic Effects

We can be overexposed to poisons in either of two ways. The first method is called **acute** exposure, which means that a dose of a chemical enters the body in a short time. For example, if a carpenter spilled furniture stripper in a small area without adequate ventilation and inhaled the vapors, the carpenter would experience acute exposure. If the same carpenter used this stripper regularly and breathed in a little of it eight hours a day for forty years, **chronic** exposure would result. This type of exposure occurs when a person is repeatedly exposed to the same toxic substance over a long period.

Exposure to a toxic substance can produce either immediate or long-term effects. A reaction to a poison can occur at the time of exposure, and might include vomiting, eye irritation, or other symptoms that often may be readily linked to a chemical exposure. These are **immediate** effects.

Long-term effects may occur years after a single serious exposure, or as the result of chronic exposure. These effects are often more difficult to trace to their cause, and can include organ damage, respiratory diseases, and other illnesses.

Certain toxic substances produce their long-term effects by altering the genetic code, or DNA, which tells the body's cells to perform certain activities. Three categories of effects can result from such substances:

1. A **carcinogenic** effect is an increase in an individual's risk of contracting cancer.
2. A **mutagenic** effect is a permanent change in the genetic material (DNA), which may be passed along to later generations.
3. A **teratogenic** effect is an increased risk that a developing embryo will have physical defects.

Determining what level of exposure causes these effects requires laboratory research under controlled conditions. Even then, results must be **extrapolated** from laboratory animals to humans. That is, scientists must make assumptions and apply formulas to decide what their experiments tell them about **human** exposures.

Another way to classify poisons is by their physiological effects. This classification includes the following major groups:

1. **Irritants** are chemicals that inflame living tissue at the site of contact, causing pain and swelling. Household cleaners that contain ammonia produce a gas that irritates the eyes and the mucous membranes of the respiratory tract. Watery eyes and a stinging sensation in the throat will result from exposure to sufficient concentrations of these chemicals over a long enough period.
2. **Asphyxiants** are chemicals that prevent the cells of the individual from receiving life-giving oxygen. Carbon monoxide is a well-known asphyxiant, which chemically "ties up" the hemoglobin in the blood so that the body's metabolism slows and stops.
3. **Central Nervous System (CNS) Depressants** affect the nervous system. This broad category includes vapors from most anesthetic gases, depressants, and organic solvents (a general category that includes most household cleaners as well as many paints, glues, and adhesives). Some CNS depressants produce a feeling of dizziness or giddiness. More severe effects (including death) can also result.
4. **Systemic Toxicants** dramatically affect specific organ systems. For example, mercury vapor, which Victorian hat-makers had to inhale regularly when mercury was used in making hats, causes a serious nervous system disorder which could lead to insanity. (The "Mad Hatter" in Alice in Wonderland suffered from an occupational illness.)

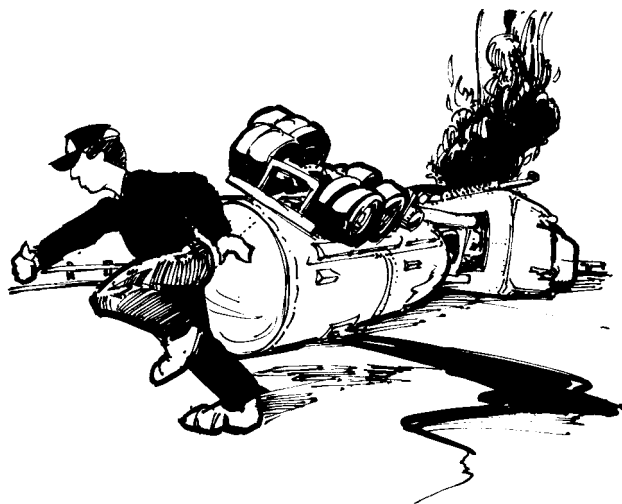

Exposure to a toxic substance over a short period of time—such as in an accident—is known as acute exposure.

Many chemicals can have multiple effects. For example, xylene, commonly used in paint, is both an irritant and a CNS depressant.

Symptoms of toxic exposure include a broad range of reactions: chronic coughs, difficulty in breathing, skin ulcers, diarrhea, irregular heartbeat, headaches, dizziness, chest pain, sore eyes and skin, difficulty in sleeping, lack of appetite, weight loss, nausea, tremors, and many others. However, the same symptoms can result from many other causes as well. Tracing a

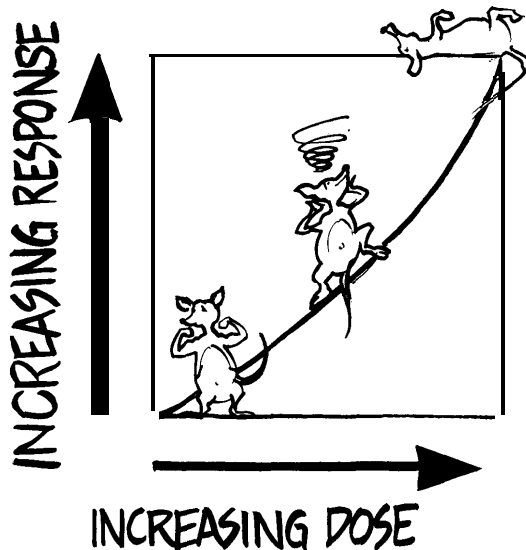

particular reaction to a specific source can be a challenge to even the most experienced environmental toxicologists, allergists, and industrial hygiene specialists. This is further complicated by the fact that many effects are delayed, and are apparent only later in life. The individual experiencing the symptom may no longer live near the original source, or may not even know that the exposure occurred.

Internal Defenses

When the body is exposed to a poison, its internal defenses try to remove the unwanted substances. The primary internal defense is excretion of the contaminant with other wastes in the feces or urine. Prior to excretion, wastes are **filtered**, primarily by the liver and kidneys. As a result, these two organs are both subject to damage from toxic substances, storing in their tissues what they are unable to breakdown. Portions of the lungs contain cilia, which try to remove particles so that they can be coughed out. Particles that are too large or cannot be removed for other reasons sometimes remain as deposits in the lower part of the lungs, where they can cause toxic effects such as fibrosis or cancer.

At low enough exposure levels, a toxic substance will produce no observable harmful effects. As the dose increases, so does the potential for harm. For every substance—even table salt—there is a lethal dose.

Other body defenses against toxic substances are **breathing** and **sweating**. When an intoxicated person has the smell of alcohol on his or her breath, the smell indicates that the body is **exhaling** material it has no use for. **Tears** also remove contaminants that enter the eyes. However, these defenses contribute only a small amount to the body's **detoxification** (that is, its attempt to rid itself of toxic substances).

The body's ability to defend itself against toxic substances varies with the individual. Small children are liable to be more affected by the same amount of a substance than are larger or older persons. Elderly individuals also may have less ability to remove toxicants from the body. Gender can be a factor in toxic responses; for example, some cancers are sex-linked (such as prostate and ovarian cancers). Personal hygiene and the overall health of an individual can also adversely affect the body's ability to process certain toxic substances. For example, a smoker is likely to be much more susceptible to lung cancer if he or she has also been exposed to high levels of radon gas.

Certain people also have allergies to substances that can cause them to react violently, even fatally, to a situation that would pose no apparent risk to another individual. Chemicals that cause strong

allergic reactions in some people are called **sensitizers**. For example, epoxy resins and polyester resins cause many people to have a **sensitivity reaction** and become ill.

Exposure to a poison becomes a problem when the material is of a type that inner defenses cannot breakdown and remove, or when there is more of it than the body can handle. In these instances, **antidotes** are available for a limited number of substances. However, only about 20 antidotes are in existence for the thousands of poisons in the world—and each antidote may work for only a few poisons.

Clearly, the safest barrier to toxic exposure is the **prevention** of exposure. This is why it is so important for the citizen to be aware of the threat posed by hazardous materials in their own home and community, and to learn to minimize or eliminate unnecessary exposure.

STUDIES OF TOXIC EFFECTS

Scientists determine what levels of exposure in human beings will produce observable symptoms by two types of studies.

Epidemiological studies use data on how toxic substances affect human populations. This type of study might compare the number of workers exposed to a certain substance who develop lung cancer to those who develop it in the rest of the population. Other **clinical** studies test the effects of concentrated doses of substances on animals or animal tissue.

A basic principle of research on toxic substances is that the seriousness of the effect a poison has on the body increases as the **dose** increases. Theoretically, there is a **threshold** for exposure to each poison. Beneath the threshold, the dose is so small that no harmful effect will occur. As the dose increases, there is a point at which there is an effect, but the animal can compensate for it by internal healing, and no permanent injury will occur.

Beyond that, there is a dose at which the animal cannot repair itself from the damage and disease results. Finally, at the upper limit of the curve, death occurs.

Death would occur if sufficient quantities of any substance were taken into the body. For example, if a large group of people with similar characteristics ate half a pound of table salt, half of them would probably die. Through experiments, scientists try to establish the particular dosage of chemical (in mass per kilogram of body weight) that will result in the death of half the test animals: that is the **Lethal Dose for 50%** or **LD₅₀**. They also try to establish the point at the other end of the curve at which there is no observable effect from the substance on the animal. This is called the **NOAEL: No Observable Adverse Effect Level**.



Scientists conduct two kinds of studies—epidemiological and clinical—to determine what levels of exposure to a hazardous substance will produce observable symptoms.

Once the LD₅₀ for a substance has been established by repeated experiments with animals, it must be **extrapolated** to determine what the LD₅₀ would be for h-umans. This means adjusting the results to apply to human body weight and similar characteristics. But a toxic substance often has different effects on different species, so tests on animals cannot predict the exact effect that the substance will have on a human population. As a result, scientists are usually quite conservative in their estimates, which means that they assume that the smallest dose that causes an effect in animals will also cause an effect in humans. In addition, scientists study the effect of a substance on human populations wherever statistics are available.



A toxic substance will sometimes combine with another substance to create a new chemical. The potential for harm of this new chemical can be greater or lesser than that of its individual components.

Another uncertainty associated with the LD₅₀ concept is that most LD₅₀ data is gained from acute exposure (single dose) testing rather than by chronic exposure. Extrapolation from these studies is complicated by the fact that chemicals are sometimes distributed differently in the body when the exposure is chronic; for example, a different target organ may be attacked, or the material may be excreted more easily.

Given these uncertainties, it is understandable why there is often considerable debate about what constitutes a "safe" level of exposure. For most substances, agency experts extrapolate conservatively from the NOAEL to set exposure limits for humans. The Occupational Safety and Health Administration (OSHA) uses "Permissible Exposure Limits," or **PELs**, while the American Conference of Government Industrial Hygienists (ACGIH) uses "Threshold Limit Values," or **TLVs**, to define the workroom air concentration that is considered a safe upper limit of exposure. For carcinogens and mutagens, however, there is considered to be no such "safe" exposure limit for regulatory purposes. Every exposure carries some risk.

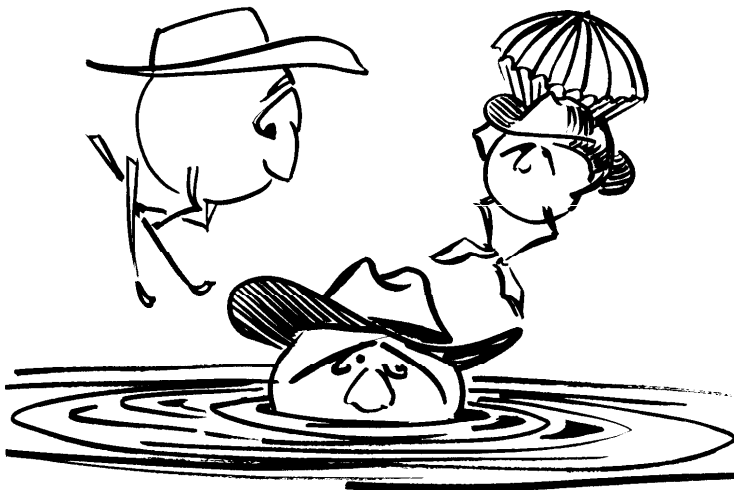

The movement of contaminants within a medium such as air, groundwater, or soil is known as transport.

HAZARDOUS MATERIALS IN THE ENVIRONMENT

Hazardous materials can enter the environment either from a specific source that can be pinpointed, known as a **point source**, or from sources that are more spread out, known as **area sources**. A factory smokestack and the flow of toxic waste from a pipe to a stream are point sources, while the liquid runoff from a field in which pesticides were used is considered an area source.

Contaminants behave differently in the environment depending on

their **physical state**. A solid may stick to surfaces, scatter, or form a dust cloud; a liquid may seep into the ground, flow along the ground, or vaporize and become a gas; a gas will expand and be carried by the wind. Some chemicals are **volatile**, meaning that they evaporate easily. Such a chemical may enter a stream as a liquid but rapidly become an **air** pollution problem.

Non-volatile chemical entering the same stream at the same point may behave quite differently. A **soluble** chemical is one which will dissolve readily in water, and would be carried by the stream. Soluble chemicals tend to be **mobile**, meaning that they will move rapidly in the ground because they can be easily dissolved in groundwater. Another chemical might be more likely to **adsorb** to soil particles, becoming attached to particles' surfaces. Such a chemical would attach to particles in the stream and eventually settle at the bottom. If the chemical were a **persistent** one, which resists breakdown in the environment, it might remain there for some time in the same form, while a less persistent one might be broken down by bacteria. This breakdown is called **biodegradation**, and is an important risk management concept. Sometimes it is possible to **increase** biodegradation so that materials lose their harmful properties more readily.



The process of chemical breakdown, or biodegradation, can cause materials to lose their harmful properties and, in effect, "disappear."

Contaminants enter any of the various **media**—air, groundwater, surface water, or soil—and move as a mass along with the general flow of that medium. This movement of contaminants within a medium is called **transport**. Substances in transport also tend to spread out as they move, becoming diluted to a varying extent by the medium. This generally reduces the concentration, and therefore lowers the level of hazard.

Once a toxic substance is released into a medium, a number of different processes can occur:

1. The substance moves in a pathway determined by its own characteristics, and those of the medium that is carrying it.
2. The substance spreads out or disperses, reducing the level of hazard. This means of reducing risk is not always reliable or consistent, **however**. For **example**, there may be periods of low flow in streams when the volume of water is reduced and less dilution occurs.
3. The material may change chemically or break down into other elements or compounds. Sometimes a contaminant will



Certain chemicals tend to become more highly concentrated as they move through the food chain. This process is known as biomagnification.

SMOOTH AIRFLOW IN STABLE AIR ABOVE MIXING LAYER

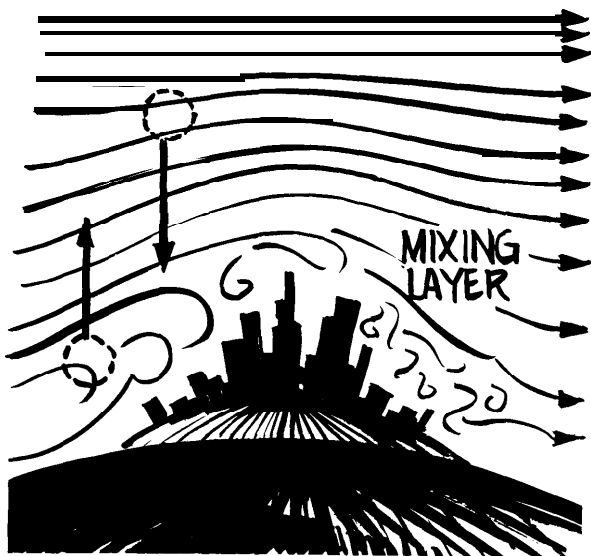

In urban locations, a turbulent "mixing area" of air exists which helps diffuse contaminants. This is due in part to the irregular surfaces of various size buildings and hot and cold spots created by contrasting materials such as concrete and grass.

combine with another substance to become a more dangerous chemical; at other times, it will be rendered less harmful by the encounter. Some chemicals have a **synergetic** effect when they combine that results in a much more dangerous hazard than either would have individually. A chemical may also **potentate**, or increase, the toxicity of another chemical; for example, alcohol potentates the effect of many chlorinated hydrocarbons.

4. A toxic substance may move from one medium to another (for example, evaporating from water into air).
5. Toxic substances can build up in the food chain. Organisms can absorb contaminants such as pesticides in a process known as bioaccumulation. These contaminants are later released into another organism that eats that animal or plant. Certain chemicals also tend to become more concentrated as they move up the food chain. (For example, toxic concentrations may be higher in a bird that ate insects containing poison than in the insects themselves.) This is known as **biomagnification**. Often, an important part of understanding a chemical's risk to humans

is understanding how a particular contaminant will move through a food chain and how each animal or plant in the chain may be affected.

The way a pollutant is **transformed** by chemical reactions and **transported** through the environment is called its **fate**. As we have seen, the fate of chemicals released at the same site may be extremely different.

The Movement of Contaminants in Different Mediums

Hazardous substances move and disperse differently, depending on the medium in which they are deposited. Regulators set standards for exposure in each media separately, trying to take the unique features of each one into account. There are four **transport mediums** in which contaminants travel.

Air

Hazardous chemicals can enter the atmosphere from a point source (such as an industrial stack), or from an area source (such as the evaporation of volatile compounds from hazardous waste sites). A major factor affecting the level of contaminants in the air is the rate of dispersion, which is affected by both weather and **topography** (the shape of the land, including buildings). With a good, strong wind, air pollutants are dispersed more rapidly; when the air is calm, contaminant concentration increases. As a rough

rule of thumb, contaminant levels are halved when wind speed is doubled. (This rule of thumb assumes no effect from topographical features.)

Contaminant levels are also affected by the amount of **vertical mixing** that occurs. Normally, temperature decreases with height; we have all noticed how much colder the air is on top of a high mountain. In urban areas, under such temperature conditions, a turbulent **mixing area** of air exists, characterized by swirls, gusts, updrafts, and downdrafts. This movement is partly attributable to the irregular surfaces of small and tall buildings, and hot and cold spots created by contrasting materials (asphalt or concrete vs. grassy park areas). Polluted air is carried upward and dispersed, while relatively cleaner air moves downward. The net result is that pollutants move up and away from us.

Under weather conditions in which temperature **increases** with height, much less vertical mixing occurs, and pollutants can grow thick in the breathing zone. Such conditions typically occur when a warm air mass moves over a cooler layer of air. In areas with basin-like topography, such as Los Angeles, high-pressure systems can develop in which air above the two-to-three thousand foot level dips and warms, while the air near the earth stays relatively cooler. Hazardous situations called "episodes" can last for days in such areas, often confining persons with respiratory difficulties such as emphysema indoors.

The height of the source can also affect the distribution of pollutants in air. For ground-level releases, the highest concentrations are almost always near the source; for elevated sources such as stacks more than 30 feet above ground, however, the highest concentrations may be further downwind from the source. The size of the particles emitted is also relevant; larger particles are more likely to settle out near the source, while small ones will travel further in the air.

Groundwater

Groundwater, defined as water moving through soil and rock, is a common route for chemical movement. The source of groundwater contamination can include surface **impoundments** in which hazardous materials are disposed or stored, such as ponds and lagoons, leaking underground storage tanks, or any spill where contaminants can seep downward. The type of soil configuration is crucial in groundwater contamination. Some soil layers, such as clay, are harder for contaminants to move through (less permeable) and can protect the underlying groundwater.

While contaminants in rivers or streams are generally churned and

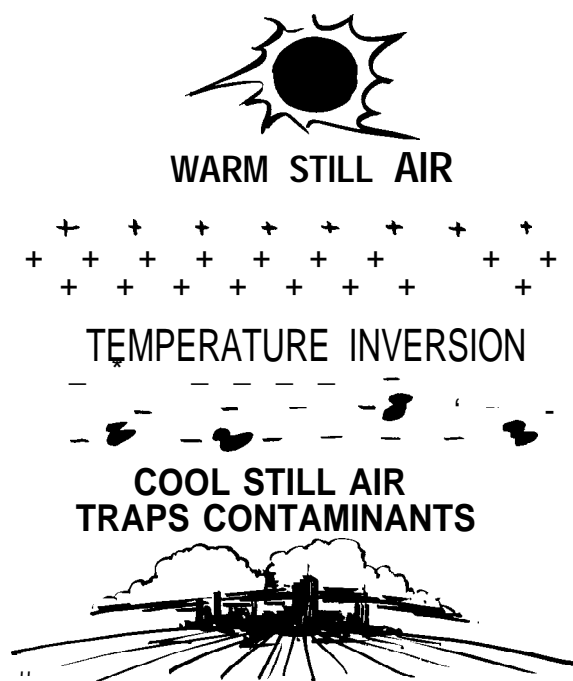

Under certain weather conditions, a "temperature inversion" can occur which traps contaminants and can promote unusually high levels of exposure.

diluted by movement as they are in the air, contaminants can move great distances in groundwater without dilution. Also, chemicals in the groundwater last longer; chemicals cannot evaporate, and they resist breakdown in the absence of air and light. It is difficult and sometimes impossible to purify contaminated groundwater.

Surface Water

Surface water includes oceans, rivers, lakes, streams, or any above-ground water. It may be contaminated by industrial and sewage discharge pipes, chemical spills, or hazardous waste landfills.

The concentration of chemicals in surface water depends on the amount of the substance entering the water, its properties, and the water's rate of flow. Chemicals that are heavier than water, which include PCBS and dioxin, settle out in the sediment at the bottom and can remain there for long periods, while lighter chemicals will flow with the stream. Exposure to light, oxygen, and organisms will break down some chemicals; others, such as metals, are **persistent** and do not break down easily. Substances that are persistent may be transported to estuaries (areas where rivers meet oceans) and accumulate in shellfish and fish,

Soil

Soil may become contaminated through dumping, spills, and other sources. Rainwater leaches some contaminants from the soil and

carries them to the groundwater; other contaminants remain near the surface, where they can affect human health by entering the food chain (ingestion), emitting toxic vapors (inhalation), or rubbing onto the skin of children playing in the dirt (dermal absorption). Because contaminated soil is a basic contaminant medium which affects other media, it is of considerable importance.

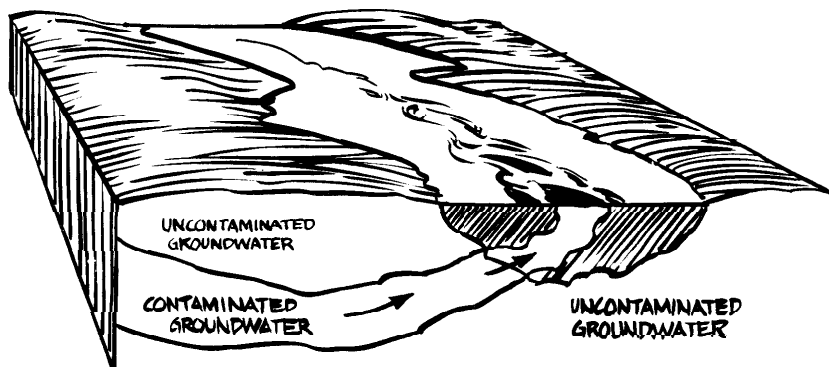

Surface water generally dilutes contaminants as it moves; they tend to break down as they contact air and light. Contaminants resist breakdown in groundwater and do not disperse readily because there is nowhere to go.

Once a contaminant has gained a foothold in one medium, it may be released into others as well. Whether this happens or not depends on the contaminant's characteristics and pathways available in the environment. Contaminants evaporate from the soil or water and enter the air through **volatilization**. Contaminants can also **leach** from the soil and enter water, or be blown by the **wind** and become airborne particles. When it rains, contaminated **runoff** from the soil can enter a stream. Therefore, it is impossible to simply place a chemical in one medium and forget about it. Careful thought must be given to how it may be released into other media.

SUMMARY

While we often associate our hazardous materials problems with industry, naturally occurring toxic substances, products used in average households, and automobiles all contribute to our country's challenge. Materials may be considered hazardous for different reasons—for example, some are liable to explode or burst into flame easily, while others can poison us. Poisons can enter our bodies by absorption, ingestion, inhalation, or injection, through various environmental pathways in different mediums.

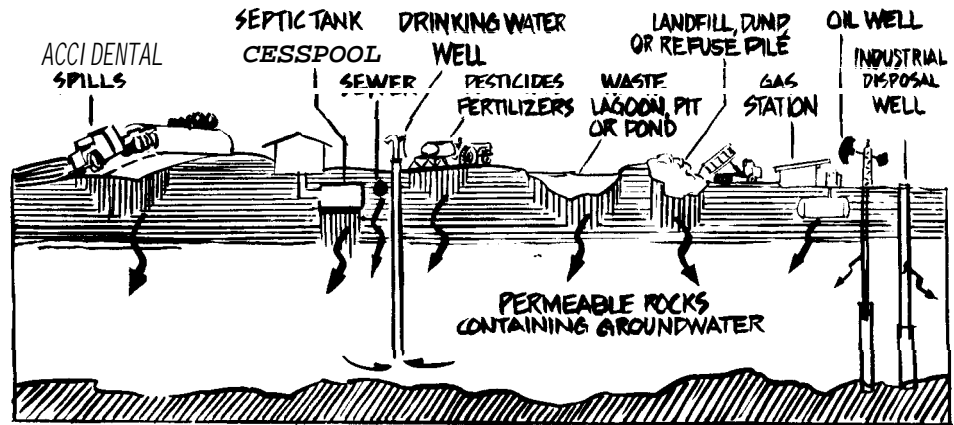

Predicting how much of a substance will actually reach us from a particular source is complicated. Chemicals often follow complex pathways through the environment, leaving one medium to enter another, and being transformed and transported in different ways by each medium. They may either disperse harmlessly or become concentrated as they move through the food chain.

Numerous sources contribute to groundwater contamination. Because groundwater is a source of drinking water for half the Nation's population, and because it is so hard to clean up, protecting this resource from contamination is a major concern.

While our bodies have many internal defenses against poisons, these defenses can be overwhelmed. Whether we are exposed to chemicals all at once or gradually over time, we can reach a threshold at which harmful effects are noticeable—sometimes years after our first exposure. To ensure our health and safety, we should take reasonable precautions to limit our potential exposure to hazardous substances. ■

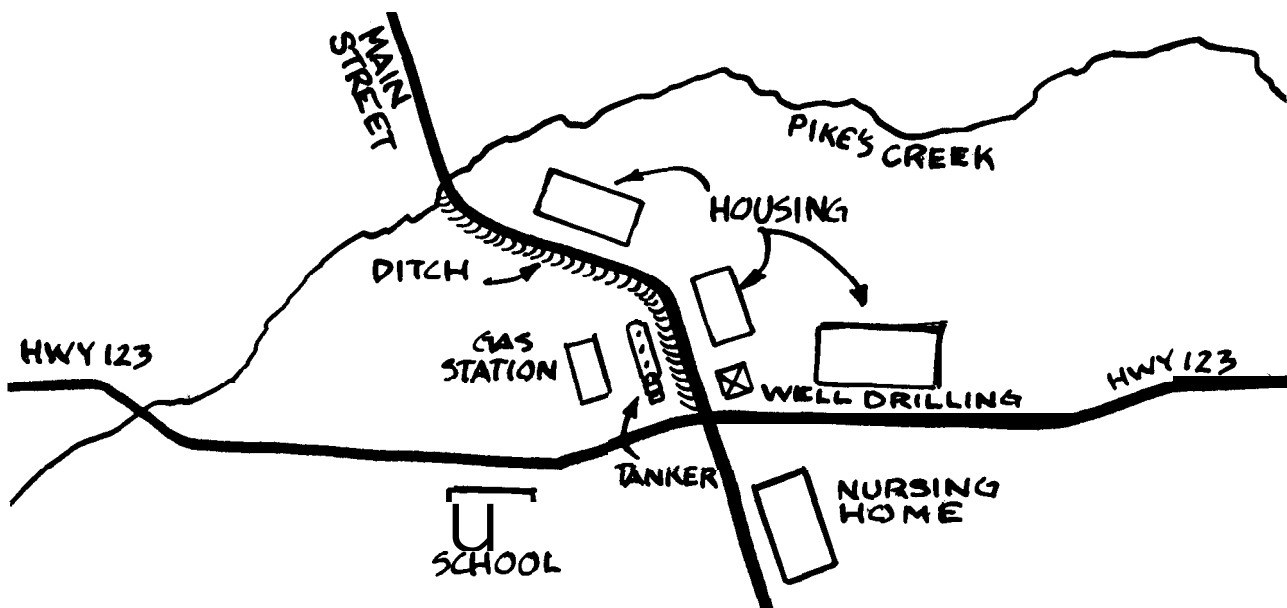

HAZ MAT TEASER
(answers on page A-1)

The driver of a gasoline tanker unloading at a local service station leaves his truck unattended for a short period of time. When the driver returns to his truck, he finds that the service station's underground storage tank has overflowed and more than 1,000 gallons of gasoline are covering the ground and flowing down the street.

A strong odor of gasoline covers the entire spill area and extends downwind for several blocks. People who live downwind of the incident notice the gasoline odor and become concerned: a well driller in the area reports the odor to the local 911 dispatch center, a nursing home in the area starts to move patients inside from an outdoor recreation yard, and teachers from a nearby elementary school begin to bring students indoors from recess. The driver of the tanker works furiously to shut off the truck's delivery valves to halt the overflow; in the process, his pants and shoes become drenched with gasoline. Down the street from the service station, the gasoline is running into a roadside drainage ditch and soaking into the ground. Some of the product has also reached a small stream that flows through the area.

1. How would you assess the risk from this incident? What are some of the things to take into account when making your risk assessment?

CHECK YOUR MEMORY
(answers on page A-4)

1. While spraying pesticides, a farmer wears long pants, a long-sleeved shirt, and gloves. The farmer is trying to prevent contaminants from entering the body by:
 - a. Dermal absorption
 - b. Injection
 - c. Ingestion
 - d. Inhalation

2. Midnight dumpers have been leaving toxic waste in an illegal dump site in the woods. The soil beneath the waste is highly porous. A nearby house has a well which taps into this porous soil. Based on this limited information, through what **medium** is the well most likely to become contaminated?
 - a. Soil
 - b. Air
 - c. Surface water
 - d. Groundwater

3. You spill a toxic substance; you cough, and your eyes water. You are experiencing what type of exposure?
 - a. Acute
 - b. Chronic

4. You have just learned that a chemical you work with is a **teratogen**. What effect does this chemical have?
 - a. Increases the risk of cancer
 - b. Increases the risk of physical defects in a developing embryo
 - c. Causes a permanent change in the genetic material (DNA)
 - d. Irritates the lining of the throat

5. When you are about to have a serious operation, the anesthetist is likely to use a substance which is:
 - a. A CNS (central nervous system) depressant
 - b. An irritant
 - c. An asphyxiant
 - d. A corrosive

6. Which of these groups would be likely to have the **most extreme reaction** to most types of toxic exposure?
 - a. Adult women
 - b. Adult men
 - c. Children
 - d. Adolescents

7. Groundwater is **least** likely to be contaminated under what circumstances?
 - a. The waste is confined by an aged underground storage tank
 - b. The groundwater is protected by a relatively impermeable protective layer, such as clay
 - c. The contaminants are persistent
 - d. The contaminants are highly soluble

Unit 2:

HAZARDOUS MATERIALS REGULATION

In this unit, you will learn about:

- The major U.S. laws pertaining to hazardous materials management
- Responsibilities of the key Federal agencies
- Title III of the 1986 Superfund Reauthorization Act, known as the "Emergency Planning and Community Right-to-Know Act"
- The roles of Federal, State, and local governments, as well as industry
- How to use legislation to protect yourself from hazardous materials

HAZARDOUS MATERIALS LEGISLATION

There are a number of Federal laws that regulate hazardous materials. The following is a brief overview of the major pieces of legislation that comprise our country's hazardous materials management policies and programs.

Superfund Amendments and Reauthorization Act of 1986 (SARA)

In 1980, Congress passed the Comprehensive Emergency Response, Compensation, and Liability Act, known as CERCLA. The bill's purpose was to fund cleanups and emergency response actions for some of the worst inactive or abandoned hazardous waste sites scattered across the country. A billion dollar revolving trust fund—financed primarily by a tax on certain chemical and petroleum products—was created to pay for Federal and State response actions when hazardous substances pose an existing or potential threat to human health or the environment.

In 1986, this bill was revised and expanded in the Superfund Amendments and Reauthorization Act of 1986 (SARA). The third part of SARA, Title III, is known as the Emergency Planning and Community Right-to-Know Act of 1986. This portion of the legislation makes over three hundred "extremely hazardous substances" subject to routine and detailed reporting to designated local, State, and Federal government agencies. It also requires local planning committees to use this information

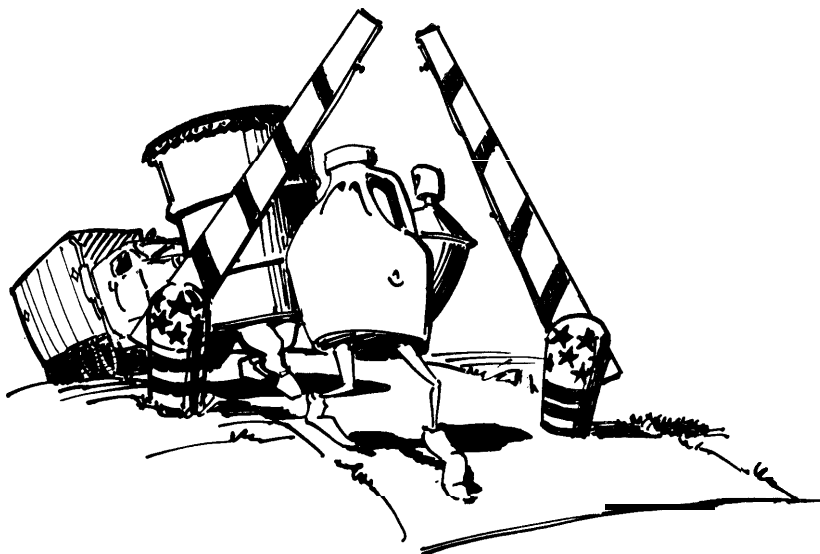

There are a number of Federal laws that regulate hazardous materials.

(and other data on local hazards) to create effective plans for hazardous materials emergencies.

The National Oil and Hazardous Substance Pollution Contingency Plan (NCP)

The National Contingency Plan is the basis for Federal action to minimize pollution damage from discharges of oil or hazardous substances. In accordance with this law, Federal agencies assist in the development and evaluation of National, Regional, and local oil and hazardous substance pollution contingency plans. This coordinated planning enables communities to prevent or lessen the harm that could accompany a hazardous materials release.

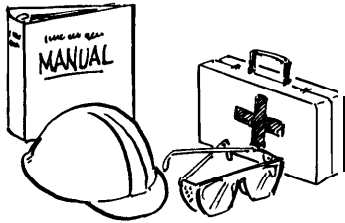

The Occupational Safety and Health Administration (OSHA) sets standards to protect workers from preventable accidents resulting from chemical use at the workplace.

Working together as part of the National Response Team—composed of 14 Federal agencies—experts publish guidance on emergency response planning and stand ready to assist States in the event of a major chemical emergency. As co-chairs of the National Response Team, EPA and the U.S. Coast Guard play key roles in environmental protection. The two agencies share specific responsibility for waterway protection, EPA having primary responsibility for most **inland** waters and the Coast Guard handling responsibility for **coastal** waters and some specifically designated Federal navigable waterways such as Lake Michigan.

The NCP covers how to identify and investigate hazardous waste sites that could potentially pose such a serious threat to public health that the situation would be considered an emergency. It also specifies how to analyze costs and evaluate the best cleanup options, and details roles and responsibilities for Federal, State, and local governments in carrying out these requirements.

The Resource Conservation and Recovery Act of 1976 (RCRA)

This law, administered by EPA, establishes a Federal program to provide comprehensive regulation of hazardous waste, which includes certain materials held to pose a potential threat to public health and safety when they are discarded. RCRA regulations provide and maintain a hazardous waste management system that covers the generation, transportation, use, and disposal of such waste (sometimes summarized as regulation from “cradle to grave”). Major control mechanisms include a manifest system to track hazardous waste shipments and a permit system requiring waste site owners and operators to comply with specified safety standards. While RCRA primarily regulates safety precautions at hazardous waste facilities in operation today, it also has strong provisions potentially relevant to cleanup if any part of a facility was in operation during the 1980s.

The Hazardous Materials Transportation Act (HMTA)

The Department of Transportation (DOT) has the authority to

regulate the handling and interstate transportation of hazardous materials. More specifically, DOT's Office of Hazardous Materials Transportation (OHMT) **issues** regulations dealing with the shipping and packaging of hazardous materials, including how they are classified and **labelled** (both Nationally and internationally). While the law enables DOT to regulate any traffic that "affects" interstate or foreign commerce, the agency has chosen to regulate only shipments of carriers engaged in interstate commerce, leaving the States themselves to regulate shipments by carriers that do not cross State lines.

The Occupational Safety and Health Act (OSHA)

Enacted in 1970, the purpose of this law is to assure, so far as possible, "safe working conditions" to "every working man in the country." This is accomplished by the issuing of basic safety and health standards, assigning OSHA employees to inspect workplaces, and forcing industry to reduce or eliminate job hazards by imposing fines for identified violations.

The Occupational Safety and Health Administration (OSHA) sets standards for worker exposure to hazardous substances and requires that such substances bear warning labels. It also mandates that employees be given training and other information on dangers posed by chemicals, and be given instruction as to how to use these chemicals safely. OSHA has the authority to inspect a workplace to determine whether it is in compliance with these regulations. In current practice, only a worker complaint or high worker injury rates as shown in company records will trigger an actual inspection.

Under SARA, the Secretary of Labor was directed to issue a final standard to protect the health and safety of employees engaged in hazardous waste operations. In 1989, OSHA issued this rule on Hazardous Waste Operations and Emergency Response, which represents the first comprehensive approach to protecting public and private sector employees involved in the dangerous business of handling hazardous waste materials. Many of the workers affected by this rule are employees of State and local governments. Twenty-five States and Territories have their own job safety and health programs. Their standards are required to be at least as stringent as the Federal regulation.

The Toxic Substances Control Act (TSCA)

This legislation was passed in 1976 to reduce the threat from **new** chemicals that "present or will present an unreasonable risk of injury to health or the environment." As a result, chemical producers are required to research the effects of new chemicals and notify EPA before they are manufactured. EPA has the authority to ban or restrict chemical uses if there is sufficient evidence that the substance poses an "unreasonable risk."

Pesticides Legislation

Both the Federal Insecticide, Fungicide and Rodenticide Act (FIFRA) and the Federal Food, Drug and Cosmetic Act (FFDCA) regulate pesticides. Originally requiring mere registration of pesticides, FIFRA was amended in 1972 to require testing for short-term and long-term toxic effects prior to registration. For pesticides used on food crops, EPA establishes an upper limit on the amount of residue that can remain on food based on human tolerance levels. The FFDCA requires the Food and Drug Administration (FDA) to enforce these residue limits by monitoring and seizing foods whose residues are in excess of these standards.



The Federal Emergency Management Agency (FEMA) carries the primary responsibility for planning, preparedness, and related training for hazardous materials emergency management.

The Clean Air Act (CAA)

This act, passed in 1970, is the basic Federal law for controlling toxic air pollution. It requires EPA to keep an up-to-date list of industrial pollutants that are

hazardous to human health, and set an emission standard for each "with an ample margin of safety." Under the law, EPA prepares minimum pollution standards, and States prepare implementation plans showing how these standards will be attained. States issue permits for the release of listed pollutants into the atmosphere, and take samples to evaluate the State's air quality. Of the 320 toxic air pollutants named in the act, EPA has to date completed regulations governing only 7, in large part because industry protests have resulted in legal precedents requiring costly and lengthy scientific studies to show that a pollutant has harmful effects at a certain level.

The Clean Water Act (CWA)

Originally enacted in 1972, this act envisioned swimmable waters by 1983 and pollution discharges halted by 1985. Obviously, these goals were not accomplished. The law continues to promote clean water by supporting construction of sewage treatment facilities (which are currently bearing a heavy burden in processing pollutants); supporting the preparation of water quality plans encompassing the entire Nation; and setting up a permit system restricting the amount and type of pollutants that can be discharged into the Nation's waterways. Modest fines may be imposed for illegal spills. The law is primarily designed to address point sources of pollution, paying far less attention to non-point sources such as agricultural runoff (currently estimated to be responsible for 65% of stream pollution).

The Safe Drinking Water Act

This act is specifically designed to protect public water supplies from contamination by mandating water testing, denying Federal funds to projects that threaten critical water supplies, and requiring States to submit plans to protect public wells from contamination.

The law also has a "Right to Know" provision in which the public must be informed if certain contaminants are present in drinking water above specified levels.

RESPONSIBILITIES OF KEY FEDERAL AGENCIES

The Federal Emergency Management Agency

The Federal Emergency Management Agency (FEMA) is responsible for coordinating all civil emergency planning, management, mitigation, and assistance functions of the Federal Government. Under SARA's Title III, FEMA is the primary Federal agency responsible for planning and related training for hazardous materials emergency management. This authority encompasses accidents at manufacturing, processing, storage, and disposal facilities, as well as hazardous materials in transit by highways, on water, by rail, and by air.

FEMA provides resource information, technical and financial assistance to States for developing emergency plans for hazardous materials accidents and other types of emergencies, and assists State and local governments in hazardous materials training. FEMA also assists States and communities by interpreting Federal planning guidance, providing advice on plan preparation, and reviewing completed plans. FEMA Regional staff are available to provide this support. When emergency exercises are conducted, FEMA Regional officials provide support by reviewing the plans, observing exercises to test the plans, and providing technical evaluation of how well the plans worked.

Finally, FEMA is available to provide additional financial relief in the event of an incident so serious that both local and State funds prove inadequate.

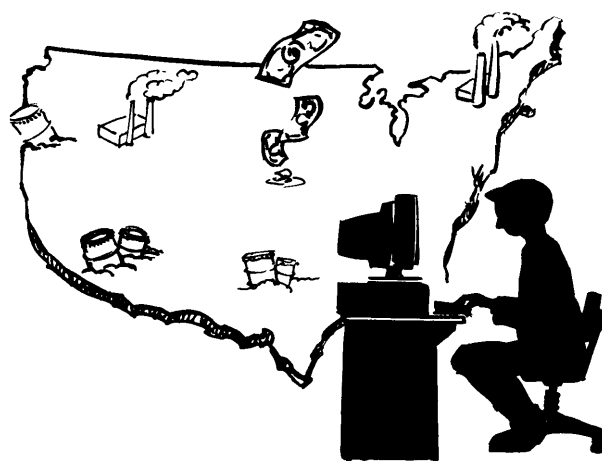

The Environmental Protection Agency

The primary mission of the Environmental Protection Agency (EPA) is to protect and enhance our environment. EPA is the lead agency responsible for carrying out Title III reporting requirements. Under Superfund and other related laws, it is the agency primarily responsible for hazardous waste site operations and Superfund site cleanup activities. EPA also conducts technical and environmental training programs related to hazardous materials, and chairs the 14-agency National Response Team (NRT). At the request of community officials, EPA can provide technical expertise on the full range of environmental contamination issues.

The Environmental Protection Agency (EPA) is responsible for monitoring hazardous waste site operations and cleanup activities, and has the lead responsibility for many Title III activities.

The Department of Transportation

The Department of Transportation (DOT) establishes the Nation's overall transportation policy. It bears the primary responsibility for

issuing standards and regulations relating to the transportation of hazardous materials from State to State nationwide. (Hazardous materials which are transported only **within** a State's borders are regulated by State law.) DOT is heavily involved in identifying safer modes of hazardous materials transport, and has significant regulatory, research and development, and training functions in this area. DOT trains and inspects carriers and shippers of hazardous materials to ensure that they are in full compliance with regulatory guidelines.

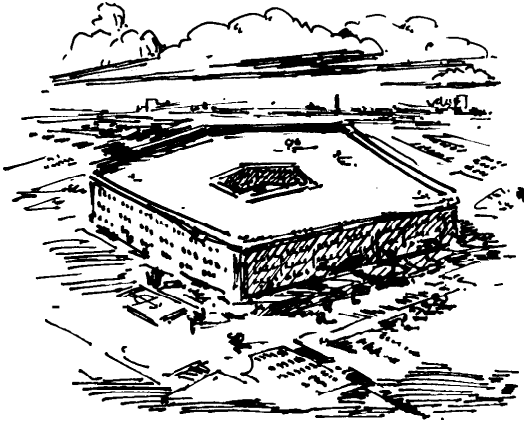

*The Department of Defense (DOD) manufactures, tests, and discards the full range of hazardous materials. Military installations are **also** a potential source of expertise on hazardous materials for local governments.*

The Department of Energy

The Department of Energy (DOE) provides the framework for a comprehensive and balanced National energy plan through the coordination and administration of the energy functions of the Federal government. Its primary responsibilities in the hazardous materials arena involve radioactive waste generated by the nuclear weapons program or by nuclear reactors which supply energy. DOE provides assistance in the removal and

disposal of radioactive contamination, as well as in identifying the source and extent of radioactive releases. In addition, DOE conducts hazardous materials training workshops throughout the country.

The Department of Defense

The Department of Defense (DOD) is responsible for maintaining manpower, equipment, and other resources for potential use in military conflict. DOD manufactures, stores, and discards the full range of hazardous materials, and is also one of the Nation's largest shippers of such materials. The Agency also conducts hazardous materials courses at five military installations, primarily for military personnel responsible for the handling and control of such substances. DOD laboratories and bases can be a source of expertise, equipment, and supplies for use in local chemical emergencies.

The Department of Labor

The purpose of the Department of Labor is to foster, promote, and develop the welfare of the wage earners of the United States, to improve their working conditions, and to advance their opportunities for profitable employment in carrying out this mission.

The Department's Occupational Safety and Health Administration (OSHA) is responsible for establishing rules and standards to ensure that occupational environments are safe for workers. As part of this function, OSHA regulates employee safety and health at hazardous waste operations, in work environments where hazardous materials are present (primarily chemical industries), or during emergency response to incidents involving hazardous materials.

THE EMERGENCY PLANNING AND COMMUNITY RIGHT-TO-KNOW ACT (TITLE III)

What is Title III?

On October 17, 1986, the Superfund Amendments and Reauthorization Act of 1986, also known as SARA, was signed into law. The third part of SARA is Title III: the Emergency Planning and Community Right-to-Know Act. Prior to this law, citizens had little or no legal backing in their attempts to obtain information about toxic releases from facilities in their own communities. As the public and its Congressional representatives became more aware of the increasing use of hazardous materials and the corresponding increase in the number of accidents, pressure grew for better information at the local level.

The single incident that is credited with raising the level of concern to the point that such a law could be passed occurred in **Bhopal**, India, where a release of methyl isocyanate killed at least 1,700 people and injured thousands more. To help reduce the likelihood that such a tragedy would occur in the United States, and simultaneously increase a local government's ability to anticipate and plan for such a major emergency if one were to occur, Title III seeks to provide reliable information to those who would be most affected by an accidental release of this kind: the communities located in the immediate area of industrial plants.

As used in SARA, the term "hazardous materials" refers to substances transported, used, and stored at petroleum refineries and natural gas facilities; hazardous chemicals such as PCBs and trichloroethylene (dry cleaning chemicals); acutely toxic chemicals; and fumes and dust from metals such as arsenic, lead, and cadmium. For the first time, the law even requires the agricultural industry to report production, use, storage, or release of certain chemicals. EPA maintains an updated list that includes over 300 extremely hazardous substances (EHS), selected on the basis of their ability to pose an **immediate** threat to life and health. These EHS chemicals have been involved in some of the most serious accidents that have occurred in the U.S. to date.



The Department of Transportation (DOT) regulates interstate hazardous materials transport, training carriers and shippers to comply with the law.

Title III establishes requirements for Federal, State, and local governments and industry regarding local emergency planning and reporting on hazardous materials. It also provides a comprehensive framework within which Federal, State, and local governments can work together with industry to reduce risks.

Title III has four major sections:

- Emergency planning
- Emergency notification

- Community right-to-know reporting requirements
- Toxic chemicals release and emissions reporting

The four sections of Title III will be discussed in turn.

1. Emergency Planning

Title III requires that the governor of each State designate a State Emergency Response Commission (SERC). This commission generally includes representatives of public agencies and departments with expertise in environmental issues, natural resources, emergency services, public health, occupational safety, and transportation. Various public and private sector groups and associations with an interest in Title III issues may also be included in the State commission.

The SERC designates local emergency planning districts and appoints Local Emergency Planning Committees (LEPCs) within each of these districts. The SERC is responsible for supervising and coordinating the activities of the Local Emergency Planning

Committees, for establishing procedures for receiving and processing public requests for information collected under other sections of Title III, and for reviewing plans generated by the LEPCs.

Each Local Emergency Planning Committee is expected to include elected State and local officials; police, fire, civil defense, public health, environmental, hospital, and transportation officials; representatives of facilities subject to the emergency planning requirements; community groups; and the media. Public notice is given of meetings and activities, and procedures are established for handling public requests for information. Citizens who want to help their community prevent and plan for hazardous materials emergencies should contact the LEPC.

The LEPC's primary responsibility is to develop a local emergency response plan. The target date for completion of the emergency response plan was October 17, 1988; however, many LEPCs have not yet completed final plans at the time of this writing. In developing their plans, local committees analyze local risks and evaluate resources available to their area that could help them to prepare for and respond to a hazardous materials accident. A progressive LEPC may also consider strategies for **preventing** or **mitigating** chemical emergencies—that is, identifying ways to keep emergencies from happening, or of making their consequences less severe.

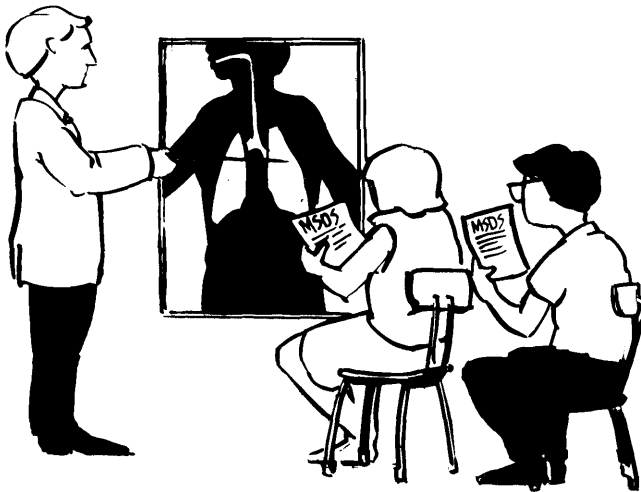

The Occupational Safety and Health Administration (OSHA) establishes rules and standards designed to ensure safe working environments for the Nation's employees.

Examples of this include the installation of sprinklers in a chemical plant, or the routing of certain hazardous materials carriers away from residential areas.

The contingency plan generated by the LEPC must include a list of hazardous materials facilities and the routes they use to transport listed materials, emergency response procedures, and evacuation plans. It is reviewed by the SERC and updated annually by the LEPC. Emergency plans must focus on the list of extremely hazardous substances published by the EPA (but are not limited to this list). Any facility that uses these substances in excess of specified "threshold" quantities is subject to emergency planning requirements.

2. Emergency Notification

This section of Title III requires an industry to notify the Local Emergency Planning Committee, the State, and the National Response Center if there is a release of a listed hazardous substance that exceeds a certain quantity, as specified in the November 17, 1986 issue of the *Federal Register*.

The emergency notification must include the name of the chemical released, the quantity involved, how and into what it was released, and the health risks from exposure. This section of Title III also requires industry to submit reports to the State and LEPC after the event that explain what actions were taken to control the release, and provide more data on health risks and any medical attention required for victims.

This part of the law will allow communities to learn if significant releases from hazardous materials facilities are occurring or are likely to occur, and whether state-of-the-art technology is being used by the plants to protect nearby communities from unnecessary adverse health effects.

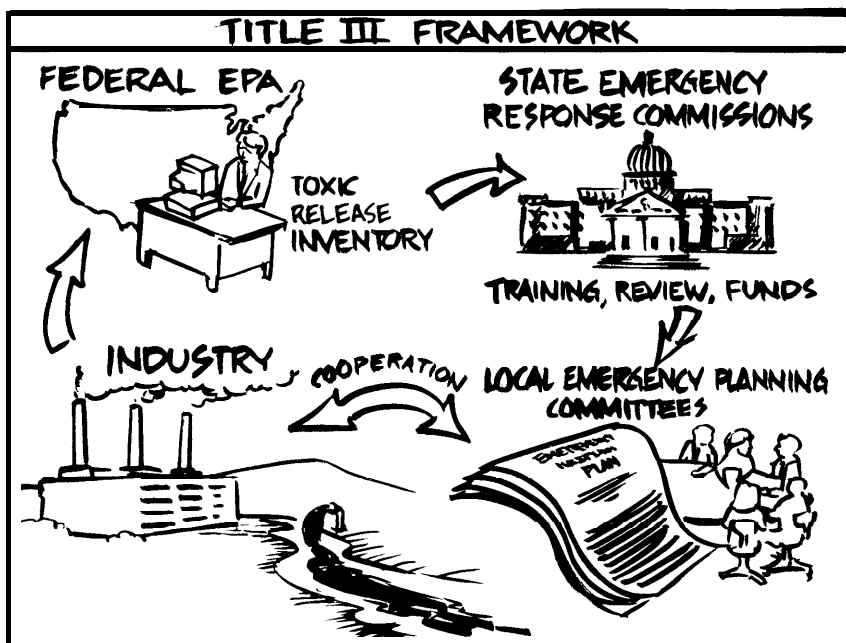

Title III of the Superfund Amendments and Reauthorization Act of 1986 (SARA) provides a framework for Federal, State, and local governments to work with industry to reduce hazardous materials risks and develop comprehensive emergency response plans.

3. Community Right-to-Know Reporting Requirements

This is a particularly important part of Title II 1, because it grants citizens the **right** to obtain information on hazardous materials in their community. Environmental, health, and labor groups have worked hard for passage of this law.

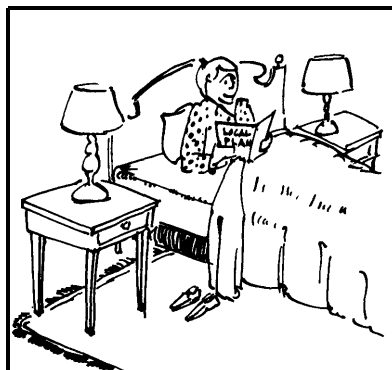

*As a citizen, you should have a **basic** awareness of the procedures spelled out in your local plan for protecting public safety in the event of a hazardous materials incident. How would you be told that an incident had occurred, for example? Are you near an area **where** an incident is considered more probable than at other locations?*

This section of Title III requires facilities to submit **either** a form called a Material Safety Data Sheet (**MSDS**) **or** lists of certain hazardous chemicals on sites in amounts over threshold quantities to the LEPC, the **SERC**, and the local fire department. MSDS formats vary considerably among providers, but all include vital information about the properties and effects of the hazardous material involved. Industry facilities must also submit inventories of the amounts and locations of these chemicals in their plants. OSHA and EPA rules specify which chemicals must be reported and at what quantity.

4. Toxic Chemical Release and Emissions Inventory Reporting

This section of Title III requires hazardous materials facilities to inform the public about routine, day-to-day releases of chemicals. The intent is to provide information on the extent of the cumulative toxic chemical burden on the environment.

Over 300 chemicals listed by EPA must be reported if they are emitted regularly. Facilities must submit toxic chemical release forms for these chemicals. This requirement applies to facilities that have 10 or more full-time employees and that are in certain types of specified industries. Facilities that use less than 10,000 pounds of a listed chemical each year are currently exempted.

How to Use Title III Legislation to Protect Yourself from Hazardous Materials

The Emergency Planning and Community Right-to-Know Act (Title III of SARA) was written with concern for the individual citizen. It is based on the principle that the more you and your neighbors know about hazardous materials in your community, the more effective your community can be in improving public safety. The law requires industry to make information available on potential chemical hazards. There are several ways you can become involved in obtaining and using this information to protect yourself from hazardous materials.

- Make sure that your Local Emergency Planning Committee (LEPC) has been formed, and attend its meetings. Make sure it addresses **your** concerns by volunteering to serve on it as a citizen representative. Information on your LEPC may be obtained by calling your **SERC**, county health department, fire department, or emergency management agency.
- Review and comment on the emergency response plan, and ask questions about how the emergency procedures affect you, your family, and your place of business.
- Ask for information from your LEPC or SERC about hazardous materials in your community. Ask your LEPC what local facilities are doing to reduce the dangers from these materials.

- Use the National Toxic Release Inventory database to obtain information on routine releases of toxic chemicals in your community. If your LEPC **does** not have this information, you or your LEPC can get it from a library, the **SERC**, or the EPA Reporting Center in Washington, **D.C.** If you have a home computer and a modem, you can access the National database on the National Library of Medicine's computer system for a nominal fee. (For additional information on accessible computer databases, see "Computer Networks Open to the Public" in the Resources section later in this course.)
- Call or visit facilities in your area and ask their safety officers if they have complied with the reporting requirements.

REDUCING RISKS FROM HAZARDOUS MATERIALS RELEASES

Federal Role

The Federal role in reducing public risk from exposure to hazardous materials includes technical guidance, legislated standards and procedures, and providing States access to data about chemical releases and training. The Federal Emergency Management Agency (FEMA) has the lead role for coordinating civil emergency response planning and disaster response. FEMA's hazardous materials program is largely one of providing guidance, technical assistance, information, and training. For Title III reporting and enforcement activities, EPA is the key Federal agency: it maintains the National toxic chemical inventory, publishes regulations concerning hazardous materials, reports on the status of various emergency systems, conducts training, and assists citizens with hazardous materials site identification and investigation.

State Role

Under Title III, each State governor must appoint a State Emergency Response Commission (**SERC**). These commissions provide leadership to ensure that an emergency planning and implementation structure is developed at the local level, and review plans developed by communities. In addition, the SERCS provide training and technical assistance to local communities. In the case of an emergency which is too expensive for a local community to handle, the State may contribute resources. In general, the burden of funding for training and information management for Title III **recordkeeping** falls at the State and local level.

States may, of course, elect to exceed Federal requirements for hazardous materials management. For example, over 30 States have enacted Right-to-Know laws similar to the Federal one, some of which cover more chemicals and more potentially hazardous situations.

Federal controls on operating hazardous materials waste



Many communities regulate hazardous materials traffic to try to reduce injuries and property loss that could result from an accident.

treatment, storage, and disposal facilities contain many exceptions. States have added specific requirements to address these “loopholes” and increase their protection from particular hazards. For example, California prohibits discharge from an underground injection well if it is within one-half mile of a drinking water supply. States have broad authority to control how hazardous materials are stored, used, transported, and disposed of within their borders. For instance, States establish zoning control policies that determine where chemical plants may be located, and control siting for hazardous waste facilities and landfills. Pennsylvania and Connecticut currently have laws that deny permits to companies found in violation of environmental protection laws. Regulating transportation of hazardous materials within State borders is also a State responsibility.

Local Role

Local communities play a key role in the system setup by Congress under Title III to inform and protect citizens from hazardous materials. Local communities, represented by Local Emergency Planning Committees (LEPCs), are responsible for developing an emergency plan for disasters involving hazardous substances. This includes identifying the resources that would be available in an emergency (such as trained personnel and specialized equipment) and ensuring planning coordination among responding groups. The LEPC also collects and stores information from hazardous materials facilities, and makes that information available to the public.

Local officials have the lead role in responding to hazardous materials emergencies; usually, management of incidents is the specific responsibility of the local fire department. Communities also regulate the disposal of hazardous waste, and inspect hazardous materials storage areas for violations of local codes. Many communities regulate hazardous materials traffic through specific zoning requirements.

The Role of Industry

Under Title III, facilities that use hazardous materials are responsible for complying with packaging, labelling, storage, transportation, and workplace safety regulations. Additionally, industry is required to furnish information about the quantities and health effects of materials used at the plant, and promptly notify local and State officials whenever a significant release of hazardous materials occurs. Small businesses and farmers are also included under the Title III umbrella if they use “extremely hazardous substances” in reportable quantities, as set in EPA rulemaking for the EHS list.

The Chemical Manufacturers Association (CMA) has set up a voluntary, industry-wide **Community Awareness and Emergency Response program (CAER)**. This program

encourages plant managers to listen to community concerns, participate in planning, and explain their plant's operations and policies. Byworking with the community to ensure safe handling, storage, transportation, and disposal of dangerous chemicals, industry can protect itself as well as the public from the high costs of chemical accidents.

WHEN THE LAWS ARE NOT OBEYED

If you believe a problem exists in your community that should be addressed by an existing law, begin with research on the law and its specific provisions, working through the responsible government agency. (For fixed sites, your first stop is always your LEPC.) Many Federal and State agencies maintain hotlines for citizen inquiries and reports of violations. Title III has specific provisions that enable citizens to bring legal actions against facilities or industries that do not comply with its provisions. Find out as much as you can about the problem and report it to the responsible agency, citing the specific provisions of the law you believe are violated and stating whatever evidence you have. If possible, work with a public interest group that has experience in tackling pollution problems.

Litigation is a slow and costly process, and should be used only after discussions with the source of pollution and the enforcing agency have proven fruitless. However, lawsuits can force a government agency to act if it is shown to be:

- Violating normal agency procedures
- Violating a substantive statute or regulation
- Abusing its discretionary authority (that is, making a decision based on inadequate information or inappropriate standards)
- Violating legally required decision-making procedures
- Violating environmental impact review requirements

What about legal action to force polluters to pay cleanup costs? Traditionally, monetary awards for damages are not by any means sufficient to pay cleanup costs. Approaches differ in "balancing equities," the relative interests of the complainant and polluter. It is extremely important to know the specific provisions of environmental law for your particular State.

Under both Federal and State environmental laws, you have the right to file a suit for an injunction (halt) to pollution if you can show that the defendant is in violation of the State law, or (in some States) if it is creating an imminent danger. However, it is only in extreme cases, when the potential damage is clear and irreparable, that a judge is likely to take short-term action before the full-scale legal process has come to its conclusion.

SUMMARY

The Nation's regulation of hazardous materials is accomplished

through several key pieces of legislation, each of which addresses a specific aspect of the problem. This legislation charges numerous Federal agencies with responsibilities to protect our environment and the public health, each agency bringing its expertise in a specific area to bear on particular areas of concern. These laws and agencies support State and local governments in addressing their hazardous materials problems, but leave a great deal of responsibility to lower levels of government. By becoming familiar with key Federal legislation as well as the specific provisions of your State and local legislation, you can recognize possible violations of the law and join others in working for full enforcement of its provisions. ■



HAZ MAT TEASER

(answers on pages A-1 and A-2)

Early in spring, people living around a meat packing plant begin to notice a faint odor of ammonia coming from the facility when the wind is out of the west. Other things begin to raise the level of concern in the community over the next few weeks: a large number of dead and dying fish are observed in the river that runs next to the packing plant, and the school down the block is experiencing a higher than normal absentee rate caused by children coming down with chest colds and respiratory tract infections.

Several people who live in the neighborhood also work at the plant. They have reported to company management that the strong odor of ammonia has given them severe headaches and caused breathing difficulties. Plant managers have told them that there is no cause for alarm and the odor of ammonia is "normal."

That evening, several neighborhood leaders get together and compare notes on the problems at the plant. Concerns are expressed about the now-frequent odor of ammonia, and the effects it may be having on the local community.

The neighborhood leaders decide to hold a community meeting to share perspectives on the situation and determine what additional steps should be taken. If you were among this group of neighborhood leaders:

Over 90 people representing a variety of interests attend the meeting to discuss the situation. Conspicuously missing are company representatives of the meat packing plant. At this session, people begin to compare notes and stories and learn that the problem and the complaints come from a far larger area than was previously believed.

4. Assuming those you invited attended, what are some of the immediate follow-up actions that can be taken by members of the group to resolve the situation?

CHECK YOUR MEMORY

(answers on page A-4)

1. This Federal act addresses the problem of *inactive* hazardous waste sites:
 - a. Superfund
 - b. The Resource Conservation and Recovery Act
 - c. The Occupational Safety and Health Act
 - d. The Clean Water Act

2. This act requires chemical companies to research the effects of new chemicals and notify the EPA before they are manufactured:
 - a. The Clean Water Act
 - b. The Hazardous Materials Transportation Act
 - c. The Toxic Substances Control Act
 - d. Superfund

3. Under Title III, the primary responsibility for developing a local plan for handling accidental releases of acutely toxic substances is the responsibility of:
 - a. The State Emergency Response Commission
 - b. The National Response Team
 - c. The Local Emergency Planning Committee
 - d. The Environmental Protection Agency

4. Title III requires industries that store or use certain quantities of acutely hazardous substances to report them under what conditions?
 - a. Only routine (day-to-day) releases
 - b. Only accidental releases of a certain quantity
 - c. Both routine and accidental releases of a certain quantity
 - d. Every release in any quantity

5. The local role in reducing public risks from hazardous materials includes:
 - a. Developing an emergency plan for hazardous materials incidents
 - b. Regulating hazardous materials transportation through local ordinances
 - c. Regulating safe disposal of hazardous waste
 - d. All of these

6. If you believe a local manufacturer is not in compliance with Title III, you should:
 - a. Report the situation to the LEPC
 - b. Sue the manufacturer
 - c. Call a reporter
 - d. Threaten the manufacturer

7. The Federal agency responsible for regulating hazardous materials traffic between States is:
 - a. The Environmental Protection Agency
 - b. The Department of Labor
 - c. The Department of Transportation
 - d. The Federal Emergency Management Agency

Unit 3:

IDENTIFYING HAZARDOUS MATERIALS

In this unit, you will learn about:

- Clues that indicate the presence of hazardous materials
- How to identify where hazardous materials are located in your community
- Common problems and remedies for hazardous materials sites
- How to use a Material Safety Data Sheet (MSDS) to learn more about acutely toxic substances

How do you know where hazardous materials exist in your community, and whether or not they pose a threat to public health? In some cases, lengthy testing of samples from numerous locations is required to prove that a threat does (or may) exist. In others, the danger is clear and immediate. As a concerned citizen, you need to be aware of where hazards may exist and know how to recognize and report a possible problem.

DETECTING THE PRESENCE OF A HAZARD

The ability to detect a hazard and take corrective action can save lives. In Roseburg, Oregon a number of years ago, several people observed a truck with an "explosives" placard on it parked by a lumberyard. Later that night, a fire broke out in a dumpster in the lumberyard, igniting the explosives, Eighteen city blocks were destroyed; 13 people were killed, and 125 others were injured. Had someone recognized that this location was a questionable one for a truck with this placard and called the police or fire department, this disaster could have been averted.

Sometimes there are **sensory** clues that indicate the presence of hazardous materials. However, sensory clues are the least dependable and potentially most dangerous method of identification. Many materials do not have such warning signals as smell or taste. If you notice that an area has a terrible smell, your eyes water, your skin is



Thousands of communities across the country are knowingly or unknowingly affected by hazardous waste sites.

irritated, or you begin to cough or feel nauseous, **leave** immediately and telephone your local police or fire department. If you encounter a suspicious substance, do not try to dispose of it yourself. You might only add to the problem.

Sometimes no sign reveals that hazardous chemicals exist beneath the surface of the ground, but occasionally unusual circumstances suggest its presence. Water that has an oily appearance, unusual algae growth, or white froth may be contaminated. Discolored soil, bare spots in the ground where vegetation has died off, dead animals, and the presence of metal drums or other specially designed containers also signal a potential problem. Should you ever actually see someone dumping what appears to be a hazardous material in a place not designed to receive it, note the identifying features of the person and vehicle and call the police immediately. "Midnight dumping," whether by individuals or corporations, is a growing threat to public health that requires prompt correction.

Some State and local areas offer programs to help the public identify hazardous materials problems. The New Jersey Attorney General's Office, for example, has a program to sensitize people to evidence of illegal waste disposal. You may wish to inquire about similar programs in your area.

Your Local Emergency Planning Committee (LEPC) should be able to give you precise information about where reportable quantities of extremely hazardous materials are stored or released from fixed sites in your community. (Or, you can use the Toxic Release Inventory database to find this out for yourself.) Remember, however, that all the hazardous materials that might pose a problem may not be known to the LEPC. Hazardous materials of a type not on the list or stored at levels just below the reportable quantity may still cause a serious incident. Undocumented waste sites or underground storage tanks may exist, or large quantities of toxic materials may be regularly transported through your community.

In identifying where hazardous materials are found in your community, consider the five phases of a hazardous material's "life"-production transportation, storage, use, and disposal. At each phase, the possibility exists either for controlled, careful use or for short-sighted mismanagement.

HAZARDOUS MATERIALS PRODUCTION AND STORAGE

Hazardous materials are stored before and after they are transported to their intended use. For example:

- Service stations store gasoline and diesel fuel in underground tanks
- Hospitals store radioactive materials, flammable materials and other hazardous substances

- .. Manufacturers, processors, distributors, and recycling plants for chemical industries store a variety of chemicals on site

In addition to the LEPC, your local police and fire departments should maintain specific information on industries in your community that use, store, or generate hazardous materials. Your local codes are a critical element in protecting community health, for they determine what handling, reporting, and emergency preparedness practices are considered "safe." It is usually the local fire department's role to inspect facilities to ensure code compliance. A fire department with a strong prevention emphasis may require businesses to document a hazardous materials management plan that indicates how materials are stored, how compatible substances are separated, where they are disposed of, and other pertinent information. Of particular interest is the existence of underground storage tanks, which can present a significant groundwater contamination hazard. (Old tanks are often overlooked in inspections or not known to exist.) Small volunteer fire departments often lack the personnel and skills required to inspect and maintain records on hazardous materials stored locally; some train citizen volunteers to assist them in these tasks.

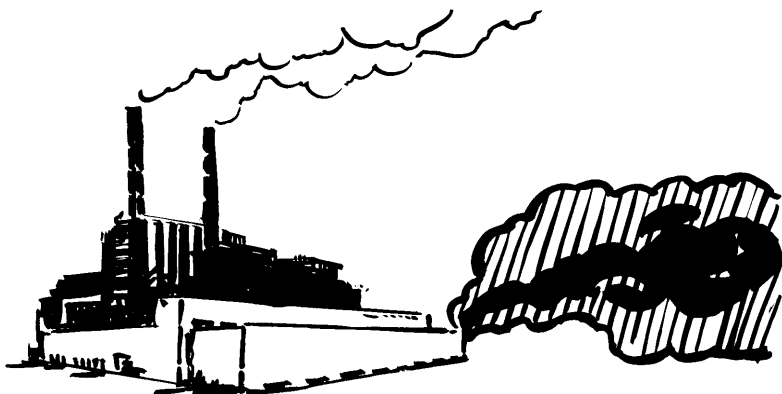

The likelihood of the accidental release of a toxic substance from a fixed site such as a factory can be prevented by regular local inspections of facilities to ensure compliance with hazardous materials storage and handling regulations. Should a release occur, the cloud would contain areas of greater and lesser concentration (depicted here as solid and striped).

At the local level, citizens can often express their concern about a local industry's safe manufacture and storage of hazardous materials by conducting a neighborhood inspection. If approached in an atmosphere of cooperation and concern, businesses may respond positively, for they have a great deal to gain by being "good neighbors." Wherever possible, the inspection team should be accompanied by an industrial hygienist—a specialist trained in industrial health and safety issues. In one such neighborhood inspection in Massachusetts, a potentially dangerous situation was noted where hundreds of chemicals were stored in alphabetical order. As a result of the inspection, the storage system was altered to separate chemicals that could react with one another. The discovery of this problem may well have prevented a serious accident in which neighborhood residents could have been injured or killed.

READING A MATERIAL SAFETY DATA SHEET (MSDS)

Hazardous materials are common in the modern workplace, and it is clearly important that workers know when they are handling these materials to ensure adequate protection and compliance with the proper safety procedures. Fortunately, the Hazard Communication Standard created by OSHA requires that employers who use hazardous substances must make Material Safety Data Sheets

(MSDSs) available for employee use and reference, and provide appropriate warning labels on containers of hazardous substances within the facility.

The MSDS is usually prepared by the manufacturer or distributor of a hazardous substance. MSDS forms are found in a wide variety of formats, but regardless of the format must contain certain key information for employee reference. In many cases, more information is provided on the MSDS than is required by law. The Hazard Communication Standard requires that the following categories of information be written in English on an MSDS form. (A sample MSDS is found at the end of this unit; you can refer to it when reading this section.)



A Material Safety Data Sheet (MSDS) provides important information on a substance's composition, potential hazards, and specific first aid procedures required in the event of an emergency.

ingredients which comprise 1% or greater of the mixture must be given. If the hazardous ingredient is a carcinogen, those contents which comprise greater than 0.1 % must be listed.

An example of this information can be found in Section I of the sample MSDS at the end of this unit. This MSDS is for hydrofluoric acid—a mixture of hydrogen fluoride gas in water, whose properties vary with its concentration.

Physical and Chemical Characteristics

This category includes the physical and chemical characteristics of the hazardous substance—such as whether it is a liquid, gas, or solid, and data pertaining to characteristics such as vapor pressure and flash point.

The physical data may provide information on how the product will act under a variety of temperatures and conditions. You may learn from this category of information if the material has an odor (and at what level the odor becomes noticeable), the color of the material, and other items about the material's behavior.

This information can be found in Sections III, IV, and VI of the sample MSDS at the end of this unit.

Physical Hazards

The physical hazards of the material must be noted on the MSDS, including the potential for fire, explosions, or reactions and the conditions under which they may occur. The recommended extinguishing media (water, foam, dry chemical, carbon dioxide, graphite, etc.) for fires can be found here—this information is of great value to community emergency responders.

Some chemicals are **stable** by nature—that is, they are unlikely to undergo a chemical reaction or change that may result in a dangerous situation, such as an explosion, fire, or toxic release. On the other hand, some chemicals are **unstable** and are likely to react either alone or in combination with other chemicals and substances. This knowledge can be of great value when selecting storage locations for the product.

This information can be found in Sections IV and V of the sample MSDS form at the end of this unit.

Health Hazards

The health hazards of the hazardous substance must be given, including the signs and symptoms of exposure (such as a rash or burning of the eyes and throat) and any medical conditions which are generally recognized as being aggravated by exposure to the material. For example, people with respiratory problems should avoid the inhalation of solvent vapors from paint since these vapors may bring on breathing difficulties.

This information can be found in Section VI of the sample MSDS form at the end of this unit.

Routes of Entry

Potential routes of entry into the body for a hazardous substance must be noted on its MSDS. For example, our sample MSDS indicates that the routes of exposure for hydrofluoric acid include eye contact, skin contact, inhalation, and ingestion.

This information can be found in Section VI of the sample MSDS form at the end of this unit.

Permissible Exposure Limits

The OSHA Permissible Exposure Limit (PEL), ACGIH Threshold Limit Value (TLV), and any other exposure limit recommended by the manufacturer, distributor, or employer preparing the MSDS must be given if such values are available.

If such values are listed, they may indicate the maximum exposure a worker should have to the substance during an eight-hour working day, as expressed in parts per million (ppm) in air. The PEL is set

by OSHA and is a mandated exposure level. However, some PELs have not been updated recently and a number of employers follow exposure limits based on TLVS.

The TLV is the recommended level set by the Conference of Governmental Industrial Hygienists. TLVS are advisory guidelines that are revised each year as more information becomes available for different chemicals.

This information can be found in Section II of the sample MSDS form at the end of this unit.

Carcinogens

If the material is listed in the National Toxicology Program (NTP) Annual Report on Carcinogens or has been found to be a potential carcinogen by OSHA or the International Agency for Research on Cancer, this information must be noted on the MSDS.

The product used for the sample MSDS at the end of this unit is not a carcinogen. Had it been, this information might have been found in Sections II or VII.

Safe Handling

This category of required information includes any generally applicable precautions for safe handling and use of the product which are known to the preparer of the MSDS, including appropriate hygienic practices, protective measures during repair and maintenance of contaminated equipment, and procedures for spills and leaks of the material.

This information can be found in Section VII of the sample MSDS form at the end of this unit.

Control Measures

Any generally applicable control measures which are known to the preparer of the MSDS, such as appropriate engineering controls, work practices, or personal protective equipment that is needed to safely handle the material, are included in this category.

This information can be found in Section IX of the sample MSDS form at the end of this unit.

First Aid Procedures

The first aid procedures that are to be used on a person who is exposed to the product must be listed for the various routes of exposure and noted on the MSDS.

On some MSDS forms, this category maybe expanded to include procedures that should be followed by medical authorities treating

those who have been exposed to the material. In all cases of suspected overexposure, medical advice should be sought.

This information can be found in Section VI of the sample MSDS form at the end of this unit.

Date of Preparation

The date that the MSDS was prepared, and the date that the information was last updated, if applicable, must be noted on the MSDS.

This lets you know exactly how current an MSDS is. Some MSDS forms may be updated once or twice a year, while others, such as those for steel, do not require frequent updating. A call to the manufacturer or supplier can determine if you have the most recent update of the MSDS form that is available.

This information can be found in the header of the sample MSDS form at the end of this unit.

Manufacturer Information

The name, address and telephone number of the chemical manufacturer or responsible party who prepared the MSDS and can provide additional information on the hazardous chemicals and appropriate emergency procedures to be followed, if necessary, must be listed on the form.

This information can be found in the header of the sample MSDS form at the end of this unit.

If no relevant information can be located for a required category, the MSDS will be marked to indicate that no applicable information has been found for that entry.



THE NFPA 704M SYSTEM

The National Fire Protection Association (NFPA) has devised a voluntary marking system to alert firefighters to the characteristics of hazardous materials stored in stationary tanks and facilities. This system, known as NFPA 704M, can also assist citizens visiting a site in identifying the hazard presented by the stored substance. Use of the system is voluntary, unless specified by local codes.

The NFPA 704M labelling system for hazardous materials was devised to provide at-a-glance information to response personnel on how a substance could be expected to react in the event of an emergency.

The NFPA 704M label is diamond-shaped, and is divided into four parts, or quadrants.

The left quadrant is **blue**, and contains a numerical rating of the substance's health hazard. Ratings are made on a scale of 0 to 4, with a rating of 4 indicating a danger level so severe that a very short

exposure could cause serious injury or death. A zero, or no code at all in this quarter, means that no unusual hazard would result from the exposure.

The top quadrant of the NFPA symbol contains the substance's fire hazard rating. As you might expect, this quadrant is **red**. Again, number codes in this quadrant range from 0 to 4, with 4 representing the most serious hazard.

The NFPA label's right quadrant, colored **yellow**, indicates the substance's likelihood to **explode** or react. As with the health and fire hazard quadrants, ratings from 0 to 4 are used to indicate the degree of danger. If a 4 appears in this section, the chemical is extremely unstable, and even under **NORMAL** conditions may explode or react violently. A zero in this quadrant indicates that the material is considered to be stable even in the event of a fire.

The bottom quadrant is **white**, and contains information about any special hazards that may apply. There are three possible codes for the bottom quarter of the NFPA symbol:

- **OXY** means this material is an oxidizer. It can easily release oxygen to create or worsen a fire or explosion hazard.
- The symbol **W** indicates a material that reacts with water to release a gas that is either flammable or hazardous to health.
- If the material is radioactive, the usual tri-blade "propeller" symbol for radioactivity will appear.

It is important to remember that the system is chemical-specific. **No** chemical identification system can accurately assess the synergistic effects of one chemical combining with another, or the possible effects of combining unknown amounts of several chemicals.

HAZARDOUS MATERIALS TRANSPORTATION

Hazardous materials are transported daily in the United States by air, water, road, rail, and pipeline. Of the 1.5 billion tons of hazardous materials **transported** in this country each year, more than half move by tankers along the Nation's highways.

Highway transport of hazardous materials is so common that it is doubtful that any area of the country could be considered free of the threat of an accident. Sound State and local policies to regulate this transportation safely, and to ensure that firefighters and others who would respond to an incident are well-prepared, are essential.

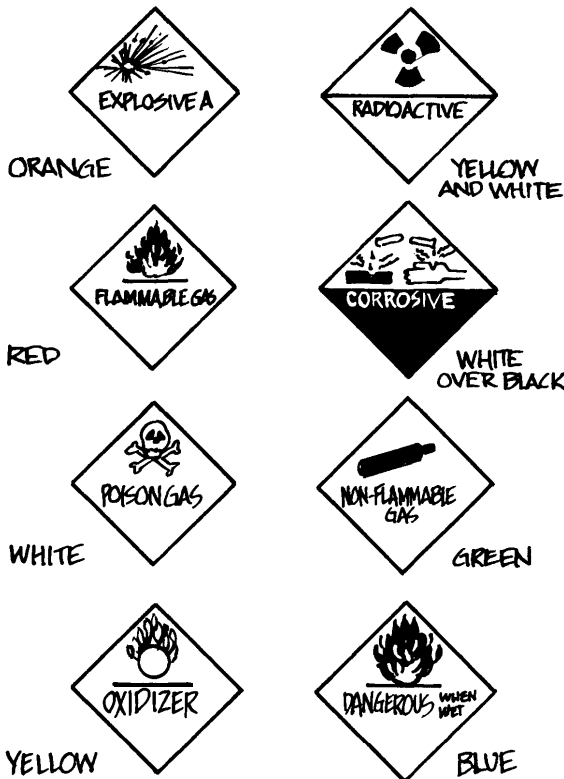

The Department of Transportation (DOT), in cooperation with the United Nations, has devised an international classification system which tags hazardous materials in transit with color-coded, symbolic warning placards.

The Department of Transportation, working with the United Nations, has developed an international classification system for hazardous materials. A substance is classified as hazardous if it "poses an unreasonable risk to public health and safety" when transported. Federal legislation requires that cargo tanks and railroad tank cars which are carrying regulated hazardous contents between States bear a four-digit code number. This code, called a North American (NA) or United Nations (UN) number, is located on placards placed on all four sides of the vehicle. If you are concerned about what sort of hazardous materials are passing through your community, you can use these UN numbers to categorize the transport vehicles by load. Interpretations of these codes are found in DOT's *Emergency Response Guidebook*, which may be obtained through DOT. You can also contact your LEPC to determine the stationary locations of chemicals in your area, and ask the companies involved where their chemicals originate and where they go.

Some placards also have a hazard class number at the bottom corner which indicates the substance's particular class. These numbers are standardized throughout the U. N.-participant countries using the system, and are as follows:

Number	Class
1	Explosives
2	Gases
3	Flammable Liquids
4	Flammable Solids
5	Oxidizers
6	Poisons
7	Radioactive
8	Corrosives
9	Miscellaneous Dangerous Substances

Each of these classes is then broken down into specific subsets. For example, gases may be poisonous, flammable, or nonflammable. Oxygen and chlorine are gases that have their own individual labels. Each class has a symbol that suggests the **primary** type of hazard it poses. (A single chemical may pose several hazards, only one of which is on the placard.)

Most transportation accidents involve **flammable or combustible liquids**. These are substances that have low flash points, and include the frequently transported fuel, gasoline. The **flash point** of a liquid is the point at which sufficient vapor is produced to cause it to flash in the presence of an ignition source. The **lower** the flash point, the more volatile the substance.

The second most frequent type of incident involves **corrosives**, defined by DOT as "any liquid or solid that can destroy human skin tissue, or any liquid that has a severe corrosion rate on steel." This class includes acids (such as sulfuric acid, used in chemical

processing; and nitric acid, commonly used in the manufacture of fertilizers, explosives, and synthetic fibers) and bases (such as sodium hydroxide, used to purify petroleum products and in the manufacture of soap, pulp, and paper).

How can your community lessen the likelihood of a serious accident involving a hazardous material? One good way is to be sure that existing regulations are enforced. This can require a **substantial** commitment in human resources. Another community responsibility is to ensure that the area has a good emergency plan for handling this type of incident, and that confusion over jurisdiction ("who's in charge?" and "who's in charge of what?") will not hinder an effective response.



The ability to detect an immediate hazard and take corrective action can save your life.

Finally, each community needs to carefully examine its own hazardous materials traffic and ensure that routes, assigned lanes, and other restrictions are used conscientiously to regulate the flow of potentially dangerous substances. In addition to analyzing highway traffic, you will want to know more about hazardous cargo traveling by rail and water if this applies to your community.

Excellent data on rail traffic can be obtained from the Federal Railroad Administration and the individual railway lines serving your area. Many individual rail lines can provide detailed information on the hazardous materials shipments in your area. In addition, State regulatory agencies can tell you which hazardous materials travel most frequently by rail in your State.

For water transportation facts, the Army Corps of Engineers and the U.S. Coast Guard are most likely to be of assistance, while the Federal Aviation Administration is the best source for data on air traffic.

HAZARDOUS MATERIALS WASTE SITES

Thousands of communities across the country are affected by hazardous waste sites. These include abandoned dump sites, municipal landfills, industrial ponds, storage piles, military base waste sites, and similarly designated areas. Sites that are **inactive** (not receiving hazardous waste) are generally listed and ranked for cleanup under the Federal Superfund legislation or State cleanup programs, while **active** sites are regulated under the Resource Conservation and Recovery Act (RCRA).

Only the most dangerous sites are eligible for Superfund, which ranks qualified sites on the **National Priorities List (NPL)**. A site is placed on the NPL after a **preliminary assessment** and a more thorough **site investigation** demonstrate that a potentially serious health threat exists. While approximately 22,000 hazardous waste sites are identified in EPA's inclusive Emergency Response and

Remedial Information System (ERRIS), ***less than 1% of this number are included on the NPL.***

The NPL ranking is usually determined by a score assigned to the site by the State and reviewed by EPA. The score reflects the severity of the contamination, and the vulnerability of residents and the environment to damage from any of the pathways of exposure. Careful testing is required to establish concentrations of pollutants at various points.

State and local officials have been taking an active role in the hazardous waste discovery process. Many local officials have actively sought out these sites with the aid of local citizens. Ideally, the "responsible party" who left the waste assists in cleanup, but in some cases the polluting company no longer exists or responsibility cannot be proven. The State or local area maybe left with extremely large cleanup costs in such cases—which is why ***prevention*** of poor waste disposal practices is by far the best option.

Unfortunately, "cleanup" is not as "clean" a process as the name implies. There are basically three approaches to cleaning contaminated soil:

1. ***Containment.*** The objective of this approach is to leave the waste in place and try to keep it from moving into the soil, air, or groundwater. Unfortunately, natural forces have triumphed in many landfills to date, and systems expected to last decades have made it only a few years before leaking.
2. ***Off-Site Disposal.*** Under this approach, hazardous materials are removed to a RCRA site. Often, risks are transferred rather than eliminated; a number of RCRA landfills have begun to leak and have been added to the NPL for cleanup.
3. ***Treatment.*** Numerous technologies are available or are currently being explored to chemically treat waste so that it is no longer harmful. The best method varies according to the waste. Some waste can be ***biodegraded*** by adding micro-organisms specifically bred to "eat up" the chemicals; organic chemicals can sometimes be forced to break down when high temperatures are applied.

Decontaminating groundwater is an even lengthier process. Since groundwater moves slowly through the soil, as long as 20 years may be needed to complete decontamination once pollution has occurred. Three water treatment approaches are currently in use:

1. ***Air Stripping/Aeration.*** Water is brought to the surface and agitated or sprayed into the air to accelerate the evaporation of organic compounds. Citizens near a site using this method need to ask questions about the rate at which toxic elements are released into the atmosphere, particularly if residential areas are located near the stripping tower.

2. **Activated Carbon.** This treatment passes water through columns containing activated carbon, leaving many chemicals attached to the carbon particles. A sensitive issue in this type of treatment is how to dispose of the contaminated carbon.
3. **Chemical Precipitation.** In this approach, primarily used to remove metals such as lead and arsenic, chemicals are added which can convert metals to insoluble particles. These particles then settle out of the water as sludge. The controversial issue with this method is the disposal of the toxic sludge.

HAZARDOUS MATERIALS IN RURAL AREAS

Even rural areas face hazardous materials problems. In addition to the ever-present possibility of a hazardous materials transportation accident, or storage problems associated with small businesses such as agricultural chemical dealers, threats exist which are unique to the rural environment.

Since wells are a primary water supply in most rural areas, a major concern is the introduction of contaminants into groundwater. A serious, and fortunately infrequent, hazard is that of flammable gas in wells. Small volumes of naturally occurring methane gas can

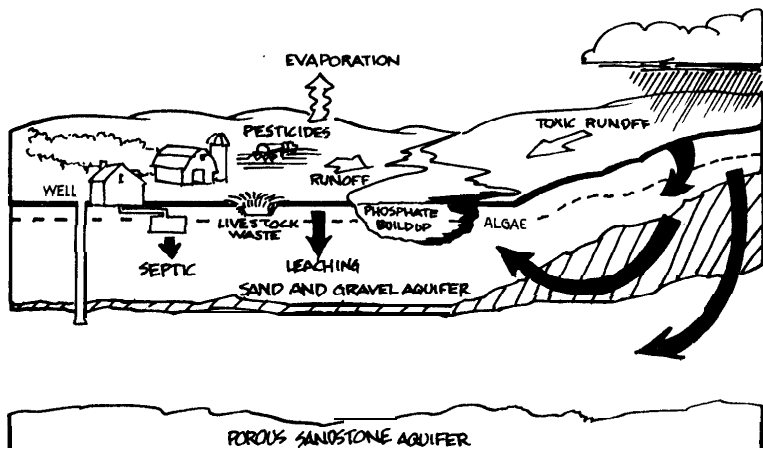

enter wells that are drilled into carbonate or shale rock, causing explosions and fire. This hazard may be lessened by venting the well head and other areas of the house where gas can be trapped. Another source of concern is the common farming practice of applying fertilizers and pesticides to crops next to the barnyard or farmyard, where many can be drawn into a well—a problem that can be reduced by decreasing the use of pesticides in that general area.

Farmers sometimes use sewage sludge as a source of plant nutrients.

Groundwater contamination is a major concern in rural areas, which must deal with pollutants such as livestock waste and pesticide runoff in addition to the problems found in more heavily populated environments.

However, some industrial sludge contains heavy metals that may be toxic to crops, humans, and other animals. Because tolerance levels for heavy metals depend on the soil's physical and chemical characteristics, farmers should work with a professional to determine their soil's tolerance and stay within its limits.

Phosphate fertilizer can also cause problems. If you notice that fish are dying in an area where phosphates can reach the water from farm runoff, it is possible that phosphates are promoting the growth of algae and other aquatic plants that deplete oxygen. Reduced use of phosphates and runoff control can reduce this problem. Similarly, excessive use of nitrogen can contaminate groundwater and surface water, particularly when fertilizer is applied far in advance of the crop or to improve poor soils.

Accidents involving excessive use of pesticides have resulted in fish kills, human illness, and even death. Pesticides have been known to contaminate groundwater, particularly in very permeable soils or at sinkholes in limestone; once these substances are introduced into the groundwater supply, they can also be carried to surface waters. Developing other pest control procedures to reduce pesticide use and avoiding applications to permeable soils can reduce contamination. Protective clothing is also important whenever pesticides are applied.

Agricultural runoff can carry soil particles, pesticides, bacteria, and other pollutants directly into estuaries and coastal waters, or into rivers that flow into these waters. Control of runoff by each farmer is extremely important in limiting the spread of harmful products,

SUMMARY

It is not possible to rely on the senses to detect the presence of hazardous materials—such clues as pungent odors or a feeling of nausea may or may not be present. (Radon, the second leading cause of lung cancer in the United States, is a colorless, odorless, tasteless gas.) To find out whether you are exposed to hazardous materials is, therefore, a matter of research. Federal laws require disclosure and identification of hazardous materials in specific circumstances. For example, hazardous materials shipments crossing State lines and many hazardous materials used in the workplace must be **labelled**. For such substances a Material Safety Data Sheet (**MSDS**) is often available that provides detailed information on the material's attributes and required self-protection, State laws often "close loopholes" in Federal legislation (such as transportation of hazardous materials within State lines) to provide further citizen protection.

To identify the presence of hazardous materials in your community, consider all five phases of the material's "life"-production, transportation, storage, use, and disposal. Thoughtful policies are needed at each phase to protect local residents from unnecessary health risks. ■

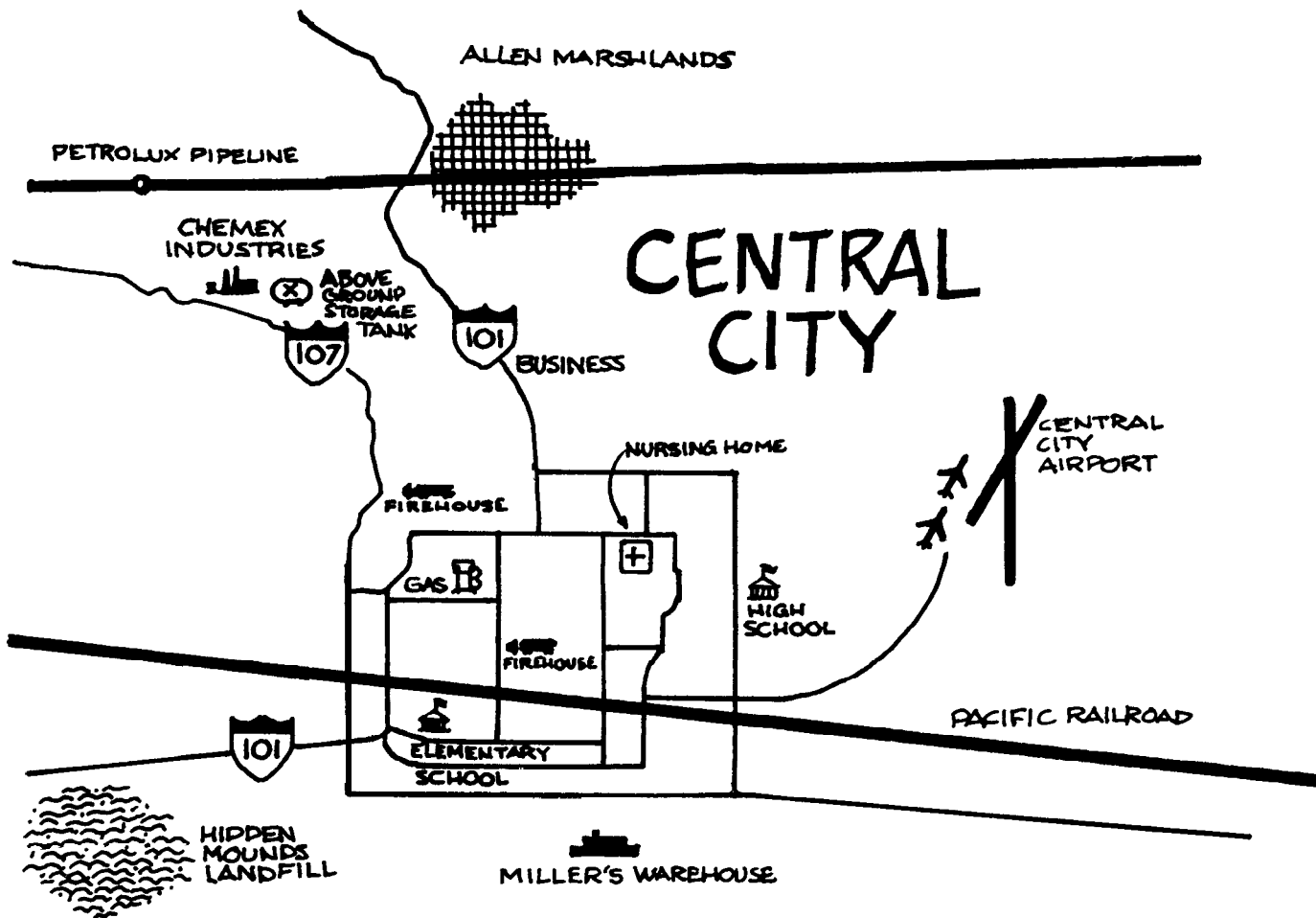

HAZ MAT TEASER
(answers on page A-2)

Consider the five phases of the life cycle of a hazardous material—production, transportation, storage, use, and disposal. Based on the map shown above, where in this community do you see a potential for a hazard to develop?

1. During production?

2. During transportation?

3. During storage?

4. During use?

5. During disposal?

MATERIAL SAFETY DATA SHEET

GENIUM PUBLISHING CORPORATION
1145 CATALYN STREET
SCHENECTADY, NY 12303-1836 USA
(518) 377-8855



No. 6A
HYDROFLUORIC ACID
AQUEOUS (47-70%)
Revision B
Date May 1981

SECTION I, MATERIAL IDENTIFICATION

MATERIAL NAME: HYDROFLUORIC ACID, AQUEOUS (47-70%)
DESCRIPTION: A solution hydrogen-fluoride-gas in-water. Properties vary with concentration.
OTHER DESIGNATIONS: GE Material D4A7, CAS #007 664 393
MANUFACTURER: Available from many suppliers, including Harshaw Chemical Company, and E.I. duPont de Nemours Co., Inc.

SECTION II, INGREDIENTS AND HAZARDS

	%	HAZARD DATA
Hydrogen fluoride (HF)	47-70	8-hr TWA 2 mg/m ³ or 3 ppm*
Water	Balance	--

*Current OSHA Standard and ACGIH (1980) TLV (as HF).
NIOSH has recommended 10-hr TWA of 2.5 mg (as F)/m³ and a ceiling level of 5.0 mg/m³ (15 min. sample).
TLV set at level to minimize irritation of eyes and nose and to prevent fluorosis. DuPont recommends that this level be treated as a ceiling limit.

SECTION III. PHYSICAL DATA

48% acid 70% acid

Boiling point, 1 atm ----- 225F (107 C) 152 F (66 C) Volatiles, % --- ca 100
Weight % HF in vapor at BP ----- ca 80 ca 98 Water volubility- Complete
Vapor pressure at 20 C, mm Hg -- ca 25 ca 125 pH ----- <2
Specific gravity (0/4 C) ----- 1.18 1.27
Freezing point ----- ca -35 F ca -95 F

Appearance & Odor: Colorless, or nearly colorless, fuming liquid with a pungent, irritating odor above 5 ppm.

SECTION IV, FIRE AND EXPLOSION DATA

LOWER UPPER

Flash Point and Method	Autoignition Temp.	Flammability Limits In Air	LOWER	UPPER
N/A	N/A	N/A		

Extinguishing Media: Water or carbon dioxide. Keep upwind of fire.
This material is nonflammable; however, flammable and explosive hydrogen gas may be formed when HF reacts with certain metals.
Dangerous when heated; emits toxic corrosive fumes. Avoid getting water into tanks or drums, can cause generation of heat and possible spattering.
Firefighters should wear self-contained breathing-apparatus, eye protection; and complete body protection equipment when fighting an HF fire.

SECTION V, REACTIVITY DATA

Hydrofluoric acid is a stable chemical when used and stored under proper conditions. This acidic material will attack glass, concrete certain metals, silica-containing materials natural rubber, leather, and many organics. It reacts with silica to produce SiF₄, a hazardous colorless gas. Reaction with cyanides or sulfides may cause release of poisonous cyanide or hydrogen sulfide gas.

Keep 50% acid in tightly closed polyethylene; TEFLON, lead, wax, or paraffin coated containers. >60% HF concentrations can be handled in passivated steel containers and piping of appropriate design.

SECTION VI, HEALTH HAZARD INFORMATIONTLV 3 ppm or 2 mg/m³ (as HF)

HF is not detected by smell at 3 ppm but is immediately irritating to mucous membranes a over 5 ppm. Inhalation of vapors can cause extreme irritation of respiratory tract, pulmonary edema, congestion, and fluorosis. Breathing 50 ppm for 30-60 min. may be fatal. Eye contact can cause permanent damage. Skin contact causes severe burns, which may not be immediately painful or visible; concentrations below 50% may not produce symptoms for 8 hours or longer. Ingestion can cause throat burns and severe swelling of windpipe.

FIRST AID:

Eye Contact: Immediately flush with water for 15 min. or more, including under eyelids.*

Skin Contact: Wash acid from the skin. Remove contaminated clothing. Continue washing 2-4 hours with water; or preferably if available, soak in iced zephiran (0.13%), epsom salt or 70% denatured ethyl alcohol solution for 1-4 hours, depending on severity of burns.*

Inhalation: Immediately remove to fresh air. Admin. 100% O₂ and repeat 1/2 hr intervals.*

Ingestion: Do not induce vomiting. Give large quantities of milk or water with milk m a g n e s i a . *

*Get Medical attention promptly for all affected persons. First aid procedures should be planned before beginning work with HF. Consider hospitalization.

SECTION VII. SPILL, LEAK, AND DISPOSAL PROCEDURES

Notify safety personnel, provide adequate ventilation, and remove ignition sources since hydrogen may be generated by reactions with metals. Use protective clothing & equipment. HF vapor should be passed through a packed tower scrubber. Spills should be covered with lime to form a slurry. Do not flush to sewers or waterways.

DISPOSAL: The neutralized slurry can be scraped up for disposal in an approved landfill. Liquid wastes may be neutralized in a trench with lime in a remote location away from buildings and people. Then fill the trench with earth and cover with lumber or sheet metal until the earth settles. Follow Federal, State, and Local regulations.

NOTE: Porous materials (concrete, wood, plastic, etc.) will absorb HF and become a hazard for an indefinite time. Such spills to be cleaned and neutralized immediately.

SECTION VIII, SPECIAL PROTECTION INFORMATION

Exhaust hoods should be a noncorroding construction, with a face velocity minimum of 100 fpm. Respirators should be available for nonroutine and emergency use above the TLV. An air-supplied respirator or a self-contained breathing apparatus with full facepiece is recommended when vapors/fumes are above exposure limits, up to 20 ppm.

Wear protective clothing, including boots or safety shoes with polyvinyl chloride (PVC), neoprene or composition soles; chemical goggles and/or a full face shield; coveralls with long sleeves; gauntlets and gloves of PVC or neoprene. A high degree of protection obtained with an air-inflated suit with mask and safety belt. Protective clothing not to be worn or carried beyond operation areas. Use protection suitable for conditions.

Chemical showers and eyewash stations to be readily available to areas of use. Immediately shower with copious amounts of water within seconds after contact, and completely remove all clothing while in shower.

Contact with dilute HF solutions (below 20% in water) may not produce immediate pain or visible damage; but after several hours, the burns will be manifest.

SECTION IX, SPECIAL PRECAUTIONS AND COMMENTS

Maintain adequate ventilation. Use forced draft ventilation and scrubbers for fume control. Keep containers tightly closed. Storage facilities to be constructed for containment and dilution/neutralization of spills.

Use nonsparking tools around tanks & pipes where hydrogen as may collect. Handling and storage of HF requires special materials technology for containers, pipes, valves, gaskets, etc., which is available from suppliers. TEFLON TFE or FEP fluorocarbon resins are resistant to all conc. of HF up to 500 F and 400 F respectively.

Do not inhale HF mists or vapors! Preclude from exposure workers with kidney disease, osteofluorosis, or impaired pulmonary function.

DOT Classification - CORROSIVE MATERIAL.

I.D. no. UN1790

1-11, 17, 20, 26, 31, 37, 38,
DATA SOURCE(S) CODE: 43 MSDS # 6

APPROVALS: MIS / CRD

Industrial Hygiene/
and Safety

5-5-81

MEDICAL REVIEW: 14 May 1981

Judgments as to the suitability of information herein for purchaser's purposes are necessarily purchaser's responsibility. Therefore, although reasonable care has been taken in the preparation of such information, Genium Publishing Corporation extends no warranties, makes no representations and assumes no responsibility to the accuracy or suitability of such information for application to purchaser's intended purposes or for consequences of its use.

CHECK YOUR MEMORY

(answers on page A-4)

1. The best source for information on where hazardous materials are stored or released from fixed sites in your community is usually:
 - a. The mayor's office
 - b. Your Congressional representative
 - c. The LEPC
 - d. Individual manufacturers

2. Which of the following can **not** be learned from an MSDS?
 - a. The dangerous ingredients in a substance
 - b. Recommended first aid for overexposure
 - c. Firefighting recommendations
 - d. How to adapt the Permissible Exposure Limit (PEL) to your age, weight, gender, and sensitivity

3. On which of the following might you find an NFPA 704M label?
 - a. A truck
 - b. A storage tank
 - c. A train
 - d. A package

4. You find on an NFPA label that the left side of the quadrant, which is blue, has a rating of 4. This means that:
 - a. The material offers no unusual health hazard
 - b. A very short exposure to the substance could cause serious injury or death
 - c. The chemical is unstable, and may explode or react
 - d. In four minutes of exposure to this substance you will lose consciousness

5. The symbol W on an NFPA label means that:
 - a. The substance will not dissolve in water
 - b. The substance is slippery when wet
 - c. You should not add water to the substance
 - d. You should keep the substance wet at all times

6. DOT requires highway cargo tanks and railroad tank cars with regulated hazardous contents to bear a four-digit number identifying the load if they are:
 - a. In high-hazard areas
 - b. Moving in interstate commerce
 - c. Listed as extremely hazardous
 - d. Acutely toxic

7. Which of the following is **not** an approach to cleaning contaminated **soil**?
 - a. Containment
 - b. Off-site disposal
 - c. Treatment
 - d. Air stripping

Unit 4:

PREPARING FOR HAZARDOUS MATERIALS INCIDENTS

In this unit, you will learn about:

- .The importance of the Local Emergency Operations Plan
- .Responsibilities of local, State, and Federal government and emergency response forces in a hazardous materials incident
- .How to protect yourself and your family during a hazardous materials incident

In September 1988, a minor chemical accident at a swimming pool supply plant near Los Angeles released a highly toxic gas over a six square mile area, forcing 25,000 people from their homes within a matter of hours. Emergency personnel and city and county government staff members responded to the incident. Over the next few hours, fire engines, police cars, emergency medical technicians, the mayor, the county emergency services director, and the hazardous materials response team arrived to assist with management and cleanup duties.

The rapid escalation of resources on the scene associated with such serious hazardous materials incidents raises a key issue. How do all these people know what to do in the crucial first minutes of an emergency to contain the disaster and avoid making the situation even worse?

The answer lies in a good emergency operations plan. Such a plan will prevent role confusion and logistical tie-ups that can hamper an efficient response.

IS YOUR COMMUNITY PREPARED FOR A HAZARDOUS MATERIALS INCIDENT?

Experience in disasters has shown repeatedly that when emergency plans and procedures are known, exercised, and kept up-to-date by operating forces, reaction times are reduced, coordination is improved, and overall response and recovery measures are more effective and efficient.

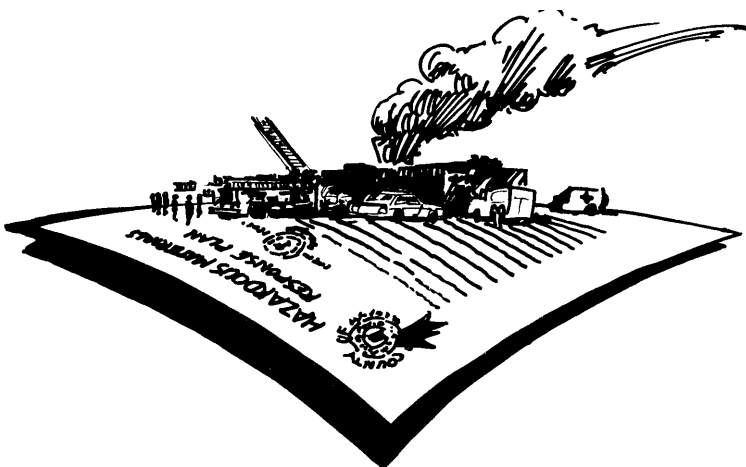

Your community Emergency Operations Plan serves as a blueprint for its response to a potential hazardous materials incident.

Your community's Local Emergency Operations Plan serves as a blueprint for response to many types of emergencies that could occur in your community, including a hazardous materials incident. Ideally, the plan will have been prepared by a multi-disciplinary team of specialists familiar with:

- The hazards in your area,
- The local resources available to respond to an incident, and
- The resources of neighboring jurisdictions, as well as from States and the Federal government.

The hazardous materials plan should be one component of a more comprehensive plan detailing how your community would respond to various types of disasters. The key components of **a complete local plan** are the following:

- The **basic plan**, which is a relatively broad conceptual framework describing the policy and approach to emergency operations.
- Supporting annexes** that contain information on specific functional responsibilities, tasks, and operational actions needed to deal with particular hazards. The focus of an annex is on operations—what the function is and how it is carried out. Annexes are action-oriented and written for personnel charged with execution of the plan. Examples of annexes include warning, evacuation, and fire and rescue.
- Implementing procedures**—these may be in the form of hazard-specific appendices, standard operating procedures, or checklists. They support annexes and contain technical and detailed operational information for use by emergency personnel, including such information as lists of people to alert under specified conditions, and specific “how to” instructions for operating departments or individuals to carry out assigned responsibilities.

Because the requirements of hazardous materials incidents differ markedly from those of other emergencies, a separate hazardous materials annex to the generic operations plan is needed to address these issues. The plan outlined in the annex should be comprehensive, but specifically tailored to your community's unique situation. For example, local fire service jurisdictions must reach specific agreements on how they will communicate and work together in an emergency. Local industries must be approached **beforehand** to ensure that critical equipment can be made available in the event of an emergency, with agreements in place to facilitate leasing or lending.

Once in place, the hazardous materials annex to the plan should allow your community to respond quickly and effectively to a hazardous materials incident. Its benefits will extend beyond this, however. The planning process itself—by bringing together local

officials, response workers, citizen volunteers, and industry representatives involved **with** hazardous materials—opens important lines of communication. Through dialogue, planners can find options for minimizing the chances of a major hazardous materials incident, and prepare to work together efficiently if a major or minor incident does occur.

The summary at right reviews the basic elements that comprise an effective plan.

Detailed instructions for preparing an effective plan are published by the National Response Team. (See the listings at the end of this course.)

The Planning Process

Under Title III provisions, the SERC decides how many planning districts are needed to prepare adequate plans for responding to chemical emergencies throughout that State. Some States have LEPCs at the county level, while others have designated the entire State as a planning district with one LEPC. The SERC is responsible for appointing individuals to serve as LEPC members in each planning district.

Each LEPC prepares a plan based on a thorough understanding of the hazards faced by the specific area and the resources it has to meet them. The following steps would be required to complete a sound plan for **any** emergency.

1. Identifying Participants

The LEPC should include members with diverse experience. The group's collective expertise should include experience in **planning**; knowledge of the community; experience with the **local response forces**; and knowledge of hazardous materials, their effects, and appropriate medical treatments.

2. Analyzing Risks

The LEPC reviews and critiques any community plans that may already exist. It then determines the community's potential hazardous materials risks, primarily through the use of reports submitted by local industries under Title III, but supplemented by analysis of hazardous materials transport and other potential local hazards not addressed by the legislation.

3. Identifying Special Populations and Areas of Concern

The LEPC takes a close look at the community to identify areas

REQUIRED ELEMENTS OF A LOCAL EMERGENCY RESPONSE PLAN

To be effective, a local emergency response plan must:

- Use the information provided by local industry to **identify** where hazardous substances are used and stored, and the routes used for transporting such substances.
- Establish emergency response procedures, including evacuation plans, for use in the event of an accidental chemical release.
- Set up notification procedures to contact designated emergency response personnel.
- Establish methods for determining the occurrence and severity of a release, and the areas and populations that the release would be most likely to affect.
- Establish ways to notify the public of a release.
- Identify the emergency equipment available in the community, including equipment at facilities.
- Devise and schedule a preparedness program to train local emergency personnel and medical workers in response procedures for chemical emergencies.
- Devise methods and schedules for conducting "exercises" (simulated emergencies) to test elements of a proposed response plan.
- Designate a **community coordinator** and **facility coordinators** to be responsible for the smooth execution of the plan.

To be effective, an emergency response plan must address the unique characteristics of the community it is to serve—a "fill-in-the-blanks" type of plan simply will not do.

that are particularly vulnerable to incidents, and populations that would require special planning to protector evacuate them in an emergency (such as nursing home residents).

4. Identifying Available Resources

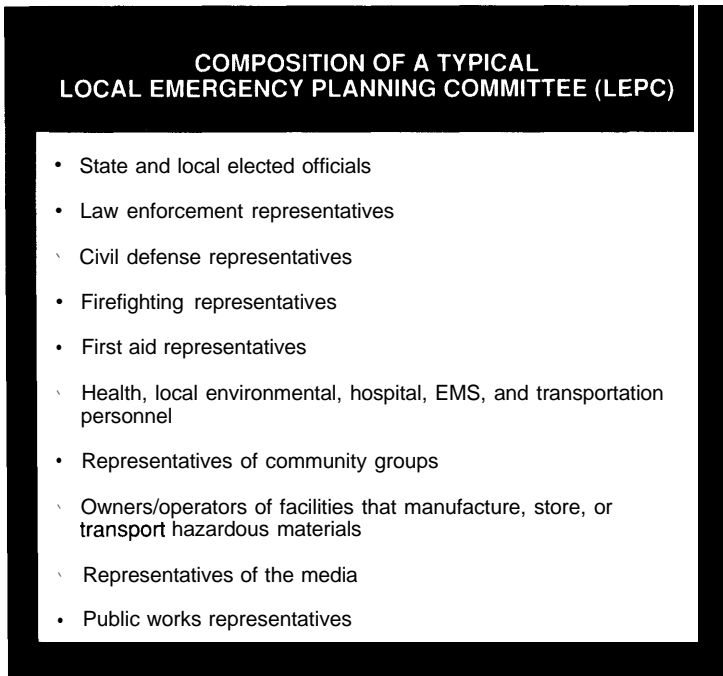

COMPOSITION OF A TYPICAL LOCAL EMERGENCY PLANNING COMMITTEE (LEPC)

- State and local elected officials
- Law enforcement representatives
- Civil defense representatives
- Firefighting representatives
- First aid representatives
- Health, local environmental, hospital, EMS, and transportation personnel
- Representatives of community groups
- Owners/operators of facilities that manufacture, store, or transport hazardous materials
- Representatives of the media
- Public works representatives

Makeup of a typical Local Emergency Planning Committee (LEPC).

The LEPC works with local police and fire officials to determine the response capabilities of their departments, then gathers information to understand the incident response role played by surrounding communities and State and Federal government agencies. Capabilities of these secondary sources are then assessed. The Committee then determines the response capabilities of local industry and transporters, specifically those which have the potential to be involved in a hazardous materials incident.

On the basis of this information, the LEPC develops a resource list, detailing where equipment and personnel may be obtained to help with a hazardous materials emergency, and whom to call for assistance. It also designates the specific responsibilities of all resources—police, fire, and other city departments, as well as volunteers and key private sector organizations—in the event of a hazardous materials incident.

5. Drafting the Plan

A draft hazardous materials emergency plan is prepared by the LEPC, reviewed and approved by all parties assigned responsibilities under the plan, and revised to incorporate comments. Finally, the LEPC distributes and explains the plan to key emergency response and government personnel, and **periodically updates** it to reflect changes within the community or within its local government

6. Testing the Plan

Once the plan is in place, the community must conduct **exercises** (simulations of emergency situations) to determine whether responders are prepared to handle their assigned roles, and whether the planned procedures are effective. Exercises provide a means of validating the emergency plan and evaluating training programs used to prepare responders. Ranging in complexity from “tabletop” discussions to the actual deployment of significant resources and personnel (as if in response to an incident), exercises are the best way to find out

if the community is ready for a specific type of emergency. Potential problems with plans and procedures are often revealed in the exercise. These problems can then be corrected, leaving the jurisdiction better able to handle an actual emergency.

Problems in Past Incidents

When a hazardous materials incident plan either does not exist or is inadequate, a wide range of problems can occur. A lack of trained personnel or insufficient resources to handle the incident can lead to rapid escalation and unnecessary injuries. Unless detail-oriented preparation has included **all** emergency responders in plan development, unpleasant "surprises" can occur. Examples from recent incidents include the following:

- .Difficulties occurred in locating victims and in finding a hospital or reception center to receive them.
- .Reception centers were uncertain about who was to obtain food, medical supplies, and bedding for evacuees.
- .The Emergency Operating Center was inundated with so many citizen calls that communications among emergency organizations were paralyzed.
- .Medical personnel were unfamiliar with the treatment and effects of the hazardous material involved.
- .Organizational "turf" issues were not worked out in advance, and role conflicts impeded operations.

Often responders discover that their resources are inadequate to handle the incident, or that personnel were insufficiently trained in the specific role they must perform in the incident.

ROLES IN INCIDENT RESPONSE

Any chemical incident, or potential release, may draw firefighters, police, and emergency medical technicians to the scene. Response to a hazardous spill or fire is a complex process, requiring specially trained personnel and specialized equipment. A buddy system is needed to ensure personnel protection. A typical team would consist of approximately eight well-equipped and trained members. Of these, two individuals perform incident operations and rescue, two others serve as operations backup, two are the decontamination team, and there is one safety and one operations officer.

A truly serious incident would require representatives of all three levels of government (Federal, State, and local) to be present at the scene, with each level consisting of personnel from between five and 15 different agencies. Scientists familiar with chemical

properties would help develop a strategy for controlling the incident that is appropriate to the properties of the material. Environmental scientists would project the movement of materials and provide advice on minimizing the adverse impact on the environment. Local firefighters and specialized hazardous materials response teams (their capabilities enhanced through specialized training and additional resources brought in through interagency agreements) would manage the incident, as public safety personnel controlled crowds and traffic. The media, as well as lawyers and management representatives of the chemical company, would also be on hand. At a recent Florida incident, in fact, some 200 officials responded to the scene: this figure did **not** include the 21 workers handling the actual cleanup!

Given the large number of personnel at the site, roles and responsibilities must be clearly established in the contingency plan **before** the incident occurs. Individual Emergency Operations Plans (EOPs) will spell out these roles and responsibilities for each responding agency—but whether these responding agencies work smoothly together is largely a function of planning, and of how well the plan was communicated to key personnel.

Successful management of a hazardous materials incident falls upon the shoulders of the **Incident Commander**. In most States and jurisdictions, this individual is from the local fire service. The Incident Commander is tasked with directing all response and supporting operations in accordance with procedures specified in State or local ordinances and the local emergency operations plan. As additional officials with higher rank arrive on the scene, they may assume the Incident Commander role. A good plan will eliminate any confusion as to who the Incident Commander is at any point in the emergency.

The Local Role in Incident Response

In a hazardous materials incident (as in other types of emergencies) a successful outcome depends largely on **local** level preparedness. The amount of training response personnel have received, the extent to which responsible personnel were involved in planning, and other key factors in the planning process will become abundantly clear in an exercise or in an actual incident.

As first responders at the scene of a hazardous materials transportation spill, local firefighters and/or police typically have the lead responsibility for:

- Identifying the materials involved
- Determining the risk or hazard posed by the spill
- Calling for additional resources, if necessary, to monitor and contain the spill
- Isolating the scene, restricting or rerouting traffic, and conducting evacuation, if necessary
- Providing first aid, as needed

- Fighting the fire and protecting against explosions
- Keeping the public informed of the hazard that exists, the actions being taken, precautionary measures to take, and evacuation routes and destinations (if necessary)
- Taking overall scene management responsibilities

The first local forces who arrive on the scene usually do not have the specialized clothing they would need to rescue personnel in a chemical emergency without themselves becoming victims. Once a chemical emergency has been identified, specially equipped responders may arrive who are better able to take action. Incident responders who must come into direct contact with hazardous materials (particularly at an incident site) should be wearing appropriate personal protective equipment (PPE) and clothing. PPE should isolate individuals from the chemical, physical, and biological hazards they will encounter by protecting the respiratory system, skin, head and face (particularly the eyes), hands, feet, and body. A fully encapsulating suit is often required in incidents involving toxic substances. This type of suit is extremely bulky and cumbersome, and provides only half an hour of actual intervention time.

Your local emergency services department or communications center will usually notify appropriate State and Federal agencies, send and receive messages, and record and disseminate information. It may also assume the public information role from the firefighters and/or police. Individuals involved with these services may also coordinate requests for outside assistance and activate a mobile command post, along with a driver, if required at the scene.

The local public health department safeguards the public when food and/or water supplies may be affected or when dwellings may become contaminated. A chemist and toxicologist from this department may provide advice on toxicity and personnel protection, as well as recommendations to the scene manager regarding actions to be taken to reduce public health hazards. The public works department may assist in containment and cleanup, if they have adequate protective clothing and equipment.

State Role

In a major incident, a local government may have to call on State agencies for specialized resources and knowledge. Such an action could involve a number of State agencies; their potential roles are described below.

- The **Office of Emergency Services** arranges State and **Regional** mutual aid support and provides liaison with State agencies.
- The **Department of Transportation** assists and/or provides for identification and containment of all materials on State highways and freeways or unincorporated county roadways.



A fully encapsulating suit is generally the required dress for response personnel in incidents involving toxic substances. These suits are extremely bulky and cumbersome, and provide only half an hour of actual intervention time.

- The **State Police** or Highway **Patrol** provides general control of the perimeter of the incident (regulating traffic, for example) and will play other roles depending on State law and incident requirements.
- The **Department of Fish and Game** and **Regional Water Quality Control Boards** provide recommendations and guidelines when hazardous material spills are likely to contaminate streams and/or waterways, or would otherwise affect wildlife resources.
- **State OSHA personnel** often possess a large reservoir of technical knowledge useful to an Incident Commander in the areas of exposure to, protection from, and control of hazardous materials. In an incident in which employees have been injured due to exposure, or in a prolonged incident, State OSHA personnel may respond.
- The **State Department of Health** employs health scientists who can help assess the potential human impact of a toxic release.
- The **State Department of Environmental Protection** can predict the environmental impact of actions the Incident Commander is considering.
- The **State and local Fire Marsha/** have specific expertise relating to chemical behavior and State fire codes.

Federal Role

In the event of a major incident, the Federal government can also provide assistance to the local Incident Commander through the National Response Center (NRC). This center, staffed by the U.S. Coast Guard, operates a 24-hour hotline to receive and relay notices of major hazardous materials discharges to the appropriate authorities. When needed, the NRC can also make the expertise and other resources of Federal agencies available to the local government.

Other Sources of Information and Assistance

Other types of specialized assistance are available from governments, local industries, and from National organizations representing chemical manufacturers and transporters.

Hazardous Materials Response Teams (HMRTs). An HMRT is a specialized emergency response team formed to provide the particular skills, knowledge, and technical equipment needed to handle hazardous materials incidents. The chemical industry was the first provider of these services because it manufactured, transported, and used the products involved.

An HMRT is a major investment; whether the investment is warranted for a community depends on the nature of the risks it is facing as well as its resources. An HMRT would need specialized equipment, including expensive specialized protective clothing and detection instruments, containment vessel repair equipment, substance containment and recovery equipment, decontamination equipment, and instruments. The operating costs can be high—but so are the costs of a mismanaged incident. Often, local areas that cannot afford their own HMRTs pool their resources to form a more practical multijurisdictional team.

Regional Response Teams (RRT's).

Regional Response Teams may be assembled to provide advice and support for transportation or fixed facility incidents that surpass the capability of State and local governments. The RRT reports to an On-Scene Coordinator who directs the response in keeping with the local Incident Commander. RRTs are composed of representatives from Federal agencies and a representative from each State within a Federal Region. Overall responsibility for coordinating Federal emergency preparedness and planning on a nationwide basis rests with the National Response Team (NRT), which is composed of representatives from 14 Federal agencies with major environmental, transportation, emergency management, worker safety, and public health responsibilities.

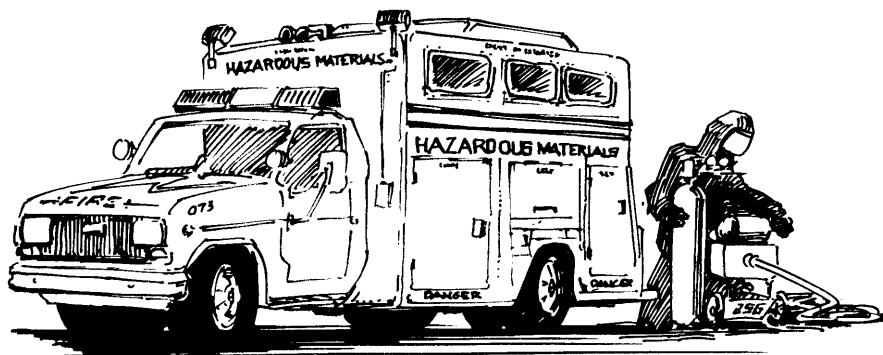

Specialized groups of emergency response personnel, known as Hazardous Materials Response Teams (HMRTs), meet the need for the specific knowledge and technical equipment required to handle hazardous materials incidents.

The Federal resources available in a significant emergency are immense. How they are used, however, is determined by the Incident Commander, and regulated by State statutes and local ordinances.

CHEMTREC, CHLOREP, and NACA. The CHEMical Transportation Emergency Center, called CHEMTREC, was established by the Chemical Manufacturers Association in 1971 to provide information for responders to chemical or hazardous materials emergencies. CHEMTREC operates in two stages:

1. Upon receipt of the name of a specific chemical, CHEMTREC provides immediate advice on the nature of the product and steps to be taken in handling the early stages of an emergency involving that product.
2. CHEMTREC promptly contacts the shipper of the material involved to obtain more detailed information and appropriate follow-up, including on-scene assistance when feasible.

CHEMTREC'S operators can assist incident responders by providing information such as the physical properties of the chemical involved, appropriate protective clothing to be worn by response personnel, and general tactics to use with the various hazardous materials (e.g., certain hazardous materials-induced fires will need to be extinguished with water, while others should be smothered or covered with a special type of foam). CHEMTREC will not, however, tell the Incident Commander how to manage the incident.

Never call CHEMTREC unless a true emergency exists. It is important that telephone lines be open at all times for those who urgently need help. If you do call CHEMTREC, you will need to provide them with as much of the following information as is possible:

- Your name, and a number at which you can be called back
- The location of the problem
- The type of container involved
- The product, or type of product, involved
- The rail car or truck number
- Local conditions
- The shipper or manufacturer
- The intended receiver

The Chlorine Institute can provide specific technical assistance for chlorine emergencies. **CHLOREP**, the CHLORine Emergency Plan, provides telephone instruction to on-scene personnel in the United States and Canada, and, if necessary, can notify the nearest producer of chlorine and request that a trained team be dispatched.

The National Agricultural Chemicals Association (NACA), has identified a group of specialists designated as the Pesticides Safety Team (PST). The team provides advice for incidents involving pesticides and will dispatch a response team to the site if one is needed.

Local Industry. Local industries which use or generate hazardous materials can also be sources of assistance. In general, the larger the firm, the more likely that it will be able to provide assistance in an emergency. The following types of companies are likely to have the knowledge, equipment, or personnel to provide local-level assistance:

- **Chemical companies**, which often have the equipment and personnel to respond to chemical spills.
- **Oil refining** and storage facilities, which maybe able to assist at a spill of oil or gasoline.
- **Construction companies**, which can provide heavy equipment and operators when needed.

• **Transportation companies**, which can provide detailed information on the materials they carry, assist in evacuation, and may have trained personnel and specialized equipment.

• **Pollution cleanup contractors**, which have specialized equipment and trained personnel. Although a fee will be charged for the services provided, professional cleanup contractors are often the best (and quickest) source of advice and physical assistance at a spill.

Your local emergency operations plan should maintain a current list of contacts and telephone numbers for all potential sources of assistance. Compiling this information during an emergency can waste valuable time when the need for action is urgent.

The Public. Unlike many other emergencies, in which volunteer help is often welcome, in a hazardous materials emergency there is usually little that untrained members of the public can do. Citizens should **never** try to approach the command post in a hazardous materials emergency: any information you wish to offer should be given by telephone from a safe distance. Observe all posted exclusion zones, and listen for public announcements on the radio or other local information system.

PROTECTING YOURSELF IN A TOXIC INCIDENT

If an accident involving hazardous materials occurs in your community, emergency services personnel will notify you as to what steps to take. Your best protection is to follow these directions, which are aimed at minimizing your exposure to the hazardous materials.

Public Warning and Notification Methods

Communities generally alert and notify the public as to emergency situations through one of the following methods:

- **Warning Sirens or Horns.** These audible warning devices are used to attract attention and alert citizens to an emergency situation. Different tones or tone patterns may have various meanings. These devices are **outdoor** warning systems, and may not be heard indoors or inside vehicles.
- **Emergency Broadcast System (EBS).** The radio and television Emergency Broadcast System can disseminate community emergency information, including where to go for additional information. This notification system requires individuals to be tuned into the radio or television at the time of the announcement.
- **"All-Call" Telephoning.** This notification method uses an automated system to ring up area telephones and provide a recorded message when telephones are answered. Obviously,

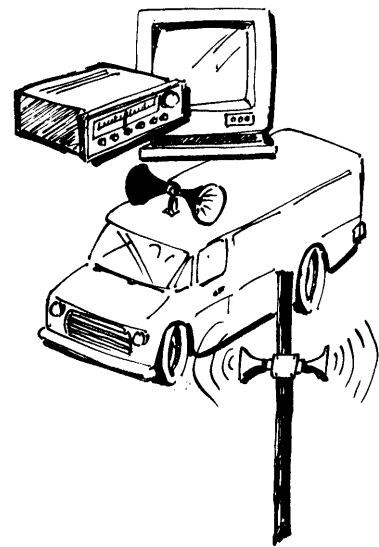

Communities use different methods to inform and direct the public in the event of an incident. In your community, which would most likely be used to notify you if an incident occurred that required you to evacuate or take other protective action ?

this type of notification works only for people who are within earshot of a telephone.

• **Announcements Over Cable Television.** In some communities, cable systems are hard-wired to enable emergency response forces to relay announcements over all cable television stations. Viewers may be alerted by a tone alert with a line of text across the bottom of their television set, an automatic cut-in with a picture and voice transmission from the emergency scene or a local agency, or a cut-in using voice communication only. As with the Emergency Broadcast System, this notification method is useful to people who are tuned in to a broadcast channel.

• **Residential Route-Alert.** In this method, motor vehicles equipped with public address systems travel predesignated routes to notify people of the emergency situation. This method may not be heard by persons inside buildings. An alternative is door-to-door knocking by officials on foot.



What You Should Do

After you have been alerted of a hazardous materials incident, you should await further information from emergency response personnel. Upon receiving this information, follow it carefully. Your primary objective is to keep your distance from the incident in order to minimize your chances of contamination.

If you are caught outdoors during a hazardous materials incident, it is best to stay upstream, uphill, and/or upwind. Move toward a crosswind, so the wind is blowing from either the right or the left rather than directly in your face or at your back.

If you are caught outside in an incident, try to stay **upstream, uphill, and upwind**. You want to stay upstream from toxic waste flowing in water, so it is not carried towards you. Many toxic vapors are heavier than air and will tend to settle in low areas; thus, you are usually safest uphill where the topography will provide some protection.

Wind will play a critical role in distributing the toxic material, so you want to stay **upwind**—i.e., in the opposite area from where the wind is spreading the toxic fumes. If you are already caught in a plume, however, move in a **crosswind** direction, so the wind is blowing from either the right or left and not into your face or at your back.

How far away from an incident should you go to be safe? The answer to this will depend on weather conditions, topography, and the characteristics of the chemical itself. A high wind can carry the toxic substance many miles from the spill. Hills can delay dispersal, while the opposite is true of open country. (Your LEPC can gain low-cost access to highly sophisticated computer software that can project how far a plume is likely to extend under specific incident conditions.) In general, however, you should go at **least** 10 city

blocks (one-half mile) from the danger area; for many incidents, you will need to go much further.

Evacuation

A major hazardous materials incident could require an evacuation of a large area. When a burning rocket fuels plant blew up in Henderson, Nevada, thousands had to leave the area, and interstate highway traffic was deadlocked. An overturned propane truck on New York's Long Island kept 1,000 families from their homes for several days until the danger of explosion was over. At the peak of a fire at a plant where chlorine was stored, some 25,000 residents of Springfield, Massachusetts were evacuated.

If you are asked to evacuate because of a hazardous materials emergency, **do so immediately**. Your local radio station or television channels should give you precise directions. Before leaving your home or office, close your windows and shut all vents to minimize contamination. If time permits, place a sign on your door or front window to notify the Public Service Department that your building has been evacuated and no one remains inside. It is also a good idea to provide a telephone number where you can be reached.

In a major emergency, the Red Cross and other local volunteer organizations will establish temporary shelters for evacuated residents. These shelters most frequently are located in schools or other large public facilities. Stay tuned to your radio for updates on the situation, evacuation routes, and alternative routes for traffic. If you are handicapped or need special assistance in order to evacuate, call your local police. (If you do **not** need this assistance, do **not** call: keep the line open for those who do!)

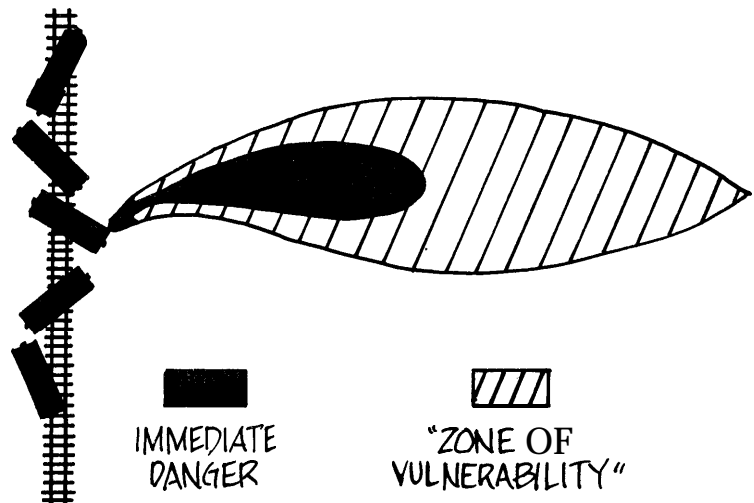

In-Place Sheltering

In certain circumstances, it is safer to keep community residents indoors than to evacuate them. This option, known as **in-place sheltering**, is sometimes chosen by local authorities when evacuation may expose people to large doses of toxic chemicals. If you are sheltered in your own home, strictly follow all instructions given by the emergency forces. The following procedures are intended to reduce risk in most incidents where in-place sheltering is used:

- To reduce the amount of toxic vapors entering your home, seal entry routes as efficiently as possible. Close windows and doors, and seal drafty places with wet towels, blankets, or tape.

Your Local Emergency Planning Committee (LEPC) can gain access to highly sophisticated computer software that can project how far a plume will extend under specific incident conditions.

- Turn off all ventilation, including furnaces, air conditioners, vents, and fans.
- If dangerous vapors are entering the building, take shallow breaths through a cloth or towel. (The same procedure may offer some protection from smoke in a fire.) While use of a cloth may be of value, however, it is important to emphasize that it is strictly a defensive measure and can provide only minimal protection. It certainly does **not** enable the wearer to enter a toxic environment! Portrayal of daring rescues on television using handkerchiefs for protection are erroneous and misleading, and should **not** be imitated.
- Remain in protected areas of the house where toxic vapors are reduced, and be sure to take your radio with you.

Other Protective Measures

A hazardous materials incident offers opportunities for exposure by three primary routes discussed earlier in this manual: inhalation, absorption, and ingestion. The following guidance will help you minimize your exposure by these routes. This guidance is intended to supplement—not replace—information given by local emergency services personnel.

Minimizing the Inhalation Hazard. If you are in a motor vehicle, close off ventilation and shut your windows. As we have seen, a **minimal** amount of protection from contamination is provided by covering your mouth and nose with a cloth. The best protection is to **distance** yourself from the source: sightseeing at an incident of this type is an unnecessary risk to your health.

Minimizing the Risk of Skin Absorption. Many toxic materials can be easily absorbed by the skin. Since even a small amount of a chemical substance may be toxic, you should avoid contact with any spilled liquid material, mist in the air, or condensed solid chemical deposit. Keep your body fully covered—including gloves and socks—but remember that these measures are only minimally effective. Once you have left the area, you should fully disrobe, proceed through decontamination, and dress in fresh clothing.

Avoiding Ingestion of Toxic Substances. Toxic substances can be ingested if your food or water supply becomes contaminated. If you learn that you will be sheltered indoors, quickly fill up your bathtub with a supply of uncontaminated water and turn off the intake valve to your home. Do not eat any food that could have become contaminated in an incident.

Decontamination. A person or item that has been exposed to a hazardous material is **contaminated** and can contaminate other people or items (i.e., **cross-contamination**). For example, if you enter your car after being exposed to a toxic substance, you will contaminate your car.

Decontamination is the process of removing or neutralizing contaminants that have accumulated on people and equipment. At hazardous waste incidents, "clean" areas must be established and maintained and materials in contaminated areas be confined to specific "hot" zones. Response personnel who have had to enter the middle area—the contamination reduction zone—must later remove their clothing and equipment, shower in fresh water, be rinsed with neutralizing agents, re-shower, and change into clean clothing.

The specific procedure for decontamination will vary according to the chemical to which the individual was exposed. Certain items—e.g., leather and some plastic and rubber materials—absorb toxic substances so easily that they cannot be completely decontaminated; these items must be discarded.

Decontamination methods seek to:

- Physically remove contaminants,
- De-activate contaminants by chemical detoxification or disinfection/sterilization, or
- Remove contaminants through a combination of both physical and chemical methods.

The manufacturer of the substance can provide information on the appropriate decontamination method to follow. Basic information should be readily available on the substance's container.

If you believe you maybe contaminated and medical assistance is not immediately available, remove all of your clothing, shower thoroughly, don fresh loose warm clothing, and seek medical help. Advise **all** who come in contact with you that you may have been exposed to a toxic substance so they can take proper precautions. To avoid contaminating your home and others, place your exposed clothing in a nonpermeable container without allowing it to contact other materials, and arrange for proper disposal.

1. Wash down outer clothing (**unless the chemical is water-reactive**).
2. Remove clothing, working from the top down.
3. Wash down your entire body (**unless the chemical is water-reactive**).
4. Wrap up or dress in clean clothing.
5. Discard contaminated clothing in a well-secured plastic bag. Then, report to trained medical personnel at the earliest opportunity.

Reporting a Hazardous Materials Incident

If you witness a hazardous material accident, spill, or leak, call 911 or your local emergency notification number as soon as possible. In rare cases in which no local emergency forces appear to be available, you can contact the National Response Center to report



Once exposed to a toxic substance, clothing must be decontaminated or discarded prior to contact with human skin or other objects. Some materials, such as leather, absorb contaminants easily and must be discarded.

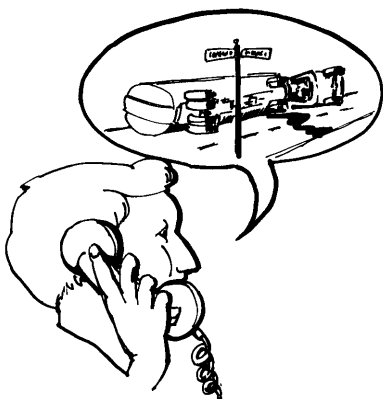

If you witness a hazardous materials accident, spill, or leak, call 911 or your local emergency notification number with precise information about the incident.

an emergency. Provide as much of the following information as possible:

- The chemical involved, if known
- Information on the substance's placard or label, if it is visible
- Precise location of the incident
- Size of the incident, in quantitative terms
- Direction in which the plume is moving
- Color of the smoke or spilled liquid
- Altitude and movement of the plume (i.e., is the plume rising or sinking?)
- Number of injuries
- For a transportation incident, a description of the vehicle involved (e.g., tanker or pickup truck) including any identifying marks, numbers, or placards

WHAT CITIZENS CAN DO TO ENHANCE LOCAL PREPAREDNESS

As a concerned citizen, the first thing you can do is find out how well—or poorly—your community is prepared for a hazardous materials incident.

You may find that your community does not even have an emergency plan in place for dealing with a hazardous materials incident. A 1988 survey by the National Response Team on the status of local preparedness programs discovered that even among those local jurisdictions with a full-time public safety agency, only one-third possess some form of planned response capabilities for hazardous materials incidents. Furthermore, of the relatively few communities that have emergency operations plans which include hazardous materials annexes or information, only a small fraction currently have plans considered acceptable under published NRT standards.

If there is no plan, or if the existing plan is ineffective, you should lobby for and/or assist in plan development. The following are some ways in which you can become involved:

- Make sure that an LEPC has been formed in your community, attend its meetings, and ensure that it truly represents your community. Volunteer to serve as a citizen representative to the LEPC.
- Make sure that the LEPC has obtained all the information it needs from local facilities to prepare a comprehensive emergency response plan.
- Review and comment on the emergency response plan, and inquire about its review status with the SERC and Regional Response Team (RRT).
- Ask for information (from your LEPC or SERC) about chemical

hazards, inventories, and releases in your community. Ask your LEPC what local facilities are doing to reduce chemical hazards.

- Use the National Toxic Release Inventory database to obtain information on routine releases of toxic chemicals in your community. This information should also be available from your LEPC.

Another way to enhance local preparedness is to help educate other residents. Write articles for your local newspaper (or interest someone who can) about the potential for injury and death to people and great harm to the environment that can be caused by hazardous materials. Also, offer to speak to community groups, or locate effective speakers who can help the community understand the issues and correct local problems.

SUMMARY

Protecting a community from the consequences of a hazardous materials accident requires teamwork that does not happen automatically. Responders to an incident must be working in a framework that clearly specifies their respective responsibilities. This means agreeing together on how they would locate and direct the resources—both personnel and equipment—a hazardous materials incident might require, documenting their shared understanding in a plan, training responders to fulfill their responsibilities, and conducting periodic tests to be sure the plan is realistic and responders are ready to carry it out.

In the event of major incident, local responders could access additional expertise through State and Federal agencies. Local citizens, however, can do little to assist in most such incidents. Rather than trying to volunteer to assist, citizens should be aware of what public information systems would be used and tune in to them for instructions. Citizens should also do what they can to minimize their exposure to toxic substances; in some cases, staying indoors with tightly closed windows may be healthier than evacuating through toxic vapors. The responding agencies will have access to information about the chemical, its behavior, weather conditions, and other data essential to make the best decision about protecting lives: therefore, it is of primary importance to follow their directions. ■

IS YOUR COMMUNITY PREPARED FOR A HAZARDOUS MATERIALS EMERGENCY?

Or, better yet, is your community successfully working to prevent such an occurrence? The following is only a sample of possible hazardous materials preparedness questions, but the answers should give you an idea of whether your community is thinking ahead or waiting for a serious incident to get its attention. A large number of "yes" answers area positive sign. Too many "no" answers suggest public inquiries may be needed to increase the awareness of the potential costs of hazardous materials accidents.

1. Was there formal training on HAZ MAT operational and response procedures in your community during the past year?
Yes _ No _ Don't Know _
2. Was there a HAZ MAT exercise in your community during the past year?
Yes _ No _ Don't Know _
3. Does your community have, in place, written mutual aid agreements with other jurisdictions or with industry?
Yes _ No _ Don't Know _
4. Does your community have an inspection program that deals with the transportation, on-site storage, and processing of hazardous materials?
Yes _ No _ Don't Know _
5. Has discharger liability been formally defined in your State?
Yes _ No _ Don't Know _
6. Are there established hazardous materials transportation regulations (in addition to the Federal standards) that affect your community?
Yes _ No _ Don't Know _
7. Are there established waste transportation regulations (in addition to the Federal standards) that affect your community?
Yes _ No _ Don't Know _
8. Are rails in the area aligned and leveled at least once a year?
Yes _ No _ Don't Know _
9. Are train speeds constantly monitored and violators prosecuted?
Yes _ No Don't Know _
10. Has the police department been enforcing the restricting of truckers to specific routes?
Yes _ No _ Don't Know _

11. Have sewer shut-off points been identified for the retainment of hazardous materials that may leak into sanitary and storm sewers?

Yes _ No _ Don't Know_

12. Do all industries handling hazardous materials in the area have individual in-plant emergency plans which are compatible with a general community plan?

Yes _ No _ Don't Know____

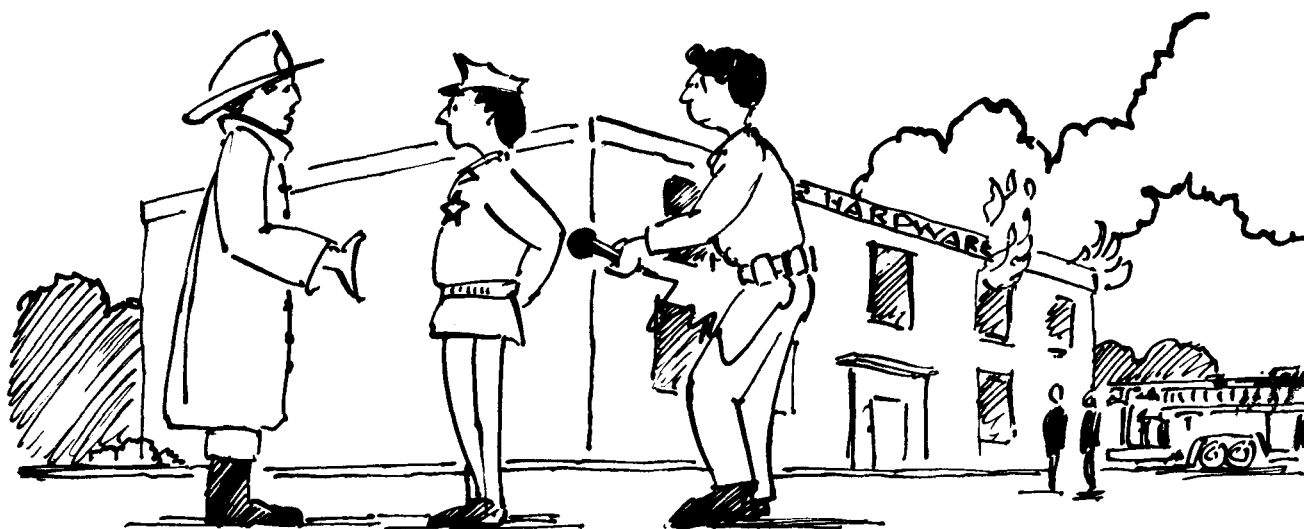

HAZ MAT TEASER
(answers on page A-2)

A fire was reported at a rural hardware store on the county line during the early morning hours of July 4th. The responding community fire department quickly realized that it had a major incident on its hands. Birds flying near the area were falling from the sky, and cows in nearby fields were having difficulty walking.

The firefighters tried to extinguish the blaze, but were driven back by several explosions that shot burning debris in all directions.

When the owner of the hardware store arrived on the scene, he informed the firefighters that his store contained large quantities of pesticides and a supply of fireworks for the July 4th celebration.

The fire chief told the police chief to evacuate the area, but could not say how large an area needed to be evacuated. The police chief stated that he did not have sufficient manpower to evacuate the area, and was unable to communicate with the sheriff's department to request assistance due to the incompatible radio frequencies used by the two forces. The police chief also felt that he did not have the authority to order people to leave, and suggested that the Town Council meet to declare an emergency. The sheriff arrived at the site and declared that he was in complete control of the incident and all operations, which greatly upset the fire chief and police chief.

Members of the fire department began knocking on doors to evacuate residents, but only went as far as the county line, which was the boundary of their fire district. Some residents were told to go to the fire station for shelter, while others were told to report to a nearby church. A radio station covering the story instructed listeners living within five miles of the hardware store to evacuate to the local high school. The Red Cross and the Salvation Army learned about the incident when the police department called them to request coffee and donuts at the scene of the fire.

Residents were scattered throughout the area while the fire burned itself out. Concern was raised over pesticide residues that may have traveled downwind from the fire, but no one knew who to call for technical advice and air testing. Attempts were made to contact the Mayor to take control of the situation, but he had gone out of town for the holiday and could not be reached.

CHECK YOUR MEMORY

(answers on page A-4)

1. What is the **minimum** number of persons needed to manage a hazardous materials incident safely?
 - a. 3
 - b. 5
 - c. 35
 - d. 8

2. The most critical element in avoiding confusion and conflict among responders at a hazardous materials incident is:
 - a. A good plan which all responders know and use
 - b. How much money the community spends preparing for an incident
 - c. The number of people who respond
 - d. The type of chemical involved

3. The person in charge of managing responding forces at a hazardous materials incident is:
 - a. The Incident Commander (usually from the local fire service)
 - b. The governor
 - c. The mayor
 - d. The EPA representative on the scene

4. Which of the following should you do if you are in your car and learn that there is an accident involving a volatile toxic substance **ahead** of you on the road?
 - a. Get in close to offer help
 - b. Walk to the scene to get more information
 - c. Drive as close as you can to evaluate the performance of the responders
 - d. Follow instructions and remain clear of the release plume

5. A person whose skin has been in contact with a toxic substance should be:
 - a. Decontaminated
 - b. Fed
 - c. Massaged
 - d. Given mouth-to-mouth resuscitation

6. Which of the following is **not** typically represented on a Local Emergency Planning Committee?
 - a. The governor
 - b. The police department
 - c. The fire service
 - d. The public works department

7. To find out **more** about your local plan for accidents at chemical plants and other fixed sites, your first contact should be:
 - a. The Department of Transportation
 - b. The LEPC
 - c. The Chemical Manufacturers Association
 - d. The Sierra Club

Unit 5:

HAZARDOUS MATERIALS IN THE HOME

In this unit, you will learn about:

- Common household hazardous materials; their effects on people and the environment; safe alternatives to these products; and their proper use, storage, and disposal
- What to do in the event of accidental poisoning from household hazardous materials, including the role of a poison control center and first aid techniques
- Hazardous waste disposal, the results of incorrect disposal, and suggestions for improving local hazardous waste disposal programs and policies

Disposal of household wastes has been a persistent problem throughout history. Solutions to many aspects of this problem are surprisingly recent: for example, sewage treatment plants were first constructed only 100 years ago. This lag time between problem and solution has intensified as technology produces more and more household products whose use and disposal constitutes a hazard.

In an average city of 100,000 residents, 23.5 tons of toilet bowl cleaner, 13.5 tons of liquid household cleaners, and 3.5 tons of motor oil are discharged into city drains each month, according to the Environmental Hazards Management Institute. These figures do **not** reflect the large quantities of household hazardous wastes disposed of in backyards.

We rely on the drain and the garbage truck for disposing of our wastes. Increasingly, however, these methods are becoming inadequate for disposing of materials we no longer want. We must learn how to **manage** our household hazardous materials: their use, storage, and ultimate disposal.

COMMON HOUSEHOLD HAZARDOUS MATERIALS

Toxic chemicals are stored in almost every room of a typical American home: cleansers in the kitchen, fresheners in the bathroom, and hobby supplies in the workroom, to name but a few. Incorrect use of these products may create unnecessary health risks for you and your family. In addition, improper disposal of hazardous waste from these household products can contaminate our land, water, and air.

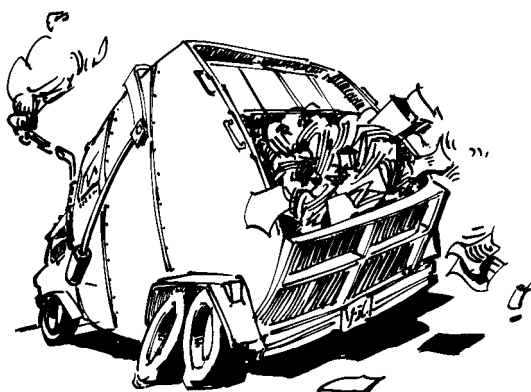
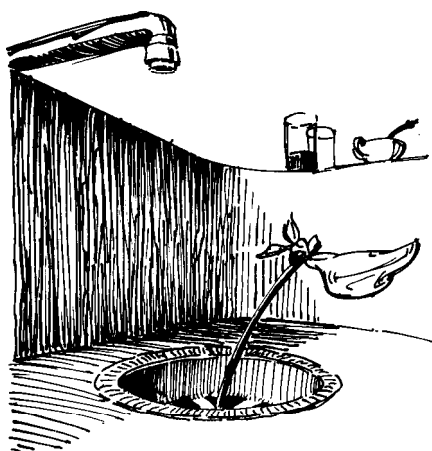

The drain and the garbage truck are increasingly becoming inadequate for disposing of materials we no longer want.

Understanding the nature of products that contain hazardous materials is the first step toward learning how to use them appropriately. This section provides basic information on some of the most common household hazardous materials.

Lead

Lead—which can cause anemia, brain damage, and damage to the digestive, neuromuscular, and central nervous systems—may be found in home plumbing systems. Lead contaminates tap water through **leaching**—either from lead water pipes or from the lead solder used to join sections of copper plumbing.

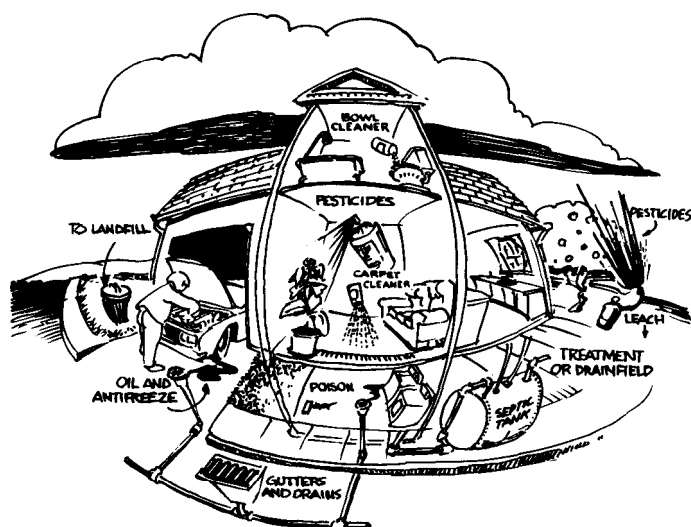

Hazardous materials are used throughout the house, eventually reaching the environment.

The amount of lead that leaches into the water you drink depends on the materials used in your plumbing system, the age of the plumbing, and the amount of time that water stands in the pipes. The longer water is in the pipes before it is used, the more lead it absorbs.

New copper plumbing installed with lead solder may leach high levels of lead into tap water for three or more years. Lead contamination is more likely if the plumbing was not installed by a professional plumber, since amateurs tend to use too much solder when attempting to join the pipes.

Many homes built before World War II have lead service pipes which may corrode and add lead to the tap water. A service pipe brings water into the house through the basement wall or floor, and connects to your water meter. Your service line is probably made of lead if:

- It is grey
- It will not attract a magnet
- It can be easily gouged with a key
- It does not have a sharp bend or elbow

Two precautions will help lessen the amount of lead in household water:

1. If the water has not been used for several hours, let the faucet run until the water temperature changes (usually three to five minutes). This ensures that you are getting fresh water rather than water that has been standing in the pipes.
2. Do not drink water from the hot water faucet or use it in cooking. Hot water remains stationary in the tank and pipes for a longer time; also, the higher temperatures increase the amount of lead that the water absorbs.

— Lead can also be a problem in paint in older homes, particularly if peeling paint is ingested by children.

Asbestos

Exposure to asbestos causes no immediate symptoms; however, there is a high correlation between asbestos exposure and the eventual development of chest and abdominal cancers and lung disease. Smokers have a greater chance of developing asbestos-induced lung cancer.

Since the mid-1960s, asbestos has been recognized as a cancer risk. Consequently, Environmental Protection Agency (EPA) programs address its containment and removal, especially in school environments. The Occupational Safety and Health Administration (OSHA) also has strict rules concerning worker exposure to asbestos.

Asbestos is now being phased out of all commercial uses. Because of its excellent capabilities for insulation and fire protection, however, asbestos has been used extensively in a wide variety of products. These include household and building materials such as appliances, ceilings, wall and pipe coverings, floor tiles, and some roofing materials. Contact the product manufacturer or an asbestos handler (e.g., plumber, building or heating contractor, etc.) to determine if a specific material or product in your home contains asbestos.

Usually, asbestos is not a serious threat to health until it is damaged or disturbed. Once it is disturbed, even slightly, the fibers give off toxic dust. Given the dangers associated with asbestos, removal of asbestos should be handled only by trained and qualified contractors.

Formaldehyde

Exposure to formaldehyde typically produces eye, nose, and throat irritation; wheezing and coughing; fatigue; skin rash; and severe allergic reactions. Other immediate reactions may include nausea and a loss of coordination. Long-term effects from exposure may include liver, kidney, and central nervous system damage. In addition, formaldehyde is a suspected carcinogen.

Although its use is regulated by both EPA and the Department of Housing and Urban Development (HUD), formaldehyde is still widely used in the makeup of such building materials as plywood, particle board, and urea-formaldehyde foam insulation (UFFI). It can be found in carpeting and furniture made with pressed wood products, permanent press drapes, and some glues. Also, like asbestos, formaldehyde has been extensively used in insulation.

To reduce exposure to formaldehyde, use "exterior grade" pressed wood products which release less of the chemical. Also, use air conditioning and dehumidifiers to maintain moderate temperatures and reduce humidity levels. Finally, increase ventilation, particularly after bringing new sources of formaldehyde into your home.

Organic Solvents

Solvents—fluids that dissolve other substances—can cause a variety of irritations, injuries, and diseases if used improperly. Inhaling these substances can irritate the mucous membranes of the throat and lungs, and can also produce nausea, headaches, muscular weakness, drowsiness, and impaired motor response. Eye irritation or injury can result from absorption. Certain solvents can even cause liver damage.

Water, the most familiar and universal of solvents, is often used as a base for other solvents. Most household solvents, however, are petroleum-based. Because of their ability to dissolve oily materials (including skin oils), many organic solvents can easily enter the body. Solvents are found in paints, paint thinners and strippers, floor polish, cleansers and disinfectants, spot removers, and rug cleaners. In addition to emitting toxic vapors, many of these products are highly flammable, requiring careful attention to storage instructions.



*Many household organic solvents can damage the skin as well as emit harmful vapors. Some acids and bases with corrosive properties can cause severe internal damage or death if ingested in even **small** quantities.*

Most cleaners and strippers can harm the skin, and emit harmful organic vapors. Phenol and cresol (cresylic acid) are particularly harmful ingredients that exist in some of these products. Both can cause extremely painful burning if spilled on the skin, and can be readily absorbed into the bloodstream, harming vital organs. Neither chemical can be removed from leather and other organic products. If leather shoes or similar articles were to become contaminated, they would have to be discarded.

To reduce exposure to solvents, wear protective clothing, including solvent-resistant gloves, when using these products. Protective goggles may also be required (check the product's label for specific instructions). For all organic solvents, it is important to avoid touching your eyes when your hands are contaminated.

Even though solvents dry quickly, the vapors linger in the air. Work outside with solvents whenever possible, or use in well-ventilated areas. All organic solvents, at **any** level of exposure, are considered dangerous to pregnant women at **any** stage of the pregnancy.

If an accident occurs involving organic solvents, the victim must be immediately moved to receive fresh air and emergency medical care. Eyes must be rinsed continually with clear water for at least 15 minutes after contact with a solvent; any exposed skin must be washed with soap and water and rinsed thoroughly.

Pesticides

Pesticides are **poisons**, whether used in the flea collars of pets, on lawns, in gardens, or sprayed indoors to combat vermin and

rodents. In sufficient quantity, pesticides can be injurious or even fatal if ingested, absorbed through the skin, or inhaled. In California alone, there are an estimated 14,000 incidents of pesticide exposure per year which result in requests for medical assistance. Most of these involve children and occur in the home or garden.

Pesticide poisoning is sometimes mistaken for the flu: symptoms may include headaches, nausea, dizziness, and overall aches. Some pesticides remain in the environment for a long time, resisting natural means of breakdown and decomposition. Besides destroying harmful insects, some pesticides can also destroy plants, pets, **beneficial** insects, and other wildlife. Some authorities believe that as many as 50 percent of all pesticides have not been adequately tested for their ability to cause cancer or birth defects.

Public interest has spurred research on alternatives to pesticides and increased public use of these alternatives. Examples include:

- Importing known, natural predators such as praying mantises and ladybugs to help control pests; these beneficial insects may be purchased from some retailers.
- “Comparison planting”—for example, nasturtiums and rue are repellant to many insects.
- Insecticidal soap for plants.

Additionally, removing plant debris and wood from a garden will make it less attractive to insects.

There are also various homemade, nonpolluting alternatives to pesticides—e. g., pepper (the taste of which repels many insects), beer (to attract and kill slugs and snails), and salt (to kill crabgrass). Additional alternatives may be found in a number of commonly available books and pamphlets on organic gardening.

Acids and Bases

Acids and bases are common chemicals found in both household and work environments, which can often cause severe burns or even permanent destruction to organic tissue. Certain acids and bases can also cause death.

Household acids are found in many tub and tile cleaners and toilet bowl cleaners, and are also found (in much stronger concentrations) in car batteries.

Bases are the chemical opposites of acids, and frequently have chemical names that end in hydroxide, oxide, or -amine. Bases often contain lye or sodium hydroxide, which is highly corrosive to body tissue and can also cause burns. The degree of the burn depends on the amount of chemical exposure as well as an

individual's sensitivity to the chemical. Lye is most commonly found in drain openers and oven cleaners; most drain opener accidents involve children whose mouth, face, esophagus, or stomach is burned by the lye.

When an acid is mixed with a base, the substances react—often violently. While a waste treatment facility can combine these substances in proportions that will render the mixture harmless, a chance encounter in a garbage can could cause an accident. Small quantities of acids and bases can be diluted and safely disposed of in the drain, but larger quantities should be taken to hazardous waste disposal facilities or drop-off locations designated by the local government. Acids and bases should also be stored separately.

HAZARDOUS CHEMICALS IN COMMON HOUSEHOLD PRODUCTS

CHEMICAL	CONSUMER PRODUCTS	HEALTH EFFECTS
Carbon tetrachloride	Paint/varnish remover, liquid degreasers, spot removers, old fire extinguishers	Suspected carcinogen; liver and kidney damage
Trichloroethylene	Cleaning fluid, strippers, upholstery cleaner	Suspected carcinogen; CNS and organ damage
Toluene	Spray paint, paint thinners, glue, cosmetics, gasoline	Possible reproductive hazard, liver and kidney damage
Tetrachloroethylene (PERC)	Stain remover, paint stripper, contact cement, degreasers, wax removers, shoe polish, pesticides, rug cleaner	Suspected carcinogen and mutagen; liver and blood damage
M-xylene	Spray paint, paint removers, degreasers, gasoline	Possible reproductive hazard; liver and kidney damage
Naphthalene	Bathroom deodorant, insecticides, moth repellent, rug cleaners	Liver damage; blood disorders
Benzenes	Spot removers, gasoline	Carcinogen
Chloroform	Cough medicine, liniments	CNS depression; liver and kidney damage
O-phenylphenol	Disinfectants, preservatives	CNS depression; irritant
Phenol	Disinfectants, deodorants, furniture polish	May cause severe burns upon skin contact; CNS depression
Chlorobenzenes	Deodorizers, dyes, metal polish, moth repellents, disinfectants	Irritant; possible liver and kidney damage
2,4, 5-T	Pesticides	Suspected animal carcinogen, may contain dioxin
Pentachlorophenol	Wood preservatives	Toxic to liver, kidney, and CNS; contains hexachlorobenzene, which is carcinogenic in rats and mice; may contain dioxin
Methylene chloride (dichloromethane)	Pain relievers, degreasers, refrigerants	Respiratory irritant; CNS depression; alters ability of blood to carry oxygen to body tissue

USING AND STORING HOUSEHOLD HAZARDOUS MATERIALS

Understanding Product Labels

Product labels for hazardous materials provide much useful information concerning dangers and precautions for use and disposal. For example, the signal word—required to be prominently displayed on the label—indicates the degree of danger that may be created by the chemicals in the product:

- **DANGER**—the *highest* degree of hazard
- **WARNING**—*intermediate* degree of hazard
- **CAUTION**—the *lowest* degree of hazard

The most commonly used consumer products are not without hazardous side effects.

Additionally, if the danger is due to ingestion, inhalation, or dermal contact, **the label may have a picture of a skull and crossbones**. Children can be attracted by this picture, however, so the American National Standards Institute (ANSI) has developed a system that uses words instead of symbols. These ANSI labels also warn of short- and long-range

hazards, including any chronic health effects, reproductive disorders, or cancer-causing properties associated with the product. At right is an example of an ANSI label.

Reducing Risks From Household Products

Household hazardous materials should be stored and used carefully and appropriately. The following suggestions will help you reduce your family's risk of harmful exposure to household hazardous materials:

1. Read the label before purchasing a product containing hazardous materials. If you decide to buy the product, take the responsibility for using and disposing of it properly.
2. Buy only the amount you will use in the near future. Except for medicines and certain pesticides, give any "leftovers" to someone who can use them **properly**.
3. Always keep substances in their **original** containers, and make sure that the labels are securely attached. Label information is vital in the event of adverse reactions from the product.
4. Consider keeping a list of any hazardous products you store in your home. Include the name of the product, date of purchase, and emergency care information.
5. Keep all household products in a cool, dry place, securely out of the reach of children and pets. Check containers periodically for deterioration, and ensure that lids are kept tightly closed. Dispose of products immediately and appropriately when they reach their stated expiration date.
6. Incompatible chemical products should be stored separately. To find out which chemicals in your household are incompatible, check with your local or State office of public health.
7. Carefully read and follow directions for product use. Use products only at their recommended strength (dilution). Never mix chemical substances. If you are using several substances one after another, rinse all traces of the first away before using the second. Wear appropriate protective clothing, goggles, or gloves. Prevent splashing, and work only in well-ventilated areas.

PINE AWAY CLEANER AND DISINFECTANT

Pine Oil: 30%
Soap: 11%

Isopropanol: 9%
Inert Ingredients: 50%

CAUTION! Harmful if swallowed. Do not get in eyes. May cause severe eye irritation. Avoid contamination of food.
FIRST AID: In case of eye contact, immediately flush with water. If swallowed, do not induce vomiting. Promptly drink a large quantity of milk or egg whites. Call a physician.

A sample label for a product containing hazardous ingredients, in the format recommended by the American National Standards Institute (ANSI).

ALTERNATIVES TO HOUSEHOLD HAZARDOUS MATERIALS

HOUSEHOLD:

Drain cleanser	Pour boiling water down the drain. To clean pipes and avoid clogging, use two handfuls of salt followed by boiling water.
Sink de-clogger	One or two handfuls of baking soda, followed by 1/2 cup vinegar; let set for an hour before running water through.
Laundry detergent	Use a non-detergent, natural laundry soap. To brighten colors, add 1/2 to 1 cup vinegar.
Brass cleaner	Mix equal parts of salt and flour. Add enough vinegar to make a stiff paste. Cover surface and allow to dry, then quickly rinse off.
Silver polish	Combine 1 quart water, 1 teaspoon baking soda, and 1 teaspoon salt. Add a piece of aluminum foil to this solution; soak silver until shiny.
Furniture polish	Mix 1/2 cup vinegar, 1/2 cup rubbing alcohol, and 1 cup linseed oil. Shake well before using.
Oven cleaner	Line oven with aluminum foil. Sprinkle salt on spills while still warm. Scrub with baking soda and water.

DEODORIZERS:

Air freshener	Set out a dish filled with warm vinegar, or add cloves and cinnamon to boiling water and allow to simmer.
Bathroom odors	Quickly eliminate noxious odors in bathroom by lighting a match; this literally burns off gases.

HOME INSECT CONTROL:

Cockroaches and ants	Sprinkle equal parts of confectioners sugar and borax (i.e., boric acid) in dry areas where these pests are found. (Use extreme caution, because boric acid is toxic.)
Flies	Repel with mint plants in windowsills.
Other houseplant pests	Wash leaves with soapy water (1 lb. non-detergent soap to 5 gallons water); rinse.

GARDEN:

Aphids	Repel with garlic, chives, petunias, and nasturtiums.
Other pests	Many insects are repelled by the smell and taste of pepper.
Slugs and snails	Pour beer in a flat receptacle and place below ground level in the infested area.
Crabgrass	Place a teaspoon (or less) of salt in the center of each offending plant.

Adapted from Environmental Health Watch, "Citizen Fact Sheet #3: Alternatives to Hazardous Household Chemicals" (Cleveland: Environmental Health Watch) and David Robertson, et al., "Liquid Household Hazardous Wastes in the United States: Identification, Disposal, and Management Plan," *Environmental Management*, Vol. 11, No. 6.

These simple alternatives can eliminate the need for many hazardous materials commonly found in the home.

organic compounds may cause sickness and have to be removed. Workrooms where substances with toxic vapors are used must be adequately ventilated.

Another approach to lowering the concentrations of hazardous air in the home is to increase the amount of outside air allowed indoors. Opening windows and doors, when the weather permits, increases the natural ventilation rate. Similarly, turning on bathroom or kitchen exhaust fans, if they are vented to the outdoors, can lower

8. Use natural, less toxic products or alternatives whenever possible. A list of several common alternatives appears at left.
9. Place the phone number of the poison control center and your local emergency medical service on or beside your telephone.
10. Be prepared to provide first aid' during chemical-related and other emergencies by taking a First Aid and CPR course (such as those offered by your local Red Cross chapter).

Improving Household Ventilation and Air Quality

When there is a low **air exchange rate** (the rate at which outside air replaces indoor air), the pollutant levels created by household products containing hazardous chemicals can increase.

Usually, the most effective way to improve indoor air quality is to eliminate individual sources of pollution. Some sources, like those containing asbestos, can be sealed or enclosed. New carpeting that contains sufficient quantities of formaldehyde or other volatile

pollution levels by removing contaminants from the room where the fan is located.

Another way to increase the air exchange rate is to install heat recovery ventilators to filter pollutants from the air. Your local utility company or heating/air conditioning contractor is a good source for more information on this option.

It is particularly important to take as many of these steps as possible while you are involved in short-term activities that can generate high levels of pollutants—for example, painting or paint stripping, or maintenance and hobby activities such as welding, soldering, or sanding. If practical, you might choose to do some of these activities outside. In addition, you should remain alert to signs of inadequate airflow, such as stuffy air, moisture condensation on cold surfaces, or mold or mildew growth.

FIRST AID

If someone shows symptoms of toxic effects from household products, they should be treated **immediately**. The steps to be performed will vary depending on the toxic substance, how the victim was exposed to the substance (swallowed, inhaled, or contact with skin), and the specific first aid procedures recommended by the Poison Control Center or professional medical personnel.

First Aid Measures You Can Take Immediately

First, if the rescuer can do so without endangering his or her safety, the victim should be removed from further contact with the hazardous material or its by-products. For instance, if the vapors of the chemical are toxic, the person should be moved outside.

Next, call the Poison Control Center for directions. They will tell you what you can do to help the victim. If the incident requires it you will also notify your local Emergency Medical Services (EMS). Many toxic product labels list first aid measures to be taken in case of exposure, but the directions are not always reliable. Although exposure symptoms may be similar for some chemicals, first aid treatments could still be different. Therefore, your actions should be guided by the Poison Control Center or the EMS.

If an eye should contact a hazardous substance, immediately flush the eye with clear water for at least 15 minutes and get **medical attention**. A few seconds' delay can greatly increase the extent of the injury.

Finally, when the victim is transported for further medical attention,

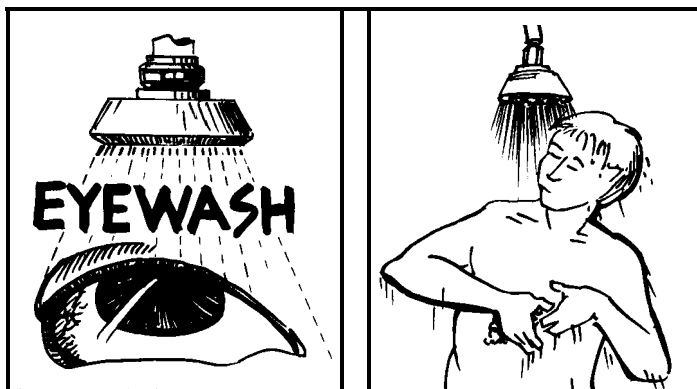

In cases of eye contact with a hazardous substance, flush the eye with clear water for at least 15 minutes and get medical attention. In cases of skin contact, toxic contaminants may be removed by thorough washing.

have the product container and any vomit or excretions from the victim sent with the EMS.

The Poison Control Center

Poison Control Centers are located throughout the country, and are dedicated to handling calls relating to medical emergencies involving poisons. On an average day, a center may handle over 200 calls. Keep the telephone number for the poison control center nearest your home on the inside front cover of your local telephone book and on the phone itself.

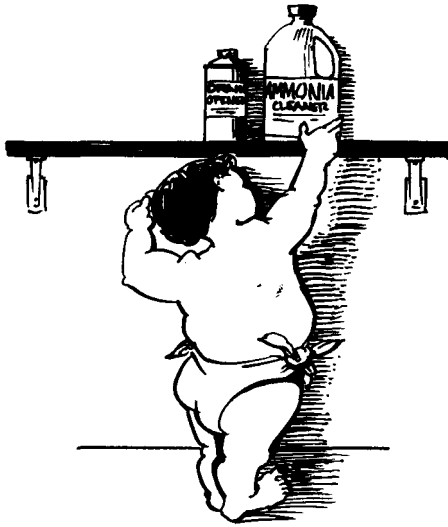

Roughly half of all calls to Poison Control Centers are about accidents involving children.

When you call a Poison Control Center, you will need to have the hazardous material's container close at hand. You will most likely be asked to provide information on the product's name and manufacturer, which will be keyed into a computer database to provide an immediate readout of ingredients, toxic effects, and recommended first aid procedures. You will be "talked through" any steps that require immediate action. The Poison Control Center operator may also be able to directly notify your local rescue personnel.

HAZARDOUS WASTE DISPOSAL

It has been estimated that the average U.S. resident discards approximately one ton of waste each year. It is not known how much of this is hazardous waste. What is becoming increasingly obvious, however, is that the standard approaches to waste disposal are generally inadequate and frequently inappropriate for household hazardous waste. The following section describes current methods of disposing of waste, and some of the associated problems and issues.

Landfills

Landfills currently receive 80 percent of the Nation's total waste. Here, organic items—such as food wastes, leaves and grass—usually decompose quickly. This garbage, however, contains contaminants that can pollute groundwater. The most common form of contamination at a landfill site is **toxic leachate**. Formed as rainwater percolates down through a landfill, leachate carries soluble toxic and hazardous materials absorbed from the garbage downward through the soil.

Landfills must be properly situated to protect groundwater supplies. While technologies exist that can prevent toxic leachate from reaching and contaminating water supplies, the best and newest technologies are often too expensive for a local government's budget. As existing landfills near capacity and fewer new landfills are developed due to public pressure, communities are increasingly challenged by the question of what to do with their refuse. It has been estimated that one-third of the Nation's landfills will be full by 1991.

Incinerators

Incinerators are used by some communities to burn trash and thereby reduce the volume of garbage; however, landfills **must still** be used for the large quantities of resulting ash. Although volume reduction is a **positive** step, incineration raises issues concerning air pollution and the toxicity of the remaining ash. These issues must be addressed before incineration can be considered the best alternative.

Other methods for community waste disposal, especially for toxic wastes, are currently being studied. However, at the time of this writing none have proven satisfactory on a large scale.

Sewer Systems

When poured into the sink, hazardous substances in liquid form may corrode plumbing, collect in the sink's trap and release fumes, and/or cause septic system malfunctions. These toxic substances may also contaminate groundwater supplies.

In most cities and suburban areas, wastes travel through the pipes of individual buildings and directly into the common sewers. The **sewers** are a system of underground pipes that carry liquid wastes from each house, store, and office building, and collect it as sewage in pipes or **trunk lines**.

For decades, sewage was routinely dumped directly into rivers, lakes, and oceans. Many waterways still serve as dumping grounds for millions of gallons of raw sewage each day. Much of this sewage is contaminated; this in turn contaminates the food chain, which means that fish living in a toxic environment absorb or ingest the poisons and pass them onto people who eat the fish.

To **keep** toxic substances out of the water, most cities and towns have some type of sewage treatment plant. Again, however, developing the most up-to-date facilities for treating wastes before they are dumped in waterways is considered by some communities to be prohibitively expensive.

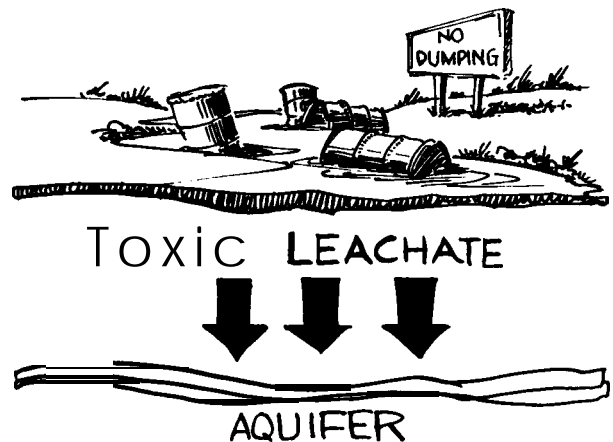

Septic Tanks and Drainfields

In rural areas, buildings are not connected to a sewer system, but rather make use of a **septic tank**—that is, a large underground concrete container through which most sewage eventually drains into the soil.

Landfills must be properly situated to prevent the contamination of groundwater supplies.

While the waste water is in the septic tank, heavier solids (called **sludge**) settle to the bottom. Bacteria in the tank gradually break

down nontoxic wastes. Lighter solids and liquids are discharged into a **drainfield**, a large area of gravel and soil.

As the liquid **percolates** (filters) down through the soil, some pollutants will be slowly decomposed by microorganisms. However, many household toxic wastes will not be broken down by this process, resulting in contamination of the land and local wells.

Of particular concern is the hazardous practice of using septic tank "conditioners" such as trichlorethylene (possibly the most common groundwater contaminant). All of these solvents are toxic, some are carcinogenic, and most are sufficiently water soluble to enter and travel considerable distances in groundwater. To avoid potential contamination of drinking water, avoid the use of conditioners and do not dispose of significant quantities of hazardous wastes by flushing.

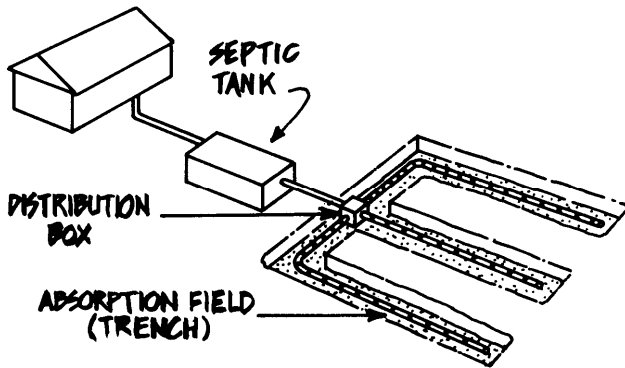

In rural areas, buildings often make use of a septic tank rather than a sewer system for waste disposal. Some toxic wastes flushed into the tank will not break down when they enter the drain field, polluting the soil and possibly the groundwater as well.

Injuries from Household Garbage

Another concern related to proper disposal of household hazardous wastes is that sanitation workers may be seriously injured when handling these substances. In a few cases, sanitation workers have died from exposure to hazardous chemicals placed for routine trash pickup.

Most garbage trucks use automated compactors to increase the amount of trash collected in each trip. When a household hazardous waste, such as a partially used container of furniture stripper, is compacted, the container can explode, causing the released substance to injure the skin or eyes of a sanitation worker.

The inadequacies of these waste disposal methods illustrate the need for better public understanding of safe disposal methods to minimize the risk to sanitation workers, the environment, and the drinking water supply.

Safe Disposal of Household Hazardous Wastes

A large part of the household hazardous waste disposal problem stems from the fact that these wastes are generated on an individual basis, and are likely to be disposed of individually as well. One discarded can of furniture spray, the used motor oil from a single car, or a jar of old prescription medicine do not seem able to threaten an entire waterway—but accumulating in quantity, they can. Ironically, such household waste is easier to handle in **larger** quantities: commercial hazardous waste disposal facilities will not accept household hazardous wastes unless they are collected and combined.

How should you dispose of your household waste? How can you help your community tackle its hazardous waste problem?

The safest way to get rid of hazardous household products is to use them until they are gone. If this is not possible, give the product (in its original container) to someone who can use it up appropriately and legally. Try **to recycle the material, if possible**. If your community has no recycling program appropriate for the material, refer to the product's label for any directions on disposal.

In general, when disposing of **hazardous** household products, do **Not**:

- Pour them into storm sewers
- Pour them into septic tanks
- Bury chemicals or containers in the yard or garden
- Burn chemicals or containers
- Mix chemicals together

In addition, significant quantities of a hazardous substance should not be thrown in the trash or poured down the drain. Some household products should not ever be disposed of in this way. Consult the product label for disposal directions.

In many jurisdictions, it is illegal as well as unsafe to dispose of hazardous products improperly. Product labels for hazardous household substances normally list safe disposal methods for the specific product; in addition, the table on the following page provides a number of proven methods for the safe disposal of specific household hazardous materials.

Community Collection Days

Concern over household hazardous waste has prompted more than 600 communities across the country to hold hazardous waste collection day programs. Held once or twice a year, these days offer residents an opportunity to safely dispose of their hazardous wastes. Collection days (sometimes sponsored in their entirety by government agencies, at other times a combination of private and public sector resources) have been increasingly popular across the country. Besides allowing for safe disposal of toxic wastes, these collection days offer opportunities for public education about the dangers and proper use and disposal of hazardous wastes. After collection, communities usually transport their household hazardous wastes to specially designed landfills; in some communities, these wastes are recycled. Several commercial companies dealing with hazardous waste disposal are researching disposal alternatives such as using chemicals to detoxify wastes, since many of the special landfills are becoming full. Moreover, some areas are devising creative options for reuse: Rhode Island, for instance, collects motor oil and uses it in the State's maintenance garages.

The most significant achievement of the community collection day is the ability to treat household wastes innovatively and efficiently by consolidating the waste. However, considerable time, money,

SAFE DISPOSAL OF HOUSEHOLD HAZARDOUS MATERIALS

AUTOMOTIVE PRODUCTS:

Used motor oil, transmission/brake fluid	Recycle+take to area auto center or service station.
Batteries	Recycle+take to battery retailer.
Antifreeze	Pour amounts of less than 4 gallons down drain, or mix with cat box filler or sawdust and discard in trash. DO NOT pour into septic tank.
Gasoline	Allow small quantities to evaporate outdoors, away from children and pets,
Battery acid	Add small amounts of acid to water to dilute; mix with baking soda to neutralize, and flush down drain.

PESTICIDES:

Toxic pesticides	Avoid use of extremely toxic pesticides. If use is unavoidable, never discard by dumping down the drain or on the ground. Deliver unused pesticides to a hazardous waste collection program.
Insecticides, herbicides, rodent bait	Use up; follow container disposal instructions, or rinse container three times and use rinse water as a pesticide. Wrap empty container in newspaper; discard with trash.

CLEANERS:

Bleach, disinfectant, drain and toilet cleaners	Use up, if possible; if this cannot be done, dilute with large amounts of water and flush down drain. Do not flush into septic tank.
Polish and powdered cleansers	Discard in trash.
Oven cleaner	Solidify by mixing with cat box filler or sawdust; discard in trash.
Spot remover	Allow to evaporate outdoors, away from children and pets; discard empty container in trash.

PAINTS AND SOLVENTS:

Paint and varnish	Use up if not possible, allow to evaporate outdoors in its original container until solidified, away from children and pets; discard container in trash.
Turpentine, thinner, and stripper	Allow paint particles to settle in closed container, then strain off liquid for re-use. Wrap sludge in newspaper and discard in trash.

MISCELLANEOUS:

Photographic chemicals	Flush small amounts down drain, or solidify with cat box filler or sawdust and discard in trash.
Smoke detectors	Return to the manufacturer.
Gas cylinders	Return to the retailer.
Old medicines	Flush down drain.

Adapted from Environmental Health Watch, "Citizen Fact Sheet #4: A Guide to Safe Disposal" (Cleveland: Environmental Health Watch).

and publicity are required to make it work. Also, if collections do not occur with sufficient frequency, hazardous wastes can accumulate to undesirably high levels in the home.

Permanent Drop-Off Facilities

A more efficient and convenient method of community household waste disposal is to establish *permanent* facilities for hazardous waste storage and transfer. Residents would not have to store materials in their homes for six months or more between community collection days, and long lines would be eliminated. Some areas of the country—like San Bernadino County, California, and Martha's Vineyard, Massachusetts—have taken this step and established permanent drop-off facilities.

Commercial development of such permanent sites has been considered, but has not yet proven viable. If a company were to establish such a drop-off point, some means of paying for the handling and disposal of the waste must be devised. Although the idea of a user fee (to be paid by the disposing homeowner) is attractive, it may be so high that it would discourage participation. Surveys have shown that people are willing to spend \$10 to \$25 per carload/per year to dispose of household hazardous wastes. Hiring employees, obtaining liability insurance, and building the facility must also be considered. At present, these facilities are not economically attractive enough to stimulate unsubsidized private development.

It is often illegal, as well as unsafe, to dispose of hazardous materials improperly. While product labels are the best source of safe disposal methods for a particular substance, a number of more general methods have been proven to be safe and effective.

What Communities Are Doing

The following paragraphs describe recent or ongoing community waste disposal programs. These are included to help you determine if similar programs are or can be implemented in your community.

- Florida's** "Amnesty Day" program, the first collection program in the country to be funded and operated entirely by the State, was financed through Florida's Water Quality Assurance Trust Fund. The program served not only homeowners but also small businesses, farms, and institutions. Over the past two years, 7,000 residents disposed of 351 tons of hazardous waste.
- Rhode Island** provides innovative recycling opportunities through its collection program. Funding for the program, which has been operational for several years, comes from a special bond authorization which was voted into effect by the general public.
- The **Massachusetts** Household Hazardous Waste program, "Operation Clean Sweep," has a matching grant program which pays 50 percent of the cost of collection while individual towns supply matching funds.
- In **Iowa**, retailers selling products designated as household hazardous wastes must apply for a permit each year. Revenues generated by the permit fees go toward funding household hazardous waste collection days. Retailers must also label the area where hazardous products are displayed, and must provide the public with consumer information booklets on the use and disposal of household hazardous wastes.
- The San Bernadino County, California**, Health Department has two permanent collection facilities, one at the county agricultural center and one at a fire department. Although the issue of liability has been discussed, the county is self-insured. Employees of the health and fire department unload, sort, and package the wastes, and a hazardous waste contractor picks up the material on a regular basis.

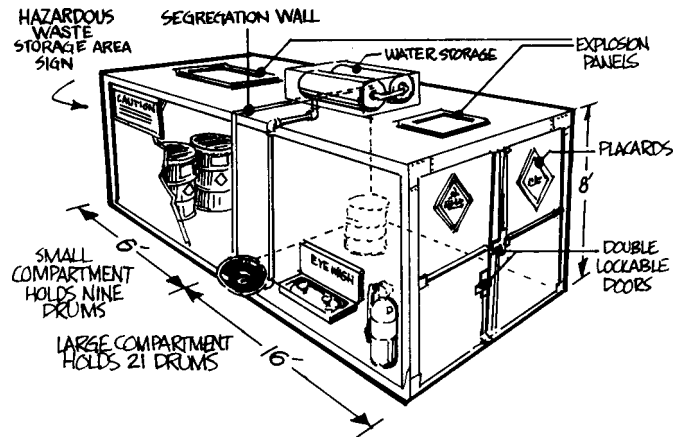

Some areas of the country have established permanent drop-off facilities for hazardous waste. This drawing depicts the storage area designed by San Bernadino County, California, for its permanent drop-off site.

Suggestions like the ones just described can be modified to meet the needs of your community's volume of hazardous wastes and the funds available to spend on the problem.

What You Can Do

If your community currently has no educational or collection

programs for hazardous wastes, you may want to take some aggressive action to fill the gap. Citizens can work toward having their communities set up a hazardous waste collection day or a permanent facility through persistence and effective organization. Steps in this process include:

1. Discover all you can about the disposal problem in general and in your community in particular.
2. Decide who else to include in your campaign. If your local government officials tend to be responsive, a direct approach may work. If not, you may need to organize local groups or individuals to help your cause.
3. You can lobby directly for government funding, changes in State and local ordinances to obtain funding through bonds or user permits, or changes to State and local laws that will protect against toxic wastes. For example, promote **source reduction—fewer** toxic constituents in products mean less toxic waste to dispose of.

SUMMARY

While we often attribute our Nation's problems with hazardous materials to industry, we forget that as consumers we voluntarily buy and store materials with harmful properties in our own homes, contributing to our community's collective exposure as we use and dispose of them. Among materials commonly found in homes are lead, asbestos, formaldehyde, organic solvents, pesticides, and acids and bases. It is important for us as consumers to lower household exposures to toxic chemicals by using non-toxic substitutes where we can and ensuring adequate ventilation. Further, by keeping the number of the Poison Control Center on the phone, we can be prepared to assist someone in our home who is injured by a toxic product. Always read the label of chemicals you bring into your home so you know what harmful effects they might have and how to use them properly.

Toxic products are disposed of at landfills and incinerators, and at the home level through flushing them into the sewer system or septic tank. This can be dangerous for many toxic products. Disposal in the trash can also injure sanitation workers. The safest way to dispose of significant quantities of hazardous waste is through community collection programs which can treat the waste properly. Many communities have active programs to provide for safe disposal of potentially harmful products. ■

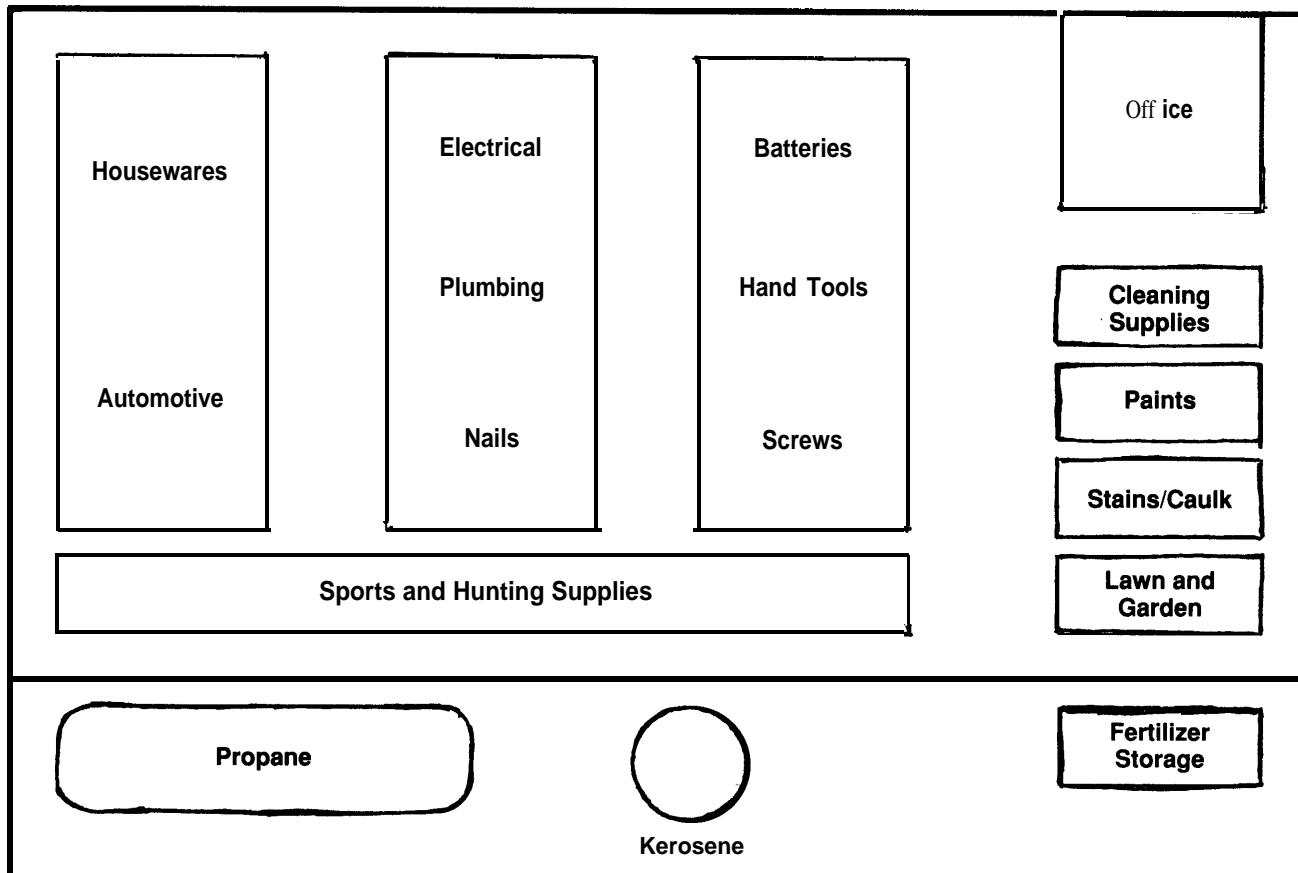
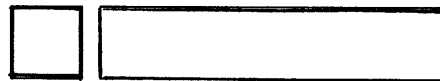

Diagram of BOB'S HARDWARE STORE

Truck Parking



HAZ MAT TEASER
(answers on page A-3)

Hazardous materials can be found in a variety of places, often where you least expect them. For example, the average hardware store in your community offers a variety of commonly used household products containing hazardous materials. If these products are used according to their label directions, most can be considered safe; however, if they should break, spill, or become involved in a fire, they have the potential to become deadly. Mark the numbers corresponding to the hazardous materials shown below on the diagram of Bob's Hardware Store pictured above, to indicate the store department(s) where each hazardous material might be found. Note: Some numbers may be used more than once.

In which department(s) of the hardware store might you find:

- | | | | |
|--------------------|-----------------|------------|---------------|
| 1. Acids and bases | 3. Formaldehyde | 5. Phenols | 7. Pesticides |
| 2. Flammables | 4. Solvents | 6. Poisons | |

As you walk through the store, your child accidentally knocks a bottle of caustic drain cleaner off a shelf. Part of its contents splash onto your leg. What first aid steps would you immediately take? Who would you call for additional first aid information?

CHECK YOUR MEMORY

(answers on page A-4)

1. If you discover that loose asbestos was used as a pipe covering in your basement, you should:
 - a. Not worry about it, because there is insufficient evidence that it is a hazard
 - b. Shake it loose with gardening or cleaning tools and throw it away
 - c. Remove it only if it is damaged or deteriorated
 - d. Call a qualified contractor to remove it

2. Phenol and **cresol** are particularly harmful ingredients that can be found in some _____
 - a. Cleaners and strippers
 - b. Paints
 - c. Glues
 - d. Carpets

3. Which of the following is **not** typically an organic solvent?
 - a. Paint thinner and stripper
 - b. Floor polish
 - c. Drain cleaner
 - d. Rug cleaner

4. Which of the following warning labels indicates the **highest** degree of hazard?
 - a. Danger
 - b. Warning
 - c. Caution

5. If someone in your house gets a toxic substance in the eye, you should **FIRST**:
 - a. Take him/her to the emergency room
 - b. Telephone the doctor for instructions
 - c. Begin flushing the eye with clear water
 - d. Take him/her outside to fresh air

6. When you wish to dispose of a hazardous household substance and you cannot find anyone to use it up, the best option is to:
 - a. Throw it in the trash
 - b. Pour it down the drain
 - c. Take it to a legally designated drop-off site
 - d. Bury it in your yard

7. The following is an example of a successful approach to collecting hazardous waste:
 - a. Community collection days
 - b. A permanent drop-off point
 - c. An open landfill
 - d. Both a and b

GLOSSARY

Absorption	The passing of a substance into the circulatory system of the body. Also used specifically to refer to entry of toxicants through the skin.
Acute Exposure	An exposure to a toxic substance which occurs in a short or single time period.
Acute Toxicity	Any poisonous effect produced by a single short-term exposure. The LD_{50} of a substance (the lethal dose at which 50 percent of test animals succumb to the toxicity of the chemicals) is typically used as a measure of its acute toxicity.
Additive Effect	A biological response to exposure to multiple chemicals which is equal to the sum of the effects of the individual agents.
Adsorption	The bonding of chemicals to soil particles or other surfaces.
Aerosol	A solid particle or liquid droplet suspended in air. An aerosol is larger than a molecule and can be filtered from the air.
Antagonism	The situation in which two chemicals interfere with each other's actions, or one chemical interferes with the action of the other.
Aquifer	An underground bed, or layer, of earth, gravel, or porous storage that contains water.
Asphyxiants	Chemicals that starve the cells of an individual from the life-giving oxygen needed to sustain metabolism.
Biodegradable	Capable of decomposing quickly through the action of microorganisms.
Biomagnification	The tendency of certain chemicals to become concentrated as they move into and up the food chain.
Boiling Point	The temperature at which a liquid will start to become a gas, and boil. A chemical with a low boiling point can boil and evaporate quickly. If a material that is flammable also has a low boiling point, a special fire hazard exists.
Carcinogen	A chemical or physical agent that encourages cells to develop cancer.
Central Nervous System Depressants	Toxicants that deaden the central nervous system (CNS), diminishing sensation.
CERCLA	The Comprehensive Environmental Response, Compensation, and Liability Act of 1980—the Federal statute that authorized “Superfund.” Administered by EPA, the law provides funding for cleanups and emergency response actions for hazardous substances at the worst

Hazardous Materials: A Citizen's Orientation/Glossary

CERCLA (continued)	hazardous waste sites in the United States, CERCLA is also significant because it set the first criteria for notification of emergencies involving hazardous substances. Superfund regulates abandoned waste disposal sites; for active disposal site regulation, see RCRA .
CHEMTREC	Chemical Transportation Emergency Center, a service operated by the Chemical Manufacturers Association to provide information and other assistance to emergency responders.
Chronic Exposure	Process by which small amounts of toxic substances are taken into the body over an extended period.
Command Post	A centralized base of operations established near the site of a hazardous materials incident.
Corrosive	A chemical that destroys or irreversibly alters living tissue by direct chemical action at the site of contact.
Decontamination	The process of removing or neutralizing contaminants that have accumulated on personnel and equipment. This process is critical to health and safety at hazardous waste incidents.
Dermal Exposure	Exposure to toxic substances by entry through the skin.
Dose	The quantity of a chemical absorbed and available for interaction with metabolic processes.
Epidemiology Studies	Investigation of factors contributing to disease or toxic effects in the general population.
Evaporation Rate	The rate at which a chemical changes into a vapor. A chemical that evaporates quickly can be a more dangerous fire or health hazard.
Exercise	A simulated emergency condition carried out for the purpose of testing and evaluating the readiness of a community or organization to handle a particular type of emergency.
Explosive	A chemical that causes a sudden, almost instantaneous release of pressure, gas, and heat when subjected to sudden shock, pressure, or high temperatures.
Extremely Hazardous Substance (EHS)	Any one of over 300 hazardous chemicals on a list compiled by EPA to provide a focus for State and local emergency planning activities.
Fate	The transport and transformation of a pollutant.
Hazard Class	A group of materials, as designated by the Department of Transportation, that share a common major hazardous property such as radioactivity or flammability.

Hazardous Materials Response Team (HMRT)	A team of specially trained personnel who respond to a hazardous materials incident. The team performs various response actions including assessment, firefighting, rescue, and containment; they are not responsible for cleanup operations following the incident.
Incident Commander	The person in charge of on-scene coordination of a response to an incident, usually a senior officer in a fire department.
Inversion	An atmospheric condition caused by a layer of warm air preventing cool air trapped beneath it from rising, thus holding down pollutants that could otherwise be dispersed.
Irritant	Chemicals which inflame living tissue by chemical action at the site of contact, causing pain or swelling.
LD₅₀	The calculated dosage of a material that would be fatal to 50% of an exposed population (Lethal Dose 50%).
Leachate	Material that pollutes water as it seeps through solid waste.
Leaching	The process by which water dissolves nutrient chemicals or contaminants and carries them away, or moves them to a lower layer.
LEPC	Local Emergency Planning Committee.
LOAEL	The Lowest Observed Adverse Effect Level, i.e., the lowest dose which produces an observable adverse effect.
Medium	The environmental vehicle by which a pollutant is carried to the receptor (e.g., air, surface water, soil, or groundwater).
Melting Point	The temperature at which a solid material changes to a liquid. Solid materials with low melting points should not be stored in hot areas.
MSDS (Material Safety Data Sheet)	A worksheet required by the U.S. Occupational Safety and Health Administration (OSHA) containing information about hazardous chemicals in the workplace. MSDSS are used to fulfill part of the hazardous chemical inventory reporting requirements under the Emergency Planning and Community Right-to-Know Act.
Mutagen	A chemical or physical agent that induces a permanent change in the genetic material.
NOAEL	No Observable Adverse Effect Level.
Organic Compound	Chemicals that contain carbon. Volatile organic compounds vaporize at room temperature and pressure. They are found in many indoor sources, including many common household products and building materials.
OSHA	The Occupational Safety and Health Administration, part of the Department of Labor.

Hazardous Materials: A Citizen's Orientation/Glossary

Pathway	A history of the flow of a pollutant from source to receptor, including qualitative descriptions of emission type, transport, medium, and exposure route.
PEL	Permissible Exposure Limits set by OSHA as a guide to acceptable levels of chemical exposure.
Percent Volatile	The percentage of a chemical that will evaporate at ordinary temperatures. A high volatile percentage may mean there is more risk of explosion, or that dangerous fumes can be released. Evaporation rates are a better measure of the danger than the percent volatile measure.
pH	The pH is a measure of how acidic or caustic a chemical is, based on a scale of 1 to 14. A pH of 1 means the chemical is very acidic. Pure water has a pH of 7. A pH of 14 means the chemical is very caustic. Both acidic and caustic substances are dangerous to skin and other valuable surfaces.
Poison	A chemical that, in relatively small amounts, is able to produce injury by chemical action when it comes in contact with a susceptible tissue.
RCRA	The Resource Conservation and Recovery Act (of 1976). A Federal statute which establishes a framework for proper management and disposal of all wastes. Generation, transportation, storage, treatment, and disposal of hazardous wastes are all regulated under this Act.
Risk Assessment	<p>Broadly defined as the scientific activity of evaluating the toxic properties of a chemical and the conditions of human exposure to it, with the objective of determining the probability that exposed humans will be adversely affected. Its four main components are:</p> <ol style="list-style-type: none">1. Hazard Identification—Does the agent cause the effect?2. Dose-Response Assessment--What is the relationship between the dose and its incidence in human beings?3. Exposure Assessment—What exposures are experienced or anticipated, and under what conditions?4. Risk Characterization-The total analysis producing an estimate of the incidence of the adverse effect in a given population.
Runoff	Water from rain, snow melt, or irrigation that flows over the ground surface and returns to streams.
SARA	Superfund Amendments and Reauthorization Act of 1986.
SERC	State Emergency Response Commission.

Volubility in Water	An indicator of the amount of a chemical that can be dissolved in water, shown as a percentage or as a description. A low percent of volubility (or a description of "slight" volubility or "low" volubility) means that only a small amount will dissolve in water. Knowing this may help firefighters or personnel cleaning a spill.
Specific Gravity	A comparison of the weight of the chemical to the weight of an equal volume of water. Chemicals with a specific gravity of less than 1 are lighter than water, while a specific gravity of more than 1 means the chemical is heavier than water. Most flammable liquids are lighter than water.
Synergistic Effect	A biological response to exposure to multiple chemicals which is greater than the sum of the effects of the individual agents.
Systemic Toxicants	Chemical compounds that affect entire organ systems, often operating far from the original site of entry.
Teratogen	A material that produces a physical defect in a developing embryo.
Threshold	The lowest dose of a chemical at which a specific measurable effect is observed. Below this dose, the effect is not observed.
Title III	The third part of SARA, also known as the Emergency Planning and Community Right-to-Know Act of 1986.
TLV	Threshold Limit Values, which are the calculated airborne concentrations of a substance to which all workers could be repeatedly exposed eight hours a day without adverse effects.
Totally Encapsulated Suits	Special protective suits made of material that prevents toxic or corrosive substances or vapors from coming in contact with the body.
Toxicity	The degree of danger posed by a substance to animal or plant life.
Toxicology	The study of the adverse effects of chemicals on biological systems, and the assessment of the probability of their occurrence.
Transformation	The chemical alteration of a compound by processes such as reaction with other compounds or breakdown into component elements.
Transport	Hydrological, atmospheric, or other physical processes that convey pollutants through and across media from source to receptor.
Vapor Density	The measure of the heaviness of a chemical's vapor as compared to the weight of a similar amount of air. A vapor density of 1.0 is equal to air. Vapors that are heavier than air may build up in low-lying areas, such as along floors, in sewers, or in elevator shafts. Vapors that are lighter than air rise and may collect near the ceiling.

Hazardous Materials: A Citizen's Orientation/Glossary

Vapor Pressure	The measure of how quickly a chemical liquid will evaporate. Chemicals with low boiling points have high vapor pressures. If a — chemical with a high vapor pressure spills, there is an increased risk of explosion and a greater risk that workers will inhale toxic fumes.
Volatilization	Entry of contaminants into the atmosphere by evaporation from soil or water.
Workers Right-to-Know	Legislation mandating communicating of chemical information to employees. A regulatory initiative by OSHA, and an antecedent to Community Right-to-Know.

MEMBER AGENCIES OF THE NATIONAL RESPONSE TEAM

Federal Emergency Management Agency

Technological Hazards Division
Federal Center Plaza
500 C Street, S.W.
Washington, DC 20472
(202) 646-2861

U.S. Environmental Protection Agency

OSWER Preparedness Staff
401 M Street, S.W.
Washington, DC 20460
(202) 475-8600
(479-2449 in Washington, DC area)

U.S. Environmental Protection Agency

OERR Emergency Response Division
401 M Street, S.W.
Washington, DC 20460
(202) 475-8720

**Agency for Toxic Substances
and Disease Registry**

Department of Health and Human Services
Chamblee Building 30S
Atlanta, GA 30333
(404) 452-4100

U.S. Department of Energy

1000 Independence Avenue S.W.
Washington, DC 20585
(202) 252-5000

Department of Agriculture

Forest Service
P.O. Box 96090
Washington, DC 20013-6090
(703) 235-8019

Department of Labor

Occupational Safety and Health Administration
Directorate of Field Operations
200 Constitution Avenue, N.W.
Washington, DC 20210
(202) 523-7741

U.S. Coast Guard (G-MER)

Marine Environmental Response Division
2100 2nd Street, S.W.
Washington, DC 20593
(202) 267-2010

U.S. Department of Transportation

Research and Special Programs Administration
Office of Hazardous Materials Transportation
(Attention: DHM-50)
400 7th Street, S.W.
Washington, DC 20590
(202) 366-4000

Department of Justice

Environmental Enforcement Section
Room 7313
10th and Constitution, N.W.
Washington, DC 20530
(202) 633-3646

Department of the Interior

18th and C Streets, N.W.
Washington, DC 20240
(202) 343-3891

Department of Commerce

NOAA-Superfund Program Coordinator
11400 Rockville Pike
Rockville, MD 20852
(301) 443-8465

Department of Defense

OASD (A+L)E
Room 3D 833
The Pentagon
Washington, DC 20301-8000
(202) 695-7820

Department of State

Office of Oceans and Polar Affairs
Room 5801
2201 C St., N.W.
Washington, DC 20520
(202) 647-3263

Nuclear Regulatory Commission

Washington, DC 20555
(301) 492-7000

ORGANIZATIONS TO WRITE FOR MORE INFORMATION

American Association of State Highway Transportation Officials (AASHTO)

444 North Capitol Street, N.W.
Washington, DC 20001
(202) 624-5800

For assistance in locating State personnel involved in monitoring hazardous materials road traffic.

Center for Emergency Response Planning (CERP)

Workplace Health Fund
815 16th Street, N.W.
Washington, DC 20006
(202) 842-7834

Educational resources for workers, labor officials, and community leaders on chemical hazards and planning issues.

Chemical Manufacturers Association

2501 M Street, S.W.
Washington, DC 20590
(202) 887-1255

Chemical emergency preparedness, chemical safety. Has lending library of audiovisual materials.

Hazardous Materials Transportation Bureau

Information Services Division
400 7th Street, S.W.
Washington, DC 20590
(202) 426-2301

Hazardous materials transportation.

Division of Respiratory Disease Studies

National Institute for Occupational Safety and Health
944 Chestnut Ridge Road
Morgantown, WV 26505

Indoor air pollution.

Environmental Policy Institute

218 D Street, S.E.
Washington, DC 20003
(202) 544-2600

Development of national policy for hazardous materials management.

Federal Emergency Management Agency

Public Information Office
Box 70274
Washington, DC 20024
(202) 646-4600

Emergency preparedness.

Library Programs Service

Office of the Assistant Public Printer
U.S. Government Printing Office
Washington, DC 20401
(202) 275-1114

Government documents on loan through Regional Depository Libraries.

National Technical Information Service

5285 Port Royal Road
Springfield, VA 22161
(703) 487-4650

Technical studies on a range of subjects such as ocean incineration, transportation of hazardous materials, and acid rain.

Working Group on Community Right-to-Know

218 D Street, S.E.
Washington, DC 20003
(202) 544-2600

Packets on Title III.

Occupational Safety and Health Administration

Directorate of Technical Support
Technical Data Center, Room N-2634
200 Constitution Avenue, N.W.
Washington, DC 20210
(202) 523-9700 or (202) 523-7894

OSHA standards, Material Safety Data Sheets, environmental science, literature searches on over 500 databases.

Public Information Center

U.S. Environmental Protection Agency
Mail Code PM-21 1 B
401 M Street, S.W.
Washington, DC 20460

Indoor air pollution, hazardous waste, waste cleanup.

Sierra Club
530 Bush Street
San Francisco, CA 94108
(415) 981-8634

Environmental protection issues.

U.S. Environmental Protection Agency (EPA)
Public Information Center
Mail Code PM-21 1 B
401 M Street, S.W.
Washington, DC 20460

Range of environmental issues.

U.S. Emergency Planning and Right-to-Know Information Agency
OS 120
401 M Street, S.W.
Washington, DC 20460

Title III documents. (Also see "Hazardous Materials Hotlines and Other Telephone Services" later in this section.)

RECOMMENDED READING

Unit 1: Hazardous Materials and Human Health

Center for Environmental Toxicology, TOXICOLOGY FOR THE CITIZEN. Available from the Center for Environmental Toxicology, C-231 Holden Hall, Michigan State University, East Lansing, Michigan 48824, (51 7) 353-6469. Single copies free; inquire about quantity prices.

Provides introduction to basic principles of toxicology.

NIOSH/OSHA, POCKET GUIDE TO CHEMICAL HAZARDS (017-033-00426-9). Available from Superintendent of Documents, U.S. Government Printing Office, Washington, DC 20402, (202) 783-3238. Cost: \$7.00.

Pocket reference covering health effects of chemicals.

Unit 2: Hazardous Materials Regulation

Tri-State League of Women Voters, THE WORLD OF WASTE. (1988). Available from Tri-State League of Women Voters, Rochambeau School, 229 Fisher Avenue, White Plains, NY 10606, (718) 423-2148. Cost: \$12.

Includes digest of Federal legislation. Also discusses emerging technologies in waste management.

U.S. Department of Labor, Occupational Safety and Health Administration. OSHA: EMPLOYEE WORKPLACE RIGHTS. (1987 Revised) OSHA 3021. Available from Occupational Safety and Health Administration Publications Office, Room N31 01, Washington, DC 20210, (202) 523-9667.

A review of employee workplace rights undercurrent legislation. Intended for the general public.

U.S. Department of Labor, Occupational Safety and Health Administration. HOW TO PREPARE FOR WORKPLACE EMERGENCIES. "(1 988 Revised) OSHA 3088. Available from Occupational Safety and Health Administration Publications Office, Room N31 01, Washington, DC 20210, (202) 523-9667.

Reviews what should be done to prevent chemical accidents at work and to make treatment available.

Unit 3: Identifying Hazardous Materials

Cohen, Gary, executive ed. THE CITIZENS TOXICS PROTECTION MANUAL. (1 988). Available from the National Campaign Against Toxic Hazards, 29 Temple Place, 5th Floor, Boston, MA 02111, (617) 482-1477. Cost: \$30.00 for nonprofits, \$50.00 for business, industry and government.

Intended to assist community leaders trying to attack toxics problems, this thick book contains specific strategies for action, including how to do research and obtain information.

Hance, Billie Jo, Chess, Caron, and Sandman, Peter M. IMPROVING DIALOGUE WITH COMMUNITIES: A RISK COMMUNICATION MANUAL FOR GOVERNMENT. (1988). Available from the Risk Communication Unit, New Jersey Department of Environmental Protection, Division of Science and Research, CN 409, Trenton, NJ 08625, (609) 984-6072.

Gives clear-cut guidelines for planning and understanding effective environmental health risk communication. Intended for use by State agencies.

Hazardous Materials: A Citizen's Orientation/Resources

Krames Communications, HAZARD COMMUNICATION PROGRAM (#1 136) and MSDS POSTER (##9056). Available from Krames Publications, 312 90th Street, Daly City, CA 94015-1898, (800) 228-8349. Cost: \$1.10 (#1 136), \$4.95 (#9056).

Shows how to use Material Safety Data Sheets and read warning labels.

Scanlon, Raymond D., ed. HAZARDOUS MATERIALS, HAZARDOUS WASTE: LOCAL MANAGEMENT OPTIONS. (1987). Available from the International City Management Association (ICMA), 1120 G Street, N.W., Washington, DC 20005, (202) 626-4600. Cost: \$21.00

*Reviews **Federal regulations and explores local options for hazardous waste management, including emergency prevention and response.***

U.S. Department of Labor, Occupational Safety and Health Administration. CHEMICAL HAZARD COMMUNICATION. (1988 Revised) OSHA 3084. Available from Occupational Safety and Health Administration Publications Office, Room N31 01, Washington, DC 20210, (202) 523-9667.

Reviews requirements of Hazard Communication Standard.

Unit 4: Preparing for Hazardous Materials Incidents

Auf der Heide, Erik. DISASTER RESPONSE: PRINCIPLES OF PREPARATION AND COORDINATION. (1989). C.V. Mosby Company.

Provides thorough overview of full range of issues associated with planning an effective response to any type of disaster (including hazardous materials).

Chemical Manufacturers Association, CMA Resources. COMMUNITY AWARENESS AND EMERGENCY RESPONSE. TITLE III. Available from Publications Fulfillment, Chemical Manufacturers Association, 2501 M Street, N. W., Washington, DC 20037.

This pamphlet contains ordering information for Title III-related materials offered by the Chemical Manufacturers Association.

Musselman, Victoria Cooper. EMERGENCY PLANNING AND COMMUNITY RIGHT-TO-KNOW: AN IMPLEMENTER'S GUIDE TO SARA TITLE III. (1988). Van Nostrand Reinhold, New York. Available from Public Information Center, U.S. Environmental Protection Agency, Mail Code PM-21 1 B, 401 M Street, S. W., Washington, DC 20460.

Broad explication of laws and regulations, preparedness issues, and training requirements.

National Response Team DIRECTORY OF FEDERAL INFORMATION RESOURCES FOR EMERGENCY PLANNING AND RESPONSE. (1988). Available from National Response Team of the National Oil and Contingency Plan, G-WER/l 2,2100 2nd Street, S. W., Washington, DC 20593.

A comprehensive review of computer databases, documents, hotlines, and other resources of assistance in planning for chemical emergencies.

National Response Team. HAZARDOUS MATERIALS EMERGENCY PLANNING GUIDE. (March 1987) NRT-1. Available from Hazardous Materials Emergency Planning Guide, WH-562A, U.S. Environmental Protection Agency, 401 M Street, S. W., Washington, DC 20460.

Presents a comprehensive approach to hazardous materials emergency planning.

U.S. Environmental Protection Agency. CHEMICALS IN YOUR COMMUNITY. A GUIDE TO THE

EMERGENCY PLANNING AND COMMUNITY RIGHT-TO-KNOW ACT. (September 1988) OS-1 20. Available from Emergency Planning and Community Right-to-Know Information Service, OS-1 20, U.S. Environmental Protection Agency, Washington, DC 20460.

An overview of Title III especially useful as an overall introduction for the general public.

U.S. Environmental Protection Agency, Office of Pesticides and Toxic Substances. THE EMERGENCY PLANNING AND COMMUNITY RIGHT-TO-KNOW ACT. SECTION 313 RELEASE REPORTING REQUIREMENTS. (February 1988) EPA 560/4-88-001. Available from Emergency Planning and Community Right-to-Know Information Service, OS-1 20, U.S. Environmental Protection Agency, Washington, DC 20460.

*A Title III review focusing on what must be **reported** and how.*

U.S. Environmental Protection Agency. TECHNICAL GUIDANCE FOR HAZARDS ANALYSIS: EMERGENCY PLANNING FOR EXTREMELY HAZARDOUS SUBSTANCES. Available from Emergency Planning and Community Right-to-Know Information Service, OS-1 20, U.S. Environmental Protection Agency, Washington, DC 20460.

Intended to enable local planners to conduct a hazard analysis, including computer applications and use of equations to establish zones of vulnerability.

U.S. Environmental Protection Agency. TITLE III FACT SHEET. EMERGENCY PLANNING AND COMMUNITY RIGHT-TO-KNOW. (August 1988 Revised). Available from Emergency Planning and Community Right-to-Know Information Service, OS-1 20, U.S. Environmental Protection Agency, Washington, DC 20460.

A brief review of key features of Title III.

Unit 5: Hazardous Materials in the Home

Enterprise for Education. HAZARDOUS WASTES FROM HOMES. Available from Enterprise for Education, 1320A Santa Monica Mall, Santa Monica, CA 90401. Cost: \$2.75, plus \$1.50 postage and handling.

An introduction to the household hazardous waste problem with advice on disposal of common types of products.

Environmental Hazards Management Institute. HOUSEHOLD HAZARDOUS WASTE WHEEL. Available from **EHMI**, P.O. Box 932, 10 Newmarket Road, Durham, NH 03824, (603) 868-1496. Cost: \$2.75 for 1-9; discount in quantity.

Shows chemical ingredients, alternatives, hazardous properties, and disposal options for common household products in a handy format.

Environmental Hazards Management Institute. WATER SENSE WHEEL. Available from **EHMI**, P.O. Box 932, 10 Newmarket Road, Durham, NH 03824, (603) 868-1496. Cost: \$2.75 for 1-9; discount in quantity.

Reviews sensory clues of the presence of contaminants in drinking water, Federal standards, health effects, and chemical-specific water treatment options.

Scanlon, Raymond D., ed. HAZARDOUS MATERIALS, HAZARDOUS WASTE: LOCAL MANAGEMENT OPTIONS. (1987). Available from the International City Management Association (ICMA), 1120 G Street, N.W., Washington DC 20005, (202) 626-4600. Cost: \$21.00.

Hazardous Materials: A Citizen's Orientation/Resources

Reviews Federal regulations and explores local options for hazardous waste management, including emergency prevention and response.

U.S. Environmental Protection Agency. HOUSEHOLD HAZARDOUS WASTE: BIBLIOGRAPHY OF USEFUL REFERENCES AND LIST OF STATE EXPERTS. (March 1988) EPA/530-SW-88-OI 4. Available from Public Information Center, U.S. Environmental Protection Agency, Mail Code PM-21 1 B, 401 M Street, S. W., Washington, DC 20460.

Includes listings of State as well as privately produced materials, experts, and collection program contractors.

U.S. Environmental Protection Agency, Office of Research and Development, Office of Air and Radiation. INDOOR AIR FACTS/No. 1-4. Available from Public Information Center, U.S. Environmental Protection Agency, Mail Code PM-21 1 B, 401 M Street, S. W., Washington, DC 20460.

Technical reviews of what is known about important indoor air pollutants.

U.S. Environmental Protection Agency/U.S. Consumer Product Safety Commission. THE INSIDE STORY. A GUIDE TO INDOOR AIR QUALITY. (September 1988) EPA/400/I-88/004. Available from Indoor Air Division, Office of Air and Radiation, U.S. Environmental Protection Agency, Washington, DC 20460.

Overview of causes and remedies for poor indoor air quality. Includes an overview of "sick building syndrome," its causes and cures.

Wailer, R.M. GROUNDWATER AND THE RURAL HOMEOWNER. (1988). Available from Book and Open-File Reports Section, U.S. Geological Survey, Federal Center, Box 25425, Denver, CO 80225.

Surveys common sources of groundwater pollution in rural areas.

COMPUTER NETWORKS OPEN TO THE PUBLIC

CAMEO Bulletin Board

Sponsor: National Oceanic and Atmospheric Administration (NOAA)

Description: Designed to enable users of CAMEO software to interact with NOAA personnel. CAMEO software is designed to be an aid in management of emergency operations, and includes such features as plume modeling. For information contact:

National Oceanic and Atmospheric Administration
Office of Oceanic and Marine Assessment
Hazardous Materials Response Branch
7600 Sand Point Way, N.E.
Seattle, WA 98115

EMI Bulletin Board

Sponsor: FEMA (EMI)

Description: The EMI Bulletin Board System is an interactive electronic bulletin board that provides current information on emergency management training courses, conferences, and workshops provided by the Emergency Management Institute.

Access: Data Lines (301) 447-6434 and (301) 447-3283. 24 hours, 7 days a week. Requires modem (300/1 200/2400) and communications software. Settings N-8-1 (preferred) or E-7-1.

Assistance: Federal Emergency Management Agency
Office of Training
Emergency Management Institute
16825 South Seton Avenue
Emmitsburg, MD 21727
(301) 447-1162
FTS: 652-1162

Hazardous Materials: A Citizen's Orientation/Resources

Hazardous Materials Information Exchange

Sponsors: FEMA and DOT

Description: Hazardous materials training events and conferences, literature, laws, news, query/response, information on databases and toll-free numbers.

Access: (31 2)972-3275 (commercial) or 972-3275 (FTS). Requires modem (300, 1200, or 2400 baud), and any communication software (set at no parity, 8 databits and 1 stop).

Assistance: 1 -800-PLANFOR (outside of Illinois)
1-800-367-9592 (in Illinois)

User's Guide Available From: Federal Emergency Mangement Agency
HMIX Coordinator
State and Local Programs and Support Directorate
Technological Hazards Division
500 C Street, S.W.
Washington, DC 20472
(Or call the toll-free number given above)

Toxic Chemical Release Inventory (TRI)

Sponsors: Made available through the National Library of Medicine's Toxicology Data Network using data collected by EPA.

Description: Contains information on annual estimated releases of toxic chemicals to the environment mandated by Title III. Designed to be user-friendly. Menu-driven search package allows novice users or those with limited computer skills to search TRI efficiently. TRI users can ask such questions as "how much benzene was reported released to waterways in 1987 by Virginia industrial plants?" TRI users have automatic access to all TOXNET files, including:

The Chemical Carcinogenesis Research Information System (CCRIS) scans primary journals for research on suspected carcinogens.

Toxicology Information Online (TOXLINE) provides bibliographic information on effects of drugs and other chemicals, including emergency handling of chemicals in the toxic chemical release inventory.

The Hazardous Substance Data Bank (HSDB) provides data on the toxicology of potentially hazardous chemicals in 11 broad subject areas, including safety and handling, chemical and physical properties, and environmental fate/exposure potential.

The Registry of Toxic Effects of Chemical Substances (RTECS) contains toxic effects data on some 90,000 chemicals.

The Environmental Mutagen Information Center Database (EMIC) includes bibliographic databases on suspected mutagens.

The Environmental Teratology Information Center Backfile (ETIC BACK) is a bibliographic database covering literature on teratology and developmental and reproductive toxicology.

Access: Direct dial or various telecommunications networks. Register first as a National Library of Medicine online user by contacting:

TRI Representative
Specialized Information Services
National Library of Medicine
8600 Rockville Pike
Bethesda, MD 20894
Telephone (301) 496-6531

HAZARDOUS MATERIALS HOTLINES AND OTHER TELEPHONE SERVICES

Emergency Planning and Community Right-to-Know Information Hotline, 1-800-535-0202, or 479-2449 in Washington, D.C. Open 8:30 a.m. to 7:30 p.m., Eastern Standard Time. Provides literature and information to LEPCs and the general public on Title III requirements.

Learning Resource Center, National Emergency Training Center, FEMA, 1-800-638-1821, operating hours Monday through Thursday, 8:30 a.m. to 5 p.m.; Friday, 8:30 a.m. to 5:00 p.m.; Saturday, 4 p.m. to 8 p.m.; Sunday, 12 noon to 4 p.m., Eastern Standard Time. Provides research support services, including photocopying of articles, and maintains a collection of case studies of disasters.

National Institute for Occupational Health and Safety (NIOSH), 1-800-35-NIOSH. Operated Monday through Friday, from 8:30 a.m. to 4:30 p.m. Eastern Standard Time. Maintains files on hundreds of hazardous chemicals that may be found in work environments and their current recommended exposure limits. Also provides information on occupational indoor air quality, and how to obtain a health hazard evaluation of your work place by NIOSH.

National Pesticides Telecommunications Network, 1-800-858-PEST, or (806) 743-3091 in Texas. Open 24 hours. Provides information about pesticides to the general public and the medical, veterinary, and professional communities.

RCRA/Superfund Hotline, 1-800-424-9346, or 382.3000 in Washington, D.C. Operates Monday through Friday, from 8:30 a.m. to 7:30 p.m. Eastern Standard Time. Provides information on regulations under both the Resource Conservation and Recovery Act (including solid and hazardous waste issues) and the Superfund law.

TSCA Assistance Information Service, (202) 554-1404. Operated Monday through Friday, from 8:30 a.m. to 5 p.m. Eastern Standard Time. Provides information on regulations under the Toxic Substances Control Act and on EPA's asbestos programs.

ANSWERS TO HAZ MAT TEASERS

Unit 1: Suggested Answers

1. **The risk from** this incident would have to be rated as high. Factors to be considered in your risk evaluation are: the presence of a school and a nursing home nearby, and the service station's location in a residential area. The material involved is highly flammable, and a significant quantity of it has spilled onto the ground. In addition, gasoline can produce toxic effects even in relatively small quantities.
2. The primary route of entry of immediate concern for people downwind of the spill would be inhalation. For the driver of the tanker, the routes of concern would be inhalation (from the vapors produced by the material on the ground and on his clothes) and direct skin absorption.
3. Yes, there is a potential for a long-term exposure threat. Since the gasoline is soaking into the ground along the side of the street, the potential exists for groundwater contamination. We know that there are wells in the area of the spill, so this groundwater contamination could result in a long-term exposure threat due to the ingestion of gasoline-contaminated water. In addition, if the contaminated ground is not removed or treated, the affected soil could present another possible long-term exposure threat.
4. All transport media are involved in this case. The air is involved due to the volatilization of the gasoline that spilled. Soil became involved as the gasoline flowed into the roadside ditch. The groundwater has become involved due to the gasoline soaking into the ground. Finally, surface water has become involved due to the gasoline reaching the small stream that flows through the area.
5. Yes, these two groups face an increased threat from the gasoline fumes. Hazardous chemicals usually have a greater effect on young children and the elderly, who may show signs and symptoms of toxic exposure at a lower level of exposure than other segments of the population.

Unit 2: Suggested Answers

1. Among those who would be appropriate to invite are the following: the Local Emergency Planning Committee, the Mayor's office, the State Department of Natural Resources, company representatives and union officials from the meat packing plant, PTA leaders, the city attorney, fire inspection officials, and the emergency program manager.
2. Prior to the meeting, you would want to request information on plant emissions from your State Emergency Response Commission and Local Emergency Planning Committee, and request other general information on plant conditions from the local fire department and the plant safety officer. In addition, you might want to research applicable standards for ammonia emissions. (The Title III "hotline" could be of some assistance.)
3. Laws that could be violated include the Clean Air Act, the Superfund Amendments and Reauthorization Act (SARA), the Resource Conservation and Recovery Act (RCRA), and State environmental statutes.
4. Some possible actions—but by no means **all** of the actions that could be taken—include the following:

Unit 2: Suggested Answers (continued)

The county air quality office is asked to take measurements of air pollutants in the area and determine if there are violations of the Clean Air Act. The Local Emergency Planning Committee is asked to provide copies of the information collected under the Superfund Amendments and Reauthorization Act, and will determine if the facility is in full compliance with SARA. State natural resource officials, along with representatives of the Coast Guard and EPA, are asked to investigate the fish kills in the river and determine if there are any violations of the Clean Water Act, RCRA and State environmental statutes. Union officials agree to ask OSHA to inspect the plant for compliance with health and safety standards. And the fire inspector agrees to check the plant for fire code violations.

All of these actions are, to a great extent, made possible by citizen interest and involvement.

Unit 3: Suggested Answers

1. During **production**, a hazard could exist at Chemex Industries (located on Route 107).
2. During **transportation**, a hazard might be found on any of the roadways, at the airport, along the Pacific Railroad, and along the Petrolux Pipeline. A special hazard may exist along the Petrolux Pipeline where it crosses the Allen Marshlands.
3. During **storage**, possible hazards could be found at the gas station, at Miller's Warehouse, and at Chemex Industries.
4. During **use**, hazards could exist at Chemex Industries, the high school and elementary school, the nursing home, and at the Central City Airport.
5. During **disposal**, the Hidden Mounds Landfill could contain a hazard as the result of improperly discarded materials.

Unit 4: Suggested Answers

1. Yes, good planning would have prevented many of the problems that occurred in the incident. A good emergency plan would have outlined who had the authority to order an evacuation, and who was to be in charge at the incident scene. Also, the plan should have identified the hazards associated with the hardware store's stocking of pesticides and fireworks.
2. Yes, good emergency planning must be coordinated with other communities and jurisdictions. Incidents can occur on political boundaries and involve more than one jurisdiction. Coordination between the two jurisdictions must be undertaken to provide protection to the residents in each community. Also, mutual aid (the sharing of services and equipment between communities) can be of great value in times of major emergencies.
3. Emergency planning should not be limited to governmental agencies. Other potential participants, such as private disaster relief organizations, schools, and churches, can be key players in a total community emergency plan. In the incident mentioned above, the Red Cross and Salvation Army, as well as the owner of the hardware store, should have been involved with the community planning process.

Unit 5: Suggested Answers

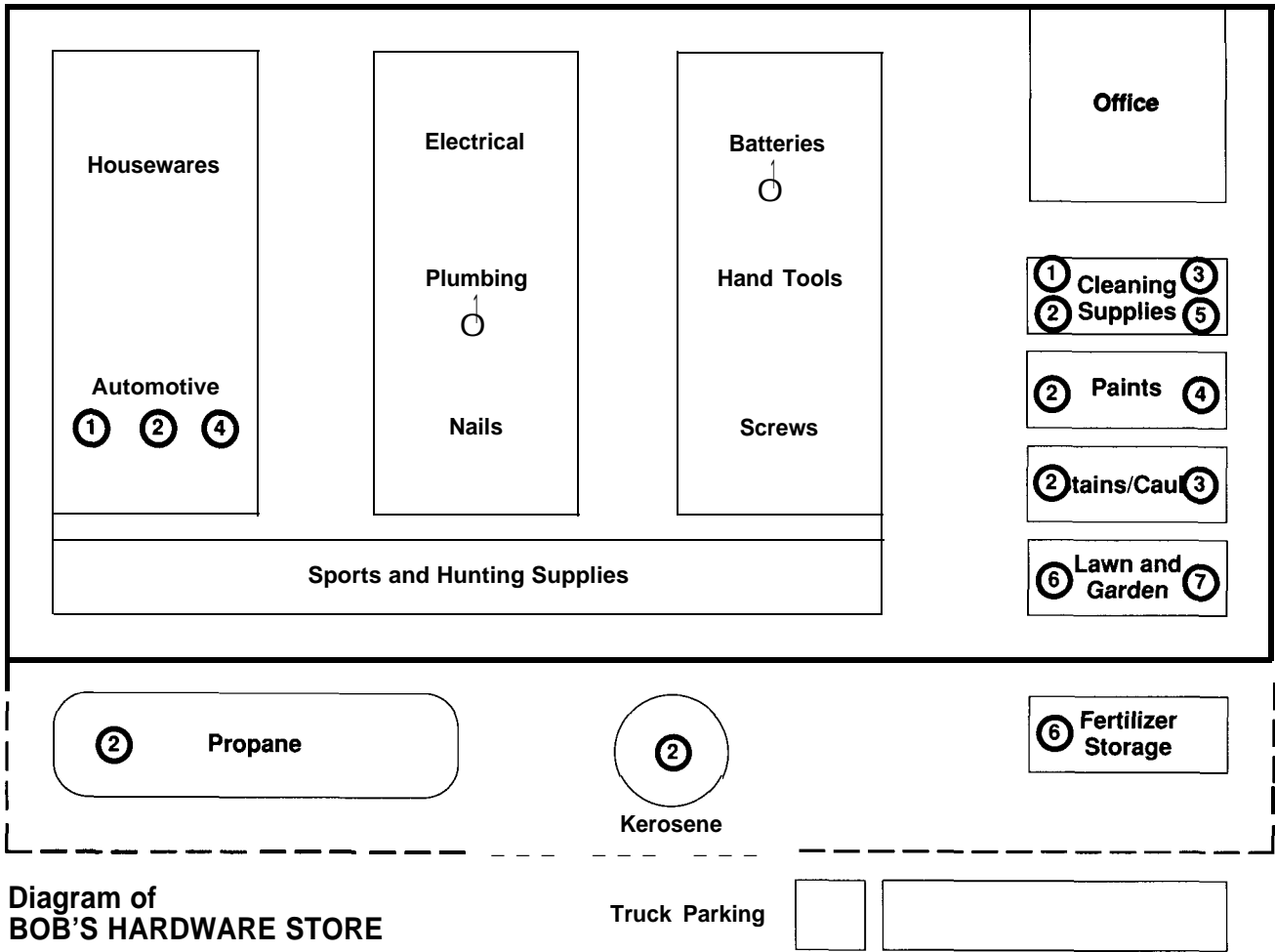

If a bottle of caustic drain cleaner fell from a shelf and splashed your leg, you should try to wash the caustic off of the skin with running water for at least 15 minutes. Additional first aid information could be obtained from your family doctor, the local Poison Control Center, or the hospital emergency department.

ANSWERS TO PRETEST AND CHECK YOUR MEMORY

PRETEST

- | | | | |
|-------|----------------------------------|-------|---------------------------------|
| 1. b | (See Unit 1, pages 1-14 to 1-16) | 16. b | (See Unit 4, page 4-6) |
| 2. d | (See Unit 1, pages 1-4 to 1-6) | 17. c | (See Unit 4, page 4-11) |
| 3. d | (See Unit 1, page 1-8) | 18. a | (See Unit 4, page 4-6) |
| 4. c | (See Unit 1, page 1-9) | 19. d | (See Unit 4, page 4-11) |
| 5. e | (See Unit 1, page 1-8) | 20. a | (See Unit 4, page 4-11) |
| 6. d | (See Unit 2, page 2-7) | 21. c | (See Unit 5, page 5-2) |
| 7. a | (See Unit 2, page 2-5) | 22. c | (See Unit 5, pages 5-4 and 5-6) |
| 8. c | (See Unit 2, pages 2-5 to 2-6) | 23. a | (See Unit 5, page 5-13) |
| 9. b | (See Unit 2, page 2-6) | 24. d | (See Unit 5, page 5-6) |
| 10. c | (See Unit 2, page 2-7) | 25. a | (See Unit 5, page 5-9) |
| 11. e | (See Unit 3, page 3-9) | | |
| 12. e | (See Unit 3, page 3-5) | | |
| 13. a | (See Unit 3, page 3-9) | | |
| 14. c | (See Unit 3, page 3-1) | | |
| 15. b | (See Unit 3, page 3-9) | | |

CHECK YOUR MEMORY

- | | | | |
|---------|--------------------------|---------|---------------------------|
| Unit 1: | | Unit 4: | |
| 1. a | (See pages 1-4 to 1-5) | 1. d | (See page 4-5) |
| 2. d | (See pages 1-15 to 1-16) | 2. a | (See page 4-1) |
| 3. a | (See page 1-18) | 3. a | (See page 4-6) |
| 4. b | (See page 1-9) | 4. d | (See page 4-1 2) |
| 5. a | (See page 1-9) | 5. a | (See pages 4-14 to 4-1 5) |
| 6. c | (See page 1-1 O) | 6. a | (See pages 4-2 to 4-3) |
| 7. b | (See page 1-1 5) | 7. b | (See pages 4-16 to 4-1 7) |
| Unit 2: | | Unit 5: | |
| 1. a | (See page 2-1) | 1. d | (See page 5-3) |
| 2. c | (See page 2-3) | 2. a | (See page 5-4) |
| 3. c | (See page 2-8) | 3. c | (See pages 5-4 and 5-6) |
| 4. c | (See pages 2-9 to 2-1 O) | 4. a | (See page 5-6) |
| 5. d | (See page 2-1 2) | 5. c | (See page 5-9) |
| 6. a | (See page 2-13) | 6. c | (See page 5-1 3) |
| 7. c | (See pages 2-5 to 2-6) | 7. d | (See pages 5-13 to 5-1 4) |
| Unit 3: | | | |
| 1. c | (See page 3-2) | | |
| 2. d | (See pages 3-3 to 3-7) | | |
| 3. b | (See page 3-7) | | |
| 4. b | (See pages 3-7 to 3-8) | | |
| 5. c | (See page 3-8) | | |
| 6. c | (See page 3-8) | | |
| 7. d | (See page 3-1 1) | | |

FINAL EXAMINATION

Using a soft lead (#2) pencil, record the best answer for each of the following questions on the attached computer answer sheet. There is only one correct answer for each question. When you have finished, prepare the answer sheet as directed and mail to the address provided. Your examination will be evaluated and the results returned to you as quickly as possible.

- Which of the following correctly identifies the four "routes of entry" for toxic substances into the body:
 - Irritation, injection, absorption, asphyxiation
 - Absorption, injection, ingestion, inhalation
 - Absorption, injection, insertion, inhalation
 - Injection, ingestion, integration, absorption
- A person works every day with a toxic substance, but does not take protective measures. The individual will experience what type of exposure?
 - Acute
 - Chronic
 - Lethal
 - Carcinogenic
- The body has very efficient internal defenses which can remove any quantity of an unwanted substance.
 - True
 - False
- The tendency of chemicals to become more concentrated as they move up the food chain is known as:
 - Leachification
 - Biodegradation
 - Chemical breakdown
 - Biomagnification
- An industry's smokestack is an example of what type of source?
 - Point
 - Area
- You have just learned that a chemical you work with is a **mutagen**. What effect does this chemical have?
 - Increases the risk of cancer
 - Increases the risk of physical defects in a developing embryo
 - Causes a permanent change in the genetic material (DNA)
 - Irritates the lining of the throat
- A toxic accident occurs in your neighborhood. Several adults, teenagers, and small children are present. Which group, if any, would be likely to be most severely affected?
 - All would be affected to the same degree
 - The small children would be most severely affected
 - The teenagers would be most severely affected
 - The adults would be most severely affected

Hazardous Materials: A Citizen's Orientation/Final Examination

8. The analysis of a situation to determine the level of risk inherent in that situation is called:
 - a. Risk assessment
 - b. Risk management
 - c. Risk search
 - d. Health effects assessment

9. A chemical that, in relatively small amounts, produces injury when it comes in contact with susceptible tissue is known as:
 - a. A radioactive material
 - b. An explosive
 - c. A flammable liquid
 - d. A poison

10. It is difficult and sometimes impossible to purify contaminated groundwater.
 - a. True
 - b. False

11. The Federal agency responsible for regulating interstate shipments of hazardous materials is:
 - a. FEMA
 - b. DOT
 - c. EPA
 - d. OSHA

12. The Federal law designed to regulate hazardous waste "from cradle to grave" is:
 - a. Resource Conservation and Recovery Act of 1976
 - b. Toxic Substances Control Act
 - c. Safe Drinking Water Act
 - d. Superfund

13. Under existing laws, States have broad authority to control how hazardous materials are stored, used, transported, and disposed of within their borders.
 - a. True
 - b. False

14. Under Title III, Local Emergency Planning Committees (LEPCs) are charged with the responsibility to:
 - a. Develop an emergency plan to respond to hazardous materials incidents
 - b. Regulate hazardous materials within State borders
 - c. Inspect local factories to ensure compliance with Federal legislation
 - d. Write local ordinances to promote emergency preparedness

15. Under what circumstances are judges are likely to take immediate action to halt pollution before a violation of the law has been proven in court?
 - a. Whenever there is cause to believe the environment might be harmed
 - b. Whenever environmental lobby groups are in agreement that the problem exists
 - c. When the polluting industry is large and can afford it
 - d. In extreme cases when the potential damage is clear and irreparable

16. The local role in reducing public risks from hazardous materials includes:
- a. Developing an emergency plan for hazardous materials incidents
 - b. Regulating hazardous materials transportation through local ordinances
 - c. Regulating safe disposal of hazardous waste
 - d. All of these
17. The Federal agency primarily responsible for protecting our environment from contamination by hazardous materials releases is:
- a. The Department of Transportation
 - b. The Federal Emergency Management Agency
 - c. The Department of Labor
 - d. The Environmental Protection Agency
18. Which Federal agency provides training, resource information, and technical and financial assistance to States to help them prepare for hazardous materials emergencies?
- a. The Department of Transportation
 - b. The Federal Emergency Management Agency
 - c. The Department of Labor
 - d. The Environmental Protection Agency
19. Title III of the Superfund Amendments and Reauthorization Act of 1986 (SARA) grants citizens the right to obtain information on hazardous materials in their community.
- a. True
 - b. False
20. Which Federal law is intended to assure, so far as possible, safe working conditions?
- a. The Occupational Safety and Health Act
 - b. The Clean Air Act
 - c. The Toxic Substances Control Act
 - d. The Safe Drinking Water Act
21. The presence of hazardous materials can always be detected by the sense of smell.
- a. True
 - b. False
22. A Material Safety Data Sheet (MSDS) includes information on:
- a. Health effects and physical properties of a specific chemical
 - b. Laws governing the use of a specific chemical
 - c. The amount of a specific chemical that can be legally released
 - d. The cost of a specific chemical
23. In the NFPA 704M labelling system, a rating of 4 in any quadrant corresponds to:
- a. The lowest degree of hazard
 - b. A moderately low hazard
 - c. A moderately high hazard
 - d. The highest degree of hazard

Hazardous Materials: A Citizen's Orientation/Final Examination

24. Sensory clues to the possible presence of hazardous materials in water include:
- a. Dead fish
 - b. Unusual algae growth
 - c. White froth
 - d. All of these
25. By reading the placard on a tanker bearing hazardous materials, you can find out:
- a. The hazard class of the substance being carried
 - b. The amount of the substance being carried
 - c. The date the substance was shipped
 - d. The name of the carrier
26. The five phases of a hazardous material's life include production, transportation, storage, elimination, and disposal.
- a. True
 - b. False
27. Besides the LEPC, what local agencies may maintain specific information on industries in your community that use, store, or generate EHS-listed hazardous materials?
- a. The local police
 - b. The local fire department
 - c. Both a and b
 - d. Neither a nor b
28. If you encounter a suspicious substance, you should:
- a. Immediately dispose of it yourself
 - b. Notify the appropriate authority to remove it
29. The code OXY in the bottom white quadrant of a label conforming to NFPA 704M indicates that:
- a. The material can easily release oxygen to create or worsen a fire or explosion hazard
 - b. The material reacts with water
 - c. The material will explode on contact with air
 - d. The material is radioactive
30. The three basic approaches to cleaning contaminated soil include:
- a. Containment, off-site disposal, and treatment
 - b. Air stripping/aeration, activated carbon, and chemical precipitation
31. One benefit of a sound community plan to deal with a hazardous materials emergency is:
- a. Fewer resources are required to handle the incident
 - b. Role confusion among incident responders is minimized
 - c. The need for assistance from other jurisdictions is eliminated
 - d. The likelihood of an incident occurring is almost eliminated
32. A primary purpose of conducting a hazardous materials exercise is to find out:
- a. Which responders should receive raises
 - b. Whether planned procedures work
 - c. What type of incident is most likely to occur
 - d. What Federal and State resources could be made available for such an incident

33. If you are caught outdoors in the vicinity of a hazardous materials incident, you should try to stay:
- a. Upstream, uphill, and upwind
 - b. Downstream, downhill, and downwind
 - c. Close to the incident responders
34. In-place sheltering is never an appropriate option in an accident involving toxic chemicals.
- a. True
 - b. False
35. Decontamination is needed in order to:
- a. Remove contaminants from people and equipment
 - b. Treat injuries resulting from chemical emergencies
 - c. Identify chemicals involved in an accident
 - d. Estimate the amount of contaminant to which a person has been exposed
36. Once approved, an Emergency Operation Plan should never be revised, since this would create potential confusion in responding agencies.
- a. True
 - b. False
37. Formal mutual aid agreements with surrounding jurisdictions are seldom if ever needed, since everyone is ready to pitch in when an incident occurs.
- a. True
 - b. False
38. The key components of a complete local plan include a basic plan, supporting annexes, and implementing procedures. The supporting annexes typically include:
- a. Conceptual framework for emergency operations
 - b. Lists of people to alert under certain conditions
 - c. Information on how specific functions (such as evacuation) will be carried out for particular hazards
 - d. "How to" instructions for operating departments or individuals
39. What is the primary purpose of a Hazardous Materials Response Team?
- a. To develop a community plan for responding to hazardous materials incidents
 - b. To inspect buildings where hazardous chemicals are used or manufactured
 - c. To provide the skills, knowledge, and technical equipment needed to handle hazardous materials incidents
 - d. To assist in the disposal of household hazardous waste
40. A person whose skin is coated with a toxic substance hands his/her contaminated clothing to another individual. This likely will result in what is called:
- a. Cross-contamination
 - b. Ingestion
 - c. Risk
 - d. Reckless endangerment

41. The health effects that can result from asbestos exposure include:
- a. Lung disease and certain cancers
 - b. Heart disease
 - c. Mental illness
 - d. Paralysis
42. The primary hazard associated with most organic solvents is:
- a. Radioactivity
 - b. Explosiveness
 - c. Faulty containers
 - d. Toxic vapors
43. When treating a household incident involving exposure to a poison, your most reliable source of advice and expertise is:
- a. The local health department
 - b. The police
 - c. The Poison Control Center
 - d. The product's label
44. Standard approaches to waste disposal are generally inadequate and frequently inappropriate for household hazardous waste.
- a. True
 - b. False
45. Household chemical products should generally be stored in a _____.
- a. Warm place
 - b. Humid place
 - c. Cool, dry place
46. Which of the following warning labels indicates the **least** degree of hazard?
- a. Danger
 - b. Warning
 - c. Caution
47. Which of the following is most likely to occur when an acid such as toilet bowl cleaner is combined with a base such as a drain opener?
- a. The substances neutralize each other, and no harm results
 - b. The substances react, often violently
 - c. Radioactivity is released
 - d. The products solidify, and can be disposed of readily
48. If your water service pipe is grey, will not attract a magnet, cannot be easily gouged with a key, and has no sharp bend or elbow, it could be made of a metal that has undesirable health effects if ingested. That metal is:
- a. Lead
 - b. Copper
 - c. Iron
 - d. Aluminum

49. A good substitute for drain cleanser is:

- a. Two handfuls of salt followed by boiling water
- b. A mixture of salt and flour
- c. Vinegar, alcohol, and linseed oil
- d. Confectioners sugar and borax

50. Existing landfills are generally considered sufficient to serve as the sole means of disposing of the Nation's waste for the foreseeable future.

- a. True
- b. False

-(fold here)-

Please
Place
Stamp
Here

FEMA HOME STUDY PROGRAM
Administrative Office—EMI
16825 South Seton Avenue
Emmitsburg, MD 21727

-(fold here)-

PRIVACY ACT STATEMENT (Public Law 93 579)

1. **AUTHORITY:** The authority for collection of the information is 5 U.S.C. 301; 44 U.S.C. 3101; 50 U.S.C. 2253,2281 and E.O. 9397.
2. **PRINCIPAL PURPOSE(S):** This information is collected for the purpose of providing self-directed study courses to citizens who cannot attend regular classroom courses and certify applicants who successfully complete the courses.
3. **ROUTINE USES:** Information maybe provided to the FEMA Self-Directed Study Program Contractor to enter applicant into the self-directed study program and to release self-directed study materials to applicants and to forward certificates to applicants who successfully complete a course; to FEMA Computer Center in Olney, Maryland, to establish a printout including name, address, student number, numerical grade for each course unit, date of completion of each course unit, final grade and date of course completion for submission to the contractor and to FEMA Training and Education; to FEMA Training and Education to respond to student inquiries relating to completion dates, requests for military reserve credits and requests for certificates of completion that were awarded but did not arrive for the student; to FEMA Regional Offices to measure training progress in the region; to State Emergency Management Offices to schedule more advanced training for students who have completed basic emergency management instruction through self-directed study courses. In some cases, information contained in the self-directed study course program is used to update individual student records maintained by the FEMA Self-Directed Study Program.
4. **MANDATORY OR VOLUNTARY DISCLOSURE AND EFFECT ON INDIVIDUAL NOT PROVIDING INFORMATION:** The disclosure of this information is voluntary, however, omission of the name and address would result in our inability to forward you copies of the self-directed study course and certificates of completion of courses. **Information Regarding Disclosure of Your Social Security Number Under Public Law 93-579 Section 7(b)** - The collection of your social security number is authorized by E.O. 9397 of November 22, 1943. The disclosure of your social security number is voluntary. You may take the self-directed study courses even if you do not provide the social security number; however, failure to provide such information may result in limited service which we will be able to provide to you regarding successful completion of courses and certifications.