

Wholesale Glass Distributors, Inc.

Shop Manual

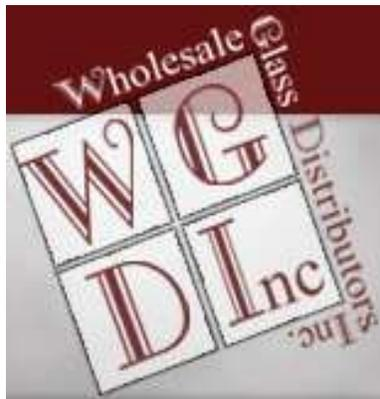

www.wholesaleglassdist.com

See What's New!

- Standard 48" Tempered Circles With Edgework
- New Taller Double Track Option for Showcase Systems
- SDL Divided-Lite Style Muntins Available for IGs
- Several New Pattern Glass Options
- Argon Gas Available to Improve Energy Efficiency of IGs

To Order Call: 1-800-277-5223

Table of Contents

■	The WGD Advantage	1	■
■	Placing an Order	2	■
■	Auto Glass & Related Products	3	■
■	Flat Glass	4	■
■	Mirrors	5	■
■	Acrylics & Lexan	6	■
■	Standard Tempered: Circles, IGs, & Doorlites	7	■
■	Showcase Materials	8	■
■	Shelving	9	■
■	Bath Enclosures, KDs, & Parts	10	■
■	YKK & Other Metal Products	11	■
■	Custom Items & Fabrication Services	12	■

To Order Call: 1-800-277-5223

1

**The WGD
Advantage**

To Order Call: 1-800-277-5223

The WGD Advantage

Welcome To Wholesale Glass Distributors!

Since our inception in 1992, Wholesale Glass Distributors has prided itself on delivering the highest quality and best value to our customers. This philosophy has helped us grow into an industry leader, distributing a wide range of automotive and commercial glass and related products to glass retailers in South Carolina, Southwestern North Carolina, and Northeastern Georgia.

Sincerely,
Timothy C. Conklin
Founder

Wholesale Glass Distributors Inc. sells exclusively to Qualified Glass Retailers. We proudly offer a wide variety of commercial and residential glass products including:

- Auto Glass & Related Products
- Replacement Window Glass
- Insulated Window Units
- Custom Tempered Glass
- Shower Doors
- Storefront Materials
- Wire Shelving Products
- And Much More!

The WGD Advantage

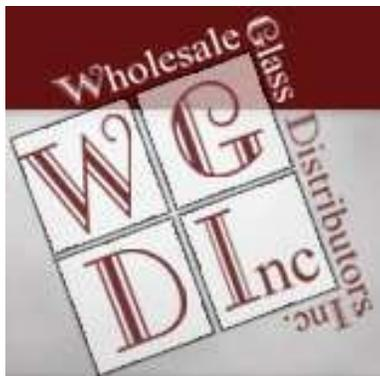

Founded in 1992 by Timothy C. Conklin, Wholesale Glass Distributors provides automotive and commercial glass and related products to glass retailers in South Carolina, Southern North Carolina, and Northeastern Georgia.

Wholesale Glass Distributors is unique in the wholesale glass market because we cater to several different business sectors. We provide laminated windshield and tempered automotive replacement glass, mirrors, and related sundries to the automotive market. Plus, we offer an extensive selection of products for commercial flat glass applications including: window glass, plate glass, laminated glass, wire glass, mirrors, insulated glass, acrylics and polycarbonates, store-front metal products, showcase materials, and shower doors. We also offer closet wire shelving and related parts.

In recent years we have greatly expanded our range of services with the addition of a new tempering and glass fabrication plant. Among our many new services, WGD now offers high quality heavy glass fabrication as well as edgework including beveling, polishing, and mitering.

Our initial policy of high quality products and attention to service helped our organization to grow and service an expanding market. Today, Wholesale Glass Distributors is a one-stop shop for all of your glass needs. As always, we provide high-quality glass products with relentless customer service.

To Order Call: 1-800-277-5223

2

Placing an Order

Placing an Order: Customer Service Centers

Since our inception, our employees worked to form relationships with customers that last far beyond a single sale. We believe that if the customer succeeds, then we also succeed. We constantly strive to facilitate growth for our customers throughout the lives of their businesses.

Wholesale Glass Distributors maintains a complete commitment to customer service, so we build our operations around the desire to get you the products you need when you need them. We run our own fleet of delivery vans, operating out of each of our three warehouse distribution facilities around the clock, so most orders are delivered in well under 24 hours. Even our tempered glass and insulated glass units, which are custom fabricated upon order receipt, are usually delivered inside of two days. We inventory our products in our warehouse locations strategically for the market segments we supply, and we always maintain flexibility, transferring materials quickly between warehouse locations when our customers request it.

Wholesale Glass Distributors offers excellent customer service from the time of order entry through delivery. We pride ourselves on our employees, who we carefully hire from among the most motivated and caring individuals who want to be part of our service team.

Placing an Order: Customer Service Centers

You can contact our knowledgeable customer service representatives any time between 8am and 5:30pm, Monday through Friday, at any of our three Customer Service Centers:

Greenville, SC

6 Haverhill Drive
Mauldin, SC 29662
Local Phone: 864-233-5080
Toll-Free Phone: 800-277-5223
Fax: 864-233-3484

Charleston, SC

2214 Technical Parkway
North Charleston, SC 29406
Local Phone: 843-824-5960
Toll-Free Phone: 800-864-0991
Fax: 843-824-5964

Columbia, SC

1035 Dreyfus Road
Columbia, SC 29201
Local Phone: 803-799-5525
Toll-Free Phone: 866-233-0733
Fax: 803-799-5514

If you need to place an order outside of our office hours, you can send in a fax or leave a message on our answering system. Employees check these messages before the night trucks leave and will do their best to meet your needs.

You can also access Wholesale Glass Distributors anytime day or night through our online ordering system at www.wholesaleglassdist.com.

To Order Call: 1-800-277-5223

Placing an Order: Ordering Online

In our ongoing effort to provide our customers with the highest quality service Wholesale Glass Distributors has created a website at www.wholesaleglassdist.com.

Website Log-On

If you have not already obtained a username and password, you may do so by contacting our IT department at (864)233-5080 ext. 221. Once you have obtained these two pieces of information, you can enter them in the customer login box on our home page (circled in red below) and then click on the gray "Login" box to access online ordering and additional product information.

The screenshot shows the homepage of Wholesale Glass Distributors Inc. At the top, there is a navigation menu with links: home | about us | why WGD | testimonials | products | contact us | customer login. Below the menu is a banner with the company logo (WGD Inc. Distributors) and the tagline "The One Stop Shop for all of Your GLASS NEEDS". The banner also includes a quote: "providing automotive and commercial glass and related products to glass retailers in SC, Southwestern NC and Northeastern GA." Below the banner, there is a "Welcome To Wholesale Glass Distributors" section with a message from Timothy C. Conklin, Founder. To the right of the welcome message is a "CUSTOMER LOGIN" box, which is circled in red. The login box contains the text "Enter username & password below:", two input fields for "Username" and "Password", a "LOGIN" button, and a "Forgot Password? Click Here" link. At the bottom of the page, there is a footer with the text "wholesaleglassdist.com © 2004 • Privacy Policy • Terms of Use".

Placing an Order: Ordering Online

Placing Your Order

Once you are logged in, you can click on the “Home” link (circled in red below) at the top of the page to place an order.

The screenshot shows the website's header with navigation links: [home](#) | [about us](#) | [why WGD](#) | [testimonials](#) | [products](#) | [contact us](#) | [customer login](#). The 'home' link is circled in red. Below the header is a banner for 'The One Stop Shop for all of Your GLASS NEEDS' with a description of services and a photo of workers. The main content area includes a welcome message from Timothy C. Conklin, a list of products (Auto Glass, Replacement Window Glass, Insulated Window Units, Shower Doors, and Many Other Residential and Commercial Related Glass Products), and a 'CUSTOMER LOGIN' section. The 'CUSTOMER LOGIN' section includes a shopping cart icon, a greeting for a 'TEST Account', a 'YOUR ACCOUNT' button, a link to 'View WGD Shop Manual', and a search box with a 'GO!' button (boxed in blue). Below the search box is a 'Make / Model / Year Search' dropdown menu (boxed in green).

If you know the part number you would like to order, type it into the search box (boxed in blue above) and click “Go.”

Tip: You can find most part numbers in this Shop Manual, which is also available on the website—just click the “View WGD Shop Manual” link. For auto glass, just type in the numeric portion of the NAGS number. You can also use the Make/Model/Year drop-down search menu (boxed in green above).

Placing an Order: Ordering Online

After you type in a part number and click “Go,” you will be brought to a Search Results page. Select the part that you wish to order and type in the quantity you would like to buy in the box to the left of that item (you do not need to place a zero in the boxes of items you do not wish to order).

Tip: “Next Run” availability means the part is in stock at your local branch. “Next Day” availability means it can be transferred in overnight from another branch.

Search Results for: 1256 << Back						
All items are shipping from: Greenville, South Carolina 000 864-233-5080						
Qty	Part #	Description	Availability	List Price	Price	Actions
	DD11256 GTN	07 Cad.Escalade R/Left	Please Call	N/A	Please Call	Fits Related
	DD11256 YPN	07 Cad.Escalade R/Left	Please Call	N/A	Please Call	Fits Related
<input type="checkbox"/>	DW01256 GBN-AM	Windshield (Solar) FORD 96.5+ *WFTD1256*	Next Run	N/A	\$44.86	Fits Related
<input type="checkbox"/>	DW01256 GBN-CCS	Windshield (Solar) FORD 96.5+ *WFTD1256* {25}	Next Day	N/A	\$41.06	Fits Related
<input type="checkbox"/>	DW01256 GBNCAR	Windshield (Solar) FORD 96.5+ *WFTD1256* {25}	Next Run	N/A	\$41.06	Fits Related
	DW01256 GTN-CCS	Windshield (Solar) 97-Expdtn/F150/Navig w/Bnd Slr	Please Call	N/A	Please Call	Fits Related
	DW01256 GTNCAR	Windshield (Solar) FORD *WFTD1256*	Please Call	N/A	Please Call	Fits Related
	FD21256 YPN	SUZUKI	Please Call	N/A	Please Call	Fits Related
<input type="checkbox"/>	WFT D1256	FORD F-SER/EXP 97-	Next Run	N/A	\$10.96	Fits Related
	YE9-1256-YB	BRONZE HORZ SNAP ON COVER	Please Call	N/A	Please Call	Fits Related

[▲ top of page](#)

If there is no box to the right of the part you want to order, please call WGD. We can often obtain the part from one of our suppliers and still get it to you on your next run.

Once you have entered the quantity you wish to order of each item on the page, click the “Purchase” button at the bottom of the page. This adds the part(s) to your shopping cart.

Tip: For multiple quantity orders of the same item, please call to check inventory.

Placing an Order: Ordering Online

Shopping Cart

Cart > Account > Shipping > Payment > Confirm
Help with My Shopping Cart EMPTY CART

Qty	Description	Unit Price	Price	Remove
<input type="text" value="1"/>	DW01256 GBN-AM Warehouse Location: 005	\$44.86	\$44.86	

Subtotal: \$44.86

Ready to Checkout?

Option #2: I am a returning customer?
TEST, if you know your password, enter it below and click **GO!**

Username
Password

Forgot My Password? [Click Here](#)

Help with My Shopping Cart

How do I remove items from my cart?
Click the icon next to the item you wish to remove.

How do I change the quantity of an item in my shopping cart?
Change the number in the box next to that item and click

How safe is my order?
We use the latest encryption technology. Each purchase you make is protected and safe.

[BACK TO TOP](#) ↑

wholesaleglassdist.com © 2004 • [Privacy Policy](#) • [Terms of Use](#)

After you click “Purchase,” you will be redirected to your shopping cart. From there you can either choose to continue shopping by clicking the orange “Continue Shopping” button, edit your order by changing the quantity and then clicking “Update Qty,” remove an item from your shopping cart by clicking the trashcan to the right of it, or check out.

If you are ready to check out, you will need to re-enter your password in the box circled in red above (a security measure to protect you against unauthorized purchases on your account), and then click “Go!”

Placing an Order: Ordering Online

Checkout

To complete your order, simply follow the on-screen instructions. On the next page, confirm your account information. This should be the address where we send you mail.

Note: Although an email address is not required to proceed, we ask that you provide one so that we can better serve you with informational emails (including order confirmations). We will not give out your information or bombard you with useless emails. Once you have confirmed that this information is accurately filled out, click “Proceed.”

The next page will ask you to confirm your shipping address. You should only have to fill this information out the first time you purchase a product online. Once you are certain that this information is correct, click “Update.”

The final step you will have to take is to select your payment option. Once the correct option has been selected, click the “Proceed” button.

Note: Clicking “Proceed” after selecting your payment option will place your order with WGD and cannot be undone online. If you need to cancel or change an order after this point, you will need to call a customer service representative at one of our branches.

After your order has been placed, you will be sent to your Order Confirmation page.

Placing an Order: Ordering Online

Confirmation Page

Cart > Account > Shipping > Payment > **Confirm**
 ? Help with Your Order Confirmation

TEST, thank you for your order!
 An email confirmation has been sent to your email address.

Order Confirmation Number: 17492
Order Date: 12/07/2009 3:25:31 PM

Billing and Shipping Information

Billing Contact Information
 Account, TEST
 A-1 Auto
 123 Main St
 Anytown, SC 29615
 United States
 123-456-7890
 user@email.net

Shipping Address
 Smith, John
 Smith
 111 Anywhere Ave.
 Somewhere, SC 29615
 United States
 123-456-7890

Product Order Information

Qty	Description	Unit Price	Price
1	DW01256 GBN-AM	\$44.86	\$44.86
Sub Total			\$44.86
State Tax Total			\$0.00
Grand Total			\$44.86

PO Number: Emily

Help with Your Order Confirmation

What if I need to change my order?
 Please contact us via phone or email immediately.

What do I need to do now?
 Just print this page for your records, and we'll take care of the rest. Thanks again for your business.

[BACK TO TOP](#)

Your order confirmation page will show your order as WGD received it. It will include your Billing and Shipping information, as well as a list of the items you have ordered, along with their prices. You should print this page for your records (see red circled button above).

Tip: Your order confirmation number (see blue circled number above) will print as a comment line on your ticket.

A copy of this confirmation page will be emailed to you if you provided a current email address.

To Order Call: 1-800-277-5223

3

**Auto Glass
& Related
Products**

To Order Call: 1-800-277-5223

Auto Glass & Related Products

In order to conserve space, this manual does not include a list of all the auto glass parts that we carry at WGD. However, you can easily look up any auto glass part through our website at www.wholesaleglassdist.com. Once you have logged in, there is a box in the lower left-hand corner where you can type part numbers (you can simply type in the numerical portion of the NAGS part number if you know it) or perform a make and model search.

Performing a Make & Model Search Online

To perform a make and model search at www.wholesaleglassdist.com, simply click on the drop box (circled in red below) and select the correct vehicle make. Additional drop-boxes will then appear where you can select the model and year. Once you have entered this information, a box listing all available glass for that vehicle will appear on the screen. Please refer to section 2.2 of this manual for additional information about using our website.

The screenshot shows the homepage of Wholesale Glass Distributors. At the top, there is a navigation bar with links: home | about us | why WGD | testimonials | products | contact us | customer login. Below this is a banner with the WGD logo and the text "The One Stop Shop for all of Your GLASS NEEDS".

The main content area is divided into two columns. The left column contains a "Welcome To Wholesale Glass Distributors" message from Timothy C. Conklin, Founder, and a list of products including Auto Glass, Replacement Window Glass, Insulated Window Units, Shower Doors, and other residential and commercial glass products.

The right column is titled "CUSTOMER LOGIN" and includes a shopping cart icon, a greeting for a "TEST Account", a "YOUR ACCOUNT" button, and a link to "View WGD Shop Manual". Below this is a search form with the label "Make / Model / Year Search" and a dropdown menu currently showing "[Select a Make]". This dropdown menu is circled in red in the image.

At the bottom of the page, there is a footer with the text: wholesaleglassdist.com © 2004 • Privacy Policy • Terms of Use

Auto Glass & Related Products

Understanding Auto Glass Part Numbers

WGD's auto part numbers are set up in the following order: a 2 letter prefix, a several digit number, a 3 letter suffix, and additional information (if any).

The first letter tells whether the glass is for a foreign (F) or domestic (D) vehicle. The second letter identifies what type of part it is:

- W is for windshield
- D is for door glass
- B is for back glass
- Q is for quarter glass
- V is for vent glass
- Occasionally you'll see T for tempered parts and L for laminated parts

The numbers are the NAGS part number for the glass.

Tip: when searching for a part online, you can type in just this portion of the part number.

The first letter of the suffix tells the color of the glass overall:

- G is for green
- B for blue
- Z for bronze
- Y for gray
- C for clear

The second letter of the suffix gives more about the color:

- T means that the glass is just the same color all over (the color identified in the first letter of the suffix)
- P means it is privacy tinted
- If there is any other letter (G, B, Z, Y, etc.), that letter represents the presence (and color) of a shade band across the top of the glass

The third letter in the suffix will be either a Y or an N, which stand for "yes" or "no" in answer to the question "Are there any attachments included on this piece of glass?" Y can mean it has a molding or a clip of some kind, or a rain sensor, etc.

Any additional letters give information about the brand of glass (MOP for Mopar, CAR or CCS for Carlite, etc). This information is not always included in the part number.

To Order Call: 1-800-277-5223

Auto Glass & Related Products

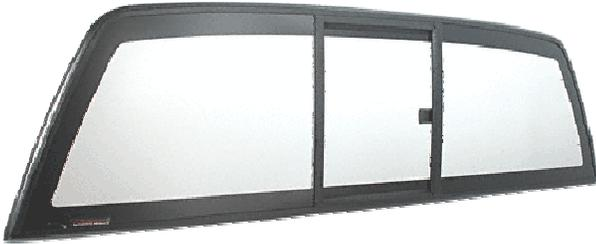

Rear Sliders for Trucks

WGD carries a large selection of aftermarket rear sliders for trucks. These part numbers begin with the letters “DY” or “FY.”

Other Auto Products

WGD carries a wide variety of parts related to auto glass as well. You can look online or call a customer service representative to order moldings, gaskets, clips, side-view and rear-view mirrors, mirror kits, rain sensor kits, urethanes, installation tools, and much more.

Wiper Blades

WGD is now proud to offer windshield wiper blades for nearly every vehicle make and model! We carry wiper blades ranging from 11” to 28” individually or in sets of two. Contact a customer service representative to find out which wiper blade is right for a specific application or to request more information or a complete parts list. You can also look up pricing and availability online at www.wholesaleglassdist.com by typing in “WB-” in the search box and clicking “Go!”

Tip: be sure to include the dash or you will pull up several hundred moldings and fill strips whose part numbers also start with the letters WB



Auto Glass & Related Products

Tips for Finding Auto Glass-Related Product Numbers

When searching for auto-related products online at www.wholesaleglassdist.com, the following information may be helpful to you:

You don't have to know the entire part number. You can type in just the first few letters or any portion of the part number you may know, and then click "Go!" to browse through parts that match your search terms.

Here are some tips to guide you in searching for some of the most commonly requested auto-related parts we carry:

- Side-view and rear-view mirror part numbers start with the letters "CM" (for "convex mirror") followed by a number corresponding to Burco's part numbers. 
- Rain sensor kits begin with the letters "RSK"
- Sika products begin with the letters "SIKA" 
- Essex products begin with "U-" 
- Equalizer products begin with "EQ" 
- 3M products begin with "M3" 
- Wiper blade part numbers begin with "WB-"
(Tip: be sure to include the dash or you will pull up several hundred moldings and fill strips whose part numbers also start with the letters WB)
- Other items can be found by searching for "Tool," "Blade," or "Tape"

To Order Call: 1-800-277-5223

4

Flat Glass

These parts may be purchased through our website (www.wholesaleglassdist.com)
by using the part numbers provided in this chapter.



To Order Call: 1-800-277-5223

Flat Glass

This chapter consists of the following subsections:

<u>Clear, Tinted, & Low-E Plate Glass</u>	<u>4.1</u>
<u>Patterned Plate Glass</u>	<u>4.2</u>
<u>Laminated Glass</u>	<u>4.3</u>
<u>Nonglare & Reflective Glass</u>	<u>4.4</u>
<u>Pyrex, Pyroceram, & Wire Glass</u>	<u>4.5</u>

These parts may be purchased through our website (www.wholesaleglassdist.com) by using the part numbers provided in this chapter.



4.1 Clear, Tinted, & Low-E Plate Glass

Wholesale Glass Distributors, Inc.

4

Thickness	Color	Dimensions	Part Number
3/32" SSB Single Strength	Clear	36 X 60	PL332CL3660
		36 X 84	PL332CL3684
		48 X 60	PL332CL4860
		48 X 72	PL332CL4872
		48 X 84	PL332CL4884
		48 X 96	PL332CL4896
		60 X 84	PL332CL6084
		72 X 84	PL332CL7284
1/8" DSB Double Strength	Bronze	48 X 84	PL18BZ4884
		60 X 84	PL18BZ6084
		60 X 96	PL18BZ6096
		72 X 84	PL18BZ7284
		72 X 96	PL18BZ7296
		Clear	36 X 60
	36 X 72		PL18CL3672
	36 X 78		PL18CL3678
	36 X 84		PL18CL3684
	46 3/4 X 56 7/8		PL18CL46X56
	48 X 60		PL18CL4860
	48 X 72		PL18CL4872
	48 X 84		PL18CL4884
	48 X 96		PL18CL4896
	60 X 72		PL18CL6072
	60 X 84		PL18CL6084
	60 X 96		PL18CL6096
	72 X 84		PL18CL7284
	72 X 96		PL18CL7296
	Gray	48 X 84	PL18GY4884
		60 X 84	PL18GY6084
		60 X 96	PL18GY6096
		72 X 84	PL18GY7284
		72 X 96	PL18GY7296
	Graylite 31	60 X 96	PL18GYLITE6096
		72 X 84	PL18GYLITE7284
		72 X 96	PL18GYLITE7296
	Green	72 X 84	PL18GN7284-3.2
		72 X 96	PL18GN7296-3.2
	Low-E	60 X 84	PL18LO6084
		60 X 96	PL18LO6096
		72 X 84	PL18LO7284
72 X 96		PL18LO7296	

Flat Glass

Continued...



To Order Call: 1-800-277-5223

4.1 Clear, Tinted, & Low-E Plate Glass

Flat Glass

Thickness	Color	Dimensions	Part Number
3/16"	Bronze	48 X 130	PL316BZ48130
		60 X 130	PL316BZ60130
		72 X 130	PL316BZ72130
		84 X 130	PL316BZ84130
		96 X 130	PL316BZ96130
	Clear	48 X 100	PL316CL48100
		48 X 130	PL316CL48130
		48 X 96	PL316CL4896
		60 X 130	PL316CL60130
		72 X 130	PL316CL72130
		84 X 130	PL316CL84130
	Gray	48 X 130	PL316GY48130
		60 X 130	PL316GY60130
		72 X 130	PL316GY72130
		84 X 130	PL316GY84130
		96 X 130	PL316GY96130
	Green	72 X 130	PL316GN72130
		96 X 130	PL316GN96130
	Low-E	72 X 130	PL316LO72130
		72 X 84	PL316LO7284
84 X 130		PL316LO84130	
96 X 130		PL316LO96130	
1/4"	Bronze	48 X 130	PL14BZ48130
		60 X 130	PL14BZ60130
		72 X 130	PL14BZ72130
		84 X 130	PL14BZ84130
	Clear	48 X 100	PL14CL48100
		48 X 130	PL14CL48130
		60 X 100	PL14CL60100
		60 X 120	PL14CL60120
		60 X 130	PL14CL60130
		72 X 100	PL14CL72100
		72 X 130	PL14CL72130
		84 X 130	PL14CL84130
		84 X 144	PL14CL84144
		96 X 130	PL14CL96130
96 X 144	PL14CL96144		
Continued...			



4.1 Clear, Tinted, & Low-E Plate Glass

Thickness	Color	Dimensions	Part Number
1/4"	Dark Blue	88 X 126	PL14BLUE88126
	Gray	48 X 130	PL14GY48130
		60 X 130	PL14GY60130
		72 X 130	PL14GY72130
		84 X 130	PL14GY84130
Graylite 14	84 X 130 96 X 130	PL14GYLT84130 PL14GYLT96130	
Low-E	84 X 130	PL14LO84130	
3/8"	Bronze	88 1/2 X 126	PL38BZ88.5X126
	Clear	48 X 130	PL38CL48130
		60 X 130	PL38CL60130
		72 X 130	PL38CL72130
		84 X 130	PL38CL84130
Gray	48 X 130 88 1/2 X 126	PL38GY48130 PL38GY88.5X126	
1/2"	Clear	48 X 130	PL12CL48130
		60 X 130	PL12CL60130
		72 X 130	PL12CL72130
		84 X 130	PL12CL84130



To Order Call: 1-800-277-5223

4.2 Patterned Plate Glass

The following patterns are arranged in alphabetical order. If you do not see the pattern you are looking for, please contact a WGD representative. We can usually find just about any pattern of glass you might need through our network of suppliers, including Spectrum, Wissmach, & Kokomo patterns, and we would be happy to special order any glass that meets your needs.

Remember:
If you don't see a pattern listed in this manual, one of our CSRs will gladly custom order it for you!

Pattern	Thickness	Dimensions	Item Number
Antique	1/4"	60 5/8 x 94 1/2	PG14ANTQ6094
	1/8"	63 x 83	PG18ANTQ6383
Aquatex (Spraylite)	3/16"	60 x 84	PG316AQ6084
Autumn	1/4"	52 x 84	PG14AUTM5284
	5/32"	52 x 84	PG532AUTM5284
Bamboo	3/16"	60 x 84	PG316BAMBOO6084
Baroque	1/8"	24 x 48	PG18BQ2448
Cotswold	5/32"	52 x 84	PG532CTSWLD5284
Double Glue Chip	1/8"	48 x 84	PG18DBLGC4884
	3/16"	48 x 84	PG316DBLGC4884
Flemish	1/4"	52 x 84	PG14FLEM5284
	1/8"	32 x 42	PG18-W01FLEMISH
	5/32"	52 x 84	PG532FLEM5284
Florentine	1/8"	32 x 42	PG18FL3242
Flutex	3/16"	60 x 84	PG316FLT6084
Full Restoration	1/8"	24 x 36	PG18-FULLRES
German New Antique	1/8"	30 x 40	PG18GNA0189-1/2
Hammered	5/32"	60 x 84	PG532HAMMER6084
J3 (Pattern 62)	1/8"	60 x 84	PG18J36084
		72 x 84	PG18J37284
	3/16"	60 x 84	PG316J36084
		72 x 84	PG316J37284
Krinkle	1/8"	24 x 48	PG18-100K2448
Medium Amber	1/8"	32 x 42	PG18-W45M
Morisco	5/32"	67 x 87	PG532MORIS6787
Neo Renovation	1/8"	36 x 48	PG18NR3648
Rain (Niagra)	1/4"	72 x 96	PG14RAIN7296
	3/16"	60 x 84	PG316RAIN6084
	3/8"	72 x 84	PG38RAIN7284
Reeded	1/4"	60 x 100	PG14REED60100
	5/32"	60 x 100	PG532REED60100
Rolled Glue Chip	3/16"	48 x 84	PG316ROLLGC4884
Satin	1/4"	88 1/2 x 126	PG14SATIN88126
	1/8"	63 x 88 1/2	PG18SATIN6388.5
	3/8"	94 31/64 x 126 3/8	PG38SATIN94126
Seedy	1/8"	24 x 48	PG18SEEDY2448
		30 x 72	PG18SEEDY3072
		32 x 42	PG18-W01SEEDY
Single Glue Chip	1/8"	60 x 84	PG18GC6084
	3/16"	36 x 48	PG316GC3648
	3/8"	42 x 96	PG38CG4296
Super Chip	1/4"	36 x 48	PG14SUPER3648
Thin Ribbed (Rayado)	5/32"	65 x 126	PG532THINR65126
Water	1/8"	24 x 48	PG18100W2448
		24 x 72	PG18100W2472

Flat Glass



4.2 Patterned Plate Glass

Flat Glass

4.3 Laminated Glass

Thickness	Color	Dimensions	ItemNumber
1/4"	Bronze	32 X 78	LM14BZ3278
		36 X 84	LM14BZ3684
		48 X 84	LM14BZ4884
		48 X 96	LM14BZ4896
	Clear	21 X 60	LM14CL2060
		24 X 60	LM14CL2460
		32 X 78	LM14CL3278
		34 X 80	LM14CL3480
		36 X 48	LM14CL3648
		36 X 60	LM14CL3660
		36 X 84	LM14CL3684
		40 X 80	LM14CL4080
		42 X 84	LM14CL4284
		48 X 80	LM14CL4880
		48 X 84	LM14CL4884
		48 X 96	LM14CL4896
		50 X 72	LM14CL5072
		60 X 96	LM14CL6096
	72 X 96	LM14CL7296	
	Dark Bronze	32 X 50	LM14BZZ3250
		36 X 60	LM14BZZ3660
	Dark Gray	28 X 60	LM14GYY2860
		32 X 50	LM14GYY3250
		36 X 60	LM14GYY3660
	Gray	32 X 78	LM14GY3278
		36 X 84	LM14GY3684
		48 X 84	LM14GY4884
		48 X 96	LM14GY4896
	Green	16 X 60	LM14GN1660
		20 X 60	LM14GN2060
		24 X 60	LM14GN2460
		36 X 60	LM14GN3660
36 X 84		LM14GN3684	
40 X 80		LM14GN4080	
48 X 60		LM14GN4860	
48 X 84		LM14GN4884	
48 X 96	LM14GN4896		
Shaded (green with blue shade band across top)	24 X 48	LM14SH2448	
	28 X 48	LM14SH2848	
	28 X 60	LM14SH2860	
	36 X 48	LM14SH3648	
	36 X 60	LM14SH3660	
	42 X 50 (10" Band)	LM14SH4250	
	42 X 50 (6" Band)	LM14SH4250 6	
	45 X 45	LM14SH4545	
	48 X 48	LM14SH4848	
7/32"	Clear	48 X 84	LM732CL4884
	Green	48 X 84	LM732GN4884
9/16"	Clear	27 9/16 X 72 5/8 (YKK)	SR916CL2772
		63 7/8 X 102 5/8	LM9/16CL63 X102
		72 X 120	LM9/16CL72120

4.4 Nonglare & Reflective Glass

Nonglare Glass

Dimensions	Item Number	How Sold
24 x 36	NONGLARE 24X36	Individually
30 x 40	NONGLARE30X40	Box of 6
32 x 40	NONGLARE32X40	Box of 6
36 x 48	NONGLARE36X48	Box of 4

Reflective Glass

Solarcool Bronze

Dimensions	Item Number
72 x 130	PL14SCBZ72130
84 x 130	PL14SCBZ84130
88 x 126	PL14SCBZ89127
84 x 130	PL316SCBZ84130
88 x 126	PL316SCBZ88126
96 x 130	PL316SCBZ96130

Solarcool Gray

Dimensions	Item Number
72 x 130	PL14SCGY72130
88 x 126	PL14SCGY84130
96 x 130	PL14SCGY96130
84 x 130	PL316SCGY84130
96 x 130	PL316SCGY96130

Mirrorpane

Dimensions	Item Number
72 x 130	MR14MP72130



To Order Call: 1-800-277-5223

4.5 Pyrex, Pyroceram, & Wire Glass

Pyrex

Can withstand temperatures up to 900 degrees. WGD sells this glass cut to size or in sheets of 30 x 60. It is available in 1/8" thickness.

Item Number
PYREX18 3060

Pyroceram

Can withstand temperatures in excess of 1400 degrees. WGD sells this glass cut to size or in sheets of 31 x 62 or 33 x 62.

Item Number
PYRO CERAM 3060
PYRO CERAM 3362

Wire Glass

WGD carries wire glass in both diamond (Misco) and square (Baroque) patterns.

	Dimensions	Item Number
Diamond (Misco)	78 x 100	WG14CL78100
	78 x 130	WG14CL78130
Square (Baroque)	78 x 100	WG14SQ78100

FLAT GLASS



5

Mirrors

These parts may be purchased through our website (www.wholesaleglassdist.com)
by using the part numbers provided in this chapter.



To Order Call: 1-800-277-5223

Mirrors

This chapter consists of the following subsections:

<u>Plate Mirrors</u>	<u>5.1</u>
<u>Beveled Mirrors, Strips, Corners & Tees</u>	<u>5.2</u>
<u>Mirror Plates</u>	<u>5.3</u>

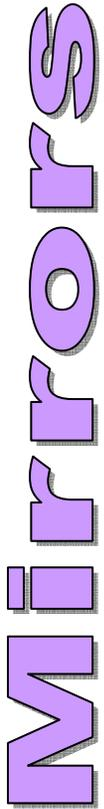

These parts may be purchased through our website (www.wholesaleglassdist.com)



5.1 Plate Mirrors

WGD carries clear, bronze, and gray 1/4" mirror, as well as 1/8" clear mirror:

	Dimensions	ItemNumber
1/4" Clear	36 X 100	MR14CL36100
	36 X 120	MR14CL36120
	40 X 100	MR14CL40100
	42 X 120	MR14CL40120
	42 X 100	MR14CL42100
	42 X 120	MR14CL42120
	48 X 100	MR14CL48100
	48 X 120	MR14CL48120
	48 X 144	MR14CL48144
	48 X 84	MR14CL4884
	60 X 100	MR14CL60100
	60 X 120	MR14CL60120
	72 X 100	MR14CL72100
	72 X 120	MR14CL72120
	72 X 130	MR14CL72130
	72 X 144	MR14CL72144
	1/8" Clear	24 X 48
48 X 60		MR18CL4860
48 X 84		MR18CL4884
48 X 96		MR18CL4896
1/4" Bronze	72 X 100	MR14BZ72100
1/4" Gray	72 X 100	MR14GY72100

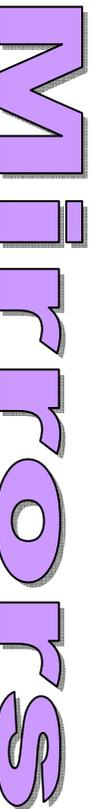

Mirror Clips & Rosettes

	Item Number
Chrome EZ Mount Clips (1/4")	MRCLIPCR14
Plastic Clips (1/4")	MRCLIPPL14
Plastic Clips (1/8")	MRCLIPPL18
Mirror Rosettes	MRROSETTES





To Order Call: 1-800-277-5223

5.2 Beveled Mirrors, Strips, Corners & Tees

Beveled Mirrors

WGD carries several standard sizes of beveled mirrors in stock (See section III of this manual for information on ordering custom beveled mirrors):

Dimensions	Item Number
18 X 68	MR14BE1868
20 X 68	MR14BE2068
22 X 68	MR14BE2268
24 X 68	MR14BE2468
21 x 31 (Oval)	MR14CL2131OVAL
24 X 37 (Oval)	MR14CL2437OVAL

Beveled Mirror Strips

Dimensions	Item Number
1 X 100	MR14CL1100
2 X 100	MR14CL2100
3 X 100	MR14CL3100
4 X 100	MR14CL4100
8 X 100	MR14CL8100
2 X 120	MR14CL2120
3 X 120	MR14CL3120
4 X 120	MR14CL4120

Beveled Mirror Corners & Tees

	Size	Item Number
Beveled Mirror Corners (Regular)	2"	MRCORNER2
	3"	MRCORNER3
	4"	MRCORNER4
Beveled Mirror Corners (Square)	2"	MRCORNER2SQ
	3"	MRCORNER3SQ
	4"	MRCORNER4SQ
Beveled Mirror Tees	2"	MRTEE2
	3"	MRTEE3
	4"	MRTEE4

MIRRORS



5.3 Mirror Plates

Our acrylic mirror plates (see next two pages) come in the following sizes:

Singles (MRPL-101 thru MRPL-117)

Regular	2.875" x 4.75"
Regular Decora	2.875" x 5.2"
Oversize	3.5" x 5.2"
Jumbo	4" x 6"

Doubles (MRPL-201 thru MRPL-208)

Regular	4.75" x 4.75"
Regular Decora	4.75" x 5.2"
Oversize	5.2" x 5.2"
Jumbo	6" x 6"

Triples (MRPL-301 thru MRPL-307)

Oversize	7.125" x 5.2"
Jumbo	7.875" x 6"

4 Gangs (MRPL-401 thru MRPL-407)

Oversize	9" x 5.2"
Jumbo	9.75" x 6"

Tip: "Decora" refers to the wider rectangle holes, as seen on MRPL part numbers 102, 202, 205, 206, 302, 305, 307, 302, and 407.

Tip: Regular, Jumbo, and Oversize are all 1/8" thick. Image, Jumbo Image, and Oversize Image are all 3/16" thick.



To Order Call: 1-800-277-5223

5.3 Mirror Plates

MIRRORS

101 

Size	Item Number
Jumbo	MRPL-101-J
Oversize	MRPL-101-O
Jumbo Image	MRPL-101-JI
Oversize Image	MRPL-101-OI
Image	MRPL-101-I

102 

Size	Item Number
Jumbo	MRPL-102-J
Oversize	MRPL-102-O
Image	MRPL-102-I
Jumbo Image	MRPL-102-JI
Oversize Image	MRPL-102-OI

103 

Size	Item Number
Jumbo	MRPL-103-J
Oversize	MRPL-103-O
Image	MRPL-103-I
Jumbo Image	MRPL-103-JI
Oversize Image	MRPL-103-OI

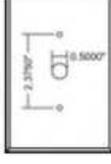
104 

Size	Item Number
Oversize	MRPL-104-O
Oversize Image	MRPL-104-OI

105 

Size	Item Number
Oversize	MRPL-105-O
Oversize Image	MRPL-105-OI

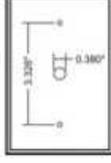
110 

Size	Item Number
Oversize	MRPL-110-O
Jumbo Image	MRPL-110-JI
Oversize Image	MRPL-110-OI

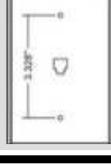
111 

Size	Item Number
Oversize	MRPL-111-OW
Oversize Image	MRPL-111-OWI

113 

Size	Item Number
Oversize Image	MRPL-113-OI

117 

Size	Item Number
Oversize Image	MRPL-117-OI

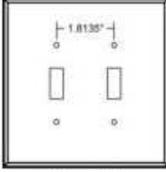
201 

Size	Item Number
Jumbo	MRPL-201-J
Oversize	MRPL-201-O
Image	MRPL-201-I
Jumbo Image	MRPL-201-JI
Oversize Image	MRPL-201-OI

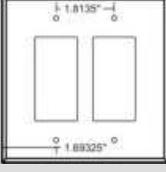
202 

Size	Item Number
Oversize	MRPL-202-O
Image	MRPL-202-I
Jumbo Image	MRPL-202-JI
Oversize Image	MRPL-202-OI

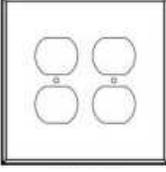
203 

Size	Item Number
Oversize	MRPL-203-O
Image	MRPL-203-I
Jumbo Image	MRPL-203-JI
Oversize Image	MRPL-203-OI

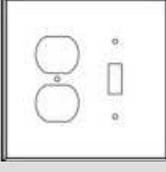
204 

Size	Item Number
Jumbo	MRPL-204-J
Oversize	MRPL-204-O
Image	MRPL-204-I
Jumbo Image	MRPL-204-JI
Oversize Image	MRPL-204-OI

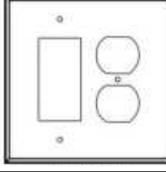
205 

Size	Item Number
Jumbo	MRPL-205-J
Oversize	MRPL-205-O
Jumbo Image	MRPL-205-JI
Oversize Image	MRPL-205-OI

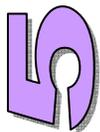



5.3 Mirror Plates

MIRRORS

206

Size	Item Number
Oversize	MRPL-206-O
Jumbo Image	MRPL-206-JI
Oversize Image	MRPL-206-OI

207

Size	Item Number
Oversize	MRPL-207-O
Oversize Image	MRPL-207-OI

208

Size	Item Number
Oversize	MRPL-208-O
Oversize Image	MRPL-208-OI

301

Size	Item Number
Oversize	MRPL-301-O
Jumbo Image	MRPL-301-JI
Oversize Image	MRPL-301-OI

302

Size	Item Number
Oversize	MRPL-302-O
Jumbo Image	MRPL-302-JI
Oversize Image	MRPL-302-OI

303

Size	Item Number
Oversize	MRPL-303-O
Jumbo Image	MRPL-303-JI
Oversize Image	MRPL-303-OI

304

Size	Item Number
Jumbo Image	MRPL-304-JI
Oversize Image	MRPL-304-OI

305

Size	Item Number
Jumbo Image	MRPL-305-JI
Oversize Image	MRPL-305-OI

306

Size	Item Number
Jumbo Image	MRPL-306-JI
Oversize Image	MRPL-306-OI

307

Size	Item Number
Jumbo Image	MRPL-307-JI
Oversize Image	MRPL-307-OI

401

Size	Item Number
Oversize	MRPL-401-O
Jumbo Image	MRPL-401-JI
Oversize Image	MRPL-401-OI

402

Size	Item Number
Oversize	MRPL-402-O
Jumbo Image	MRPL-402-JI
Oversize Image	MRPL-402-OI

404

Size	Item Number
Oversize Image	MRPL-404-OI

407

Size	Item Number
Oversize Image	MRPL-407-OI





To Order Call: 1-800-277-5223

Mirror Plated Pull Knobs

Mirrors

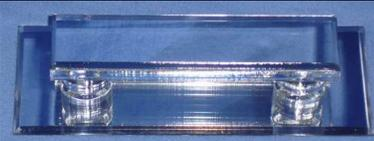
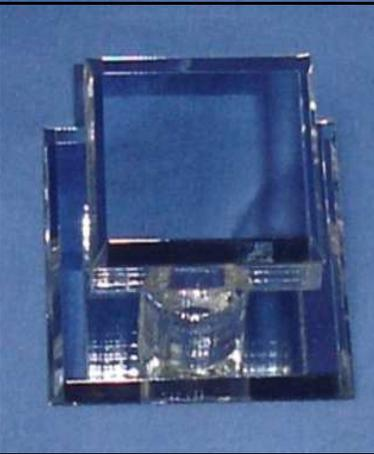
Shape	Part Number	Picture
Rectangle	MRPL-KNOLP	
Square	MRPL-KNOLS	



6

Acrylics & Lexan

These parts may be purchased through our website (www.wholesaleglassdist.com)
by using the part numbers provided in this chapter.

Acrylics

Thickness	Color/Type	Size	Item Number
.100	Clear	30 x 32	AC10CL3032
		32 x 32	AC10CL3232
.093	Clear	24 x 48	AC093CL2448
		30 x 60	AC093CL3060
		36 x 72	AC093CL3672
		48 x 96	AC093CL4896
1/8	Black	48 x 96	AC18BLK4896
	Bronze	48 x 96	AC18BZ4896
	Clear	48 x 96	AC18CP4896
		36 x 60	AC18CL3660
		48 x 120	AC18CL48120
		60 x 96	AC18CL6096
	72 x 96	AC18CL7296	
	Dark Gray	48 x 96	AC18DRKGY4896
	Gray	48 x 96	AC18GY4896
	Mirror	48 x 96	AC18MR4896
	Obscure	48 x 96	AC18OBS4896
Prismatic Panel	24 x 48	AC18PP2448	
	48 x 96	AC18PP4896	
White	48 x 96	AC18WH4896	
3/16	Bronze	48 x 96	AC316BZ4896
	Clear	48 x 96	AC316CL4896
		60 x 96	AC316CL6096
White	48 x 96	AC316WH4896	
1/4	Black	48 x 96	AC14BLK4896
		60 x 120	AC14BLK60120
	Bronze	48 x 96	AC14BZ4896
	Clear	48 x 96	AC14CP4896
		60 x 120	AC14CL60120
		60 x 96	AC14CL6096
		72 x 120	AC14CL72120
		72 x 96	AC14CL7296
		38 x 78	AC14CP3878
	48 x 120	AC14CP48120	
	Dark Gray	48 x 96	AC14DRKGY4896
	Gray	48 x 96	AC14GY4896
	Mirror	48 x 96	AC14MR4896
	Ripple Hair	48 x 96	AC14RPLHAIR4896
White	48 x 120	AC14WH48120	
	48 x 96	AC14WH4896	
3/8	Clear	48 x 96	AC38CL4896
1/2	Clear	48 x 96	AC12CL4896

New Part



Lexan

Thickness	Color/Type	Size	Item Number
1/8	Bronze	48 x 96	AC18LXBRZ4896
	Clear	48 x 96	AC18LX4896
		48 x 120	AC18LX48120
		60 x 96	AC18LX6096
		72 x 96	AC18LX7296
Gray	48 x 96	AC18LXGY4896	
3/16	Bronze	48 x 96	AC316LXBZ4896
	Clear	48 x 96	AC316LX4896
		60 x 96	AC316LX6096
		72 x 96	AC316LX7296
Gray	48 x 96	AC316LXGY4896	
White	48 x 96	AC316LXWHT4896	
1/4	Bronze	48 x 96	AC14LXBZ4896
		72 x 96	AC14LXBZ7296
	Clear	48 x 96	AC14LX4896
		48 x 120	AC14LX48120
		60 x 120	AC14LX60120
		60 x 96	AC14LX6096
		72 x 120	AC14LX72120
		72 x 144	AC14LX72144
		72 x 96	AC14LX7296
	48 x 96	AC14LXGY4896	
White	48 x 96	AC14LXWHT4896	
XL10 UV Protected	48 x 96	AC14LXXL10-4896	
3/8	Clear	48 x 96	AC38LX4896
1/2	Clear	48 x 96	AC12LX4896

Acrylics & Lexan



To Order Call: 1-800-277-5223

7

Standard Tempered: Circles, IGs, & Doorlites

These parts may be purchased through our website (www.wholesaleglassdist.com)
by using the part numbers provided in this chapter.

To Order Call: 1-800-277-5223

Standard Tempered Circles

New Parts!!!

WGD now keeps 48" tempered circles in stock in the following varieties:

GLASS THICKNESS	EDGEWORK	PART NUMBER
1/2"	OG	CIRCLE1/2OG48
1/4"	PENCIL POLISH	CIRCLE1/4PP48
3/8"	BEVEL	CIRCLE3/8BE48
	PENCIL POLISH	CIRCLE3/8PP48

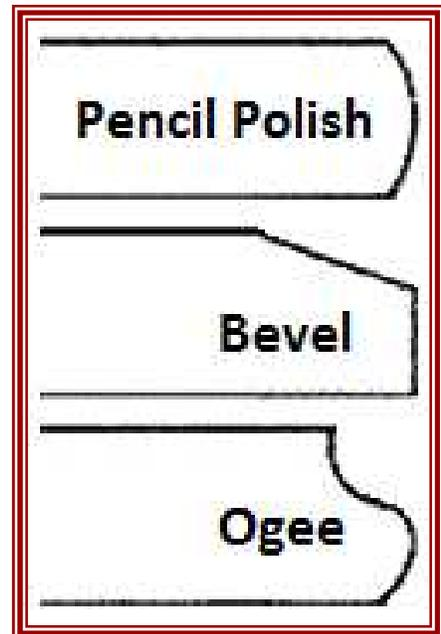
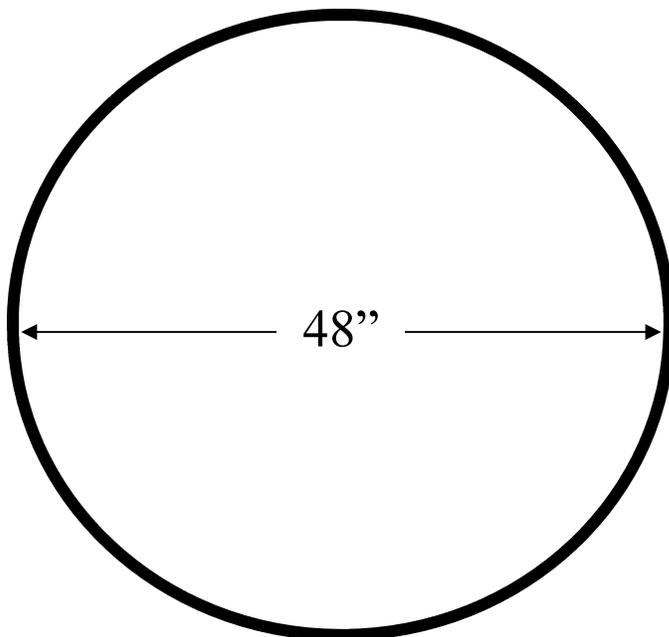

WGD will also make standard size tempered or annealed circles to your custom specifications. See Section 12 of this manual for more information!

Standard Insulated Doors

YKK Standard Insulated Tempered Units:

Dimensions	Thickness	Color	Item Number
31 1/8 x 72 1/2	1"	Bronze	SR1BZ3172
		Clear	SR1CL3172
		Gray	SR1GY3172
	5/8"	Bronze	SR58BZ3172
		Clear	SR58CL3172
		Gray	SR58GY3172
31 1/8 x 76 1/2	1"	Bronze	SR1BZ3118
		Clear	SR1CL3118
		Gray	SR1GY3118
	5/8"	Bronze	SR58BZ3118
		Clear	SR58CL3118
		Gray	SR58GY3118

Patio Standard Insulated Tempered Units:

Dimensions	Thickness	Color	Item Number
28 x 76	5/8"	Bronze	SR58BZ2876
		Clear	SR58CL2876
		Gray	SR58GY2876
		Low-E	SR58LO2876
34 x 76	1"	Clear	SR1CL3476
	5/8"	Bronze	SR58BZ3476
		Clear	SR58CL3476
		Gray	SR58GY3476
		Low-E	SR58LO3476
34 x 90	5/8"	Clear	SR58CL3490
46 x 76	5/8"	Bronze	SR58BZ4676
		Clear	SR58CL4676
		Gray	SR58GY4676
		Low-E	SR58LO4676

WGD will also make standard size tempered units to your custom specifications (adding muntins, changing overall thickness, etc.) at a discounted price from our custom tempered IGs.

To Order Call: 1-800-277-5223

Standard Doorlites (Single)

Dimensions	Thickness	Color	ItemNumber
25 3/8 x 69 13/16	3/16"	Clear	SR316CL2569
25 5/8 x 76 3/4	3/16"	Gray	SR316GY2576
28 3/8 x 70 7/8	3/16"	Bronze	SR316BZ2870
		Clear	SR316CL2870
		Gray	SR316GY2870
28 x 76	1/8"	Bronze	SR18BZ2876
		Clear	SR18CL2876
		Gray	SR18GY2876
		Low-E	SR18LO2876
	3/16"	Clear	SR316CL2876
		Gray	SR316GY2876
31 1/2 x 77 5/8	3/16"	Bronze	SR316BZ3278
		Clear	SR316CL3278
31 1/8 x 68 1/2	3/16"	Bronze	SR316BZ3168
		Clear	SR316CL3168
		Gray	SR316GY3168
31 1/8 x 72 1/2	1/8"	Bronze	SR18BZ3172
		Clear	SR18CL3172
		Gray	SR18GY3172
	3/16"	Bronze	SR316BZ3172
		Clear	SR316CL3172
		Gray	SR316GY3172
Low-E	SR316LO3172		
	Solarcool Bronze	SR316SCBZ3172	
31 1/8 x 76 1/2	1/8"	Bronze	SR18BZ3118
		Clear	SR18CL3118
		Gray	SR18GY3118
	3/16"	Bronze	SR316BZ3118
		Clear	SR316CL3118
		Clear	SR316CL3177
Gray	SR316GY3118		
Solarcool Bronze	SR316SCBZ3118		
31 3/16 x 76 11/16	3/16"	Clear	SR316CL3077
31 3/8 x 76 5/8	3/16"	Bronze	SR316BZ3176
		Clear	SR316CL3176
		Gray	SR316GY3176
31 3/8 x 77 1/4	3/16"	PPG Bronze	SRPPG316BRZ31
		PPG Clear	SRPPG316CL31
		PPG Gray	SRPPG316GY31
31 5/8 x 76 3/4	3/16"	Bronze	SR316BZ3277
		Clear	SR316CL3277
31 5/8 x 76 5/8	3/16"	Bronze	SR316BZ3276
		Clear	SR316CL3276
31 7/16 x 77 3/8	3/16"	Clear	SR316CL3178

Dimensions	Thickness	Color	ItemNumber
34 x 76	1/8"	Bronze	SR18BZ3476
		Clear	SR18CL3476
		Gray	SR18GY3476
		Low-E	SR18LO3476
	3/16"	Bronze	SR316BZ3476
		Clear	SR316CL3476
		Gray	SR316GY3476
34 x 90	5/32"	Clear	SR532CL3490
37 1/8 x 72 1/2	3/16"	Bronze	SR316BZ3772
		Clear	SR316CL3772
		Gray	SR316GY3772
37 1/8 x 76 1/2	3/16"	Bronze	SR316BZ3718
		Clear	SR316CL3718
		Gray	SR316GY3776
37 5/8 x 76 5/8	3/16"	Clear	SR316CL3758
46 x 76	1/8"	Bronze	SR18BZ4676
		Clear	SR18CL4676
		Gray	SR18GY4676
	3/16"	Bronze	SR316BZ4676
Clear		SR316CL4676	
Gray		SR316GY4676	
Low-E		SR316LO4676	

3/16" Doorlites With Mail Slots

Dimensions	Thickness	Color	Item Number
31 1/8 x 76 1/2	3/16"	Clear	SR316CL3118SLOT
31 1/8 x 76 1/2	3/16"	Gray	SR316GY3118SLT
31 3/8 x 77 1/4	3/16"	Clear	SR316CL3177SLOT

To Order Call: 1-800-277-5223

8

Showcase Materials

These parts may be purchased through our website (www.wholesaleglassdist.com)
by using the part numbers provided in this chapter.

Showcase Materials

The following are the part numbers for the showcase materials WGD carries.

Stock Lengths

Description	Length	Color	Item Number
Double Channel	12'	Aluminum Bronze	SCCHANNELAL SCCHANNELBZ
	16'	Aluminum	SCCHANNELAL16
Double Channel (Deep)	12'	Aluminum Bronze	SCCHANNELALDP SCCHANNELBZDP
Double Track	12'	Aluminum Bronze	SCTRACKAL SCTRACKBZ
	16'	Aluminum	SCTRACKAL16
Shoe	12'	Aluminum Bronze	SCSHOEAL SCSHOEBZ
	16'	Aluminum	SCSHOEAL16
Single Track	12'	Bronze Aluminum	SCSINGLE- SCSINGLETRACK

New Part!

We now carry a new taller double track in bronze (SCTRACKSECBZ).

Other Materials

Description	Color	Item Number
Finger Pull	Aluminum	SCPULLAL
	Black	SCPULLBK
	Bronze	SCPULLBZ
	Clear	SCPULLCL
Wheels	Nylon	SCWHEEL
	Steel	SCWHEELSTEEL
Guide		SCGUIDE
Lock		SCLOCK

New Part!

WGD now offers steel wheels to fit CRL brand showcase materials, which are different from the showcase materials WGD sells (SCWHEEL CRL).

The following pages illustrate the showcase materials we carry and the various ways that they can be set up. The parts in these illustrations have been color-coded to make the diagrams easier to understand.

To Order Call: 1-800-277-5223

Showcase Materials

Showcase Materials



SCWHEEL
Steel/Nylon Wheel



SCLOCK
Lock



SCGUIDE
Plastic Guide

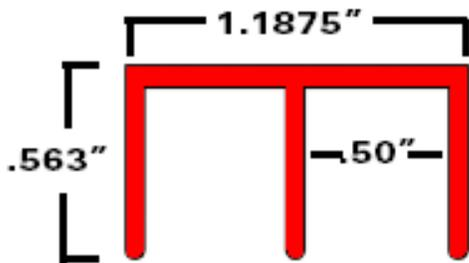

SCCHANNEL
Double Channel

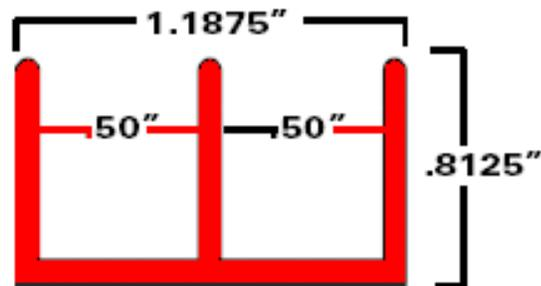

SCCHANNELDP
Deep Double Channel

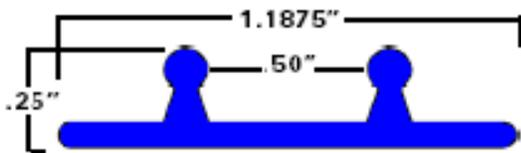

SCTRACK
Double Track

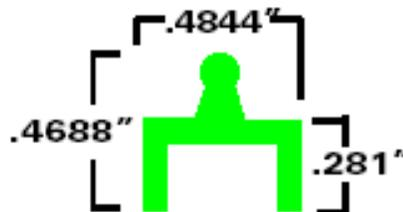

SCSINGLETRACK
Single Track



SCSHOE
Glass Shoe

Showcase Materials

Showcase Setup Options

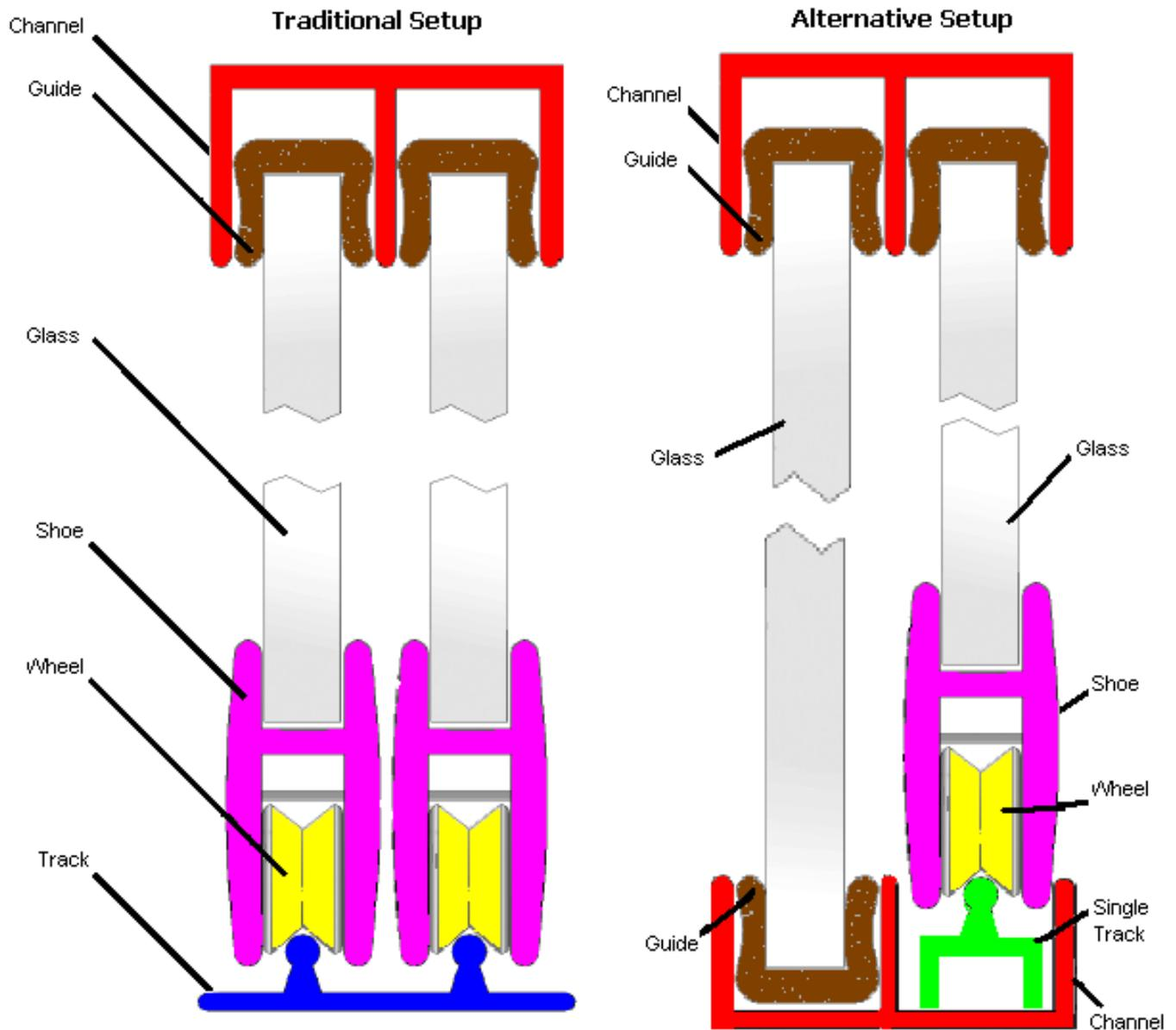

(Both pieces of glass movable)

(One piece of glass is stationary)

To Order Call: 1-800-277-5223

9

Shelving

These parts may be purchased through our website (www.wholesaleglassdist.com) by using the part numbers provided in this chapter.



To Order Call: 1-800-277-5223

Shelving

Shelving

Item Number	Item Description	Image
SH-110300	SUPRT BRACE 12" (100 PER BOX)	
SH-116400	164/ SUPRT BRACE 12"	
SH-116600	166/ SUPRT BRACE 16"	
SH-118000	180/ SUPRT BRACE 20"	
SH-16200	SUPPORT BRACE 9" (100 PER BOX)	
SH-11700	71" SQUARE POLE (50 PER BOX)	
SH-11800	85" SQUARE POLE (50 PER BOX)	
SH-201200	12 X 3/4" HANG ROD ROUND	
SH-564900	CORNER ROUND BAR	



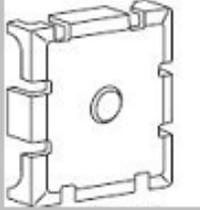
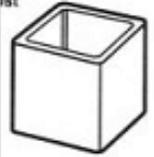
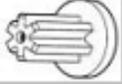
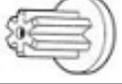
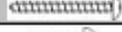

Shelving

Item Number	Item Description	Image
SH-5917400	TOTALSLIDE ROD JOINER (250)	
SH-117200	UNIVERSAL JOINER PLATE (1500)	
SH-12000	CORNER SUPPORT (100 PER BOX)	
SH-16800	S&R END CAP (100 PER BOX)	
SH-20300	SMALL END CAP (10000 PER BOX)	
SH-20400	LARGE END CAP (1000 PER BOX)	
SH-208300	EXTERNAL POLE END CAP EACH	
SH-24700	SQUARE CAPS FOR POLES(800 BOX)	
SH-96900	TOTALSLIDE SHELF STOP(100 BX)	
SH-208100	INTERNAL POLE END CAP EACH	
SH-208500	INTERNAL POLE CONNECTOR EACH	
SH-20800	#8 X 1" PAN HEAD SCREW	
SH-21700	SELF TAPPING SCREWS 1/2"	

Shelving





To Order Call: 1-800-277-5223

Shelving

Shelving

Item Number	Item Description	Image
SH-95500	LOAD ANCHOR(3000 PER BOX)	
SH-25000	1/4" ANCHOR (3500 PER BOX)	
SH-30000	SHELF & ROD 12" X 12' (EA)	
SH-30500	SHELF & ROD 16" X 12' (EA)	
SH-31000	LINEN 9" X 12' (EA)	
SH-31800	CLOSEMESH 16" X 12' (EA)	
SH-32500	LINEN 20" X 12' (EA)	
SH-40200	CLOSEMESH 12" X 12' (EA)	
SH-40300	CLOSEMESH 20" X 12' (EA)	
SH-564000	SUPERSLIDE 12"X 12' (EA)	
SH-564200	S.SLIDE 16"X 12' (EA) (SH-320)	
SH-564800	CORNER SHELF SUPER SLIDE	n/a
SH-591400	TOTALSLIDE 12" X 12 FT	



Shelving



Shelving

Item Number	Item Description	Image
SH-591800	TOTALSLIDE 16" X 12 FT	
SH-598000	TOTALSLIDE CORNER SHELF (6 BX)	
SH-598100	TOTALSLIDE CORNER SHELF 16" (6	
SH-61200	CLAMPS (1000 PER BOX)	
SH-74000	HANG ROD BRACKET W SCREWS (100	n/a
SH-90300	ADD A BRKT HANG BAR (100-BOX)	
SH-92500	HANG BAR BRKT FOR SUPERSLIDE (
SH-97700	0" GAUGE PLE CLP (1000 PER BOX)	
SH-97800	4" GAUGE PLE CLP (1000 PER BOX)	
SH-91000	CLIP PRE LOADED 100-BAG	
SH-91100	WALL CLIP NON LOADED (5000 BX)	

Shelving





To Order Call: 1-800-277-5223

Shelving

Shelving

Item Number	Item Description	Image
SH-98100	CLIP(100 PER-BAG/250 PER BOX)	
SH-91400	END BRACKET WITHOUT ANCHORS	
SH-93300	END BRACKET W/ANCHOR (600 BOX)	
SH-98000	END BRCKT SPRSLD (500 PER BOX)	
SH-93200	END BRACKET PRELOADED (500 BX)	
SH-97900	END BRCKT SPRSLD (500 PER BOX)	
SH-98800	TOTALSLIDE WALLBKT(200PER BX)	
SH-92300	SHOE SUPRT (100 PER BOX)	



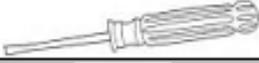

Shelving

Item Number	Item Description	Image
SH-9903700	12&16" TEMPLATE (EA)	
SH-909300	NYLON BUSHING FOR TEMPLATE	
SH-909400	METAL BUSHING FOR TEMPLATE	
SH-989700	PUSH TOOLS (EA)	
SH-39900	WHITE TOUCH UP PAINT 5 OZ	

Shelving



To Order Call: 1-800-277-5223

10

**Bath
Enclosures,
KDs, & Parts**

To Order Call: 1-800-277-5223

General Information

In the interest of space, this manual does not contain the part numbers of every shower door item we carry. However, the following information will help you in ordering the standard glazed doors, KDs, and other standard parts you might need. These items can all be ordered online at www.wholesaleglassdist.com.

WGD also specializes in building custom shower doors. Our knowledgeable customer service representatives will gladly assist you in creating the perfect bath enclosure for your customer's needs.

Part Numbers

WGD's part numbers for standard glazed bath enclosures are made up of the following components:

- "SD" for "shower door"
- The Alumax series number
- The color of the metal
- The color or style of the glass
- The width and height of the door

Example: A 58 3/4" x 71 1/2" 650 series shower door with silver metal and clear glass would be SD650SILCL5871.

The part numbers for standard KDs are similar:

- "SD" for "shower door"
- The Alumax series number
- "KD" for "knock-down kit"
- The color of the metal
- The width and height of the door

Example: A 42 3/4" x 71 1/2" 650 series KD with silver metal would be SD650KDSIL4271.

Glass & Metal Options

Glass Options

Standard Options

- Clear
- Obscure (J3; Pattern 62)

Custom Options

See section 4.2 of this manual for a more complete listing of pattern glasses WGD offers. The following are our highest sellers:

- Rain
- Glue Chip
- Aquatex
- Reed
- Flutex

Metal Finish Colors

Standard Options

- Gold (GLD)
- Silver (SIL)
- Brushed Nickel (BNKL)
- Satin (STN)
- Oil Rubbed Bronze (ORB)

Custom Options

- Black
- White (WHT)
- Cream
- Almond
- Wrought Iron
- Satin Nickel
- Platinum
- Burnished Copper
- Burnished Gold

The following pages describe several Alumax enclosure series we carry.

To Order Call: 1-800-277-5223

Sliders

640(bath)/650(shower) Series

- Adjustable Ball-bearing Rollers
- Inside & Outside Towel Bars
- Finger Pull / By-Pass Stop Keeps Inside Panel Closest to Shower Head
- Easy-Clean Open Track



640D(bath)/650(shower) Series

- Reversible Round, Euro-Styled Header
- Optional Architectural Quality Acrylic Towel Bars Mounted Through the Glass
- Optional 1/4" Glass & Additional Finishes

Source: Alumax

StikStalls



791 Series

- Simple Pivot Door and Panel



792 Series

- Corner Shower Enclosure
- Door is Full Width
- Perpendicular Panel



793 Series

- Door, Sidelite, and Return Panel



794 Series (Neo Angle)

- Corner Application
- Door in Center, Diagonal from Corner

Source: Alumax

To Order Call: 1-800-277-5223

Shower Door Parts

The remainder of this section contains diagrams, part numbers, and descriptions of our most commonly requested shower door parts. You can use the part numbers listed here to order these parts online at www.wholesaleglassdist.com.

If you don't find something you need, just call WGD and one of our customer service representatives will be happy to custom order it for you.

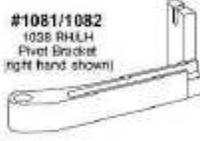
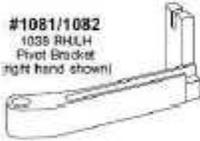
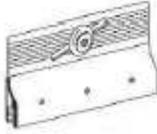
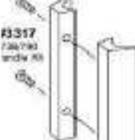
 <p>END CAP FOR SC-505</p> <p>SD0799BNKL END CAP FOR 505 HEAD</p>	 <p>SD0800SIL END CAP W/NOTCH FOR 505 HEAD</p>	 <p>EPW - OXK - 008D1 END CAP FOR SC-644 68233</p> <p>SD0801BNKL END CAP FOR 644 HEAD</p>
 <p>EPW - OXK - 00802</p> <p>SD0802BNKL END CAP W/NOTCH FOR 644 HEAD</p>	 <p>EPW - ODD - 00803 10" ANCHOR BRACKET 68342</p> <p>SD0803 ANCHOR MOUNT BRACKET</p>	 <p>EPW - ODD - 00804 WALL MOUNT BRACKET 68342</p> <p>SD0804 WALL MOUNT CLIP FOR 644 HEAD</p>
 <p>EPW - OXK - 00806 NO GAP FOR SC-646 68445</p> <p>SD0806BNKL END CAP FOR 646 HEAD</p>	 <p>EPW - OXK - 00807 NO GAP WITH NOTCH FOR SC-646 68445</p> <p>SD0807SIL END CAP W/NOTCH FOR 646 HEAD</p>	 <p>#1081/1082 1038 RHLH Pivot Bracket (right hand shown)</p> <p>SD1081SIL 1038 PIVOT BRACKET/RIGHT HAND</p>
 <p>#1081/1082 1038 RHLH Pivot Bracket (right hand shown)</p> <p>SD1082SIL 1038 PIVOT BRACKET/LEFT HAND</p>	 <p>#1511 506 730 Anchor Bracket</p> <p>SD1511 ANCHOR BRACKET FOR 542</p>	 <p>#1557 38736 Pivot Bracket</p> <p>SD1557SIL 738 PIVOT BRACKET</p>
 <p>SD1650SIL 1040/1050 Hangar Bracket</p>	 <p>SC-850 780 12 1/2" Wx 12"</p> <p>SD2282SIL SC 850 MACHINED WALL FILL 12"</p>	 <p>SD2527BNKL 340 HANDLE W/GASKET(T.B. BASE)</p>
 <p>#3317 788/780 End Cap Kit</p> <p>SD3317BNKL HANDLE SET W/SCREWS (18210)</p>	 <p>#4000 Drip Rail End Plug</p> <p>SD4000 END CAP SET FOR DRIP RAIL</p>	 <p>4016</p> <p>SD4016 340/340D GUIDE WITH SCREW</p>

To Order Call: 1-800-277-5223

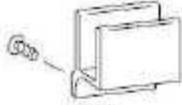
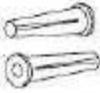
 <p>Strike Magnet</p> <p>SD4030 338/390 4 MAGNETS FOR HANDLE</p>	 <p>4041</p> <p>SD4041 338/390 END CAP FOR TOP RAIL</p>	 <p>#4048 Panel Guide</p> <p>SD4048 640 GUIDE WITH BLACK SCREW</p>
 <p>SD4082 NYLON BEARING W/SCREW {50}</p>	 <p>4084</p> <p>SD4084 90deg BRKT FOR 340/640</p>	 <p>#4106 Plastic Wall Anchors</p> <p>SD4106 PLASTIC WALL PLUGS</p>
 <p>#4112 Finger Pull with Decal</p> <p>SD4112 640 FINGER PULL WITH DECAL</p>	 <p>#4115 390/790 Pivot Spacer</p> <p>SD4115 NYLON SPACER FOR 790/390</p>	 <p>SD4123 90deg ANCHOR W/SCREWS {20} (SD)</p>
 <p>04124 135° Anchor Plate</p> <p>SD4124 135deg ANCHORS W/SCREWS {20}</p>	 <p>#4125 T-Bar Brkt & Sleeve</p> <p>SD4125BNKL CL T-BAR BRACK W/SLEEVE</p>	 <p>#4129 340 Handle with Gasket</p> <p>SD4129BNKL HANDLE FOR 340 W/GASKET</p>
 <p>#4142 Adjustment Wrench</p> <p>SD4142 ADJUSTMENT WRENCH {10}</p>	 <p>#4145 Jamb Bumper with Spacer</p> <p>SD4145 BUMPER</p>	 <p>#4160 Nylon Pivot Washer</p> <p>SD4160 NYLON WASHER {50}</p>
 <p>SD4207 CLIP FOR 2 PC HEADER</p>	 <p>#4248 Double Stick Tape</p> <p>SD4248 ADHESIVE DRIP TAPE 37 ROLL</p>	 <p>#4252 390/790 Pivot Block</p> <p>SD4252 PIVOTBLOCK LNG PIN FOR 790/738</p>

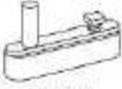
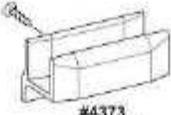
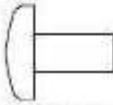
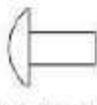
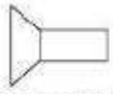
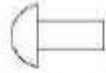
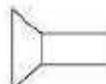
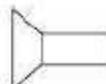
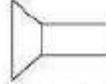
 <p>#4254 338/738 Pivot Block</p> <p>SD4254 PIVOTBLOCK SHT PIN FOR 390/338</p>	 <p>#4257 Gravity Pivot (male)</p> <p>SD4257 1038 GRAVITY PIVOT (MALE)</p>	 <p>#4356 740D Panel Guide</p> <p>SD4356 740D GUIDE WITH SCREW</p>
 <p>SD4357 740D NYLON BEARING W/SCREW(20)</p>	 <p>#4373 1038 Acrylic Panel Guide with Screw</p> <p>SD4373 1040/1050 GUIDE</p>	 <p>#4609 Pivot Bushing</p> <p>SD4609 BUSHING FOR C HINGE DOOR(PAIR)</p>
 <p>PAN HEAD</p> <p>SD5003SIL #6 32 X 1/4 PAN HEAD SIL(100)</p>	 <p>TRUSS HEAD</p> <p>SD5006SIL #8 32 X 1/4 TRUSS HEAD SIL</p>	 <p>TRUSS HEAD</p> <p>SD5013SIL #8 X 5/8 TRUSS HEAD SIL</p>
 <p>FLAT HEAD</p> <p>SD5018SIL #8 32 X 1/2 FLAT HEAD SELF TAP</p>	 <p>ROUND HEAD</p> <p>SD5020SIL #6 32 X 1 1/4 RND HEAD SIL</p>	 <p>#5080</p> <p>SD5080 SET SCREW PIVOT BLOCK (PR)</p>
 <p>#5095 Acorn Nut</p> <p>SD5095SIL #8 32 ACORN NUT SIL</p>	 <p>FLAT HEAD</p> <p>SD5098SIL #8 X 1 FLAT HEAD PILOT POINT</p>	 <p>FLAT HEAD</p> <p>SD5099SIL #8 X 1 1/4 FLAT HEAD PILOT PO</p>
 <p>TRUSS HEAD</p> <p>SD5103SIL #10 24"X 7/8" TRUSS HEAD SIL</p>	 <p>FLAT HEAD</p> <p>SD5105SIL #10 24 X 1 1/8 FLAT HEAD SIL</p>	 <p>TRUSS HEAD</p> <p>SD5108SIL #8 X 2 TRUSS HEAD SIL</p>

To Order Call: 1-800-277-5223

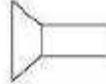
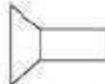
 <p>TRUSS HEAD</p> <p>SD5109SIL #6 X 3/8" TRUSS HEAD SIL</p>	 <p>FLAT HEAD</p> <p>SD5111SIL #10 24 X 1/2 FLAT HEAD SIL</p>	 <p>#5114 Allen Head Set Screw</p> <p>SD5114 ALLEN HEAD SET SCREW PIVOT</p>
 <p>#5115 5/64" Allen Wrench</p> <p>SD5115 ALLEN WRENCH</p>	 <p>TRUSS HEAD</p> <p>SD5116SIL #8 X 1 1/2 TRUSS HEAD SIL</p>	 <p>FLAT HEAD</p> <p>SD5117SIL #8 X 1 1/2 FLAT HEAD SIL</p>
 <p>FLAT HEAD</p> <p>SD5131SIL #6 X 1 3/4" FLAT HEAD SIL</p>	 <p>#5170 #8 x 2" Screw</p> <p>SD5170SIL #8 X 2 FLAT HEAD SIL</p>	 <p>SD5330 90deg ANCHOR W/SCREWS (20) (SD)</p>
 <p>SD69054BNKL 4" PULL FOR FRAMELESS W/MAG.</p>	 <p>7281</p> <p>SD7281BNKL T-BAR ASSEMBLY FOR 640</p>	 <p>7282</p> <p>SD7282BNKL T-BAR ASSY FOR 340</p>
 <p>SD7290SIL T-BAR KIT SIL 18"</p>	 <p>SD7291SIL T-BAR KIT SIL 24"</p>	 <p>07311 Adjustable Anchor (20) Plate w</p> <p>SD7311 ADJUSTABLE ANCHOR (20) PLATE W</p>
 <p>#7312 Deluxe Pull Knob Kit</p> <p>SD7312SIL DELUXE ACRYLIC PULL KNOB SIL</p>	 <p>18029</p> <p>SD8029BNKL 300/338 MAGNETIC CATCH KIT</p>	 <p>SD8044 PIVOT HINGE INSERT FOR 646</p>

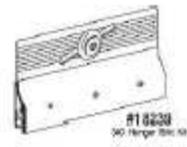
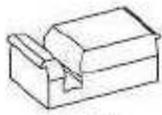
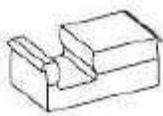
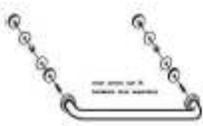
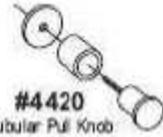
 <p>SD8045 PIVOT HINGE INSERT FOR 644</p>	 <p>#8196 SAFETY WASHER FOR 790 & 390</p>	 <p>SD8239SIL 340 HANGER BRACKETS PAIR</p>
 <p>#8241 SD8241 340/350 WALL BUMPERS SOLD 2 EA</p>	 <p>#8273 SD8273 640/650 WALL BUMPERS SOLD 2 EA</p>	 <p>#4297 Clear Vinyl Jamb Bumpers SD8319 BUMPER SET FOR 740D (PKG OF 2)</p>
 <p>SD-CLIP-90-BNKL CRL - Overclamp 90 degree</p>	 <p>SD-CLIP-90-SIL CRL - Overclamp 90 degree</p>	 <p>SDDDELAC8X8 8" BACK-TO-BACK ACRYLIC HANDLE</p>
 <p>SDDDELACTBAR18 DELUXE ACRYLIC T-BAR 18" !!!</p>	 <p>SDDL18X18TBBNK 18" B-2-B TUBULAR T-BAR BNKL</p>	 <p>SDDL4402BNKL 20" TUBULAR T-BAR BNKL</p>
 <p>SDDL4404BNKL 22" TUBULAR T-BAR BNKL</p>	 <p>SDDL4406BNKL 24" TUBULAR T-BAR BNKL</p>	 <p>SDDL4408BNKL 26" TUBULAR T-BAR BNKL</p>
 <p>SDDL4410BNKL 28" TUBULAR T-BAR BNKL</p>	 <p>SDDL4412BNKL 8" PULL/18" T-BAR COMBO BNKL</p>	 <p>#4420 Tubular Pull Knob SDDL4420BNKL PULL KNOB W/SLEEVE - BNKL</p>

To Order Call: 1-800-277-5223

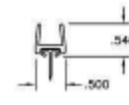
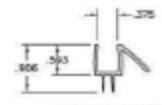
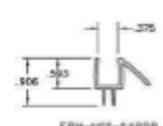
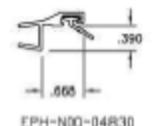
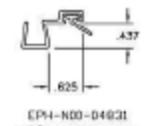
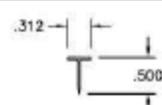
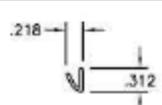
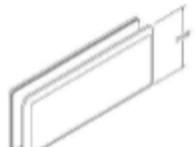
 <p>SDDL4800BNKL GLASS TO WALL HINGE BNKL FULL</p>	 <p>SDDL4801BNKL GLASS TO GLASS HINGE BNKL</p>	 <p>SDDL4802BNKL GLASS TO GLASS 135deg HINGE</p>
 <p>SDDL4804BNKL 8"BACK TO BACK C PULL BNKL</p>	 <p>SDDL4807BNKL 18"TUBULAR T-BAR BNKL</p>	 <p>SDDL4812BNKL SINGLE MOUNT KNOB - BNKL</p>
 <p>SDDL4813BNKL BACK TO BACK KNOB BNKL</p>	 <p>SDDL4828 3/8"BOTTOM WITH WIPE</p>	 <p>SDDL4829 3/8"BOTTOM WITH DRIP - 98°</p>
 <p>SDDL4829-32 3/8"BOTTOM WITH DRIP - 32°</p>	 <p>SDDL4830 180deg Polycarb. Strike Jamb</p>	 <p>SDDL4831 3/8" 90deg STRIKE JAMB</p>
 <p>SDDL4832 3/8"135deg STRIKE JAMB</p>	 <p>SDDL4833 VINYL TEE</p>	 <p>SDDL4834 ANGLE VINYL - 98°</p>
 <p>SDDL4836 3/8"X 1/2"X 2"SETTING BL</p>	 <p>SDDL4837BNKL GLASS TO WALL CLIP BNKL</p>	 <p>SDDL4838BNKL GLASS TO GLASS 180deg CLIP</p>

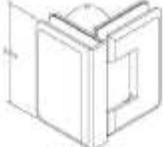
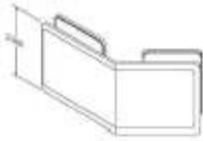
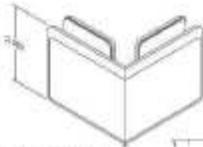
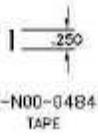
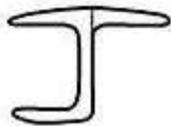
 <p>EPH-N00-04839 BULB VINYL</p> <p>SDDL4839 VINYL BULB SEAL 98"</p>	 <p>SDDL4840SIL GLASS TO GLASS 90deg HINGE SIL</p>	 <p>SDDL4841BNKL BNKL 135deg GLASS CLIP</p>
 <p>SDDL4842BNKL GLASS TO GLASS 90deg CLIP</p>	 <p>EPH-N00-04843 TAPE</p> <p>SDDL4843 VHB TAPE 24' ROLL</p>	 <p>SDDL4846BNKL HINGE TOP & BOTTOM PIVOT BNKL</p>
 <p>SDDL4848BNKL 6"BACK TO BACK C PULL BNKL</p>	 <p>SDDLBM12BNKL CRL 12' SGL TUBULAR T-BAR BNKL</p>	 <p>SDDLBM12X12BNK CRL 12" B2B TUBULAR T-BAR BNKL</p>
 <p>SDDL-SSDP6SIL CRL 6 Chrome Back To Back</p>	 <p>SDDL-TDF CLR Polycarbonate "Double fin"</p>	 <p>SDDL-Y-SEAL CLR Polycarbonate "Y" Seal</p>
 <p>SDPL4837NL-BNKL NOTCHLESS GLASS-TO- WALL CLIP</p>	 <p>SC-505 63836 Header</p> <p>SDSC-505ABNKL CURB {10}</p>	 <p>SC-505 63836 Header</p> <p>SDSC-505BNKL HEADER {10}</p>
 <p>SC-506 63857</p> <p>SDSC-506BNKL CURB FILL FOR FRAMED DR{10}</p>	 <p>SC-507</p> <p>SDSC-507BNKL CURB FILL FRAMELESS DOOR</p>	 <p>SC-508</p> <p>SDSC-508BNKL WALL JAMB {10}</p>

To Order Call: 1-800-277-5223

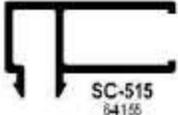
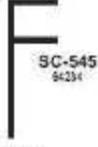
 <p>SC-511 63231</p> <p>SDSC-511BNKL BUTTRESS POST {10}</p>	 <p>SC-512 63233 135° Post</p> <p>SDSC-512BNKL 135deg POST {10}</p>	 <p>SC-513 63232 90° Post</p> <p>SDSC-513BNKL 90deg POST {10}</p>
 <p>SC-515 64155 Buttress Return Post</p> <p>SDSC-515BNKL BUTTRESS RETURN POST {10}</p>	 <p>SC-516 63239</p> <p>SDSC-516BNKL BUTTRESS CURB {10}</p>	 <p>SC-517 63239</p> <p>SDSC-517BNKL ADJUSTABLE POST MALE {10}</p>
 <p>SC-518 63240</p> <p>SDSC-518BNKL ADJUSTABLE POST FEMALE {10}</p>	 <p>SC-542 64078 3/4" Curb Fill</p> <p>SDSC-542SIL CURB ADAPTOR SIL PIVOT DR</p>	 <p>SC-543 64078 3/4" Curb Fill</p> <p>SDSC-543BNKL 3/4" CURB FILL FOR 505A</p>
 <p>SC-544 64030</p> <p>SDSC-544BNKL DOOR POST</p>	 <p>SC-545 64234</p> <p>SDSC-545BNKL IN LINE PANEL RAIL</p>	 <p>SC-549 64519 738/790 Strike Rail</p> <p>SDSC-549BNKL STRIKE RAIL W/V 253 11'9" {6}</p>
 <p>SC-551</p> <p>SDSC-551BNKL 738 STRIKE JAMB</p>	 <p>SC-552</p> <p>SDSC-552BNKL PIV JAMB/USES V266 VINYL {10}</p>	 <p>SC-556 64774 Tub Track with V-150 Vinyl</p> <p>SDSC-556BNKL 340/640 TUB TRACK 12'</p>
 <p>SC-558</p> <p>SDSC-558BNKL 338/390 TOP & BOTTOM RAIL</p>	 <p>SC-574 65814 2-PC Header</p> <p>SDSC-574BNKL 2 PC HEADER BASE BNKL</p>	 <p>SC-575 65815 2-PC Header</p> <p>SDSC-575BNKL 2 PC HEADER FACE BNKL</p>

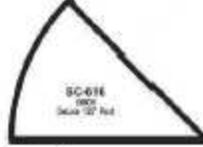
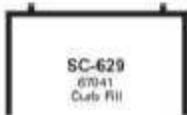
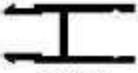
 <p>SC-582 66105 w/V-296</p> <p>SDSC-582BNKL PIVOT RAIL W/V 266 11'9" (6)</p>	 <p>SC-589</p> <p>SDSC-589BNKL DRIP RAIL</p>	 <p>SC-590 66150</p> <p>SDSC-590BNKL 1 SNAP IN FILLER (10)</p>
 <p>SC-607 66215 3381089 Curb</p> <p>SDSC-607BNKL 338 CURB BNKL 6'</p>	 <p>SC-610 66228 1090 Curb Fill</p> <p>SDSC-610BNKL CURB FILL FOR SC 646 & SC 644</p>	 <p>SC-614 66230 10' Header</p> <p>SDSC-614BNKL DELUXE HEADER 340 / 350</p>
 <p>SC-615 66235 1040/1050 Post</p> <p>SDSC-615BNKL DELUXE ENCLOSURE 90deg POST</p>	 <p>SC-616 66235 1040/1050 Post</p> <p>SDSC-616SIL DELUXE ENCLOSURE 135deg POST</p>	 <p>SC-621 66235 738/338 Post Jamb</p> <p>SDSC-621BNKL 738/338 PIVOT JAMB BNKL</p>
 <p>SC-623 67127 1040/1050 Header</p> <p>SDSC-623BNKL 1040/1050 DELUX HEADER 10' 7"</p>	 <p>SC-624 67027 740D Tub Track with V-190 Vinyl Vii Fram</p> <p>SDSC-624BNKL 740D TUB TRACK ASSEMBLY</p>	 <p>SC-625 66230 740D/1040 Wall Jamb</p> <p>SDSC-625BNKL-IS 1040/750D INSIDE WALL JAMB 84"</p>
 <p>SC-625 66230 740D/1040 Wall Jamb</p> <p>SDSC-625BNKL-OS 1040/750D OUTSIDE WALL JAMB 84</p>	 <p>SC-629 67041 Curb Fill</p> <p>SDSC-629BNKL 1" FILL BNKL 6' (740D/1050)</p>	 <p>SC-632 67312</p> <p>SDSC-632 ANTI JUMP INSERT FOR 340/350</p>
 <p>SC-633 67313 Anti-Jump Header Insert</p> <p>SDSC-633 ANTI JUMP INSERT FOR 640/650</p>	 <p>SC-636 67399</p> <p>SDSC-636SIL EURO 135deg POST SIL 12'</p>	 <p>SC-637 67324 Snap-in Post Connector</p> <p>SDSC-637 IN LINE ADAPTOR MILLFINISH (6)</p>

To Order Call: 1-800-277-5223

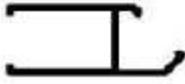
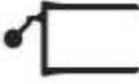
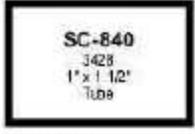
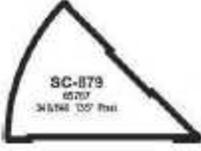
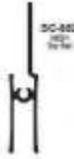
 <p>SC-644 EURO CURB 66114</p> <p>SDSC-644BNKL DESIGNLINE EURO CURB 1"</p>	 <p>SC-645 66200</p> <p>SDSC-645BNKL 135deg BUTTRESS POST</p>	 <p>SC-646 EURO HEADER 66447</p> <p>SDSC-646BNKL DESIGNLINE HEADER 1 7/16"</p>
 <p>SC-648 66191</p> <p>SDSC-648BNKL 700C HINGE RAIL BNKL</p>	 <p>SC-649 66470 Hinge Jamb</p> <p>SDSC-649BNKL 700C HINGE JAMB BNKL</p>	 <p>SC-651</p> <p>SDSC-651BNKL 390C HINGE RAIL BNKL</p>
 <p>SC-652 66070</p> <p>SDSC-652BNKL ADJUSTABLE POST FEMALE</p>	 <p>SC-653 66071</p> <p>SDSC-653BNKL ADJUSTABLE POST MALE</p>	 <p>SC-657 1/2" GLAZING CHANNEL 66858</p> <p>SDSC-657BNKL 12' U-CHANL FOR 1/2"WET GLAZ</p>
 <p>SC-658 3/8" GLAZING CHANNEL 66659</p> <p>SDSC-658BNKL 12' U-CHANL FOR 3/8"WET GLAZ</p>	 <p>SC-805 66135</p> <p>SDSC-805BNKL T-BAR BNKL 11'</p>	 <p>SC-839 3429 1" x 1" Tube</p> <p>SDSC-839BNKL 1 X 1 TUBING 12'</p>
 <p>SC-840 3428 1" x 1 1/2" Tubing</p> <p>SDSC-840BNKL 1 X 1 1/2 TUBING 12'</p>	 <p>SC-850 2590 12/12' WALL FILL</p> <p>SDSC-850BNKL 1" WALL FILL BNKL 12'(640/650)</p>	 <p>SC-878 66314 3/8\" 90' Post</p> <p>SDSC-878BNKL STALL & ENCLOSURE 90deg POST</p>
 <p>SC-879 66379 3/8\" 135' Post</p> <p>SDSC-879SIL 135deg POST</p>	 <p>SC-881 66132 640 Header</p> <p>SDSC-881BNKL 640 HEADER 10ft 10in BNKL</p>	 <p>SC-882 66315</p> <p>SDSC-882BNKL 640 TOP RAIL 14' BNKL</p>

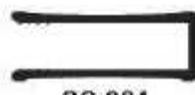
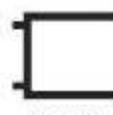
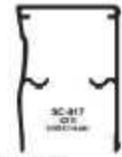
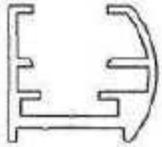
 <p>SC-883 14751 Bottom Rail</p> <p>SDSC-883BNKL 640 BOTTOM RAIL 13' 5"</p>	 <p>SC-884 14750</p> <p>SDSC-884BNKL 640 SIDE RAIL 11' 9"</p>	 <p>SC-896 1336</p> <p>SDSC-896BNKL 640/650 WALL JAMB 8' {10}</p>
 <p>SC-899 8093 738790</p> <p>SDSC-899BNKL 738 TOP/BOTTOM RAIL 11' 8"</p>	 <p>SC-900 63095</p> <p>SDSC-900BNKL 738/790 PIVOT RAIL 11' 4"</p>	 <p>SC-901 15249 1/2"</p> <p>SDSC-901BNKL 1/2 WALL FILL</p>
 <p>SC-902</p> <p>SDSC-902BNKL 1/4 WALL FILL</p>	 <p>SC-907 60103 7/8" Tub Fill</p> <p>SDSC-907BNKL CURB FILL 7/8" BNKL</p>	 <p>SC-910 60525 3/4"</p> <p>SDSC-910BNKL 3/4" WALL FILL BNKL</p>
 <p>SC-910 60525 3/4"</p> <p>SDSC-910BNKLT 3/4" WALL FILL TAPERED BNKL</p>	 <p>SC-915</p> <p>SDSC-915BNKL 738 CURB BNKL</p>	 <p>SC-917 340</p> <p>SDSC-917BNKL 340 HEADER 12' 3"</p>
 <p>SDSC-922BNKL Reversible Header - BNKL 12'</p>	 <p>SDSLEEVEBNKL T-BAR SLEEVE BNKL</p>	 <p>V-190 Vinyl Insert for Frameless Tub Track</p> <p>SDV-190D 640 / 650 TRACK INSERT 8' 1</p>
 <p>SDV-218D BLACK SETTING BLOCK</p>	 <p>V-219</p> <p>SDV-219 VINYL 1/4 by foot (500' ROLL)</p>	 <p>V-220</p> <p>SDV-220 HORZ ROLL IN 1/4 (500' ROLL)</p>

To Order Call: 1-800-277-5223

 <p>SDV-221 SETTING BLOCK HARD PLASTIC</p>	 <p>V-225 SDV-225 HORZ ROLL IN 3/16 (500' ROLL)</p>	 <p>V-226 SDV-226 VERT Roll in 3/16 (500' ROLL)</p>
 <p>V-253 Strike Magnet SDV-253B MAGNETIC VINYL STP(300' ROLL)</p>	 <p>V-257 Glazing Vinyl for 5/16" glass SDV-257 VINYL 3/16 FOR 338(400' ROLL)</p>	 <p>V-266 Jamb Vinyl Seal Vinyl SDV-266 JAMB VINYL 8' PIECE</p>
 <p>V-270 Vinyl Seal or Top Rail SDV-270 38"VINYL SEAL/STEAM DOORS</p>	 <p>V-284 Drip Vinyl SDV-284 34-3/4" TAPERED DRIP VINYL</p>	 <p>V-284 Drip Vinyl SDV-284U SOLD BY THE FOOT JAMB VINYL (1</p>
 <p>V-293 1038/1090 Bulb Vinyl SDV-293 6' 1090 JAMB SEAL</p>	 <p>V-293 1038/1090 Bulb Vinyl SDV-293-G 6' 1090 JAMB SEAL 72"</p>	 <p>#8443 V-295 1038 Door Wiper SDV-295 36 3/8"DEFLECTOR VINYL</p>
 <p>#8444 V-297 1090 Door Wiper SDV-297 DRIP RAIL VINYL FOR 1038/1090</p>	 <p>V-308 Glazing Vinyl for 1/4" glass SDV-308 VINYL 1/4 FOR 338 (400' ROLL)</p>	 <p>V-314 Strike Jamb Seal Vinyl SDV-314 338/390 JAMB VINYL 8' PIECE</p>
 <p>V-338 1090 Jamb Vinyl SDV-338 1090 JAMB SEAL</p>	 <p>V-347 Sleeve SDV-347 VINYL SLEEVE FOR SC 649 80</p>	 <p>V-351 Deflector SDV-351 DRIP FOR FRAMLESS 1/4" GLASS</p>

 <p>V-52 Glazing Vinyl for 5/32" glass</p> <p>SDV-52 VINYL 5/32"BY FT (600' ROLL)</p>	 <p>V-53 Glazing Vinyl for 3/16" glass</p> <p>SDV-53 VINYL 3/16"BY FT (600' ROLL)</p>	 <p>V-57</p> <p>SDV-57 VINYL 1/4" BY FT (600' ROLL)</p>
 <p>SD-WASHERS-BNKL Back-to-Back washer set >(4)</p>		

Remember:

If you don't see an item listed in this manual, one of our CSRs will gladly custom order it for you!

To Order Call: 1-800-277-5223

11

**YKK & Other
Metal Products**



To Order Call: 1-800-277-5223



Metal FAQs

Q Does it matter whether I will be using a single-pane or an insulated glass configuration?

A Yes. Different systems are needed depending on whether 1/4" single-pane glass or 1" insulated glass units will be used.

Q Will the color of the metal I choose change the price?

A Yes. White and Bronze metal are the same price. Silver (Clear) is a different price.

Q What is a transom?

A A doorframe with a "transom" is one that includes a frame for a window above the door.

Q What kind of pivot options are available?

A Almost all of the doors WGD carries have offset pivot frames, but we also carry center pivots (overhead concealed) and can custom order anything you need.

Q What is a "6070" or "3070" door?

A "6070" doors are double door setups that are 72" x 84" while "3070" doors are single door setups that are 36" x 84".

Q What is the difference between a high-bottom and low-bottom door?

A In "high bottom rail doors," the glass begins 8" from the bottom of the frame. North Carolina legally requires the use of high bottom rail doors in all storefront systems. "Low bottom rail doors" allow glass to extend to within 4" of the bottom of the frame. South Carolina and Georgia allow the use of low bottom rail doors in storefront systems.

Q What is a "panic" door?

A "Panic" doors have an oversized bar across the inside of the door which, when pressed against, will release the door latch and allow the door to be opened. These are available with or without a transom.

Q What type of lock will come on my door?

A Our doors come with locks that have a key on the outside and a thumb turn on the inside, but you can separately order a lock with a key on both sides.

Q What kinds of closers do you carry?

A WGD carries International surface mounted closers, Jackson-style concealed closers, and Huskey "shot gun" closers. All three of these closer types are available with or without the "hold open" feature.

Metal



YKK & Other Metal Products



Q What is “Break Metal?”

A Break Metal is a large sheet of aluminum material (48 x 120). It has finishes to match our storefront metal systems and is used to flash around window openings. The term “break” comes from the break machine that is used to neatly fold the metal to the required shape. It is used to bridge the gaps where there are unusual requirements to cover the structure and is cheaper and more versatile than buying stock length material in these odd applications under, beside, or between standard window openings.

Q What is “Panel 15?”

A Panel 15 is an insulated panel that can be glazed into our storefront systems much like a piece of glass. It is available for 1/4 systems (5/16”) and 1” systems. It has a Styrofoam, plastic, or wood core with a thin skin of aluminum on the outside. It can be ordered with one side finished or both sides finished, in colors to match our storefront metal systems. You might only want one side finished, for example, if you were using it to cover the area between floors in a building, where it will not be seen from the interior. A common application for Panel 15 with both sides finished is to put it in the bottom panels of a window system to get the glass vision panels the required 18” off the floor to meet code or to make the lower areas of the window wall less susceptible to damage from shopping carts, kids kicking it, etc. This option is cheaper than building a low wall to set the window system on top of.

Q What are “Roton Hinges?”

A Roton hinges are long piano-type hinges used on newer doors in high traffic areas or to repair old worn out doors that have broken hinges. In new applications, the door is cut down a little to allow room for the hinges to fit attractively between the door and frame (“full montise”). On existing applications where there is not space between the door and frame, roton hinges can be bolted on top of the door and frame, and come with nice covers that hide the bolts (“full surface”).

**If you have any questions not covered in this section,
please call and speak with one of our knowledgeable
customer service representatives.**





To Order Call: 1-800-277-5223



Breakmetal and Panel 15

Breakmetal (all sheets are 48 x 120)

Thickness	Color	ItemNumber
.032	Clear	BM032CL48120
.040	Black/Black	BM04BLK48120
	Black/Wash	BM04BB48120
	Bronze/White	BM04BW48120
	Clear	BM04CL48120
	Dark Bronze	BM04BS48120
	Dark Bronze/Medium Bronze	BM04BZ48120
	White/Wash	BM04WS48120
	White/White	BM04WW48120

Note: "Wash" means "Unfinished"

Metal

Panel 15 (all are textured and painted unless otherwise noted)

Color	Thickness	Size	ItemNumber
Aluminum	1"	48 x 120	P15ALUM48120 1
		48 x 96	P15ALUM4896 1
	5/16"	48 x 120	P15ALUM48120
		48 x 96	P15ALUM4896
Aluminum (smooth anodized)	1"	48 x 96	P15ALSM4896 1
	5/16"	48 x 96	P15ALSM4896
Bronze	1"	48 x 120	P15BRZ48120 1
		48 x 96	P15BRZ4896 1
		60 x 120	P15BRZ60120 1
	5/16"	48 x 120	P15BRZ48120
		48 x 96	P15BRZ4896
		60 x 120	P15BRZ60120
Dark Bronze (anodized)	1"	48 x 120	P15BZSM48120 1
White	1"	48 x 120	P15WHT48120 1
		48 x 96	P15WHT4896 1
		48 x 96	P15WHT4896
White (painted smooth)	5/16"	48 x 96	P15WHTSM4896





Offset Pivot Sets



Door Brand	Color	Side	Part Number
Arch/Vista	Aluminum	Left	PIVOTS-1110L-AL
		Right	PIVOTS-1110R-AL
	Bronze	Left	PIVOTS-1110L-DU
		Right	PIVOTS-1110R-DU
Amarlite	Aluminum	Left	PIVOTS-1112L-AL
		Right	PIVOTS-1112R-AL
	Bronze	Left	PIVOTS-1112L-DU
		Right	PIVOTS-1112R-DU
US Aluminum	Aluminum	Left	PIVOTS-1114L-AL
		Right	PIVOTS-1114R-AL
	Bronze	Left	PIVOTS-1114L-DU
		Right	PIVOTS-1114R-DU
Kawneer	Aluminum	Left	PIVOTS-1118L-AL
		Right	PIVOTS-1118R-AL
	Bronze	Left	PIVOTS-1118L-DU
		Right	PIVOTS-1118R-DU
YKK	Aluminum	Left	PIVOTS-1300L-AL
		Right	PIVOTS-1300R-AL
	Bronze	Left	PIVOTS-1300L-DU
		Right	PIVOTS-1300R-DU

Metal

Other Storefront Metal Parts

The remainder of this section contains diagrams, part numbers, and descriptions of our most commonly requested storefront metal items. You can use the part numbers listed here to order these parts online at www.wholesaleglassdist.com.

If you don't find something you need, just call WGD and one of our customer service representatives will be happy to custom order it for you.





To Order Call: 1-800-277-5223



Metal

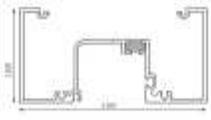
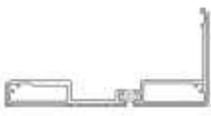
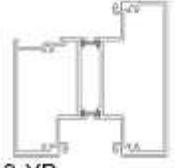
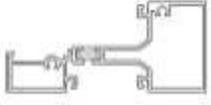
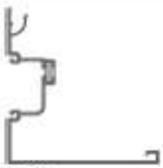

 BE9-0655-YB YHS 50 TU - Shallow Pocket Fil	 BE9-0681-YB YHS 50 TU - Head / Vertical >	 BE9-0682-YB YHS 50 TU - Sill >24' SL - th
 BE9-0687-YB YHS 50 TU - Sill Flashing >24	 BE9-1513-YB 24' THRM SIDELT BSE 2X4 1/2 BZ	 BE9-2551-YB 24' THERMAL JAMB 2X 4 1/2 BRZ
 BE9-2552-YB 24'THERM POCKET FIL 2X4 1/2BRZ	 BE9-2553-YB 24' THERMAL HEAD 2X 4 1/2 BRZ	 BE9-2556-YB 24' THERMAL HORZ 2X 4 1/2 BRZ
 BE9-2559-YB Deep pocket fill 24' BRONZE	 BE9-2560-YB 24' THERM FLASHING 2X4 1/2 BRZ	 BE9-2561-YB 2x4 1/2 THERM HD VERTICAL 24'
 BE9-2562-YB 24' THERM HEAD REC 2X4 1/2 BRZ	 BE9-2564-YB 2x4- 1/2 Female THERM Expansion	 BE9-2565-YB 2x4-1/2 Male THERM Expansion M
 BE9-2566-YB 90° corner mullion 24' BRONZE	 BE9-2567-YB 90° corner mullion 24' BRONZE	 BE9-2569-YB 135° corner mullion 24' BRONZE

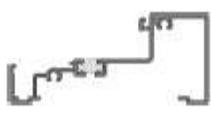
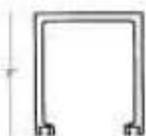
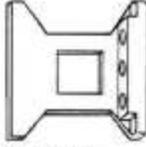
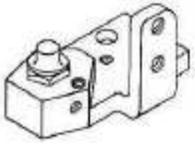
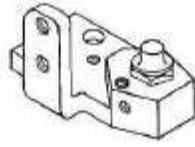
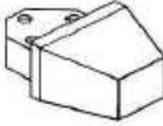
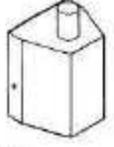
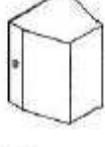
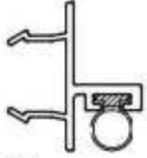
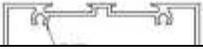
 <p>BE9-2578-YB YES45TU - Sill Flashing 24' ></p>	 <p>BE9-2579-YB E9-2554 / YES45TU SILL BRZ</p>	 <p>DIVBARBACK-YB DIVISIONBAR BACK BRZ 24' DB174</p>
 <p>DIVBARFACE-YB DIVISION BAR FACE BRZ 24' DB1</p>	 <p>DOGGING KIT Dogging Kit - Dor-O-Matic CVR</p>	 <p>GUIDES FLUSH B FLUSHBOLT FLIP TYPE GUIDE ONLY</p>
 <p>TL-P 695 L-C2 Tubelite - O.P. LH Bottom Fram</p>	 <p>TL-P 695 R-C2 Tubelite - O.P. RH Bottom Fram</p>	 <p>TL-P 695A-C2 Tubelite - O.P. Top Frame port</p>
 <p>TL-P 695B-C2 Tubelite - O.P. Top Door porti</p>	 <p>TL-P 695C-C2 Tubelite - O.P. Bottom Door po</p>	 <p>USALUM-W510 US Aluminum - Astrigal Fel'Vi</p>
 <p>YAS-0401-YB 3 pc. DOOR STOP - BRZ 24' ></p>	 <p>YAS-0402-YW 1 3/4" x 4 1/2" Door Header W</p>	 <p>YAS-0417-YB SNAP IN DOOR STOP 4 1/2" SYSTEM</p>
 <p>YAS-0421-YB 1 3/4" x 4 1/2" Door Jamb >Br</p>		 <p>YAS-0457-YB SNAP IN DOOR STOP 4" SYSTEM</p>

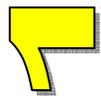

To Order Call: 1-800-277-5223

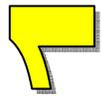

1 Metal

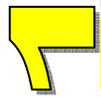
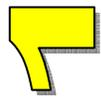

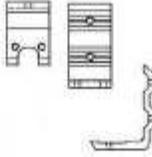
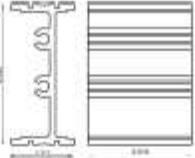
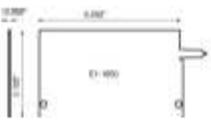
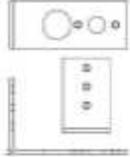
 <p>YAS-1216 PRESSURE PLATE</p>		
	 <p>YE1-0167 END DAMS FOR E9-1030 (20 PCS)</p>	 <p>YE1-0168 END DAM FOR BE9-2560 (20 PCS)</p>
 <p>YE1-0199 END DAMS- for E9-1068 (20)</p>	 <p>YE1-0307 FLUSH-THRESHOLD CLIP</p>	 <p>YE1-0317 YES45FS/FI - Head Shear Block</p>
 <p>YE1-0326 YES40FS/FI - Head Shear Block</p>	 <p>YE1-1011 SHEAR BLOCK E9-1034 SL BASE</p>	 <p>YE1-1012 YES45FS - Standard Shear Block</p>
 <p>YE1-1013 YES45FI - Standard Shear Block</p>		
 <p>YE1-1050 YHS 50 TU - End Dams</p>	 <p>YE1-1054 YES 45 FS/FI - Flat Filler *</p>	 <p>YE1-1055 Threshold Clip</p>

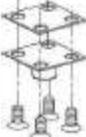
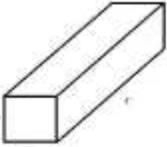
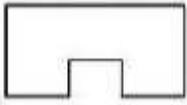
	 <p>YE1-1060 YHS 50 TU - 11' Flat Filler</p>	
 <p>YE1-1068 YHS50 ANCHOR PLATE JAMBS 20 B</p>	 <p>YE1-1070 YHS50 END DAM SUB-SILL 20 BAG</p>	 <p>YE1-1071 ANCHOR HEAD/SILL BAG OF 20 SOL</p>
 <p>YE1-1072 YHS50 SPLICE SUB-SILL 20 BAG S</p>	 <p>YE1-1073 ANCHOR PLATE YHS 50 20 BAG SO</p>	
		 <p>YE1-35140-YB BRZ PANIC STRIKES</p>
 <p>YE2-0019 SETTING BLOCK - 1/4'-BAG OF 50</p>	 <p>YE2-0020 SET BLOCKS FOR 1' BAG 50</p>	 <p>YE2-0047 WATER DEFLECTOR (BAG OF 50) 1'</p>

11 Metal 11

To Order Call: 1-800-277-5223

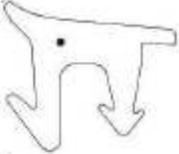
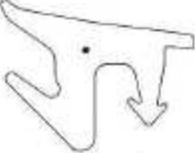
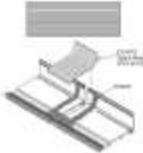
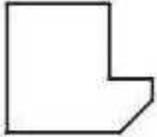
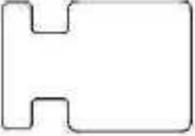
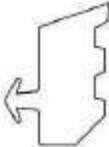
 <p>YE2-0049 WATER DEFLECTOR FOR 1 5/16"</p>	 <p>YE2-0050 VINYL FOR DOOR GLASS STOPS</p>	 <p>YE2-0051 BY FT. BLACK EPDM VINYL BULB</p>
 <p>YE2-0052 YKK EPDM VINYL (500ft PER BOX)</p>	 <p>YE2-0053 GLAZING GASKET FOR 3/8" GLASS</p>	 <p>YE2-0055 SETTING BLOCKS FOR 1" SASH</p>
 <p>YE2-0064 BLK VINYL FOR 1/2" GLS (@) 500</p>	 <p>YE2-0070 SPLIC NEW SUB SILL YES 45&50</p>	 <p>YE2-0080 YHS 50 SETTING BLOCK 50/bag</p>
 <p>YE2-0083 YHS50 - Exterior Glazing Gaske</p>	 <p>YE2-0084 YHS50 - Interior Glazing Space</p>	 <p>YE2-0087 7" SEAL BETWEEN PAIRS OF DOORS</p>
 <p>YE2-0088 INT.GLAZING FOR YHS50 SYS EACH</p>	 <p>YE2-0095 SET BLOCK HURRICANE IG BAG 50</p>	 <p>YE2-0096 HURRICANE SIDE BLOCK 50 BAG SO</p>
 <p>YE2-0101 YCW-750 "OLD" EXTERIOR GASKET</p>		

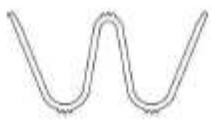
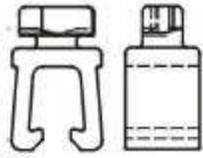
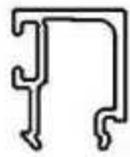
 <p>YE2-0153 W SIDE BLOCK (BAG OF 50)</p>		
 <p>YE3-0040 YCW700 - Thermal Isolator Clip</p>		 <p>YE3-0015 Thermal Glazing Clip >100 per</p>
 <p>YE9-0314-YB BRZ 1/4' GLS STOP FOR DOOR 18'</p>	 <p>YE9-0317-YB 24' 8" BOTTOM DOOR RAIL BRONZE</p>	 <p>YE9-0306-YB 24' 4" BOTTOM DOOR RAIL BRONZE</p>
 <p>YE9-0322-YB BRZ 1" GLASS STOP FOR DOOR 18'</p>		

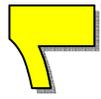

To Order Call: 1-800-277-5223

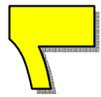

Metal

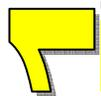
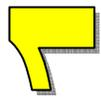

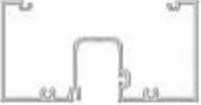
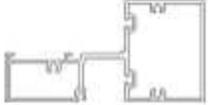
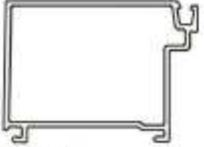
 YE9-0332-YB 7' ASTRIGAL - ADJUSTABLE END	 YE9-0403-YB TRANSOM GLASS STOP 1/4'	 YE9-0407 4" MILL THRESHOLD 24' LONG
 YE9-0408-YB BRONZE SASH BASE	 YE9-0410-YB 24' TUBE 1 3/4 X 4 1/2 BRZ	 YE9-0413-YB TRANSOM GLASS STOP FOR 1'
 YE9-0434-YB TRANSOM GLAZING POCKET 1/4' BRZ	 YE9-0435-YB TRANSOM SLIDE IN POCKET 1'	 YE9-0445 7 THR 7" MILL THRESHOLD 24' LONG
 YE9-0601-YB BRZ 2 1/2" X 5' HEADER	 YE9-0603-YB BRZ 2 1/2" X 5' HORIZONTAL	 YE9-0604-YB BRZ 2 1/2" X 5' JAMB
 YE9-0605-YB Bronze 2 1/2" X 5' Vertical	 YE9-0606-YB BRZ 2 1/2" X 5' DEEP PKT FILL	 YE9-0608-YB BRZ 2 1/2" X 5' GLASS STOP
 YE9-0615-YB BRZ 2 1/2" X 5' SILL	 YE9-0616-YB BRZ 2 1/2" X 5' SILL FLASHING	 YE9-0617-YB BRZ 2 1/2" X 5' POCKET FILLER

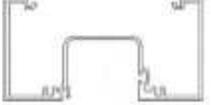
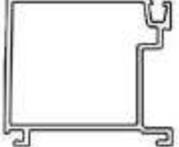
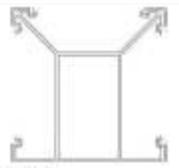
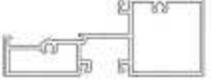
 <p>YE9-0619-YB YHS 50 - Sill Flashing 24' BRZ</p>	 <p>YE9-0651-YB BRZ 2 1/2 X 5 HEAD FOR 1 5/16</p>	 <p>YE9-0652-YB BRZ 2 1/2 X 5 SILL FOR 1 5/16</p>
 <p>YE9-0653-YB BRZ 2 1/2 X 5 HORZ FOR 1 5/16</p>	 <p>YE9-0654-YB BRZ 2 1/2 X 5 VERT FOR 1 5/16</p>	 <p>YE9-0655-YB SHALLOW POCKET FILLER HURRICAN</p>
 <p>YE9-0656-YB BRZ DEEP POCKET HURRICANE</p>	 <p>YE9-0657-YB BRZ FLAT FILLER HURRICANE</p>	 <p>YE9-0658-YB SILL GLASS STOP FOR YHS-50FI</p>
 <p>YE9-0659-YB BRZ 5' X 5' CORNER</p>	 <p>YE9-1001-YB BRZ 1 3/4 X 4 1/2 JAMB 24'</p>	 <p>YE9-1002-YB BRZ POCKETED FILLER FOR 1/4' (</p>
 <p>YE9-1003-YB BRZ 1 3/4 X 4 1/2 HEAD 24'</p>	 <p>YE9-1005-YB STOP 1 7/8' X 1 1/16'</p>	 <p>YE9-1006-YB BRZ. HORZ. 1 3/4 X 4 1/2 24'</p>
 <p>YE9-1009-YB BRZ. 1 3/4 X 4 POCKET FILL 24'</p>	 <p>YE9-1010-YB BRZ FLAT FILLER 1/4' POCKET</p>	 <p>YE9-1011-YB BRZ. 2 X 4 1/2 JAMB VERT 24'</p>



To Order Call: 1-800-277-5223

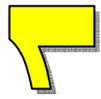

Metal

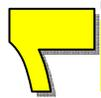
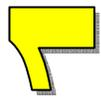

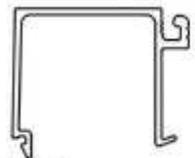
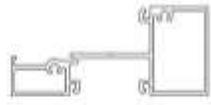
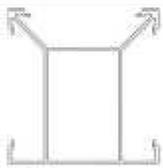
 YE9-1012-YB BRZ. 2 X 4 1/2' POCKET FILL 24'	 YE9-1013-YB 24' HEAD 2 X 4 1/2' BRZ	 YE9-1014-YB *** USE YE9-1089 *****
 YE9-1015-YB STOP 1 1/2' X 1 5/16"	 YE9-1016-YB BRZ HORIZONTAL 2 X 4 1/2' 24'	 YE9-1017-YB YES45FI -Hinged Mullion Female
 YE9-1018-YB YES45FI - Hinged Mullion Male	 YE9-1019-YB BRZ. 1' DEEP POCKET FILL 24'	 YE9-1020-YB BRZ. SMALL 1'POCKET FILLER 24'
 YE9-1021-YB 24' 90 DEG. 4 1/2'CORNER BRZ	 YE9-1022-YB ALUM 3 WAY CORNER POST 4 1/2'	 YE9-1023-YB 24' SIDELIGHT BASE BRZ 4'TALL
 YE9-1028-YB BRONZE FLEX CORNER 1/4' JAMB	 YE9-1029-YB FLEXIBLE MULLION UNEVEN BRZ	 YE9-1030-YB BRZ SILL FLASH 24' /old style
 YE9-1032-YB BRZ HEAD RECPTOR 5" BACK 24'	 YE9-1033-YB BRZ HEAD RECPTOR STOP	 YE9-1034-YB BRZ HIGH S LITE BASE 7 1/2"

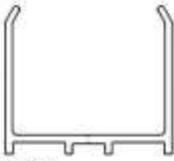
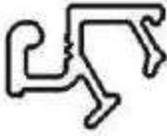
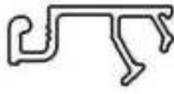
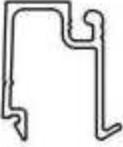
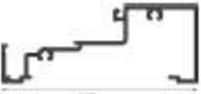
 <p>YE9-1035-YB BRZ HIGH S.LITE BASE SHOE</p>	 <p>YE9-1037-YB 24' 135 DEG POST</p>	 <p>YE9-1038-YB BRZ. FLAT FILLER</p>
 <p>YE9-1039-YB 24' 5/8" ADAPTOR</p>	 <p>YE9-1040-YB 24' 1/4" ADAPTOR BRONZE</p>	 <p>YE9-1044-YB BRZ. 4 1/2" CORNER POST 24'</p>
 <p>YE9-1045-YB BRZ. 4 1/2" CORNER POST 24'</p>	 <p>YE9-1046-YB BRZ 90 DEG CORNER POST 4 1/2"</p>	 <p>YE9-1047-YB 24' ONE POCKET CORNER POST 1'</p>
 <p>YE9-1048-YB 24' ONE POCKET CORNER POST 1'</p>	 <p>YE9-1049-YB 24' 90 DEG CORNER POST 1" GLASS</p>	 <p>YE9-1050-YB PLAIN CORNER POST HALF 4 1/2"</p>
 <p>YE9-1052-YB BRZ GLS STOP FOR HIGH BASE 1/4"</p>	 <p>YE9-1053-YB BRZ GLS STOP FOR HIGH BASE 1"</p>	 <p>YE9-1068-YB *NEW* BRZ. SILL FLASHING 24'</p>
 <p>YE9-1069-YB E9-1004 BRZ SILL 1 3/4 X 4 1/2"</p>	 <p>YE9-1082-YB 4 1/2" x 4 1/2" Horizontal Sil</p>	 <p>YE9-1089-YB NEW BRZ SILL 2 X 4 1/2"</p>

To Order Call: 1-800-277-5223

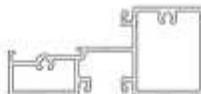
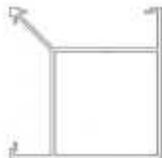
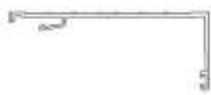
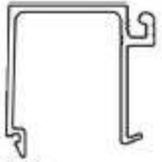
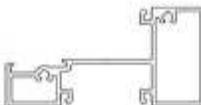
 <p>YE9-1117-YB BRONZE FLEX CORNER ROUND POST</p>	 <p>YE9-1206-YB YCW 750 - Std. Face Cover >2</p>	
 <p>YE9-1301-YB BRZ. 1 3/4 X 4 JAMB/VERT. 24'</p>	 <p>YE9-1303-YB BRZ. FINISH 1 3/4 X 4 HEAD 24'</p>	 <p>YE9-1304-YB BRZ. FINISH 1 3/4 X 4 SILL 24'</p>
 <p>YE9-1305-YB STOP 1 5/8' X 1 1/16"</p>	 <p>YE9-1306-YB BRZ. FINISH 1 3/4 X 4 HORZ 24'</p>	 <p>YE9-1309-YB BRZ.90 DEG. CORNER POST 4" 24'</p>
 <p>YE9-1310-YB BZ HEAD RECP 4 1/2"BACK FOR 4'</p>	 <p>YE9-1313-YB 24' HEAD 2 X 4 BRZ</p>	 <p>YE9-1314-YB BRZ SILL 2 X 4 24'</p>
 <p>YE9-1315-YB GLASS STOP FOR 2 X 4 BRZ</p>	 <p>YE9-1316-YB BRZ 2 X 4 I. HORIZONTAL 24'</p>	 <p>YE9-1321-YB BRZ. 4' 90 DEG. 1/2 POST 24'</p>

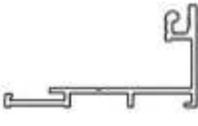
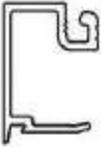
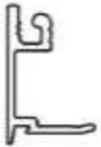
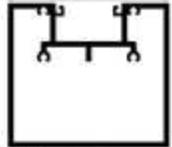
 YE9-1322-YB BRZ. 4" 90 DEG. 1/2 POST 24'	 YE9-1323-YB BRZ. 4" 90 DEG. 1/2 POST 24'	 YE9-1324-YB BRZ. 4" 90 DEG. 1/2 POST PLAIN
 YE9-1355-YB SASH BACK ONLY FOR 1/4'	 YE9-1356-YB SASH BACK ONLY FOR 1'	 YE9-1357-YB SASH FACE/STOP ONLY FOR 1/4'
 YE9-1358-YB SASH FACE/STOP ONLY FOR 1'		
		 YE9-8695-YB YES45 - 4" x 4 1/2" Header >2
 YE9-9301-YB 1" X 1 1/2" ANGLE 24 FT BRONZE	 YE9-9302-YB 1" X 1" ANGLE 1/8" 24 FEET BRZ	 YE9-9303-YB ANGLES & CHANELS-1 1/2 X 1 1/2

11 Metal 11

To Order Call: 1-800-277-5223

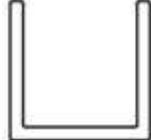
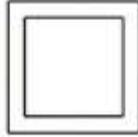
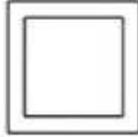
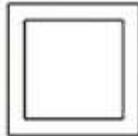
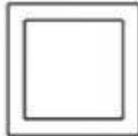
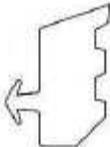
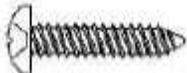
 <p>YE9-9304-YB-1/8 2' x 2' ANGLE 1/8" BRONZE 24'</p>	 <p>YE9-9311-YB TUBES- 1 3/4 X 4 X .125 BRZ</p>	 <p>YE9-9312-YB TUBING 2 X 4 1/2</p>
 <p>YE9-9313-YB BRONZE 2" X 2" TUBE 24'</p>	 <p>YE9-9321-YB 3/4 X 1/2 X 3/4 BRZ CHANNEL</p>	 <p>YE9-9322-YB 1" X 1" U-CHANNEL BRONZE</p>
 <p>YE9-9323-MILL 1 1/2 X 1 1/2 U CHANNEL MILL F</p>	 <p>YE9-9338-YB 1" x 1" Vertical Grid 24'</p>	 <p>YE9-9339-YB 1" Flush Filler 24'</p>
 <p>YE9-9342-YB TUBES-1 3/4 X 1 3/4 X BRONZE</p>	 <p>YE9-9344-YB 1" X 1" BRONZE TUBE 24 FEET</p>	 <p>YE9-9349-YB 1" x 1" Horizontal Grid 24'</p>
 <p>YE9-9401-MILL BRAKE METAL CLIP 24 FEET</p>	 <p>YES-0101 RUBBER VINYL</p>	<p>#10 x 1/2" FHMS TYPE AB (YFC-1008)</p>  <p>YFC-1008 YKK - Screw / Fastener >to at</p>
 <p>YFC-1212 YCW - Exposed Fastener</p>	 <p>YFC-1220 YCW - Concealed Fastener</p>	 <p>YFC-1410 YCW - Fastener</p>

YKK & Other Metal Products

	<p>YH-2105-YB BZ YKK OFFSET PIVOT TOP (FRAME)</p>	<p>YH-2106-YB BZ YKK OFFSET PIVOT TOP (DOOR)</p>
<p>YH-2107-YB BZ YKK OFFSET PIVOT BOT. (DOOR)</p>	<p>YH-2109-YB BZ YKK PIVOT BOT. (FRAME) RH</p>	<p>YH-2110-YB BZ YKK PIVOT BOT. (FRAME) LH</p>
<p>YH-2201-YB HING-INTERMEDIATE PIVOT RH BR</p>	<p>YH-2202-YB HING-INTERMEDIATE PIVOT LH BR</p>	<p>YH-2301-HD-YB HING-BUTT HINGES 4.5' X 4.5' B</p>
<p>YH-2301-YB BUTT HINGE BRZ</p>	<p>YH-2302-YB HING-BUTT HINGES EACH NRP</p>	<p>YH-2304 BUTT HINGE BACK UP PLATES</p>
<p>YH-2501 BOTTOM CENTER PIVOT SET > dual</p>	<p>YH-2501-FLOOR ADJ FLOOR MOUNT C.P. PIVOT SET</p>	<p>YH-2501-TH ADJ TH MOUNT CENTER PIVOT SET</p>
<p>YH-2501-YKK YKK - Bottom Center Pivot Set</p>	<p>YH-3301BLANK-YB USE TO BLANK OUT LOCK HOLE</p>	<p>YH-3301-RH-YB RH DEADLOCK/HOOKTYPE FACE PLAT</p>

To Order Call: 1-800-277-5223

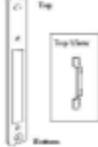
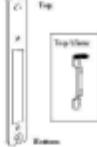
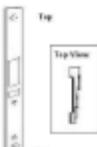
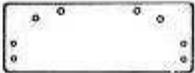
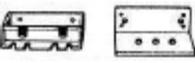
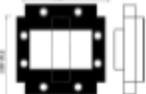
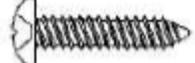
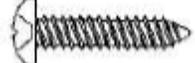
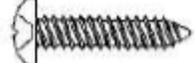
 <p>YH-3301-YB DBL RADIUS HOOKTYPE LOCK FACE</p>	 <p>YH-3301-YB-FELT DBL RADIUS HOOKTYPE FACE PLATE</p>	 <p>YH-3302-LH-YB LH BEVELED DEADLOCK/HOOKTYPE L</p>
 <p>YH-3303-YB ADAMS RITE LATCH LOCK FACE RH</p>	 <p>YH-3303-YB-FELT RADIUS ADAMS RITE LATCH LOCK F</p>	 <p>YH-3304-YB ADAMS RITE LATCH LOCK FACE LH</p>
 <p>YH-6001-XL-YB BZ SURFACE DROP PL 9" ON CNTR</p>	 <p>YH-6001-YB DROP PLATE BRZ FOR 8 3/16" OC</p>	 <p>YH-6002-END END LOAD ARM OHCC - 5/8" (YKK)</p>
 <p>YH-6002-END-7/8 END LOAD ARM OHCC - 7/8"</p>	 <p>YH-6002-SL SIDE LOAD ARM OHCC</p>	 <p>YH-6003-YB OHCC OFFSET ARM PKG w/SLIDE ></p>
 <p>YH-6005 CLIPS FOR CONCEALED CLOSER</p>	 <p>YH-6102-DU-ARM HOLD OPEN * ARM ONLY* BRONZE</p>	 <p>YH-7201 DRILL FIXTURE 2 X 4 1/2" SYSTEM</p>
 <p>YHD-2516-W3 YCW - Pressure Plate Screw</p>	 <p>YHF-2510-W1 YCW - Std. Shear Block Screw</p>	 <p>YHF-2512-W1 100 SCREWS IN A BAG >Screws</p>

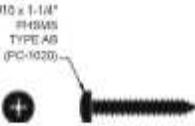

 <p>YHM-2516-W3 YHC 300 - Pressure Plate Screw</p>	 <p>#10 x 1-1/4" PHSMB TYPE AB (PC-1020)</p> <p>YPC-1020 SILL FLASHING SCREWS >#10 x 1</p>	 <p>#12 x 5/8" PHSMB TYPE AB (PC-1210)</p> <p>YPC-1210 SCREW - for E1-1013 Shear Bloc</p>
<p>YPC-1216 100 SCREWS IN A BAG #12 X 1"</p>	 <p>#12 x 1-1/4" PHSMB TYPE AB (PC-1220)</p> <p>YPC-1220 100 SCREWS IN BOX #12 X 1 1/4"</p>	 <p>#12 x 1-3/4" PHSMB TYPE AB (PC-1228)</p> <p>YPC-1228 100 SCREWS IN BAG #12 X 1 3/4"</p>
 <p>#12 x 1-1/2" PHSMB TYPE AB (PC-1424)</p> <p>YPC-1424 YKK - Screw / Fastener >for</p>	 <p>#10-24 x 1/2" PHMS (PM-1008)</p> <p>YPM-1008-SS SCREW - for E1-0199 End Dam >#</p>	

Metal

Remember:
If you don't see the storefront materials you're looking for listed in this manual, one of our CSRs will gladly custom order it for you!



To Order Call: 1-800-277-5223

12

**Custom Items
& Fabrication
Services**

Custom Items & Fabrication Services

This chapter consists of the following subsections:

<u>Cut Size</u>	<u>12.1</u>
<u>Insulated Glass Units (IGs)</u>	<u>12.2</u>
<u>Tempering</u>	<u>12.3</u>
<u>Edgework & Other Fab Work</u>	<u>12.4</u>
<u>Standard Shapes</u>	<u>12.5</u>

12.1 Cut Size

Wholesale Glass Distributors will cut glass to size for you, usually with same-day or next-day turn-around.

Tip: For directionally patterned glass, the pattern will run vertically with the dimensions you provide assumed to be width by height. For example, if you ordered “cut-size reeded glass 22 x 64,” it would look like this:

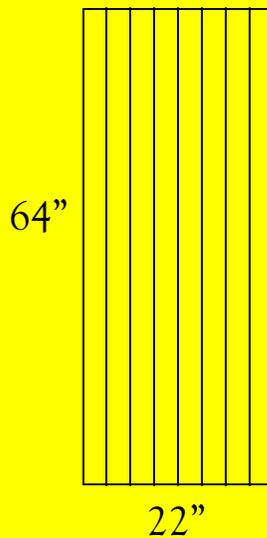

Non-rectangular Shapes

When ordering a non-rectangular shape of any cut glass, whether annealed cut-size, monolithic tempered, or insulated glass units, you can either provide a pattern, draw a detailed diagram, or simply identify one of our standard shapes (see section 12.5 at the end of this manual) and provide us with the measurements asked for.

12.2 Insulated Glass Units (IGs)

Important Information About IGs

- WGD has some of the fastest lead times in the industry. Most IGs will be completed and delivered in just one or two days.
 - WGD guarantees the quality of its IGs for 10 years when they are ordered within standard specifications and properly installed. Please see your local CSR or sales rep for more details on our IG warranty.
 - Dimensions should always be listed width first, then height (or, in the case of trapezoids and right-angle triangles: base, then left, then right). Muntin configurations should always be listed horizontal first, then vertical. All measurements should be “outside looking in.”
 - WGD will use what it believes to be the best glass thickness for the size of your unit unless you specify otherwise. Your CSR will let you know if the glass thickness you have requested is likely to cause any problems for your unit or affect your warranty (see chart on next page).
 - Gray spacer is used by default. Black spacer is available upon request for a nominal charge in 1/4”, 3/8”, 1/2”, 3/4”, and 5/8” thicknesses.
 - We carry white, bronze, and almond muntins in 5/8” and 13/16” widths, as well as 1/4” white contoured muntins. There must be at least 1/4” of air space in a unit for muntins to fit inside without touching the glass (see information on next page).
- New Part!** WGD now offers SDL division-bar style muntins!
- WGD is proud to offer argon gas, which can greatly enhance the energy efficiency of any IG unit.

12.2 Insulated Glass Units (IGs)

Glass Thickness Limitations

The following chart outlines the maximum square footage recommended for each glass thickness that can be used in an IG unit. Units that do not fall within these specifications can be made at your request, but will not be covered under our warranty.

Glass Thickness	Maximum Square Footage
3/32" (SSB)	12 (If any dimension exceeds 34" the other dimension cannot exceed 34")
1/8" (DSB)	20 (not to exceed 46" x 46")
3/16"	35 (not to exceed 65" x 65")
1/4"	45 (not to exceed 72" x 72")

Air Space Limitations

For tempered IG units, the following additional limitations apply to prevent glass from touching in the middle:

- Any unit 36" x 36" or larger must have at least 3/8" air space
- Any unit 48" x 48" or larger must have at least 1/2" air space

The following configurations do not have a wide enough air space to allow for muntins to be placed inside. In order to accommodate muntins, the unit will either need to be made thicker overall, or with thinner glass:

- 3/8" IGs
- 7/16" IGs with 1/8" glass
- 9/16" IGs with 3/16" glass
- 11/16" IGs with 1/4" glass

To Order Call: 1-800-277-5223

12.3 Tempering

WGD's 30,000 square foot manufacturing facility in Mauldin, SC, houses a glass tempering furnace.



This allows WGD to precision cut, seam, and temper most glass within 24 hours of order placement. This also reduces lead time for our tempered IGs, which are fabricated in the same facility.

To place an order for tempered glass, or if you have questions regarding whether a certain glass pattern or thickness can be tempered, please contact one of our Customer Service Representatives.

12.4 Edgework & Other Fab Work



WGD's manufacturing facility contains a variety of machinery that can seam, polish, bevel, and miter glass.

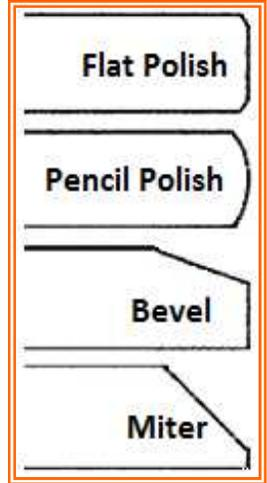

Our state-of-the-art CNC machine allows us to quickly fab even the most complicated custom heavy shower doors with precision.



WGD also has the ability to drill holes, cut notches and cut-outs, cut to patterns (by hand or with the use of automated machinery that can sense the edges of a pattern and exactly reproduce it in glass).

Please contact a customer service representative for pricing or to place an order.

12.5 Standard Shapes

The following shapes may be ordered by referencing the shape number (see number in the corner of each box) and providing the information indicated.

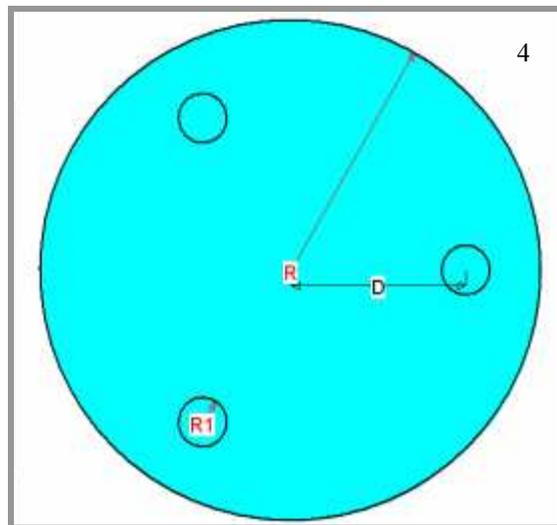
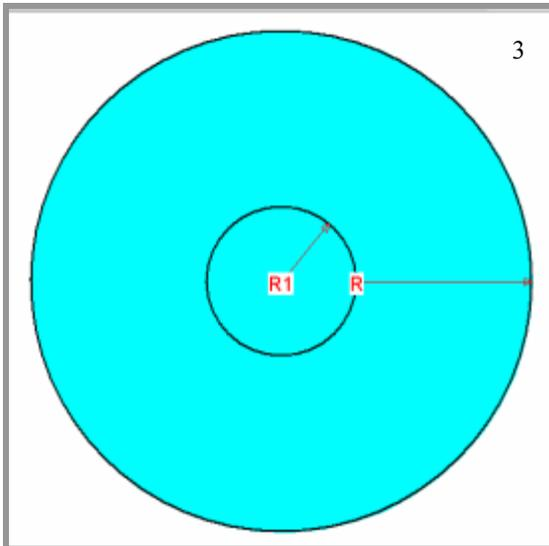
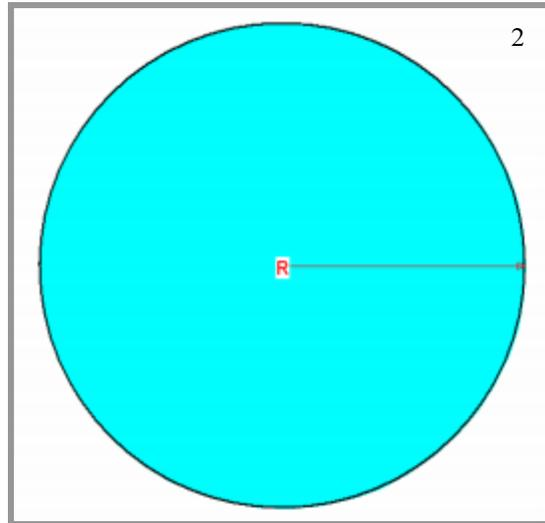
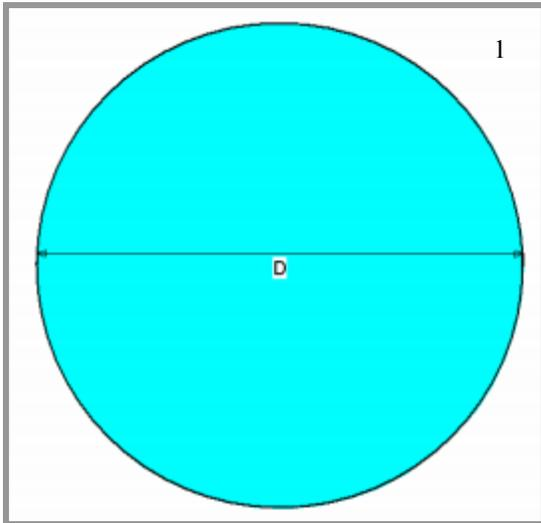

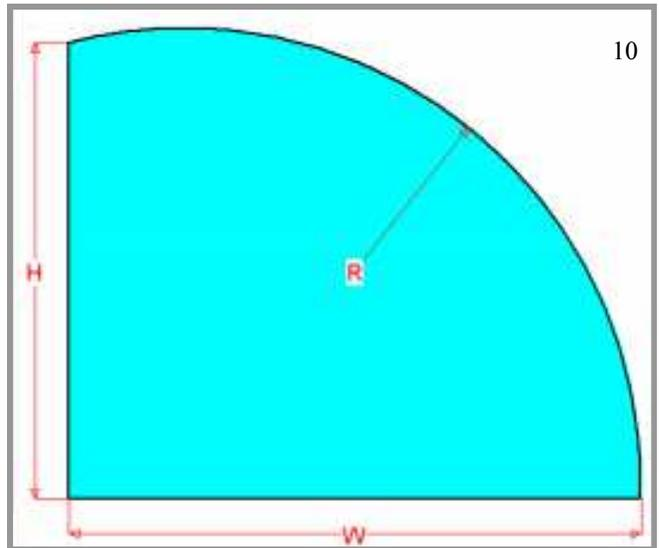
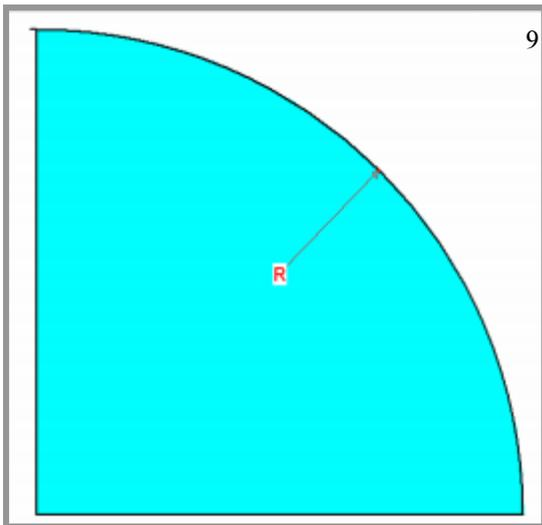
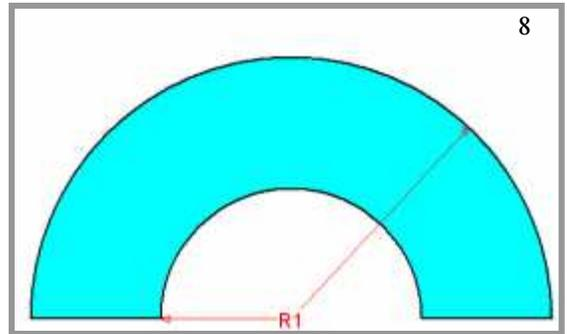
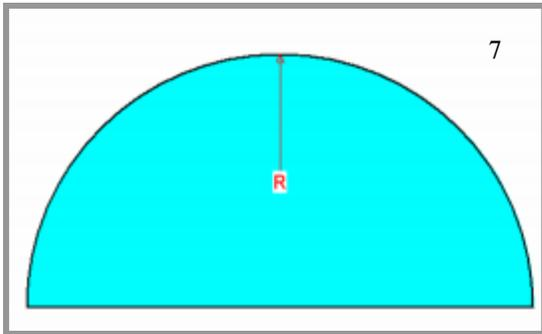
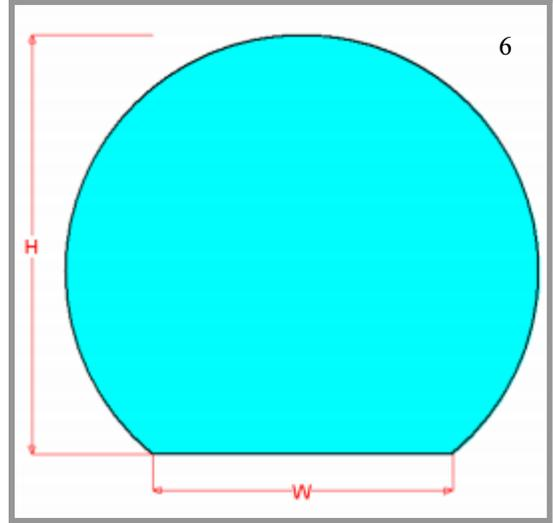
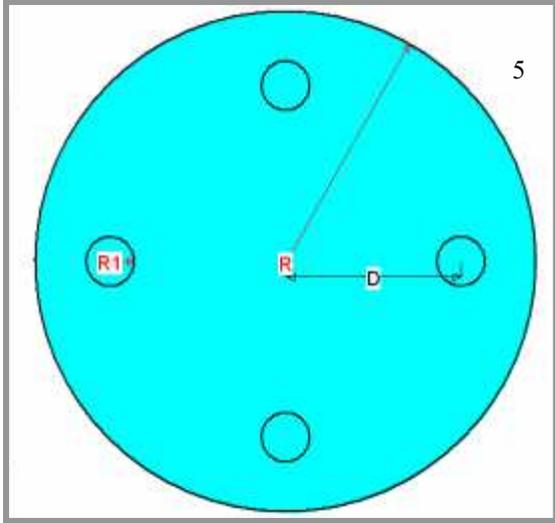

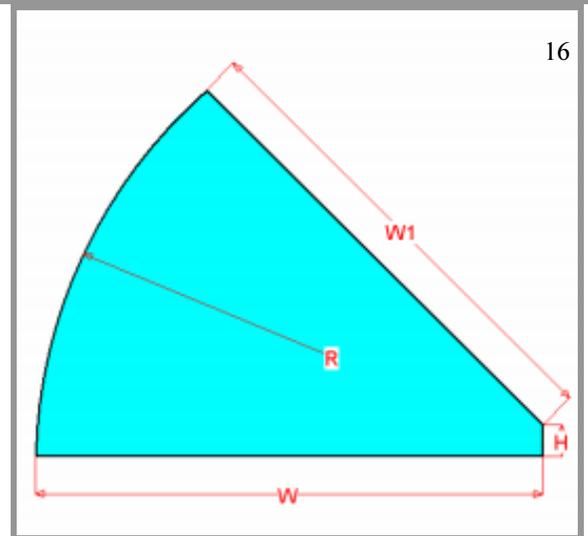
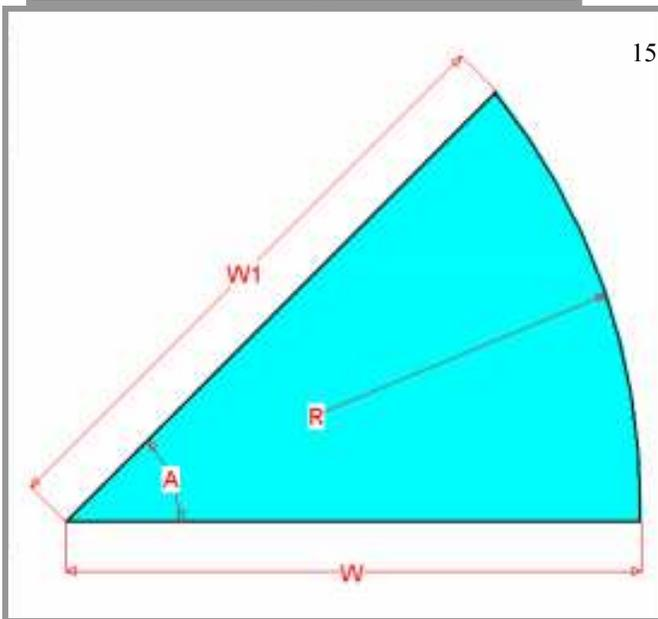
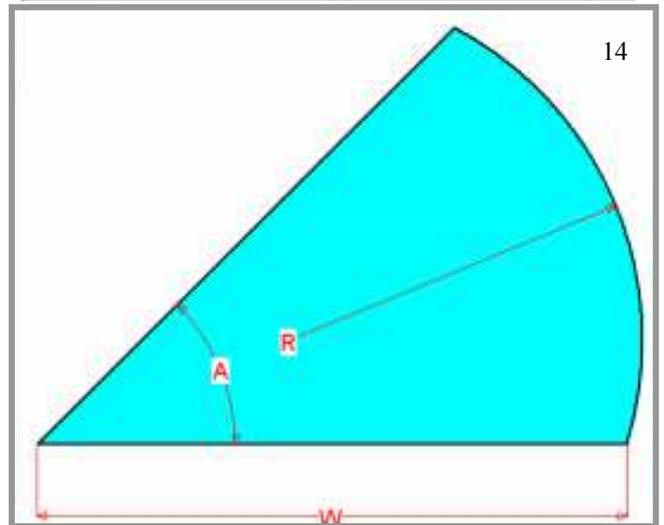
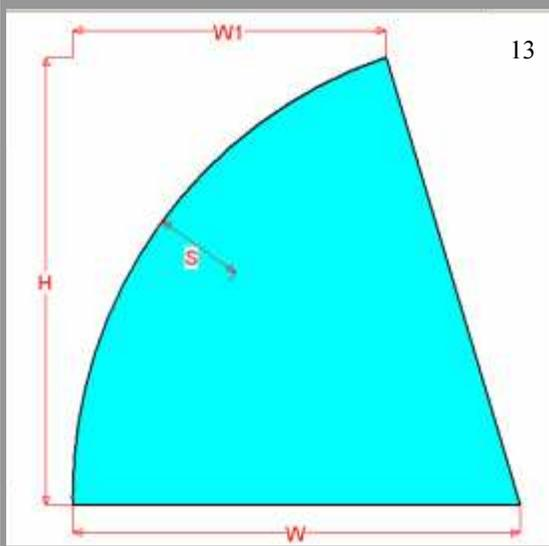
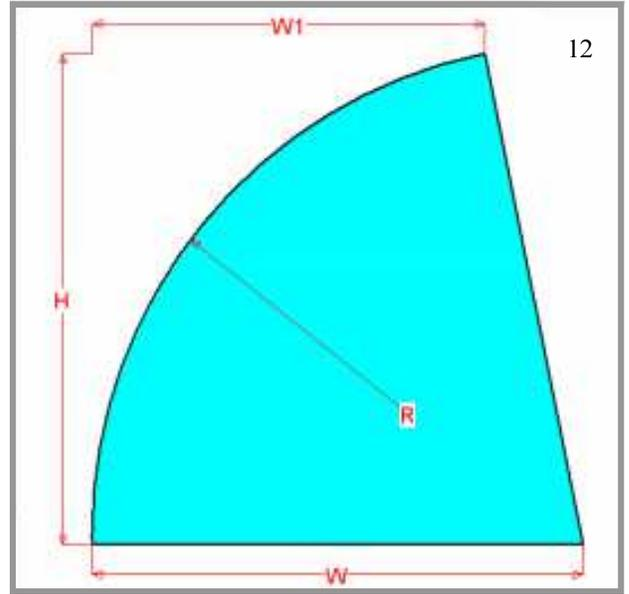
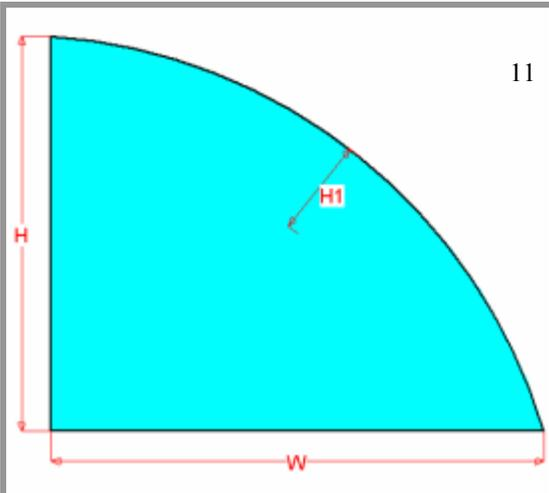

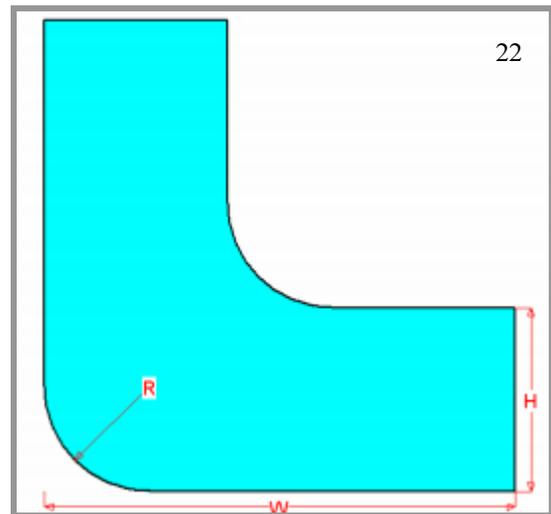
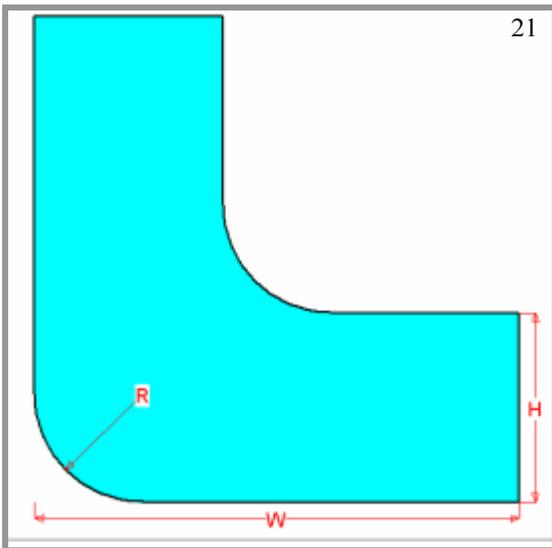
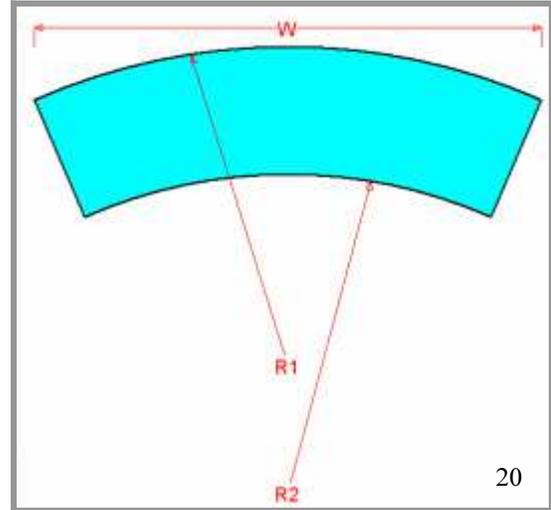
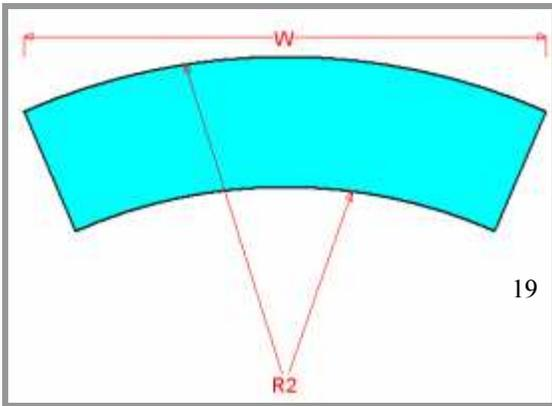
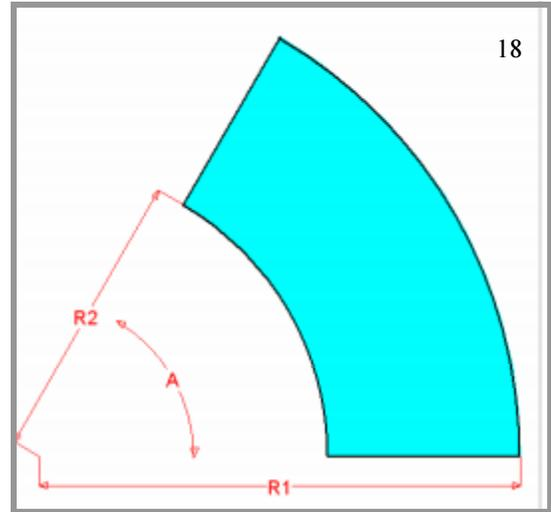
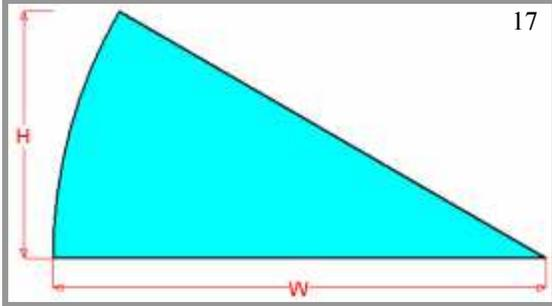

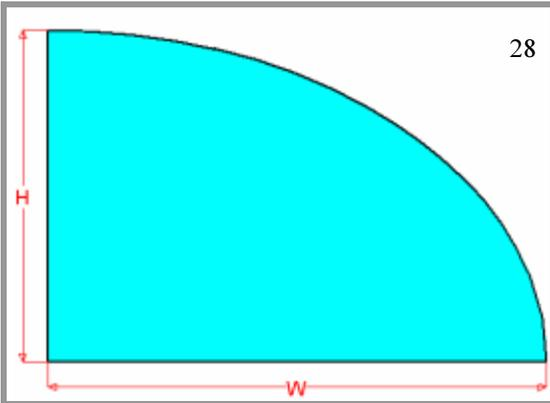
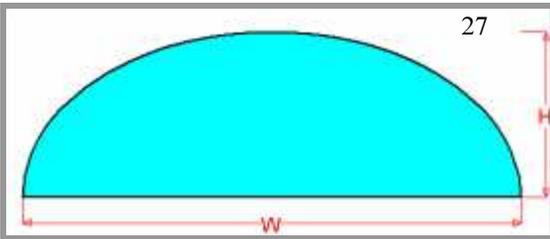
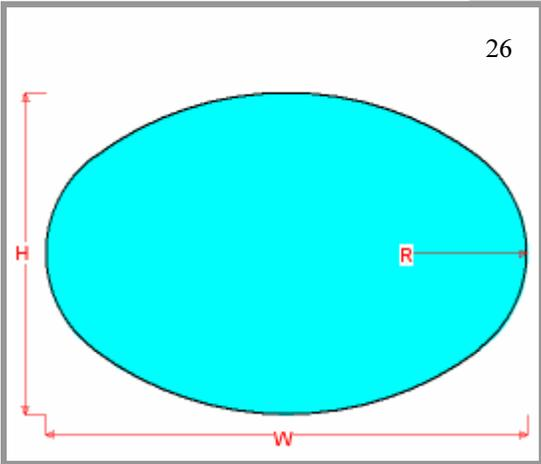
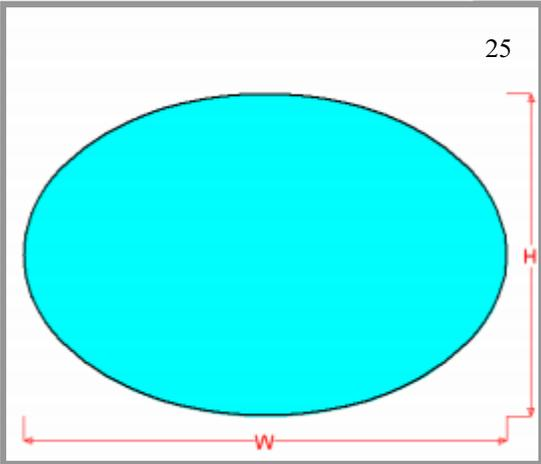
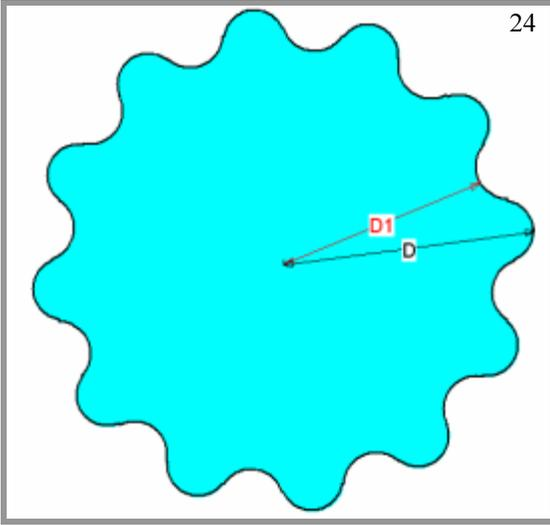
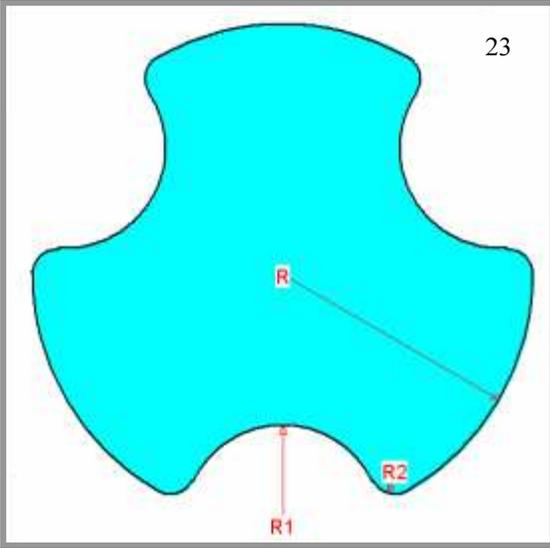

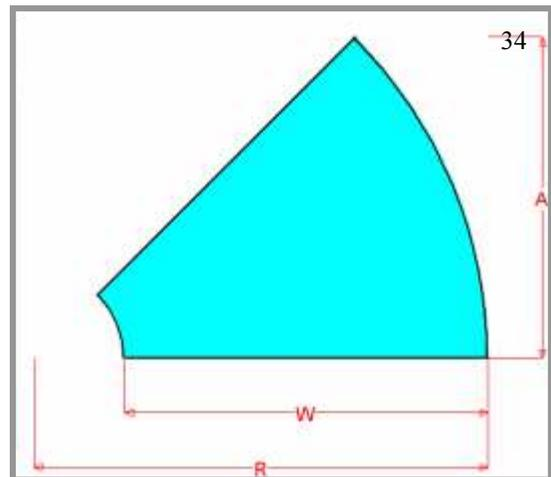
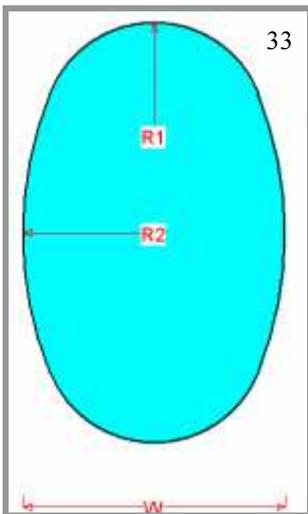
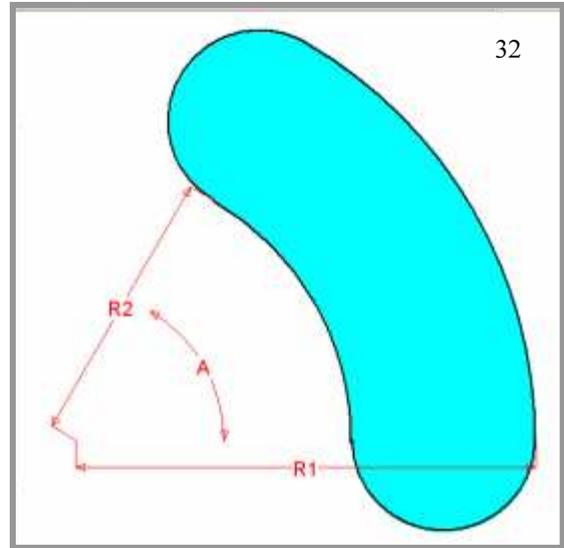
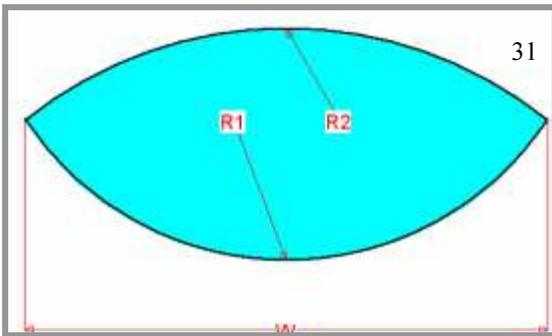
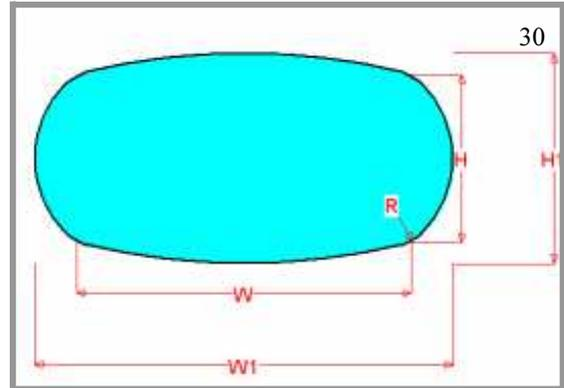
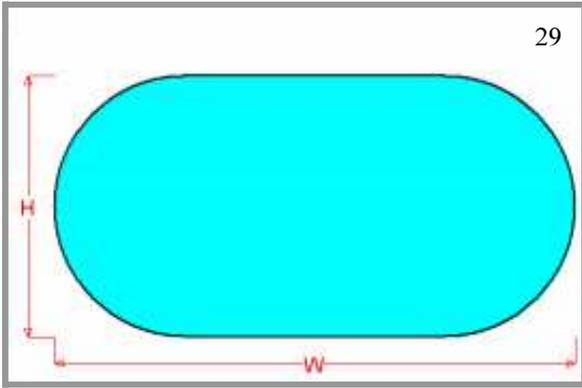

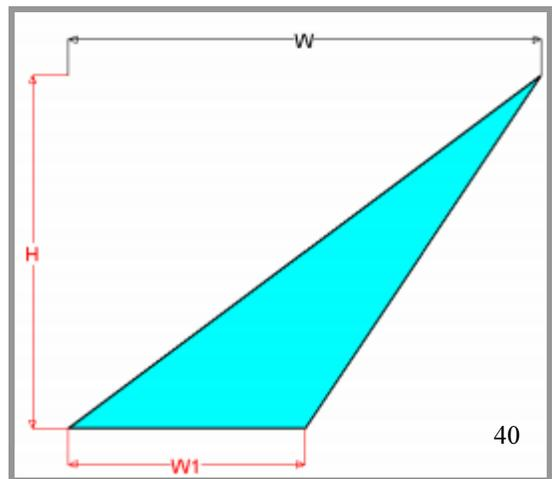
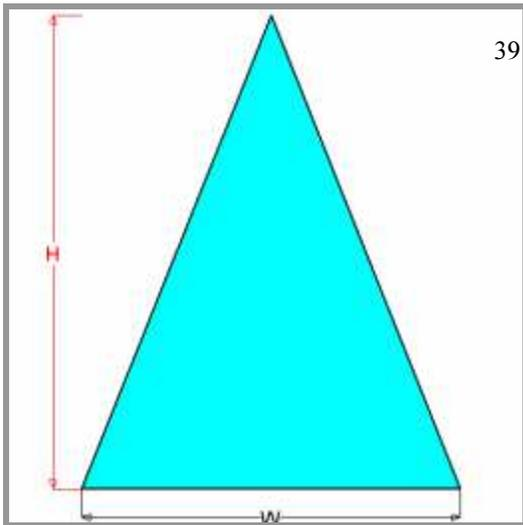
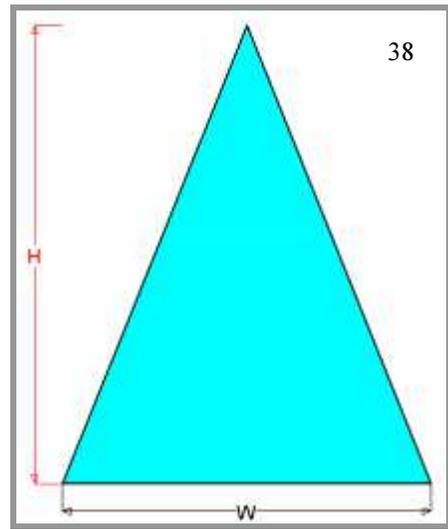
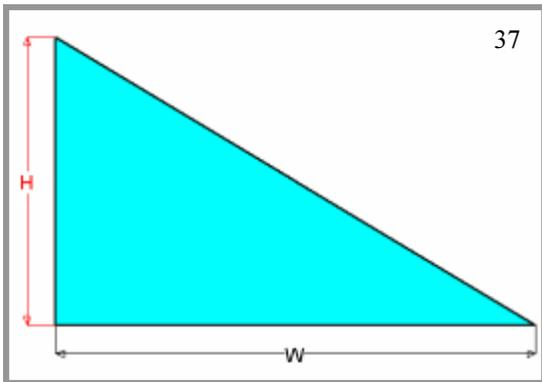
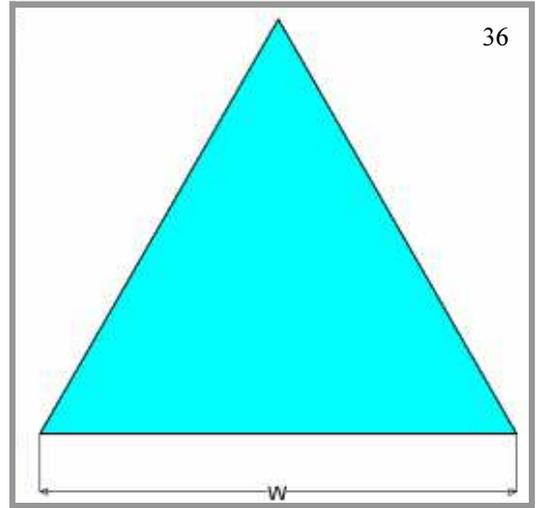
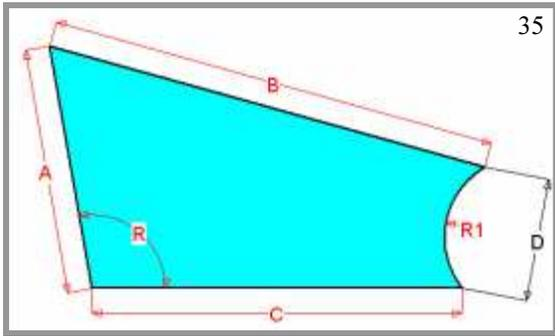

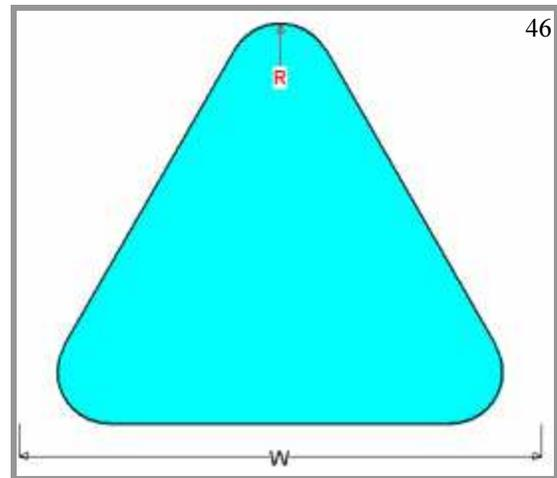
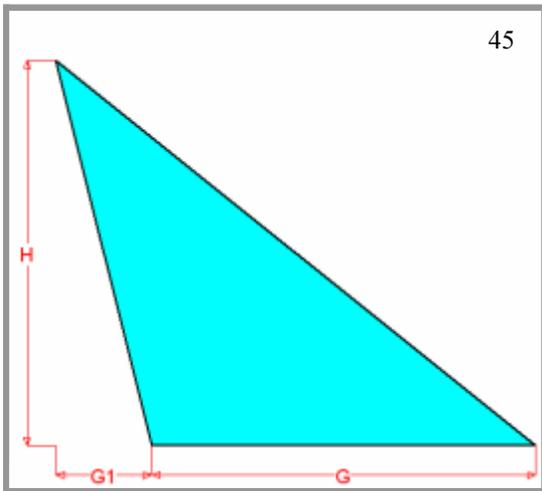
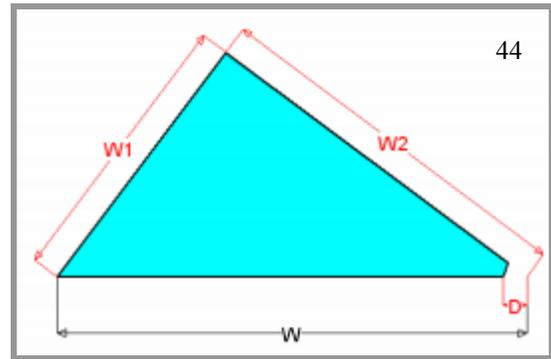
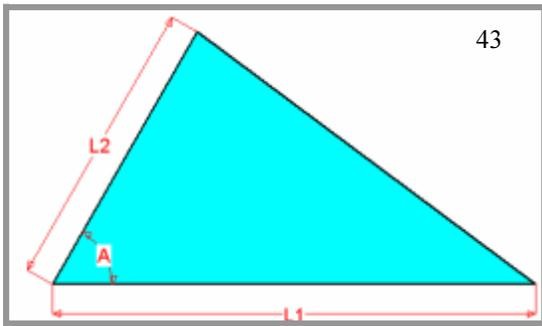
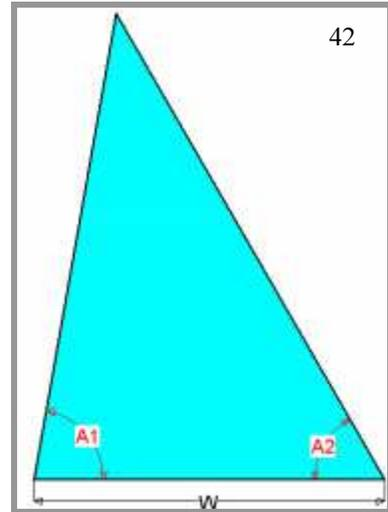
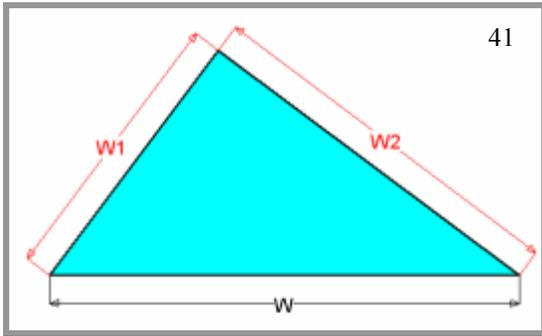

To Order Call: 1-800-277-5223

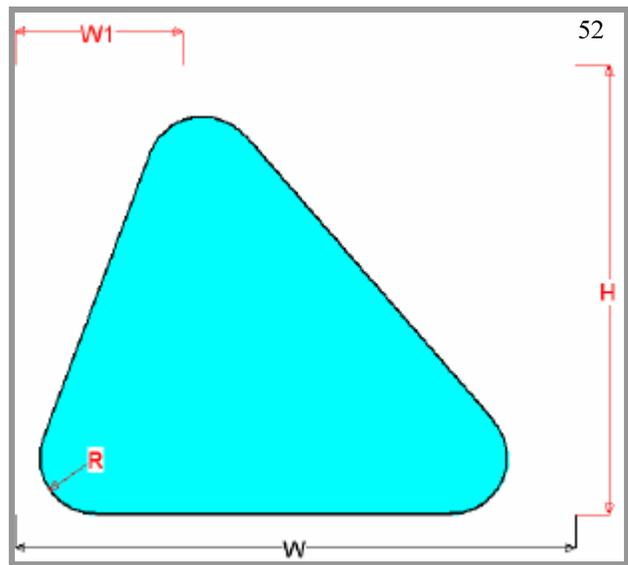
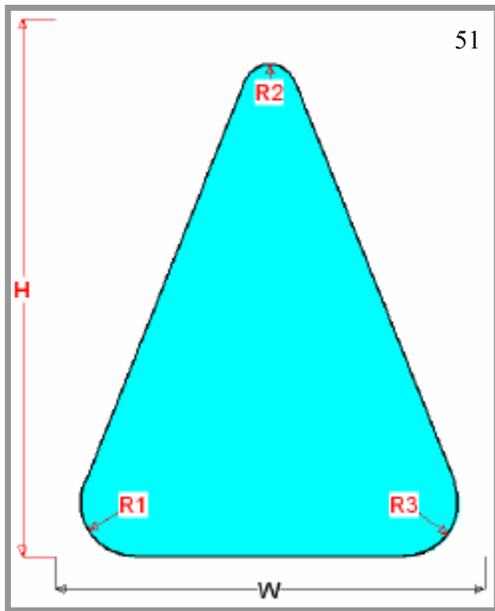
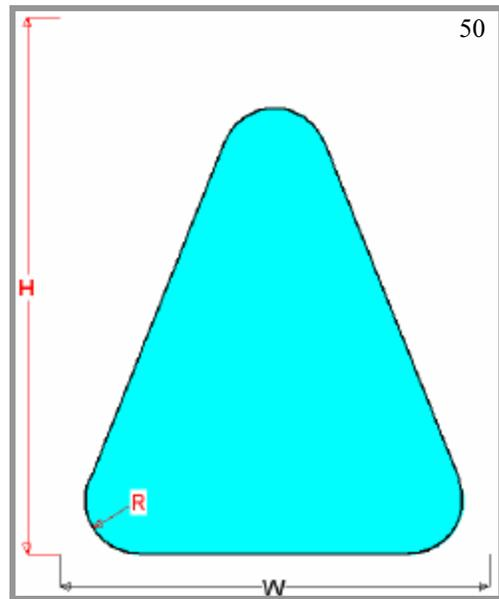
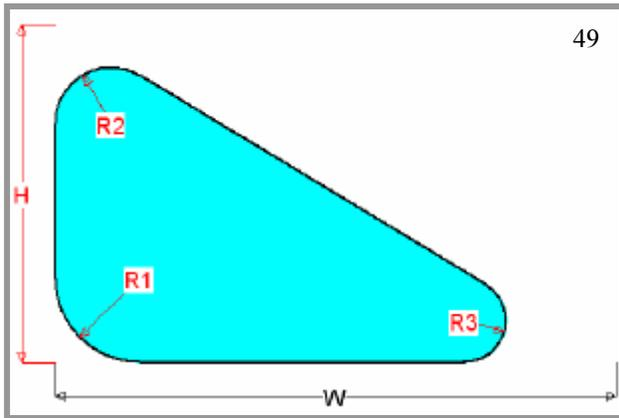
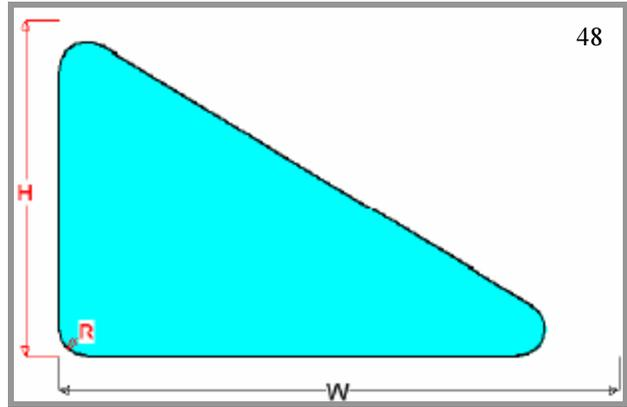
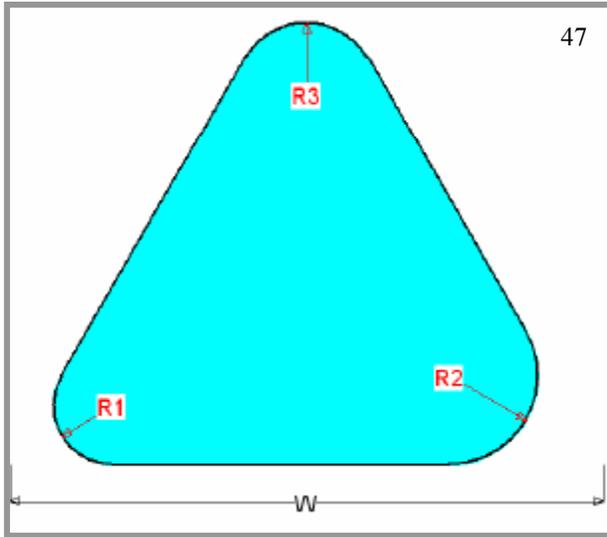

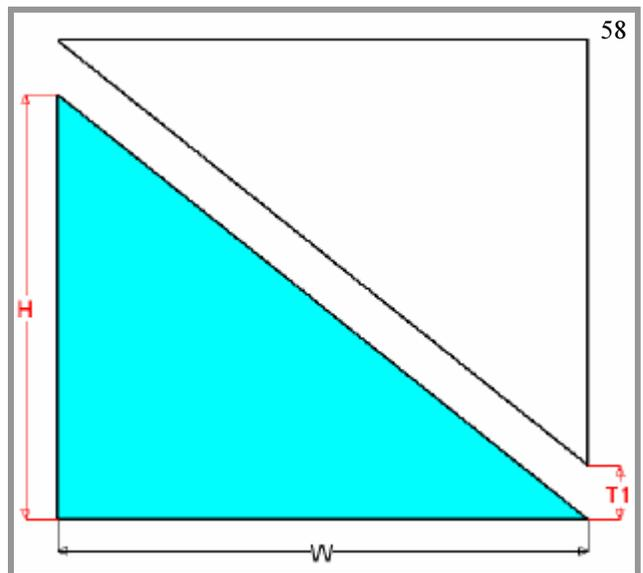
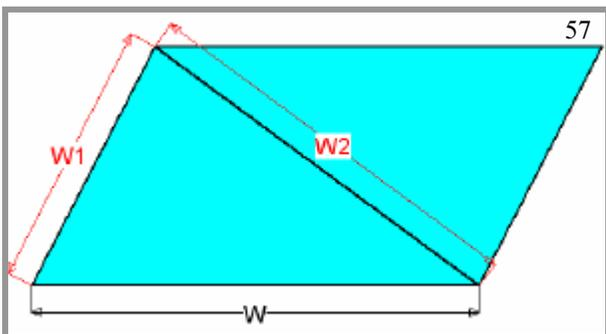
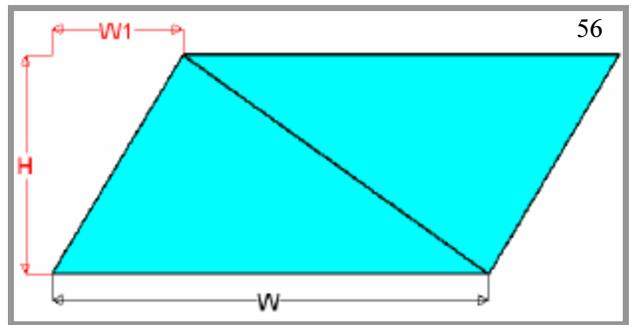
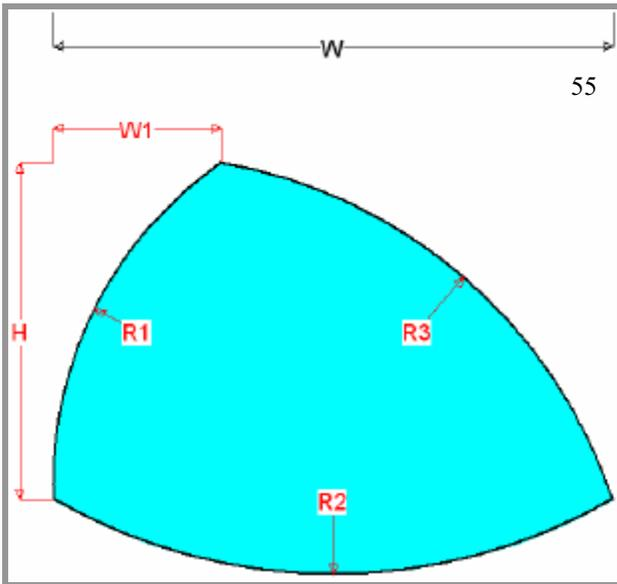
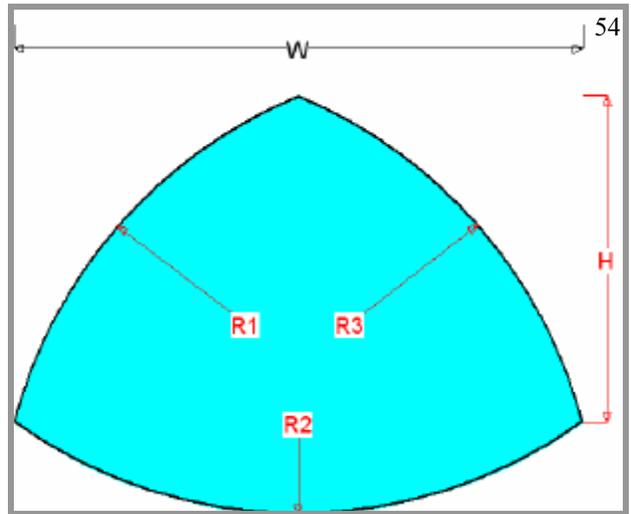
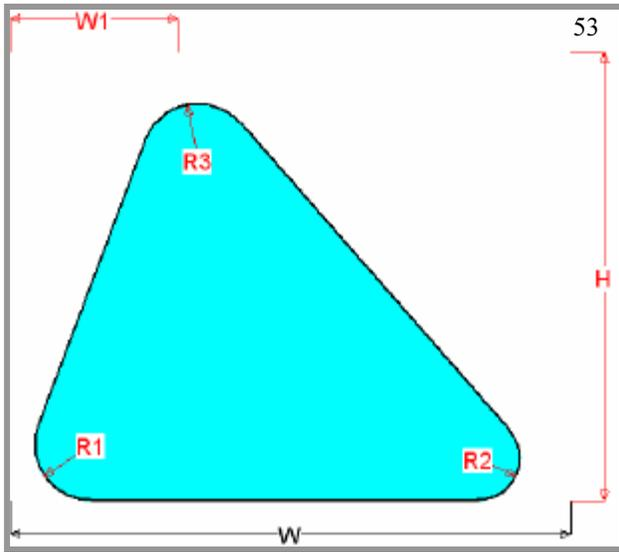

To Order Call: 1-800-277-5223

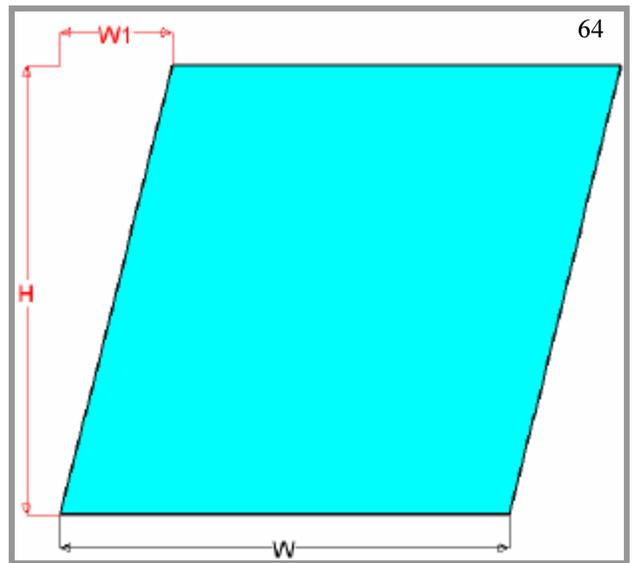
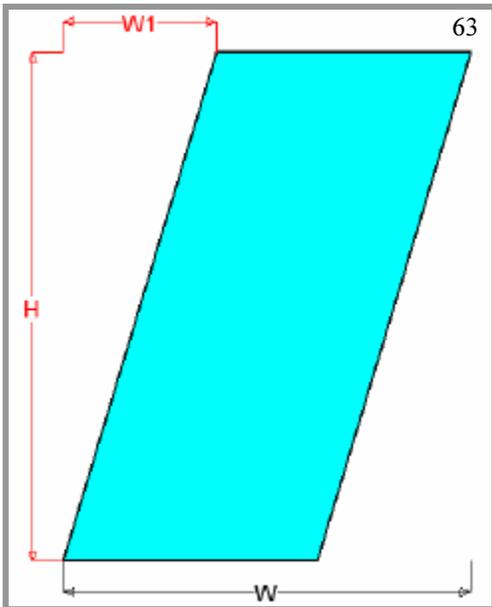
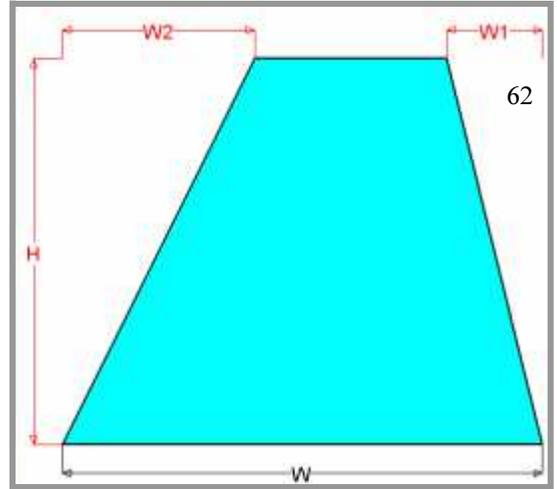
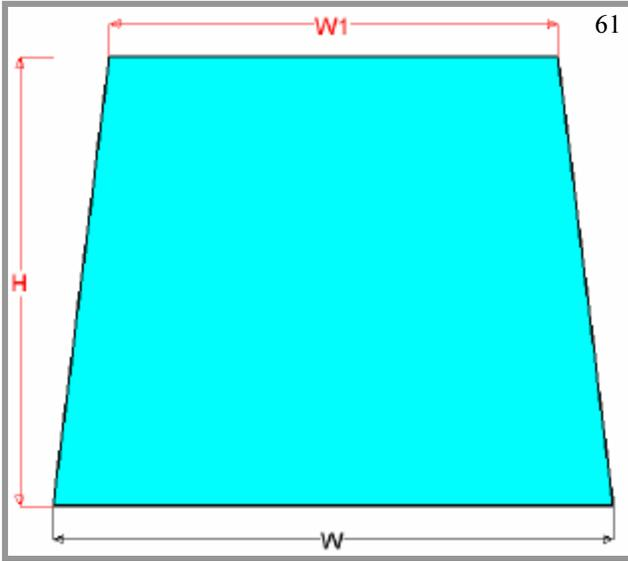
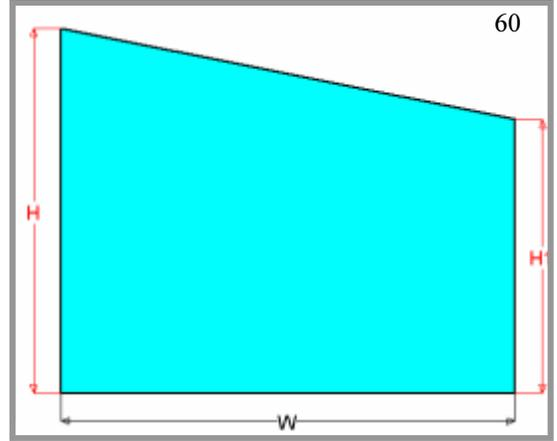
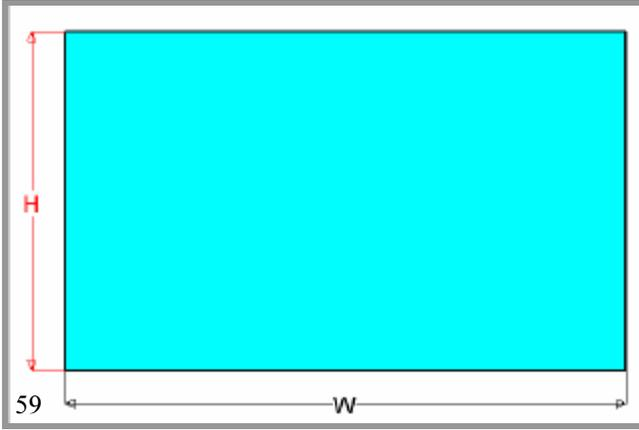

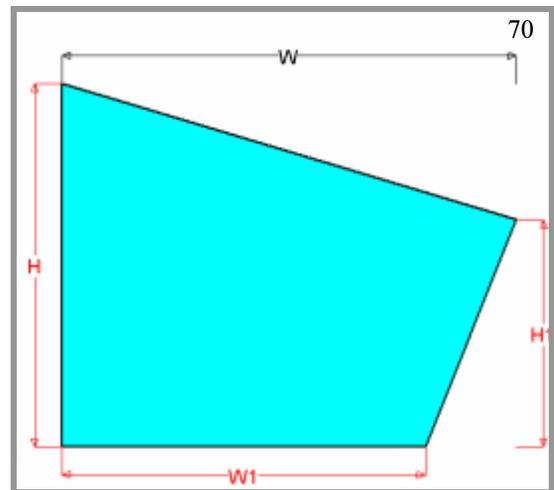
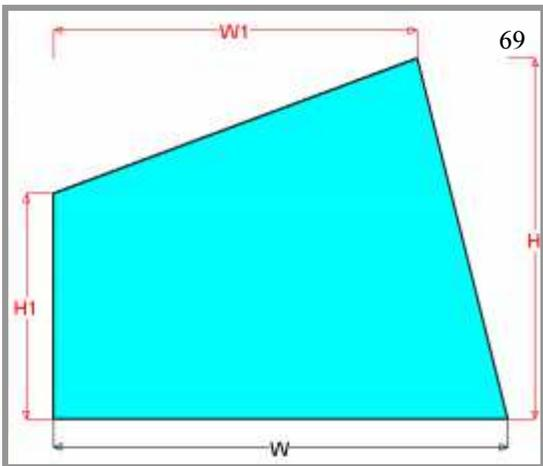
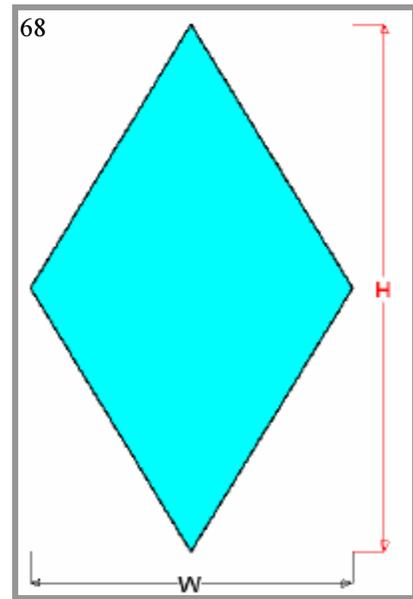
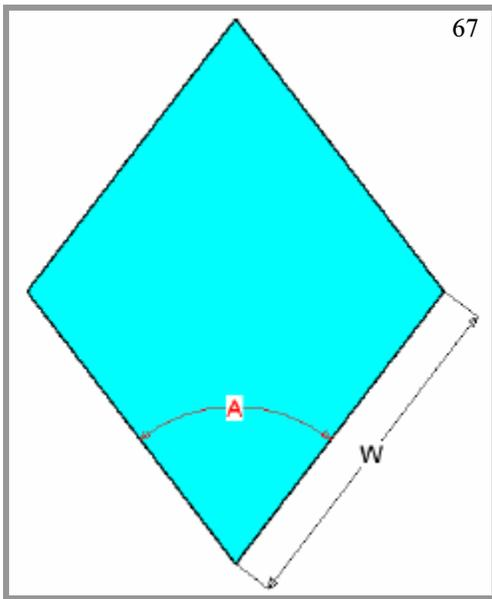
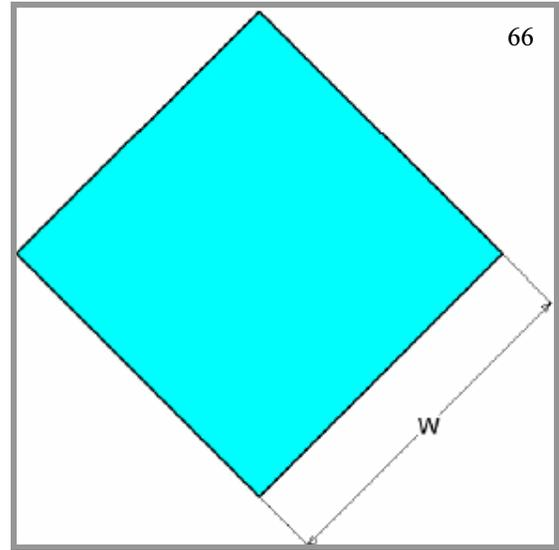
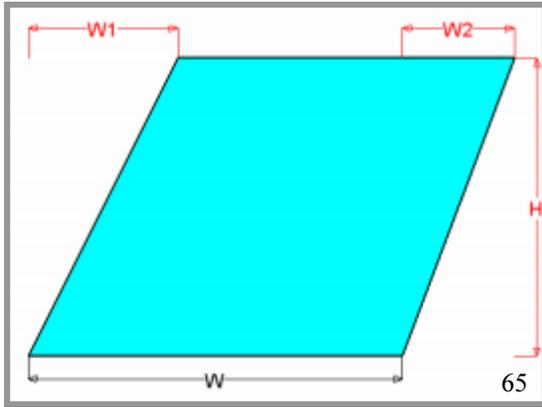

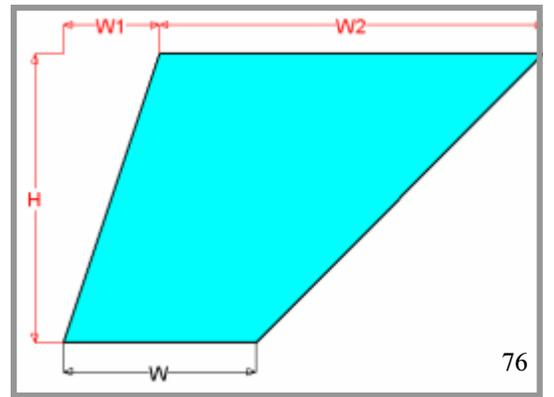
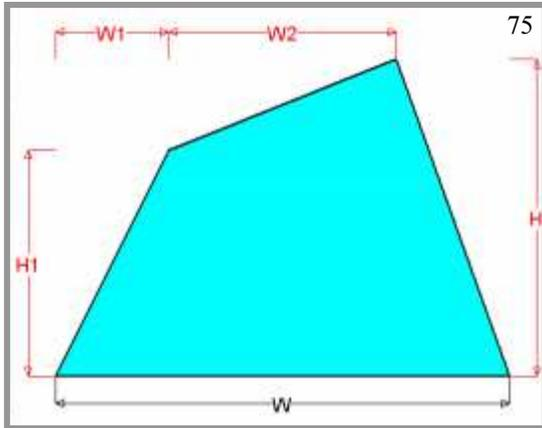
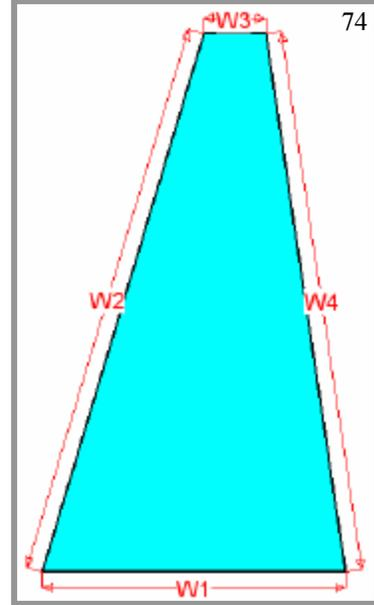
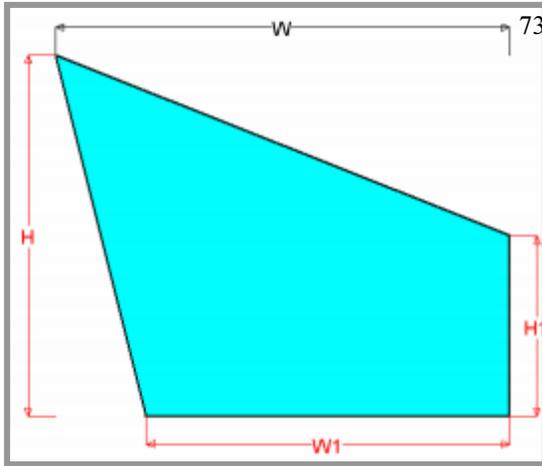
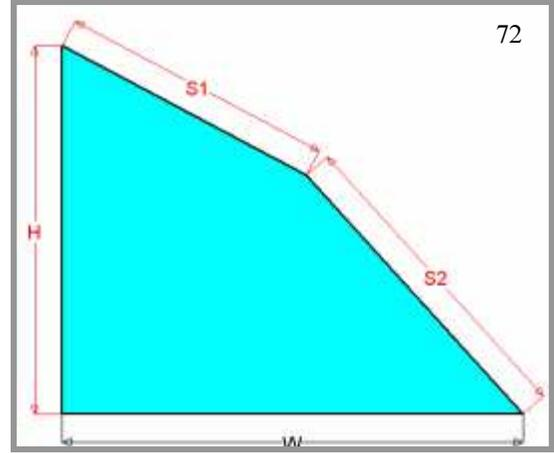
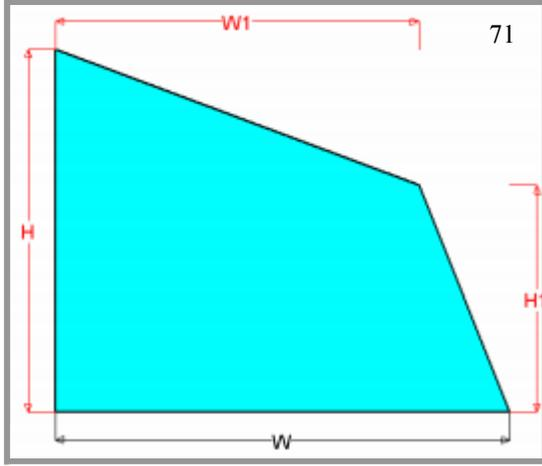

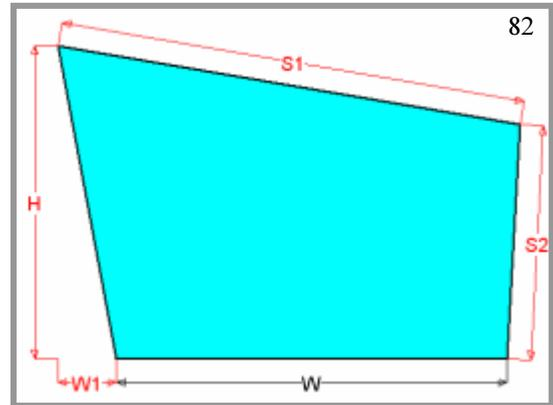
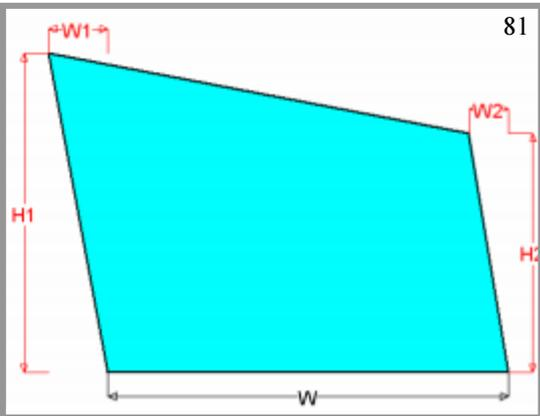
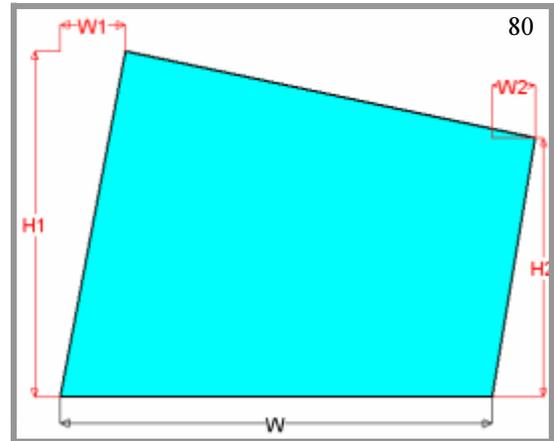
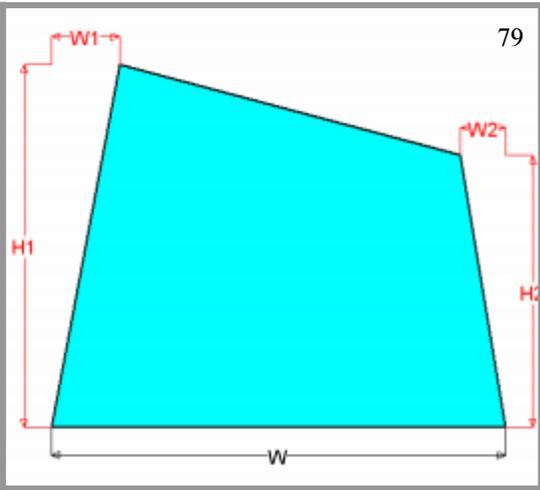
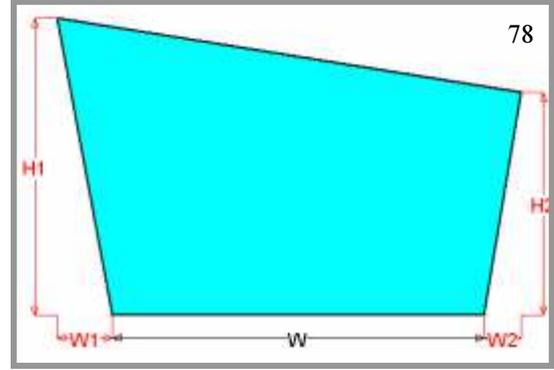
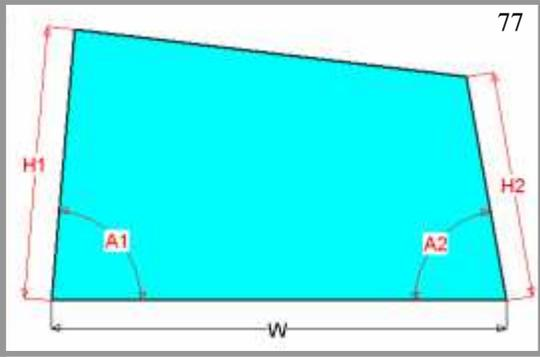

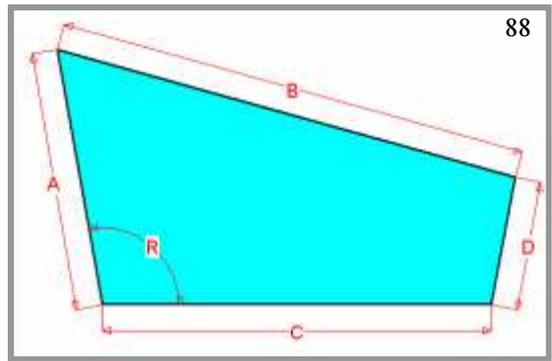
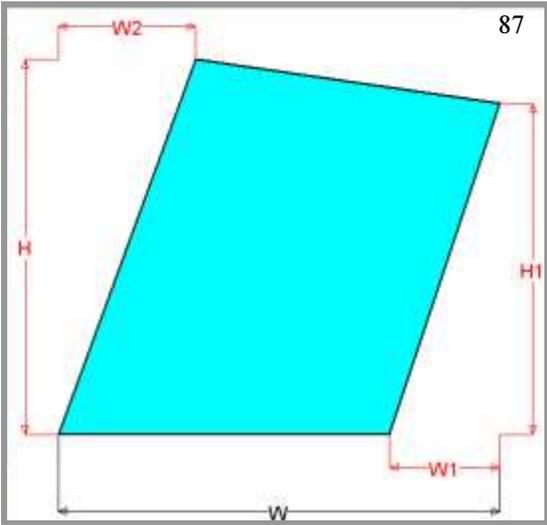
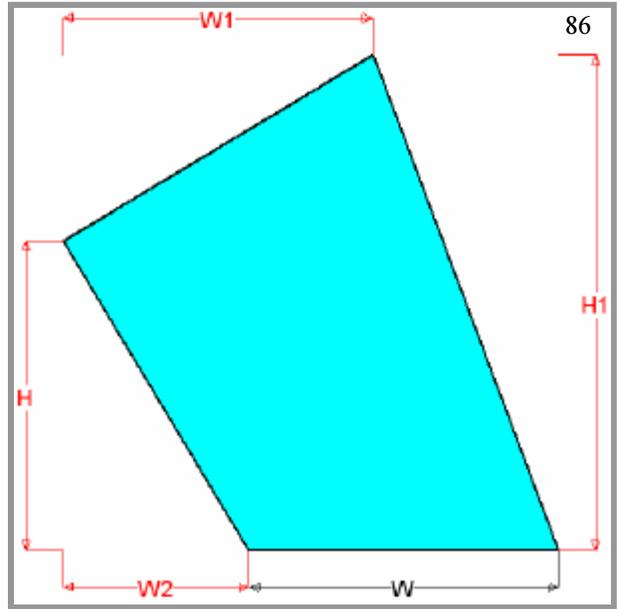
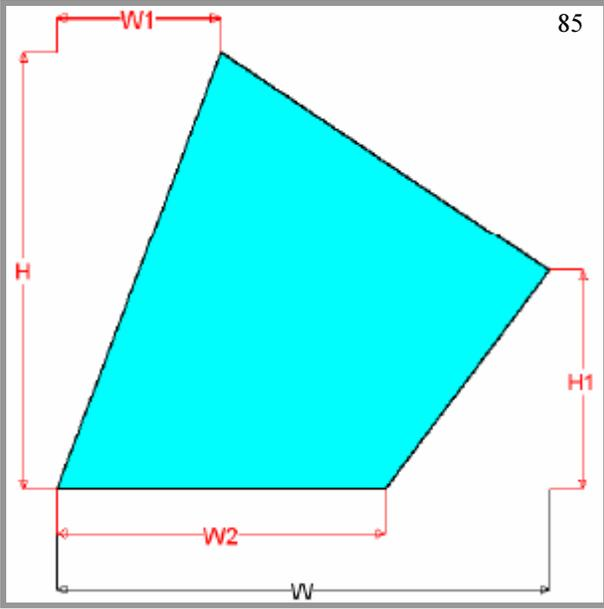
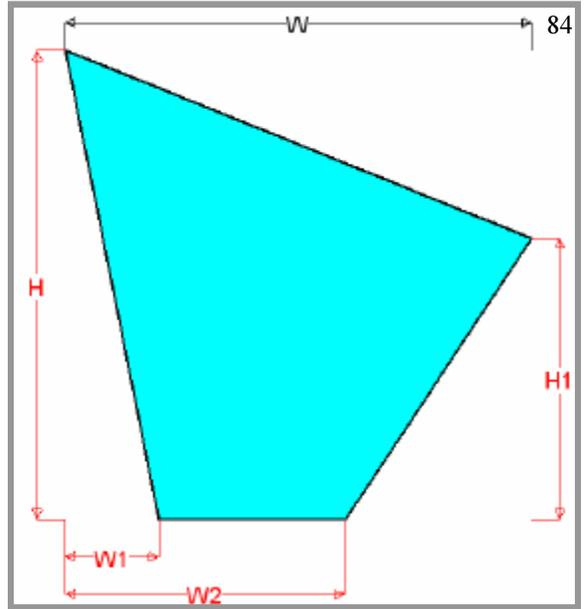
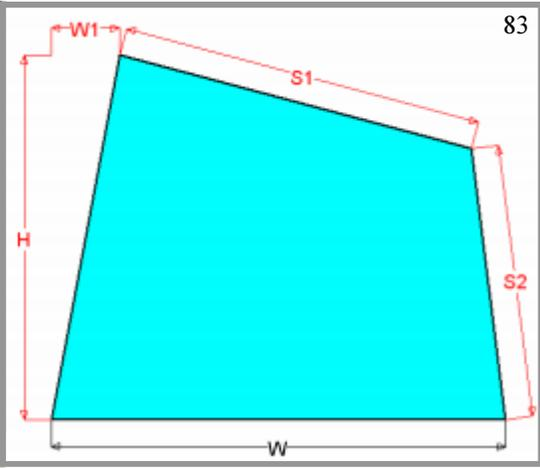

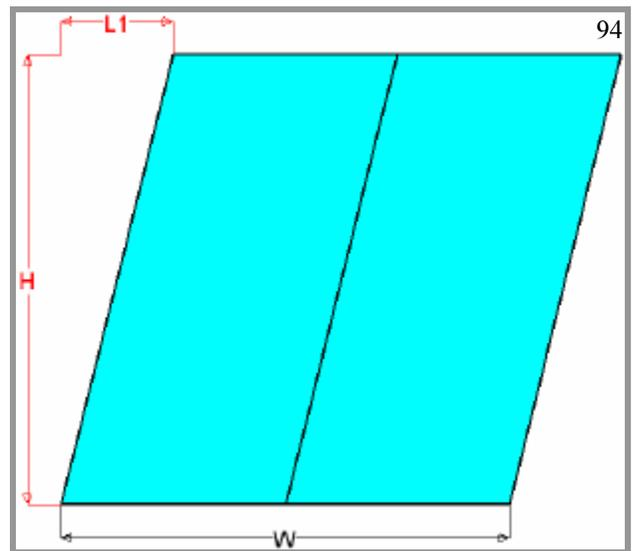
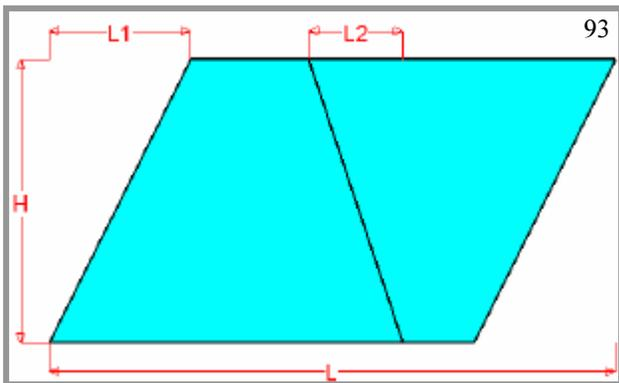
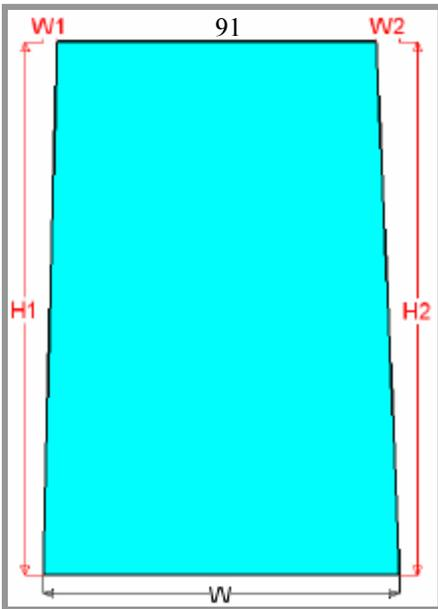
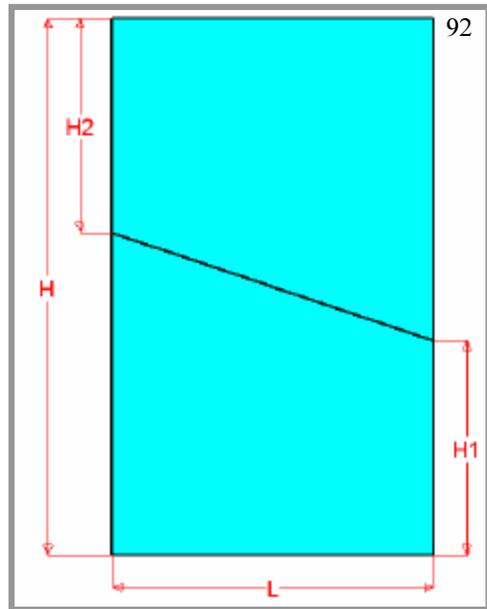
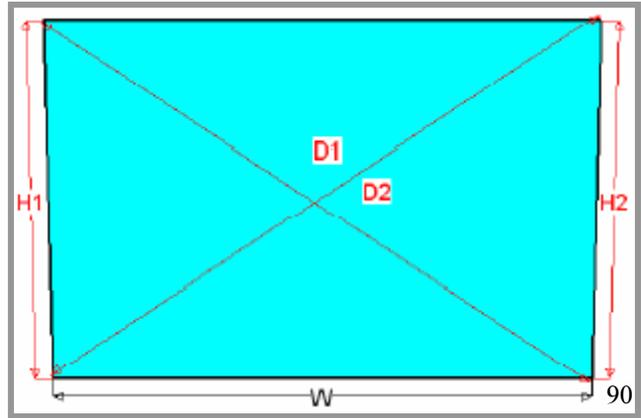
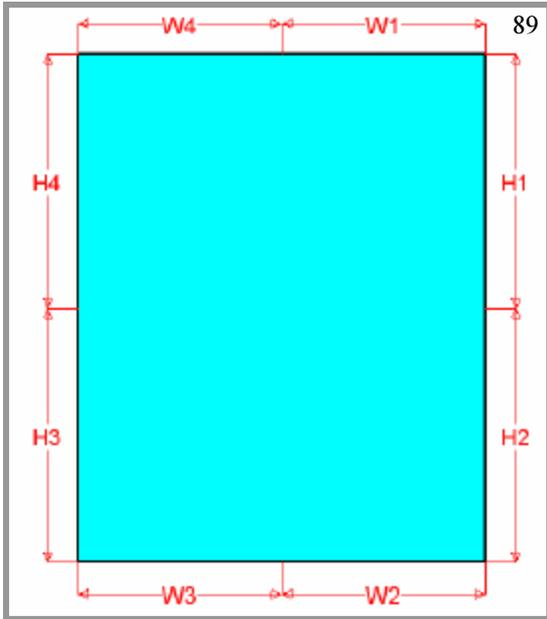

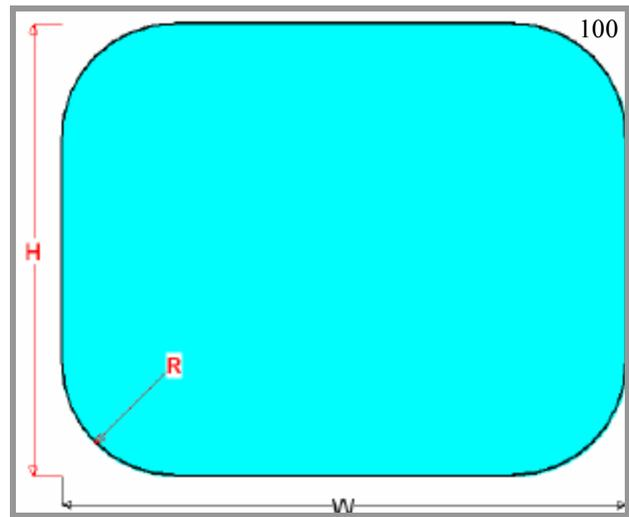
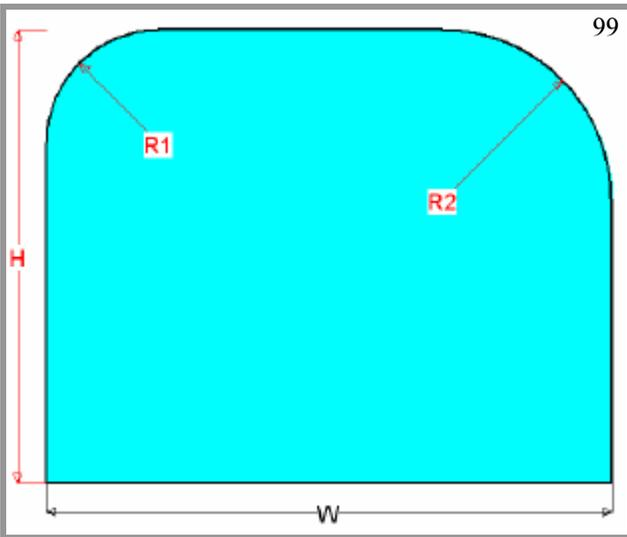
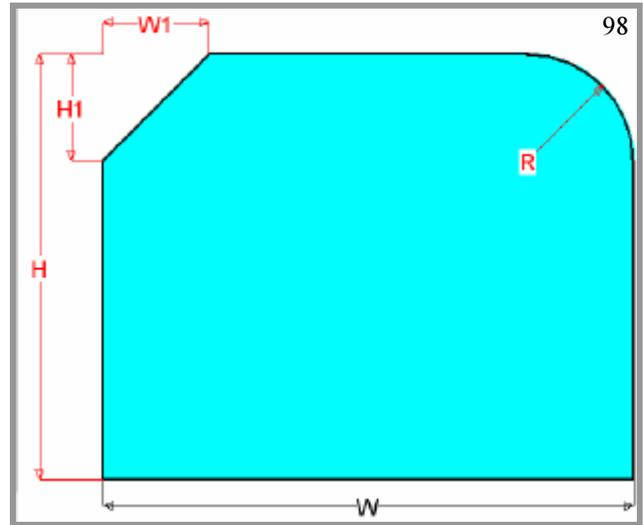
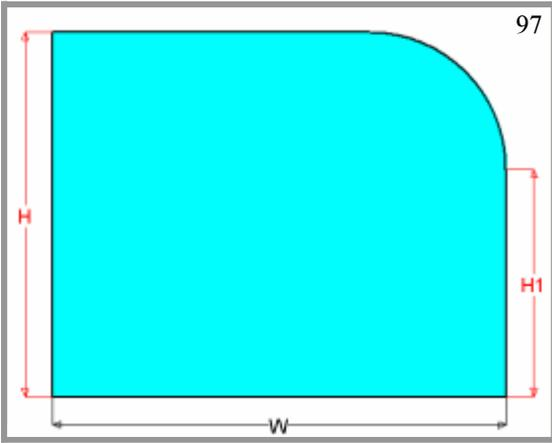
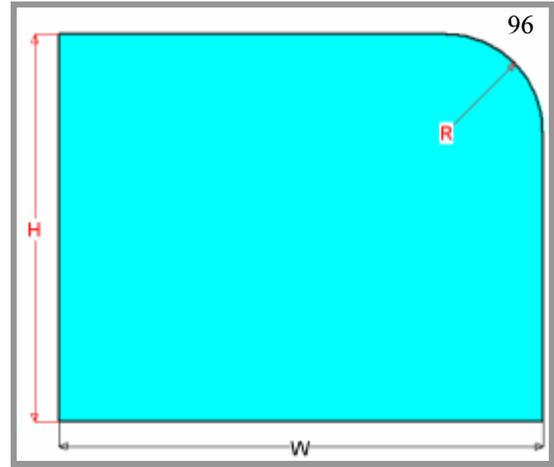
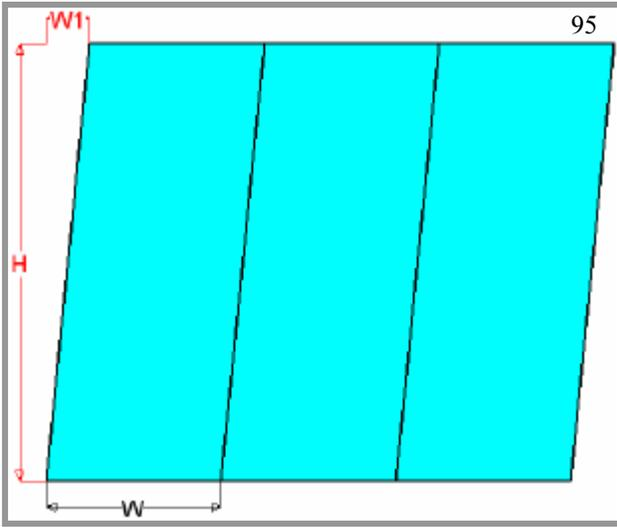

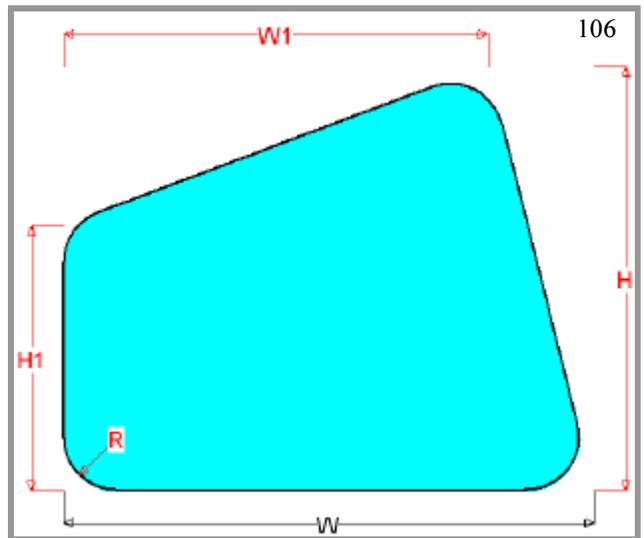
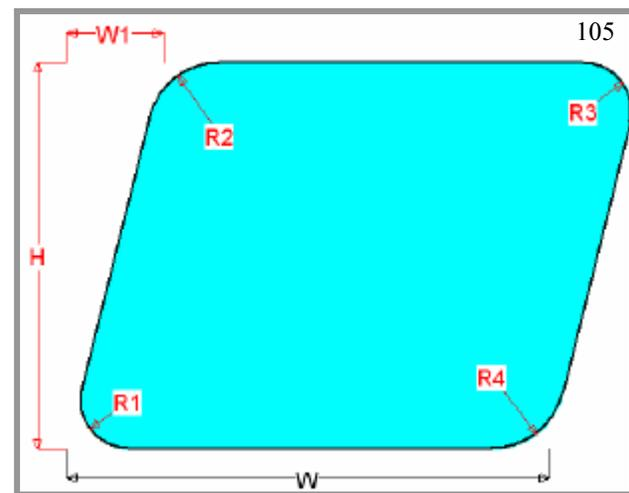
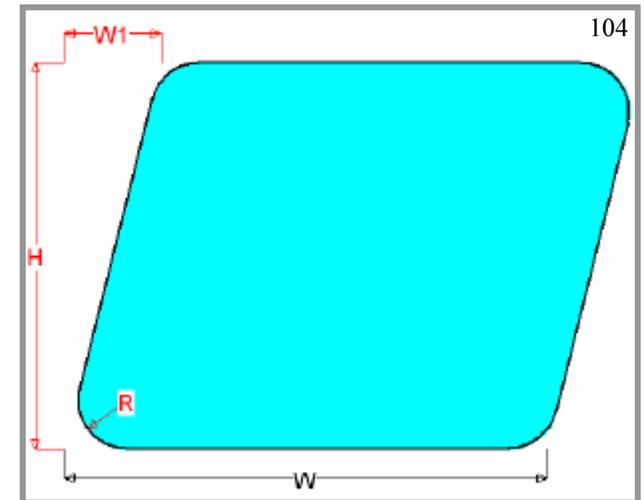
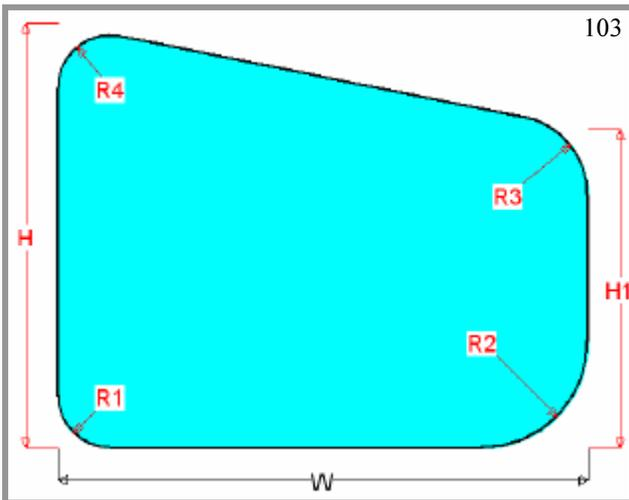
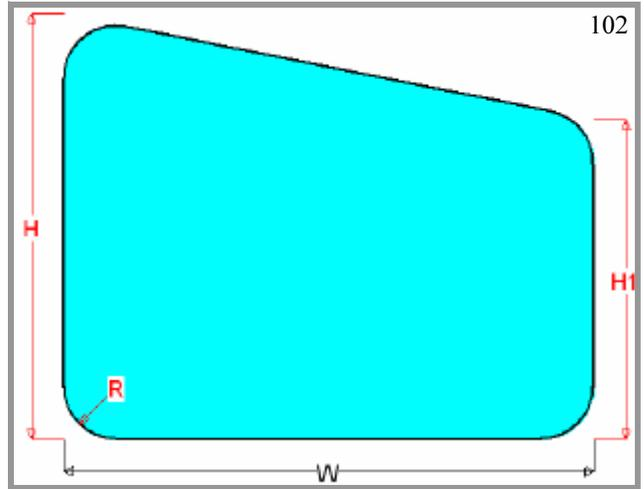
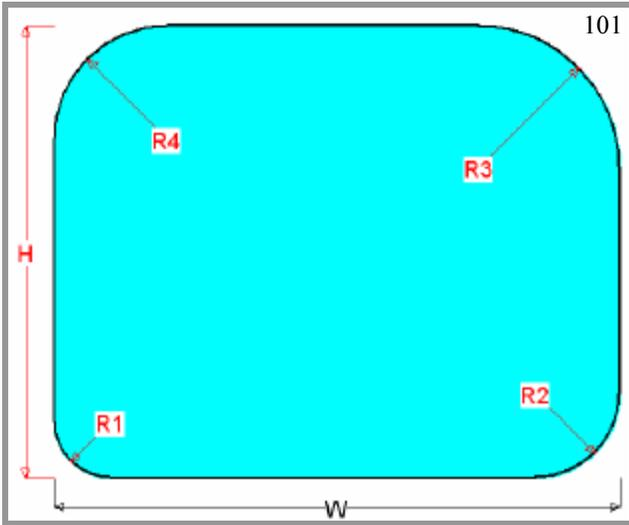

To Order Call: 1-800-277-5223

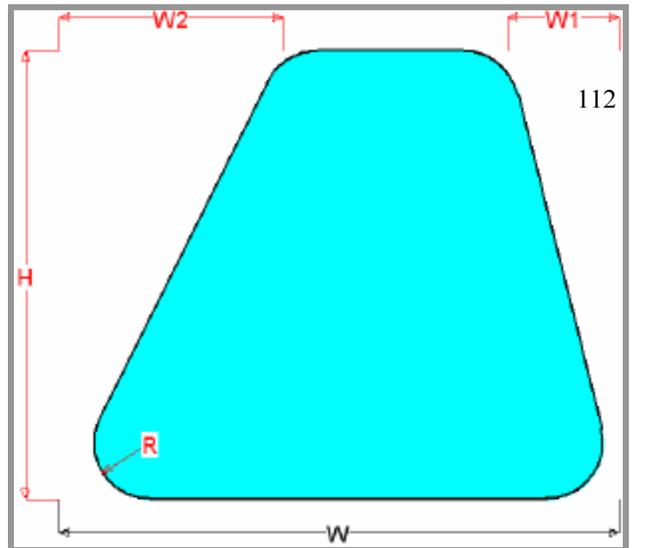
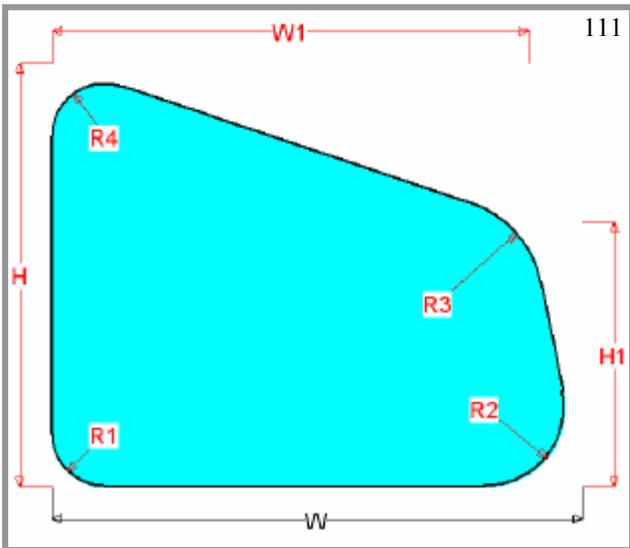
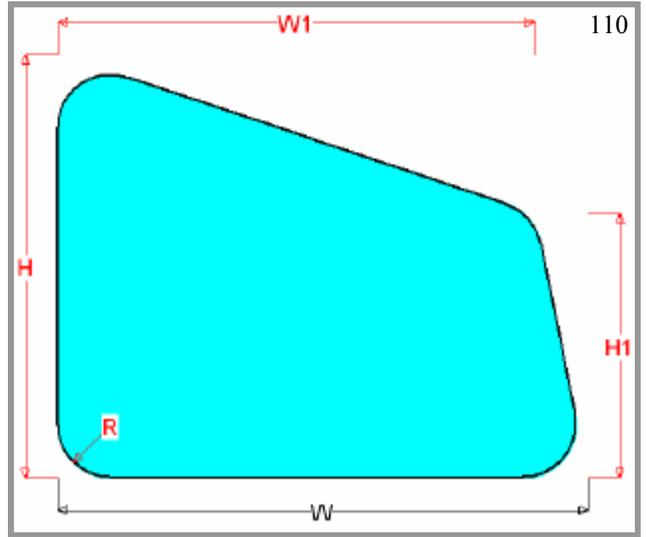
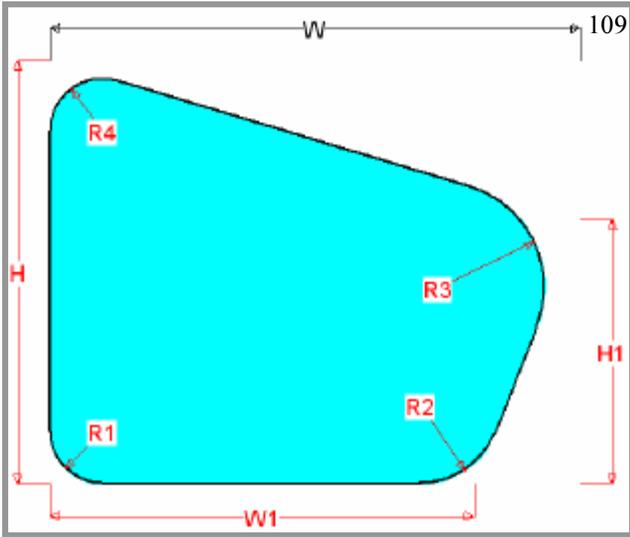
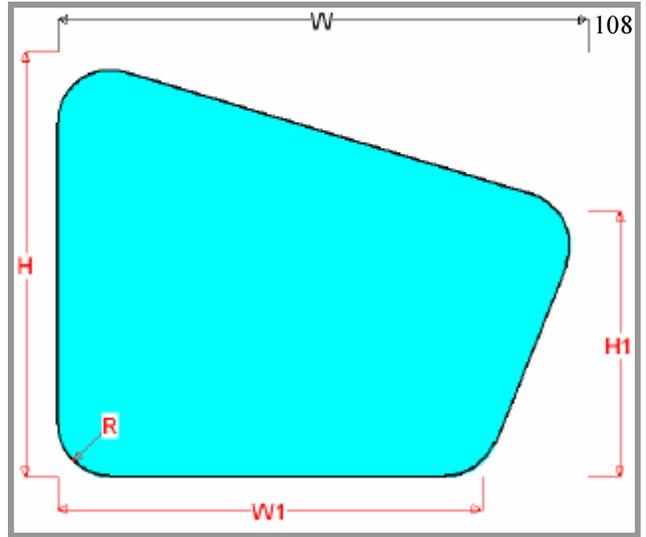
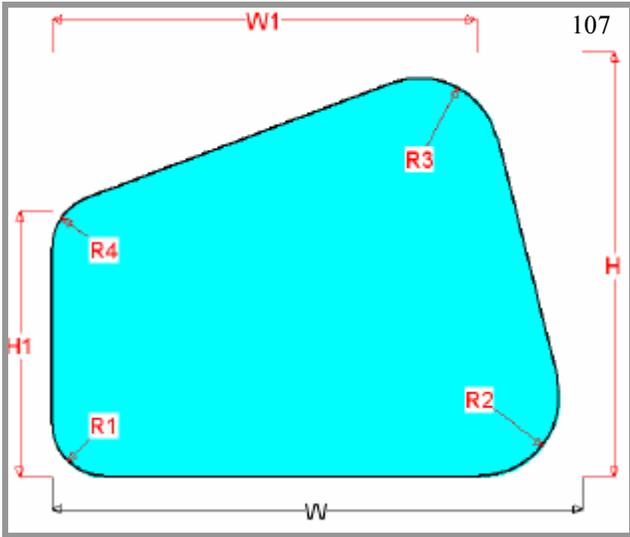

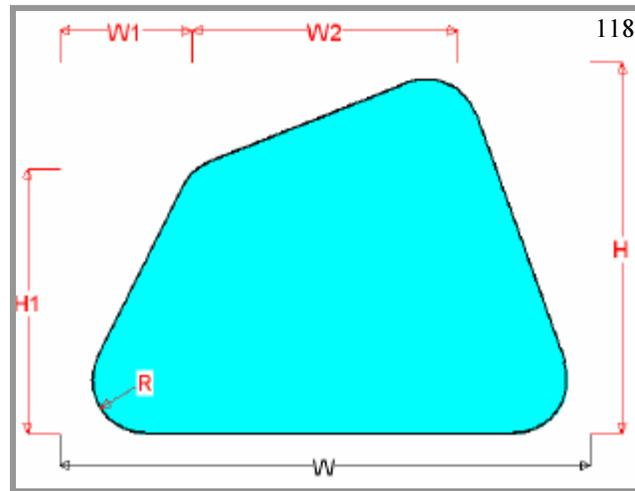
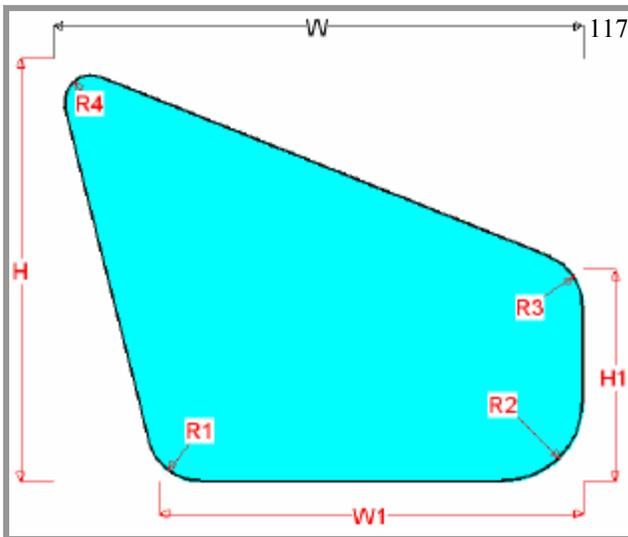
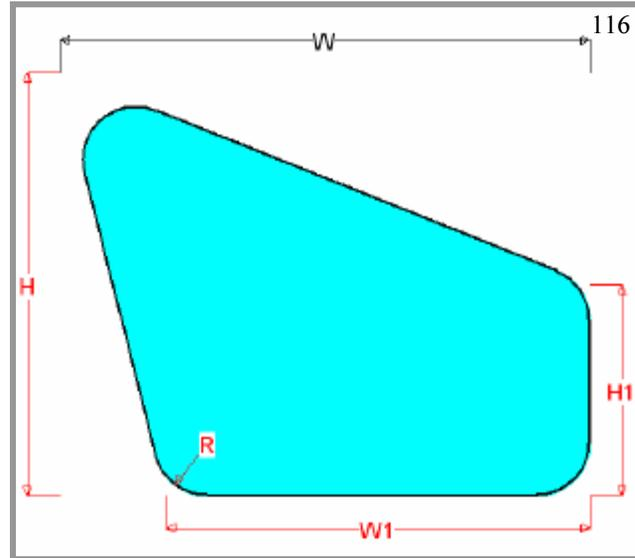
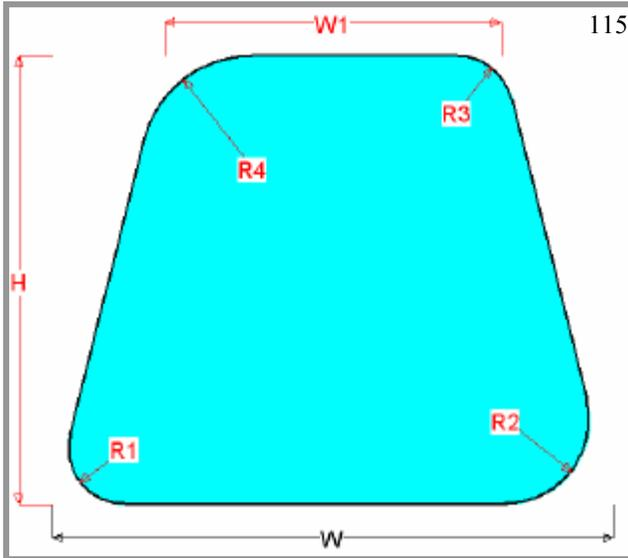
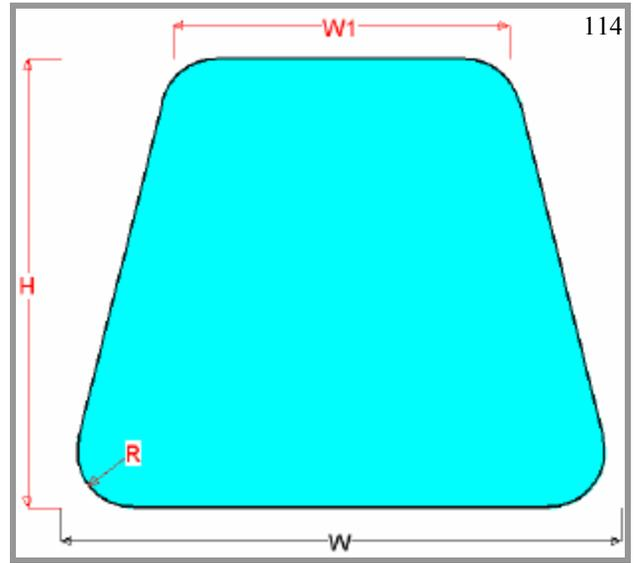
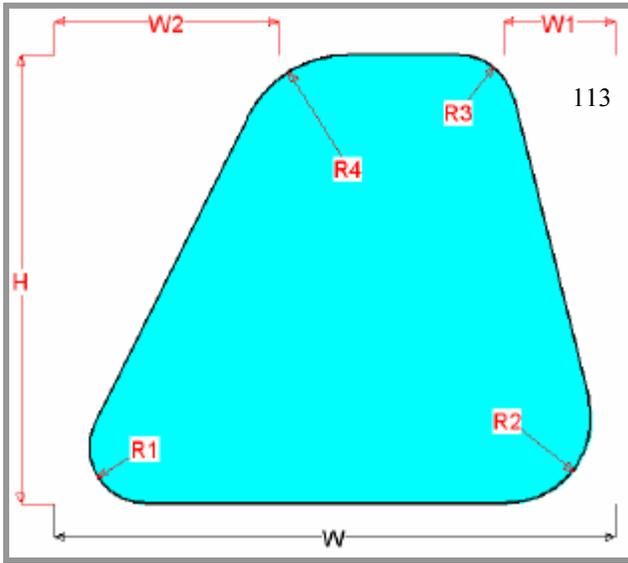

To Order Call: 1-800-277-5223

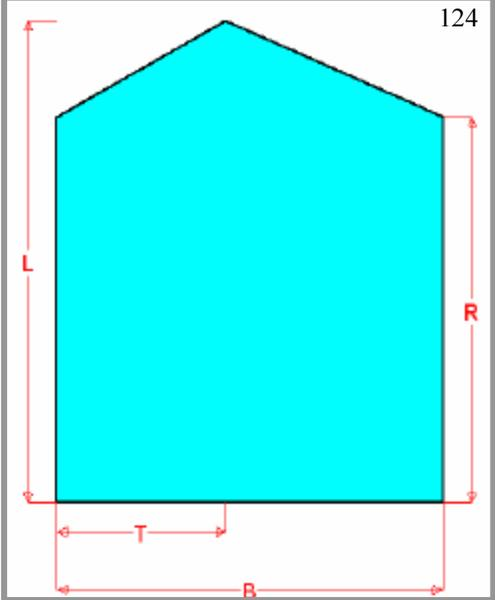
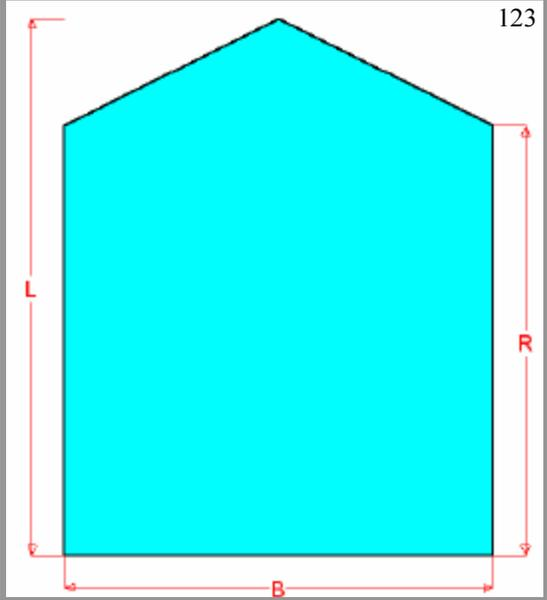
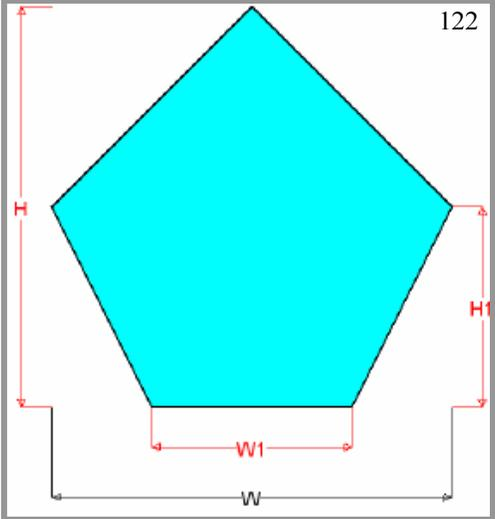
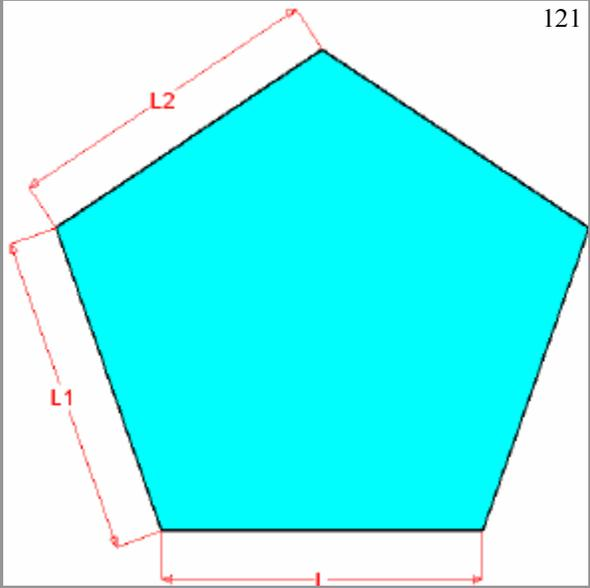
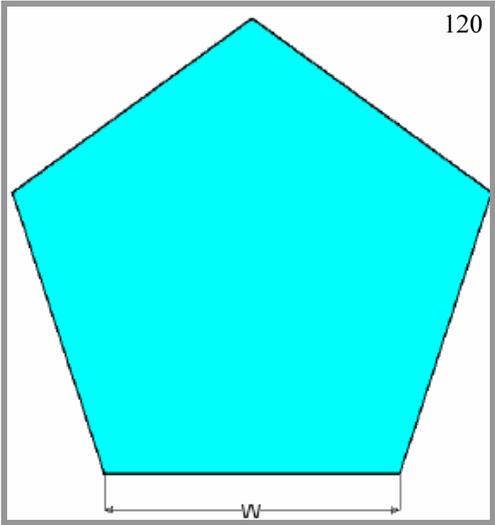
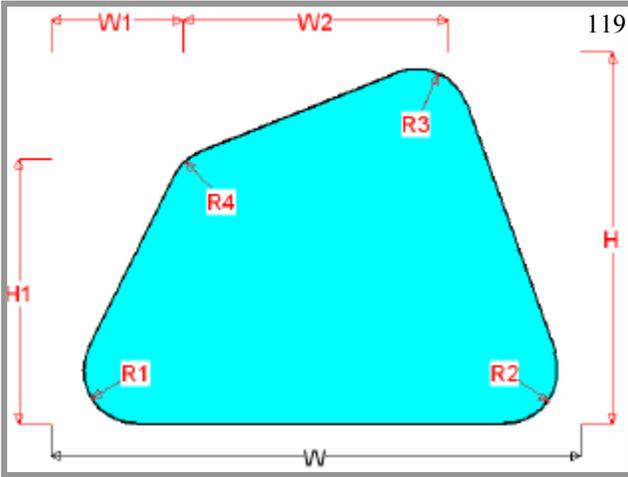

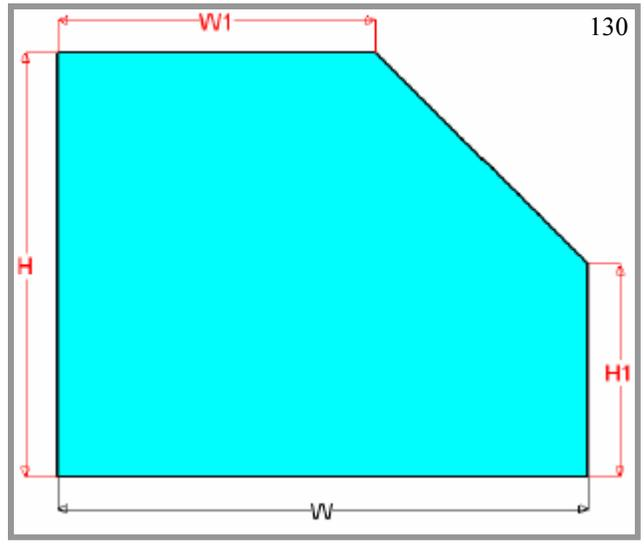
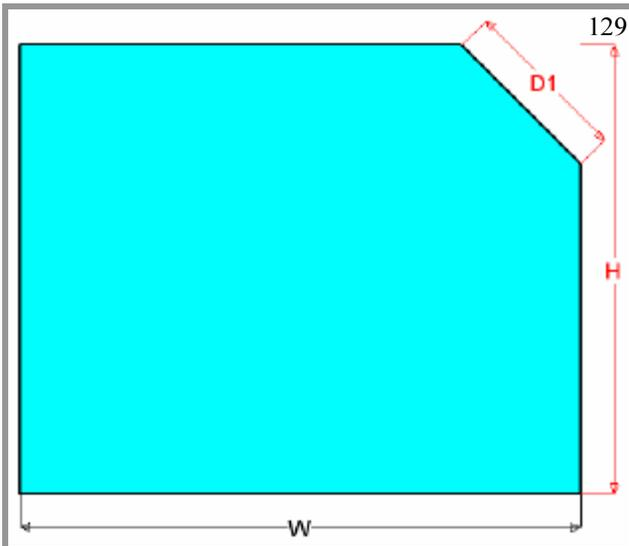
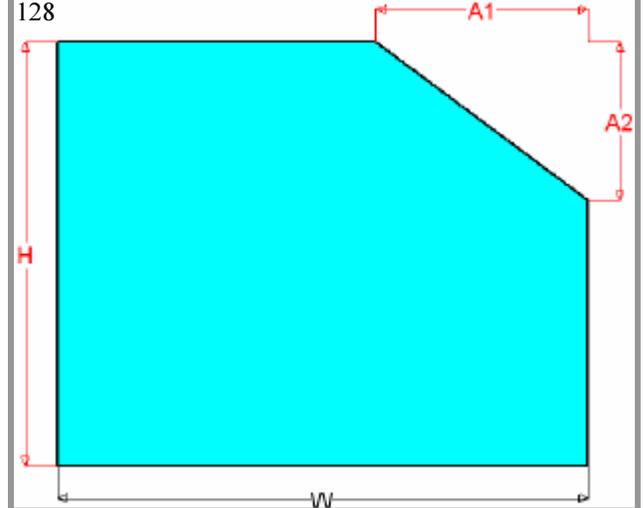
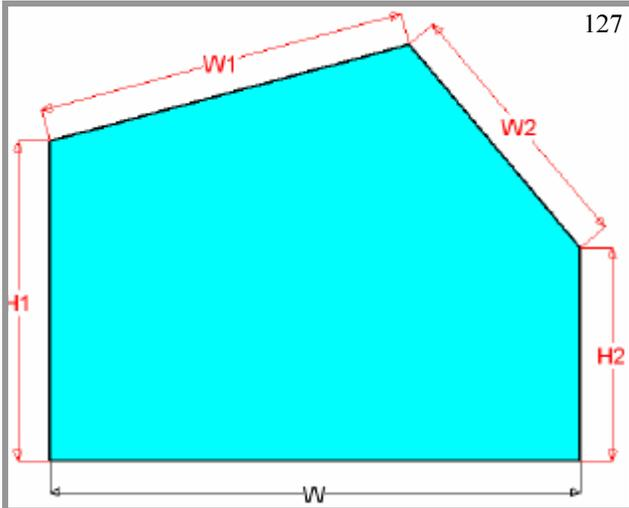
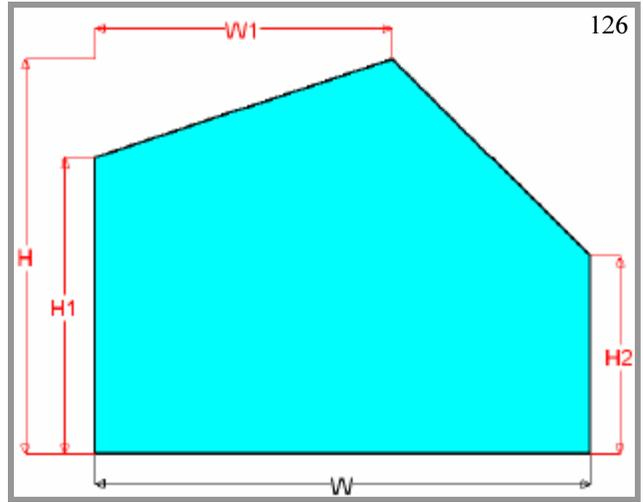
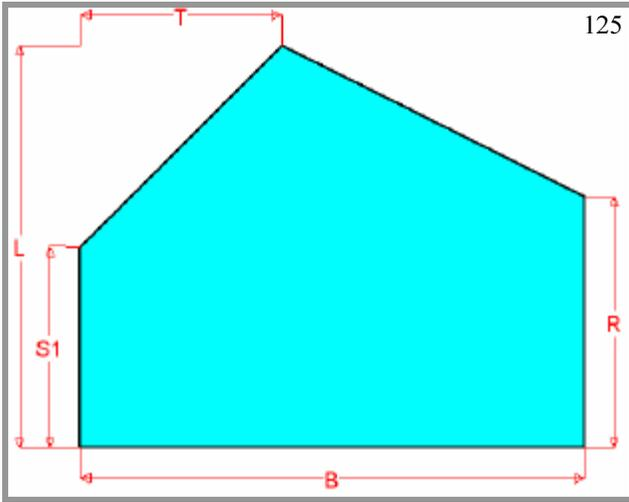

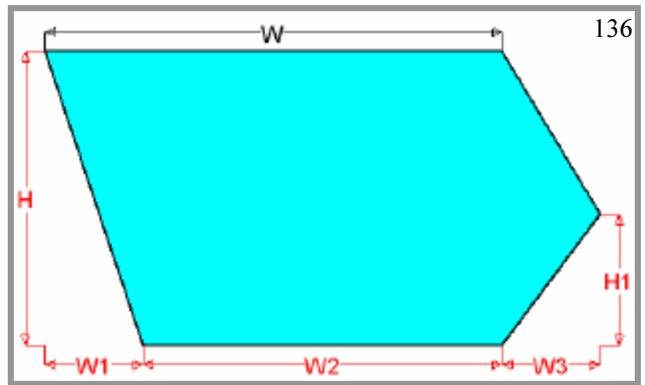
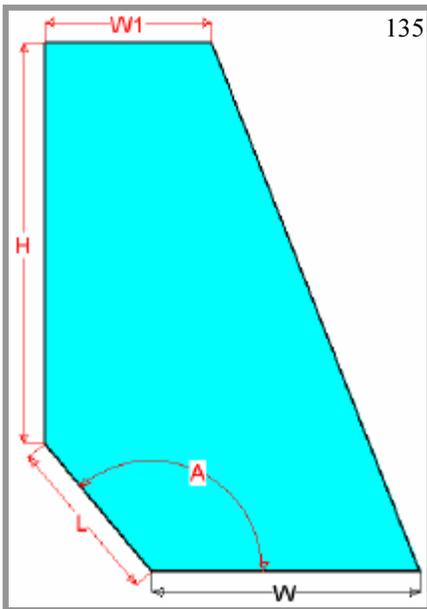
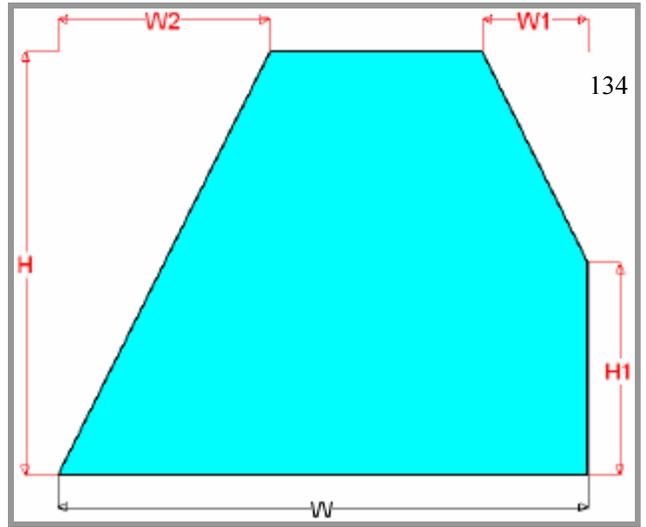
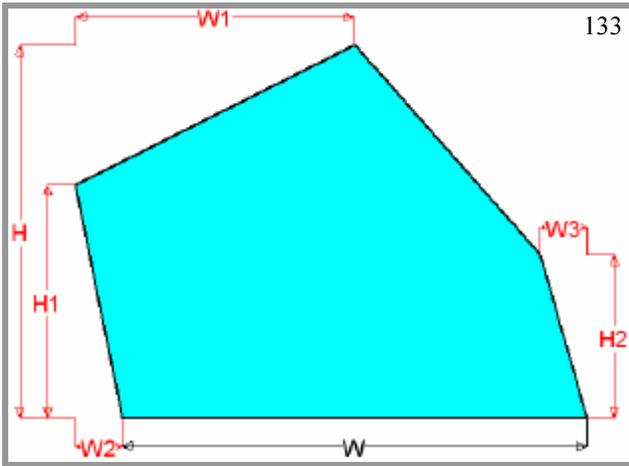
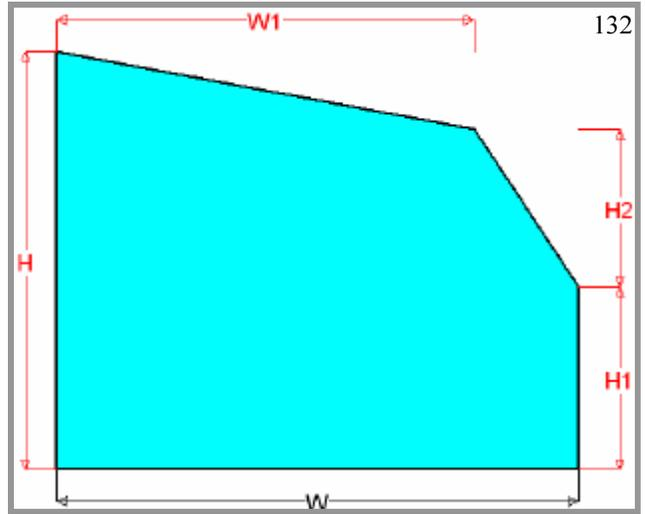
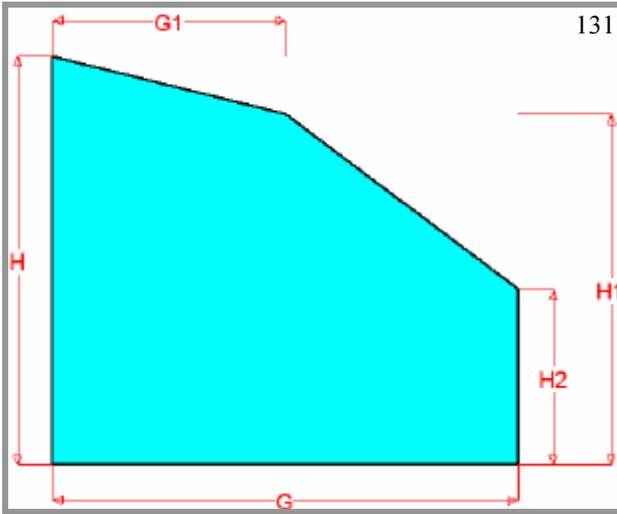

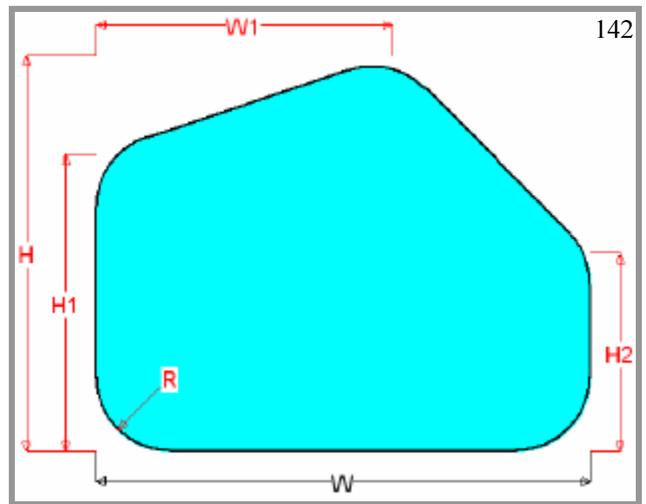
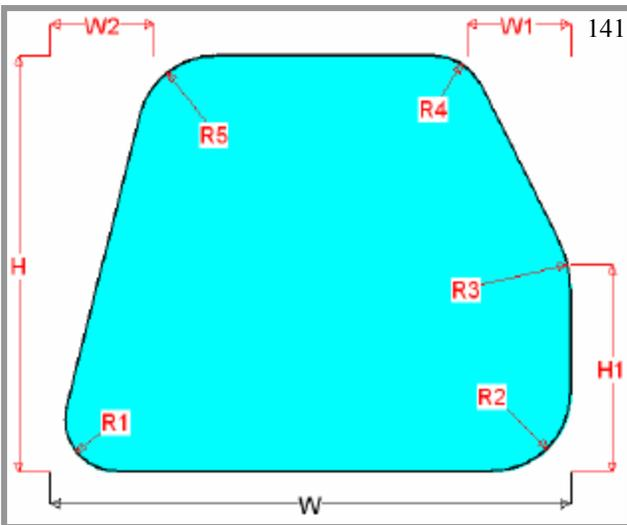
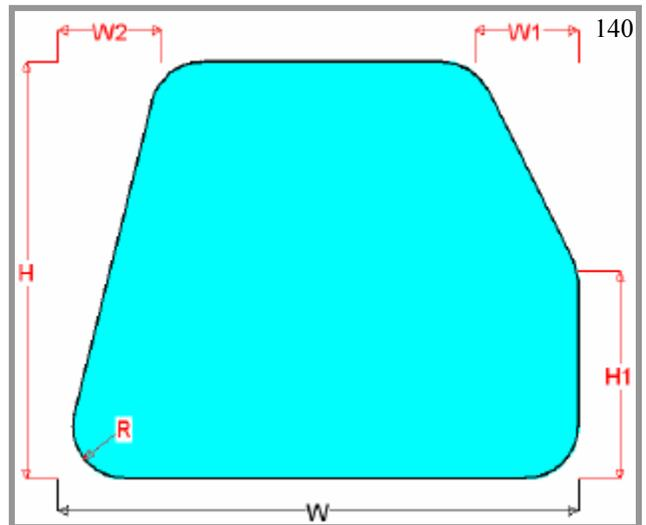
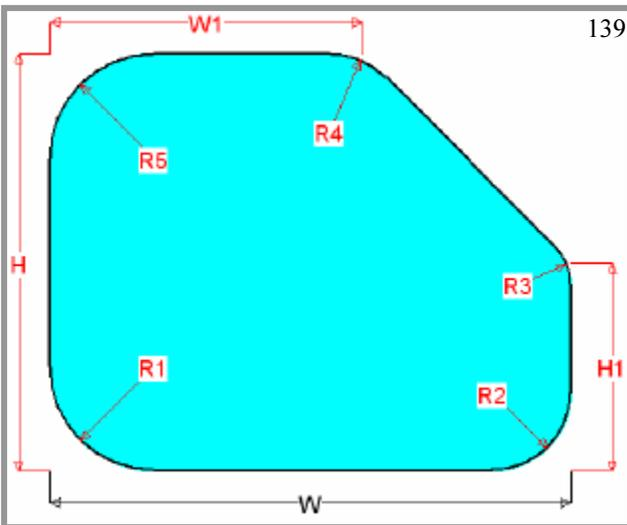
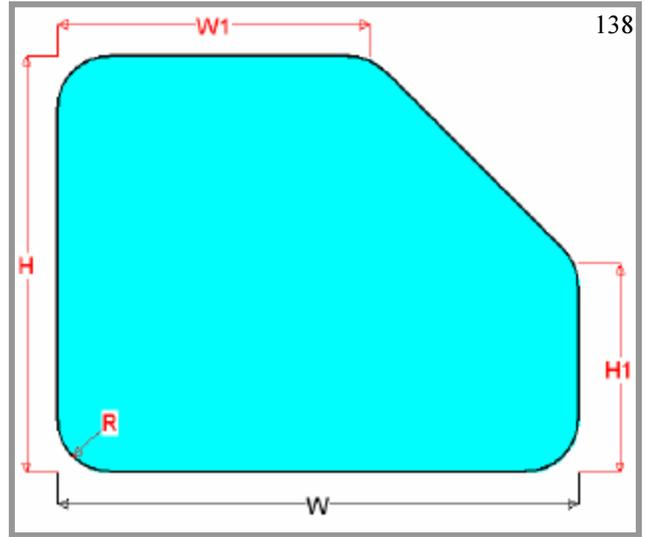
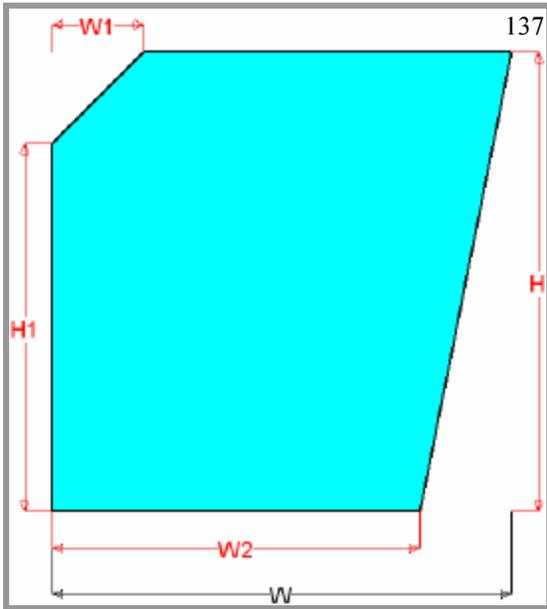

To Order Call: 1-800-277-5223

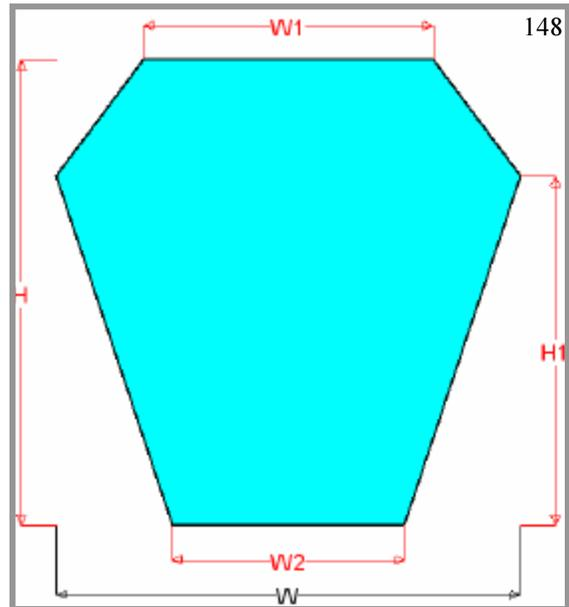
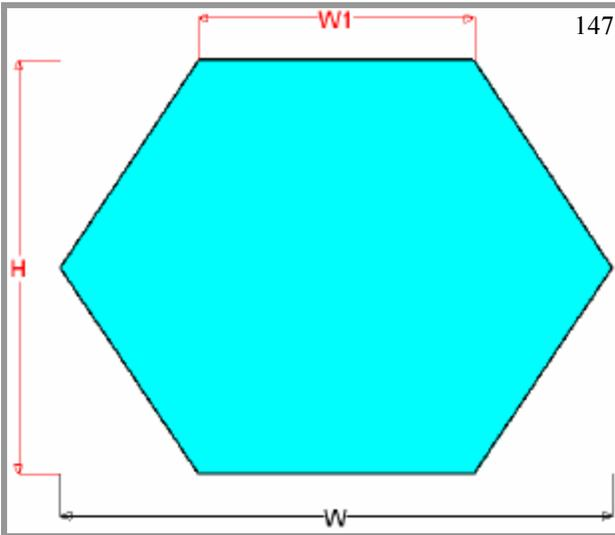
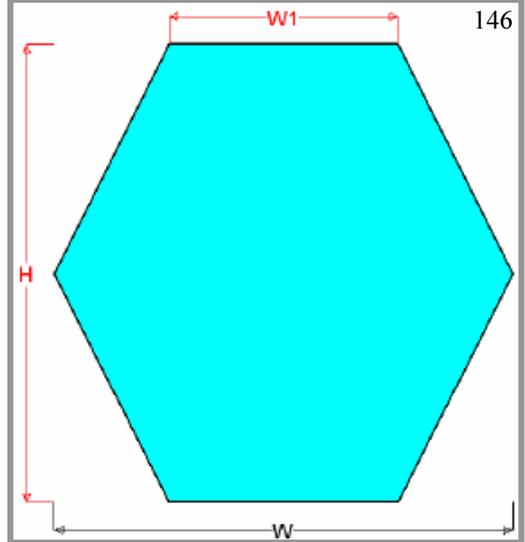
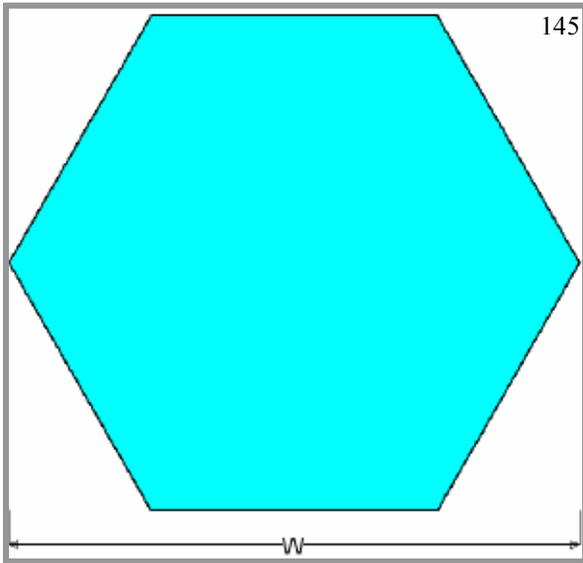
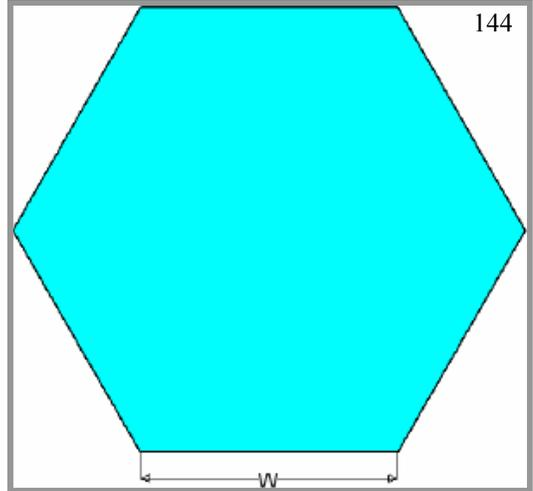
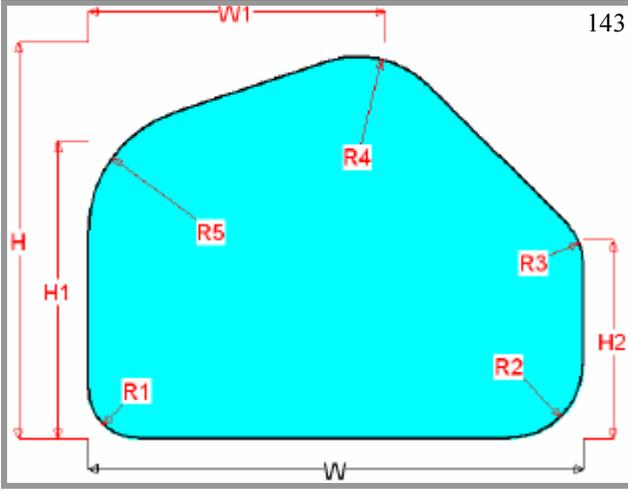

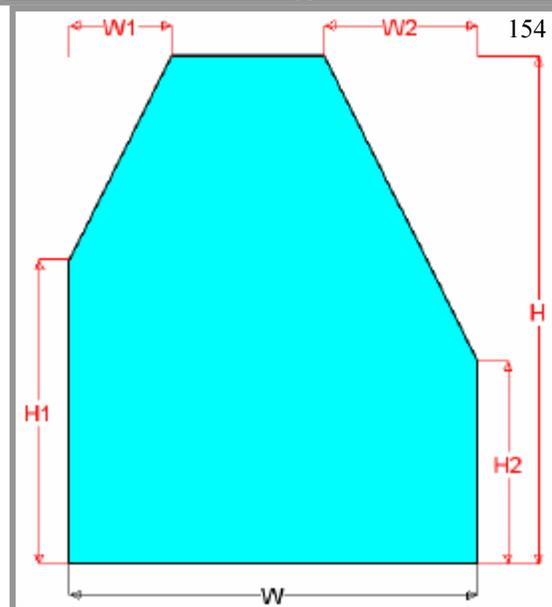
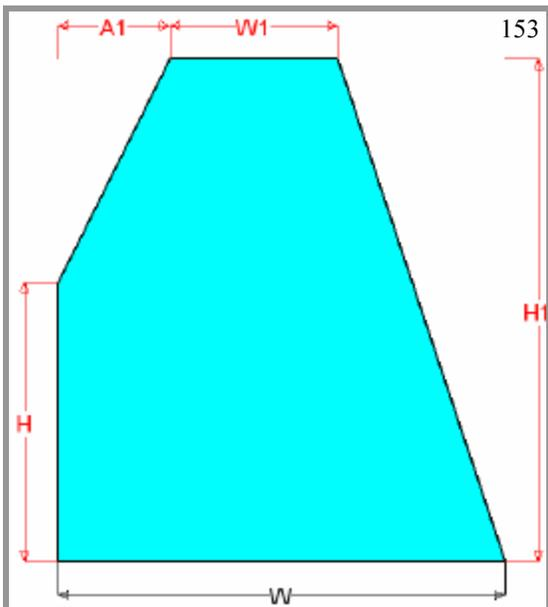
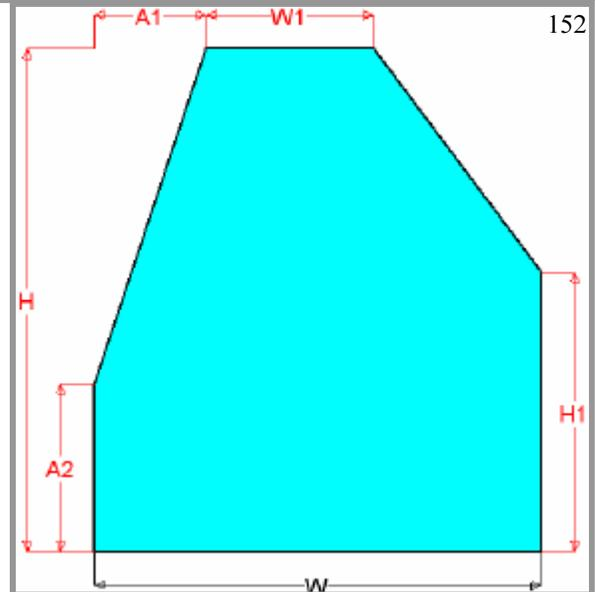
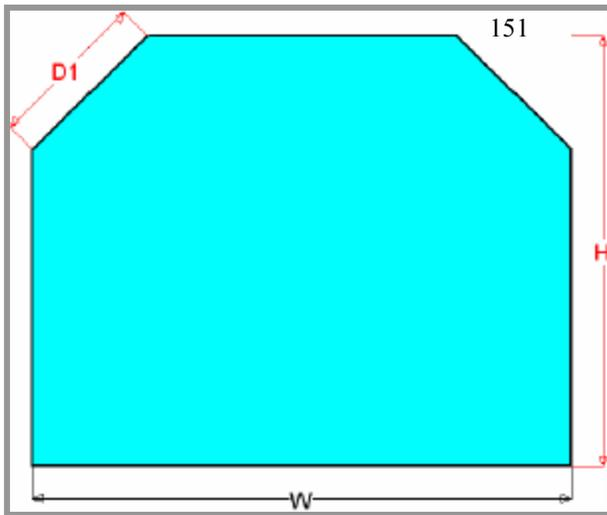
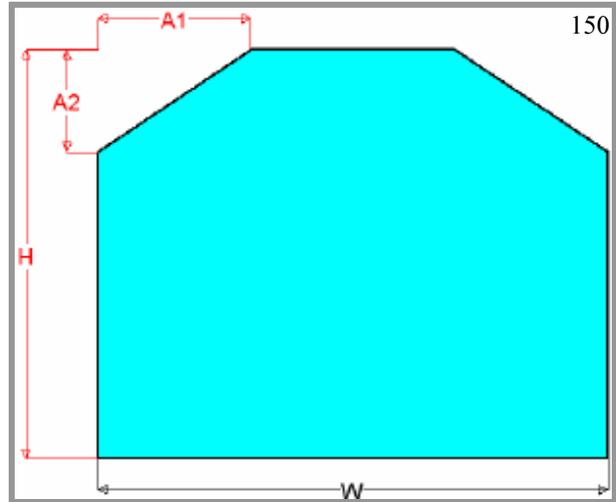
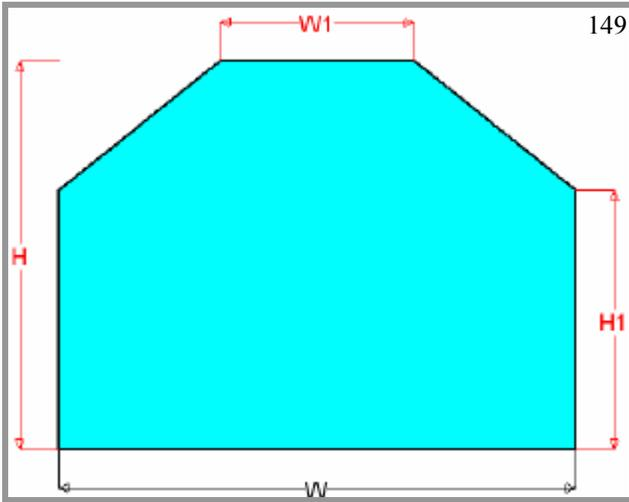

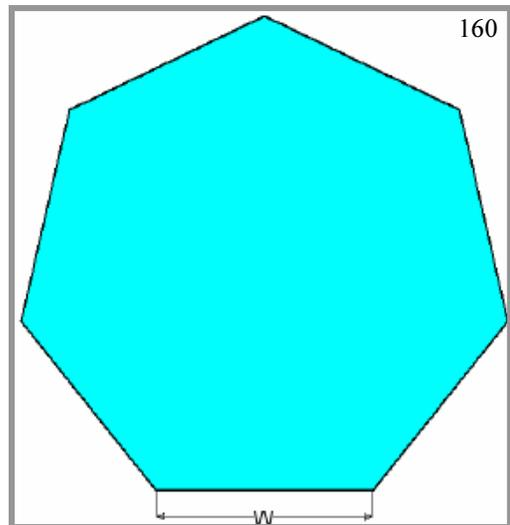
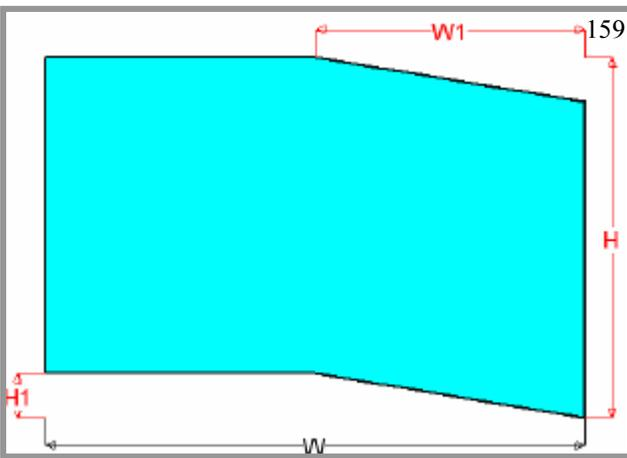
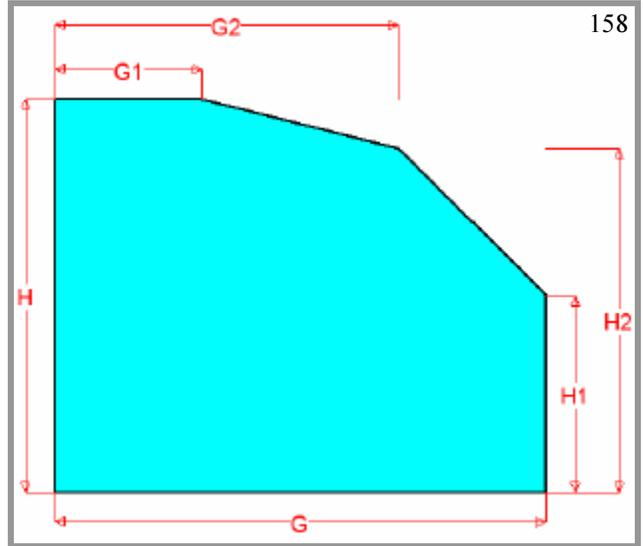
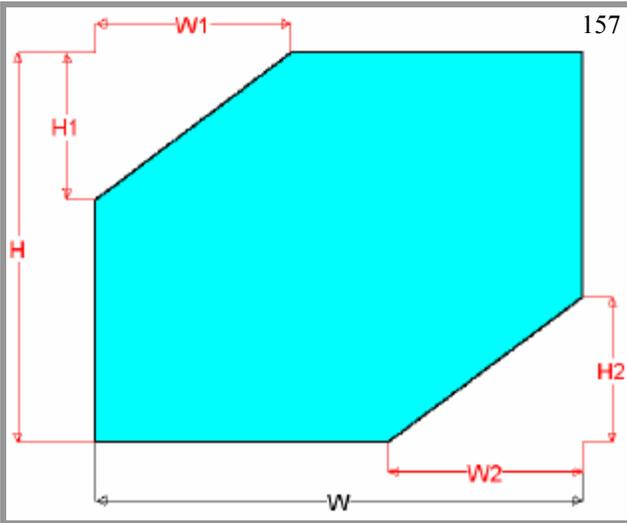
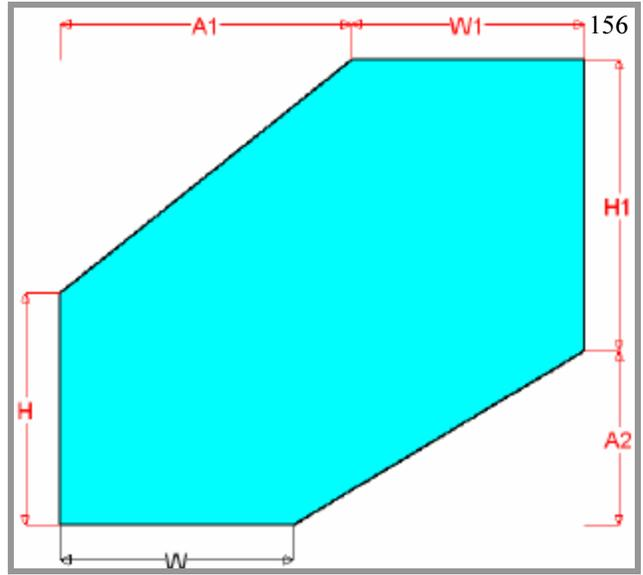
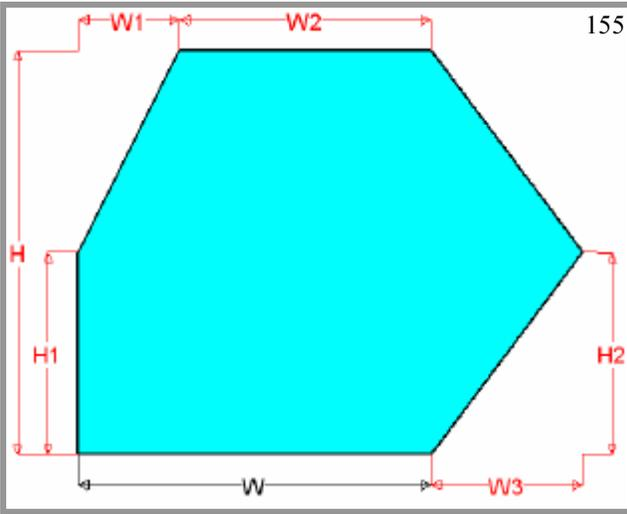

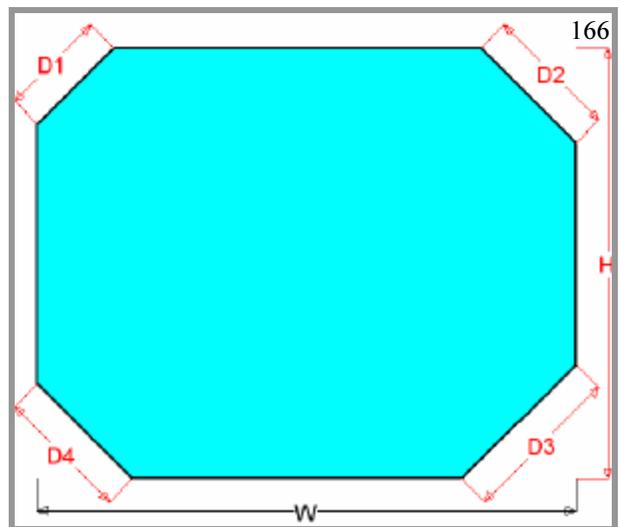
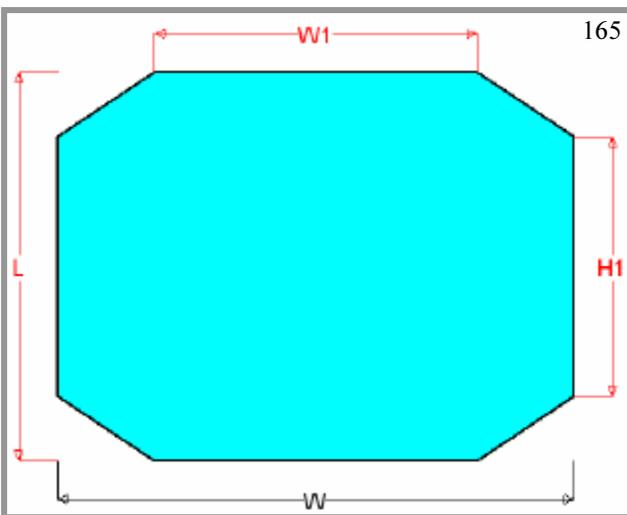
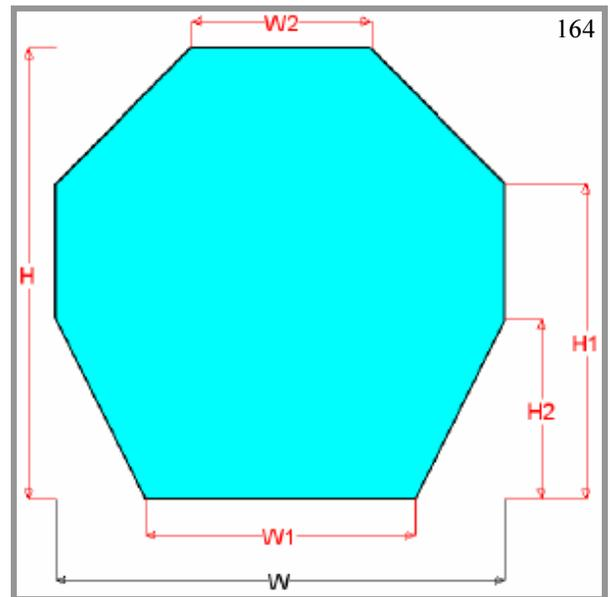
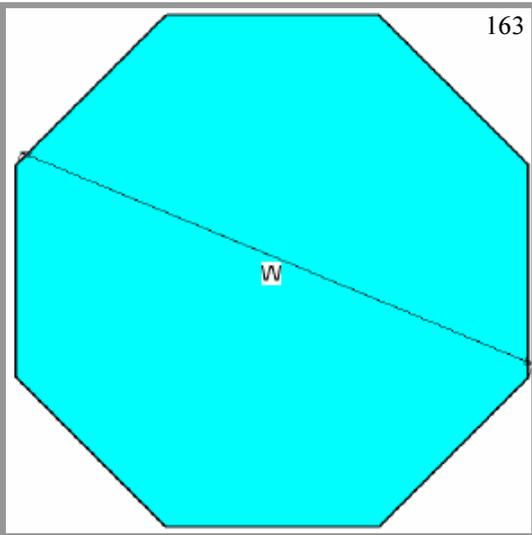
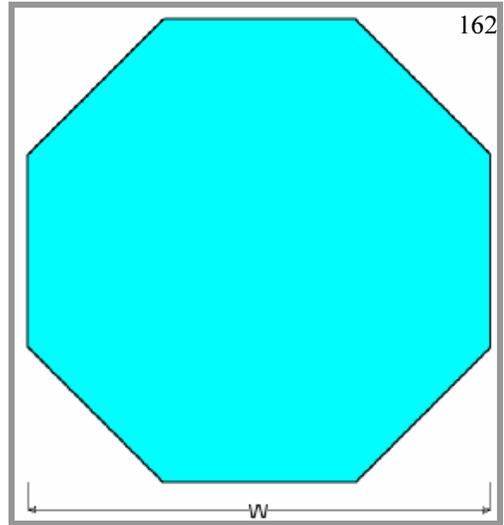
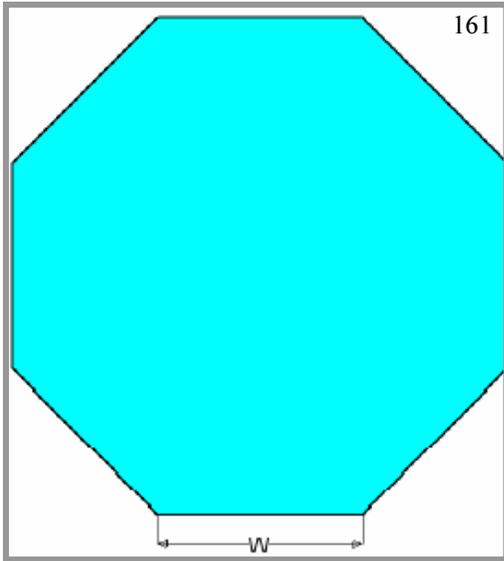

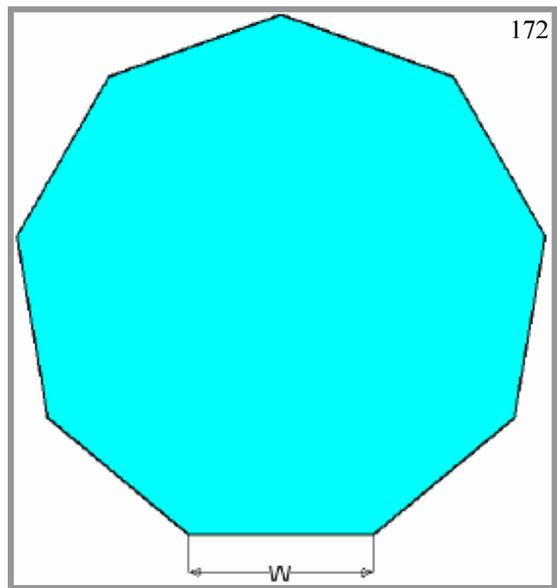
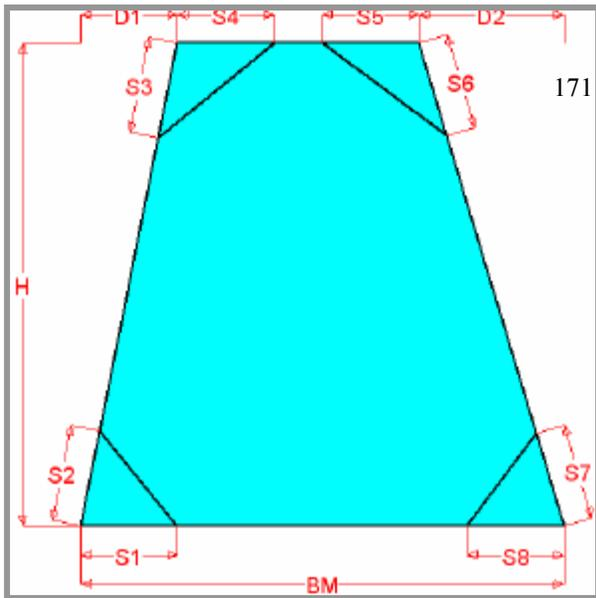
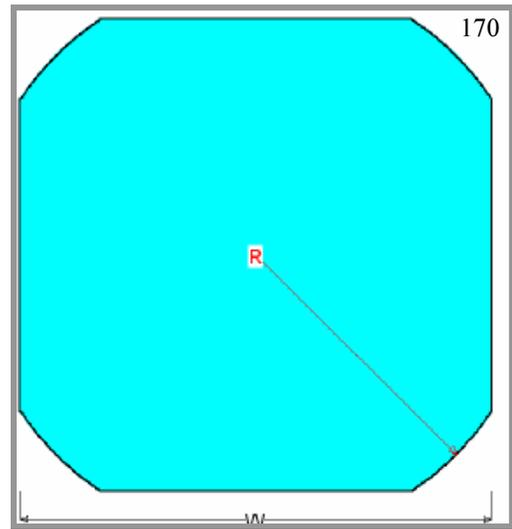
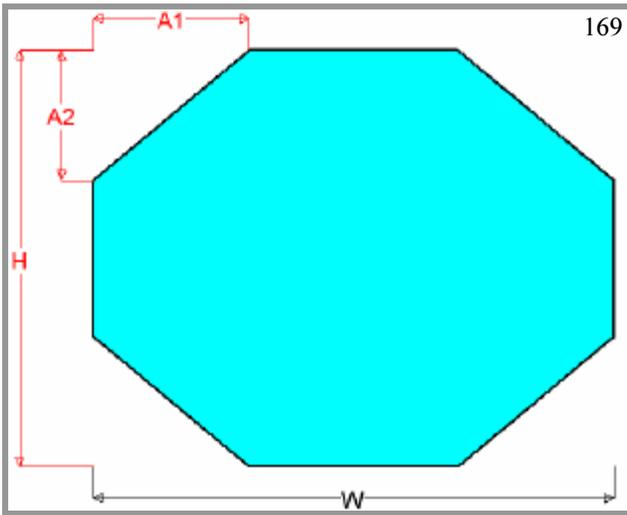
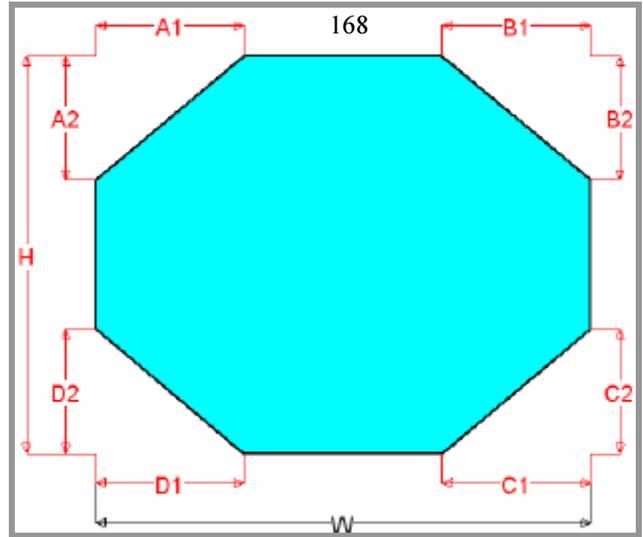
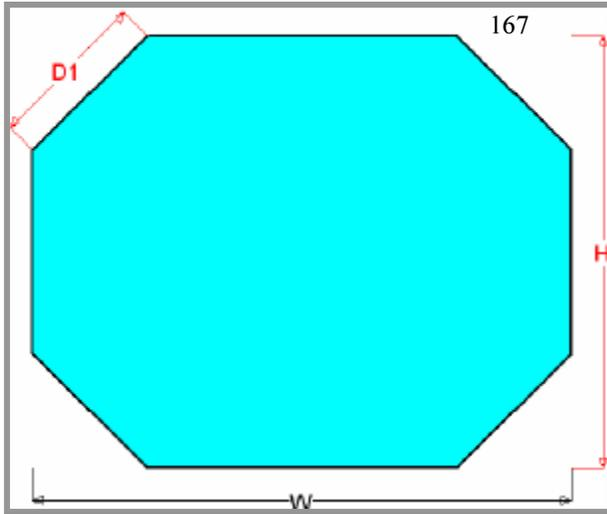

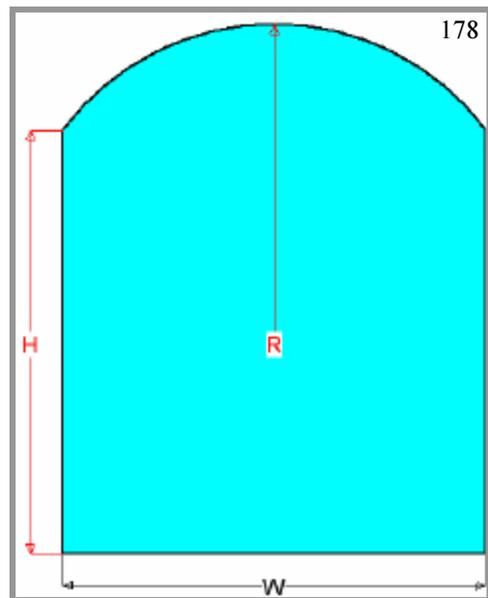
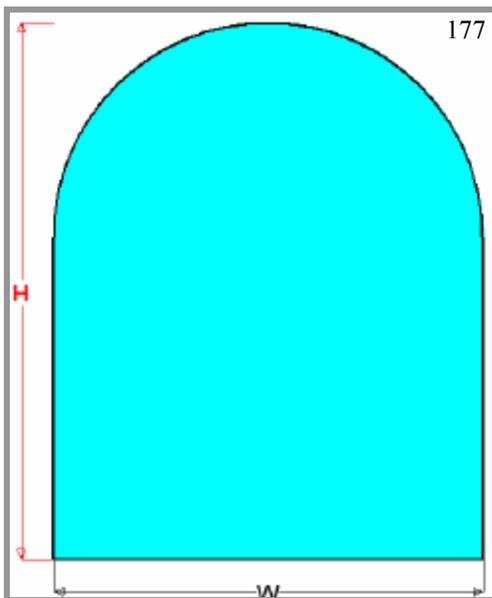
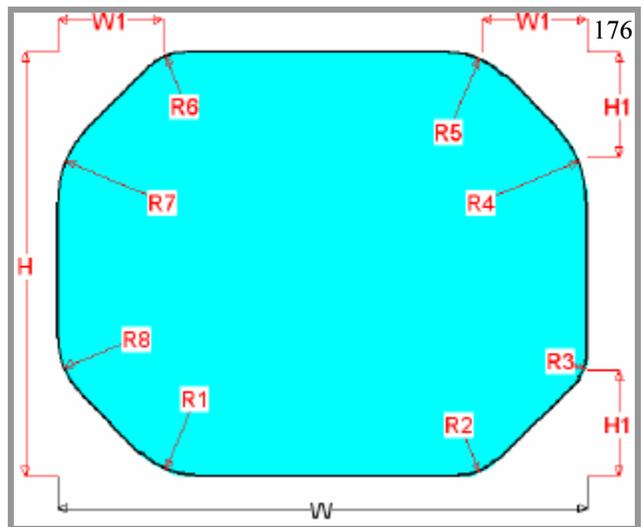
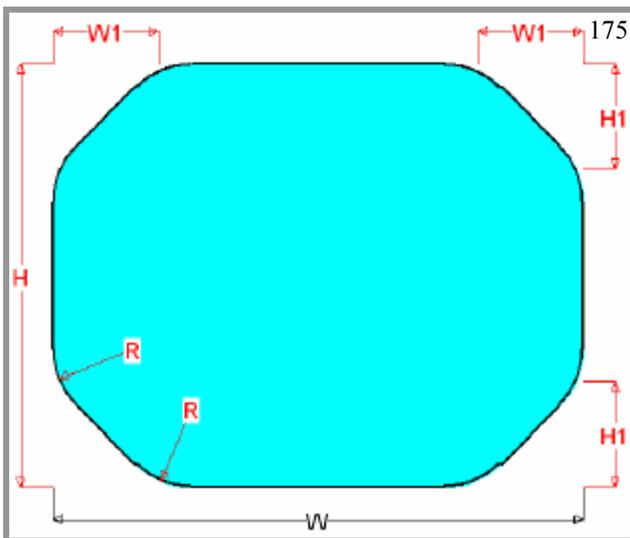
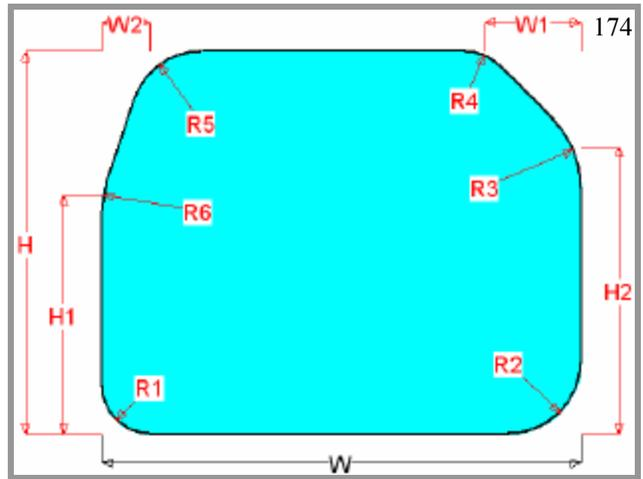
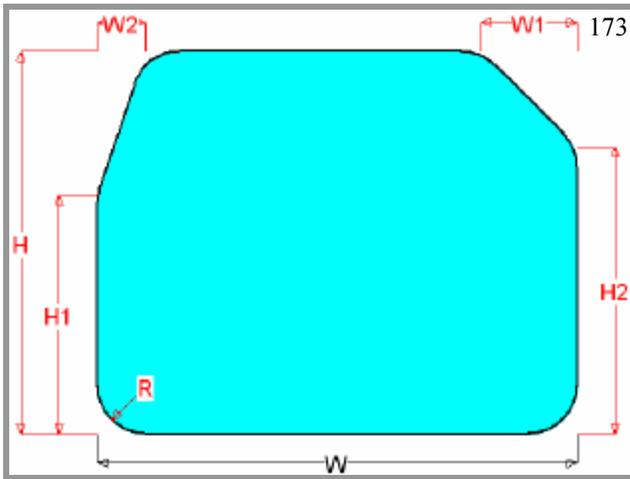

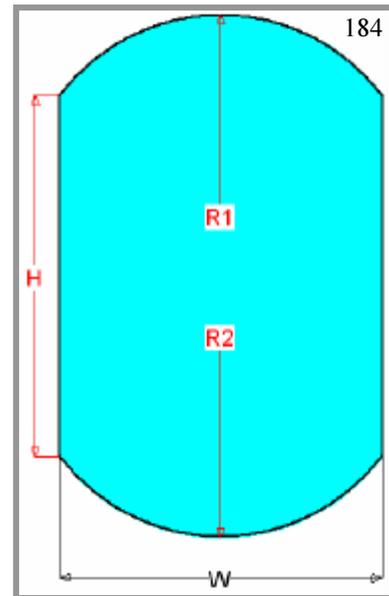
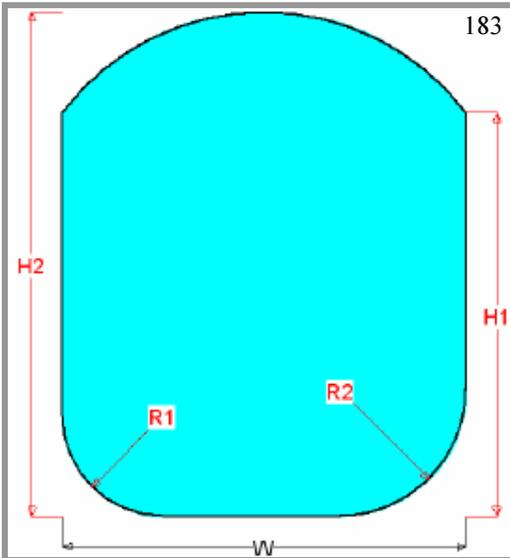
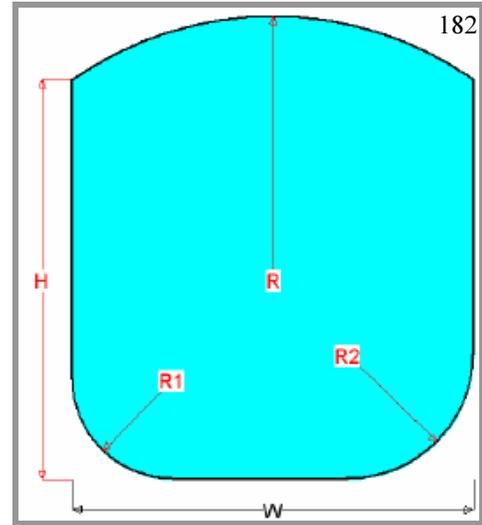
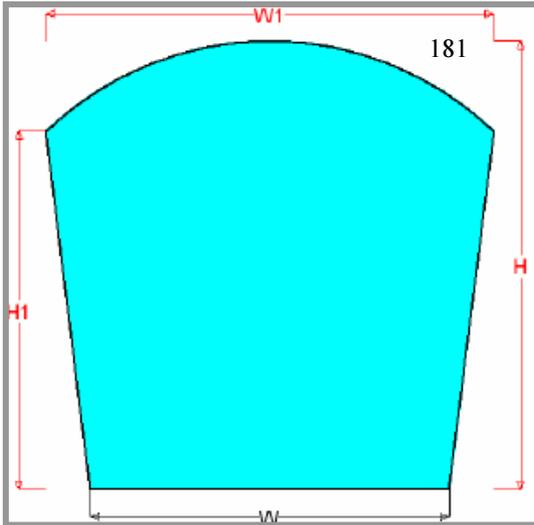
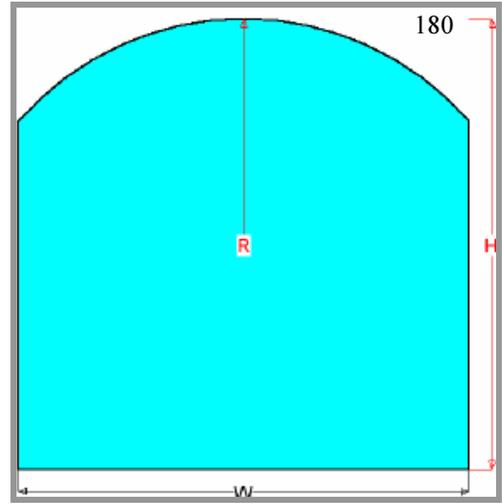
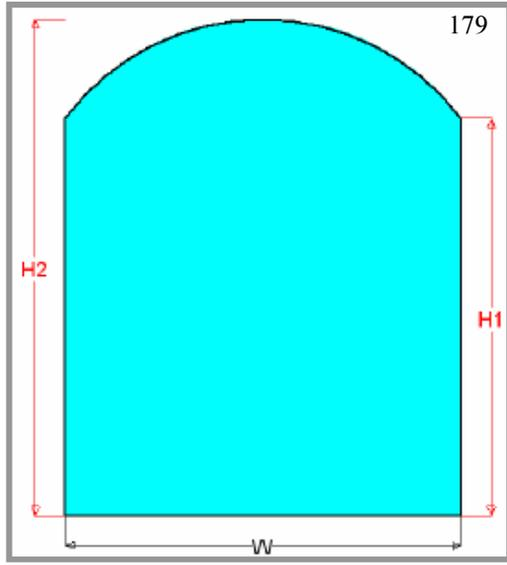

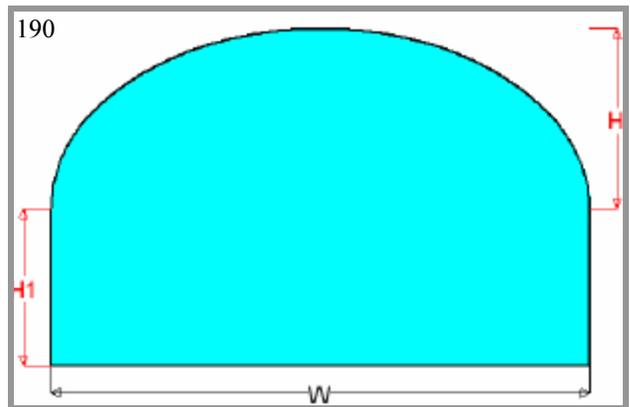
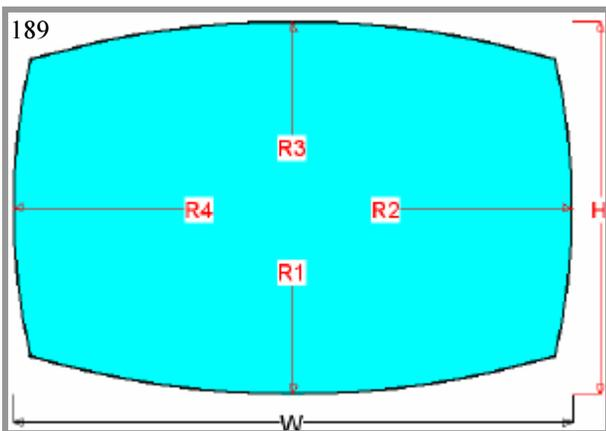
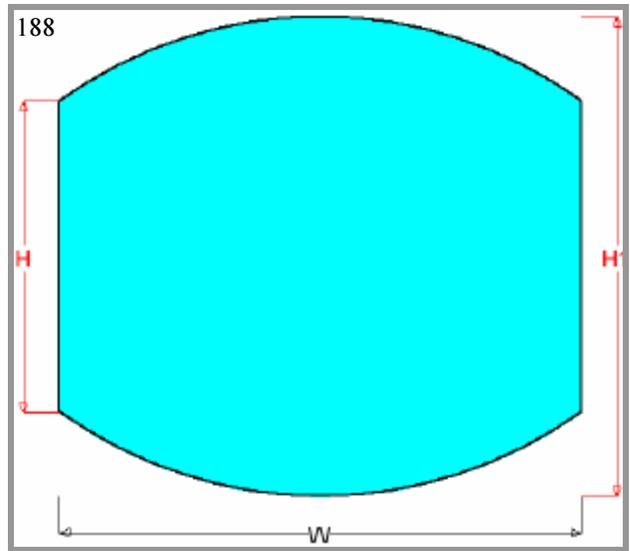
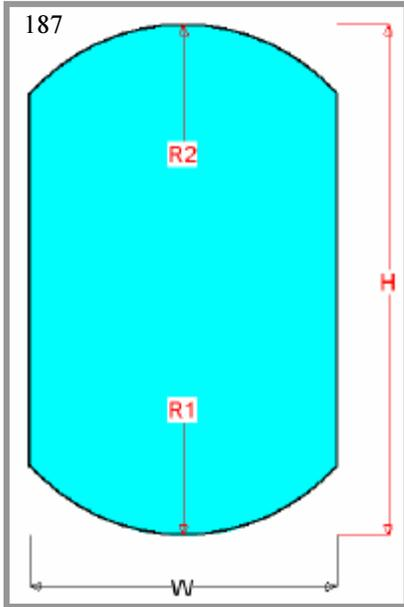
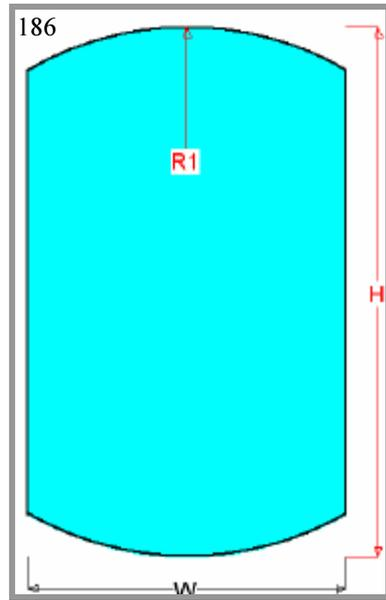
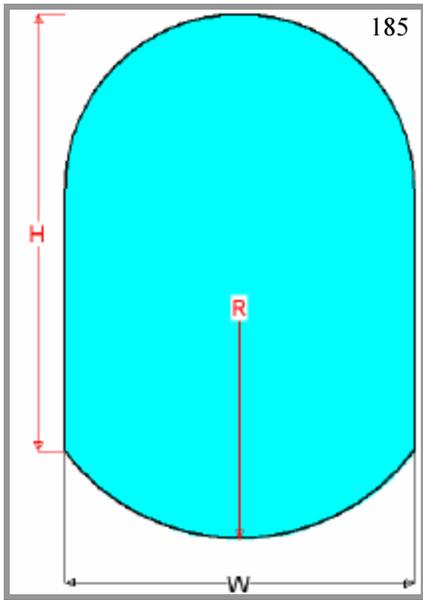

To Order Call: 1-800-277-5223

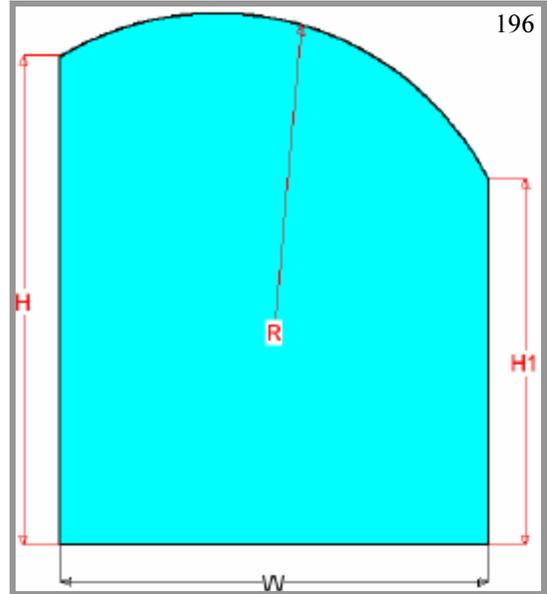
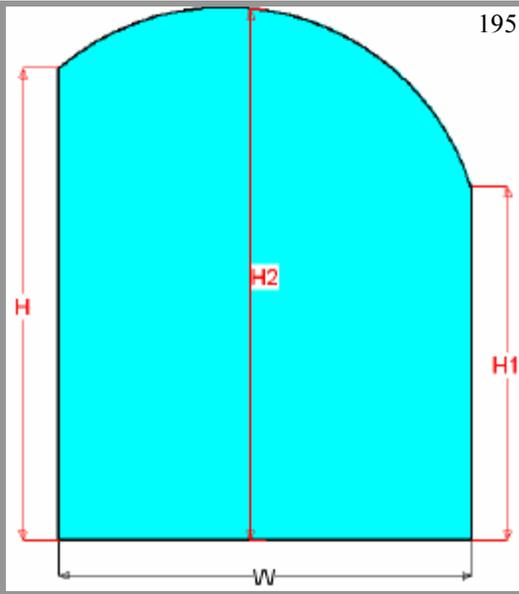
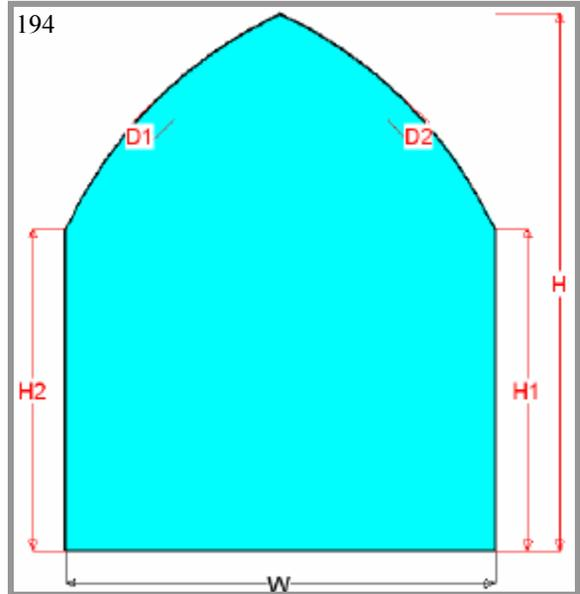
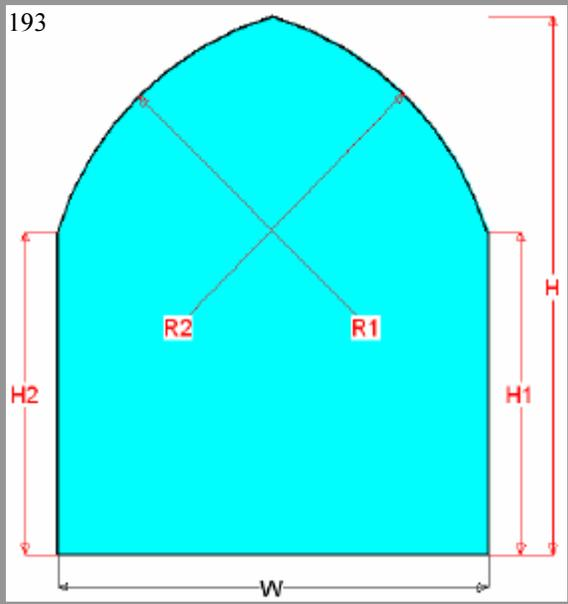
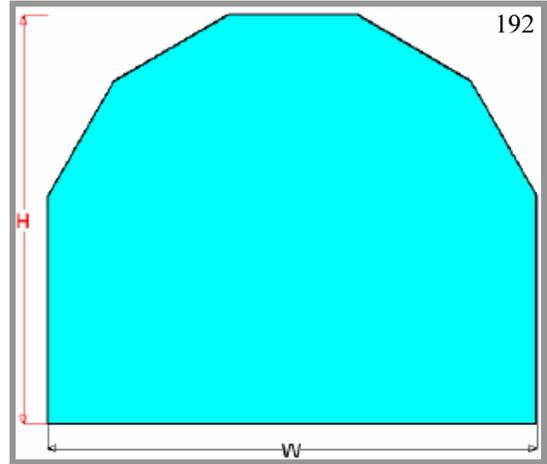
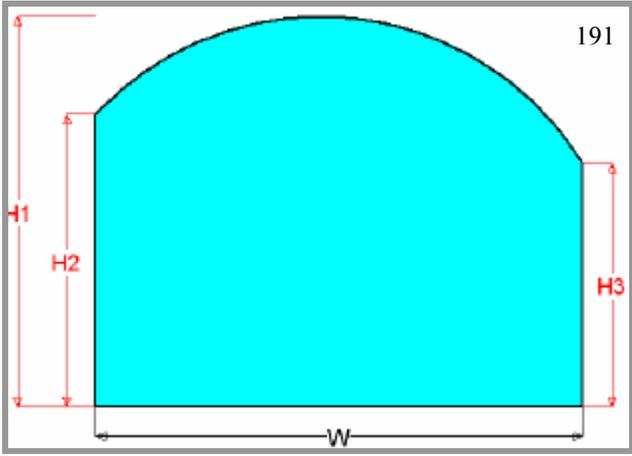

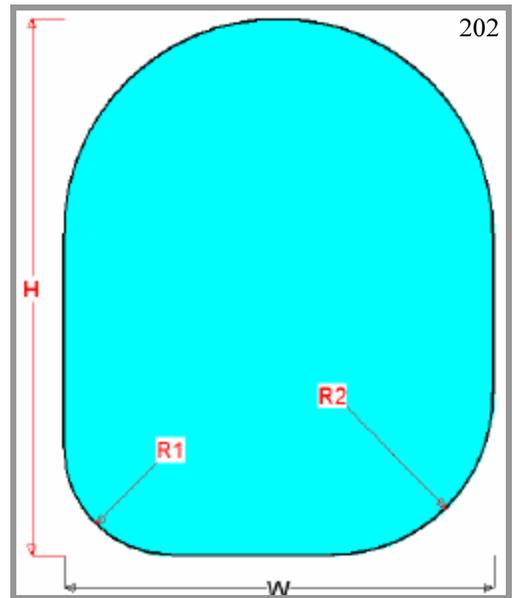
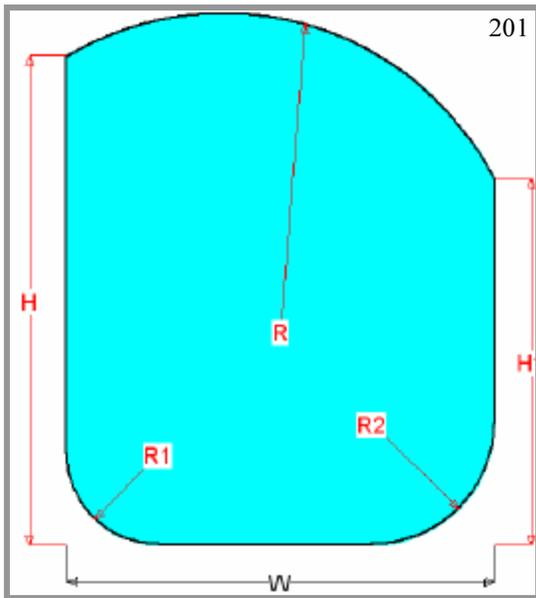
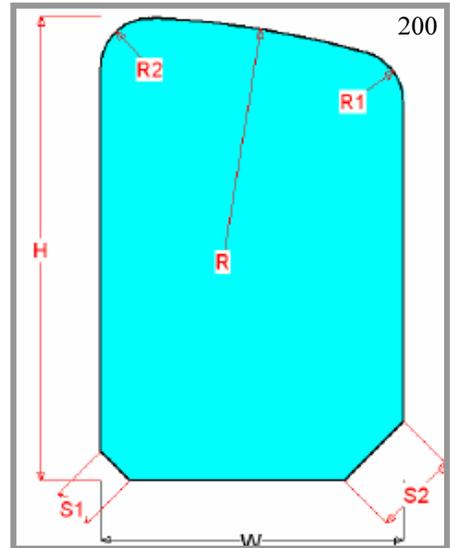
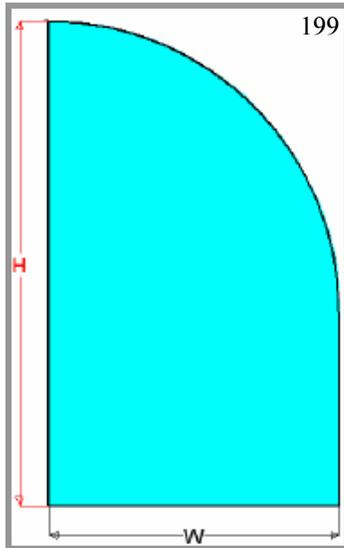
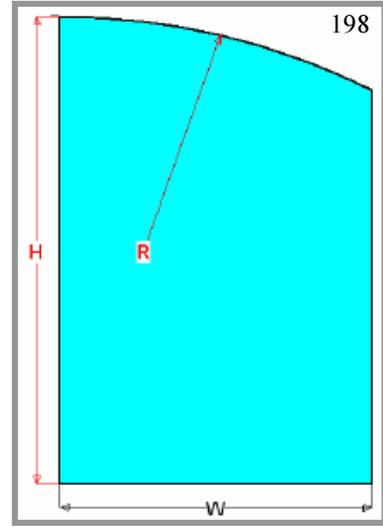
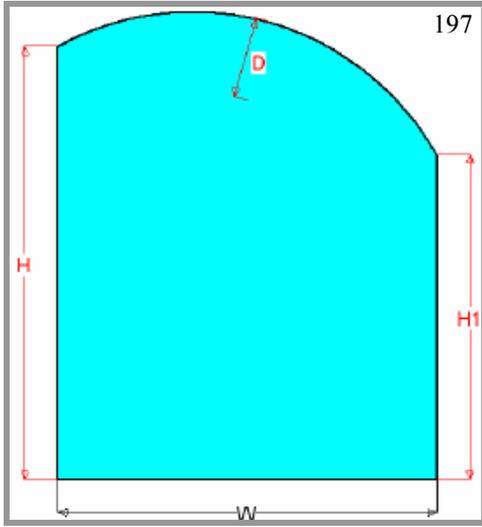

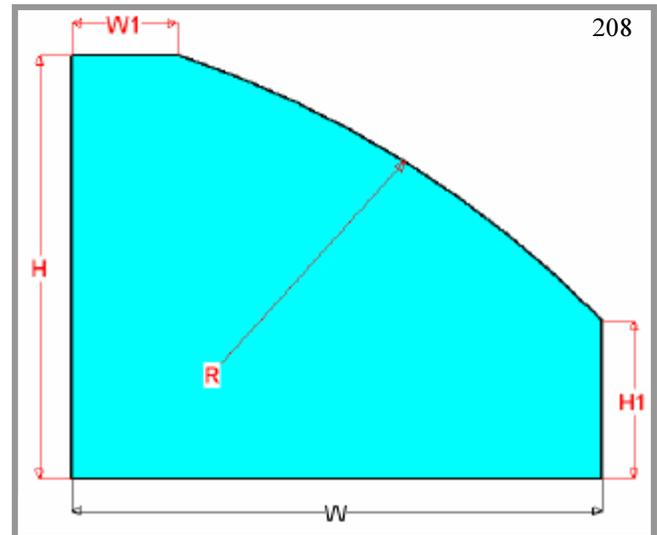
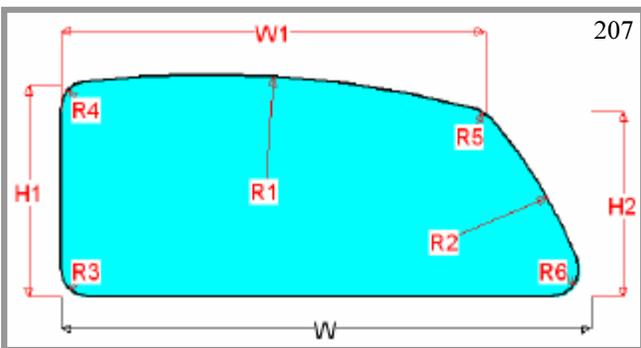
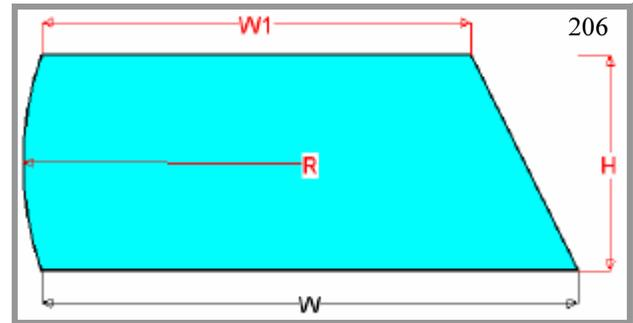
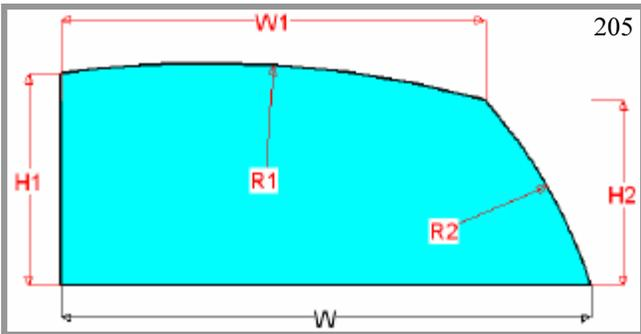
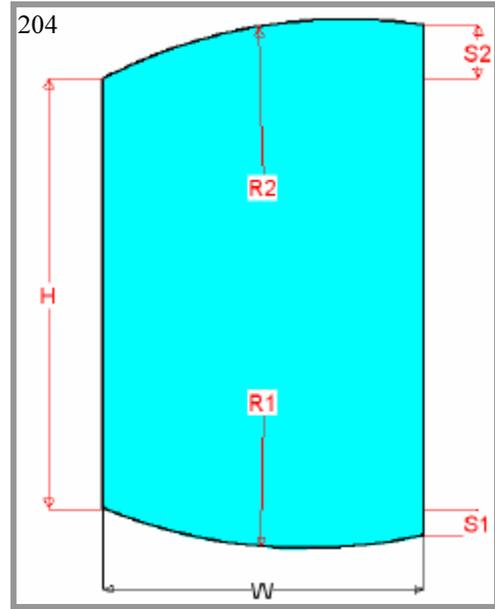
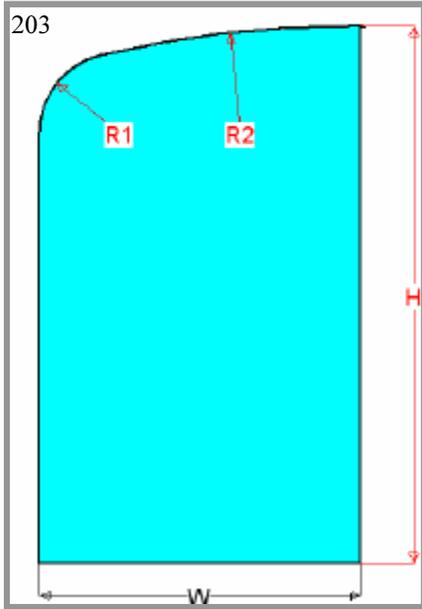

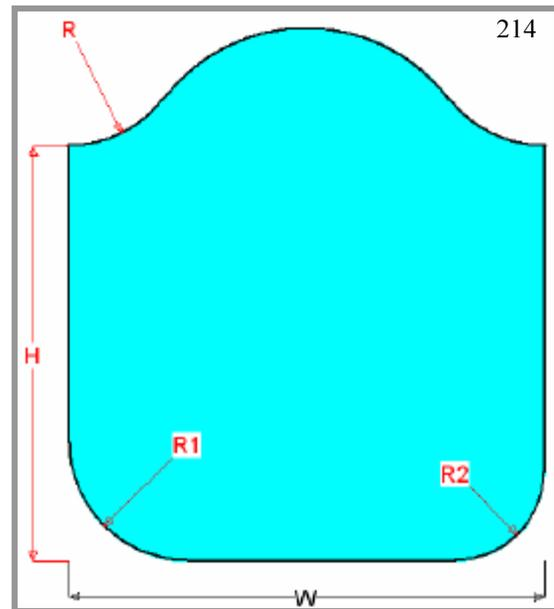
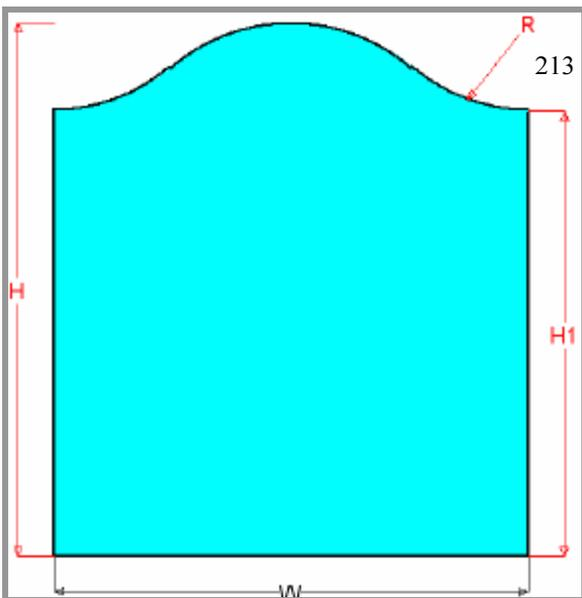
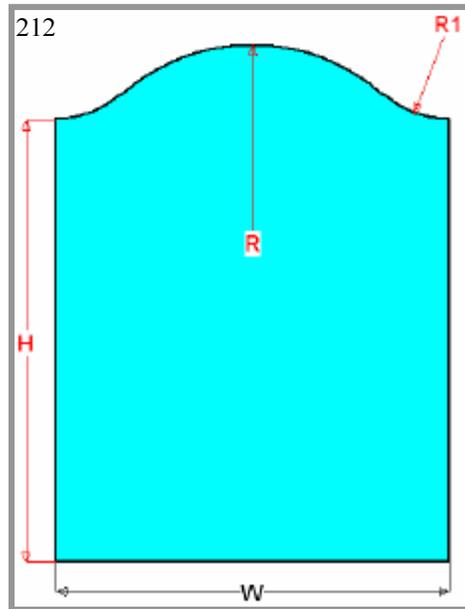
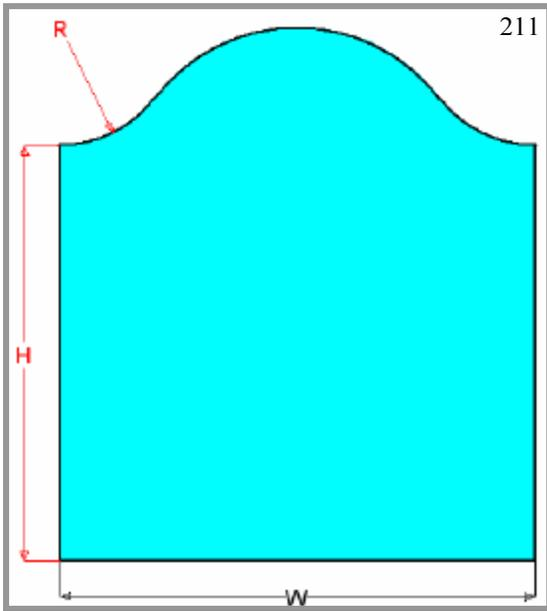
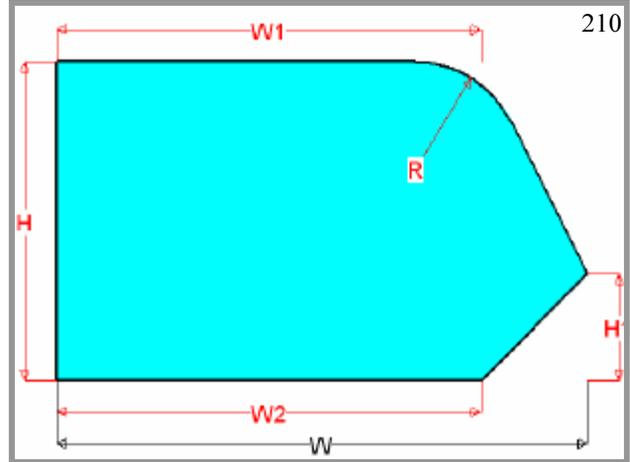
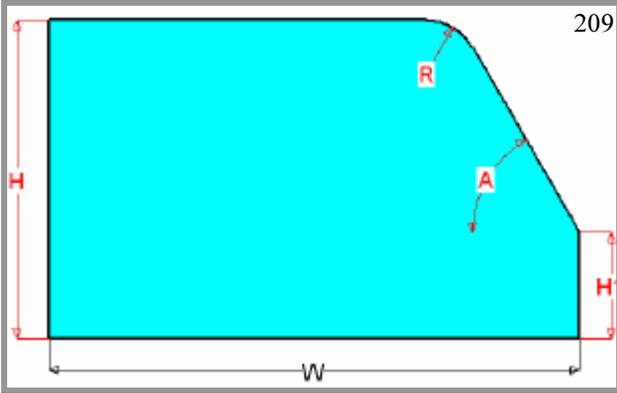

To Order Call: 1-800-277-5223

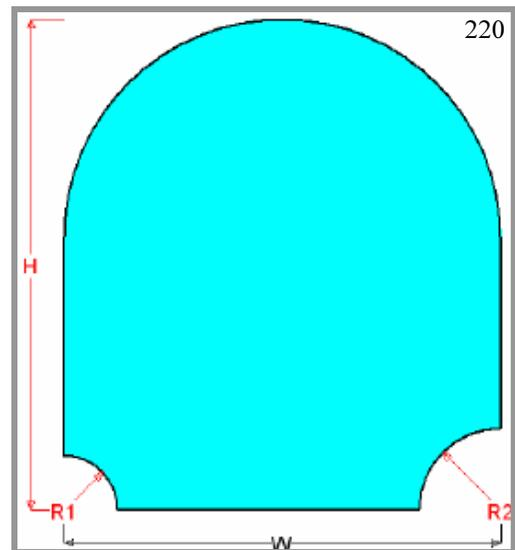
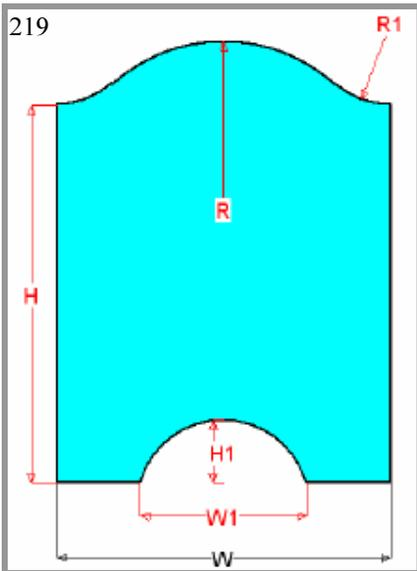
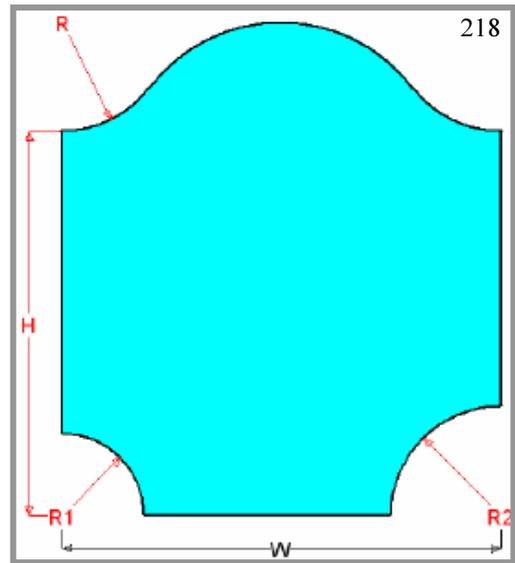
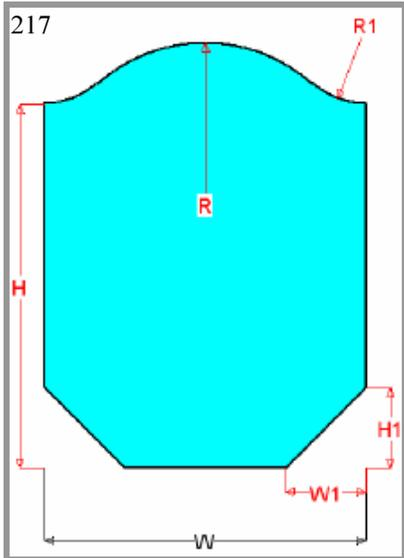
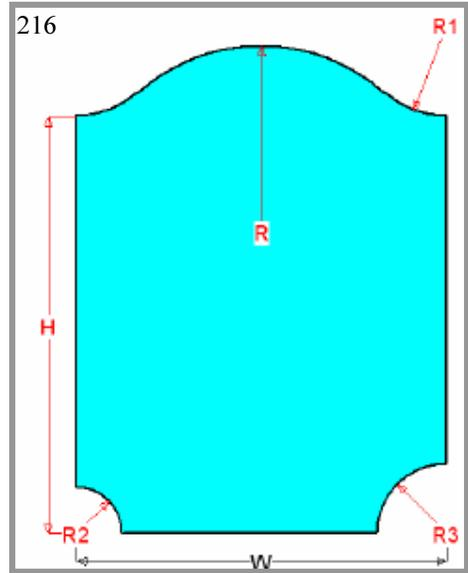
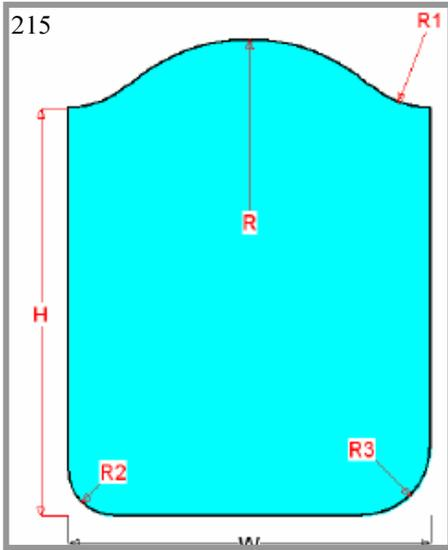

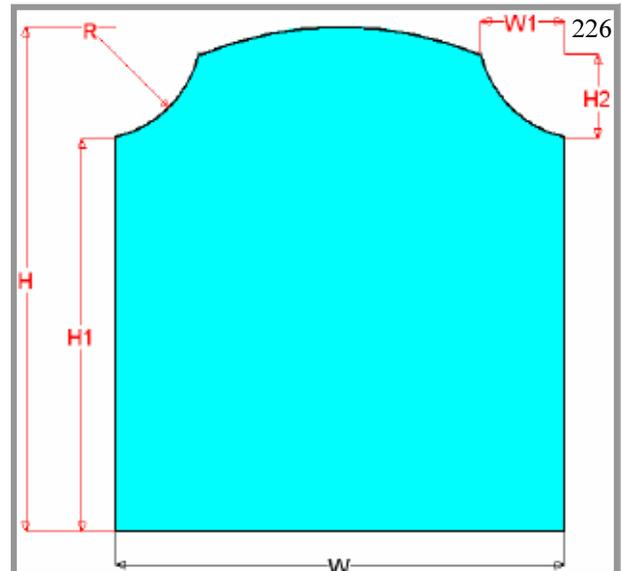
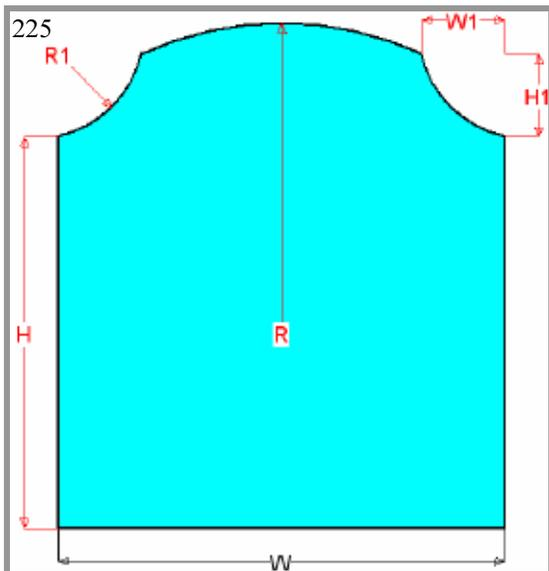
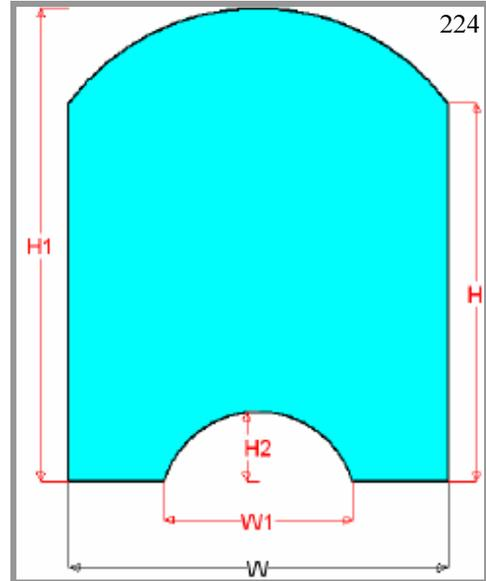
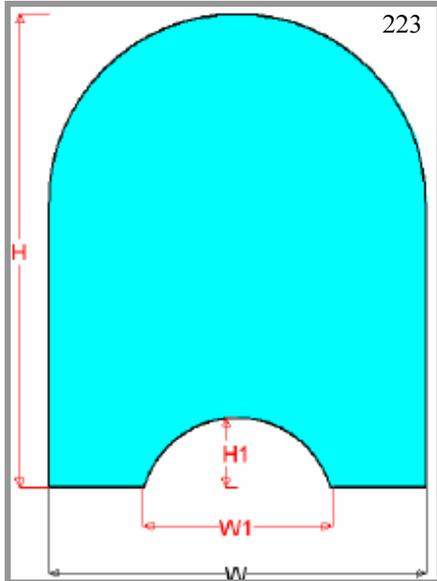
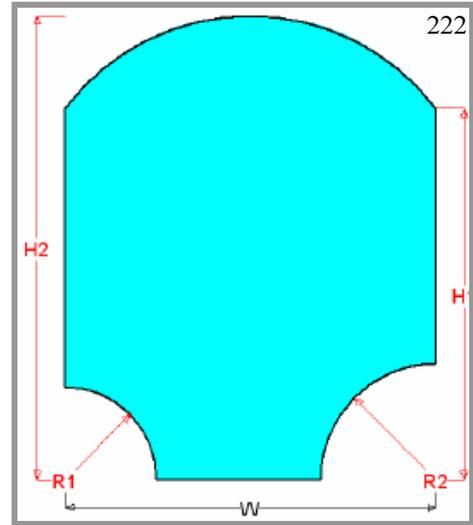
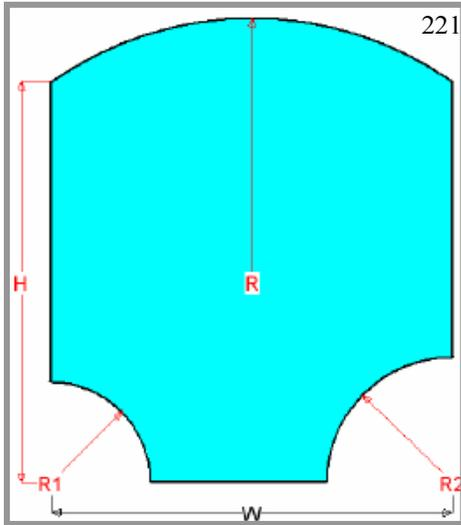

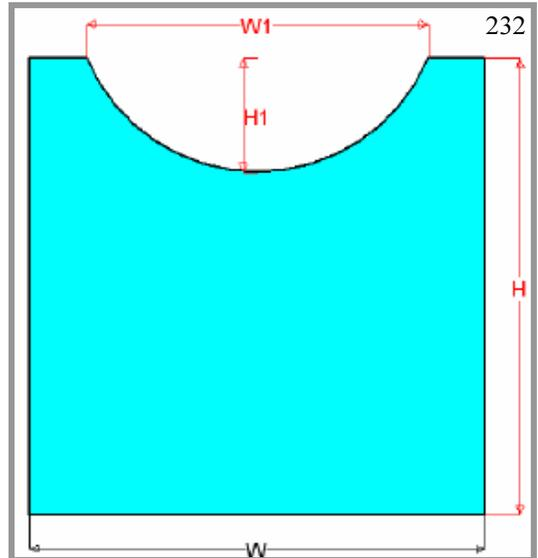
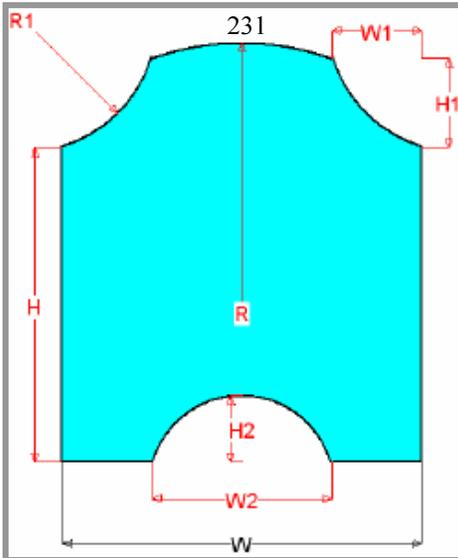
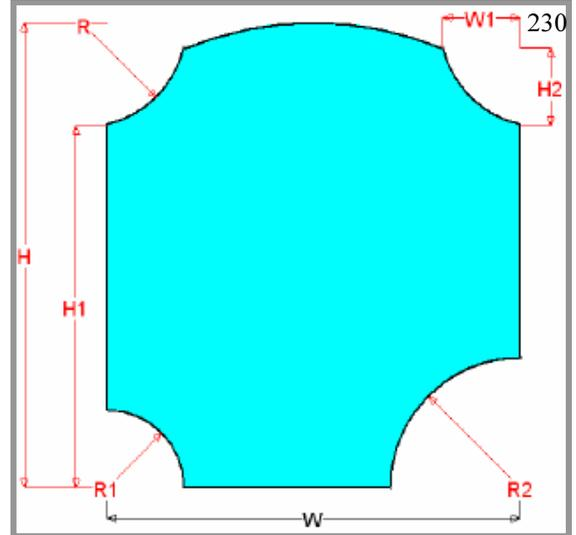
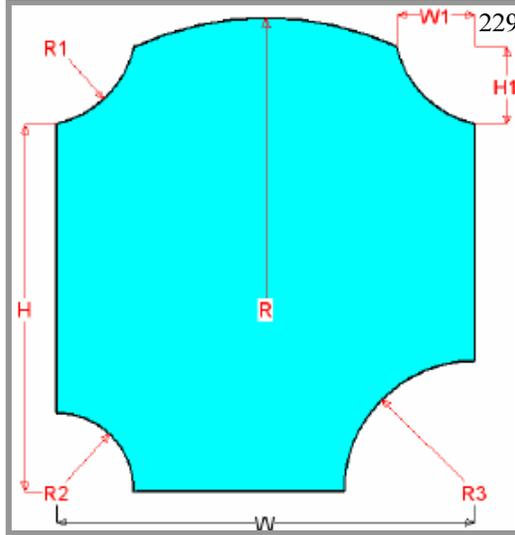
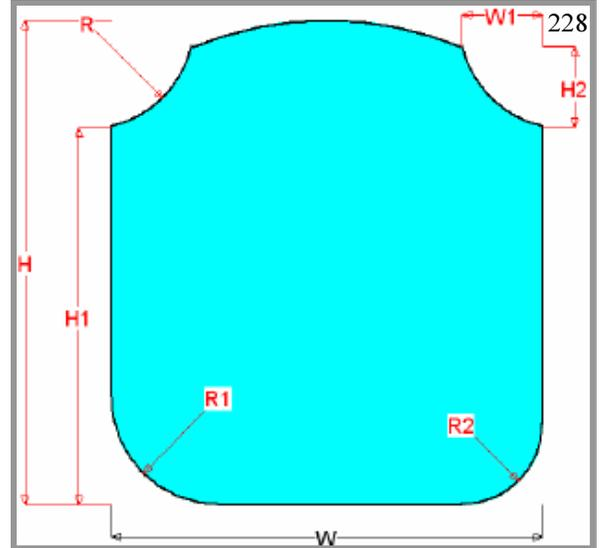
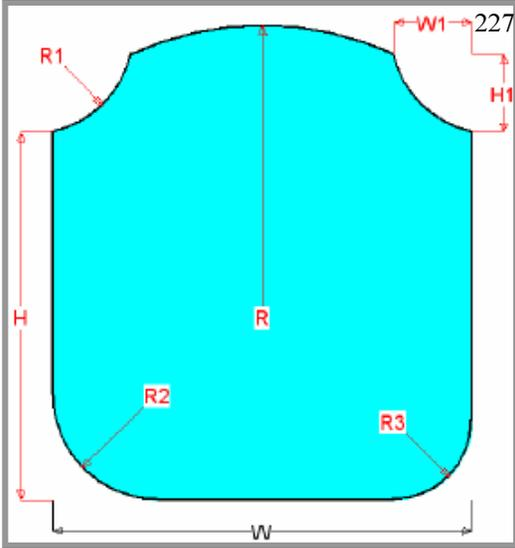

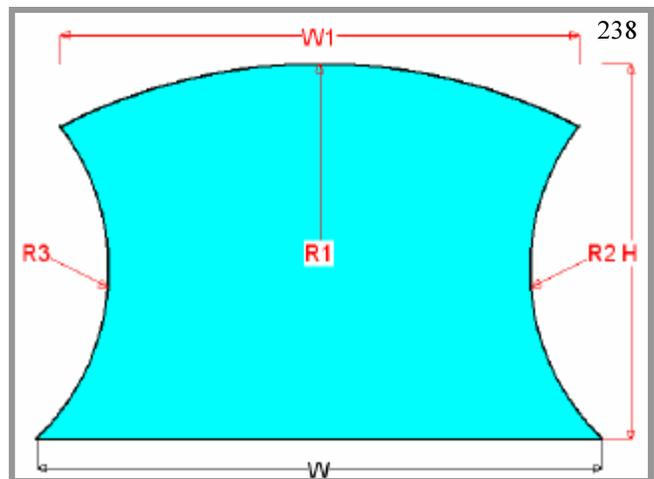
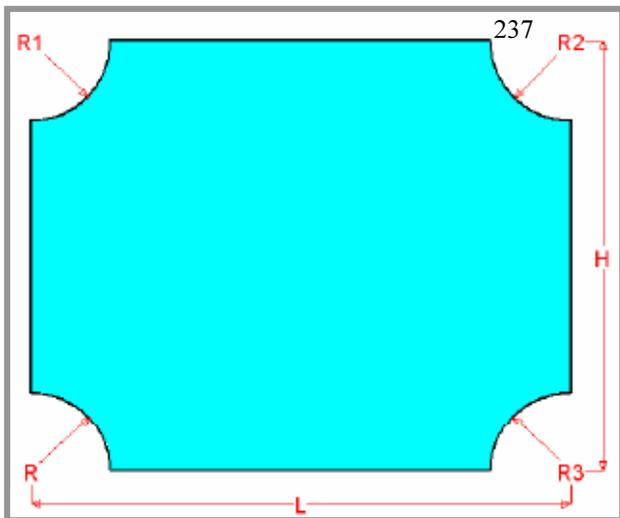
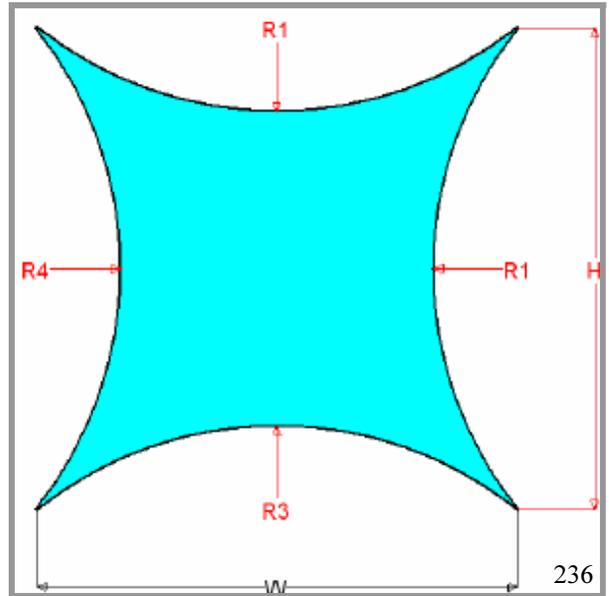
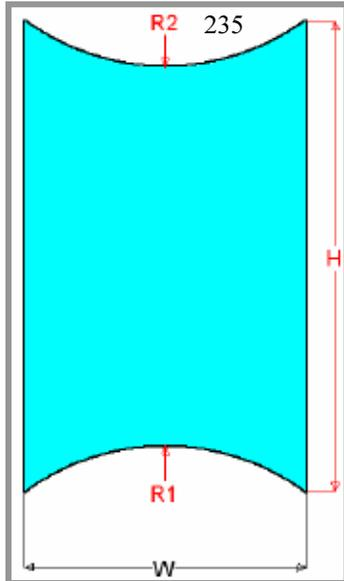
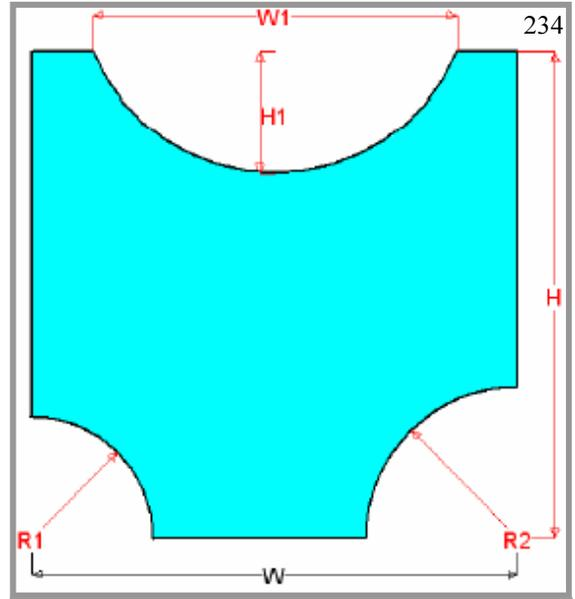
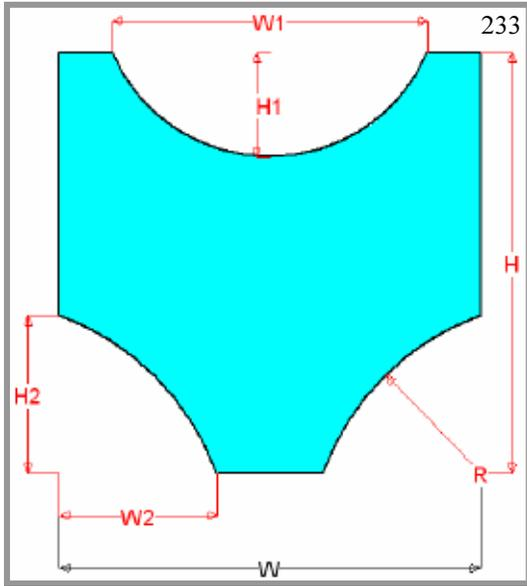

To Order Call: 1-800-277-5223

