

WIN-911 User Guide

Table of Contents

Welcome to WIN-911	1
Release Highlights for Version 4.21.5.....	2
WIN-911 Installation	3
WIN-911 4.21.5 System Requirements	3
SQL Server Requirements.....	5
Data Source (SCADA) Compatibility Matrix.....	7
Installation Path.....	7
WIN-911 System - Distributed or Standalone.....	8
WIN-911 Standalone System Setup	9
SQL Server Installation.....	13
InstallShield Wizard.....	14
Modifying WIN-911	23
WIN-911 Network Module Mapper	24
Licensing WIN-911.....	25
Create Distributed System.....	31
SQL Server Installation.....	34
InstallShield Wizard.....	35
Join Distributed System	45
SQL Server Installation.....	49
InstallShield Wizard.....	49
WIN-911 Overview.....	62
Dispatcher	64
Data Source.....	64
Notifier	65
Reporting	65
Overview of Tactics and Strategies.....	67
WIN-911 Graphical User Interface Basics	70
Connections Selector List	71
Example: Configuring an Advanced Tactic.....	75
Getting Started with WIN-911	85
Accessing the WIN-911 Configuration	85
Configure a Notification Method.....	87

Table of Contents

Configuring Escalation.....	91
Configure Data Sources	94
Mobile Gateway	100
Site Name.....	100
Username	101
Password	101
Mobile Hub	101
Validate Credentials.....	102
Online Gateway Management.....	102
Mobile Connections	104
General	104
Ack Options.....	106
Alarm Request Options	107
Utilizers.....	108
Email Gateway.....	109
Outgoing Server	109
Incoming Server	112
Email Connections.....	115
General	115
Alarm Format.....	118
Report Format.....	119
Ack Options.....	120
Alarm Request Options	121
Utilizers.....	122
Email Formats.....	123
Format	123
Utilizers.....	125
Mobile-911 Gateway.....	126
Mobile-911 Server Location	126
Mobile-911 Connections.....	128
General	128
Alarm Format.....	130
Ack Options.....	132
Alarm Request Options	133

WIN-911 User Guide

Utilizers.....	134
Mobile-911 Formats.....	135
Format.....	135
Utilizers.....	137
Mobile-911 Advanced Network Considerations	138
Mobile-911 Server Router Setup.....	139
WIN-911 Mobile Gateway Setup.....	141
WIN-911 Network Router Setup	141
Mobile-911 Server Setup.....	142
SMS Gateway	143
Gateway	143
Advanced Settings.....	147
SMS Connections.....	150
General.....	150
Alarm Format.....	152
Report Format.....	153
Ack Options.....	154
Alarm Request Options	155
Utilizers.....	156
SMS Formats	157
Format.....	157
Utilizers.....	160
Using SMS	161
Acknowledging Alarms.....	161
Requesting Alarms	162
Requesting Reports.....	163
Translations of SMS Commands.....	163
Voice Gateway	166
General.....	166
Audio.....	171
Voice Connections	173
General.....	173
Alarm Format.....	176
Report Format.....	177

Table of Contents

Speech Synthesis.....	179
Utilizers.....	181
Favorites	182
Voice Formats	185
Format	185
Utilizers.....	188
Roles	189
Roles Collection Selector List.....	189
Role Workspace Editor	190
Schedules.....	193
Notification	199
Design Basic Tactics.....	199
Design Advanced Tactics.....	199
Manage Strategies	199
Basic Tactics.....	200
Overview.....	200
Utilizers.....	202
Advanced Tactics.....	203
Overview.....	203
Blocks.....	204
Notification Blocks	207
Strategies	208
Overview.....	208
Basic Strategies and Advanced Strategies.....	210
Policy Conditions	211
Policy Actions	214
The actions which may be taken after a matching event is received are listed below.	214
Triggers	215
Alarming.....	217
OPC DA Settings	217
FactoryTalk A&E Settings	217
CIMPLICITY Settings	217
iFIX Settings.....	217

WIN-911 User Guide

InTouch Settings	217
InTouch Edge HMI Settings.....	218
System Platform Settings	218
Organize with Labels	218
OPC DA Overview.....	219
The OPC DA Conversation	220
Connecting and Reconnecting to OPC DA Servers	220
Preparing Your Computer for Remote OPC DA.....	220
Configure OPC DA Sources.....	222
Configure OPC DA Alarms.....	224
Item.....	224
Alarms.....	227
Import from OPC DA Server	230
OPC DA Source.....	230
OPC DA Item Import	231
Import Item List.....	231
Select Import Alarm Condition	233
CIMPLICITY Projects	234
CIMPLICITY Version.....	234
Project.....	234
Watchdogs.....	238
CIMPLICITY Points.....	241
Point.....	241
Conditions.....	242
iFIX Sources.....	244
Source.....	244
Health Alarms.....	247
Filters.....	248
Watchdog	251
Heartbeat (Optional)	254
iFIX Blocks.....	257
Block.....	257
Alarm States.....	259
iFIX Imports.....	261

Table of Contents

Logical Node and Attribute Selection	261
Block Selection.....	263
Import Results	264
FactoryTalk A&E Subscriptions	265
Discussion: Subscription Logic	265
Subscription	267
Utilizers.....	270
FactoryTalk Applications.....	271
Connection	271
Routes.....	274
Watchdog	275
System Platform Requirements	278
Supported Versions of System Platform	278
Configuring System Platform for WIN-911	278
System Platform Subscriptions	280
Discussion: Subscription Logic	280
Subscriptions	282
String Filters	282
Areas	284
Objects/Attributes	284
Priority Filters.....	285
Labels.....	285
Utilizers.....	285
System Platform Galaxies.....	287
Connection Details.....	287
Subscription Routes.....	289
Watchdogs.....	290
Heartbeat	294
System Platform Descriptions	297
Alarm Name	297
Condition Description.....	298
Object/Attribute Description	299
InTouch Subscriptions	300
Discussion: Subscription Logic	300

WIN-911 User Guide

Subscription	302
Utilizers.....	305
InTouch Applications	306
Application	306
Watchdogs.....	308
Subscription Routes.....	310
Heartbeat	311
InTouch Tags	314
General	315
Alarm.....	316
InTouch Import.....	319
Select Application.....	319
DBDump	319
Select Tags.....	322
Select Alarms	323
Import Progress.....	325
InTouch Runtime	326
Connecting as an Application (Default).....	326
Connecting as a Service	327
InTouch Edge HMI Overview	328
Compatibility	328
InTouch Edge HMI Terminology.....	328
Prerequisites	329
General Architecture.....	329
Establishing a Connection.....	330
Maintaining a Connection.....	331
Priority vs. Severity	331
InTouch Edge HMI Quick Start	336
Common Setup Steps	336
Subscriptions & Routes Method	338
Tags Method - Import Utility.....	340
Tags - Manual Entry.....	343
InTouch Edge HMI Alarm Acknowledgement	345
InTouch Edge HMI Subscriptions.....	346

Table of Contents

Subscriptions	347
Utilizers.....	354
InTouch Edge HMI Project.....	355
InTouch Edge HMI Health Alarm	360
InTouch Edge HMI Watchdogs.....	363
InTouch Edge HMI Subscription Routes	368
InTouch Edge HMI Import.....	370
InTouch Edge HMI Tags.....	375
InTouch Edge HMI Alarm Event Mapping.....	380
Labels.....	383
Overview.....	383
Utilizers.....	384
Reporting	386
System.....	389
Info.....	389
Standby, Activate WIN-911	389
System Info	390
Info.....	390
Standby & Activate.....	393
Standby, Activate WIN-911	393
WIN-911 Log Viewer.....	394
Alarms.....	394
AutoUpdate.....	395
Settings	395
WIN-911 Log Viewer Collection Selector List	396
Alarms View.....	397
Acknowledging Alarms with WIN-911 Log Viewer (optional - configurable).....	398
Notifications.....	405
WIN-911 and Redundancy	407
Trouble Shooting.....	409
WIN-911 Component's Operational Status.....	409
WIN-911 Diagnostic Information.....	410
Remote Standby & Activate.....	413

WIN-911 User Guide

Overview.....	413
Target.....	413
Network/Security Considerations	415
Standby.exe.....	416
Activate.exe	417
IsActive.exe	417
WIN-911 Network Module Mapper.....	419
Overview.....	419
WIN-911 Logical System Name	420
Existing Modules	420
Role Editor Utility.....	422
Install Location.....	422
Syntax	422
Arguments	423
Examples.....	424
Where to Find GUIDs	424
Accessing SQL Server	425
WIN-911 Role GUIDs.....	426
WIN-911 Connection GUIDs	426
Utility Configuration File	427
Schedule Editor Utility.....	430
Install Location.....	430
Syntax	430
Arguments	431
Examples.....	431
Where to Find GUIDs	432
Accessing SQL Server	432
WIN-911 Schedule GUIDs	433
WIN-911 Connection GUIDs	434
Utility Configuration File	435
Legal Notice.....	438

Welcome to WIN-911

WIN-911 is the most proven and advanced alarm notification software suite available for the automation industry. Capable of using a wide variety of notification methods, WIN-911 can reach you wherever you are. WIN-911 interfaces with SCADA/HMI data servers to monitor values and flag alarms. When an alarm is detected, WIN-911 will notify remotely located users by dispatching electronic messages containing vital information and allowing the recipient to respond by replying to the message with acknowledgement instructions. In addition to simple notification, WIN-911 allows users to interact with your SCADA/HMI by accepting requests for both report data and current alarm conditions.

This product is a complete rewrite of our flagship product WIN-911, using current technology and standards. This release supports Mobile, Email, Voice, SMS, and Mobile-911 messaging for remote notification delivery and subscribes as a client to any OPC DA server, Rockwell FactoryTalk Alarm & Events, GE iFIX and CIMPLICITY, Wonderware InTouch, InTouch Edge HMI, and System Platform for data monitoring and alarm reporting.

Key differences from the WIN-911 Version 7 product are:

- The configuration tool is a browser-based GUI that configures the product live during runtime from any system on the network.
- Each module has two primary components, an Application Server running in Internet Information Services (IIS), and a runtime executable running in the system's services. Hence, WIN-911 is "always on" and does not require a restart to apply configuration changes; nor is it affected by Windows users logging in and off the host computer.
- The Email notification method for WIN-911 is capable of two-way communication. Thus, a remote user will receive alarm notifications in near-real time and be able to acknowledge alarms by responding with the proper credentials. The user can also request information from WIN-911 at his/her convenience.

- Dramatic enhancements to the Schedule interface allow the user to easily create complex schedules via an calendar presentation. Schedules use appointments that can revolve around blocks of time, days of the week, weeks of the months, etc.
- WIN-911 introduces a revolutionary concept in the design and deployment of complex notification tasking: Tactics and Strategies. Alarms are associated with a single Strategy. Each Strategy controls the execution of any number of Basic or Advanced Tactics which conduct remote notification procedures.

Release Highlights for Version 4.21.5

- Added support for Windows 10, 20H2
- Added support for CIMPLICITY 11.1 and iFIX 6.5
- Added support for AVEVA InTouch 2020 R2, System Platform 2020 R2, AVEVA Edge 2020 R2
- Now distributing CodeMeter 7.20
- Restricted file and folder permissions to mitigate the reported vulnerabilities CVE-2020-13540 and CVE-2020-13539

For details, see the Release Notes on our website: www.win911.com > [Resources](#) > [Documentation](#) > [4.21.5 Release Notes](#)

1.

[Getting Started with WIN-911](#)

WIN-911 Installation

WIN-911 4.21.5 System Requirements

WIN-911 Server

- Personal Computer with dual core processor. Quad core processor is recommended.

Please note: Two physical processor cores are required. A single processor core with hyper-threading enabled will not meet the system requirements.

- 4 GB of RAM or more. Additional RAM is recommended if additional programs are to be run simultaneously.
- 4 GB of hard disk space.
- Compatible OS environment - one of the following (64-bit OS) with all Windows updates applied:

Please note: Since Microsoft operating systems feature continuous updates, you should run the Windows update feature to get the most up to date software.

- Microsoft® Windows® 7 Service Pack 1
- Microsoft® Windows® 8.1
- Microsoft® Windows® 10 (1809, 1903, 1909, and 2004, 20H2), Professional Edition (or higher).
- Microsoft® Windows® Server 2008 R2, Service Pack 1, Standard Edition (or higher).
- Microsoft® Windows® Server 2012, Standard Edition (or higher).
- Microsoft® Windows® Server 2012 R2, Standard Edition (or higher).
- Microsoft® Windows® Server 2016 Standard Edition (or higher)
- Microsoft® Windows® Server 2019 Standard Edition (or higher)
- Microsoft SQL Server 2008 R2 through 2017 (Express, Standard, and Enterprise Edition) Note: SQL Server 2014 SP2 Express (required for Windows 7 and Server 2008R2) requires Microsoft .NET 3.5.
- Internet Information Services (IIS). Application Initialization will be installed for IIS 7.5 (Windows 7/2008 R2).
- Microsoft .NET 4.5 required for install (.NET 4.8 Full will be installed)

- Optional Notification Hardware and Software:

VoIP to Analog Voice Calls	<ul style="list-style-type: none"> • Grandstream UCM6202 VoIP PBX required • Dedicated analog phone line (maximum of 2 phone lines) • *** Alternative to TAPI modems anywhere analog phone lines are available *** 																					
SMS Text Messages	<ul style="list-style-type: none"> • RS-232/USB or Ethernet (network connected) Cellular Modem <p>Recommended RS-232/USB: MultiTech MTC-H5, MTC-LVW2, MTC-LAT1, MTC-LNA4</p> <p>Recommended Ethernet: MultiTech MTR-H5, MTR-LVW2, MTR-LAT1, Sierra Wireless RV50X</p> <ul style="list-style-type: none"> • Ethernet modem required for virtual environments • Cellular account with unlimited text messages recommended 																					
VoIP Calls	<ul style="list-style-type: none"> • SIP compatible VoIP Internet account or PBX • WIN-911 Recommended SIP provider for North America – SIP.US <p>Supported VoIP Providers:</p> <table border="0"> <tr> <td>Axvoice</td> <td>VoIPtalk</td> <td>SurVoIP</td> </tr> </table> <p>Supported VoIP PBX Systems</p> <table border="0"> <tr> <td>Ozeki Phone System XE</td> <td>Tribox</td> <td>Cisco Unified CM</td> </tr> <tr> <td>OpenSER</td> <td>PBXnSIP</td> <td>Cisco Call Manager Express</td> </tr> <tr> <td>Asterisk</td> <td>PBXpress</td> <td>SipX ECS</td> </tr> <tr> <td>FreeSwitch</td> <td>FreePBX</td> <td>OpenSIP</td> </tr> <tr> <td>SwyzWare</td> <td>Aasta MX-One</td> <td>Elastix</td> </tr> <tr> <td>Asterisk Now</td> <td>Kamailio</td> <td></td> </tr> </table>	Axvoice	VoIPtalk	SurVoIP	Ozeki Phone System XE	Tribox	Cisco Unified CM	OpenSER	PBXnSIP	Cisco Call Manager Express	Asterisk	PBXpress	SipX ECS	FreeSwitch	FreePBX	OpenSIP	SwyzWare	Aasta MX-One	Elastix	Asterisk Now	Kamailio	
Axvoice	VoIPtalk	SurVoIP																				
Ozeki Phone System XE	Tribox	Cisco Unified CM																				
OpenSER	PBXnSIP	Cisco Call Manager Express																				
Asterisk	PBXpress	SipX ECS																				
FreeSwitch	FreePBX	OpenSIP																				
SwyzWare	Aasta MX-One	Elastix																				
Asterisk Now	Kamailio																					
Mobile-911	<p>*** Mobile-911 will reach End of Life on December 21, 2021 ***</p> <ul style="list-style-type: none"> • Broadband always-on Internet connection • iOS, Android and Blackberry devices for the Mobile-911 app 																					
Mobile	<ul style="list-style-type: none"> • Broadband always-on Internet connection 																					

	<ul style="list-style-type: none">• iOS (12 and up) and Android devices for the Mobile app
Email	<ul style="list-style-type: none">• Email server with a DEDICATED Email account from which WIN-911 can send alarm messages and receive acknowledgement and report requests.• POP/IMAP for incoming & SMTP for outgoing messages.• Email to SMS option not supported on all carriers and devices.

WIN-911 Client

- Internet Explorer 10 and 11 for Windows
- Microsoft Silverlight 5.1.50918.0 (January 2019)

SQL Server Requirements

WIN-911 uses an SQL Server database to store its configuration data. If an SQL Server is not already on your computer then it is important to take into consideration the requirements of the different versions of SQL Server. You can opt for the WIN-911 Launcher to install SQL Server Express 2017 for you, which is good for small to medium configurations (5,000 data points or less).

Note to Windows 7 & Server 2008R2 users: SQL Server Express 2017 is not compatible with these operating systems. Therefore, you will need to install SQL Server Express 2014. This will require .NET 3.5 be installed prior to installing SQL Server Express 2014 available here:

<https://win911na.blob.core.windows.net:443/files/Products/WIN-911//4.21.5/SQL2014.zip>

For more information about specific requirements for SQL Server installation and configuration, see Microsoft documentation available online.

["https://msdn.microsoft.com/en-us/library/bb545450.aspx"](https://msdn.microsoft.com/en-us/library/bb545450.aspx)

- WIN-911 is not compatible with SQL Server 2000.
- In order to authenticate with a remote SQL Server, identical credentials must be configured on both machines, and the SQL instance must be configured with those credentials.

Option 1: Allow WIN-911 to setup SQL

If you install WIN-911 and an SQL Server instance named "WIN911" is not found, SQL Server 2017 Express can be installed by the Install Launcher. This version is suited for small configurations, up to 5,000 data points, and is ideal for a single node.

Option 2: Install higher edition of SQL Server prior to installing WIN-911

If a compatible version of SQL Server is already installed and an instance named "WIN911" is available on the network or locally, WIN-911 Launcher installation will continue without interruption. If an incompatible version (SQL Server 2000) is present, the process will be halted, and you must remove it before the installation can continue.

Option 3: Install SQL Server remotely prior to installing WIN-911

If you would like to install SQL Server Express on a different computer than the WIN-911 host, you should copy the *SQL Server Express* folder

WIN-911 User Guide

provided with the WIN-911 install to the desired computer. Ensure that the installing user is an administrator with the same credentials as WIN-911's host user. Then run the *WIN911SQL* executable located in the root of the *SQL Server Express* folder.

Note: Higher editions of SQL are also supported remotely.

Data Source (SCADA) Compatibility Matrix

WIN-911 is compatible with the following data source version:

Data Source (SCADA - HMI)	Versions
OPC DA	OPC Data Access Classic 1.0, 2.0, 3.0
InTouch®	10.1, 2012 (10.5), 2012 R2 (10.6), 2014 (11.0), 2014 R2 (11.1), 2017 Updates 1, 2, & 3, 2020, 2020 R2
InTouch Edge HMI®	8.1 SP3, SP4, 2020, 2020 R2
InTouch ME®	8.1, 8.1 SP1
InduSoft Web Studio®	8.1, 8.1 SP1, SP3, SP4
System Platform®	2012 R2 SP1, 2014 R2, 2014 R2 SP1, 2017 Updates 1, 2, & 3, 2020, 2020 R2
FactoryTalk Alarms and Events®	6.00.00, 6.10.00, 7.00.00, 8.00.00, 8.10.00, 8.20.00, 9.00.00, 10.00.01, 11.00.00
iFIX®	5.5, 5.8, 5.8 SP1, 5.8 SP2, 5.8 SP2 R2, 5.9, 6.0, 6.1, 6.5
CIMPLICITY®	10, 11, 11.2

Installation Path

WIN-911 will install files in two locations on your system, C:\inetpub\wwwroot and C:\Program Files (x86).

WIN-911 System - Distributed or Standalone

The WIN-911 System is defined as the sum-total of all the modules that make up the WIN-911 instance. These modules can be installed on a single computer as a standalone system or distributed over several computers (EG: allowing a notifier module access to the Internet from the DMZ while the rest of the system resides on the plant network). Each of these modules fall into one of three categories: support, source, and notifier modules. Each module is independently capable of performing its unique duties and yet they interactively depend on each other in order to fulfill the WIN-911 mission.

Support Modules:

- Dispatcher
- Navigation
- Reporting

Source Modules:

- InTouch
- InTouch Edge HMI
- System Platform
- CIMPLICITY
- iFIX
- FactoryTalk Alarms and Events
- OPC DA

Notifier Modules

- Mobile
- Mobile-911
- Email
- SMS
- Voice

To perform a standalone system installation, the user will be required to select at least the minimum manifest of modules that make up a

complete WIN-911 System. These include support modules, at least one source module and one notifier. When selecting a distributed WIN-911 System installation, the minimum module requirements are relaxed to allow physical distribution.

To create a distributed system, you will need to define a WIN-911 System network ([Create Distributed System](#)) and then deploy the remaining modules on each of the remote nodes that will comprise your WIN-911 System ([Join Distributed System](#)).

The following section discusses the creation of a standalone system.

WIN-911 Standalone System Setup

The WIN-911 Launcher requires .NET 4.5 (or higher). If the target machine lacks this framework, you will need to add the framework in order to commence. In Windows 8.1, this can be done through *Programs and Features > Turn Windows features on or off*. With Server operating systems use *Server Manager > Add roles and features*. Additionally, you can find an installer for the framework in the support sub folder of the installation media or online.

To install WIN-911

WIN-911 THE MOST WIDELY USED ALARM NOTIFICATION PLATFORM IN INDUSTRY AND IIoT

Welcome to the WIN-911 Setup. The following dialogs will guide you through the process of installing WIN-911. Click the 'Next' button to begin.

- Standalone System**
All WIN-911 modules will be installed on this computer.
- Create Distributed System**
Deploy WIN-911 modules across your network starting with this computer.
- Join Distributed System**
Add additional modules to an existing system.

Display Language: English



© 1993-2020, WIN-911 Software, All Rights Reserved. U.S. Pat. No. 9,535,570. WIN-911® and Mobile-911® are registered trademarks of WIN-911 Software. All other trademarks cited herein are the property of their respective owners.

Read Install Guide Next Cancel

Attention: When using a language other than English select it here.

Click **“Next”** to begin WIN-911 Setup.

The installation program checks whether or not the environment requirements are met.



The following environment requirements have not been met:

Insufficient Number of CPU/Cores (2 CPU minimum)



Enable Features

[Read Install Guide](#) Requirements have not been met. Please click 'Cancel' to abort this installation. [Cancel](#)

Such environment requirements include:

- Supported 64-bit OS
- Sufficient minimum disk space
- Sufficient minimum processors/cores
- Installing user be a member of local administrator's group

See WIN-911 4.21.5 System Requirements at the top of this document for more information.

Note: If these requirements are met, this page will not appear.

The installation program will then check for the required features.

WIN-911 THE MOST WIDELY USED ALARM NOTIFICATION PLATFORM IN INDUSTRY AND IIoT

Installation requires the following Windows Features:

- IIS Management Console disabled
- IIS Default Document disabled
- IIS HTTP Redirection disabled
- IIS Static Content disabled
- IIS Windows Authentication disabled
- IIS Basic Authentication disabled
- Internet Information Services disabled
- IIS Application Initialization disabled
- IIS ASP .NET 4.5 disabled
- .NET WCF HTTP Activation disabled

15m

Damage Report

Operator

Read Install Guide

Requirements have not been met. Click the 'Enable Features' button to continue.

Enable Features

Cancel

Feature requirements include the following:

- Microsoft .NET 4.8
- Windows Edition and Feature Set Detection
- IIS Features: Application Initialization, Basic Authentication, Windows Authentication, HTTP Redirection and ASP.NET 4.5, HTTP Activation

Any missing feature can be enabled by clicking the Enable Features button at the bottom right.

Note: If these requirements are met, this page will not appear.

SQL Server Installation

The install script will check the WIN-911 host for an SQL Server instance named "WIN911." If there is no suitable SQL Server, the following pop-up will appear:

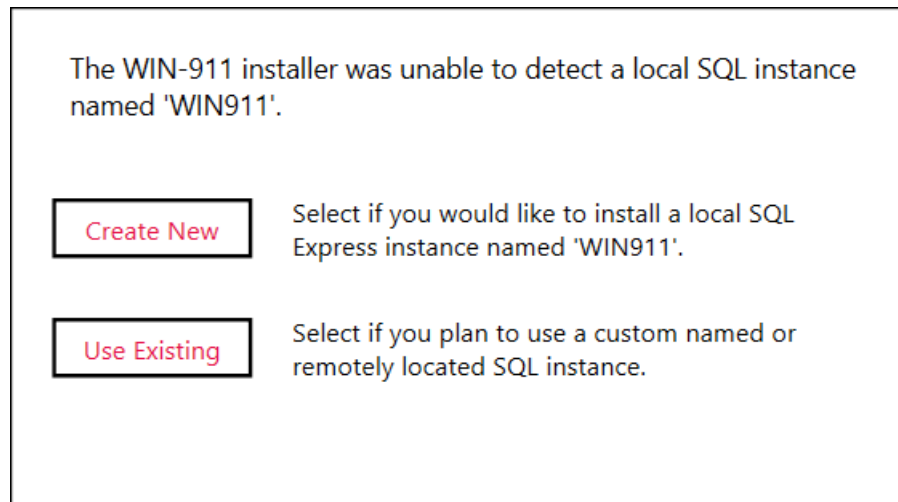

The WIN-911 installer was unable to detect a local SQL instance named 'WIN911'.

Create New Select if you would like to install a local SQL Express instance named 'WIN911'.

Use Existing Select if you plan to use a custom named or remotely located SQL instance.

This is an optional step and is not required in order to continue with the installation, but WIN-911 cannot be used until the SQL Server requirement is satisfied.

Note: if you are upgrading, you should select "Use Existing" to keep your existing data.

InstallShield Wizard

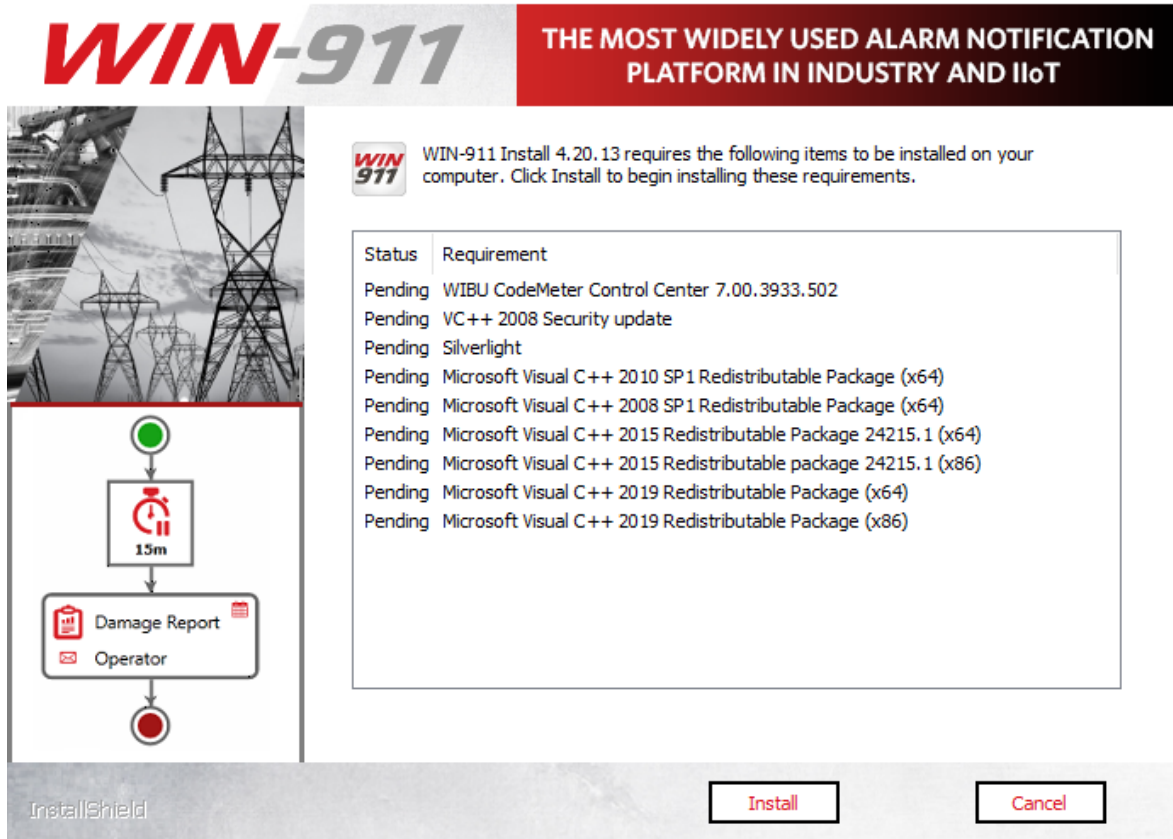

Depending on the state of .NET Framework 4.8, you may need to reboot prior to continuing.



If requested, select Yes and the install process will resume automatically once the reboot is performed.

WIN-911 User Guide

The WIN-911 InstallShield wizard will now guide you through the WIN-911 setup. Click **"Next"** to continue.

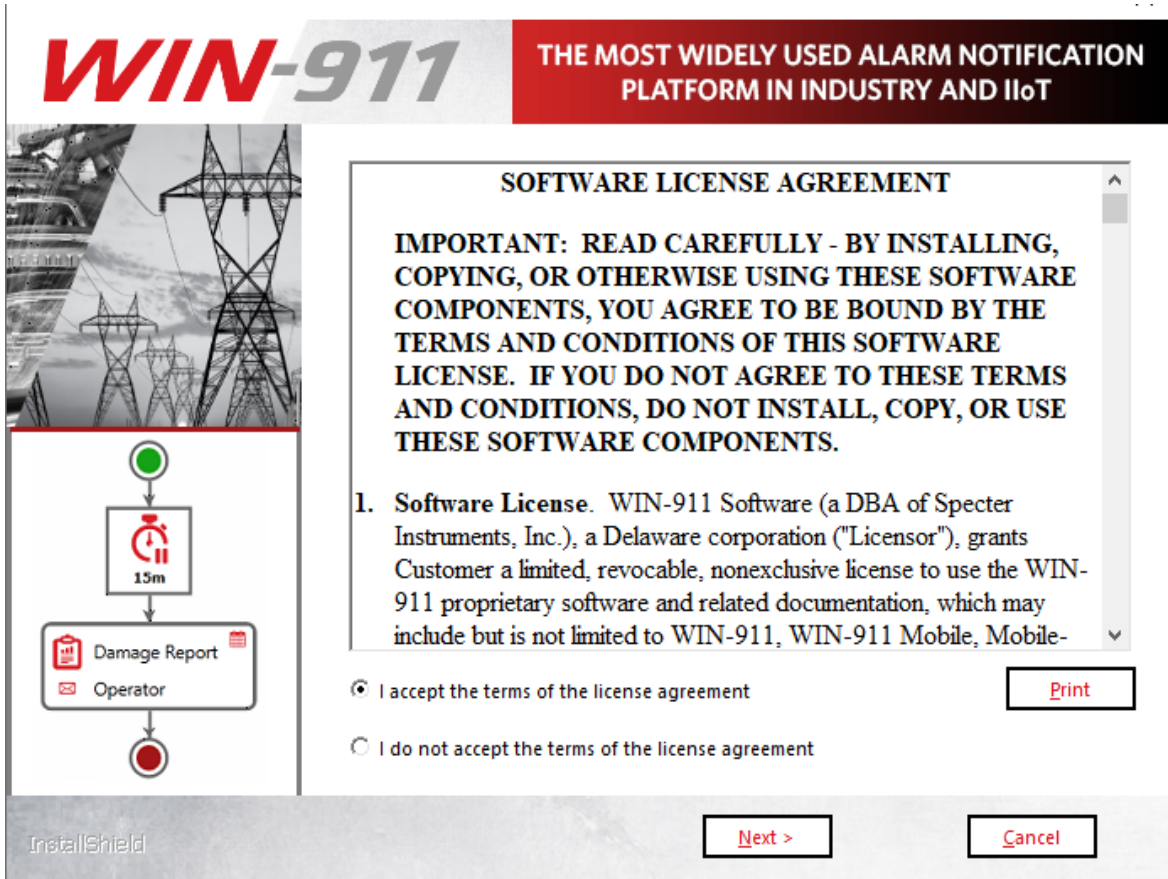

Accept the terms of the Software License Agreement by clicking the top radio button and then select **"Next"** to advance.



WIN-911 THE MOST WIDELY USED ALARM NOTIFICATION PLATFORM IN INDUSTRY AND IIoT



Enter the account under which WIN-911 services will execute. This account must be a member of the local Administrators group and will be given permission to host HTTP endpoints if necessary.

User name (User accounts must be in the format Domain\User)

MyComputer\MyUser

Password

.....

Show Password

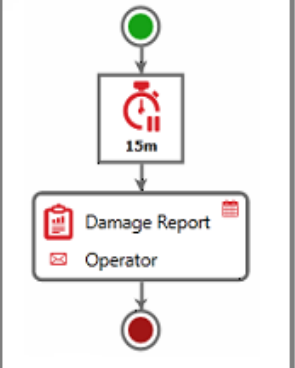

InstallShield

< Back Next > Cancel

Enter the "DOMAIN\username" and password that WIN-911 Services will run under. If a username and password are not yet set up in the operating system you can use the "**New User Information ...**" script to create one (Windows 8.1 and higher). This can be found via the control panel, User Accounts. For Active Directory users you will need to contact your network administrator or log onto a domain controller to create an account with the proper permissions. **When entering a domain user's name be sure to include the fully qualified domain name.**

Note: You must be logged in and executing this installation as an owner and administrator of the SQL instance. Additionally, the selected user here (if different) must be a member of the Windows local or domain administrator group with administrative privileges on the SQL instance.

WIN-911 THE MOST WIDELY USED ALARM NOTIFICATION PLATFORM IN INDUSTRY AND IIoT

Select the SQL Server instance to use for WIN-911 data storage. If you selected 'Use Existing' earlier, please specify your existing server below. Note that both the installing user and WIN-911 user selected previously (if different) must have SQL permissions.

Database Server:
MyComputer\WIN911

Note: Existing data will be migrated upon upgrade and will be re-initialized for modules being re-installed.

Browse...

InstallShield < Back Next > Cancel

Select the desired database server from the pull-down list. (Server OS's may require you to enable/start SQL Server Browser service in order to browse for SQL Servers)

If you do not see your target server, you may type it into the text entry field as you see it from SQL Management Studio.

WIN-911 Standalone System Setup

Connect to Server

SQL Server

Server type: Database Engine

Server name: MyComputer\WIN911

Authentication: Windows Authentication

User name: WIN-POJAKBLLFO1\mike

Password:

Remember password

Connect Cancel Help Options >>

Click "**Next**" to advance.

WIN-911 THE MOST WIDELY USED ALARM NOTIFICATION PLATFORM IN INDUSTRY AND IIoT

Required WIN-911 Support modules:

- Dispatcher
- Navigation
- Reporting

Damage Report
Operator

InstallShield

< Back Next > Cancel

WIN-911 User Guide

The support module selection menu allows you to choose which components of WIN-911 you install. As a general rule, all support features should be installed.

If a selection box appears greyed out, then installation/upgrade of the module is mandatory.

Click **Next >** to advance.

WIN-911 THE MOST WIDELY USED ALARM NOTIFICATION PLATFORM IN INDUSTRY AND IIoT

Choose your WIN-911 Source modules below:

- InTouch
- InTouch Edge HMI
- System Platform
- CIMPPLICITY
- iFIX
- FactoryTalk Alarms and Events
- OPC DA

The OPC DA source module provides connectivity to OPC DA servers.
Version to be installed: 4.20.13.0

InstallShield < Back Next > Cancel

Source modules provide connectivity to various data sources that WIN-911 supports. The source module selection menu allows you to choose which components of WIN-911 you install. Only install the source modules you intend to use. You can always add features later that are not originally installed by re-running the setup. When installing a standalone WIN-911 System you must pick at least one source module to continue.

If a selection box appears greyed out, then the option is either required or already present.

Note: Some sources require selection of specific HMI/SCADA versions.

Click **“Next”** to advance.

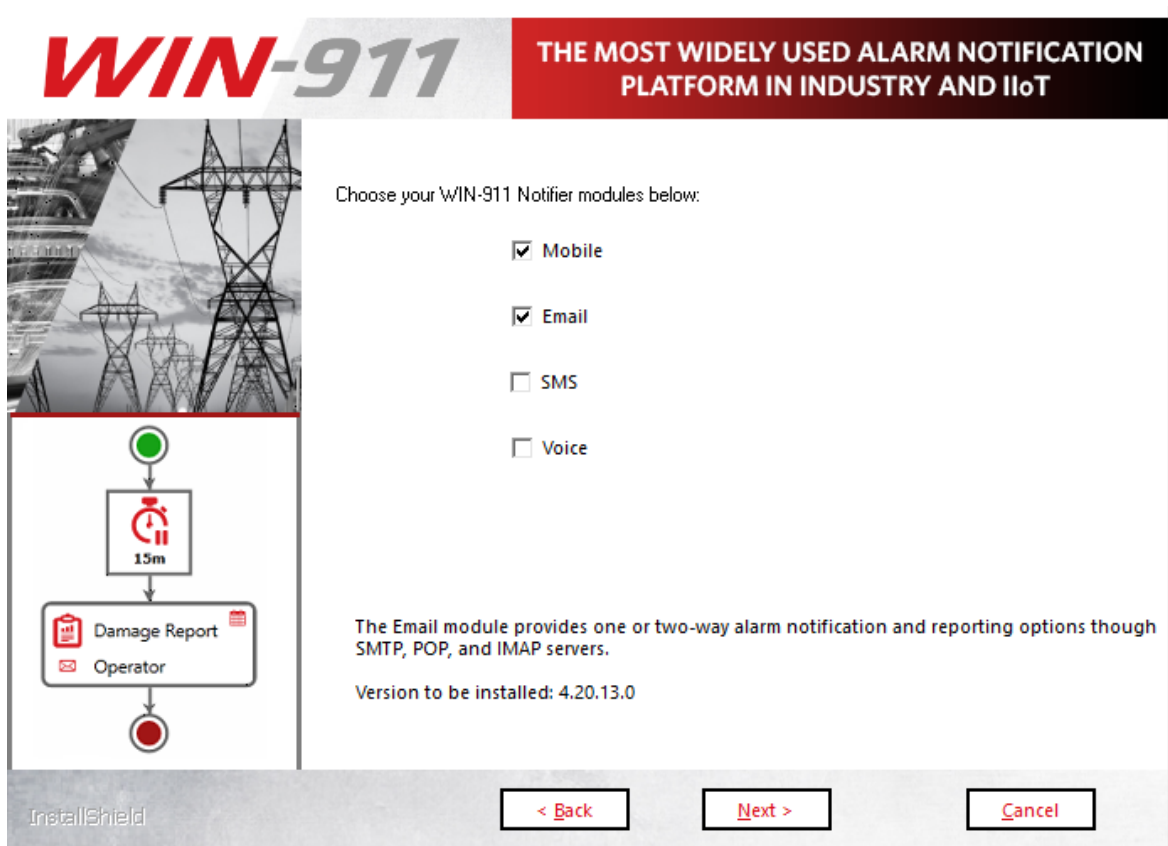

WIN-911 provides several methods of remote notification to users; including Email, Mobile (new in version 4), Voice, and SMS. The notifier module selection menu allows you to choose which components of WIN-911 to install. Only install the notifier modules you currently intend to use. You can re-run the setup program later if decide to add

WIN-911 User Guide

notifiers to your system. When conducting a standalone WIN-911 System you must pick at least one notifier module to continue.

If a selection box appears greyed-out, then that option has already been installed.

Click **“Next”** to begin the installation and initialization phase of the setup.

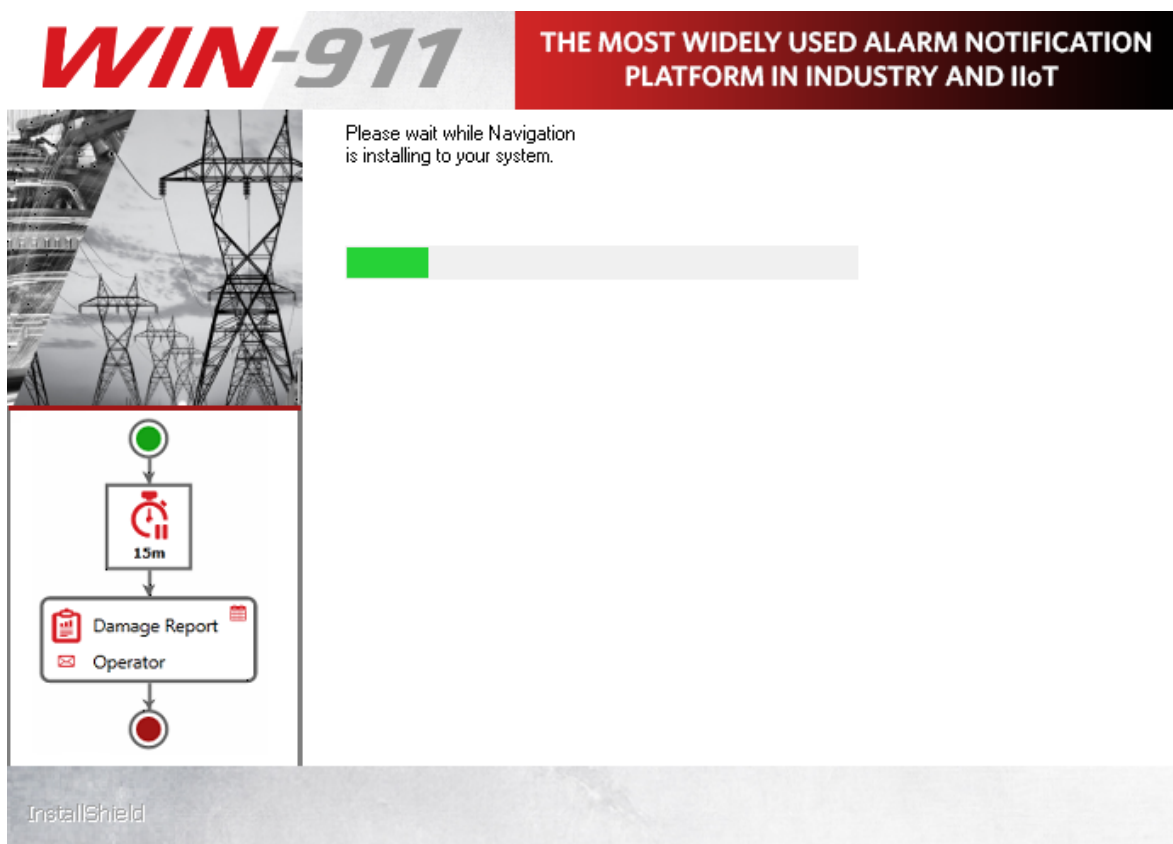

This portion of the install may take several minutes.

WIN-911

THE MOST WIDELY USED ALARM NOTIFICATION
PLATFORM IN INDUSTRY AND IIoT



Setup Complete

Setup has successfully installed WIN-911 Install 4.20.13.

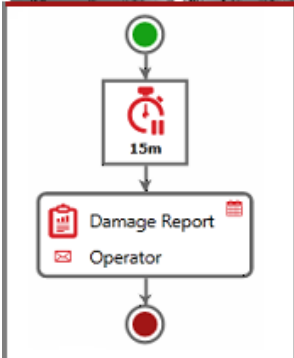

InstallShield

< Back

Next >

Cancel

Click Finish to conclude the installation process.

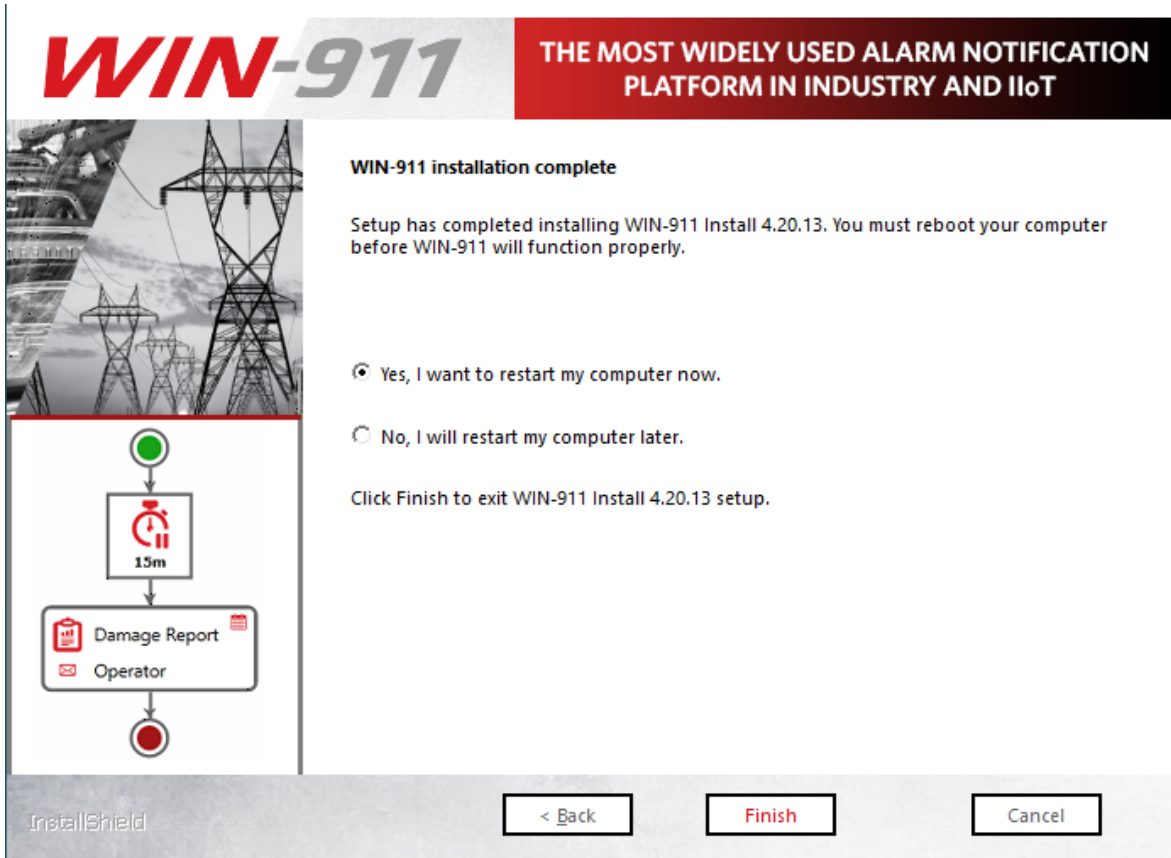

Once the installation completes, a restart will be required **before WIN-911 can be used**. You can elect to do so immediately or later. Make your selection and click **Finish**.

Modifying WIN-911

Adding features to your existing WIN-911 installation

Run the WIN-911 Install in the same manner as listed above when installing for the first time. When you get to the Select Features page the currently installed modules will appear grayed out, indicating that they are not available for installation. All currently uninstalled features should be available for selection. Select the desired check boxes and continue through the install process until you reach the Finish page.

You will then be required to reboot before using WIN-911 in its modified form.

Removing features from your existing WIN-911 installation

WIN-911 features can be uninstalled via *Control Panel\Programs and Features*. Each module will have to be uninstalled individually. Right-click the WIN-911 module and select Uninstall. Repeat this process until all undesired features have been removed. You will then need to run the WIN-911 Endpoint Mapper before using WIN-911 in its modified form.

Note: To uninstall WIN-911, remove all modules.

WIN-911 Network Module Mapper

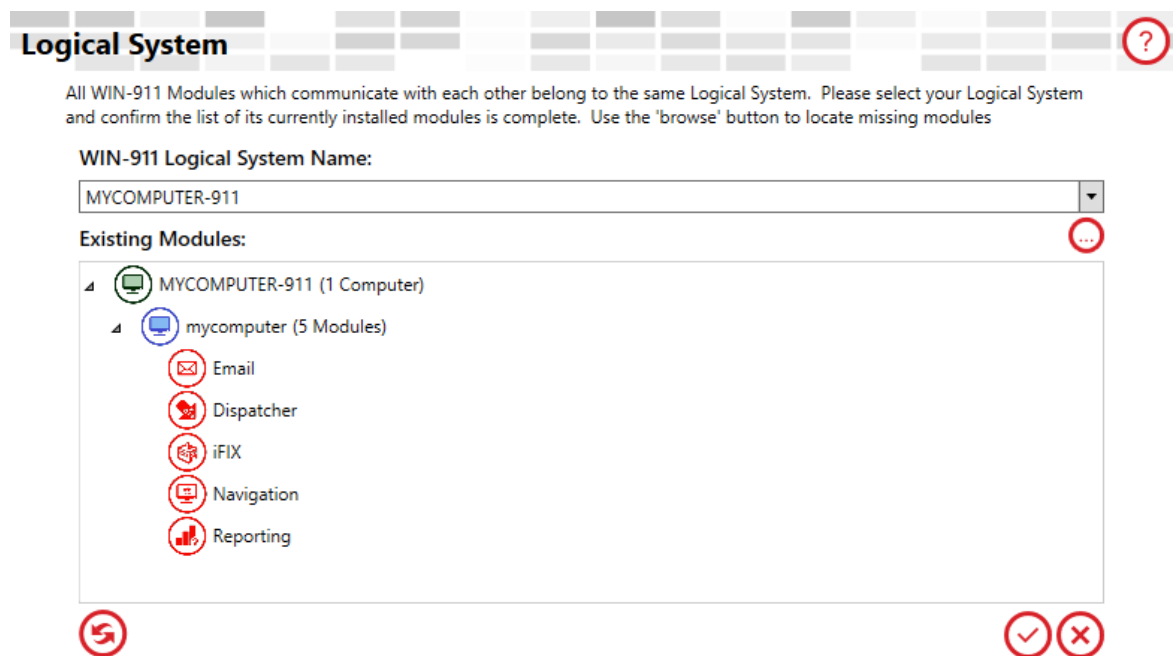

Whenever you modify your WIN-911 system by uninstalling software modules you will need to run the WIN-911 Network Module Mapper. The mapping process might take several minutes to appear and may

WIN-911 User Guide

need to be refreshed if the proper number of modules are not listed. This is normal so allow for extra time during the post-modification reboot.

The proper number of modules depends on the number of data sources and notifiers you selected during the feature selection. If fewer modules appear, then click the refresh button until the proper number are listed. To calculate the expected number of modules in your system add the *Support + Notifiers + Data Sources* from the feature selection.

Once the proper number of modules are listed, click the save button. This will conclude this portion of the install. **You should not need to run the WIN-911 Network Module Mapper again** unless you remove certain features included in the initial install.

See [WIN-911 Network Module Mapper](#) for more details.

Licensing WIN-911

Note: After an initial installation WIN-911 will be configured with a demo license that will run 30 days without restriction.

To license WIN-911 click on the CodeMeterControl Center thumbnail located in the lower right of your tray.

Click the "License Update" button and follow the wizard to generate a license request file.

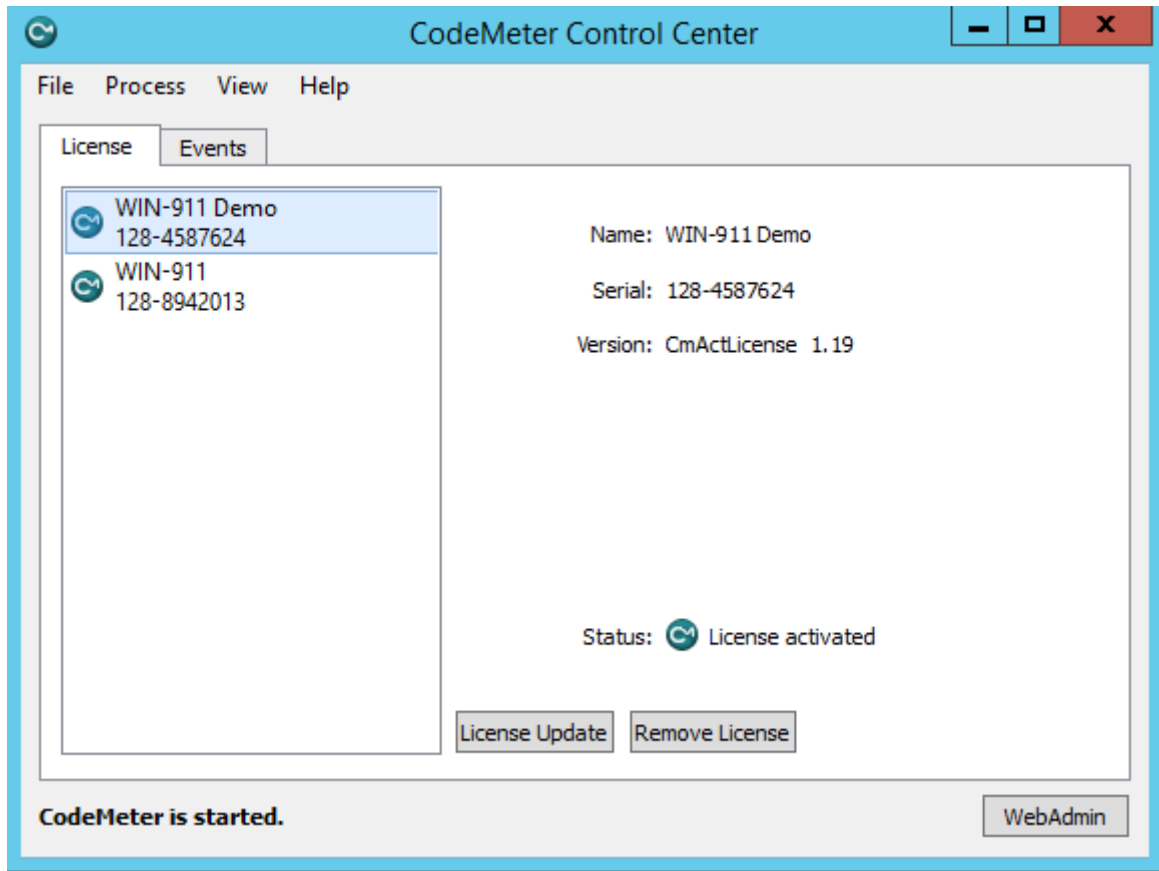

Select the container with the active license (1). The Status indication will verify "Empty license container". Then click Activate License (2).

WIN-911 User Guide

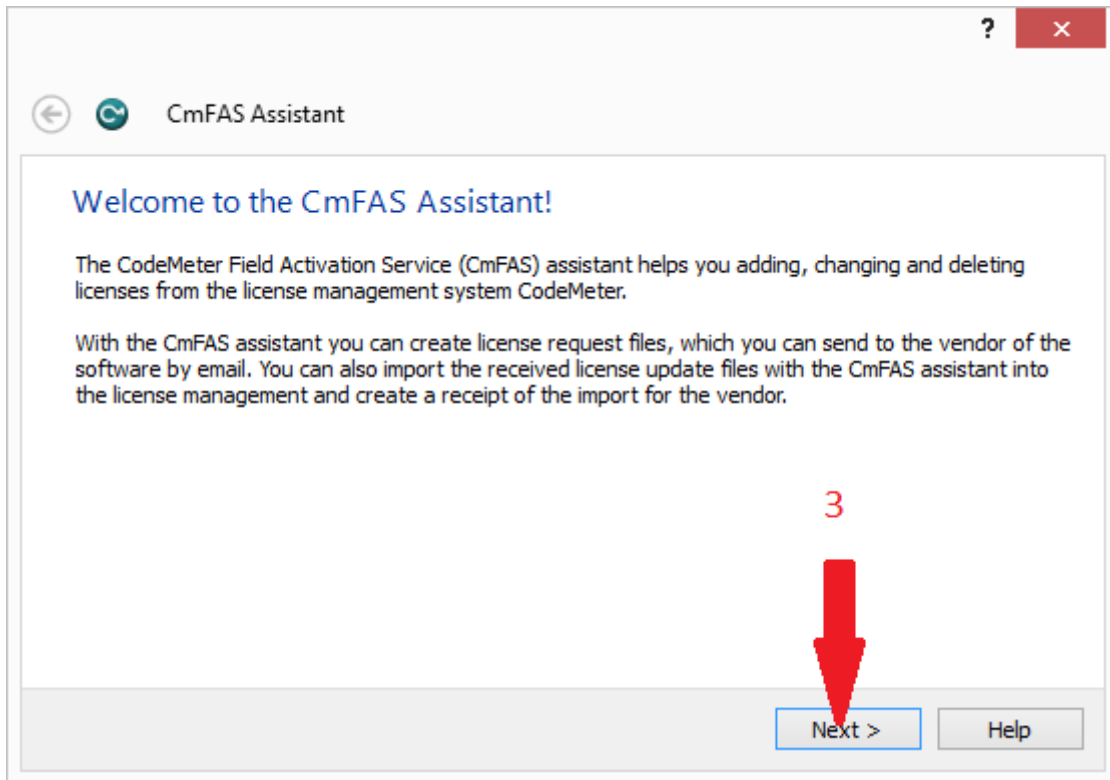

Click the Next > (3) button to advance past the welcome screen.

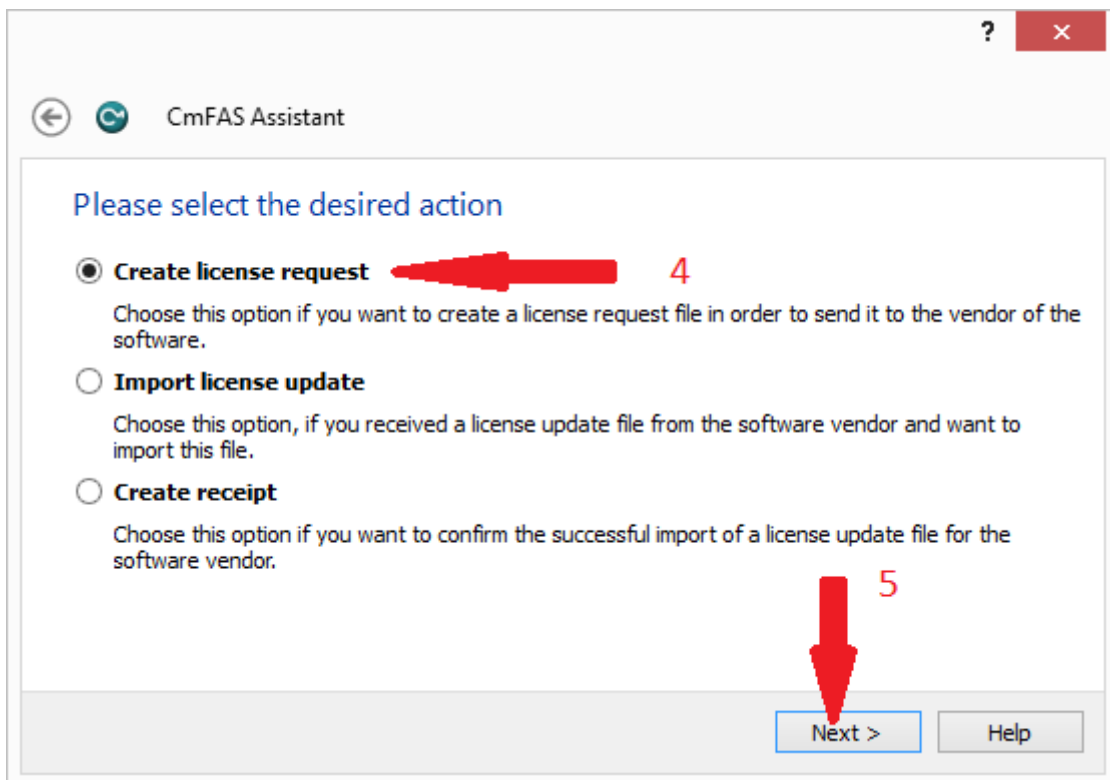

Select the Create license request (4) option and then click Next > (5).

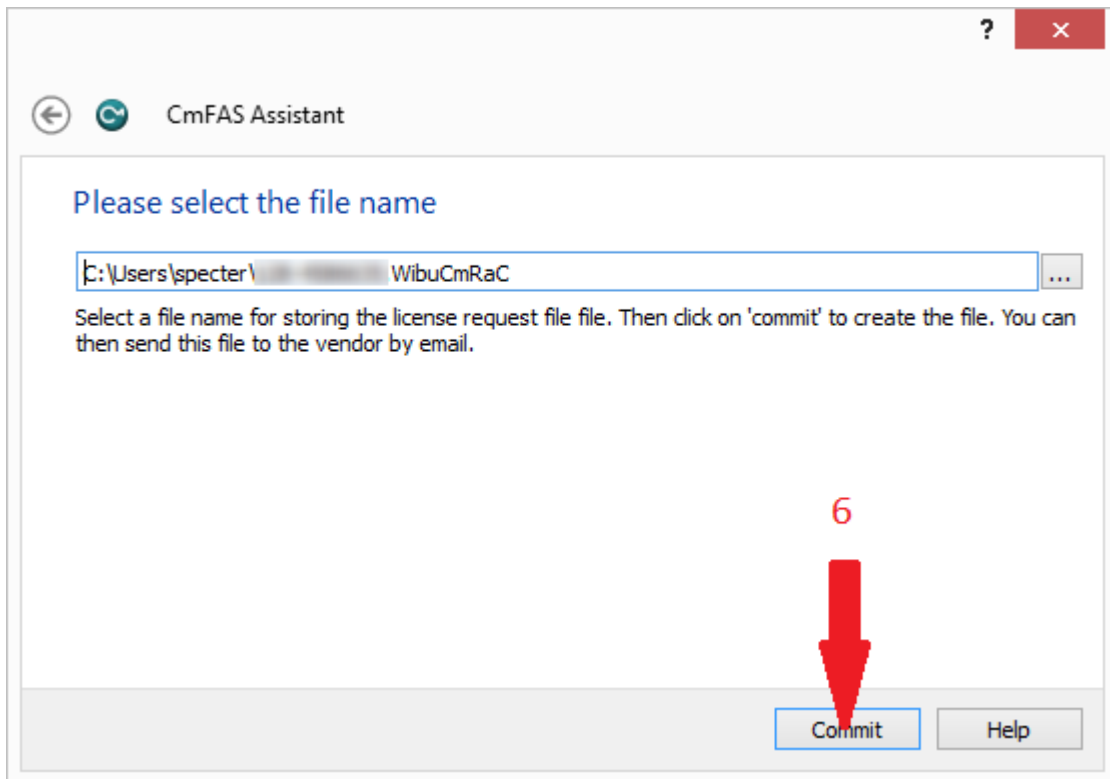

Note the location of the license request and then click Commit (6).

Log onto our [website](#), complete the license request form and submit the license request file.

Upon receipt of the license file, save it to the desktop.

Double-click on the license file. This will import and activate the license.

WIN-911 User Guide

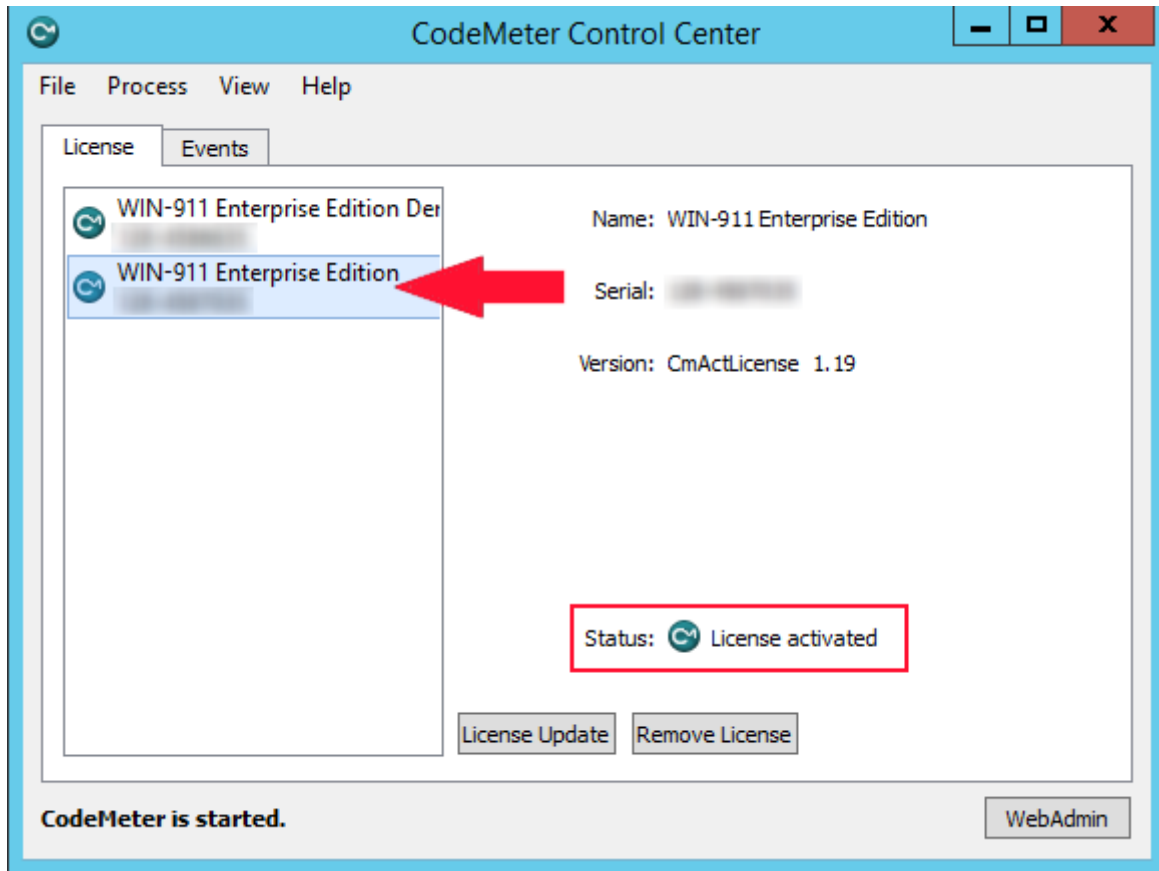

Remove the Demo license by highlighting it and clicking "Remove License".

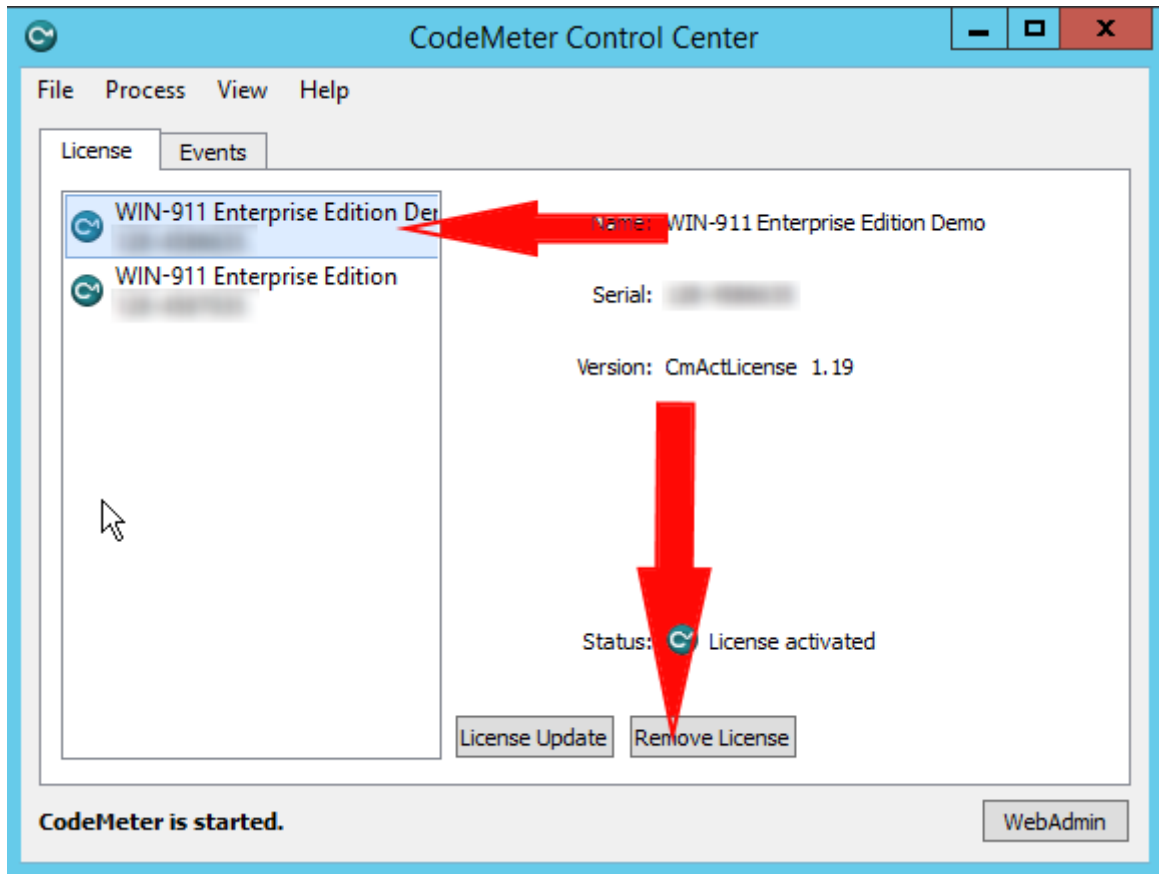

To verify proper licensing, reboot the host machine, then check the Event Logger for any WIN-911 related errors.

Create Distributed System

The WIN-911 Launcher requires .NET 4.0 (or higher). If the target machine lacks this framework, you will need to add the framework in order to commence. In Windows 8.x, this can be done through *Programs and Features > Turn Windows features on or off*. With Server operating systems use *Server Manager > Add roles and features*. Additionally, you can find an installer for the framework in the support sub folder of the installation media or online.

To begin creating a distributed WIN-911 System you will need to run the install on the computer that will host the support modules.

WIN-911 THE MOST WIDELY USED ALARM NOTIFICATION PLATFORM IN INDUSTRY AND IIoT

Welcome to the WIN-911 Setup. The following dialogs will guide you through the process of installing WIN-911. Click the 'Next' button to begin.

- Standalone System**
All WIN-911 modules will be installed on this computer.
- Create Distributed System**
Deploy WIN-911 modules across your network starting with this computer.
- Join Distributed System**
Add additional modules to an existing system.

Display Language: English

© 1993-2019, WIN-911 Software, All Rights Reserved. U.S. Pat. No. 9,535,570. WIN-911® and Mobile-911® are registered trademarks of WIN-911 Software. All other trademarks cited herein are the property of their respective owners.

Read Install Guide Next Cancel

Attention: When using a language other than English select it here.

Click **“Next”** to begin WIN-911 Setup.

The installation program checks whether or not the environment requirements are met.

The screenshot shows the WIN-911 installation error dialog box. At the top left is the WIN-911 logo. To its right, a red banner reads "THE MOST WIDELY USED ALARM NOTIFICATION PLATFORM IN INDUSTRY AND IIoT". Below the logo is a vertical image strip: the top part shows power lines, and the bottom part shows a flowchart with a green circle at the top, a red alarm icon with "15m" below it, a box containing "Damage Report" and "Operator" icons, and a red circle at the bottom. The main text area says "The following environment requirements have not been met:" followed by "Insufficient Number of CPU/Cores (2 CPU minimum)". At the bottom left is a "Read Install Guide" button. At the bottom center is the text "Requirements have not been met. Please click 'Cancel' to abort this installation." At the bottom right are "Enable Features" and "Cancel" buttons.

Such environment requirements include:

- Supported 64-bit OS

WIN-911 User Guide

- Sufficient minimum disk space
- Sufficient minimum processors/cores
- Installing user be a member of local administrator's group

See WIN-911 4.21.5 System Requirements at the top of this document for more information.

Note: If these requirements are met, this page will not appear.

The installation program will then check for the required features.

The screenshot shows the WIN-911 installation requirements dialog box. At the top left is the WIN-911 logo. To its right, a red banner contains the text "THE MOST WIDELY USED ALARM NOTIFICATION PLATFORM IN INDUSTRY AND IIoT". Below the logo is a background image of power lines. The main content area is titled "Installation requires the following Windows Features:" and lists ten disabled features: IIS Management Console, IIS Default Document, IIS Static Content, IIS Basic Authentication, IIS HTTP Redirection, IIS Windows Authentication, IIS ASP .NET 4.5, Internet Information Services, IIS Application Initialization, and .NET WCF HTTP Activation. On the left side of the dialog, there is a flowchart with a green circle at the top, a box with a red alarm icon and "15m" below it, a box with "Damage Report" and "Operator" below that, and a red circle at the bottom. At the bottom of the dialog, there are three buttons: "Read Install Guide" (with a red underline), "Enable Features" (with a red underline), and "Cancel" (with a red underline). A message at the bottom center states: "Requirements have not been met. Click the 'Enable Features' button to continue."

Feature requirements include the following:

- Microsoft .NET 4.8
- Windows Edition and Feature Set Detection
- IIS Features: Application Initialization, Basic Authentication, Windows Authentication, HTTP Redirection and ASP.NET 4.5, HTTP Activation

Any missing feature can be enabled by clicking the Enable Features button at the bottom right.

Note: If these requirements are met, this page will not appear.

SQL Server Installation

The install script will check the WIN-911 host for an SQL Server instance named "WIN911". If there is no suitable SQL Server, the following pop-up will appear:

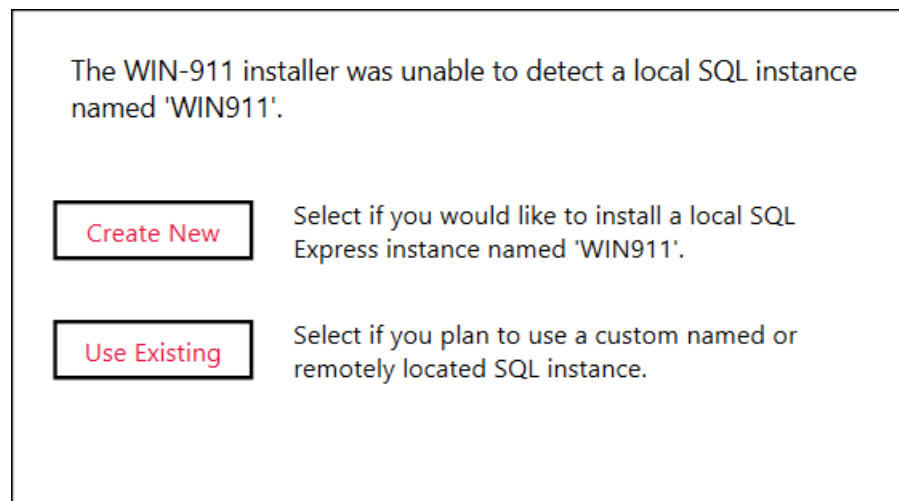

This is an optional step and is not required in order to continue with the installation, but WIN-911 cannot be used until the SQL Server requirement is satisfied.

Note: if you are upgrading, you should select "Use Existing" to keep your existing data.

InstallShield Wizard

WIN-911 THE MOST WIDELY USED ALARM NOTIFICATION PLATFORM IN INDUSTRY AND IIoT

WIN-911 Install 4.20.13 requires the following items to be installed on your computer. Click Install to begin installing these requirements.

Status	Requirement
Pending	WIBU CodeMeter Control Center 7.00.3933.502
Pending	VC++ 2008 Security update
Pending	Silverlight
Pending	Microsoft Visual C++ 2010 SP1 Redistributable Package (x64)
Pending	Microsoft Visual C++ 2008 SP1 Redistributable Package (x64)
Pending	Microsoft Visual C++ 2015 Redistributable Package 24215.1 (x64)
Pending	Microsoft Visual C++ 2015 Redistributable package 24215.1 (x86)
Pending	Microsoft Visual C++ 2019 Redistributable Package (x64)
Pending	Microsoft Visual C++ 2019 Redistributable Package (x86)

InstallShield

Depending on the state of .NET Framework 4.8, you may need to reboot prior to continuing.

WIN-911 Install 4.20.13 - InstallShield Wizard

? This installation of WIN-911 Install 4.20.13 required a reboot. Click Yes to restart now or No if you plan to restart later.

If requested, select Yes and the install process will resume automatically once the reboot is performed.

The WIN-911 InstallShield wizard will now guide you through the WIN-911 setup. Click "**Next**" to continue.

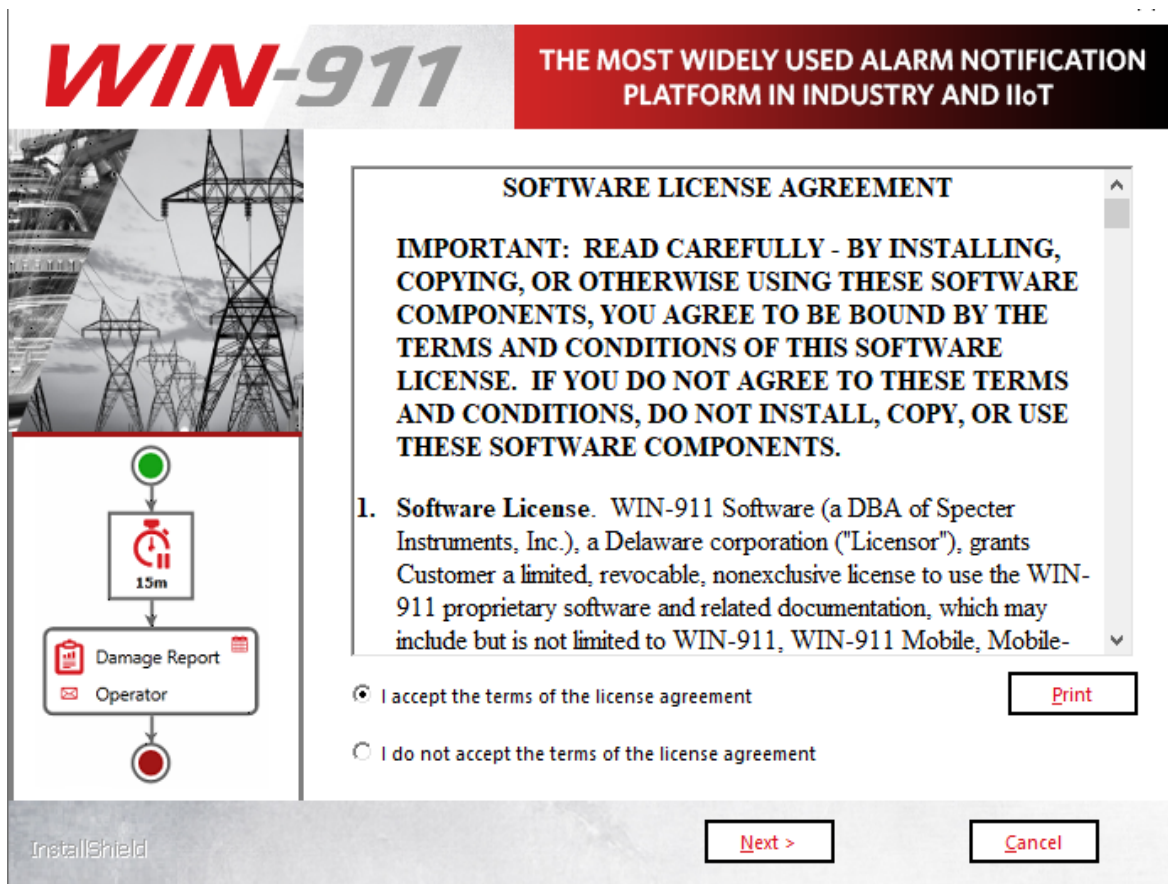

Accept the terms of the Software License Agreement by clicking the top radio button and then select "**Next**" to advance.

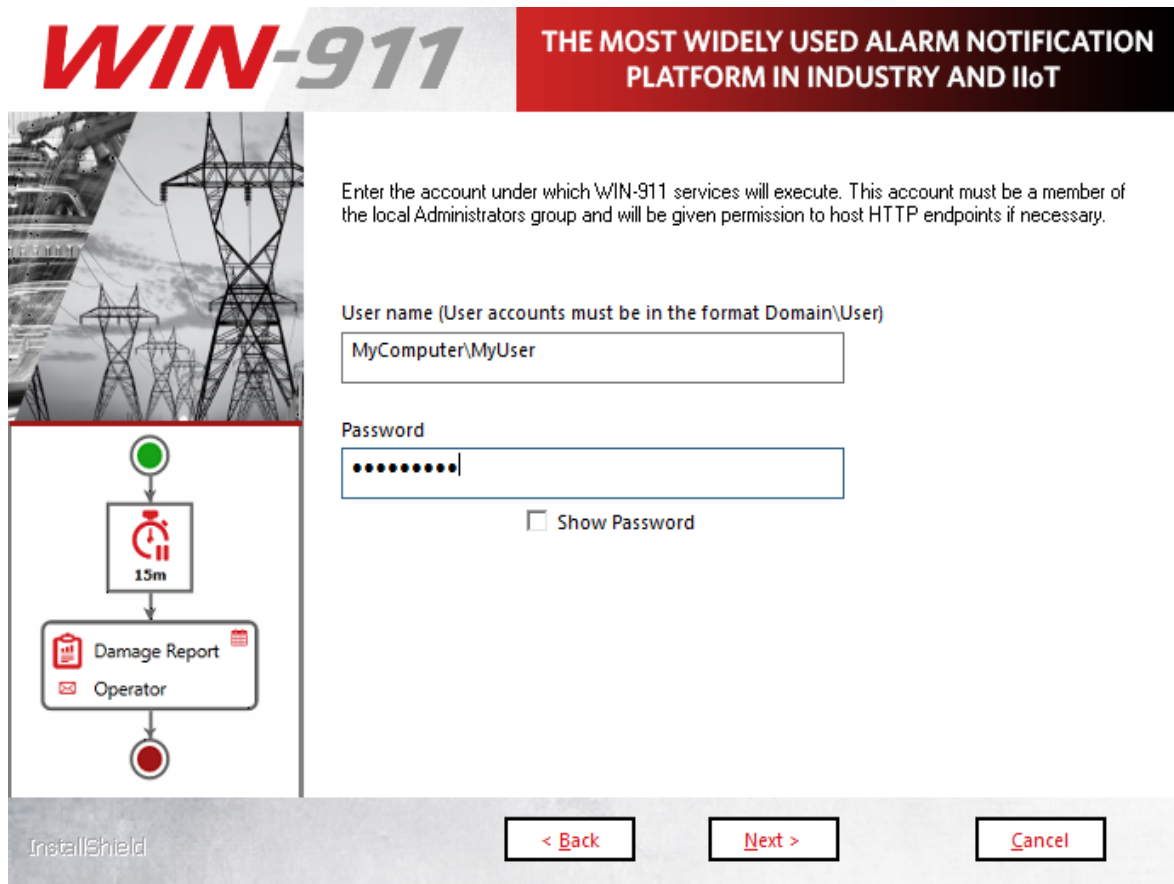

Enter the "DOMAIN\username" and password that WIN-911 Services will run under. If a username and password are not yet set up in the operating system you can use the "**New User Information ...**" script to create one (Windows 8 and higher). This can be found via the control panel, User Accounts. For Active Directory users you will need to contact your network administrator or log onto a domain control to create an account with the proper permissions. **When entering a domain user's name be sure to include the fully qualified domain name.**

Note: You must be logged in and executing this installation as an owner and administrator of the SQL instance. Additionally, the selected user here (if different) must be a member of the Windows local or domain administrator group with administrative privileges on the SQL instance.

WIN-911 THE MOST WIDELY USED ALARM NOTIFICATION PLATFORM IN INDUSTRY AND IIoT

Select the SQL Server instance to use for WIN-911 data storage. If you selected 'Use Existing' earlier, please specify your existing server below. Note that both the installing user and WIN-911 user selected previously (if different) must have SQL permissions.

Database Server:
MyComputer\WIN911

Note: Existing data will be migrated upon upgrade and will be re-initialized for modules being re-installed.

Browse...

InstallShield

< Back Next > Cancel

Select the desired database server from the pull-down list. (Server OS's may require you to enable/start SQL Server Browser service in order to browse for SQL Servers)

If you do not see your target server, you may type it into the text entry field as you see it from SQL Management Studio.

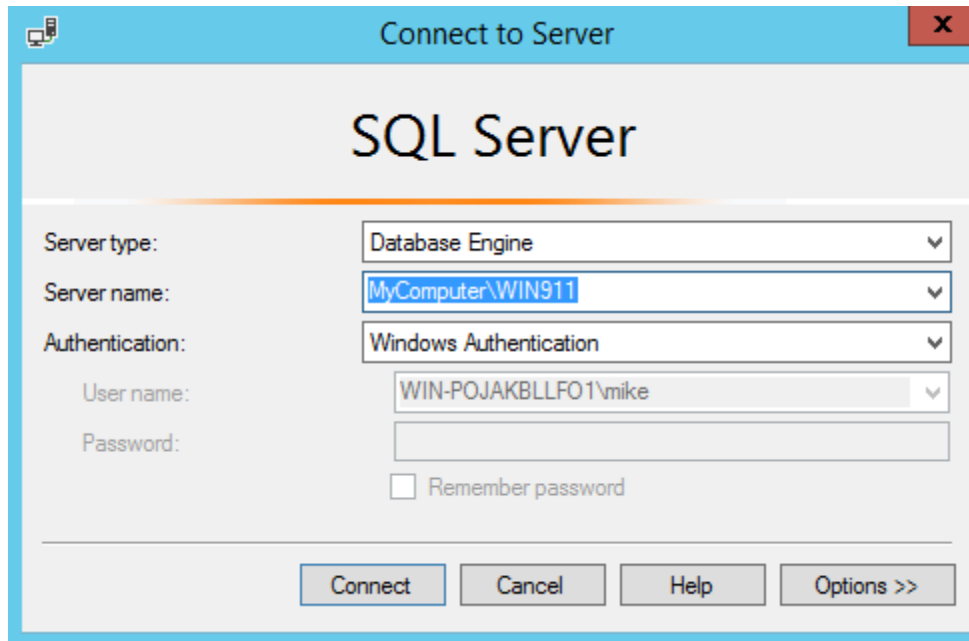

Click "**Next**" to advance.

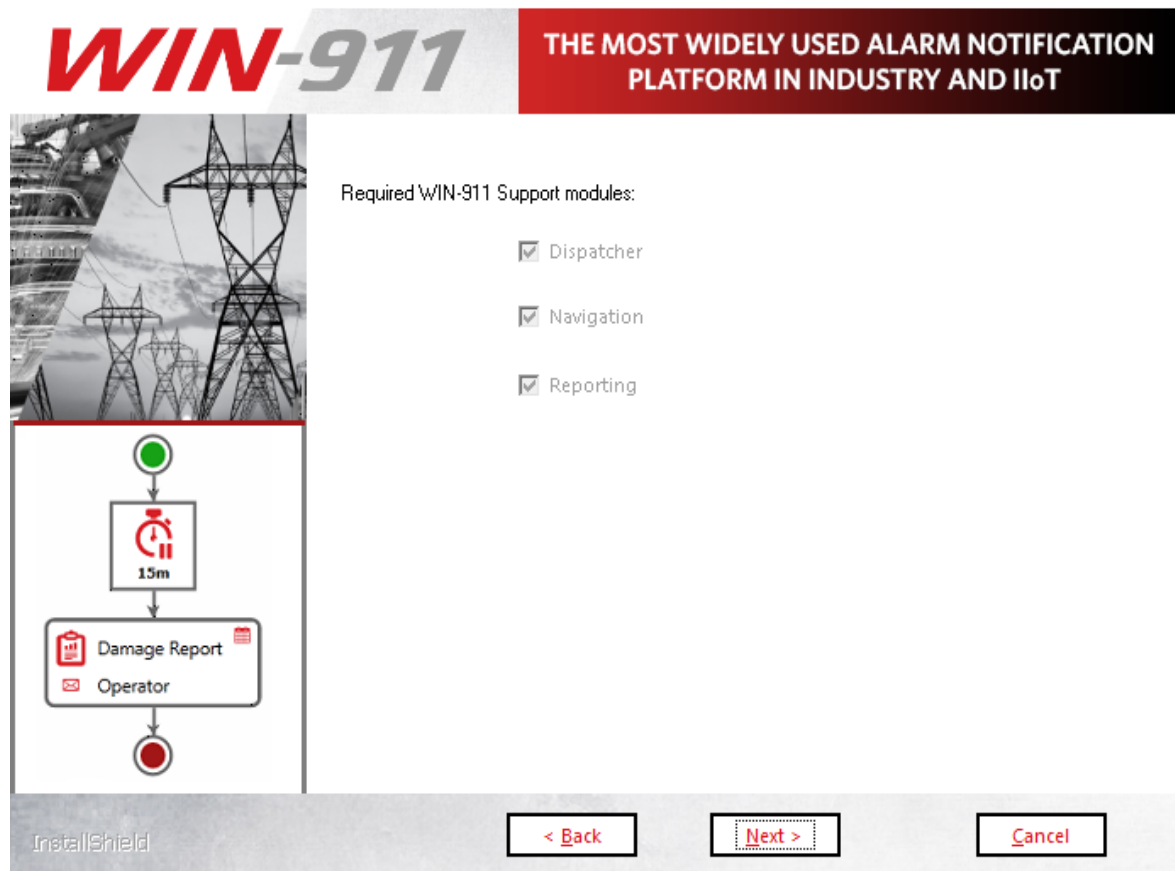

To create a distributed WIN-911 System you must install all support modules on the primary (Dispatcher) WIN-911 host. Thus, all support modules are required and selected by default.

Click **Next** > to advance.

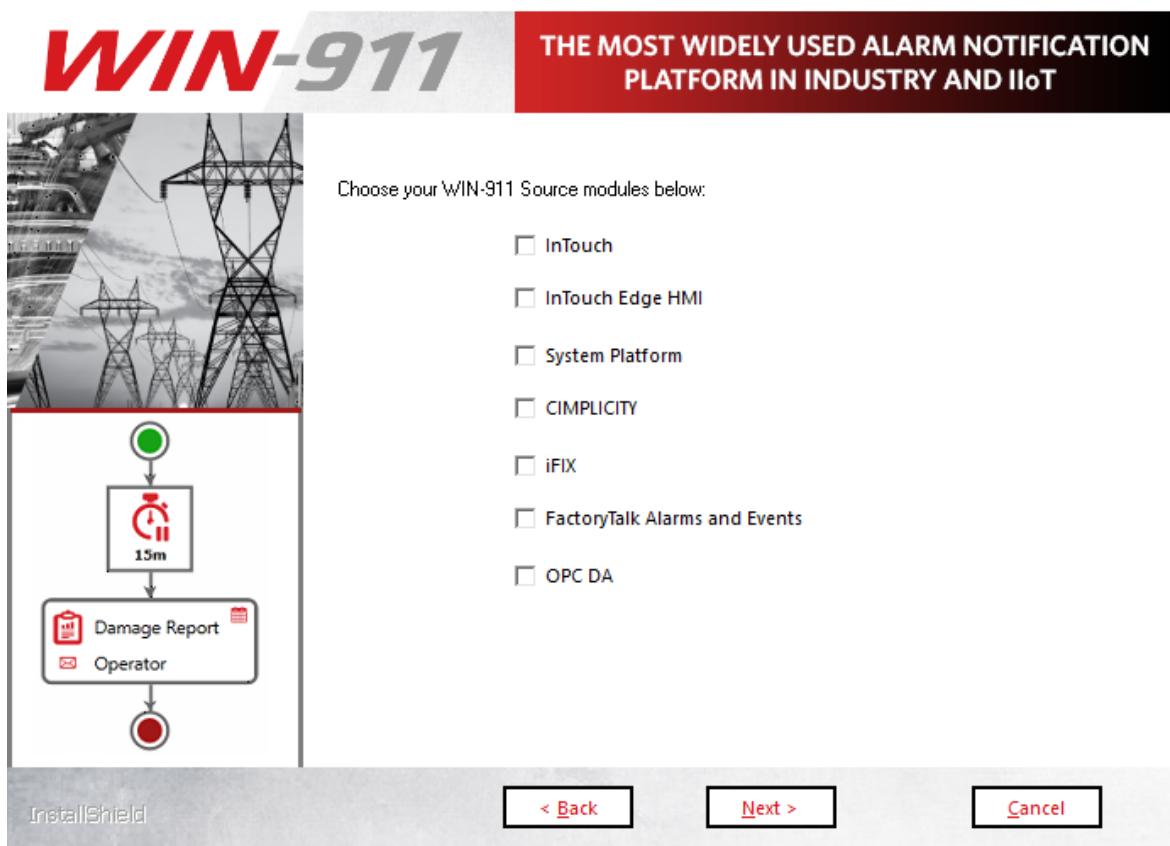

Source modules provide connectivity to various data sources that WIN-911 supports. The source module selection menu allows you to choose which components of WIN-911 you install. Only install the source modules you intend to use. You can always add features later that are not originally installed by re-running the setup.

When finalizing a distributed WIN-911 System, at least one source module is required, but it does not need to be on the same computer as your support modules. Thus, you can proceed with the current install without selecting a source module. To finalize your WIN-911

WIN-911 User Guide

System, you will need to install a source module to another computer using the "Join Distributed System" option.

If a selection box appears greyed out, then the option is either required or already present.

Note: Some sources require selection of specific HMI/SCADA versions.

Click "**Next**" to advance.

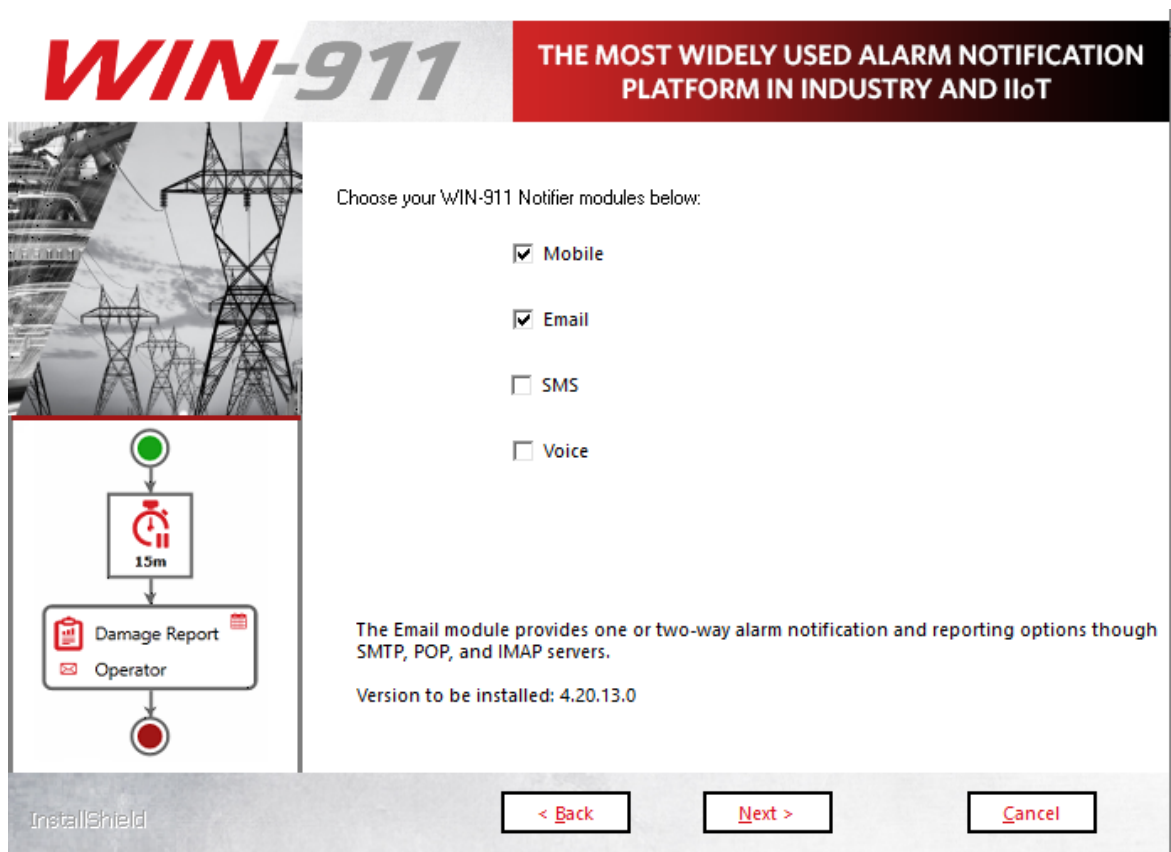

The screenshot shows the WIN-911 installation wizard interface. At the top, the logo "WIN-911" is displayed in red and grey, followed by the tagline "THE MOST WIDELY USED ALARM NOTIFICATION PLATFORM IN INDUSTRY AND IIoT" in white text on a red background. Below this, a banner image shows power lines and a control room. The main content area is titled "Choose your WIN-911 Notifier modules below:" and contains four checkboxes: "Mobile" (checked), "Email" (checked), "SMS" (unchecked), and "Voice" (unchecked). To the left of the checkboxes is a vertical flow diagram with a green circle at the top, a box with a red alarm icon and "15m" below it, a box with "Damage Report" and "Operator" below it, and a red circle at the bottom. Below the checkboxes, text reads: "The Email module provides one or two-way alarm notification and reporting options through SMTP, POP, and IMAP servers." and "Version to be installed: 4.20.13.0". At the bottom of the window, there are three buttons: "< Back", "Next >", and "Cancel". The "InstallShield" logo is visible in the bottom left corner.

WIN-911 provides several methods of remote notification to users; including Mobile, Mobile-911, Email, SMS, and Voice. The notifier module selection menu allows you to choose which components of WIN-911 to install. Only install the notifier modules you currently

intend to use. You can re-run the setup program later if decide to add notifiers to your system.

When finalizing a distributed WIN-911 System, at least one notifier module is required, but it does not need to be on the same computer as your support modules. Thus, you can proceed with the current install without selecting a notifier module. To finalize your WIN-911 System, you will need to install a notifier module to another computer using the "Join Distributed System" option.

If a selection box appears greyed out, then that option has already been installed.

Click **"Next"** to begin the installation and initialization phase of the setup.

WIN-911 THE MOST WIDELY USED ALARM NOTIFICATION PLATFORM IN INDUSTRY AND IIoT

Please wait while Navigation is installing to your system.

15m

Damage Report
Operator

InstallShield

WIN-911 User Guide

This portion of the install may take several minutes.

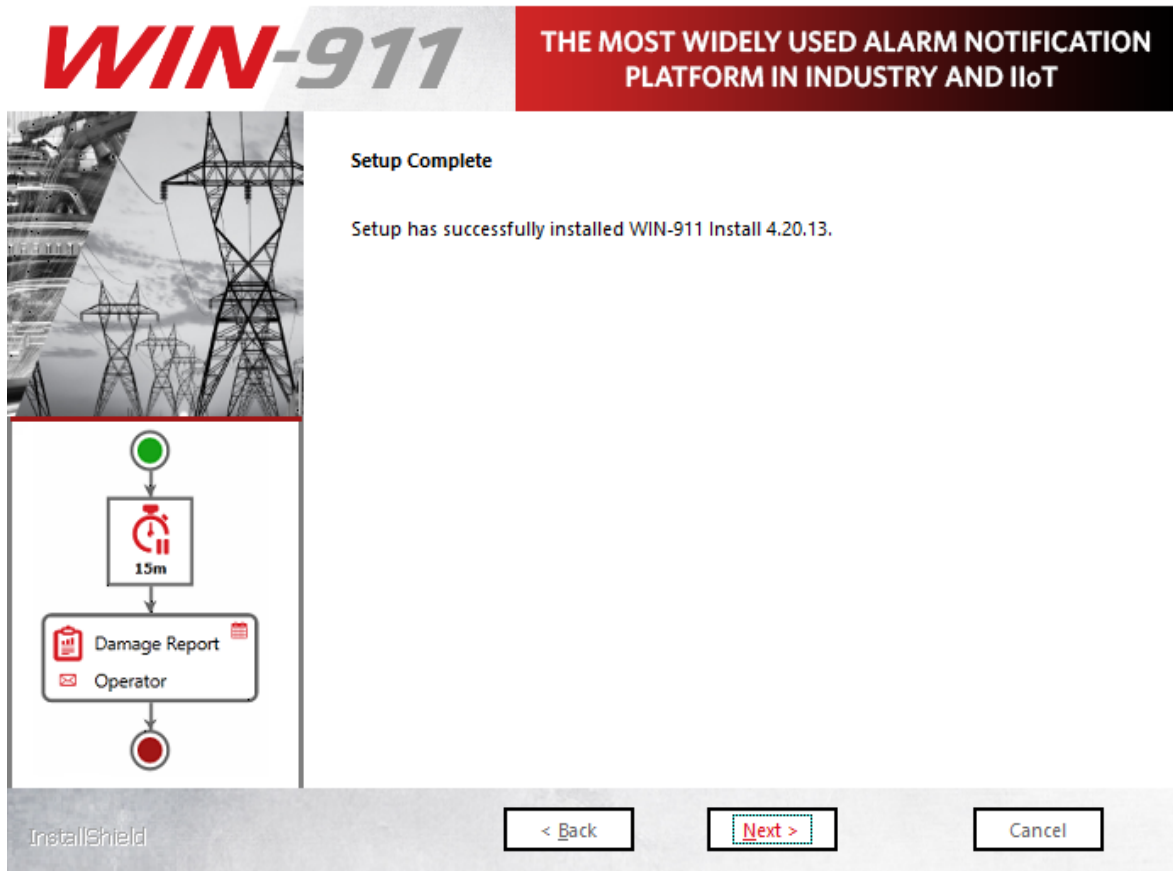

Click Finish to conclude the installation process.

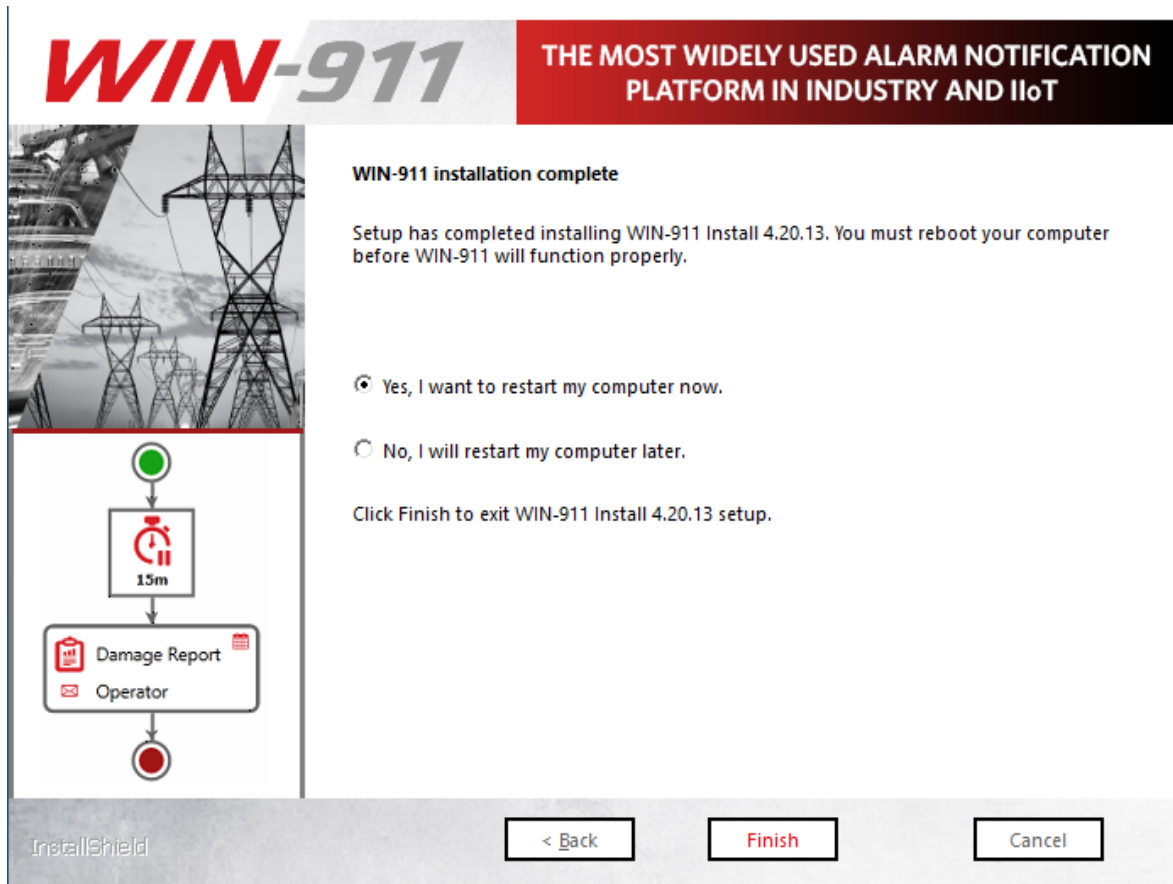

Once the installation completes, a restart will be required **before WIN-911 can be used**. You can elect to do so immediately or later. Make your selection and click ***Finish***.

[Modifying and Licensing WIN-911](#)

Join Distributed System

The WIN-911 Launcher requires .NET 4.0 (or higher). If the target machine lacks this framework, you will need to add the framework in order to commence. In Windows 8.x, this can be done through *Programs and Features > Turn Windows features on or off*. With Server operating systems use *Server Manager > Add roles and features*. Additionally, you can find an installer for the framework in the support sub folder of the installation media or online.

To join a distributed WIN-911 System you will first need to create a distributed WIN-911 System that includes the support modules. This is done by installing the WIN-911 Support modules on your primary (Dispatcher) host computer.

WIN-911

THE MOST WIDELY USED ALARM NOTIFICATION PLATFORM IN INDUSTRY AND IIoT



Welcome to the WIN-911 Setup. The following dialogs will guide you through the process of installing WIN-911. Click the 'Next' button to begin.

- Standalone System
All WIN-911 modules will be installed on this computer.
- Create Distributed System
Deploy WIN-911 modules across your network starting with this computer.
- Join Distributed System
Add additional modules to an existing system.

Display Language:

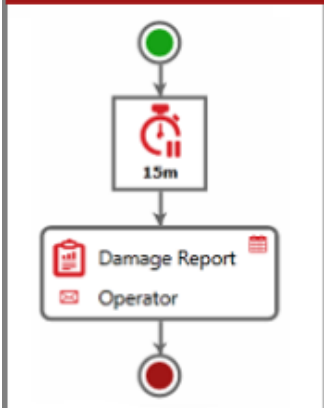

© 1993-2019, WIN-911 Software, All Rights Reserved. U.S. Pat. No. 9,535,570.
WIN-911® and Mobile-911® are registered trademarks of WIN-911 Software.
All other trademarks cited herein are the property of their respective owners.

[Read Install Guide](#)

[Next](#)

[Cancel](#)

Attention: When using a language other than English select it here.

Click **“Next”** to begin WIN-911 Setup.

The installation program checks whether or not the environment requirements are met.

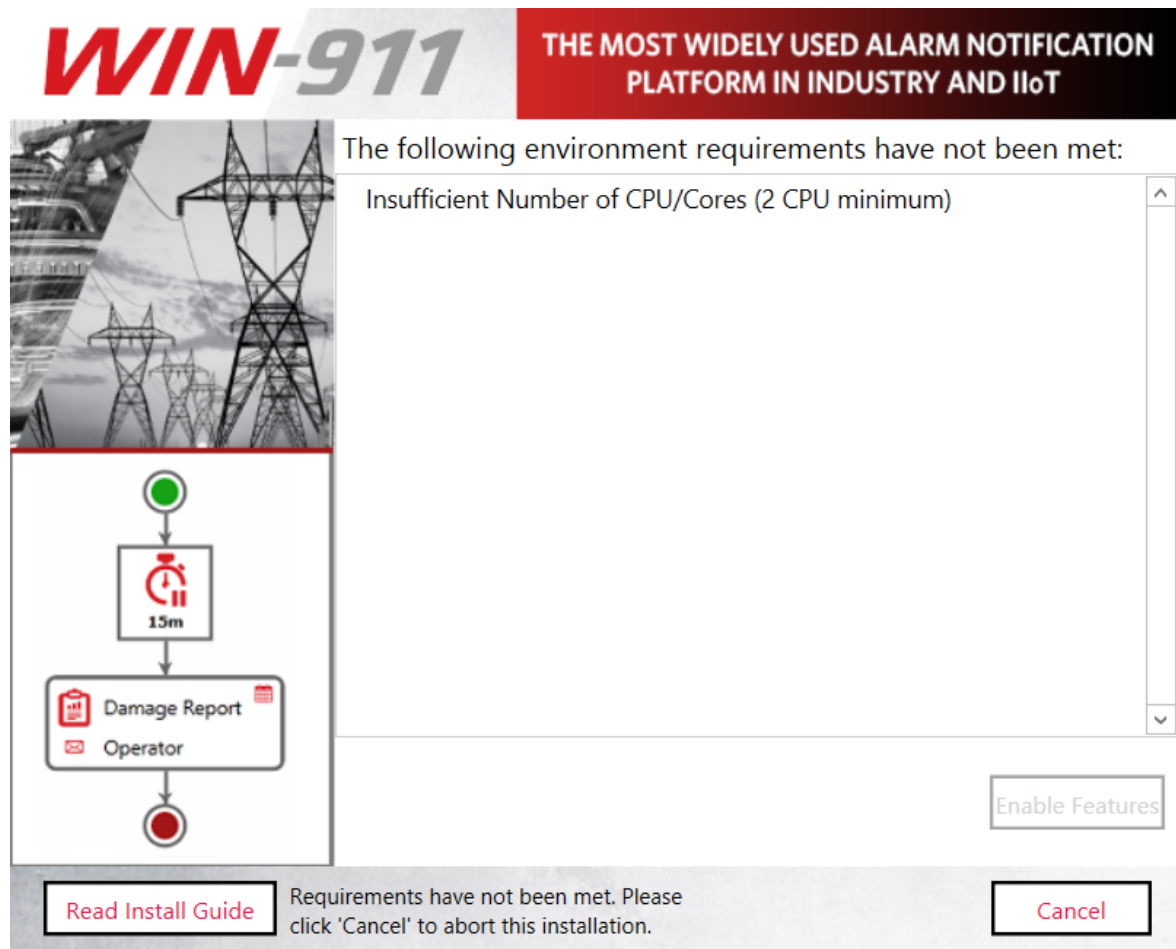

Such environment requirements include:

- Supported 64-bit OS
- Sufficient minimum disk space
- Sufficient minimum processors/cores
- Installing user be a member of local administrator's group

See WIN-911 4.21.5 System Requirements at the top of this document for more information.

Note: If these requirements are met, this page will not appear.

The installation program will then check for the required features.

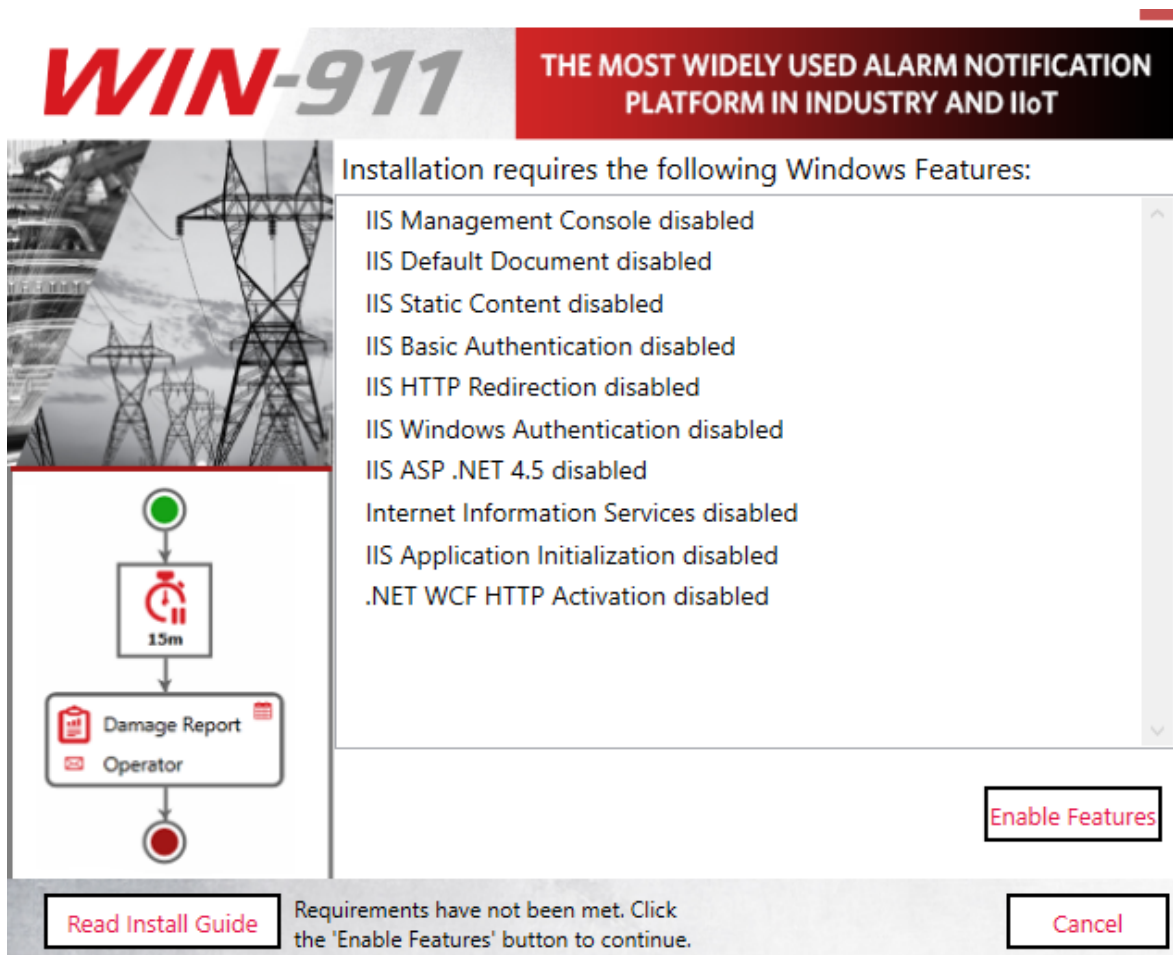

WIN-911 THE MOST WIDELY USED ALARM NOTIFICATION PLATFORM IN INDUSTRY AND IIoT

Installation requires the following Windows Features:

- IIS Management Console disabled
- IIS Default Document disabled
- IIS Static Content disabled
- IIS Basic Authentication disabled
- IIS HTTP Redirection disabled
- IIS Windows Authentication disabled
- IIS ASP .NET 4.5 disabled
- Internet Information Services disabled
- IIS Application Initialization disabled
- .NET WCF HTTP Activation disabled

Damage Report
Operator

15m

Read Install Guide

Requirements have not been met. Click the 'Enable Features' button to continue.

Enable Features

Cancel

Feature requirements include the following:

- Microsoft .NET 4.8
- Windows Edition and Feature Set Detection
- IIS Features: Application Initialization, Basic Authentication, Windows Authentication, HTTP Redirection and ASP.NET 4.5, HTTP Activation

Any missing feature can be enabled by clicking the Enable Features button at the bottom right.

Note: If these requirements are met, this page will not appear.

SQL Server Installation

When joining an existing WIN-911 system, you have the option of creating a distinct SQL instance on the new host or you may utilize the existing SQL instance.

Note: It will be easier to conduct SQL backups when using a single instance, however, this will require network access.

The install script will check the WIN-911 host for an SQL Server instance named "WIN911". If there is no suitable SQL Server, the following pop-up will appear:

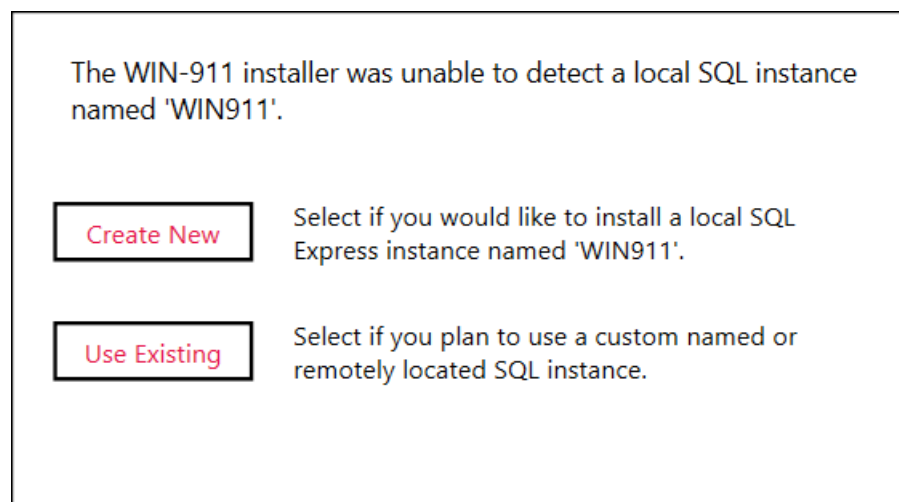

This is an optional step and is not required in order to continue with the installation, but WIN-911 cannot be used until the SQL Server requirement is satisfied.

Note: if you are upgrading, you should select "Use Existing" to keep your existing data.

InstallShield Wizard

WIN-911 THE MOST WIDELY USED ALARM NOTIFICATION PLATFORM IN INDUSTRY AND IIoT

WIN-911 Install 4.20.13 requires the following items to be installed on your computer. Click Install to begin installing these requirements.

Status	Requirement
Pending	WIBU CodeMeter Control Center 7.00.3933.502
Pending	VC++ 2008 Security update
Pending	Silverlight
Pending	Microsoft Visual C++ 2010 SP1 Redistributable Package (x64)
Pending	Microsoft Visual C++ 2008 SP1 Redistributable Package (x64)
Pending	Microsoft Visual C++ 2015 Redistributable Package 24215.1 (x64)
Pending	Microsoft Visual C++ 2015 Redistributable package 24215.1 (x86)
Pending	Microsoft Visual C++ 2019 Redistributable Package (x64)
Pending	Microsoft Visual C++ 2019 Redistributable Package (x86)

15m

Damage Report

Operator

InstallShield

Install Cancel

Depending on the state of .NET Framework 4.8, you may need to reboot prior to continuing.

WIN-911 Install 4.20.13 - InstallShield Wizard

This installation of WIN-911 Install 4.20.13 required a reboot. Click Yes to restart now or No if you plan to restart later.

Yes No

If requested, select Yes and the install process will resume automatically once the reboot is performed.

The WIN-911 InstallShield wizard will now guide you through the WIN-911 setup. Click **Next** to continue.

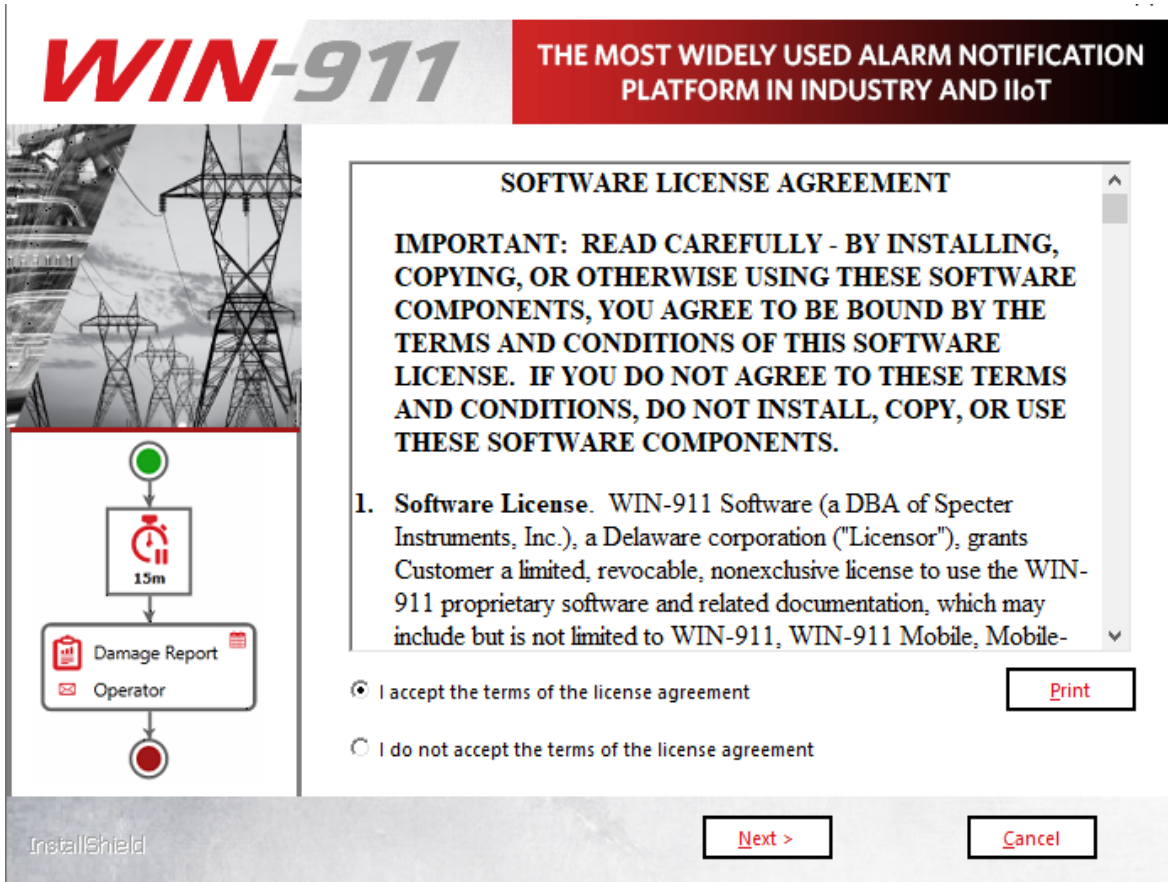

Accept the terms of the Software License Agreement by clicking the top radio button and then select **“Next”** to advance.

WIN-911 Distributed Systems

When you are joining an existing distributed system you will now be asked to locate all previously installed WIN-911 modules which are part of that system. If you are creating a distributed system or standalone system, then you will not see this step of the installer.

WIN-911 THE MOST WIDELY USED ALARM NOTIFICATION PLATFORM IN INDUSTRY AND IIoT

Logical System

All WIN-911 Modules which communicate with one another belong to the same Logical System. Please name your Logical System and verify the listing of its currently installed Modules below. Use the 'Browse' button to locate missing Modules.

WIN-911 Logical System Name:

Existing Modules:

The installer will attempt to discover all previously installed modules with a broadcast on UDP port 3702; however, this discovery attempt will be blocked on many networks. If the discovery results do not display all existing modules, simply click the browse button and browse for or enter the computer name for the target system hosting WIN-911 modules. If no modules can be found on the target system, verify that your network environment allows for communication and authentication of the user attempting this install.

Once all existing modules have been located, select 'Next' to continue with the installation. **IMPORTANT:** Do not continue the installation until all existing modules appear in the list.



Logical System

All WIN-911 Modules which communicate with one another belong to the same Logical System. Please name your Logical System and verify the listing of its currently installed Modules below. Use the 'Browse' button to locate missing Modules.

WIN-911 Logical System Name:
WIN-CLJHD1MGS36-911

Existing Modules:

- WIN-CLJHD1MGS36-911 (1 Computer)
 - win-cljhd1mgs36 (3 Modules)
 - Navigation
 - Dispatcher
 - Reporting

Read Install Guide Next Browse Cancel

Ensure that all of the existing modules appear under the tree. If multiple systems are found select the system you wish to join.

Confirm Logical System.

Confirm Logical System ×

 Please confirm you have located all existing modules for the selected Logical System. Use the 'Browse' button to locate any missing modules.

Are you sure you have located all existing modules?

Yes No

If all expected modules appear click Yes to continue.

Click Next to continue.

The WIN-911 InstallShield wizard will now guide you through the WIN-911 setup. Click **"Next"** to continue.

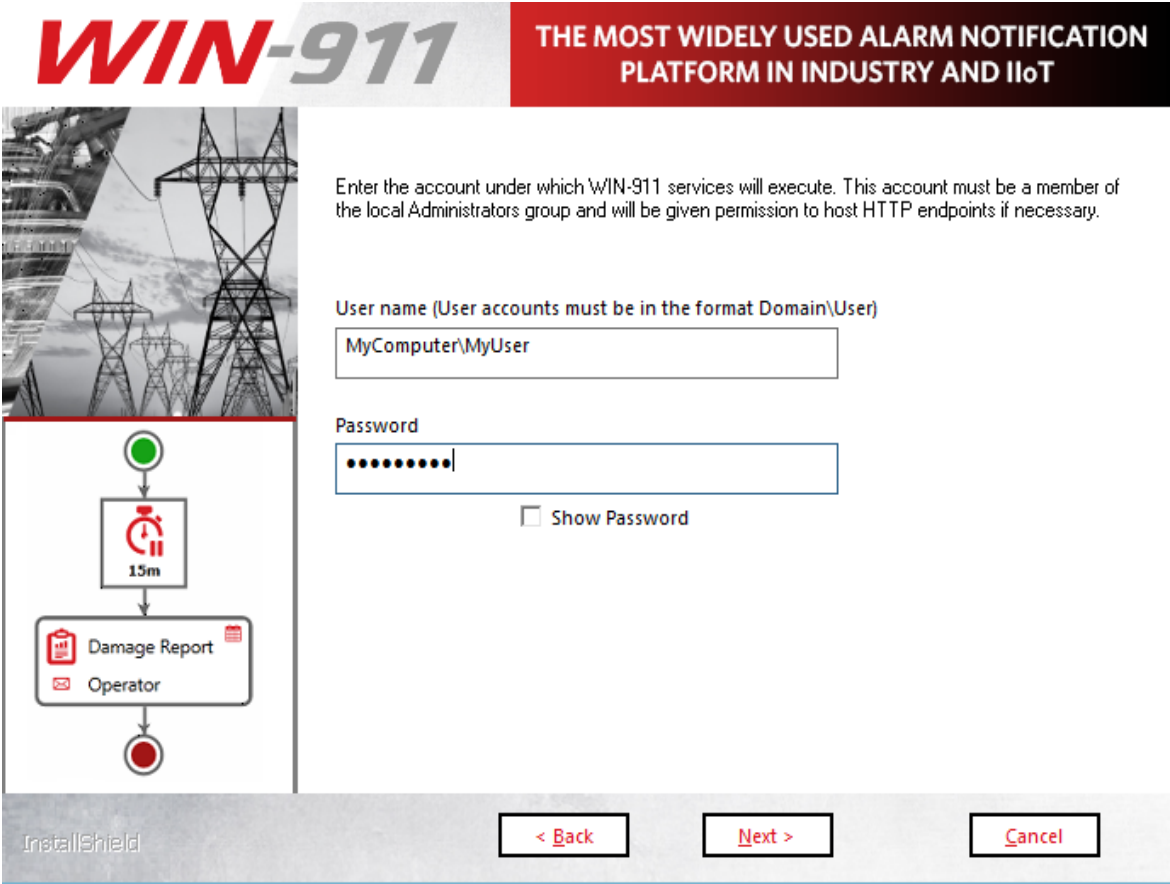

Enter the "DOMAIN\username" and password that WIN-911 Services will run under. If a username and password are not yet set up in the operating system you can use the **"New User Information ..."** script to create one (Windows 8 and higher). This can be found via the control panel, User Accounts. For Active Directory users you will need

WIN-911 User Guide

to contact your network administrator or log onto a domain control to create an account with the proper permissions. **When entering a domain user's name be sure to include the fully qualified domain name.**

Note: You must be logged in and executing this installation as an owner and administrator of the SQL instance. Additionally, the selected user here (if different) must be a member of the Windows local or domain administrator group with administrative privileges on the SQL instance.

WIN-911 THE MOST WIDELY USED ALARM NOTIFICATION PLATFORM IN INDUSTRY AND IIoT

Select the SQL Server instance to use for WIN-911 data storage. If you selected 'Use Existing' earlier, please specify your existing server below. Note that both the installing user and WIN-911 user selected previously (if different) must have SQL permissions.

Database Server:

MyComputer\WIN911

Note: Existing data will be migrated upon upgrade and will be re-initialized for modules being re-installed.

Browse...

< Back Next > Cancel

InstallShield

Select the desired database server from the pull-down list. (Server OS's may require you to enable/start SQL Server Browser service in order to browse for SQL Servers)

If you do not see your target server, you may type it into the text entry field as you see it from SQL Management Studio.

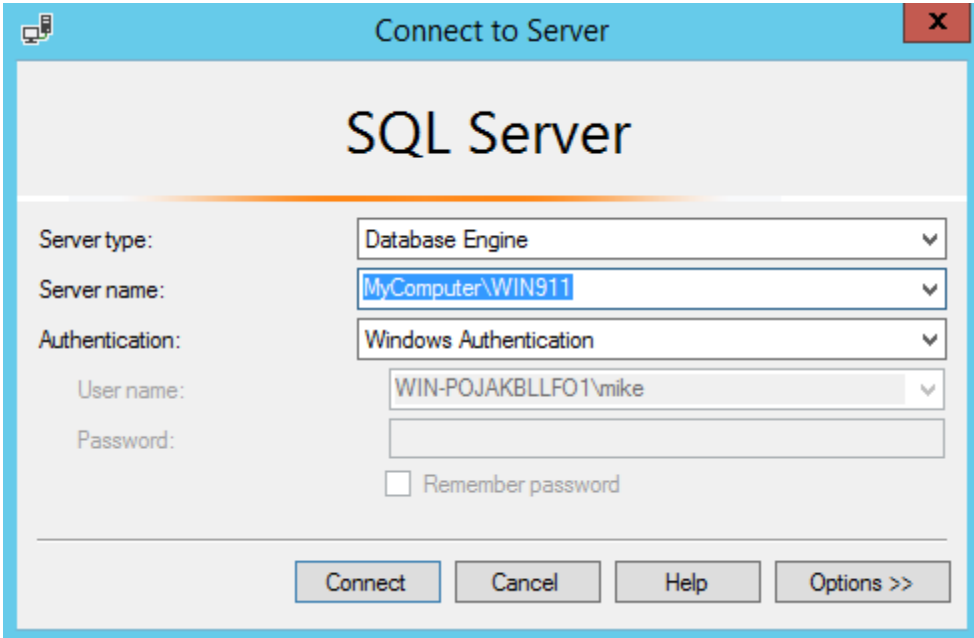

Click "**Next**" to advance.

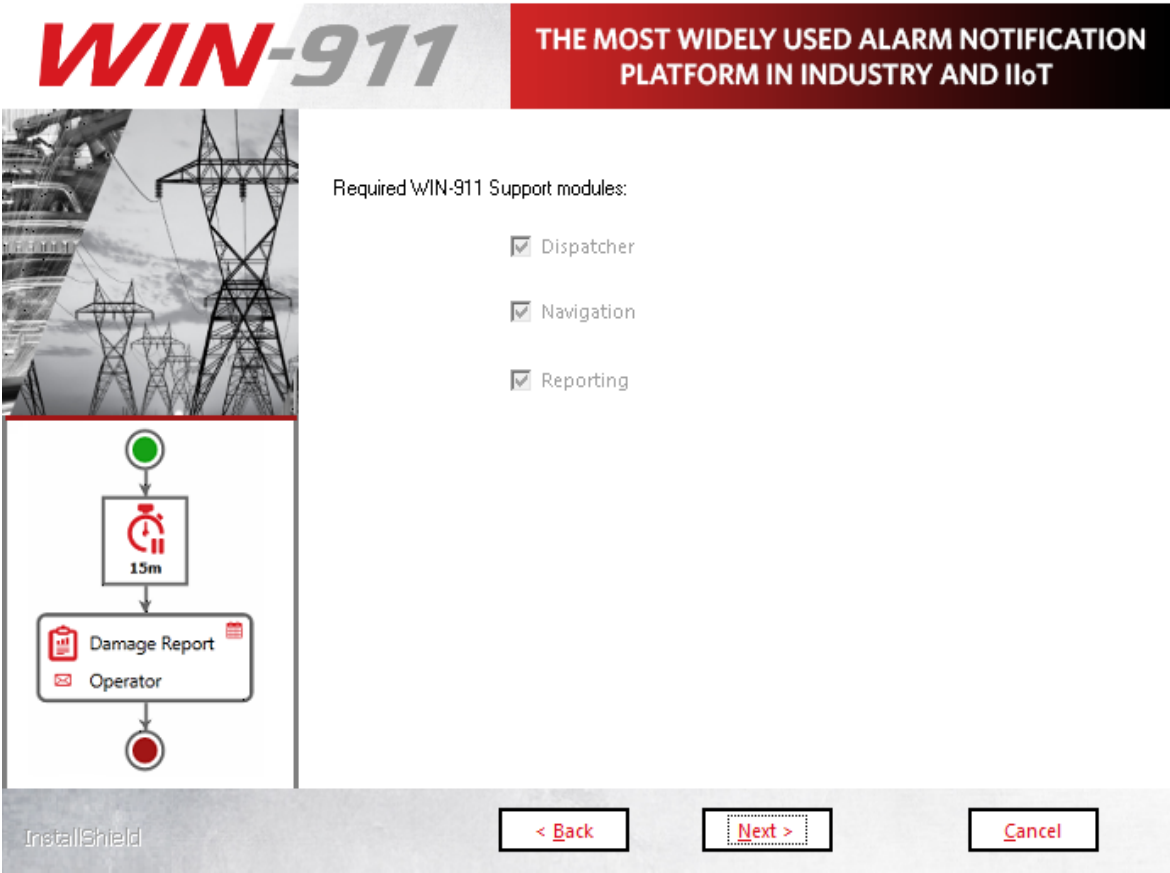

WIN-911 User Guide

To create a distributed WIN-911 System you must install all support modules on the primary (Dispatcher) WIN-911 host. Thus, all support modules are displayed as already existing on a remote computer.

Click **Next >** to advance.

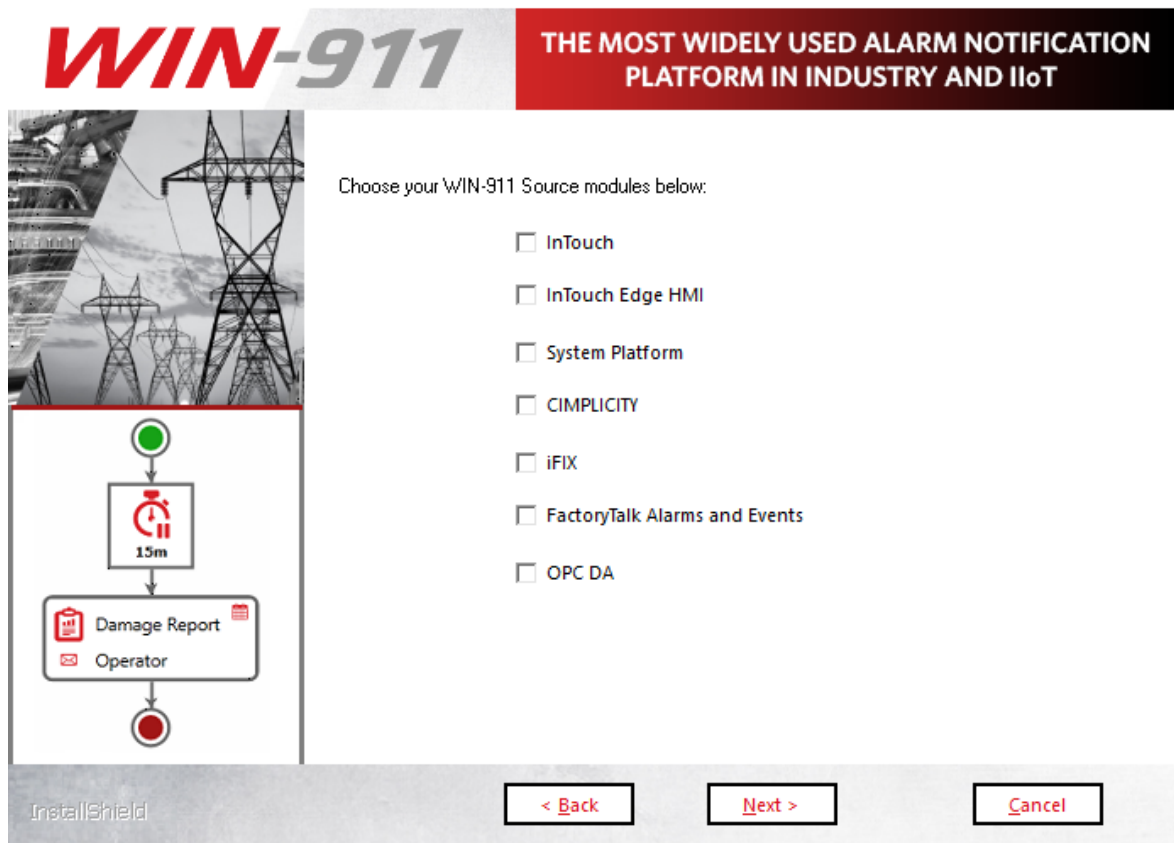

Source modules provide connectivity to various data sources that WIN-911 supports. The source module selection menu allows you to choose which components of WIN-911 you install. Only install the source modules you intend to use. You can always add features later that are not originally installed by re-running the setup.

Any existing remote modules will be displayed as such. You may install additional source modules on this computer. Your distributed system will need at least one source module.

If a selection box appears greyed out, then the option is either required or already present.

Note: Some sources require selection of specific HMI/SCADA versions.

Click “Next” to advance.

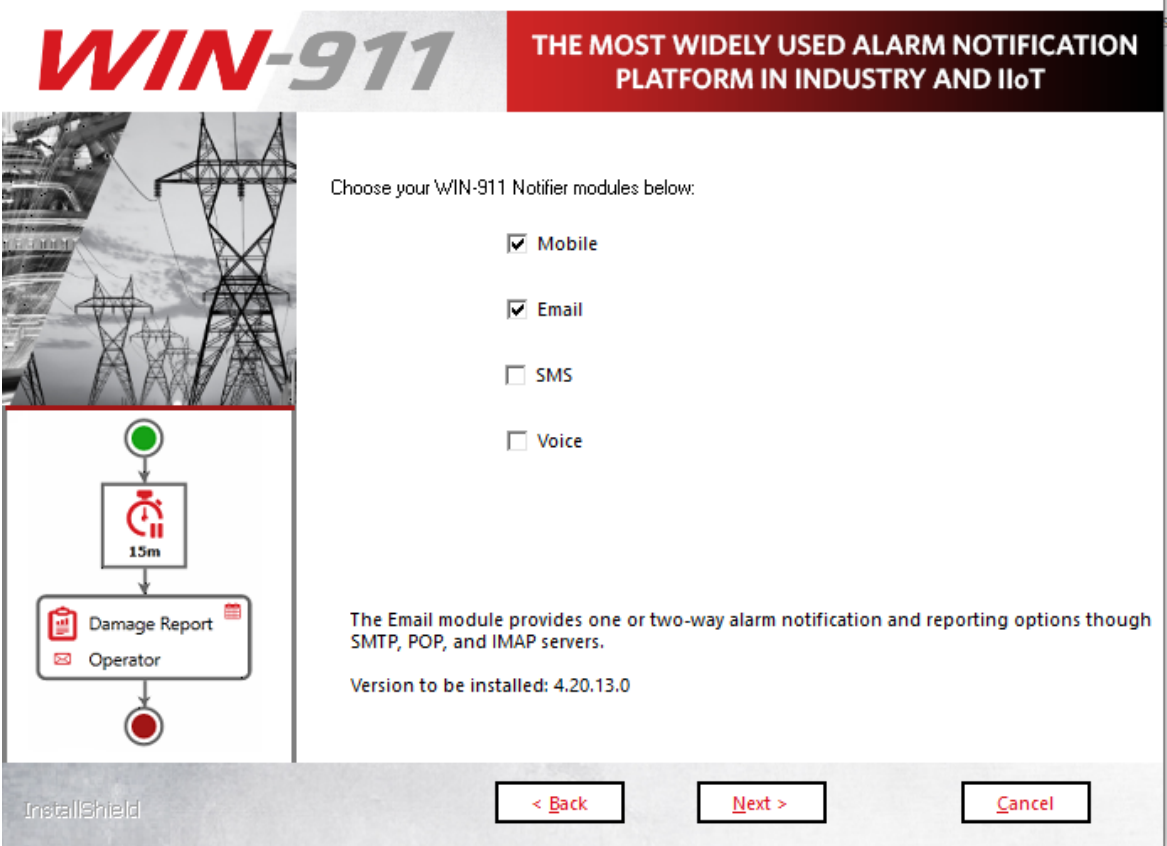

WIN-911 provides several methods of remote notification to users; including Mobile, Mobile-911, Email, SMS, and Voice. The notifier module selection menu allows you to choose which components of WIN-911 to install. Only install the notifier modules you currently intend to use. You can re-run the setup program later if decide to add notifiers to your system.

WIN-911 User Guide

Any existing remote modules will be displayed as such. You may install additional notifier modules on this computer. Your distributed system will need at least one notifier module.

If a selection box appears greyed out then that option has already been installed.

Click **“Next”** to begin the installation and initialization phase of the setup.

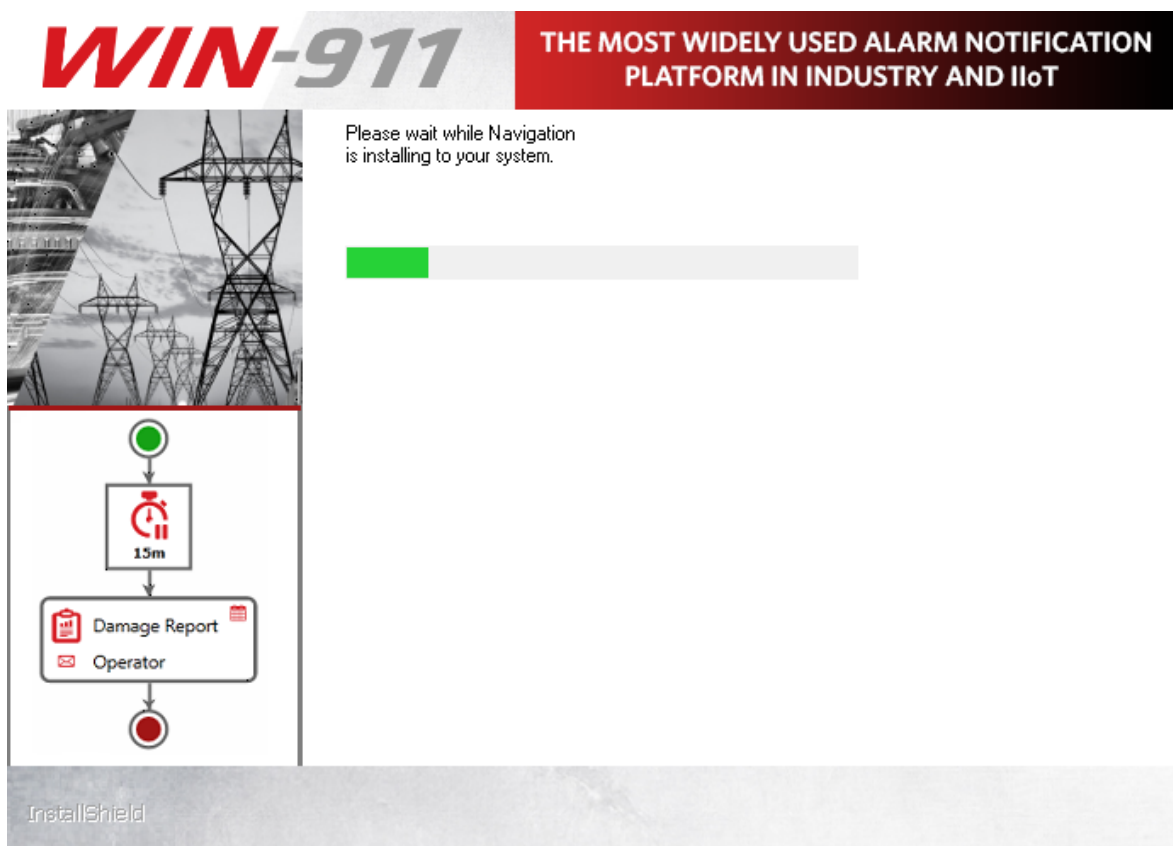

This portion of the install may take several minutes.

WIN-911

THE MOST WIDELY USED ALARM NOTIFICATION PLATFORM IN INDUSTRY AND IIoT



Setup Complete

Setup has successfully installed WIN-911 Install 4.20.13.

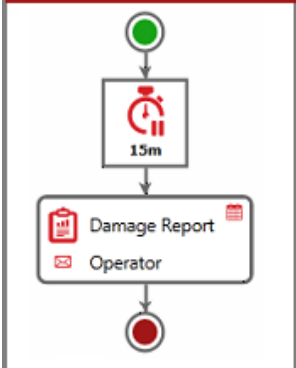

InstallShield

< Back

Next >

Cancel

Click Finish to conclude the installation process.

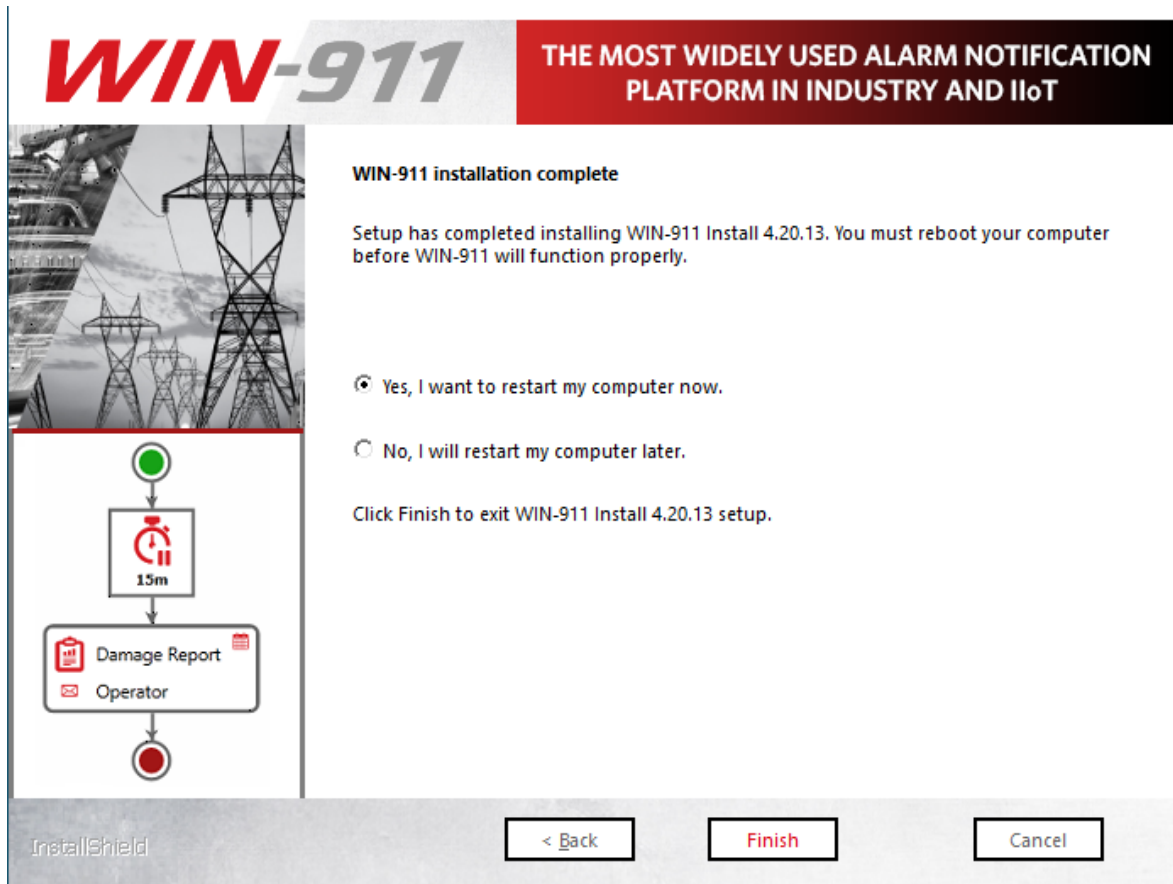

Once the installation completes, a restart will be required **before WIN-911 can be used**. You can elect to do so immediately or later. Make your selection and click ***Finish***.

[Modifying and Licensing WIN-911](#)

WIN-911 Overview

WIN-911 provides an innovation to alarm notification products and methods. With these new concepts, complex alarm notification rules can be easily rendered, significantly reducing development, deployment, and maintenance efforts. WIN-911 Software introduces a novel flow chart-style graphical interface to easily set up notification "Strategies" and "Tactics." Appropriate strategies are triggered by events such as an alarm state (for example, a new alarm condition or alarm that has recurred within a defined amount of time, etc.), and in response the strategy invokes a set of instructions (tactics) based on the policies developed by the WIN-911 administrator. Each tactic can contain multiple instructions and can even contain other tactics (which are referred to as sub-tactics). The method of assembling remote alarm notification scenarios afforded by WIN-911 is substantially easier to build, understand, visualize, and modify than other currently available products.

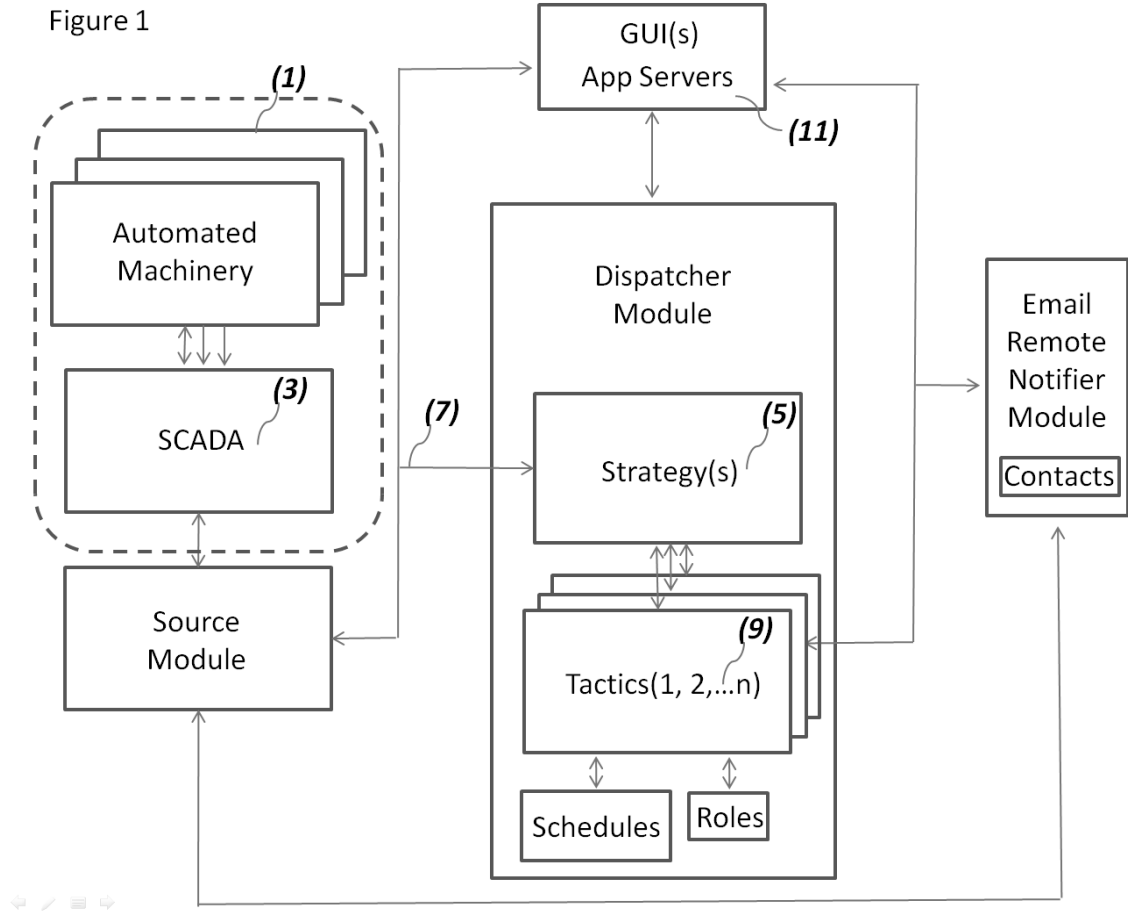

Figure 1 is a conceptual drawing that shows both the environment of WIN-911 Version 8 and its main components. The typical environment will be a plant or factory controlled by automated machinery (1) embodying programmable logic controllers (PLCs) or the like. Such machinery will typically be integrated into a SCADA network (3) hosted by operating systems that will likewise host WIN-911. The automated machinery uploads its data to the SCADA Network which centralizes that data in a well known manner and makes it available to other applications and services running within the operating systems. WIN-911 may comprise user-defined modules that query data from the SCADA network and invoke strategies that receive alarm events and queue tactics that conduct remote notification procedures. A configuration can contain an unlimited number of strategies (5). Based upon a derived alarm event (7) each strategy can then invoke any

number of user defined tactics (9). Each tactic may comprise a logical series of tasks that handle alarm event messaging based on predetermined conditions and user input. The tasks are configured by utilizing a set of instructions that are subdivided into notifications, decisions and miscellaneous. A tactic can likewise invoke other tactics, which are called sub-tactics. When the tactics are complete or the alarm event terminates, the tactics and strategies end.

WIN-911's architecture is distributed between software modules that seamlessly interact with each other. Each module consists of three primary components which include an application server and GUI that runs within Microsoft's Internet Information Services (IIS) (11). This allows the invention to be programmed and monitored through internal password protected URLs that can be accessed by any computer in the network. The third component is the runtime executable that runs in the Operating System's Services. The module manifest includes the dispatcher, data source, Email notifier, and report modules, which are detailed below.

Dispatcher

The Dispatcher module is the primary component of WIN-911's infrastructure. It maintains the execution of all strategies and tactics; receives and implements programming from the GUI whenever a schedule, strategy, tactic, or role edit is saved, and directs notifier modules during runtime operations.

Data Source

The data source module communicates directly with the SCADA network and receives alarm event data which it distributes to the Dispatcher and the GUI. It receives and implements programming from

the GUI whenever an edit is saved and works in conjunction with the GUI to conduct alarm database imports. The module subscribes to alarm services provided by the SCADA and validates the data's integrity and security. It also receives alarm acknowledgement messages from the Email notifier modules which it delivers to the SCADA and receives acknowledgement confirmation messages which it routes to the controlling strategy.

Notifier

Notifier modules receives remote notification tasking from tactics running in the Dispatcher, subscribes as a client to the configured gateway server, and contains the contact connection and gateway data entered from the GUI. It receives and implements programming from the GUI whenever an edit is saved. It utilizes the configured notification protocols to deliver alarm messages, receives responses from the alarm-responder with alarm acknowledgement requests and report requests which it relays to the data source module for processing by the SCADA.

Reporting

The Reporting module receives report tasking from tactics running in the Dispatcher Module and interfaces directly with the data source and notifier modules to conduct reporting as required by a tactic or an alarm-responders request. The Reporting module receives and implements programming from the GUI whenever an edit is saved.

Figure 2

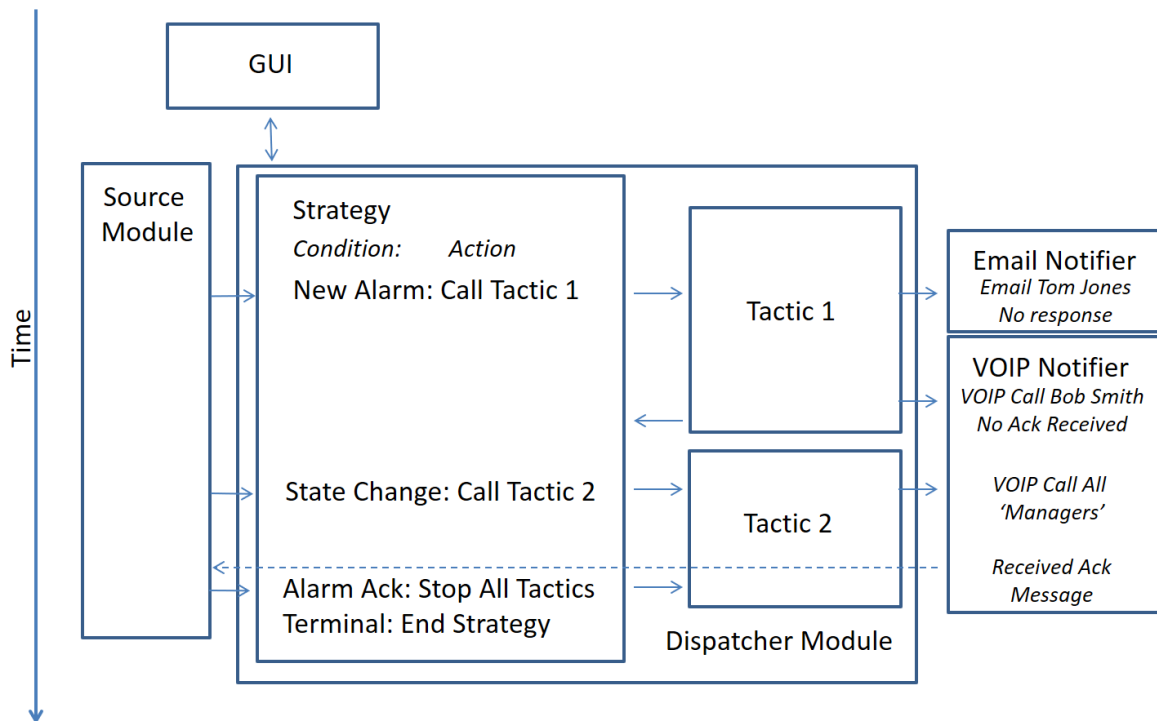

Figure 2 shows a hypothetical time-based series of events that demonstrate the interaction of the modules during runtime. This figure highlights how strategies and tactics share information in order to execute remote notification rules during the life of an alarm event.

The scenario begins when the WIN-911 administrator assigns an alarm event to the strategy he/she developed in the GUI.

Sometime after the configuration goes live the source module delivers an alarm event message that it received from the SCADA and routes it to the associated strategy within the Dispatcher module.

The strategy processes the alarm event condition according to its policy and calls Tactic 1.

Tactic 1 immediately instructs the Email Notifier to send an alarm message to Tom Jones and waits the configured amount of time for a response from Tom.

After the elapsed time expires, Tactic 1 again instructs the Email Notifier to call Bob Jones and deliver the alarm event message and process Bob's response, if any. In the scenario Bob declines to acknowledge the alarm and Tactic 1 informs the strategy and terminates.

Sometime later the source module receives an updated message from the SCADA that the alarm event has escalated and routes the update to the Strategy. The escalation event takes the form of a state change and the strategy's state change policy calls Tactic 2.

Tactic 2 instructs the Email notifier module to broadcast an asynchronous batch of Email messages to all Email connections designated with "Manager" roles. One of them responds with an acknowledgement code which the Email notifier relays to the source module and subsequently delivers acknowledgement request to the SCADA.

The SCADA accepts the acknowledgement and informs the source module. The source module routes the acknowledgement confirmation to the strategy which stops all tactics in progress in accordance with its alarm acknowledgement policy and then terminates the strategy.

Overview of Tactics and Strategies

Tactics are smart notification lists that determine who gets notified and in what order. Strategies receive alarm events and invoke tactics in response. As the state of the alarm changes the strategy updates the

tactic by stopping it, restarting it, or invoking an entirely different tactic. When the alarm state becomes terminal (inactive and acknowledged) the strategy concludes by ending all associated tactics. So, tactics determine who gets notified, and strategies determine when.

Two kinds of tactics are available for the WIN-911 user: 1) Basic and 2) Advanced. The basic tactic (Figure 3) is a simplified, straightforward callout list that operates in a synchronous fashion using configurable delays to stagger the callout progression. Advanced tactics (Figure 4) utilize a highly configurable notification flowchart that give the user the ability to render complex escalation rules in an intuitive visual format.

Name: Escalation Routine 2

Description:

Delay Before Notification: Minutes 0 Seconds 0

Repeats: 0

Connection	Type	Retries	Delay Between Retries	Delay After
<input type="checkbox"/> Tom Jones		0	Minutes 0 Seconds 0	Minutes 2 Seconds 0
<input type="checkbox"/> Wayne Smith		0	Minutes 0 Seconds 0	Minutes 0 Seconds 0

Navigation icons: +, -, ^, v, and trash.

Figure 3: Basic Tactic

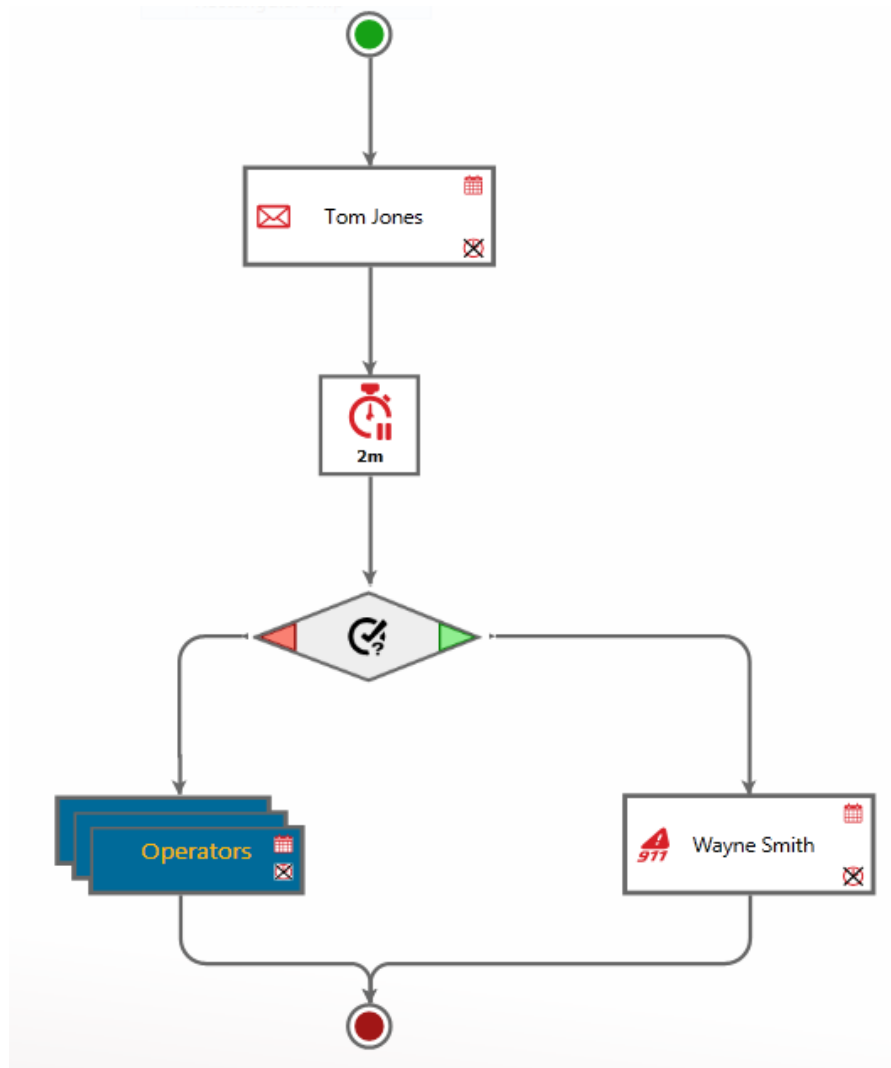



Figure 4: Advanced Tactic

Strategies are composed of policy statements that specify a condition and a subsequent action. For example: a policy could state that when an initial alarm event occurs a particular tactic is to be invoked to dispatch alarm notifications. The condition would be the initial alarm event and the action would be to start tactic X.

In its simplest form (Figure 5), a strategy will contain three policy statements, 1) an initial condition -> start tactic x, 2) on a change of state -> renotify, and 3) on termination of the alarm event -> Stop Strategy. An unlimited number of policy statements (Figure 6) can be used by clicking the Advanced Mode button.

Tactics 

Name

Description

Start Tactic 

Stop Condition

Advanced Mode

Policies

Initial Event → Start Tactic *Escalate Level 3*

Any Alarm State Change → Re-Notify

Alarm Becomes Terminal → Stop Strategy



Figure 5: Strategy

Tactics 

Name

Description

Policies

Condition	→	Action
<input type="text" value="Initial Event"/>	→	Start Tactic <input type="text" value="Escalate Level 3"/> 
<input type="text" value="Any Alarm State Change"/>	→	Re-Notify <input type="text"/>
<input type="text" value="Alarm Becomes Terminal"/>	→	Stop Strategy <input type="text"/>
<input type="text" value="Alarm Becomes Acknowledged"/>	→	Stop Tactic <input type="text" value="Escalate Level 3"/> 
<input type="text" value="Unspecified"/>	→	Re-Notify <input type="text"/>



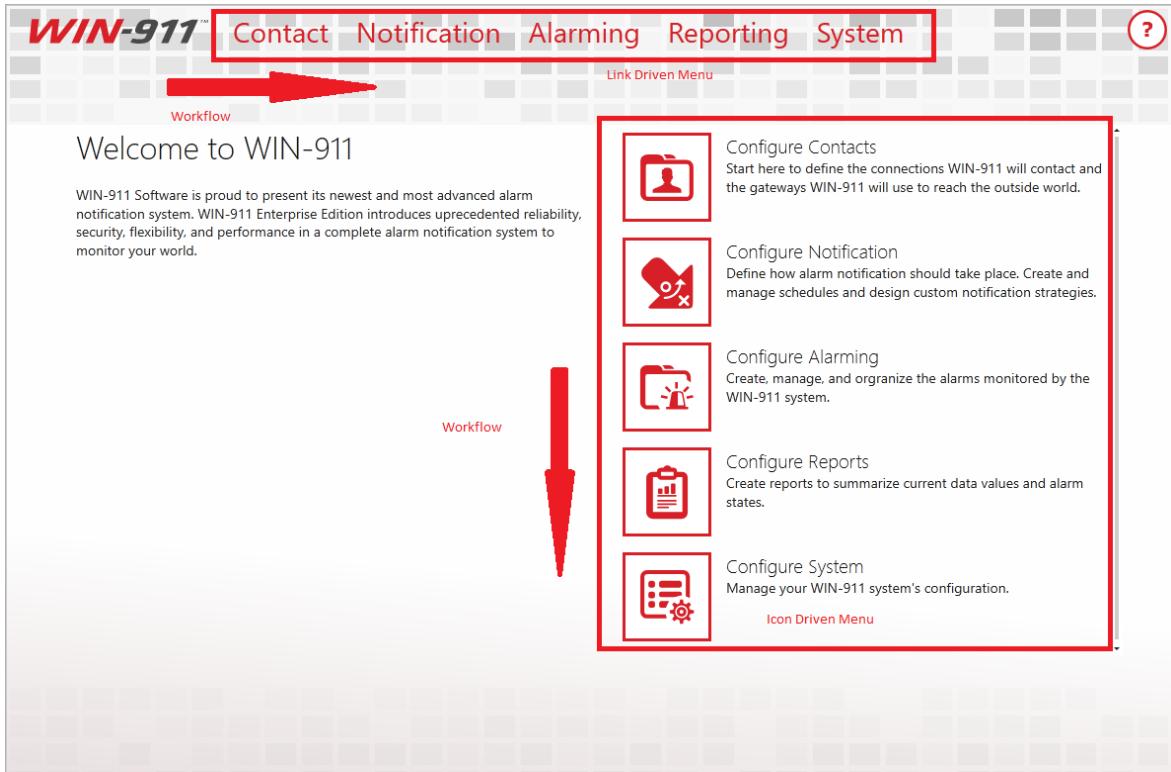

Figure 6: Advanced Mode Strategy

WIN-911 Graphical User Interface Basics

WIN-911 introduces a website driven GUI that can be accessed anywhere on the network. This frees the user to configure WIN-911 from any computer on site after providing the proper credentials.



The GUI is logically designed to follow a left-to-right (and top to bottom) configuration workflow that is largely self-documenting. Across the top is a link-driven menu that provides navigation to all the WIN-911 workspaces. The large icon menu located in the center of the welcome page is the more verbose workspace and leads the user through the configuration process with little need to refer to user documentation. In the event that more information is required a help icon can be found on the upper right corner.

Connections Selector List

On the left side of any workspace that exposes multiple objects for editing is a collections selector list. Each list is equipped with powerful tools for sorting, filtering and grouping the objects based on their properties. The active sorting column is indicated by a black triangle in

the middle of the column heading. Active filtering is indicated by a yellow column header.

In the example below the Mobile-911 Connections list is shown.

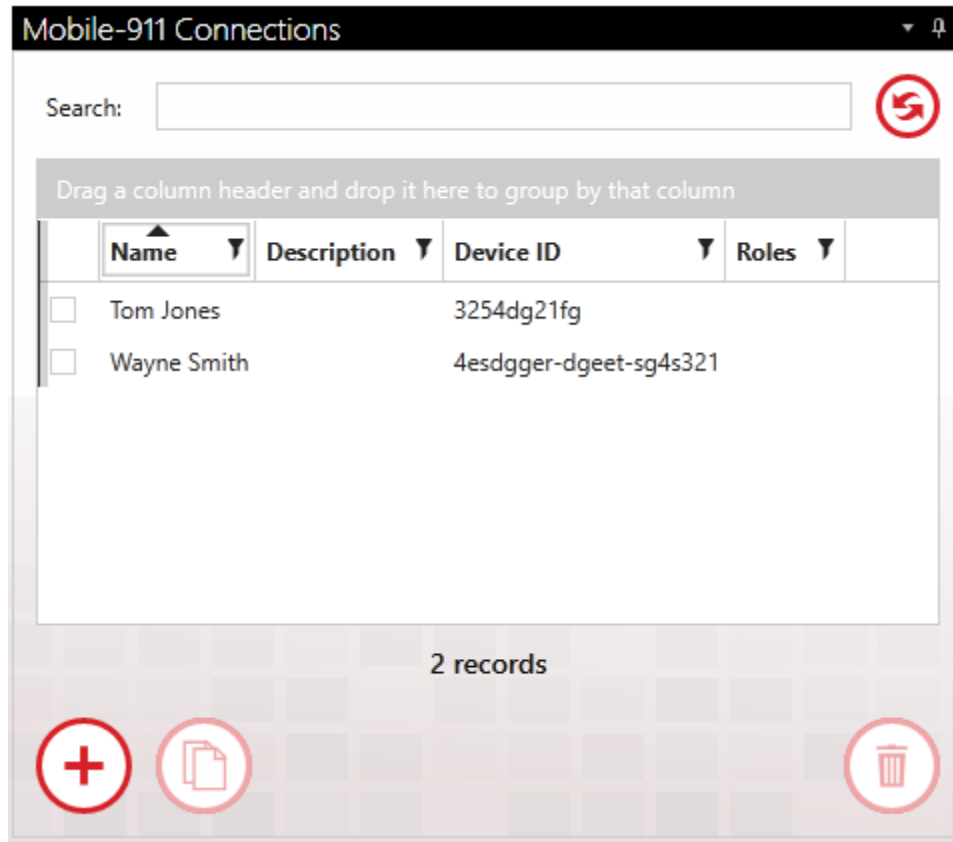

Selecting a connection to edit: An individual connection is selected by clicking the check box to the left of the connection's properties. Only one connection can be selected at a time.

Sorting

When the name column has a black triangle pointing down, the Mobile-911 connections will be arranged by name in descending alphabetical order. Clicking on the triangle will reverse the list and

cause it to be arranged in ascending order. A third click on the triangle will deselect the column. Any property column can be sorted.

Search

The search field will filter the Mobile-911 connections collection selector list by suppressing the display of Mobile-911 connections that do not contain the character string entered. Any property column can be searched. The search field will be highlighted yellow while the search filter is in session. The refresh button  to the right.

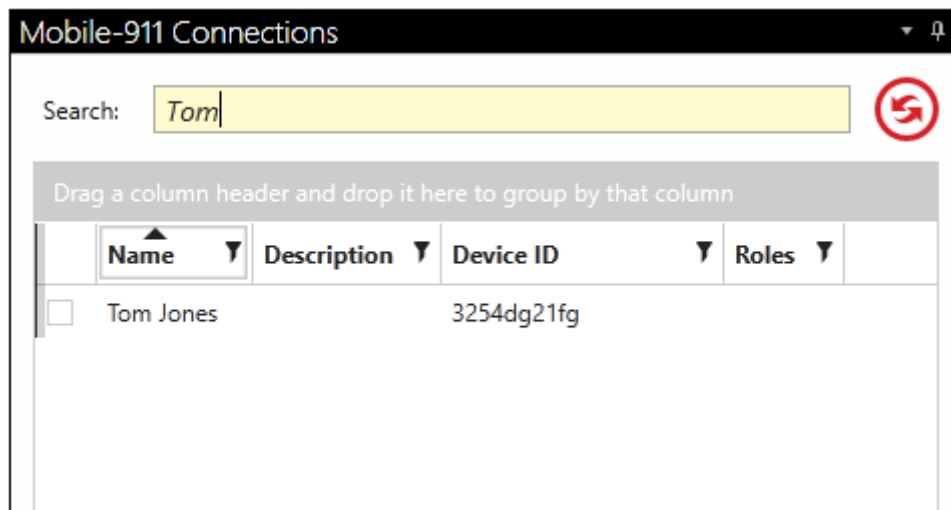

Filtering

On the right side of the property column heading is a black filter symbol. Clicking it brings up a custom filter design form. This form provides several options the WIN-911 administrator can use to exclude unwanted Mobile-911 connections from being listed in the collection selector. "And/Or" expressions can be created that key on the selected property data for inclusion or exclusion. A filter can be configured for any property column. The selected property (Name or Description) column header will be highlighted yellow while the custom filter is

applied. If more than one column has filters applied, each will be highlighted.

Grouping

Dragging and dropping a property column header into the grey area above the Mobile-911 connections list will cause the collection selector to group the Mobile-911 connections accordingly. The collection selector now lists the title of the selected object in bold font with a drop-down arrow to the left. Click on the drop-down arrow and the collection selector will drop a list of all the Mobile-911 connections that contain a particular object title. Groups can be compounded by dragging another object into the "Group by" field. Grouping can be removed by hovering over the group title and clicking the "X" that appears to the right of the title. Any property can be grouped.

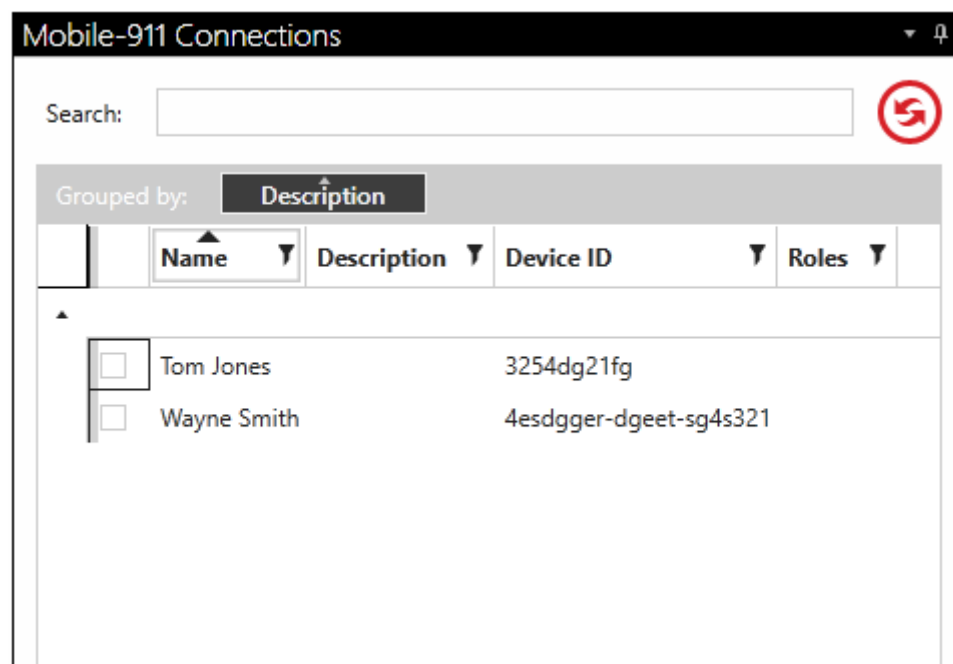

Create/Copy/Delete

WIN-911 User Guide

Select an object by clicking on the selection tick-box to the left of the object name. This will enable the Create, Copy, and Delete buttons on the bottom list. With them you can make copies of objects, create new ones and delete existing objects.

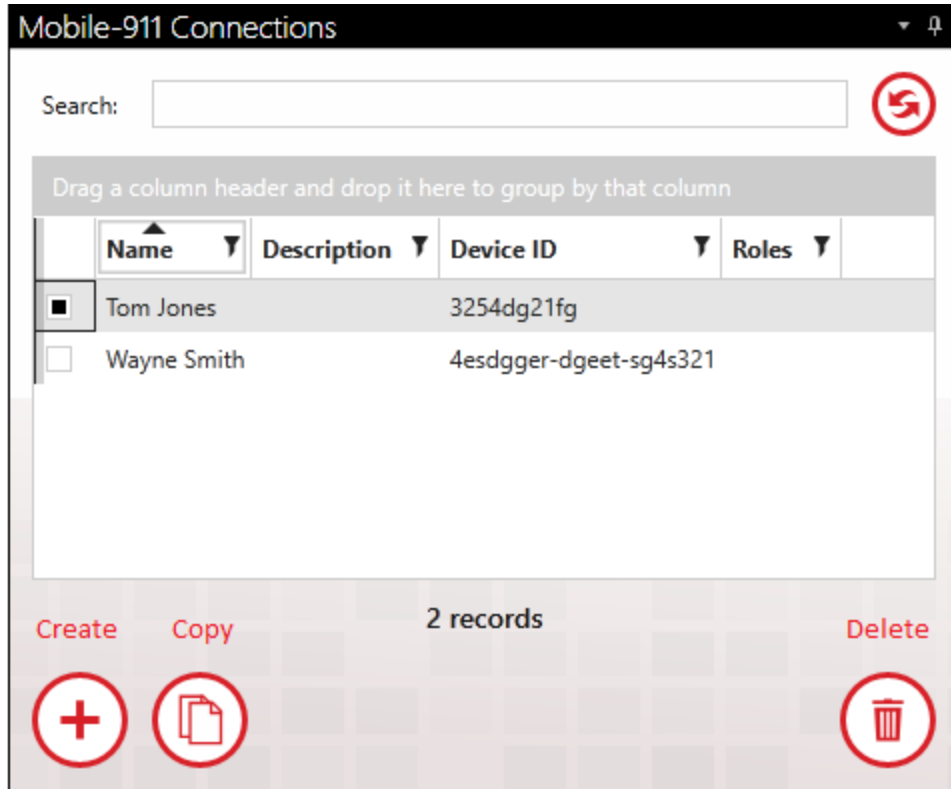

Example: Configuring an Advanced Tactic

Design advanced tactics by clicking the navigation links /notification/tactics/advanced_tactics/. Click the *add-create* icon (+) at the bottom right of the tactics list to bring up a blank advanced tactic workspace in edit mode (Figure 7). Enter a unique name for the tactic and give it a brief description in the fields provided. The blank tactic is represented by a green circular start node (where the tactic begins)

and red end node (where the tactic concludes) and directional link lines that represent the flow of tasking.

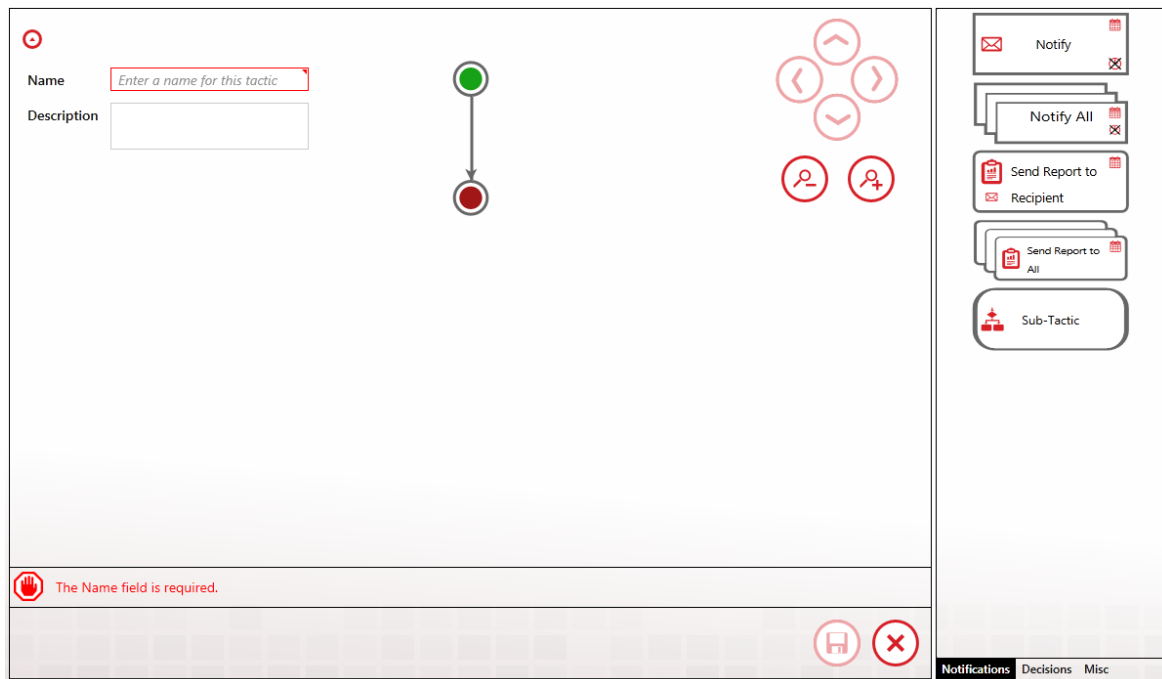

Figure 7: Blank Tactic Workspace

Drag and drop tactical instruction blocks from the right hand pane (1) directly into the tactic design workspace (2). Blocks are chosen from the three categories Notification, Decision, and Miscellaneous. Position the block by dropping it on the link in the place where you want the block to execute (Figure 8).

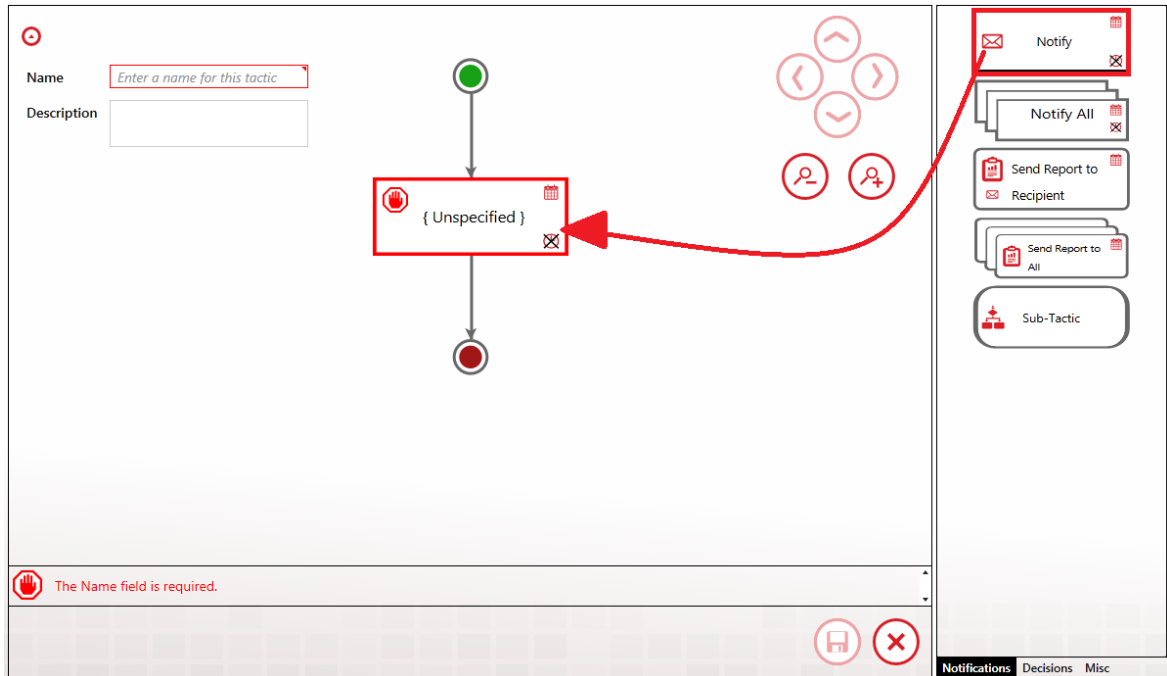

Figure 8: Placing Notification Block in Tactic

Once the notification block is in place, double-click over the center (Unspecified) of the block with your mouse to open the edit option selection box. Click to enter the edit dialog.

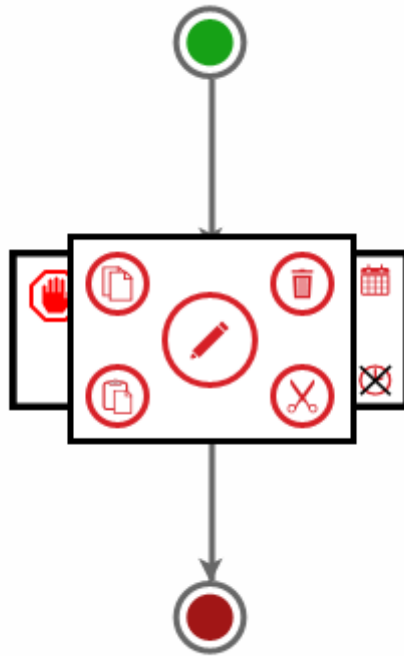

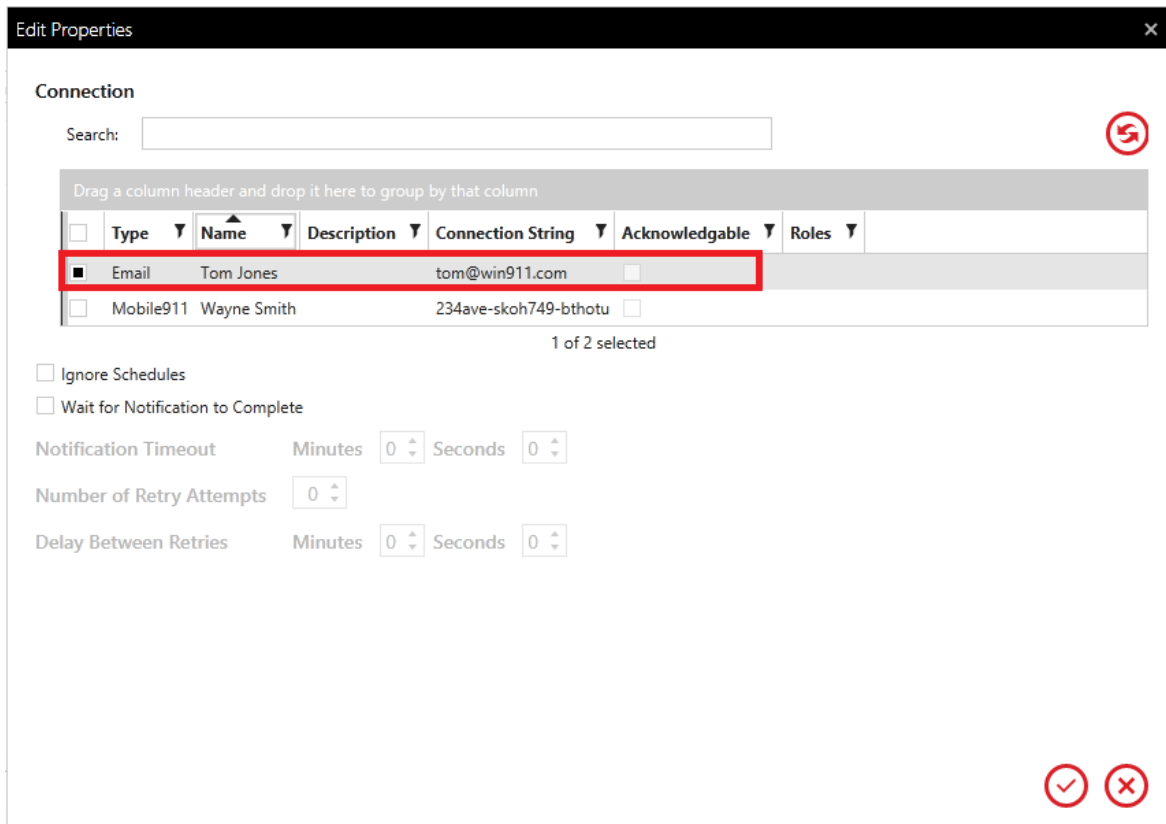

Figure 9: Entering Notification Block

The Edit Properties box will populate the connections list with all of the connections in your Contact database. Select the one you want to remotely notify and then close the properties box by clicking .

WIN-911 User Guide



Once the edit is complete the tactic will appear (Figure 11) with the Notification block appearing with the selected connection named and type of connection shown by the red icon on the left (in this example Tom Jones is an Email connection).

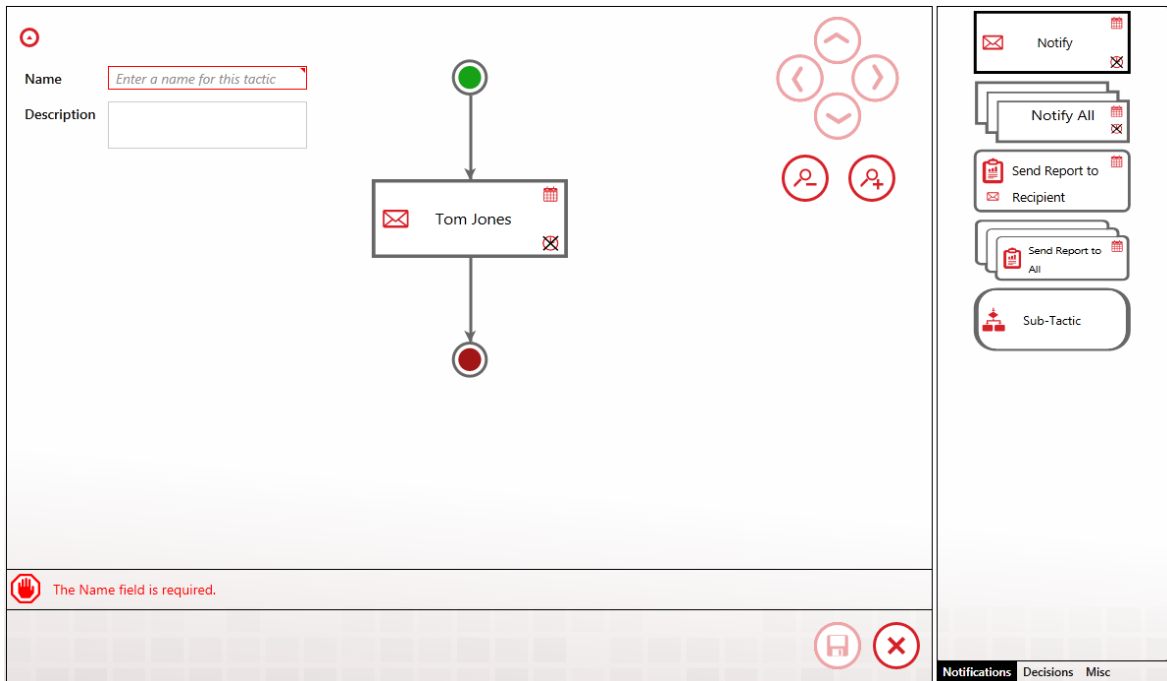

Figure 11: Complete Edit of Notification Block

To add a delay (Figure 12) between Tom Jones notification and the next task, click the Misc tab (1) at the bottom right. The Misc panel with display and from that click and hold the Delay block (2) icon and drag-and-drop (3) it on the tactic beneath Tom's Notification block.

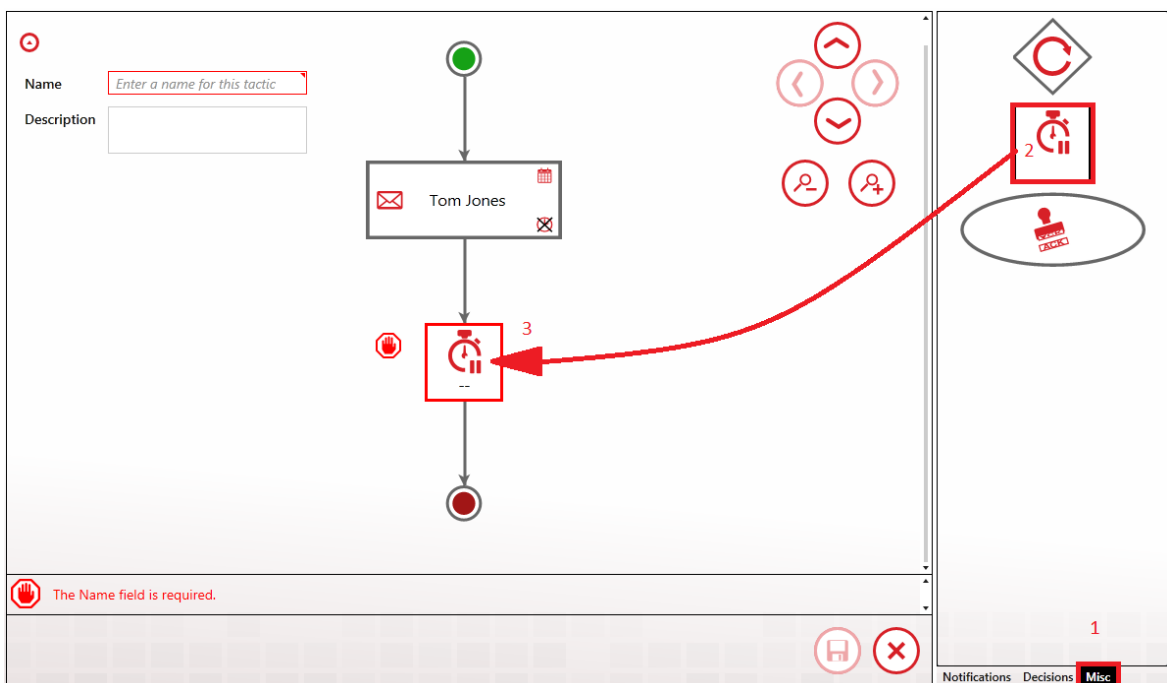



Figure 12: Adding Delay Block to Advanced Tactic

Double-click the center of the Delay block to open the Edit Properties dialog. From there, use the up-arrows in the Minutes combo-box to set the delay for 5 minutes. Click .

*Figure 13: Editing Delay Block Properties*

Next click the Decisions tab (1) and the Decisions selection panel appears. Drag-and-drop the Ack Decision block (2) on the tactic, beneath the Delay block (3). The left side of the Decision icon with the red tip points to the false path that the tactic will take of the alarm event is NOT acknowledged when the tactic reaches that point. If the alarm event IS acknowledged, then the tactic will make a right turn and take the true path.

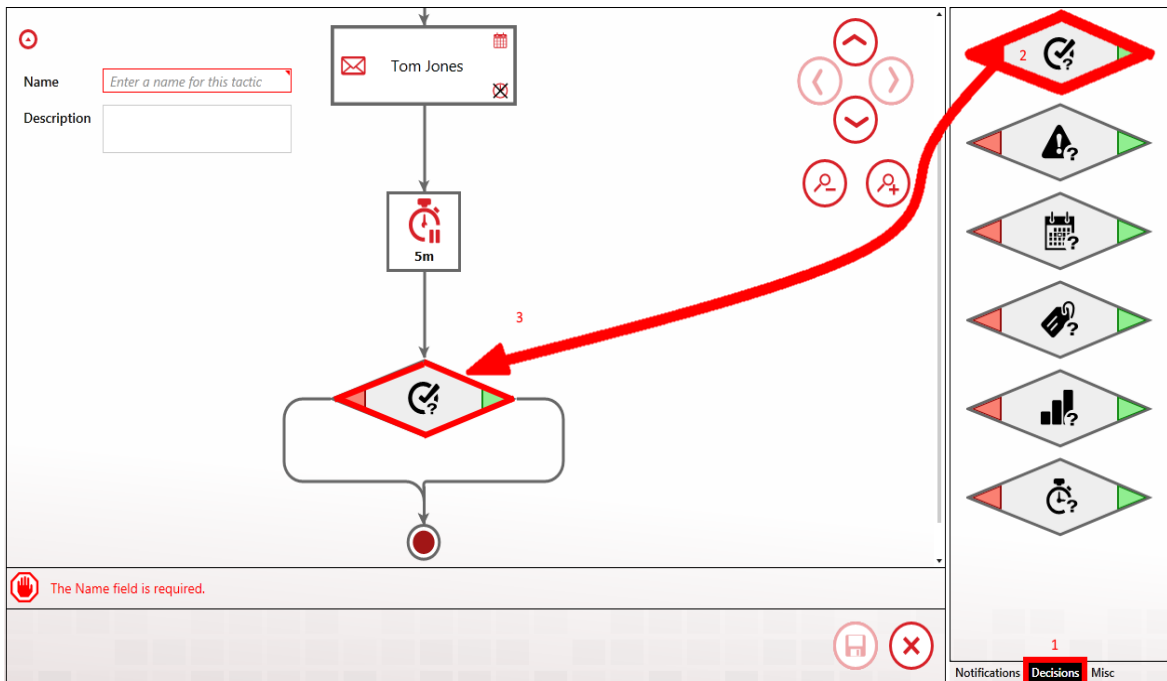

Figure 14: Adding Decision Block to Advanced Tactic

Lastly in this example, click the Notification tab (1) and the Notification panel reappears (Figure 15). Drag-and-drop the Notify All block (2) in the false path (3) of the Ack Decision block.

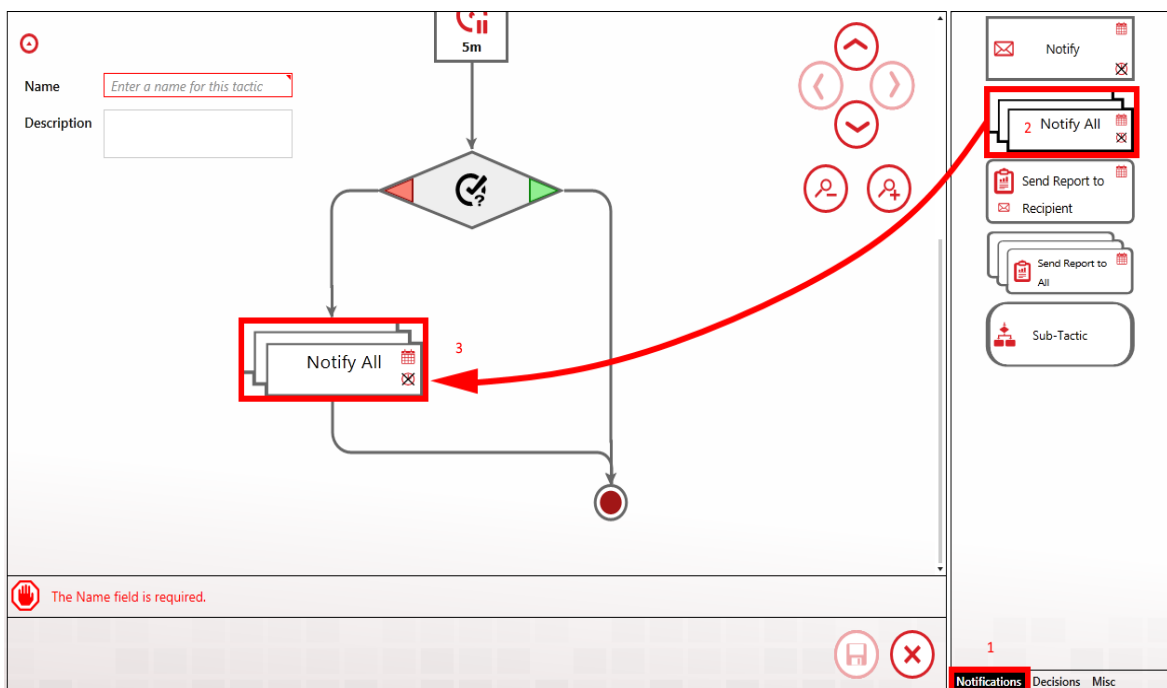



Figure 15: Adding Notify All to Decision Block

Edit the Notify All block by double-clicking the center of the icon. This will open the Edit Properties dialog (Figure 16) of the Notify All block. Select Operators Role and then click .

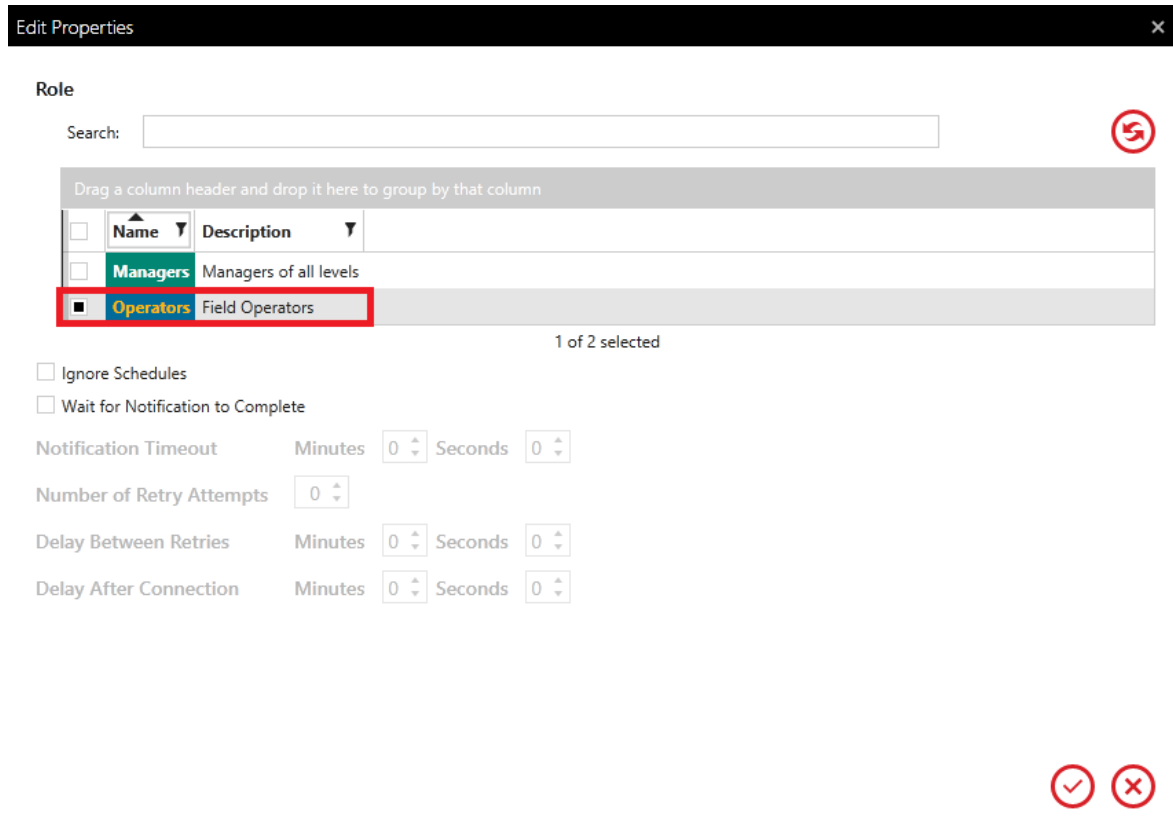

Figure 16: Notify All Edit Properties Dialog

The advanced tactic is now complete and ready to be saved (Figure 17), however, the button is disabled (1). The configuration information bar at the lower left (2) states that the tactic must be given a name before it can be saved. Enter a unique name in the Name field (3) and the save button will be enabled, allowing you to save the tactic for use in a strategy.

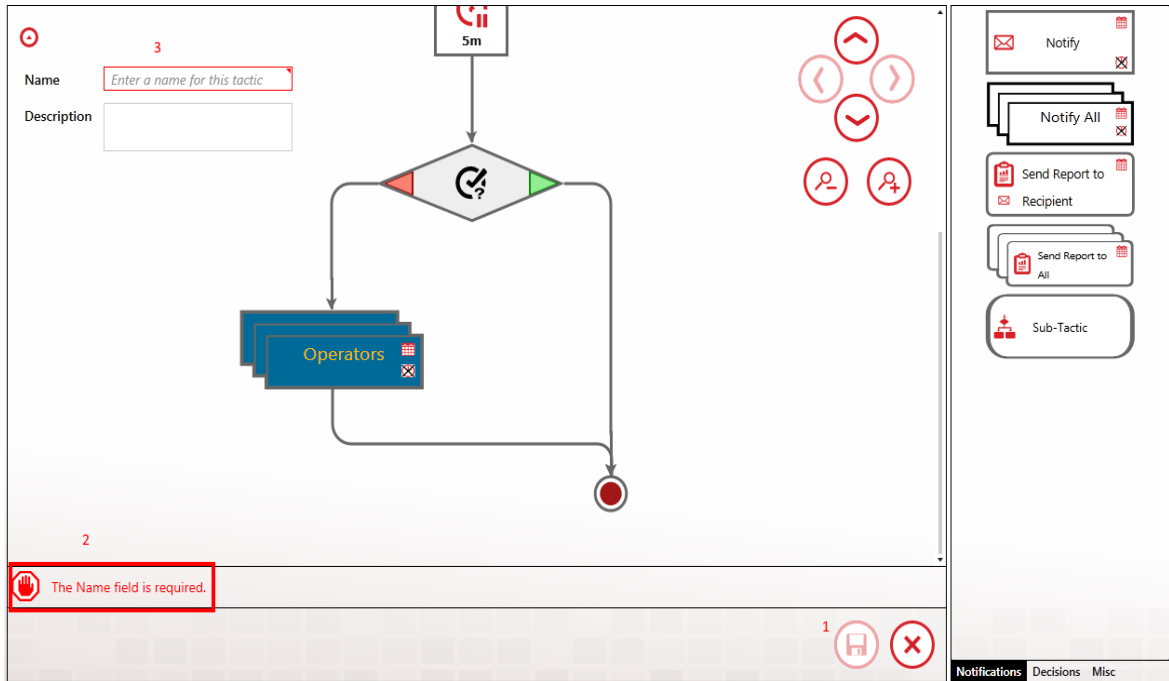

Figure 17: Tactic Complete

Getting Started with WIN-911

The following guide will explain some key concepts of WIN-911 by walking new users through the configuration of a simple alarm notification system with OPC DA and Email. While the specific technologies discussed may not be applicable to your system, WIN-911 has been designed in such a way that configuring a connection to one data source or configuring a specific notification method is not that different from configuring another. The fundamental concepts are the same and this guide will serve as an introduction to the platform as a whole.

Note: This scenario is based on the OPC DA datasource, due to its generic and wide-spread use. If you are using a different datasource, the details concerning your datasource configuration are likely to be significantly different in this respect.

There are three basic things that must be configured in every WIN-911 system: who must be notified, when must he be notified, and what he must be notified about.

Accessing the WIN-911 Configuration

The screenshot shows the WIN-911 Configuration website. At the top, the logo "WIN-911" is followed by navigation tabs: "Contact", "Notification", "Alarming", "Reporting", and "System". A question mark icon is in the top right corner. Below the navigation is a "Welcome to WIN-911" section with a brief description of the software. To the right is a vertical list of five configuration options, each with a red icon and a description:

- Configure Contacts**: Start here to define the connections WIN-911 will contact and the gateways WIN-911 will use to reach the outside world.
- Configure Notification**: Define how alarm notification should take place. Create and manage schedules and design custom notification strategies.
- Configure Alarming**: Create, manage, and organize the alarms monitored by the WIN-911 system.
- Configure Reports**: Create reports to summarize current data values and alarm states.
- Configure System**: Manage your WIN-911 system's configuration.

WIN-911 is configured with a web-driven interface that resides in the Internet Information Services (IIS) of the WIN-911 host computer. There are two ways to open this website: 1) clicking the shortcut that was created in the WIN-911 host's start menu, or, 2) opening a browser anywhere on the WIN-911 network and entering the WIN-911 Configuration URL.

The WIN-911 installation creates a "WIN-911 Configuration" shortcut in the start menu of the OS that hosts WIN-911. Simply double-click on the shortcut and your browser will open to the WIN-911 Configuration website. You will be challenged for the proper credentials before you are allowed to proceed.

The WIN-911 Configuration website can be accessed from any computer that is on the WIN-911 network, if you have the proper credentials. Simply open a browser and enter the URL: "`http://'WIN-911 computer name'/WIN911`". Note that the last segment of the URL does not contain a hyphen in WIN911. For example: if WIN-911 is installed on a computer named COMP1 and you are a remotely located user (say on computer COMP6), you would start IE and enter

http://COMP1/WIN911. From there you can enter your credentials and modify WIN-911 as desired.

Configure a Notification Method

Gateways

It is considered a best practice to configure any new installation by starting on the notification side of things, so we will begin by configuring our Email Gateway. Every Notifier has a Gateway. The Gateway defines the set of information required by WIN-911 to access the outside world. In the Mobile-911 Notifier this is your Mobile-911 server address, for SMS, your modem hardware settings, for Voice, this is your SIP server address and its associated settings or your TAPI modem configuration.

Launch the WIN-911 user interface by opening the shortcut placed in your Windows Start Menu after installation. This will open your browser and navigate to the locally installed Silverlight application. Find the Email Gateway workspace by clicking Contact > Email > Gateway.

Configuring your Email Gateway is much like configuring any Email client like Outlook or a smart phone application. WIN-911 supports SMTP for outgoing mail and POP or IMAP for incoming mail. Obtain your mail server settings from your network administrator, Email hosting provider or ISP. Customers using Exchange Server should consult with their mail administrator about configuring an SMTP relay. Place the settings provided to you in their respective fields.

WIN-911™ [Contact](#) [Notification](#) [Alarming](#) [Reporting](#) [System](#) ?
[Gateways](#) [Connections](#) [Formats](#) [Roles](#) [Schedules](#)
[Email](#) WIN-911 Mobile

Outgoing Server Incoming Server

Type SMTP
Host smtp.mycompany.com
 Use TLS/SSL
 Allow invalid certificates
Port 587
Email Address win911@mycompany.com
 My server requires authentication
Username win911@mycompany.com
Password ••••••••
[Send Test Email](#)

The gateway email account must be reserved for exclusive use by WIN-911. Do not attempt to access the account from another mail client. Be aware that WIN-911 will delete messages on this account.

I understand the above warning.



WIN-911™ [Contact](#) [Notification](#) [Alarming](#) [Reporting](#) [System](#) ?
[Gateways](#) [Connections](#) [Formats](#) [Roles](#) [Schedules](#)
[Email](#) WIN-911 Mobile

Outgoing Server Incoming Server

Enable Incoming Email (Required for Acknowledgement and Requests)

Type POP3
Host pop.mycompany.com
 Use SSL
 Allow invalid certificates
Port 995
Poll Rate (min) 1

[Test Incoming Server Settings](#)

There are two configuration items worth bringing to light here. The first is, in order to connect to your mail server, you must acknowledge

WIN-911 User Guide

the fact that WIN-911 needs exclusive access to the mail account credentials you provide. WIN-911 will use this account to send and receive mail. It will also delete any mail sent to this address as it processes it, for this reason, you should not use this account for any other purpose. Secondly, you can disable incoming mail by unchecking the incoming mail option on your gateway. This means that users will not be able to acknowledge alarms or make alarm and report requests. If you wish to allow some users to have incoming mail privileges and others not to, enable the feature here and configure the option on a per-user basis. We'll discuss this in the next section

Connections

A connection defines the specific endpoint WIN-911 will send a notification to. For the Email module, this is an Email address. In other modules, like SMS and Voice, this is a phone number. The connection also defines the format that should be applied to messages, for both alarms and reports. The connection also determines the hours during which a user should be notified, his personalized Schedule.

The screenshot displays the WIN-911 web interface. At the top, there is a navigation menu with tabs: Contact, Notification, Alarming, Reporting, System, Gateways, Connections (highlighted), Formats, Roles, and Schedules. Below this, there is a sub-menu with 'Email' and 'WIN-911 Mobile'. The main content area is titled 'Email Connections' and contains a configuration form for a connection named 'Bob Jones'. The form fields include: Name (Bob Jones), Description (empty), Email Address (bob.jones@mycompany.com), Schedule (Always), Connection Type (Standard Email Connection), and Roles (empty). There are several red circular icons with arrows and a plus sign, indicating configuration options. A 'Send Welcome Message' button is also visible. The bottom right corner of the form has a save icon and a close icon.

Enter a unique name for the connection and an Email address. Pick a Schedule from the list of default Schedules available to you, or if none of these meet your needs, click the arrow next to the list of Schedules to be taken to a workspace where you may define a new one. Schedules are configured using a calendar control much like any scheduling application. Use the GUI to configure when a connection is on or off duty. When you're done, use your browser's back button to finish configuring your connection. You may also attach a Role to a Connection. Roles are used to organize connections. We'll talk about Roles more when we discuss alarm escalation. There are a few predefined Roles already configured. Use the arrow button to create a new one, if you would like to. An arrow next to any field will take you to a workspace where you may configure that setting. You'll find this pattern repeated throughout the WIN-911 user interface.

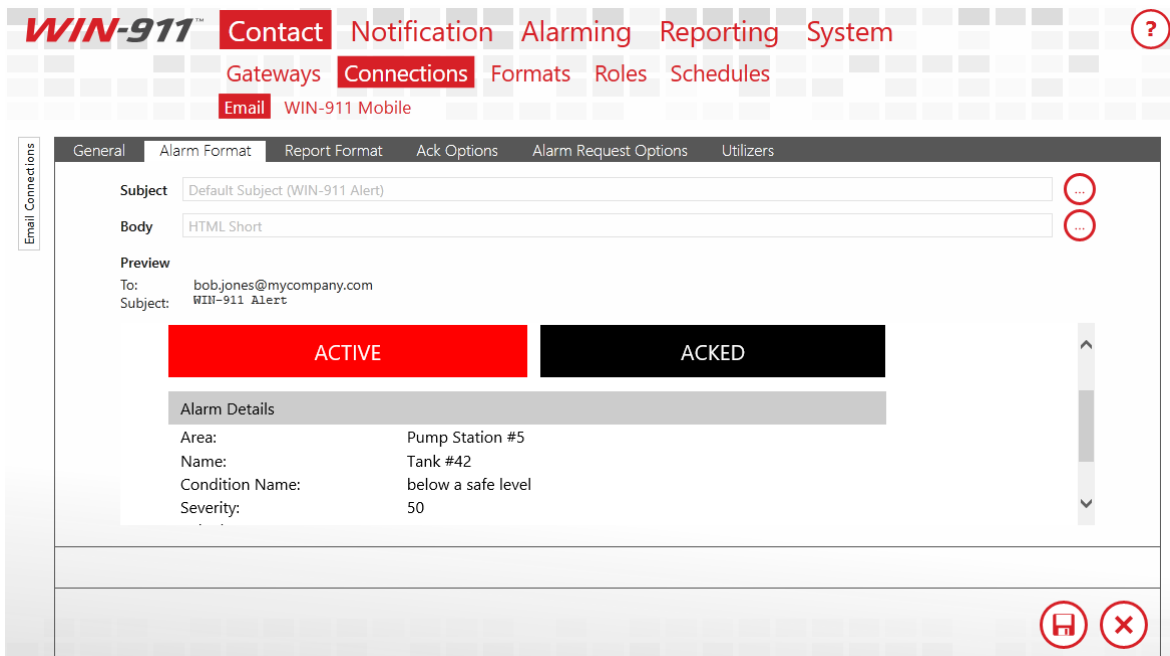

Select an Alarm Format that best suits your needs. You may format the subject and body in any way you wish. WIN-911's message formats are stored as XSLTs. XSL is a powerful programming language used for transforming XML documents. WIN-911 uses XSLTs to transform

WIN-911 User Guide

alarms into Email messages, voice calls, text messages, etc. Editing XSL is quite a complex task and is well outside the scope of this document. For more information on creating XSLTs, consult with W3Schools or contact WIN-911's support department. We'll be glad to help you design a Format that best suits your needs.

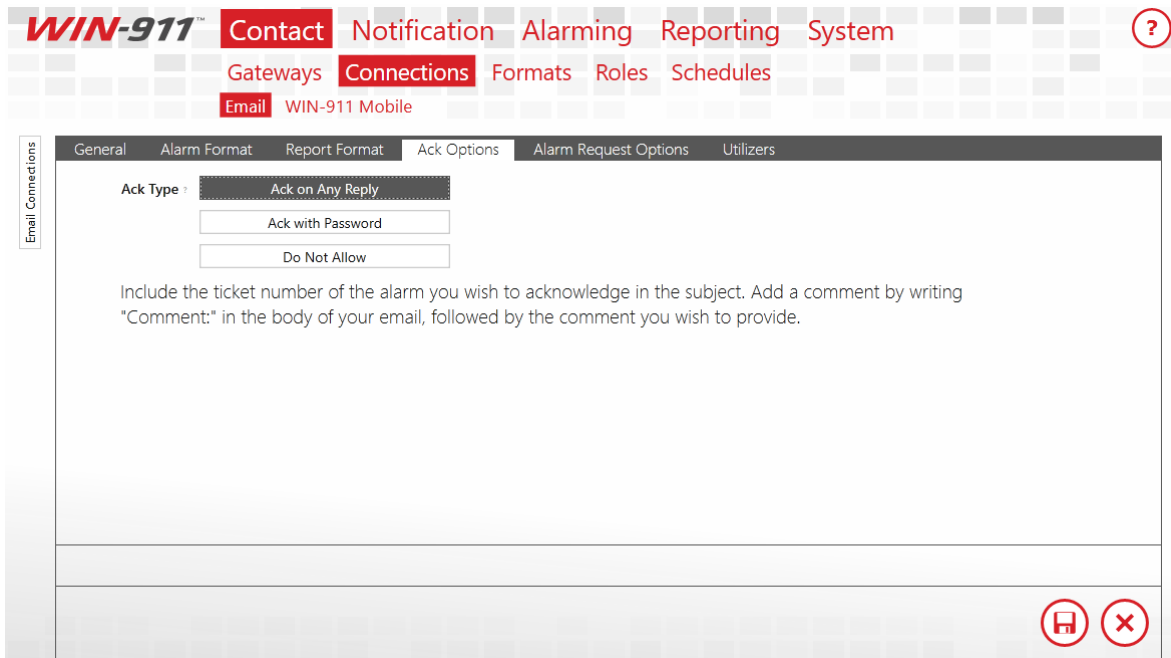

The Ack Option tab defines how alarms should be acknowledged by this connection, or if this connection should be allowed to acknowledge alarms at all. Select "Ack on Any Reply" and when WIN-911 receives a reply from this connection about an alarm, WIN-911 will acknowledge the alarm. Select "Ack with Password" to require a specific phrase be present in the reply message.

There are a few more settings available for you to configure, but they are not necessary. For the full documentation regarding Email Connections, see the WIN-911 Email manual. Save the Connection and we'll move on to configuring your escalation rules.

Configuring Escalation

The Dispatcher module is responsible for accepting alarms from data sources, running your escalation rules to determine who should receive those alarm messages and when. It sends these messages out to the appropriate notification module, which will, in turn, send them to their final destinations.

Strategies

Strategies are simply a list of events and how WIN-911 should respond to those events.

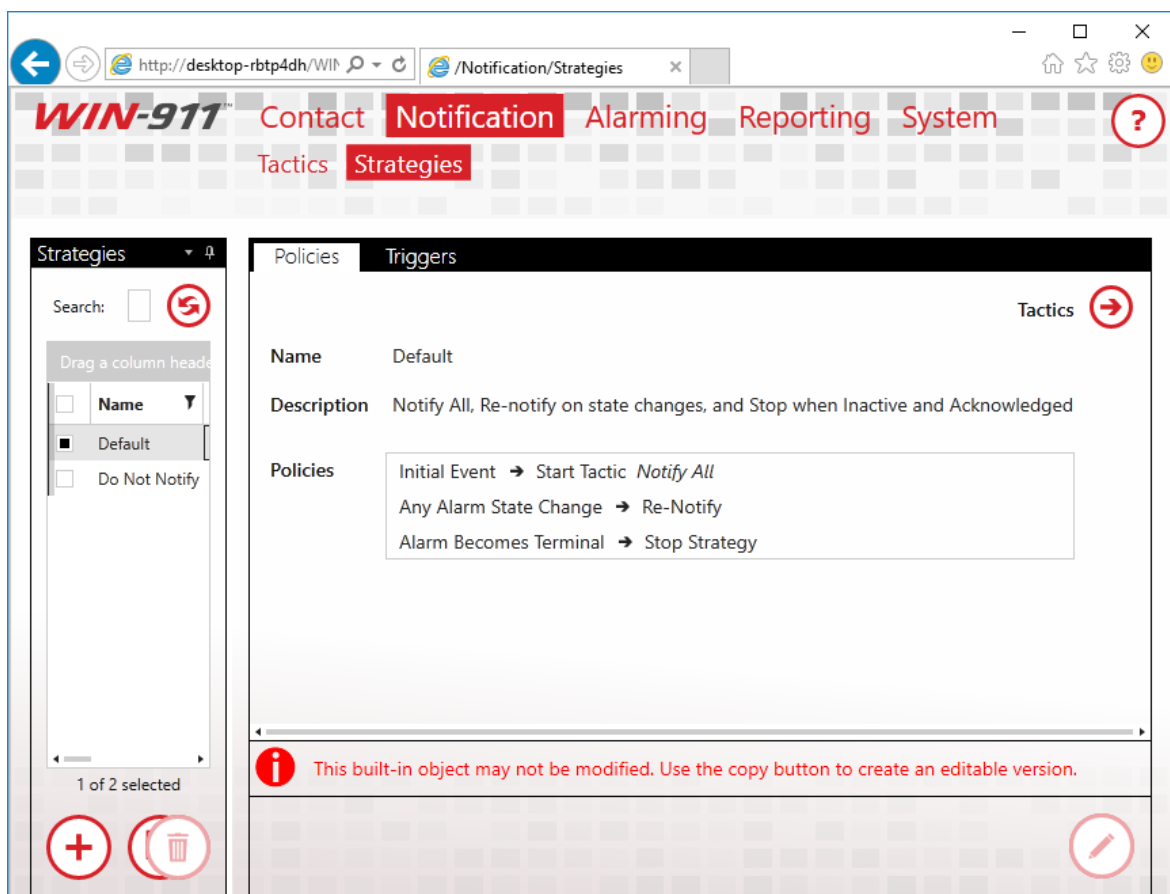

The Default Strategy will send every alarm to every connection configured in your WIN-911 system and send every update about every alarm to every user who previously received a message about the alarm. It will stop sending messages after the alarm is Terminal. An

alarm is considered Terminal when it is inactive and acknowledged. The Strategy only has three rules, formally called Policies, which define this behavior.

Initial Event -> Start Tactic "Notify All"
Any Alarm State Change -> Re-Notify
Alarm Becomes Terminal -> Stop Strategy

The first rule means that when the initial alarm is received, WIN-911 should start a Tactic called "Notify All." The Tactic determines who should actually be notified for an event. The "Notify All" Tactic tells WIN-911 to notify every connection configured in the system about the alarm. When it does so, it takes into account the Schedule defined for the connection. If the connection is on-duty, the alarm will be sent, if it is off-duty, the connection will be passed over. We'll talk more about Tactics later.

The second rule says that when any state change is received for the alarm, WIN-911 should send a message to anyone who previously received a message regarding the alarm. An alarm is considered to have changed state when either the active or acknowledged state changes.

The last rule says that when the alarm is both active and acknowledged, it should stop processing the strategy rules for the alarm. This ends the lifecycle of the alarm.

There are two types of Tactics, Basic and Advanced. Basic Tactics are simply a list of connections. When a Basic Tactic is started, everyone on the list is notified. Basic Tactics are easy to configure, and correspondingly, offer less flexibility regarding notification. That said, they meet the majority of users' needs and have the added benefit of being quite easy to maintain.

Advanced Tactics are essentially flow charts which determine who should hear about an alarm. Each block in the chart represent either an action to be taken or a decision to be made. These actions are generally Notification Blocks. Notification Blocks send messages to the connections specified in the block. You may also place a Role in a Notification Block. When you do this, any connection which has that Role attached, will be notified. Decision Blocks allow the chart to branch, decisions may be made based on properties of the alarm or the amount of time the tactic has been executing. Advanced Tactics are quite powerful and quite nuanced. A full discussion on them can be found in the Dispatcher manual. You may have noticed that we haven't configured anything on the Dispatcher yet. We'll go ahead and stick with the Default Strategy for now and move the discussion along to the OPC module.

Configure Data Sources

Sources

WIN-911 needs to know where to look for your alarms, or in the case of OPC DA, where to access your data so it can generate alarms based on the information it's provided. This point is an important one, so I'll state it plainly. Alarms are configured in WIN-911 for OPC DA data sources and WIN-911 determines when a specific alarm condition exists. Other Data Sources, like iFIX, CIMPLICITY and FactoryTalk determine when an alarm condition exists and pass that information onto WIN-911. This means that, with the exception of OPC DA, all of your alarm maintenance remains in your SCADA where it belongs. The remainder of this guide will assume that you have a locally installed OPC DA server and at least one digital point configured in that server.

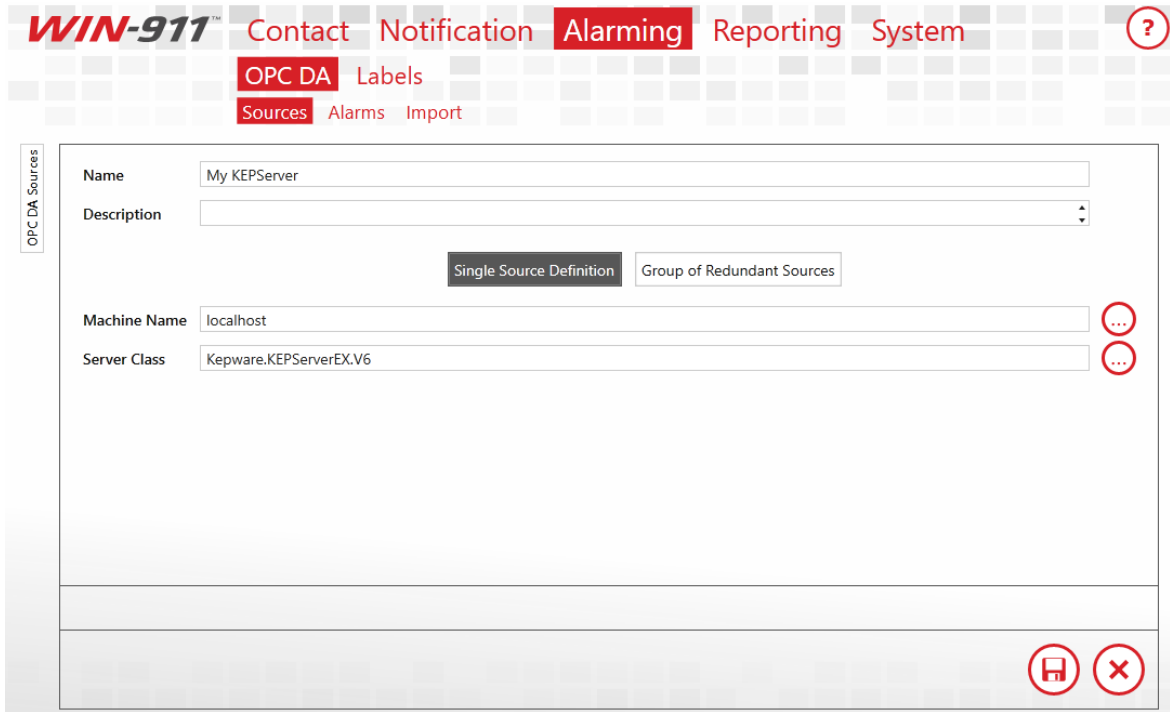

Start configuring your OPC DA module by connecting WIN-911 to your OPC server. In the OPC DA menu, create a new Source. Once again, the Name field is user defined and does not relate to any setting on your server, so be as descriptive as possible. The Machine Name is the hostname or IP address of the computer that your OPC DA server is installed to. If the server is running on the same machine as WIN-911, set this to "localhost." The server name is the name of your actual OPC DA server. Leave the radio button set to "Single Source." Redundant OPC DA is outside the scope of this document. Save the Source and click the Alarms link in the navigation menu to create an OPC DA alarm.

Alarms

The screenshot shows the WIN-911 software interface for configuring an alarm. The top navigation bar includes 'WIN-911', 'Contact', 'Notification', 'Alarming', 'Reporting', and 'System'. Below this, there are sub-menus for 'OPC DA', 'Labels', 'Sources', 'Alarms', and 'Import'. The main window is titled 'Item Alarms' and contains a form with the following fields: Name (Fresh Water Tank Gate Valve), Description, Area, Source (My KEPServer), Item ID (SCADA.FreshWaterTank.GateValve), Update Rate (1,000 ms), Units, and Item Labels. There are several red circular icons: a question mark in the top right, arrows next to Source, Item ID, and Item Labels, a plus sign next to Item Labels, and a save and close icon at the bottom right.

There are two components to any OPC DA alarm, the data on which the alarm is based, and alarm definition itself. Create a new item and enter a descriptive name for it. Again, the Name field is user-defined and does not relate to any setting on your OPC DA server. Select the OPC DA Source you configured previously. Type the Item ID of your OPC DA item in the Item ID field or click the browse button to browse your server directly. Units are optional and are always a good idea, if you're dealing with an Analog Item. Since our point is Digital, we'll skip it.

Labels

Labels are another organization feature of WIN-911, much like Roles. Tactics can treat Alarms with specific labels differently than other alarms. For instance, if you label alarms by building or assembly line, you can use a Label Decision Block to notify one set of your personnel about alarms on assembly line 1 and another set for alarms on assembly line 5. We'll skip labels for our Digital Alarm for now, but this

WIN-911 User Guide

is a powerful feature that you'll want to revisit once you create your production configuration.

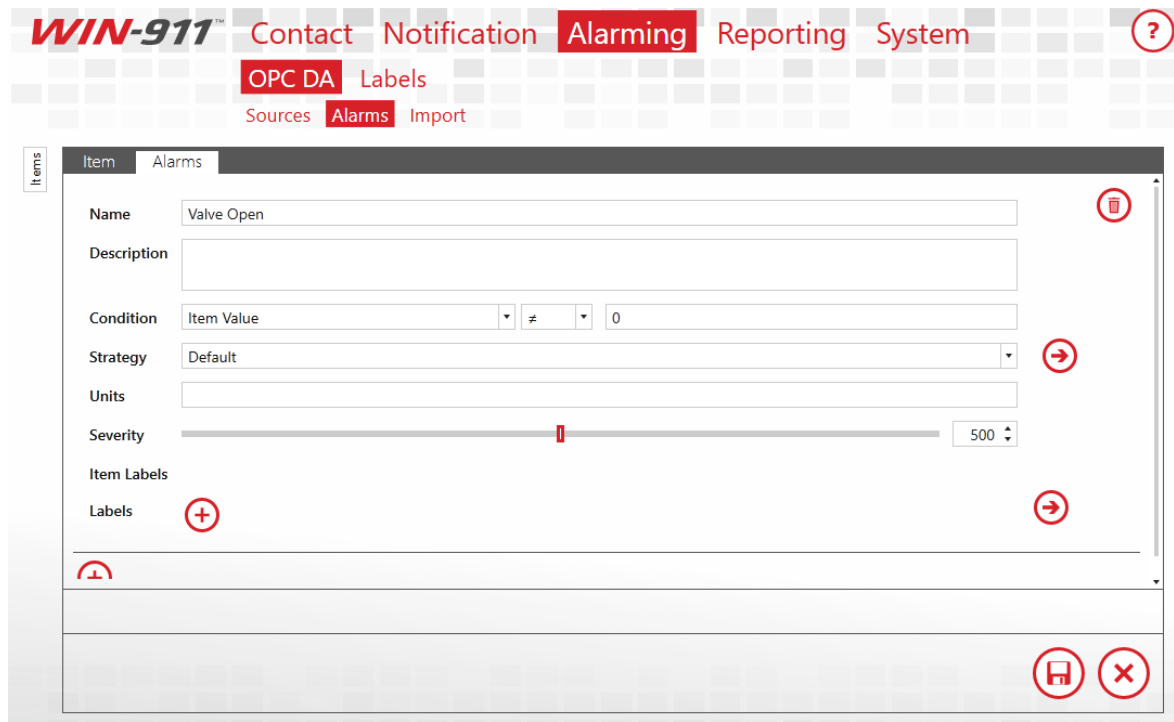

Click the Alarm tab to define the condition under which this OPC DA Item will generate an alarm. Our alarm will be triggered when the value is not zero. Enter a descriptive name for the Alarm and set the Condition so that when the Item Value is not equal to zero, our alarm is triggered. Set the Strategy to the Default Strategy, which we discussed earlier. The Strategy selection you make here is how WIN-911 associates alarms with specific Strategies. We're telling WIN-911 that when this alarm condition is met, it should execute the Strategy defined here. The Strategy then executes the Policies configured within it.

Before we save our Alarm, it's worth mentioning that WIN-911's configuration is live. As soon as you make changes to your configuration, they're executed. If you need to do maintenance on your WIN-911 system and wish to avoid sending nuisance alarms to your users, you should place WIN-911 into Standby Mode. You'll find

this option in the navigation menu under "System > Standby/Activate."

Once you're satisfied with the changes you've made to your configuration, simply place WIN-911 back into Active Mode.

Let's save our alarm and toggle the OPC DA item in our OPC DA server to "1." You should receive an alarm message at the Email address you configured at the beginning of this guide. It should look something like this:

WIN-911 Alert

: Freshwater Gate Valve : Valve Open is...

ACTIVE

UNACKED

Alarm Details

Area:

Name:

Freshwater Gate Valve

Condition Name:

Valve Open

Severity:

500

Congratulations on configuring your first WIN-911 System.

What just happened? You triggered the alarm by toggling it to a non-zero value. This is the Initial Event that the Default Strategy mentioned. Because the initial event was received, WIN-911 started the Notify All Tactic, which sent the alarm message out to everyone in your WIN-911 system. Everyone includes our one and only Email connection, so we received the alarm message.

WIN-911 User Guide

Toggle the OPC DA item back to zero and the alarm state will become inactive. Because this represents a state change, the Default Strategy will execute the Policy for Any State Change., which tells WIN-911 to renotify everyone who was sent the alarm message again. You should get an Email indicating that the alarm is now inactive.

If you set your connection up with the "Ack on Any Reply" setting, reply to this message. Leave the subject alone, it contains a ticket number, which WIN-911 uses to identify which alarm you would like to acknowledge. You can leave the body of the Email blank, or leave it filled with the history of your thread. If you set WIN-911 to require a password to acknowledge the alarm, enter that password anywhere in the body of your Email.

After WIN-911 acknowledges the alarm, you'll receive another message, because of your renotification policy, which will indicate that the alarm has indeed been acknowledged. Because the alarm is now Inactive and Acknowledged, WIN-911 will stop the executing Strategy and the lifetime of the alarm is now completed.

Mobile Gateway

Your locally installed WIN-911 instance will connect to the WIN-911 Mobile Web App which facilitates communication between WIN-911 and your WIN-911 Mobile App as well as managing interactions with push notification services provided by Google, Apple, and Baidu.

Begin your WIN-911 Mobile configuration by creating a gateway through which WIN-911 can connect to WIN-911's Mobile Web App.

The gateway will consist of a Site Name, an Email address, and a password. It may optionally include additional Mobile Hub configuration.

Site Name

This is a unique name which specifies the WIN-911 System from which the alarm information originates. This name will show up in the Settings of the Mobile App and appear in the alarm information. The site name is particularly important when the Mobile app is connected to multiple WIN-911 systems so some thought should be given how the site name can help the mobile user differentiate one alarm from another. You may have a plant with several buildings housing different production lines and a different WIN-911 instance monitoring each building. In this case it makes sense for your site name to be named after the building, i. e. Building 21, Building 22, etc.

Username

The Gateways are authenticated by credentials provided by WIN-911 Software and will be maintained by the WIN-911 administrator. If you do not have a credential set, please contact WIN-911 Software for assistance.

Note: If you are evaluating the Mobile product, you can contact WIN-911 Software for a demo account and credentials.

Password

The password for the gateway account.

Mobile Hub

The Mobile Hub is an optional network extension that allows WIN-911 to add a layer of separation between the production environment (WIN-911 System) and the outside world. It can be remotely located on a computer within a DMZ, which has Internet access and access to one or more WIN-911 Systems.

Before you can use this option, you must install and configure the Mobile Hub. Note the host computer's name (or address) and the port number assigned during the Mobile Hub configuration.

Select *Enable* to opt for the Mobile Hub topology.

Hostname

Enter the Mobile Hub host name or address in the field provided.

Note: If you are using a host name, please ensure it can be resolved by the WIN-911 host. Contrariwise, if you are using an IP address, please ensure it is static.

Port

Enter the port number of the Mobile Hub. The port number must match what is configured within the Mobile Hub settings. Please ensure your firewall allows outbound communications.

Validate Credentials

The first time the Gateway is setup using this workspace, you will use this button to create your account on the WIN-911 Mobile Web App, as defined by what you have entered above. If the creation is successful you will receive a "Connected successfully" message. If it returns a failure message you will need to troubleshoot the situation and resolve the issue. One possible issue may be that your firewall is not allowing WIN-911 to pass through.

The *Validate Credentials* button is only available when in edit mode.

Online Gateway Management

The Online Gateway Management link opens a browser page which displays your WIN-911 Mobile Web account. The first time you open this page you will be required to login using the username and password. Once logged in, you can review which Mobile connections are registered and delete any that are no longer required. You can use



WIN-911 User Guide

this link in the future to manage or recover your Mobile Gateway account password.

Mobile Connections

Mobile Connections define the individuals who make up your alarm notification network. These people will have the WIN-911 Mobile app installed on their mobile device (Android- iOS) and will login with the credentials they associate with their Email address. Use these pages to grant Acknowledgement permission and Alarm Request Options, set Schedules and assign Roles.

General

General	Ack Options	Alarm Request Options	Utilizers
Configure Gateway 			
Name	Arron Black		
Description	alarm responder		
Email Address	arron.black@mymail.com		
	Resend Invitation		
Schedule	Always		
Roles	Operators		
			

Name

Each Mobile connection must have a unique name that distinguishes the connection.

Description

An extra text field for organization or to add context not included in the other connection properties.

Email Address

The Mobile Connection (defined here) is linked to a Mobile app (on the user's device) via a registration process that involves the user's unique Email address. When the connection is first created, an invitation to join the WIN-911 Mobile Network will be sent to this address with instructions on how to create an account and start receiving alarm event information. Note: This Email address will be linked to a Microsoft account if it is not already.

Resend Invitation

When Mobile Connections are initially created, WIN-911 automatically sends an invitation to the Email address. Use this button to manually send follow up invitations as circumstance dictate.

Schedule

View or select the schedule that WIN-911 will honor when sending alarm messages to this connection. A connection can have only one assigned schedule, but a schedule can contain multiple appointments. See [Schedules](#).

Roles (for use by Advanced Tactics)

View or assign roles to the selected connection by clicking the add button in edit mode. Each connection can have multiple roles. See [Roles](#).

Ack Options

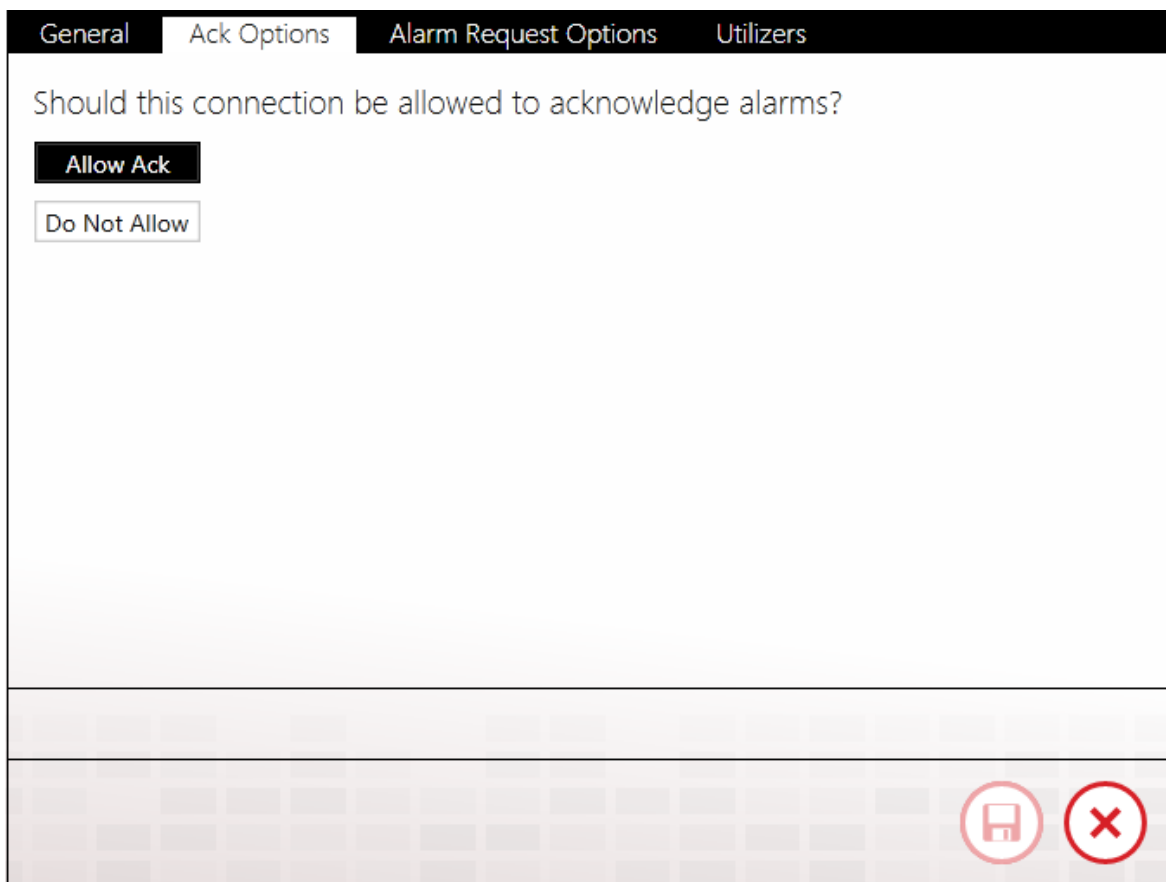

The screenshot shows a configuration interface with four tabs: 'General', 'Ack Options', 'Alarm Request Options', and 'Utilizers'. The 'Ack Options' tab is selected. The main content area contains the question 'Should this connection be allowed to acknowledge alarms?' followed by two buttons: 'Allow Ack' (highlighted in black) and 'Do Not Allow' (in a light gray box). At the bottom right of the interface, there are two red circular icons: a save icon and a close icon.

Select the connection's acknowledgement options with this tab. There are only two options, to allow or to not.

Alarm Request Options

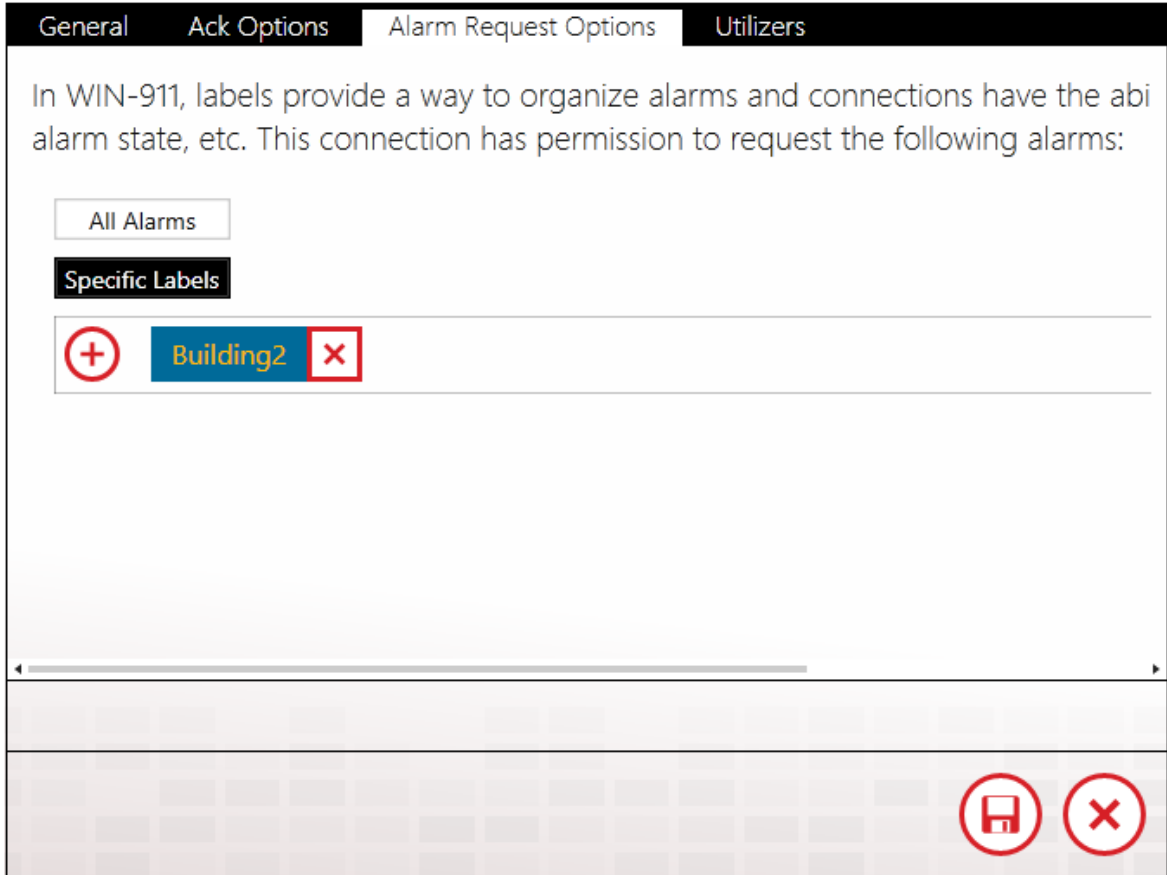



WIN-911 Labels provide a way to organize alarms, and connections have the ability to request alarms by Label, alarm state, etc.

Select the connection's alarm request options by clicking one of the two options: All Alarms, or Specific Alarms. If the Administrator wishes to limit the Connection's alarm request to specific Labels, the Labels must be added using the Labels selection tool. There are no limits to the number of Labels that can be assigned to a connection.

See [Labels](#) for more details.

Utilizers

General		Ack Options		Alarm Request Options		Utilizers	
Search:		<input type="text"/>					
Drag a column header and drop it here to group by that column							
Type	Name						
BasicTactic	Escalate Level 2						
BasicTactic	Escalate Level 3						
2 records							
							

The Utilizers tab is a bookkeeping device that lists all of the Tactics associated with this Connection. When utilizers are present, WIN-911 prevents the Connection from being deleted. If you wish to delete the Connection, you will first have to modify the utilizing Tactic in a manner that will unlink it to this Connection. Once all utilizers are cleared, the Connection can be safely deleted.

Email Gateway

Define the settings required to connect to your local or Internet-based Email server.

- *All required settings are available from your Email administrator.*
- *WIN-911 is capable of using different servers for outgoing and incoming mail.*
- *WIN-911 requires a dedicated Email address due to the way it handles the inbox. Any messages left in the inbox will be deleted from the server by WIN-911 at runtime.*

Outgoing Server

Outgoing Server
Incoming Server

Type	SMTP
Host	<input type="text" value="mail.win911.com"/>
	<input checked="" type="checkbox"/> Use TLS/SSL <input type="checkbox"/> Allow invalid certificates
Port	<input type="text" value="587"/>
Email Address ?	<input type="text" value="Alarm.Server@win911.com"/>
	<input checked="" type="checkbox"/> My server requires authentication
Username	<input type="text" value="Alarm.Server@win911.com"/>
Password	<input type="password" value="••••••••"/>

The gateway email account must be reserved for exclusive use by WIN-911. Do not attempt to access the account from another mail client. Be aware that WIN-911 will delete messages on this account.

I understand the above warning.

Type

WIN-911 uses SMTP as the outgoing server protocol.

Host

Specify the server name or IP address of your outgoing Email server.

Use TLS/SSL

Check this box if the outgoing server WIN-911 will use requires encryption.

Allow Invalid Certificates

Allow WIN-911 to transact with a server using a self-signed certificate or an expired certificate. Note that this option is less secure.

Port

Enter the port number that the WIN-911 Email server will use to send outgoing Email.

Email Address

Enter the *dedicated* Email address in the text entry box that WIN-911 will use to dispatch alarm and report messages and receive acknowledgement and report requests.

Username and Password

Specify the credentials required by your server.

Test Outgoing Server Settings

Click "Test Outgoing Server Settings" button to test WIN-911 ability to connect to the mail server and send messages. If the server values have been properly set, WIN-911 will display a "success" message. If the test fails, refer to the Windows Event Viewer for details concerning the error that occurred when the test was attempted and take corrective action.

Understanding required Warning Message

Note: Before the gateway's settings can be saved, WIN-911 requires that you read the following warning and check the confirmation box to the lower right.

The gateway Email account must be reserved for exclusive use by WIN-911. Do not attempt to access the account from another Email client. Be aware that WIN-911 will delete messages on this account.

Incoming Server

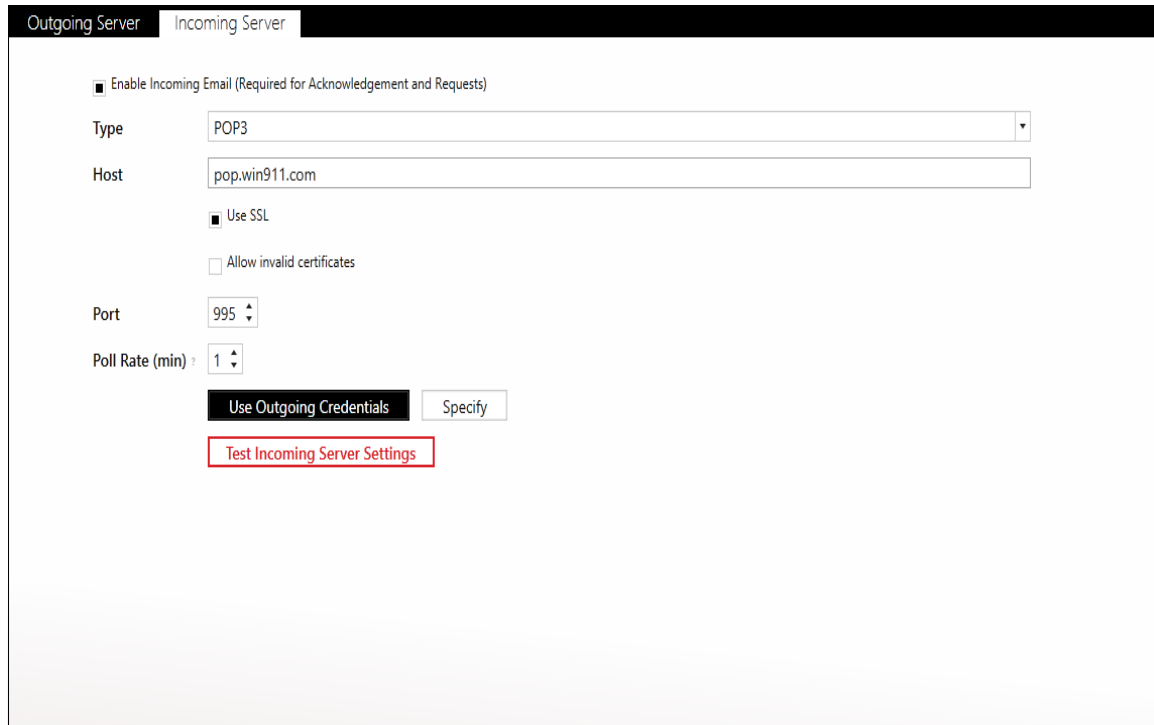

The screenshot shows a configuration window titled "Incoming Server" with a tab for "Outgoing Server" also visible. The window contains the following settings:

- Enable Incoming Email (Required for Acknowledgement and Requests)
- Type: POP3 (selected in a dropdown menu)
- Host: pop.win911.com (text input field)
- Use SSL
- Allow invalid certificates
- Port: 995 (dropdown menu)
- Poll Rate (min): 1 (dropdown menu)
- Buttons: "Use Outgoing Credentials" (highlighted in black), "Specify", and "Test Incoming Server Settings" (highlighted in red).

The incoming server can use either the POP3 or IMAP protocol to receive incoming acknowledgement and report requests.

Enable Incoming Email (required for Acknowledgement and Report Requests)

Click this check box to configure WIN-911 to receive incoming mail.

Type

WIN-911 supports POP3 and IMAP as the incoming server protocol. The default protocol is POP3.

WIN-911 User Guide

Host

Specify the server name or IP address of your incoming mail server.

Use SSL

Check this box if the incoming server requires encryption.

Allow Invalid Certificates

Allow WIN-911 to transact with a server using a self-signed certificate or an expired certificate. Note that this option is less secure.

Port

Enter the port number that the WIN-911 Email server will use to receive incoming mail.

Poll Rate (min)

Enter frequency in minutes that WIN-911 will poll the server for incoming mail.

Use Outgoing Credentials or Specify

In the event that the mail server uses the same credentials for incoming mail as it does for outgoing, use the default setting of "Use Outgoing Credentials". Otherwise select "Specify" and enter the username and password required by the incoming server.

Test Incoming Server Settings

Click the "Test Incoming Server Settings" button to test WIN-911 ability to connect to the mail server and receive mail. If the server values have been properly set, WIN-911 will display a "success" message. If the test fails refer to the Windows Event Viewer for details concerning the error that occurred when the test was attempted and take corrective action.

Email Connections

Connections specify a destination for alarm notification reports. Email connections also determine just what you will see in alarm and report Email messages, connection availability and the permissions a connection has been granted concerning acknowledgement and report requests.

General

The screenshot shows the 'General' tab of an email connection configuration window. The window has a dark header with tabs: 'General', 'Alarm Format', 'Report Format', 'Ack Options', 'Alarm Request Options', and 'Utilizers'. The 'General' tab is active. In the top right corner, there is a 'Configure Gateway' button with a right-pointing arrow icon. The main content area displays the following fields:

- Name: Tom Jones
- Description:
- Email Address: tom@win911.com
- Schedule: Always
- Connection Type: Standard Email Connection
- Roles:

Below the 'Roles' field, there is a button labeled 'Send Welcome Message'. At the bottom right of the window, there is a red circular icon with a pencil, indicating an edit function.

Name

Each Email connection must have a unique name that identifies the particular Email connection.

Description

An extra text field for organization and administration purposes, similar to a code comment.

Email Address

View or enter the Email address that WIN-911 will send assigned alarm and report messages to for this connection. It is acceptable to assign a unique Email address to multiple connections if your situation warrants such action; however, a warning message will be generated to inform the WIN-911 administrator that a pre-existing connection already uses this address and lists the number of times it has been used.

Schedule

View or select the schedule that WIN-911 will honor when sending alarm and report messages. A connection can have only one assigned schedule, but a schedule can contain multiple appointments. See [Schedules](#).

Connection Type

Standard Email Connection

This connection type is for sending email messages that will be received as email.

User an Email to SMS Gateway

This connection type is for sending SMS messages to the alarm responder that originate from WIN-911 as an Email connection. This type requires a 3rd party Email to SMS proxy.

WIN-911 User Guide

Most wireless service providers offer this service. The alarm responder can acknowledge the alarm by replying to the text using the ticket number and password, which is discussed in the Ack Options

Roles (for use by Advanced Tactics)

View or assign roles to the selected connection by clicking the add button in edit mode. Each connection can have multiple roles. See [Roles](#).

Send Welcome Message

Click the "Send" button in view or edit mode to send a WIN-911 Welcome message to the selected connection. The welcome message will test the gateway and connection settings as well as provide the recipient vital information about how to use his/her Email account to receive alarm and report messages and request acknowledgements, reports, and alarm updates.

Alarm Format

The screenshot shows the 'Alarm Format' configuration window. At the top, there are tabs for 'General', 'Alarm Format', 'Report Format', 'Ack Options', 'Alarm Request Options', and 'Utilizers'. The 'Subject' field is set to 'Default Subject (WIN-911 Alert)' and the 'Body' field is set to 'HTML Short'. Below these fields is a 'Preview' section showing an email header with 'To: tom@win911.com' and 'Subject: WIN-911 Alert'. The main body of the preview shows a red heading 'WIN-911 Alert' followed by the text 'Pump Station #5 : Tank #42 : below a safe level is...'. Below this text are two buttons: a red 'ACTIVE' button and a black 'ACKED' button. Underneath the buttons is a table titled 'Alarm Details' with the following information:

Alarm Details	
Area:	Pump Station #5
Name:	Tank #42
Condition Name:	below a safe level
Severity:	50
Acked By:	Actor
Comment:	Ack Comment

At the bottom right of the window, there are two circular icons: a save icon and a close icon.

Subject

View or select the contents of the alarm message subject. It can contain a static default subject of "WIN-911 Alert" or use a dynamic alarm descriptor that is taken from the report definition during runtime.

Body

View or select an alarm message format from the five available options: Default Text Simple, Default Text Verbose, Default HTML Simple, Default HTML Verbose, and Diagnostic. The simple selections include minimal information about the alarm whereas the verbose options include amplified details. The Diagnostic option is the most detailed and includes information regarding Email notifier modules

interaction with the Email server and is not intended for normal remote notification operations. The HTML options include a more visually appealing, rich presentation with a color-coded alarm condition and acknowledgement information but will not be compatible with "text-only" Email servers or devices.

Preview

A "What You See is What You Get" window shows the administrator what an alarm message will look like with the current options selected.

Report Format

Subject

View or select the contents of the report message subject. It can contain a static default subject of "WIN-911 Report" or use a dynamic report descriptor that is taken from the report definition during runtime.

Body

View or select the report message format from the four available options: HTML Report, Default Report (Horizontal), Plain Text Vertical Report, and Plain Vertical Report Verbose. The simple selections include minimal information about the alarm whereas the verbose options include amplified details. The HTML options include a more visually appealing rich presentation with color-coded alarm condition and acknowledgement information but are not compatible with text only Email servers or end-users.

Preview

A "What You See if What You Get" window shows the administrator what a report message will look like with the current options selected.

Ack Options

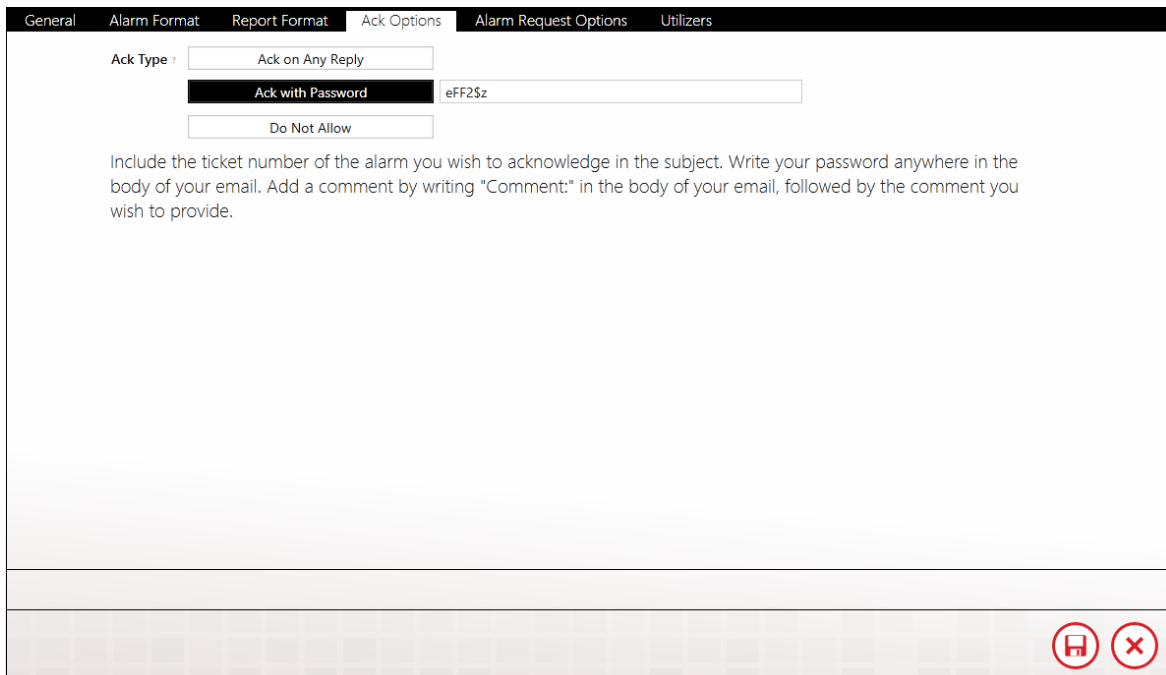

The screenshot shows a configuration window with several tabs: General, Alarm Format, Report Format, Ack Options (selected), Alarm Request Options, and Utilizers. Under the Ack Options tab, there are three radio button options for Ack Type: "Ack on Any Reply", "Ack with Password" (which is selected and highlighted in black), and "Do Not Allow". To the right of the "Ack with Password" option is a text input field containing the password "eFF2Sz". Below these options is a paragraph of instructions: "Include the ticket number of the alarm you wish to acknowledge in the subject. Write your password anywhere in the body of your email. Add a comment by writing 'Comment:' in the body of your email, followed by the comment you wish to provide." At the bottom right of the window, there are two circular icons: a save icon and a close icon.

Select the connection's acknowledgement options with this tab.

There are three options each Email connection can be configured for concerning the ability to issue acknowledgement requests: Ack on Any Reply, Ack with Password, and Do Not Allow. In edit mode this setting can be selected or modified by clicking the desired button. The "Ack with Password" option contains a text entry box where the ack password is defined. The password will not be visible in view mode.

WIN-911 User Guide

To provide a comment with your acknowledgement, enter "comment:" followed by your comment in the body of your reply Email.

To acknowledge alarms using a password, include the password in the body of your reply Email.

Note: If the connection type is set for "Use an Email to SMS Gateway" you may not select "Ack on Any Reply" as your ack type.

Alarm Request Options

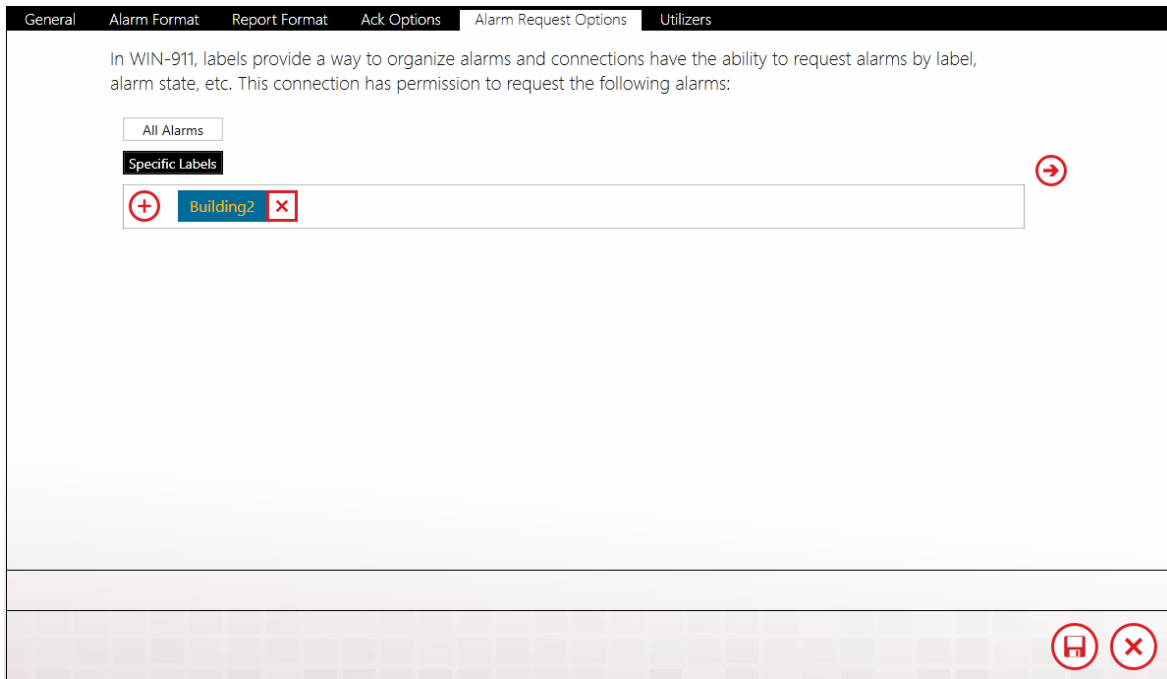

WIN-911 labels provide a way to organize alarms and connections have the ability to request alarms by label, alarm state, etc.

Select the connection's alarm request options by clicking one of the two options: All Alarms, or Specific Alarms. If the Administrator wishes to limit the connection's alarm request to specific labels, the labels

must be added using the labels selection tool. There are no limits to the number of labels that can be assigned to a connection.

See [Labels](#) for more details.

Utilizers

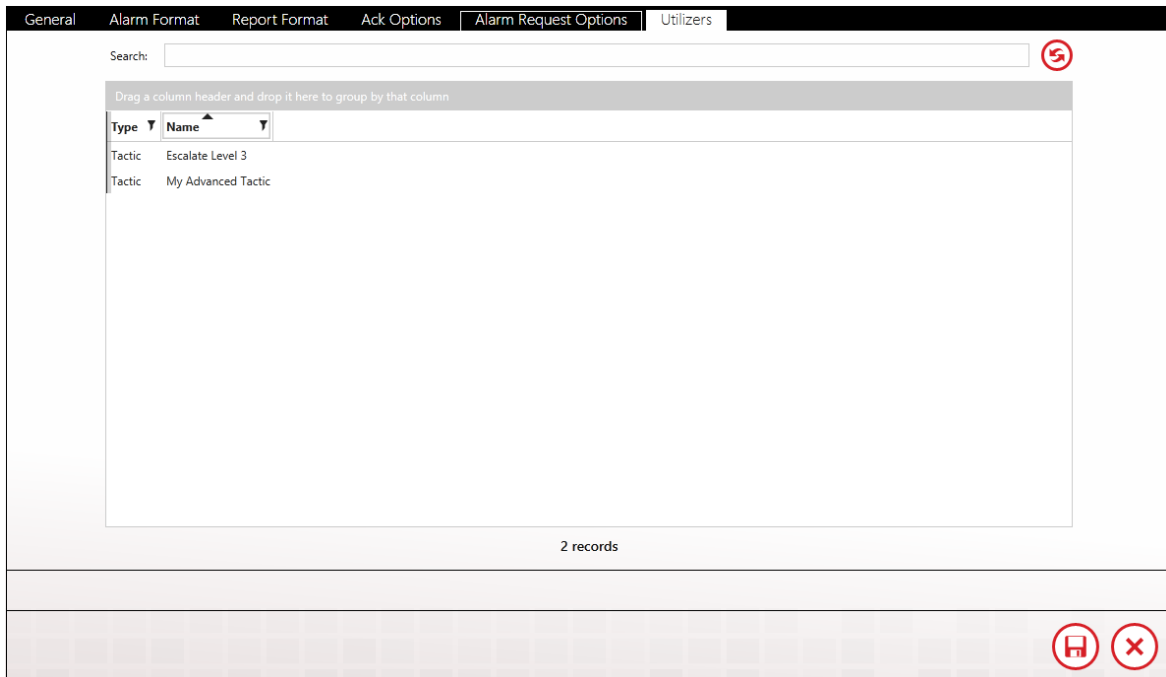

The screenshot displays the 'Utilizers' tab within a software application. At the top, there is a navigation bar with tabs for 'General', 'Alarm Format', 'Report Format', 'Ack Options', 'Alarm Request Options', and 'Utilizers'. Below the navigation bar is a search bar with the text 'Search:'. A table is shown with the following data:

Type	Name
Tactic	Escalate Level 3
Tactic	My Advanced Tactic

Below the table, it indicates '2 records'. At the bottom right of the interface, there are two red circular icons: a square with a house icon and a circle with an 'X' icon.

The Utilizers tab is a booking keeping device that lists all of the tactics associated with this contact. When utilizers are present WIN-911 prevents the contact from being deleted. If you wish to delete the contact, you will first have to modify the utilizing tactic in a manner that will unlink it to this contact. Once all utilizers are cleared, the contact can be safely deleted.

Email Formats

Email Formats use XSL to determine how alarms and reports are formatted in your e-mails. As of 3.16.9, WIN-911 allows users to create and customize their own formats for each notifier.

The screenshot displays the WIN-911 web interface. The top navigation bar includes 'WIN-911' and several menu items: 'Contact', 'Notification', 'Alarming', 'Reporting', 'System', 'Email', 'Mobile-911', 'SMS', 'Voice', 'Roles', 'Schedules', 'Gateway', 'Connections', and 'Formats'. The 'Formats' menu item is highlighted.

The main content area is split into two panes. The left pane, titled 'XSL Templates', contains a search bar and a table of templates. The table has columns for 'Name', 'Data Type', and 'Message Part'. The 'HTML Short' template is selected. The right pane, titled 'Format Utilizers', shows the configuration for the 'HTML Short' format. It includes fields for 'Name', 'Target Data', 'Message Part', and 'Message Format'. A preview of the format is shown, displaying a 'WIN-911 Alert' with 'ACTIVE' and 'ACKED' buttons, and 'Alarm Details' including Area, Name, Condition Name, Severity, Acked By, and Comment.

Name	Data Type	Message Part
<input type="checkbox"/> Alarm Descriptor	Alarm	Subject
<input type="checkbox"/> Default Subject (WIN-911 Alert)	Alarm	Subject
<input type="checkbox"/> Default Subject (WIN-911 Report)	Report	Subject
<input type="checkbox"/> Diagnostic	Alarm	Body
<input type="checkbox"/> HTML Long	Alarm	Body
<input type="checkbox"/> HTML Report	Report	Body
<input checked="" type="checkbox"/> HTML Short	Alarm	Body
<input type="checkbox"/> HTML Short Condition	Alarm	Body
<input type="checkbox"/> Plain Text Long Vertical Report	Report	Body
<input type="checkbox"/> Plain Text Short Horizontal Report	Report	Body
<input type="checkbox"/> Plain Text Short Vertical Report	Report	Body
<input type="checkbox"/> Report Descriptor	Report	Subject
<input type="checkbox"/> Text Long	Alarm	Body
<input type="checkbox"/> Text Short	Alarm	Body
<input type="checkbox"/> Text Short Condition	Alarm	Body

1 of 15 selected

Format Utilizers

Name: HTML Short

Target Data: Alarm

Message Part: Body

Message Format: HTML

Preview

WIN-911 Alert

Pump Station #5 : Tank #42 : below a safe level is...

ACTIVE **ACKED**

Alarm Details

Area: Pump Station #5
 Name: Tank #42
 Condition Name: below a safe level
 Severity: 50
 Acked By: Actor
 Comment: Ack Comment

This built-in object may not be modified. Use the copy button to create an editable version.

Format

WIN-911, when installed, will initially have 15 Email Formats. 10 of them target alarms while the remaining five target reports.

To create a new Email Format from scratch, click on the '+' button located at the bottom left corner of the XSL Templates list. The following workspace will then appear:

Format	Utilizers
Name	<input type="text" value="Enter a name for this format"/>
Target Data	<input type="radio"/> Alarm <input checked="" type="radio"/> Report
Message Part	<input checked="" type="radio"/> Body <input type="radio"/> Subject
Message Format	<input checked="" type="radio"/> HTML <input type="radio"/> Plain Text
XSLT	<input type="text" value="Enter your XSLT here. Copy an existing format as a starting point."/>

* indicates required fields:

- ***Name:** the name for this Format. Must be unique across all defined Email Formats.
- **Target Data:** determines if this Format is for Alarms or Reports. By default, this will initially be set to Alarm
- **Message Part:** determines if this Format is for the body of a message or the subject. By default, this will initially be set to Body
- **Message Format:** determines if this Format will use HTML or plain text. By default, this will initially be set to HTML
- ***XSLT:** the XSLT code that will generate the layout for this Format. Must be valid code.

Due to the granular nature of the code syntax, WIN-911 Software strongly recommends copying from one of the 15 original Formats to get started. Select a Format from the XSL Template list, then click the Copy button at the bottom of the list right next to the '+' button. You can then tweak the existing XSLT code however you want to get your desired Format.

Name	<input type="text" value="Default Subject (WIN-911 Report)"/>
Target Data	<input type="radio"/> Alarm <input checked="" type="radio"/> Report
Message Part	<input type="radio"/> Body <input checked="" type="radio"/> Subject
Message Format	<input type="radio"/> HTML <input checked="" type="radio"/> Plain Text
XSLT	<pre><?xml version="1.0" encoding="ISO-8859-1"?> <xsl:stylesheet version="1.0" xmlns:xsl="http://www.w3.org/1999/XSL/Transform"> <xsl:output method="text"/> <xsl:template match="/"> <xsl:text>WIN-911 Report</xsl:text> </xsl:template> </xsl:stylesheet></pre>

After saving a created Format, you can then select it under Email Connections in the Format tabs. If it targets alarms, it'll show up in the

WIN-911 User Guide

Alarm Format tab combo box, Report Format tab combo box otherwise.

Notes:

- *All Email subject Formats must use plain text. If you select 'Subject', 'Message Format' will automatically set to 'Plain Text'.*
- *All Email HTML Formats must target the body part of the message. If you select 'HTML', 'Target Data' will automatically set to 'Body'.*
- *The validity of the XSLT will partially be determined by which 'Target Data' is selected, since 'Alarm' and 'Report' each comply with different XML prefixes.*

Utilizers

The utilizers tab shows which Email connections make use of the chosen format.

Mobile-911 Gateway

WIN-911 communicates with your Mobile-911 clients through a server. Specify the address of your Mobile-911 Server here.

Mobile-911 Server Location

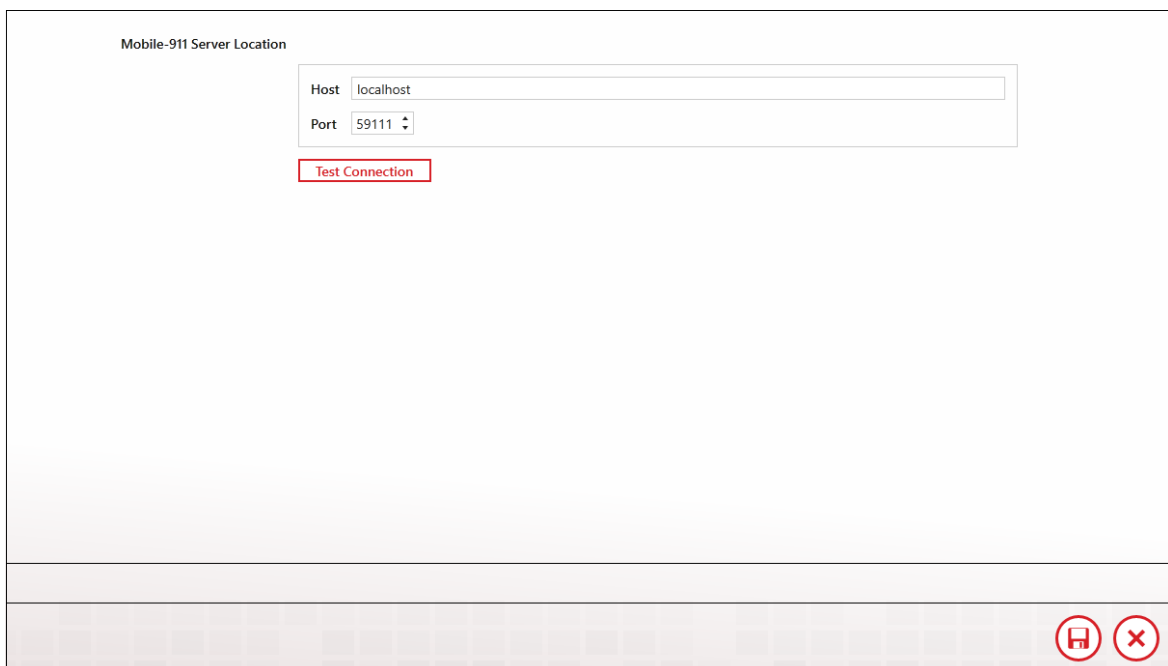

The screenshot shows a window titled "Mobile-911 Server Location". Inside the window, there are two input fields: "Host" with the value "localhost" and "Port" with the value "59111". Below these fields is a red button labeled "Test Connection". At the bottom right of the window, there are two red circular icons: a save icon and a close icon.

Specify

With this selection the location of the Mobile-911 Server can be entered manually by the WIN-911 administrator by entering the IP address and port number in the text boxes that appear when the Specify button is selected. The default IP address for Host is "localhost" and the default Port number is 59111.

Test Connection

Click this button to verify the Mobile-911 Server location. If WIN-911 cannot connect to the server check your settings and ensure that the Mobile-911 Service is running.

Mobile-911 Connections

Connections specify a destination for alarm notification reports. Mobile-911 connections also determine what you will see in alarm and report messages, connection availability and the permissions a connection has been granted concerning acknowledgement.

General

The screenshot shows a configuration window for a Mobile-911 connection. At the top, there are tabs for 'General', 'Alarm Format', 'Report Format', 'Ack Options', 'Alarm Request Options', and 'Utilizers'. The 'General' tab is active. The form contains the following fields:

- Name:** Wayne Smith
- Description:** (empty)
- Device ID:** 234ave-skoh749-bhotu
- Schedule:** Always (dropdown menu)
- Roles:** (empty list with a '+' icon)

Additional UI elements include a 'Configure Gateway' button with a right arrow icon, and a bottom bar with a save icon (floppy disk) and a close icon (X).

Name

Each Mobile-911 connection must have a unique name that identifies the particular Mobile-911 connection.

Description

WIN-911 User Guide

An optional field for entering information concerning the particular connection.

Device ID

Enter the Mobile-911 Device ID for this connection. The Device ID is found in the device's app under Settings. Since the ID is typically long and cryptic, we recommend using the Send Device ID option to Email the Device ID to the WIN-911 computer. From there you can copy and paste it directly into WIN-911.

Schedule

Select the schedule that WIN-911 will honor when sending alarm and report messages. A connection can have only one assigned schedule, but a schedule can contain multiple appointments. See [Schedules](#).

Roles (for use by Advanced Tactics)

View or assign roles to the selected connection by clicking the add button in edit mode. Each connection can have multiple roles. See [Roles](#).

Alarm Format

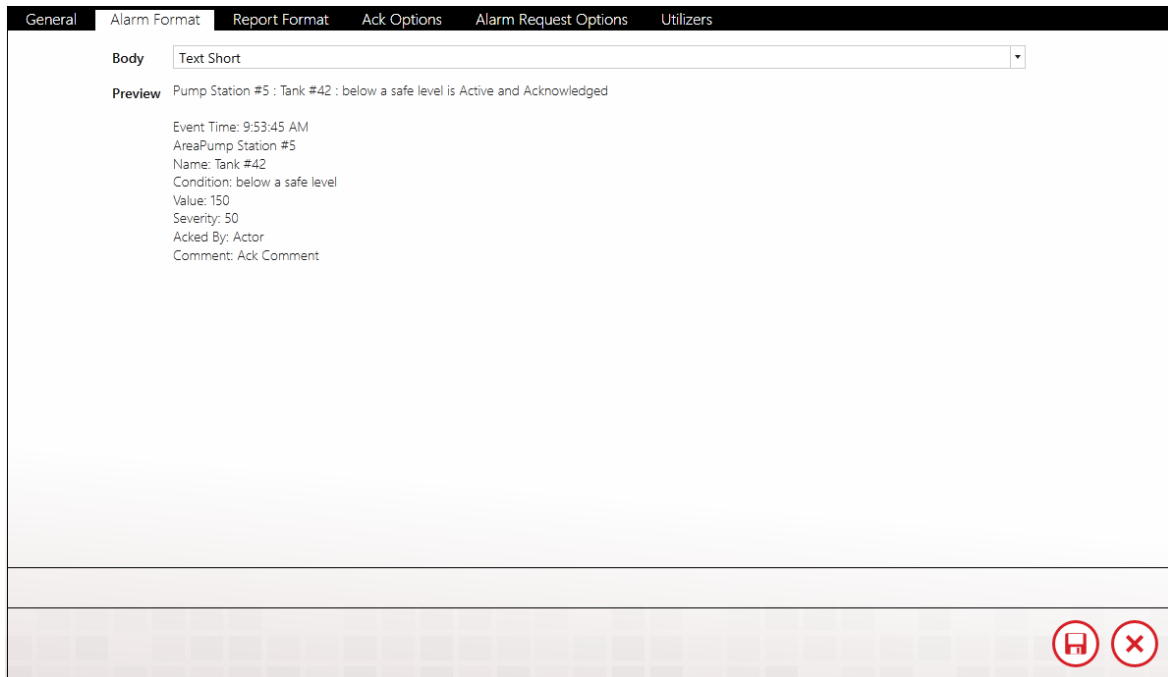

The screenshot shows a configuration window with a dark header bar containing the following tabs: General, Alarm Format, Report Format, Ack Options, Alarm Request Options, and Utilizers. The 'Alarm Format' tab is selected. Below the header, there is a 'Body' dropdown menu currently set to 'Text Short'. Underneath, a 'Preview' section displays a sample alarm message: 'Pump Station #5 : Tank #42 : below a safe level is Active and Acknowledged'. Below the preview, several fields are listed: 'Event Time: 9:53:45 AM', 'AreaPump Station #5', 'Name: Tank #42', 'Condition: below a safe level', 'Value: 150', 'Severity: 50', 'Acked By: Actor', and 'Comment: Ack Comment'. At the bottom right of the window, there are two red circular icons: a save icon and a close icon.

View or select an alarm message format from the two available options: Default Text Simple or Default Text Verbose. The simple selection includes minimal information about the alarm whereas the verbose option includes amplified details.

Preview

The Preview window shows the administrator what an alarm message will look like with the current options selected.

Report Format

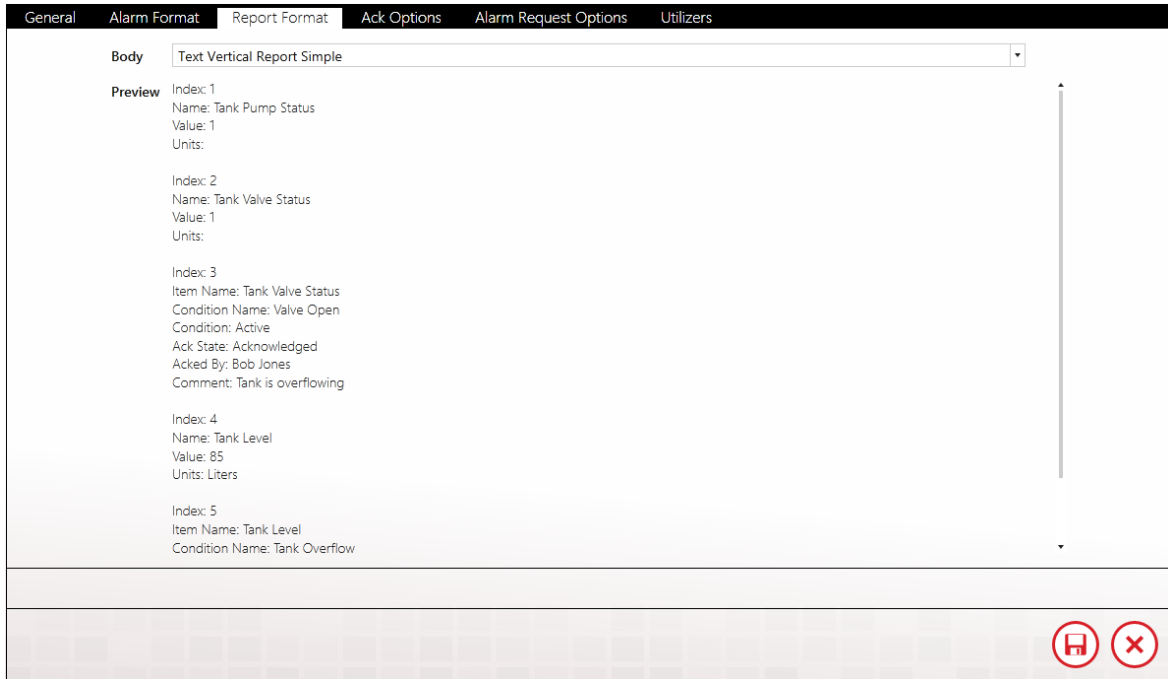

Select the report message format from the two available options: Plain Vertical Report or Plain Vertical Report Verbose. You can also create custom formats using the Mobile -911 Formats tab.

Preview

The Preview window shows the administrator what a report message will look like with the current options selected.

Ack Options

The screenshot shows a software window with a dark header bar containing several tabs: "General", "Alarm Format", "Report Format", "Ack Options", "Alarm Request Options", and "Utilizers". The "Ack Options" tab is currently selected. Below the header, the main content area contains the text "Should this connection be allowed to acknowledge alarms?". Underneath this text are two buttons: "Ack with Password" and "Do Not Allow". The "Do Not Allow" button is highlighted with a dark background. At the bottom right of the window, there are two red circular icons: a save icon and a close icon. The bottom of the window features a light-colored footer bar with a grid of small, faint icons.

Select the connection's acknowledgement options on this tab.

Alarm Request Options

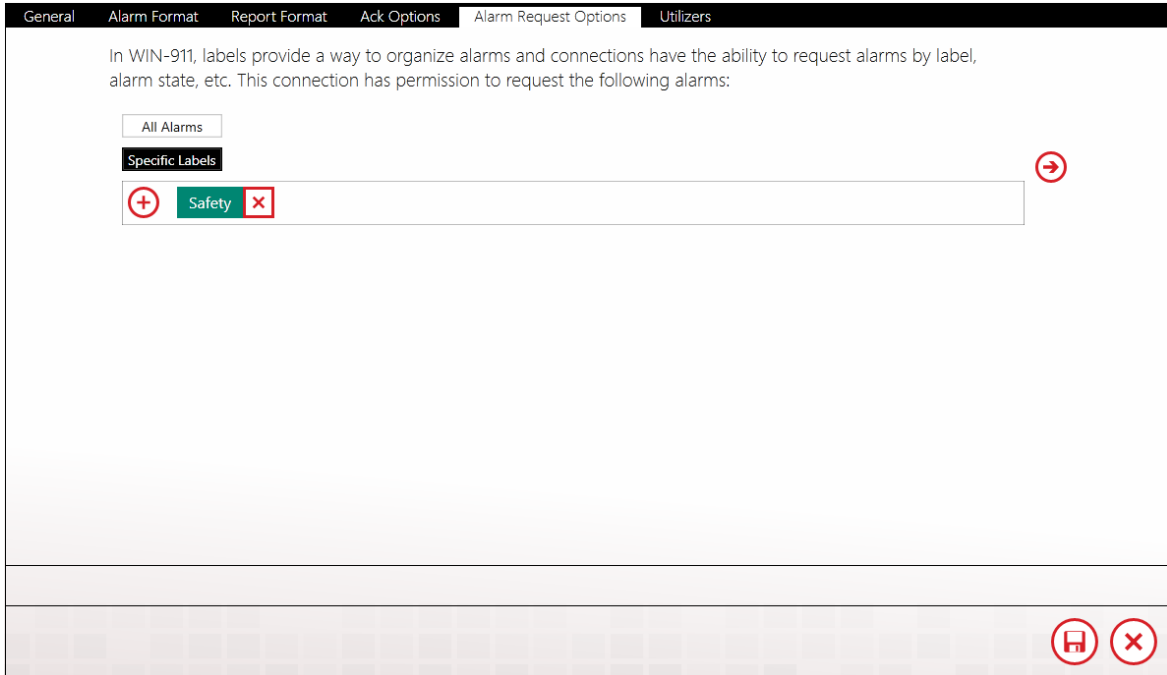

WIN-911 labels provide a way to organize alarms and connections have the ability to request alarms by label, alarm state, etc.

Select the connection's alarm request options by clicking one of the two options: All Alarms or Specific Labels. If the Administrator wishes to limit the connection's alarm request to specific labels, the labels must be added using the labels selection tool. There are no limits to the number of labels that can be assigned to a connection.

See [Labels](#) for more details.

Utilizers

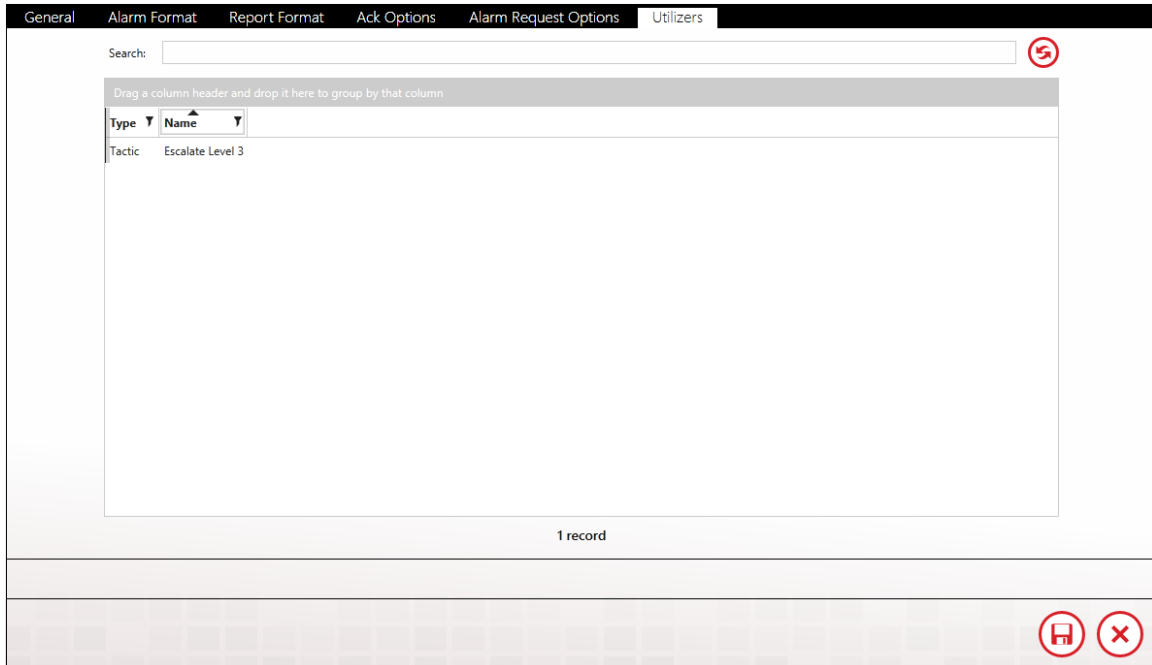

The screenshot displays the 'Utilizers' tab in a software application. At the top, there is a navigation bar with tabs: 'General', 'Alarm Format', 'Report Format', 'Ack Options', 'Alarm Request Options', and 'Utilizers'. Below the navigation bar is a search bar with the text 'Search:' and a red circular icon with a white 'S'. The main content area is a table with a header row and one data row. The header row has columns 'Type' and 'Name'. The data row has columns 'Tactic' and 'Escalate Level 3'. Below the table, it says '1 record'. At the bottom right of the interface, there are two red circular icons: one with a white 'H' and one with a white 'X'.

Type	Name
Tactic	Escalate Level 3

The Utilizers tab is a device that lists all of the tactics associated with this contact. When utilizers are present, WIN-911 prevents the contact from being deleted. If you wish to delete the contact, you will first have to modify the tactic in a manner that will unlink it to this contact. Once all utilizers are cleared, the contact can be deleted.

Mobile-911 Formats

Mobile-911 Formats use XSL to determine how alarms and reports are formatted in your Mobile-911 app. As of 3.16.9, WIN-911 allows users to create and customize their own formats for each notifier.

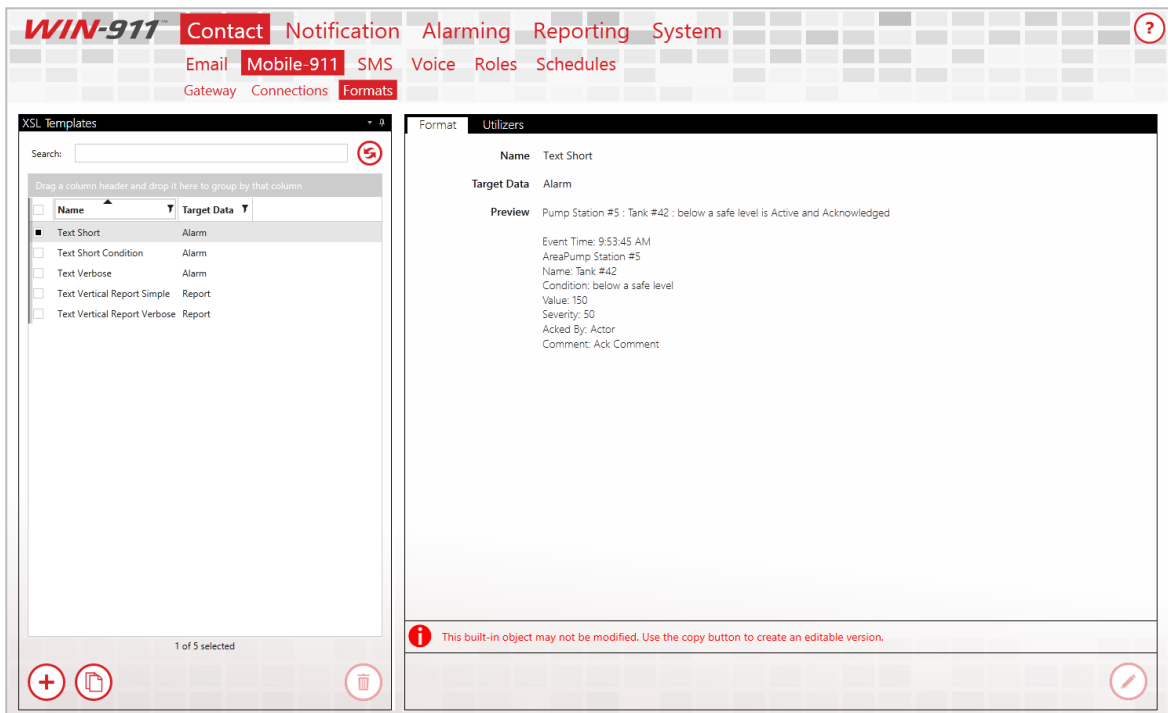

Format

WIN-911, when installed, will initially have five Mobile-911 Formats. Three of them target alarms while the remaining two target reports. The alarm formats will fundamentally list the alarm state, the value of the alarm when your Mobile-911 client is notified, who acknowledged the alarm (if acknowledged), the acknowledgement comment (if acknowledged), and the labels associated with the alarm. These five original Formats cannot be edited nor deleted:

- **Text Short:** an alarm Format that starts with the area, followed by the alarm name then the condition name
- **Text Short Condition:** an alarm Format that starts with just the condition description
- **Text Verbose:** the most descriptive alarm Format for Mobile-911. This one lists out both the alarm details and the condition details
- **Text Vertical Report Simple:** a report Format that lists each report item's name, value, and unit measurement. The alarms entries will include condition name, condition, ack state, who acknowledged the alarm (if acknowledged), and the ack comment (if acknowledged)
- **Text Vertical Report Verbose:** a more descriptive report Format that builds on Text Vertical Report Simple. For items, it'll also lists value time, quality, source, and ID for items. For alarms, It'll also list the alarms' condition descriptions, severity, alarm state, value when alarm was last triggered, value time, source name, and native ID.

To create a new Mobile-911 Format from scratch, click on the '+' button located at the bottom left corner of the XSL Templates list. The following workspace will then appear:

* indicates required fields:

- * **Name:** the name for this Format. Must be unique across all defined SMS Formats
- **Target Data:** determines if this Format is for Alarms or Reports. By default, this will initially be set to Alarm
- * **XSLT:** the XSLT code that will generate the layout for this Format. Must be valid code

WIN-911 User Guide

Due to the granular nature of the code syntax, WIN-911 Software strongly recommend copying from one of the eight original Formats to get started. Select a Format from the XSL Template list, then click the Copy button at the bottom of the list right next to the '+' button. You can then tweak the existing XSLT code however you want to get your desired Format.

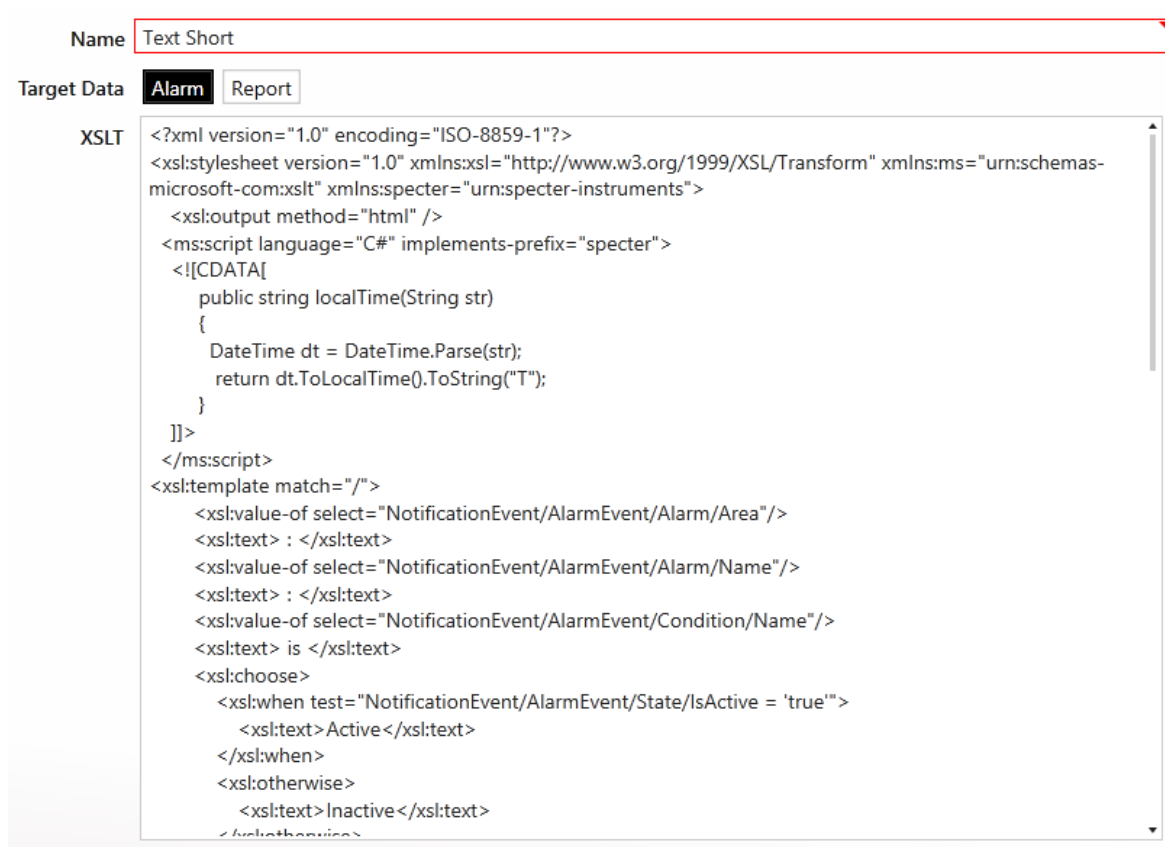

The screenshot shows a software interface for editing XSLT templates. At the top, there is a text input field labeled 'Name' containing the text 'Text Short'. Below this, there are two buttons labeled 'Alarm' and 'Report', with 'Alarm' currently selected. The main area is a text editor labeled 'XSLT' containing the following code:

```
<?xml version="1.0" encoding="ISO-8859-1"?>
<xsl:stylesheet version="1.0" xmlns:xsl="http://www.w3.org/1999/XSL/Transform" xmlns:ms="urn:schemas-microsoft-com:xslt" xmlns:specter="urn:specter-instruments">
  <xsl:output method="html" />
  <ms:script language="C#" implements-prefix="specter">
    <![CDATA[
      public string localTime(String str)
      {
        DateTime dt = DateTime.Parse(str);
        return dt.ToLocalTime().ToString("T");
      }
    ]]>
  </ms:script>
  <xsl:template match="/">
    <xsl:value-of select="NotificationEvent/AlarmEvent/Alarm/Area"/>
    <xsl:text> : </xsl:text>
    <xsl:value-of select="NotificationEvent/AlarmEvent/Alarm/Name"/>
    <xsl:text> : </xsl:text>
    <xsl:value-of select="NotificationEvent/AlarmEvent/Condition/Name"/>
    <xsl:text> is </xsl:text>
    <xsl:choose>
      <xsl:when test="NotificationEvent/AlarmEvent/State/IsActive = 'true'">
        <xsl:text>Active</xsl:text>
      </xsl:when>
      <xsl:otherwise>
        <xsl:text>Inactive</xsl:text>
      </xsl:otherwise>
    </xsl:choose>
  </xsl:template>
</xsl:stylesheet>
```

Note: The validity of the XSLT will partially be determined by which 'Target Data' is selected, since 'Alarm' and 'Report' each comply with different XML prefixes.

Utilizers

The utilizers tab shows which Voice connections make use of the chosen format.

Mobile-911 Advanced Network Considerations

The Mobile-911 Server is a separate product that facilitates WIN-911's dispatching of alarm notifications to Android, iPhone, and Blackberry smart-phone apps. It receives tasking from the WIN-911 Notifier and interfaces with Google's, Apple's, and RIM's push notification service through a live Internet connection. The Mobile-911 Server can be deployed on the local WIN-911 platform or on a separate computer with network access to WIN-911.

In cases where the Mobile-911 Server is deployed on a remote node, WIN-911 will need a method for locating Mobile-911. If WIN-911 is on the same network segment, then "Discovery" is the preferred and most easily configured method. When WIN-911 is located on a separate network (or network segment), the Mobile-911 Server location must be specified by entering the IP and port number at the WIN-911>Contacts>Mobile-911>Gateway tab.

The network administrator will need to set up "port-forwarding" on the Mobile-911 network router to enable incoming messages from WIN-911 to be routed to the Mobile-911 Server's computer port. Likewise, WIN-911's network router will need to be configured to route incoming messages and from the Mobile-911 Server to WIN-911.

When configuring WIN-911 to interface with a Mobile-911 Server on a remote network, enter the Public IP address (or URL) of the Mobile-911 network router. Then enter the router port number that has been forwarded to the Mobile-911 Server.

WIN-911 User Guide

The WIN-911 Bridge port is set to 59109 and must be configured as such in the Mobile-911 Server Settings Manager.

The Mobile-911 Server listening port is set to 59111.

Mobile-911 Server Router Setup

For WIN-911 Access

1) Open a browser on a computer that is part of the Mobile-911 Server network and enter the router administration URL (normally 192.168.1.1). This usually requires a username and password for administrative access.

Note: Be careful not to confuse the internal URL (192.168.1.1) with the Public URL of the router. For this example, we'll use 24.123.252.111 for the router's Public URL.

2) Navigate to the Port Forwarding page of the router administration GUI. Select a unique port number for WIN-911 to request communications with. For this example, we'll use 59100.

3) Enter the local network URL of the Mobile-911 computer (for example: 192.168.1.123).

4) Enter the port number that Mobile-911 will use to receive messages from WIN-911. The default port is 59111.

5) Click the "Apply" button to establish the new forwarding.

The router now actively sends any outside communication request for Port 59100 to endpoint 192.168.1.123:59110. Thus Mobile-911 can hear messages from WIN-911 on a different network.

For Mobile-911 Smartphone Access

In order for a Mobile-911 Smartphone App to send data to a Mobile-911 Server it will need a Public Port forwarded from the Mobile-911 network router to the Mobile-911 Server computer. This port is separate from the port that WIN-911 will use.

6) Back at the Port Forwarding page of the router administration GUI, select a new port number for Mobile-911 Smart phones to request communications with. For this example, we'll use 59102.

7) Enter the local network URL of the Mobile-911 Server computer (for example: 192.168.1.123).

8) Enter the port number that Mobile-911 will use to receive messages from the smartphones. The default port is 59112.

9) Click the "Apply" button to establish the new forwarding.

The router now actively sends any outside communication request for Port 59102 to endpoint 192.168.1.123:59112. Thus Mobile-911 can hear messages from any smartphone configured with this endpoint.

10) From your Mobile-911 Smartphone App, navigate to the Settings Tab. Select the Primary Server setup and enter the URL of Mobile-911 Server (24.123.252.111) and set the Port for 59102.

11) Click the Test Connection button and Mobile-911 App will attempt to contact the Mobile-911 Server and provide feedback indicating success or failure.

WIN-911 Mobile Gateway Setup

- 1) From the WIN-911>Contacts>Mobile-911>Gateway page, select Specify.
- 2) Enter the Mobile-911 Server router's Public URL (24.123.254.111, in the example above).
- 3) Enter the Public Port Number for the Mobile-911 Server (59100, in the example above).
- 4) Click the Test button and WIN-911 will attempt to contact the Mobile-911 Server and provide feedback indicating success or failure.
- 5) If the test fails, ensure the perspective operating system firewalls are set to grant local and public access to Mobile-911 Server and WIN-911.

WIN-911 Network Router Setup

- 1) Open a browser on a computer that is part of the WIN-911 network and enter the router administration URL (normally 192.168.1.1). This usually requires a username and password for administrative access. For the sake of this example we'll use 24.123.252.222 for the router's Public URL.
- 2) Navigate to the Port Forwarding page of the router administration GUI. Select a unique port number for Mobile-911 Server to request communications with. For the sake of this example we'll use 59101.

- 3) Enter the local network URL of the WIN-911 computer (for example: 192.168.1.223)
- 4) Enter the port number that WIN-911 will use to receive messages from Mobile-911 Server. The default port is 59109.
- 5) Click the "Apply" button to establish the new forwarding.

The router now actively sends any outside communication request for Port 59101 to endpoint 192.168.1.223:59109. Thus WIN-911 can hear messages from Mobile-911 Server on a different network.

Mobile-911 Server Setup

- 1) From the Mobile-911 Server Manager Bridge Server tab, select Specify.
- 2) Enter WIN-911's public router URL (24.123.254.222, in the above example).
- 3) Enter the Public Port Number for WIN-911 (59101, in the above example).
- 5) Ensure the operating system firewall is set to grant local and public access to Mobile-911 Server.

SMS Gateway

The SMS Gateway is used to configure the necessary settings for WIN-911 to communicate with the cellular modem(s) it will use to conduct remote notifications.

Gateway

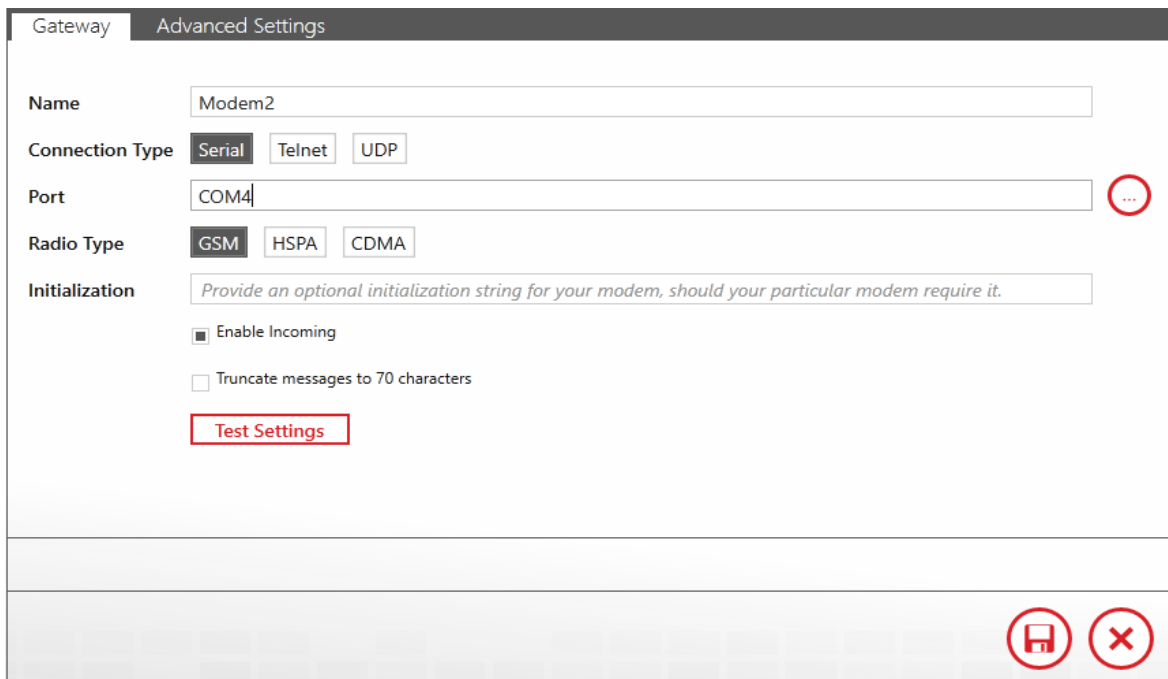

The screenshot shows the 'Advanced Settings' window for a Gateway. The window has a title bar with 'Gateway' and 'Advanced Settings'. The settings are as follows:

- Name:** Modem2
- Connection Type:** Serial (selected), Telnet, UDP
- Port:** COM4 (with a red circle containing three dots to its right)
- Radio Type:** GSM (selected), HSPA, CDMA
- Initialization:** Provide an optional initialization string for your modem, should your particular modem require it.
- Enable Incoming
- Truncate messages to 70 characters
- Test Settings** (button)

At the bottom right of the window, there are two red circular icons: a save icon and a close icon.

WIN-911 needs exclusive access to a cellular modem registered with a text service provider account. The gateway settings include the location of the modem as well as all the necessary information about modem COM parameters.

You can configure multiple modem gateways for failover protection in the event that one modem becomes unavailable. WIN-911

automatically load balances tasking between the configured gateways to ensure optimum throughput.

Name

A unique name must be given to each SMS gateway. We suggest a name that would help the administrator identify attributes of the modem like its service provider, phone number, etc. The name given is at the discretion of the administrator and does not have any bearing on the systems functionality.

Connection Type

Serial

When a cellular modem is physically connected via USB or RS232 to the WIN-911 host click the Serial button. You will then be prompted for the associated COM port.

Port Option

Browse and select the serial port that WIN-911 will use to communicate with the cellular modem. The proper syntax would be "COM3" for comm port number 3. See Phone and Modems or Device Manager for details.

Telnet

Remotely located cellular modems can be used by WIN-911 using Telnet

Address (for Telnet connections)

Enter the IP address (or host name) and port number of the remote cellular modem

WIN-911 User Guide

User Login (for Telnet connections)

Tick this box if the remote cellular modem is configured to require credentials in order to log in.

User Name (for Telnet connections)

Enter the user name that the remote modem requires for authentication during login.

Password (for Telnet connections)

Enter the user password that the remote modem requires for authentication during login.

UDP

Remotely located cellular modems can be used by WIN-911 using UDP.

Address (for UDP connections)

Enter the IP address (or host name) and port number of the remote cellular modem

Radio Type

WIN-911 supports three types of radio standards, GSM, HSPA, and CDMA. The type of radio you choose is dictated by the modem hardware and the SMS texting service provider you choose to support application. Check with your service provider and hardware manufacturer to determine your radio type.

GSM

Multitech models MTC-G3, MTR-G3, MTCBA-G2 are supported with GSM networks like AT&T and Verizon.

HSPA

Multitech models MTC-H5, MTR-H5, Sierra Wireless Airlink RV50X are supported with HSPA networks like AT&T and Verizon

CDMA

Multitech models MTC-C3, MTR-C2, MTCBA-C1 are supported with CDMA networks like Verizon.

Initialization

This string represents the AT command sent to initialize and test the modem.

Enable Incoming

Tick this box to enable WIN-911 to receive SMS messages from the remote users such as alarm, acknowledgement, and report requests.

Test Settings

Several parameters that determine the modem's ability to conduct remote notification are tested when this button is clicked: signal strength, registration with the service provider, and the bit error rate. It also sends a test message to the phone number you enter when prompted by WIN-911.

Network Registration Status: your modem should be properly registered with your service provider and on its home network (not roaming). If it reports as roaming, please contact your service provider to correct the problem or check our <https://supportdesk.WIN-911.com/support/solutions>.

Signal Quality: the network's signal strength should be in the acceptable range to ensure a reliable connection to your service provides. If the strength is insufficient you should consider moving your modem to an area with better reception. Note that the Telnet option allows WIN-911 to connect to a remotely

WIN-911 User Guide

located modem, in the event that your WIN-911 host is located in an area with bad reception. The appropriate signal strength should be 10 or more.

Bit Error Rate: the number of bit errors per unit time.

Test Message: WIN-911 sends a test message to the phone number you enter at the prompt. If WIN-911 receives a "message sent successfully" response from service provider, then the test message will be considered successful. The phone will receive a message: The Modem configuration your provided appears correct.

Advanced Settings

The screenshot shows a window titled "Gateway" with a sub-tab "Advanced Settings". The window contains the following settings:

Baud Rate	115200
Data Bits	8
Stop Bits	1
Flow Control	RTS/CTS
Parity	None
Timeout (seconds)	125

Below the settings are two buttons: "Test Settings" and "Purge SMS Queue". The window has a title bar with "Gateway" and "Advanced Settings" tabs, and a footer with a save icon and a close icon.

Baud Rate (serial connection)

The cellular modem's baud rate may be set from 110 to 921600 (115200 default). This selection controls the speed at which WIN-911 will communicate with the cellular modem. Refer to the

modem's documentation or contact the modem manufacturer for the specified recommended Baud.

Data Bits (serial connection)

The cellular modem data bits can be set to "Unspecified, 5, 6, 7, or 8". The default setting is 8 data bits. Refer to the modem's documentation or contact the modem manufacturer for recommended Data Bits.

Stop Bits (serial connection)

The cellular modem stop bits can be set to "None, 1, 1.5, or 2". The default setting is 1 stop bit. Refer to the modem's documentation or contact the modem manufacturer for recommended Stop Bits.

Flow Control (serial connection)

The cellular modem flow control can be set to "None, XON/XOFF, RTS/CTS (default), and RTS/XOnXOff". The default setting is RTS/CTS. Refer to the modem's documentation or contact the modem manufacturer for recommended flow control.

Parity (serial connection)

The cellular modem Parity can be set to "Even, Odd, None, Mark, and Space". The default setting is None. Refer to the modem's documentation or contact the modem manufacturer for recommended Data Bits.

Timeout (seconds)

This is total time WIN-911 will wait for an expected response from the modem. Setting this value too low may cause the initialization and/or modem commands to fail. The default value is 125 seconds and can be varied from a minimum of 20 and a maximum of 600.

Test Settings

Several parameters that determine the modem's ability to conduct remote notification are tested when this button is clicked: signal strength, registration with the service provider, and the bit error rate. It also sends a test message to the phone number you enter when prompted by WIN-911.

Purge SMS Queue

Purge all pending SMS messages from the queue so WIN-911 will be able to send alarm messages immediately.

SMS Connections

Connections specify a destination for alarm notification messages. SMS connections also determine just what you will see in alarm and report text messages, connection availability and the permissions a connection has been granted concerning acknowledgement and report requests.

General

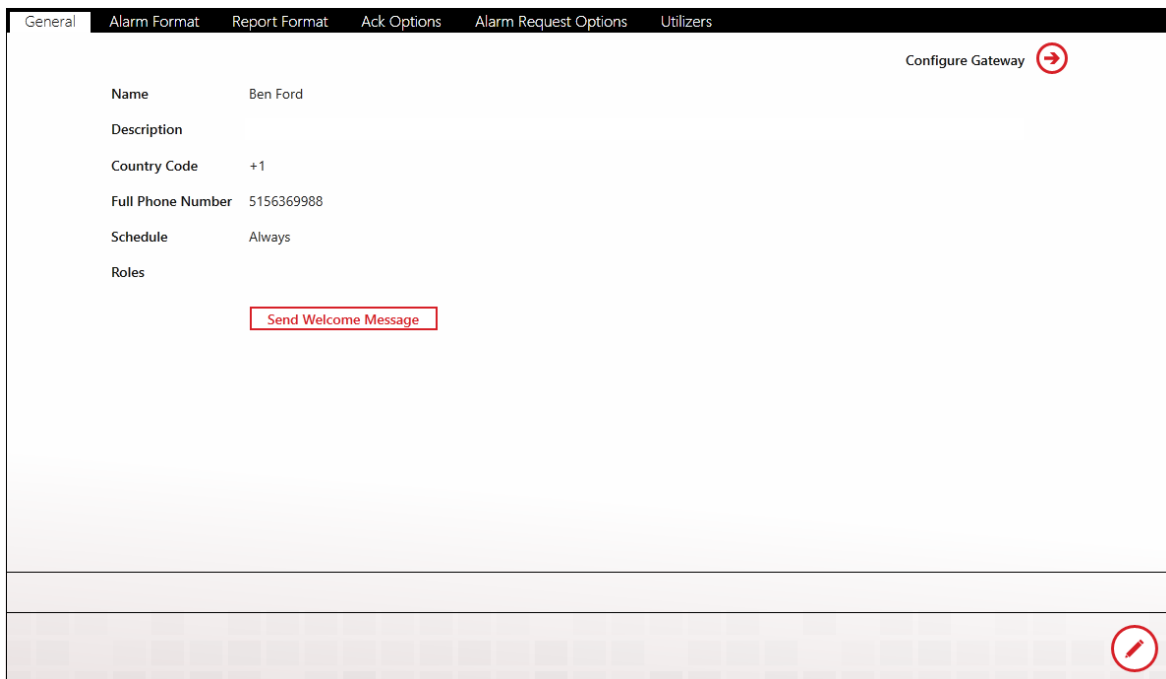

The screenshot displays the configuration interface for an SMS connection, with the 'General' tab selected. The interface includes a navigation bar at the top with tabs for 'General', 'Alarm Format', 'Report Format', 'Ack Options', 'Alarm Request Options', and 'Utilizers'. A 'Configure Gateway' button with a right-pointing arrow icon is located in the top right corner. The main content area shows the following configuration details:

Name	Ben Ford
Description	
Country Code	+1
Full Phone Number	5156369988
Schedule	Always
Roles	

Below the configuration details, there is a button labeled 'Send Welcome Message'. At the bottom right of the interface, there is a red circular icon with a pencil, indicating an edit function.

Name

Each SMS connection must have a unique name that identifies the particular connection.

Description

An extra text field for organization and administration purposes, similar to a code comment.

Country Code

Enter the country code of the alarm recipient. US and Canadians users enter +1 (default).

Full Phone Number

Enter the entire cell phone number, excluding the country code.

Schedule

View or select the schedule that WIN-911 will honor when sending alarm and report messages. A connection can have only one assigned schedule, but a schedule can contain multiple appointments. See [Schedules](#).

Roles (for use by Advanced Tactics)

View or assign roles to the selected connection by clicking the add button in edit mode. Each connection can have multiple roles. See [Roles](#).

Send Welcome Message

Click the "Send" button in view or edit mode to send a WIN-911 Welcome message to the selected connection. The welcome message

will test the gateway and connection settings. The test message should read the following:

"Welcome to the WIN-911 System! For instructions on how to use the system, make sure your SMS connection is saved, and send in the text "help"."

Alarm Format

The screenshot shows a software window titled "Alarm Format" with several tabs: "General", "Alarm Format", "Report Format", "Ack Options", "Alarm Request Options", and "Utilizers". The "Alarm Format" tab is active. Inside the window, there is a "Body" section with a dropdown menu set to "Long Condition Format". Below this is a "Preview" section showing a sample alarm message:

```
The tank is below the safe level and requires attention. is Active and Acknowledged.
below a safe level
Tank #42
Value: 150
Acknowledged by: Actor
Ack Comment
3/20/2013 9:53:45 AM
Labels: Label Name
```

At the bottom right of the window, there are two red circular icons: a save icon (floppy disk) and a close icon (X).

Body

Select an alarm message format from the six available options: Condition Format, Diagnostic Format, List Format, Long Alarm Format, Long Condition Format, and Short Alarm Format.

Condition Format, Diagnostic Format, List Format, Long Alarm Format, Long Condition Format, and Short Alarm Format. The simple selections include minimal information about the alarm whereas the

WIN-911 User Guide

verbose options include details. The Diagnostic option is the most detailed and includes information

Preview

A "What You See is What You Get" window shows the administrator what an alarm message will look like with the current options selected.

Report Format

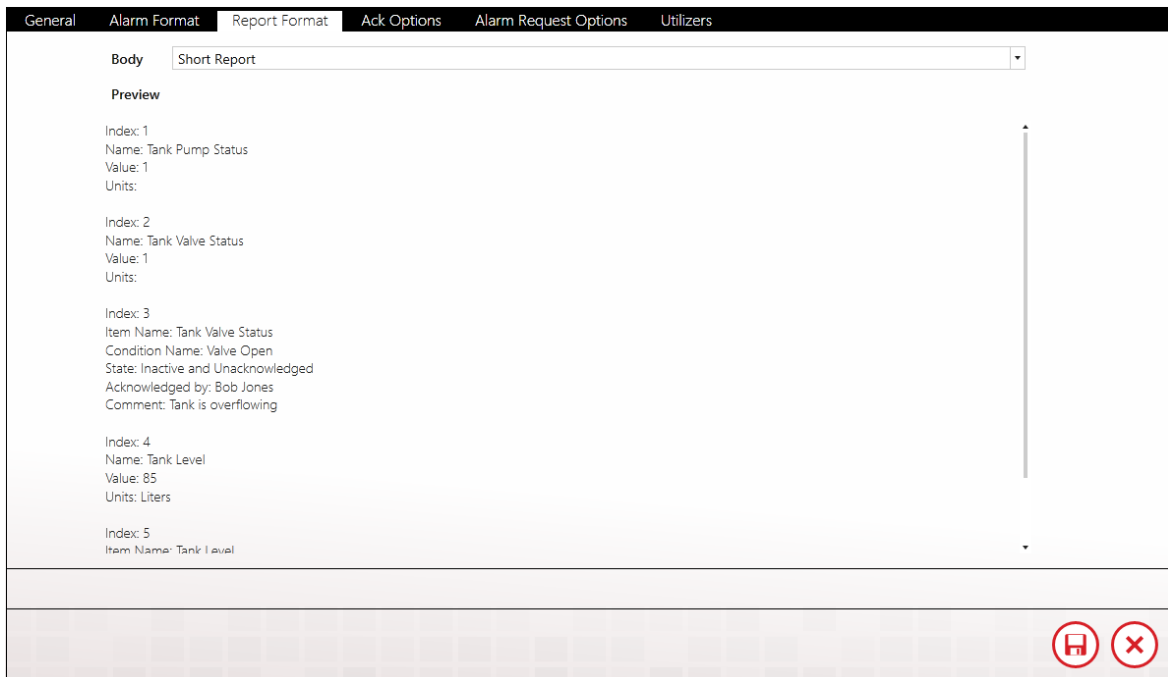

Body

View or select the report message format from the two available options: Long Report and Short Report. The short selection includes minimal information about the alarm whereas the long option includes amplified details.

Preview

A "What You See is What You Get" window shows the administrator what a report message will look like with the current options selected.

Ack Options

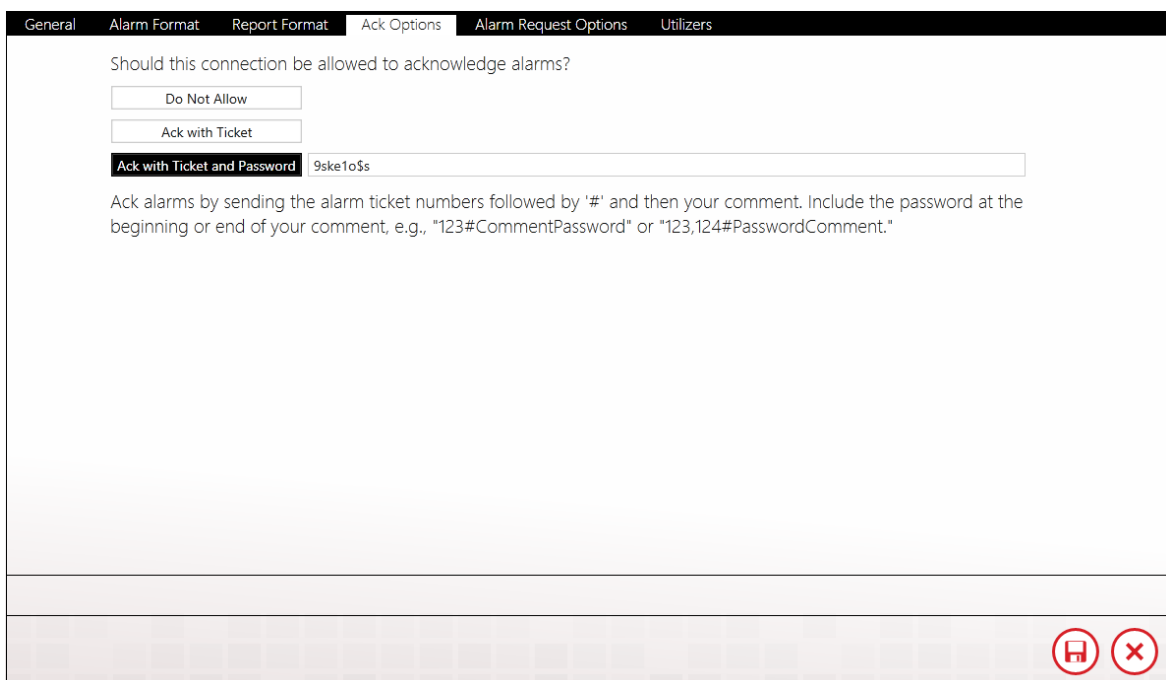

The screenshot shows a configuration window with a dark header bar containing several tabs: 'General', 'Alarm Format', 'Report Format', 'Ack Options', 'Alarm Request Options', and 'Utilizers'. The 'Ack Options' tab is selected. Below the header, the text reads: 'Should this connection be allowed to acknowledge alarms?'. There are three radio button options: 'Do Not Allow', 'Ack with Ticket', and 'Ack with Ticket and Password'. The 'Ack with Ticket and Password' option is selected. To the right of this option is a text input field containing the value '9ske1o\$s'. Below the input field, there is a descriptive text: 'Ack alarms by sending the alarm ticket numbers followed by '#' and then your comment. Include the password at the beginning or end of your comment, e.g., "123#CommentPassword" or "123,124#PasswordComment."'. At the bottom right of the window, there are two red circular icons: a save icon and a close icon.

View or select the connection's acknowledgement options with this tab.

Do Not Allow

The default selection for SMS connections is to not allow the connection the ability to acknowledge alarms.

Ack with Ticket

Alarms can be acknowledged by responding to the alarm message with the ticket number included in the alarm message.

Ack with Ticket and Password

An added layer of security can be added by requiring the actor to include a password along with the ticket number of the alarm in the response message. This option contains a text entry box where the ack password is defined. The password will not be visible in view mode. To acknowledge alarms using a password, include the password in the body of your reply SMS.

To provide a comment with your acknowledgement, enter "#:" (pound or hash character) followed by your comment in the body of your reply SMS.

Alarm Request Options

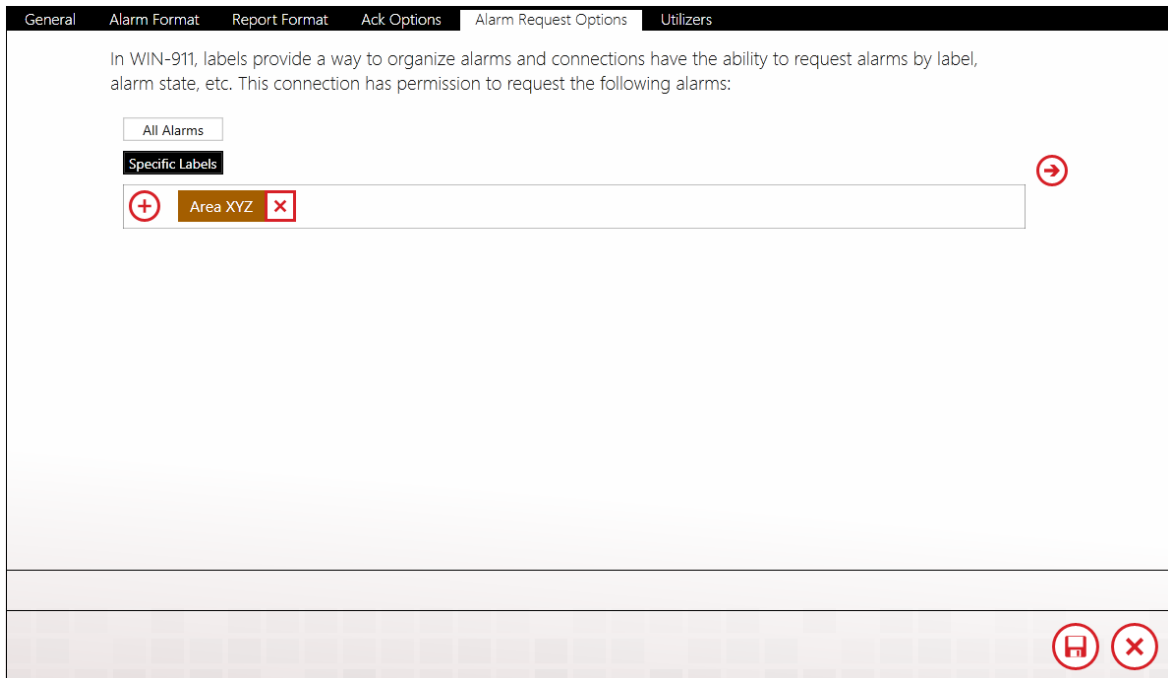

Connections have two options available for actively requesting alarm information: All Alarms, or Specific Alarms. If the Administrator wishes

to limit the connection's alarm request to specific Labels, they must be specified by using the Labels selection tool. There are no limits to the number of labels that can be assigned to a connection.

See [Using SMS](#) for an example of an SMS alarm request.

See [Labels](#) for more details.

Utilizers

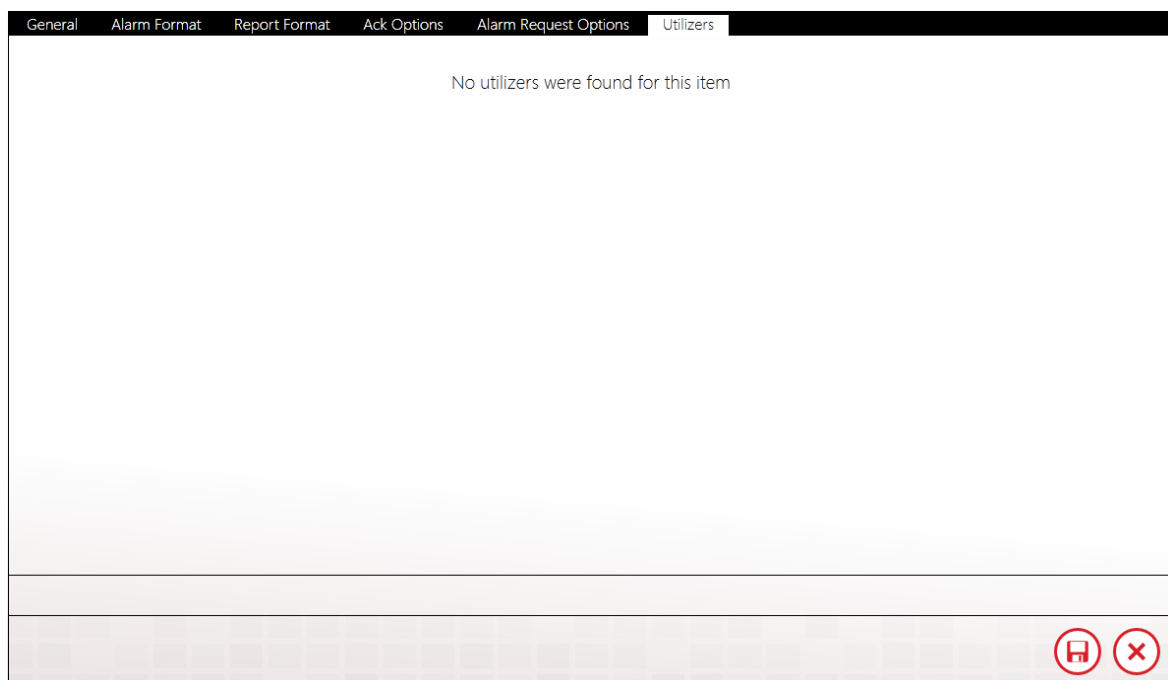

The Utilizers tab is a bookkeeping device that lists all of the tactics associated with this contact. When utilizers are present WIN-911 prevents the contact from being deleted. If you wish to delete the contact, you will first have to modify the utilizing tactic in a manner that will unlink it to this contact. Once all utilizers are cleared, the contact can be safely deleted.

SMS Formats

SMS Formats use XSL to determine how alarms and reports are formatted in your SMS text messages. As of 3.16.9, WIN-911 allows users to create and customize their own formats for each notifier.

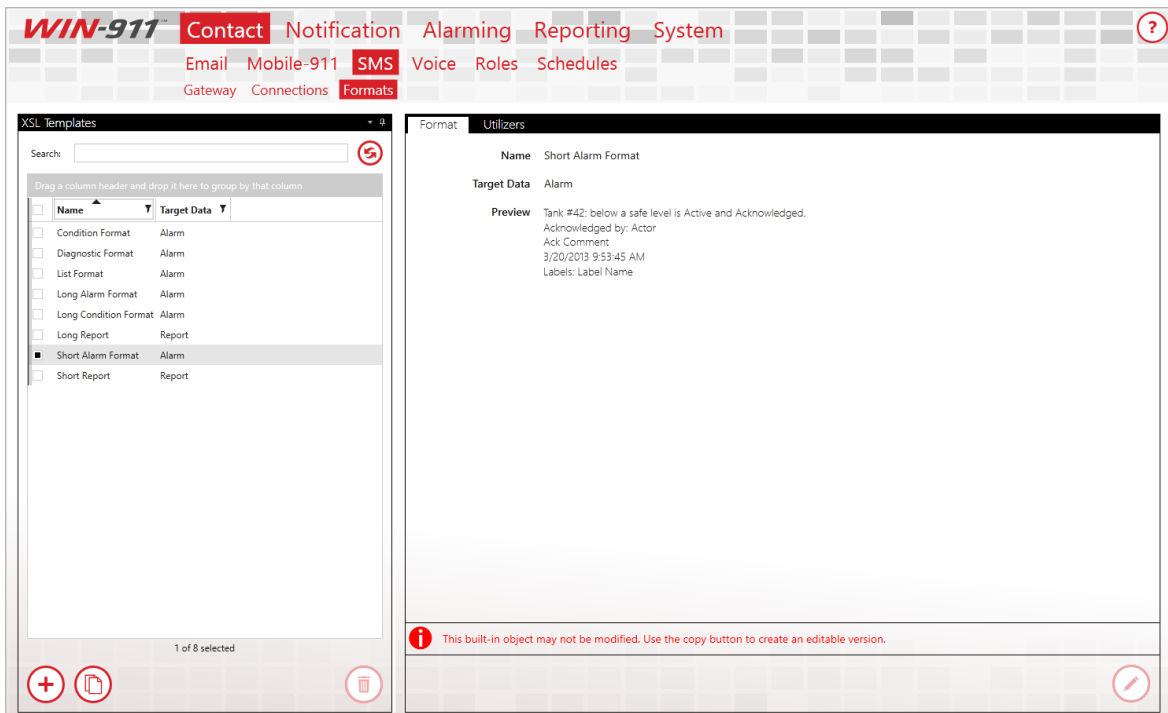

Format

WIN-911, when installed, will initially have eight SMS Formats. Six of them target alarms while the remaining two target reports. The alarm formats will fundamentally list the alarm state, the value of the alarm when the SMS connection is notified, who acknowledged the alarm (if acknowledged), the acknowledgement comment (if acknowledged), and the labels associated with the alarm. These eight original Formats cannot be edited nor deleted:

- **Condition Format:** an alarm Format with the condition description as the first part of the message
- **Long Condition Format:** an alarm Format that starts with the condition description, followed by the alarm state then the condition name and other fundamental information bits
- **List Format:** an alarm Format that lists in the beginning the name and description of the targeted alarm, followed by the fundamental information bits
- **Short Alarm Format:** an alarm Format that starts with the alarm name, followed by the condition name then the fundamental information
- **Long Alarm Format:** an alarm Format that starts with the alarm description, followed by the condition description
- **Diagnostic Format:** the most descriptive alarm Format. Includes alarm details, condition details, and diagnostic information for the more curious. Diagnostic details include the alarm lifetime ID, triggering Strategy, and executing Tactic
- **Short Report:** a report Format that lists each targeted report item's name, value, and unit measurement
- **Long Report:** a report Format that lists each targeted report item's name, description, area, value, unit measurement, value time, quality, source, and labels

To create a new SMS Format from scratch, click on the '+' button located at the bottom left corner of the XSL Templates list. The following workspace will then appear:

WIN-911 User Guide

The screenshot shows a web interface for configuring a format. At the top, there are two tabs: 'Format' and 'Utilizers'. The 'Format' tab is selected. Below the tabs, there are three main sections:

- Name:** A text input field with a red border and a red error message: "Format name required".
- Target Data:** Two radio buttons, "Alarm" (which is selected) and "Report".
- XSLT:** A text input field with a red border and a red error message: "Enter your XSLT here. Copy an existing format as a starting point."

* indicates required fields:

- * **Name:** the name for this Format. Must be unique across all defined SMS Formats
- **Target Data:** determines if this Format is for Alarms or Reports. By default, this will initially be set to Alarm
- * **XSLT:** the XSLT code that will generate the layout for this Format. Must be valid code

Due to the granular nature of the code syntax, WIN-911 Software strongly recommend copying from one of the eight original Formats to get started. Select a Format from the XSL Template list, then click the Copy button at the bottom of the list right next to the '+' button. You can then tweak the existing XSLT code however you want to get your desired Format.

Name

Target Data

XSLT

```
<?xml version="1.0" encoding="ISO-8859-1"?>
<xsl:stylesheet version="1.0" xmlns:xsl="http://www.w3.org/1999/XSL/Transform" xmlns:ms="urn:schemas-
microsoft-com:xslt" xmlns:msxsl="urn:schemas-microsoft-com:xslt">
  <xsl:output method="text"/>
  <xsl:template match="/">
    <xsl:if test="Report/GenericResult/Succeeded='false'">
      <xsl:text> Error Fetching Result - </xsl:text>
      <xsl:value-of select="Report/GenericResult/Error"/>
      <xsl:text>

    </xsl:text>
    </xsl:if>

    <xsl:for-each select="Report/Items/*">
      <xsl:choose>
        <xsl:when test="GenericResult/Succeeded = 'false'">
          <xsl:text>Error Fetching Result -</xsl:text>
          <xsl:value-of select="GenericResult/Error"/>
          <xsl:text>
        </xsl:text>
        </xsl:when>
        <xsl:otherwise>
          <xsl:if test="Type='Data'">
            <xsl:text>Index: </xsl:text>
            <xsl:value-of select="Index"/>
            <xsl:text>
          </xsl:if>
        </xsl:otherwise>
      </xsl:choose>
    </xsl:for-each>
  </xsl:template>
</xsl:stylesheet>
```

After saving a created Format, you can then select it under SMS Connections in the Format tabs. If it targets alarms, it'll show up in the Alarm Format tab combo box, Report Format tab combo box otherwise.

Notes: The validity of the XSLT will partially be determined by which 'Target Data' is selected, since 'Alarm' and 'Report' each comply with different XML prefixes.

Utilizers

The utilizers tab shows which Voice connections make use of the chosen format.

Using SMS

Alarm event messages can be sent to a cellular device when triggered by a WIN-911 Strategy or in response to a request made by a cellular device user. The SMS notifier can provide one-way or two-way communication with any number of cellular devices. With the two-way setting the user can respond to alarm events with an acknowledgement code or request current conditions by querying reports.

Acknowledging Alarms

Alarm events will be assigned a ticket number that the recipient can use to acknowledge the alarm. This is done by sending a text message to WIN-911 with the ticket number.

An example of an alarm test message with a ticket number of 308 would be as follows:

Message

308
TankLevel is
Above the High Limit & Unacknowledged
Value: 12 ft
1/22/2016, 3:03 PM

Response

308

WIN-911 can be configured to add a layer of security by requiring an acknowledgement code to the ack request. Simply enter the ticket number, followed by the pound (or hash) sign, #, and the acknowledge code.

An example of an alarm text message with a ticket number of 308 and a valid acknowledgement response with a password of '123'

Message

308
TankLevel is
Above the High Limit & Unacknowledged
Value: 12 ft
1/22/2016, 3:03 PM

Response

308#123

If you wish to enter a comment, enter it after the #, along with the password. It can be before or after the actual password. So, the following two examples would produce the same results:

308#123This is a comment

308#This is a comment123

Requesting Alarms

WIN-911 User Guide

Request alarms by texting in the word "get" followed by an alarm state. e.g., "get active unacked." Your choices are a combination of "active/inactive + acked/unacked."

get active unacked
get active acked
get inactive unacked

Requesting Reports

Request reports by texting the word "report" followed by a report's name or number. e.g., 'report 1'.

report 3
report safety

Request a list of available reports by sending in "list reports."

Translations of SMS Commands

Commands	Arabic
Request Alarms	طلب الإنذارات
Get Report	الحصول على تقارير
Get Help Information	الحصول على معلومات المساعدة
Get List of Reports	الحصول على قائمة التقارير

Commands	German
Request Alarms	Erhalten

Get Reports	Bericht
Get Help Information	Hilfe
Get List of Reports	Listen Berichte

Commands	Spanish
Request Alarms	Obtener
Get Reports	Informe
Get Help Information	Ayuda
Get List of Reports	Lista de Informes

Commands	French
Request Alarms	Obtenir
Get Reports	Rapport
Get Help Information	Aide
Get List of Reports	Liste Des Rapports

Commands	Hebrew
Request Alarms	בקש אזעקות
Get Reports	קבל דוחות
Get Help Information	קבל מידע עזרה
Get List of Reports	קבל רשימת דוחות

Commands	Italian
Request Alarms	Ottieni
Get Reports	Relazione
Get Help Information	Guida
Get List of Reports	Elenco Raporti

Commands	Portuguese
-----------------	-------------------

WIN-911 User Guide

Request Alarms	Obter
Get Reports	relatório
Get Help Information	Ajuda
Get List of Reports	Lista de relatórios

Commands	Simplified Chinese
Request Alarms	得到
Get Reports	报告
Get Help Information	救命
Get List of Reports	报告清单

Voice Gateway

General

WIN-911 provides its users with two options for conducting voice alarm notification: 1) SIP/VoIP or 2) a TAPI compliant voice modem. The SIP/VoIP option uses the Internet to place phone calls and must be used in conjunction with a SIP service provider account. The TAPI option requires a TAPI compliant modem and a dedicated analog phone line. ([See System Requirements for more details](#))

Voice Hardware: TAPI

The screenshot displays the configuration interface for the Voice Gateway, specifically the Audio tab. The interface is divided into two sections: General and Audio. The Audio tab is active, and the Voice Hardware is set to TAPI. The TAPI Voice Modem field is empty, and the Dialing Prefix field contains the placeholder text "Enter a dialing prefix if your phone system requires it, e.g. a '9' to get an outside line." A red warning icon is visible next to the TAPI Voice Modem field. At the bottom of the window, a red warning message states "You must select a voice on the Audio tab." The window also features standard save and close buttons.



General Audio

Voice Hardware **TAPI** SIP/VOIP

TAPI Voice Modem 

Dialing Prefix

 You must select a voice on the Audio tab.

TAPI Voice Modem

Select the TAPI compatible voice modem currently installed on the WIN-911 Voice Notifier machine. If the pull-down list is empty when the down arrow is clicked, then there is no TAPI compatible modem installed or the current drivers for the modem do not include support for TAPI.

Voice Hardware: SIP/VoIP

The screenshot shows the 'Audio' tab of the configuration window. The 'Voice Hardware' section has 'SIP/VOIP' selected. The 'SIP Account' section includes fields for 'User ID' (79785424735741), 'Display Name' (shebotz), and a 'Registration Required' checkbox. It also has dropdowns for 'Bi-Directional Channels' (1), 'Inbound Channels' (0), and 'Outbound Channels' (0). A note states: 'WIN-911 supports a maximum of 8 channels. Your SIP provider may support more or less than this amount - your configuration must specify a number of channels up to the lesser of these amounts.' The 'Network' section includes fields for 'Server Address' (sip.voip.com), 'Proxy Address' (The SIP proxy server address.), 'NAT Type' (None), 'Port' (5060), 'SIP Port' (5700), 'Minimum Port' (5700), 'Maximum Port' (5750), 'Binding Address' (Use all), and 'Transport Type' (UDP). A red warning icon and message at the bottom left state: 'You must select a voice on the Audio tab.' Save and close buttons are at the bottom right.

SIP Account

User ID

The user name that identifies you as a subscriber to the SIP server.

Display Name

The name that will be displayed by the call receiver's caller ID.

Authentication Required

If your SIP server requires additional credentials tick this box to enter an additional user name and password.

ID

SIP identification code for account authentication.

Password

SIP password for account authentication.

Number of Unreserved Channels

Channels can be reserved for inbound or outbound only call processing. This setting designates the number of unreserved channels for the specified SIP account.

Number of Inbound Channels

Channels can be reserved for inbound call processing only. These channels will not process outbound calls.

Number of Outbound Channels

Channels can be reserved for outbound call processing only. These channels will not process inbound calls.

Network

Server Address

Enter the URL of SIP server that WIN-911 will use to conduct alarm notification.

Proxy Address (Optional)

Some SIP providers require connection via a proxy server. Enter the URL of the proxy server that WIN-911 will use to conduct alarm notification.

WIN-911 User Guide

NAT Type

Select the type of Network Address Translation the SIP server requires for WIN-911 to conduct alarm notification.

- None: Default
- STUN: Simple Transversal of UDP over NATs is a protocol for assisting devices behind a NAT firewall or router with their packet routing.
- TURN: Transversal Using Relay NAT is an extension for STUN-bis protocol to facilitate NAT traversal when one or both endpoints are behind NAT.
- Manual

Server

NAT types STUN and TURN use servers to route data behind the NAT firewall. Enter the name of the NAT server that WIN-911 will use to interface with the SIP provider.

Username

Enter the username that WIN-911 will use when logging on to either a STUN or TURN NAT.

Password

Enter the password that WIN-911 will use when logging on to either a STUN or TURN NAT.

Public IP

Enter the public IP address will use when logging on to a Manual NAT.

SIP Port

Enter the port number that WIN-911 will use to interface with the SIP server.

Minimum Port

Enter the lower port number of the range of possible ports WIN-911 will use the conduct alarm notification.

Maximum Port

Enter the upper port number of the range of possible ports WIN-911 will use the conduct alarm notification.

Binding Address

IP Address used to bind to a particular port.

Transport Type

Select the transport protocol that WIN-911 will use to interface with your SIP provider.

- UDP: User Datagram Protocol uses packet-based data that is sent as discrete packets. UDP does not provide error correction.
- TCP: Transmission Control Protocol uses a stream of packets and provides error correction.
- TLS: Transport Layer Security is a cryptographic protocol that provides communication security over the Internet.
- STCP: Simple TCP is a full duplex, connection-oriented transport layer that guarantees in-order delivery.

SRTP Mode

Select the desired mode of Secure Real-time Transport Protocol that WIN-911 will use to interface with the SIP provider. SRTP provides encryption, message authentication and integrity, as well as playback protection.

- None: Default
- Prefer: This mode prefers but does not require SRTP be used.
- Force: This mode requires the use of SRTP.

Test SIP Settings

This button only appears in view mode and when clicked will invoke a dialog that will send a test message to the phone

number that you enter. Once the call rings through a test message will be played indicating that your SIP gateway settings are correct. If the settings are not correct, then an error message will be displayed which will advise you to check your settings. Check you Event Viewer for a more detailed explanation of the nature of the failure.

Audio

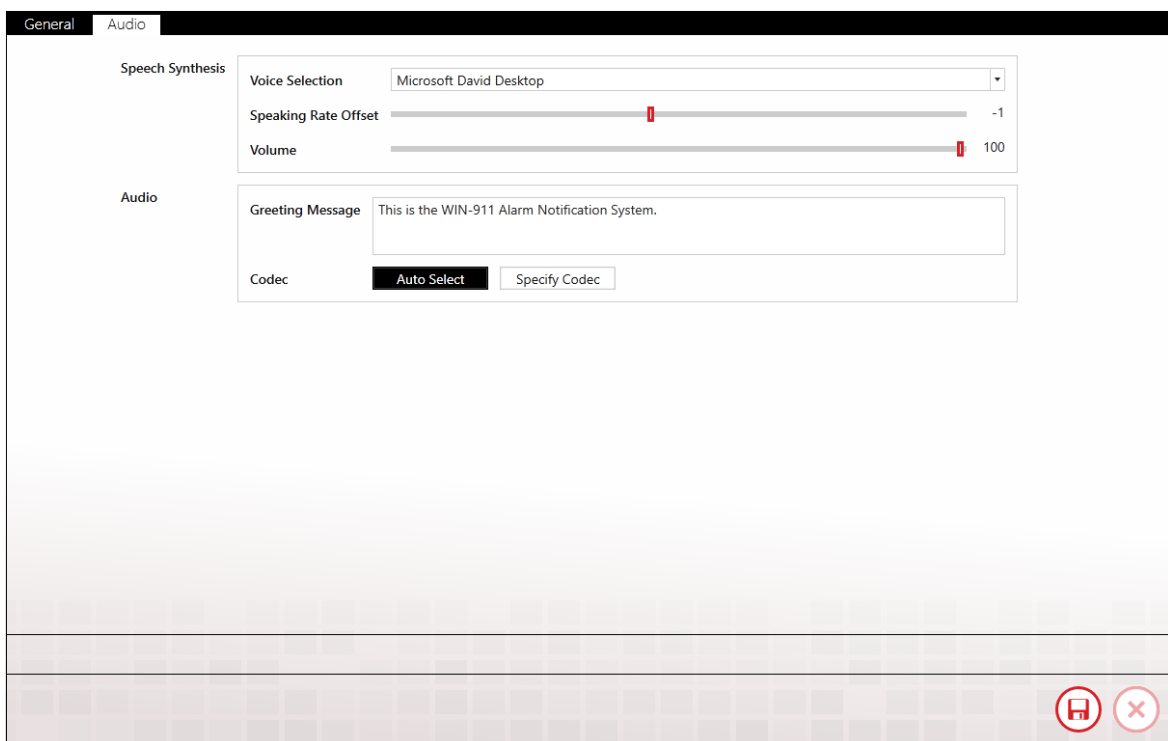

The screenshot displays the 'Audio' configuration window. At the top, there are two tabs: 'General' and 'Audio', with 'Audio' being the active tab. The window is divided into two main sections: 'Speech Synthesis' and 'Audio'.
Under 'Speech Synthesis', there are three controls:

- 'Voice Selection': A dropdown menu currently set to 'Microsoft David Desktop'.
- 'Speaking Rate Offset': A horizontal slider with a red indicator, currently set to -1.
- 'Volume': A horizontal slider with a red indicator, currently set to 100.

Under the 'Audio' section, there are two controls:

- 'Greeting Message': A text input field containing the text 'This is the WIN-911 Alarm Notification System.'
- 'Codec': A section with two buttons: 'Auto Select' (highlighted in black) and 'Specify Codec'.

At the bottom right of the window, there are two circular icons: a save icon (floppy disk) and a close icon (X).

Speech Synthesis

These are global settings that can be overridden in Connections>Speech Synthesis section for individual voice connections.

Voice

Select the Text to Speech voice that WIN-911 will use to conduct voice alarm notification. The voice must use SAPI 5 or higher speech engine.

Speaking Rate Offset

Modify the default rate of speech -10 to 10 with the slider bar to refine the speech rate for your application.

Volume

Modify the volume of speech -100 to 100 decibels with the slider bar to refine the volume for your application.

Audio

Greeting Message

Enter the string that WIN-911 will use to speak the salutation.

Codec

A codec encodes a data stream for transmission, storage or encryption, or decodes it for playback or editing.

- Autoselect: WIN-911 will automatically select the codec to use. (Default)
- Specify Codec: Enter the particular codec that WIN-911 will use to verbalize alarm notification messages.

Voice Connections

Connections specify a destination for alarm notification, as well as scheduled availability and permissions. Voice connections also determine what your alarms and reports sound like on the phone.

General

The screenshot shows a web interface for configuring a voice connection. The 'General' tab is active, with other tabs like 'Alarm Format', 'Report Format', 'Speech Synthesis', 'Utilizers', 'Favorites', and 'Options' visible. The form contains the following fields and controls:

- Name:** Text input field containing 'Charles Specter'.
- Description:** Empty text input field.
- Phone Number:** Text input field containing '515-324-9518'.
- Interactivity:** Two radio buttons, 'Interactive' (selected) and 'Non-Interactive'.
- Authorization Code:** Text input field containing '7'. Below it is a checkbox labeled 'Require additional Caller-ID authentication' which is unchecked.
- Greeting Message:** Text input field containing 'Hello Charles, this the alarm system'.
- Schedule:** Dropdown menu set to 'Always'.
- Roles:** A red '+' icon in a circle.
- Configure Gateway:** A red arrow icon in a circle at the top right.
- Save/Cancel:** Red icons for a floppy disk (save) and an 'x' (cancel) at the bottom right.

Name

Each voice connection must have a unique name that identifies the particular connection.

Description

An extra text field for organization and administration purposes, similar to a code comment.

Phone Number

Enter the phone number of this particular connection. SIP account requires the country code at the beginning of the number. Many VoIP providers alternatively use an alpha-numeric string in place of a phone number. It is acceptable to assign a unique phone number to multiple connections if your situation warrants such action; however, a warning message will be generated to inform the WIN-911 administrator that a pre-existing connection already uses this number/string and lists the number of times it has been used.

Interactivity

Interactive

This mode of alarm notification is a two-way dialog between WIN-911 and the user. It requires the recipient to enter an authorization code and can be configured to allow remote acknowledgements by use of an ack code. The user can optionally be given permission to make inbound calls to request alarm conditions and reports.

Note: The star key "" can be used at any time to have WIN-911 repeat the current segment of the message and the zero key "0" can be used to move the alarm message back one level. The message can be backed up as far as the main menu and then a subsequent zero key will end the call.*

Non-Interactive

This mode of alarm notification is a one-way transmission of alarm messages. It only conducts outbound calls, reports the

WIN-911 User Guide

alarm conditions, and disconnects the call on completion. It is intended for public address announcements and leaving messages on voice mail. It does not accept user input or answer inbound calls.

Authorization Code

Interactive calls require user authentication by entering a numeric code that can range from one to 24 digits in length.

Allow call in only from this phone number for this connection

Checking this box will cause WIN-911 to refuse access to this user if he/she calls in on another line than the one listed in the Phone Number as identified by caller ID.

Schedule

View or select the schedule that WIN-911 will honor when sending alarm and report messages. A connection can have only one assigned schedule, but a schedule can contain multiple appointments. See [Schedules](#).

Roles (for use by Advanced Tactics)

View or assign roles to the selected connection by clicking the add button in edit mode. Each connection can have multiple roles. See [Roles](#).

Alarm Format

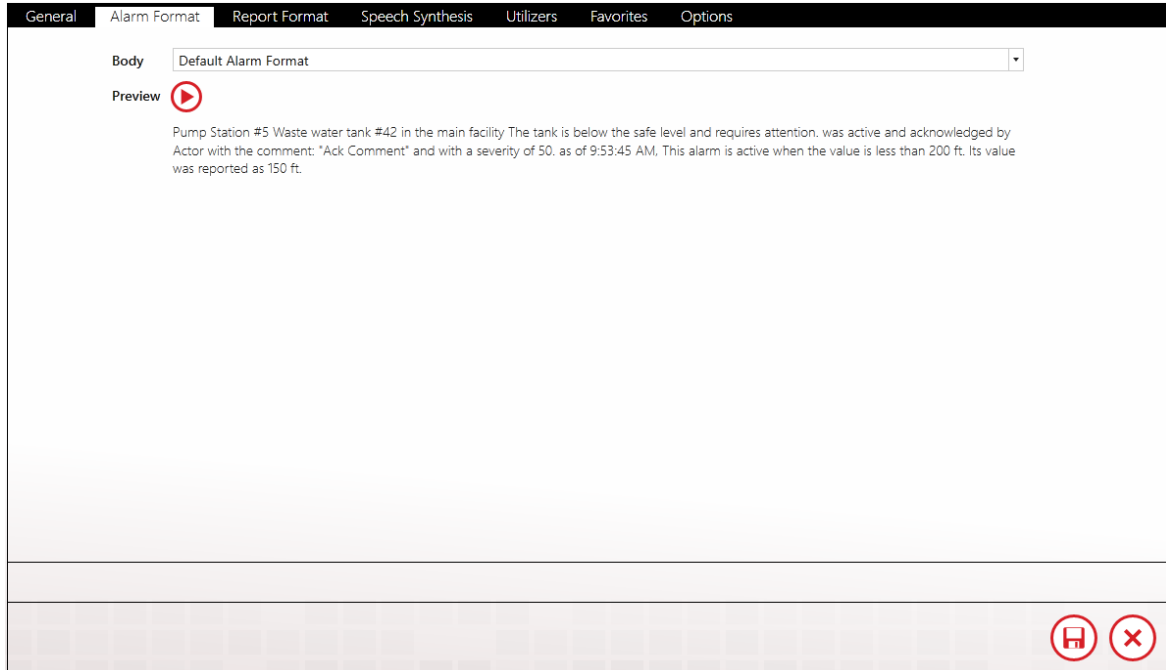

Body

The body of the voice notification consists of the information about the individual alarms. The body is played after the salutation, authorization code entry (Interactive only), and alarm enumeration segment, and before the ack code menu (interactive only). If the call is non-interactive, then the authorization code entry and ack code menu are omitted. Each alarm message is announced as per the alarm format and then the ack code menu is presented before moving on to the next alarm message. Once all alarm messages and ack/save/delete menus are processed the user is returned to the main menu. Parenthesis indicate optional fields.

Short Alarm Format

WIN-911 User Guide

Area, Item Description, Alarm Condition Description, Alarm State, Ack State, Actor, Event Time

Default Alarm Format

Area, Item Description, Alarm Condition Description, Alarm State, Ack State, Actor, (Ack Comment), (Severity), Event Time, Limit, (Value), (Units)

Long Alarm Format

Area, Item Description, Alarm Condition Description, Alarm State, Ack State, Actor, (Ack Comment), (Severity), Event Time, Limit, (Value), (Units), (Activation Time), (Label)

Preview

Click the play button to hear a sample of the alarm message format that the user will hear.

Report Format

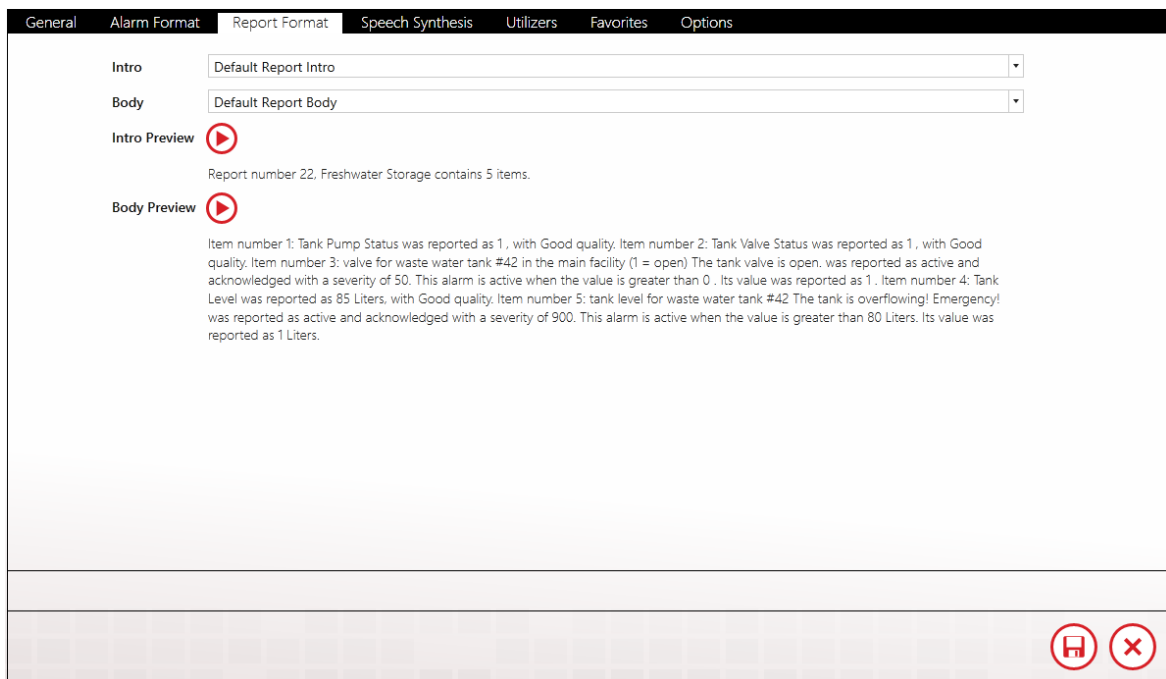

Intro

The introduction of the report identifies the particular report and enumerates the number of items it contains.

Short Report Intro

Report Description, Total Number of Items

Default Report Intro

Report Number, Report Description, Total Number of Items

Body

The body of the voice report consists of the information about the individual items. The body is played after the salutation, authorization code entry (Interactive only), and report menu. If the call is non-interactive, then the authorization code entry and ack code menu are omitted. Each item in the report is announced as dictated by the report format body. Once all items are processed the user is returned to the main menu.

Parenthesis indicate optional fields.

Short Report Body

Data Items:

Item Number, Item Description, Value, Quality

Alarm Items

Item Number, Area, Item Description, Alarm Condition Description, Alarm State, Ack State, Actor, Event Time, Limit, (Value), (Units)

Default Report Body

Data Items:

Item Number, Item Description, Value, Quality, (Labels)

Alarm Items

Item Number, Area, Item Description, Alarm Condition Description, Alarm State, Ack State, Actor, (Ack Comment), (Severity), Event Time, Limit, (Value), (Units), (Labels)

Intro and Body Preview

Click the play button to hear a sample of the report format that the user will hear.

Speech Synthesis

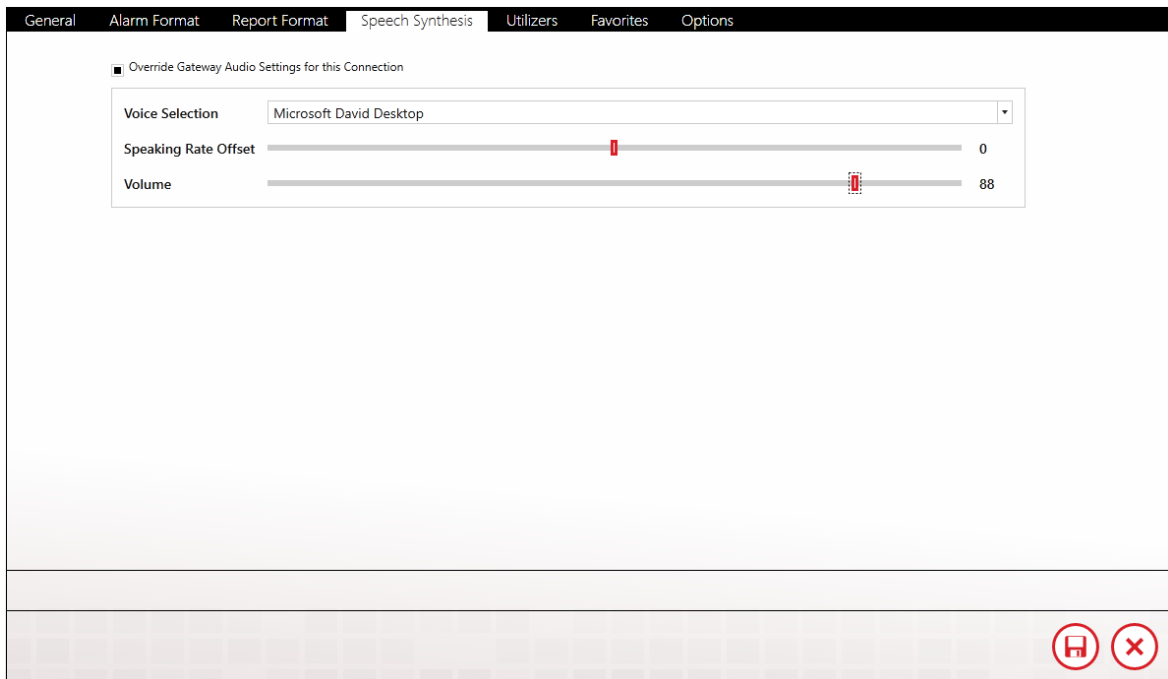

Override Gateway Audio Settings

Each voice connection has to option to substitute the global speech synthesis setting for the ones set on this page. If a particular user is

hearing-impaired then his/her connection can be set to use a higher volume than the rest of the users.

Voice

Select the Text to Speech voice that WIN-911 will use to conduct voice alarm notification. The voice must use SAPI 5 or higher speech engine.

Speaking Rate Offset

Modify the default rate of speech -10 to 10 with the slider bar to refine the speech rate for your application.

Volume

Modify the volume of speech -100 to 100 decibels with the slider bar to refine the volume for your application. This is a global setting that can be overridden in Connections>Speech Synthesis section for individual connection.

Utilizers



The Utilizers tab is a booking keeping device that lists all of the tactics associated with this contact. When utilizers are present WIN-911 prevents the contact from being deleted. If you wish to delete the contact, you will first have to modify the utilizing tactic in a manner that will unlink it to this contact. Once all utilizers are cleared, the contact can be safely deleted.

Favorites

General Alarm Format Report Format Speech Synthesis Utilizers Favorites Options

Favorite alarm requests can be configured here, which allow you to quickly request a set of alarms given an alarm state, severity threshold and a set of labels.

Alarm State: All active alarms

Severity: 128 and Above

Labels: Safety

1 ABC +

2 DEF +

3 GHI +

4 JKL +

5 +

Save Close

Favorite alarm requests can be configured here, which allow you to quickly request a set of alarms given an alarm state, severity threshold and a set of labels.

Each connection can be configured for as many as five favorites filters. Each of the selected alarm properties (Alarm State, Severity, and Labels) are combined together to define the filter in such a way that the alarm would have to fall within the range of all defined properties to be included in the request.

Options

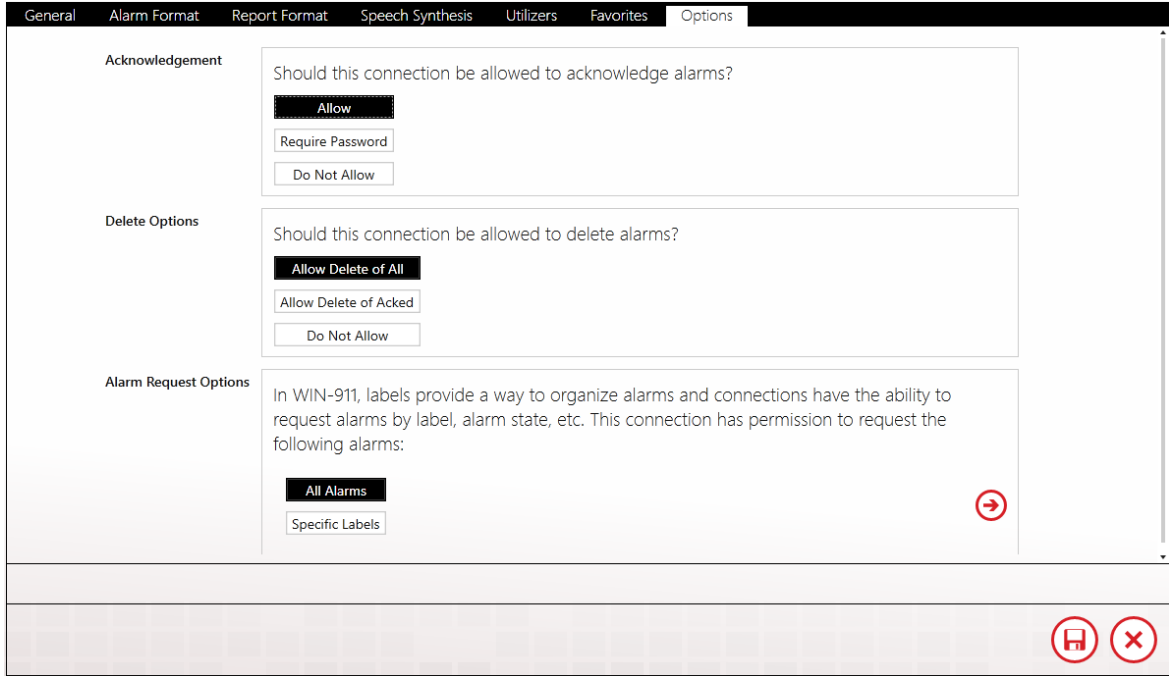

Acknowledgement

Should this connection be allowed to acknowledge alarms?

Allow

Allows the user to acknowledge the alarm by pressing the One key.

Require Password

Allows the user to acknowledge the alarm by entering the assigned connection ack code.

Do Not Allow

Default selection that does not offer the user the option to acknowledge the alarm.

Delete Options

Should this connection be allowed to delete alarms?

Allow Delete of All

Allows the user to delete all of his/her alarm messages by pressing the One button.

Allow Delete of Acked

Allows the user to delete all of his/her acknowledged alarm messages while retaining the those which have not been acked.

Do Not Allow

Default selection that does not offer the user the option to delete alarm messages.

Alarm Request Options

In WIN-911, labels provide a way to organize alarms and connections have the ability to request alarms by label, alarm state, etc. This connection has permission to request the following alarms:

All Alarms

Specific Labels

Voice Formats

Voice Formats use XSL to determine how alarms and reports are formatted in your Voice messages. WIN-911 allows users to create and customize their own formats for each notifier.

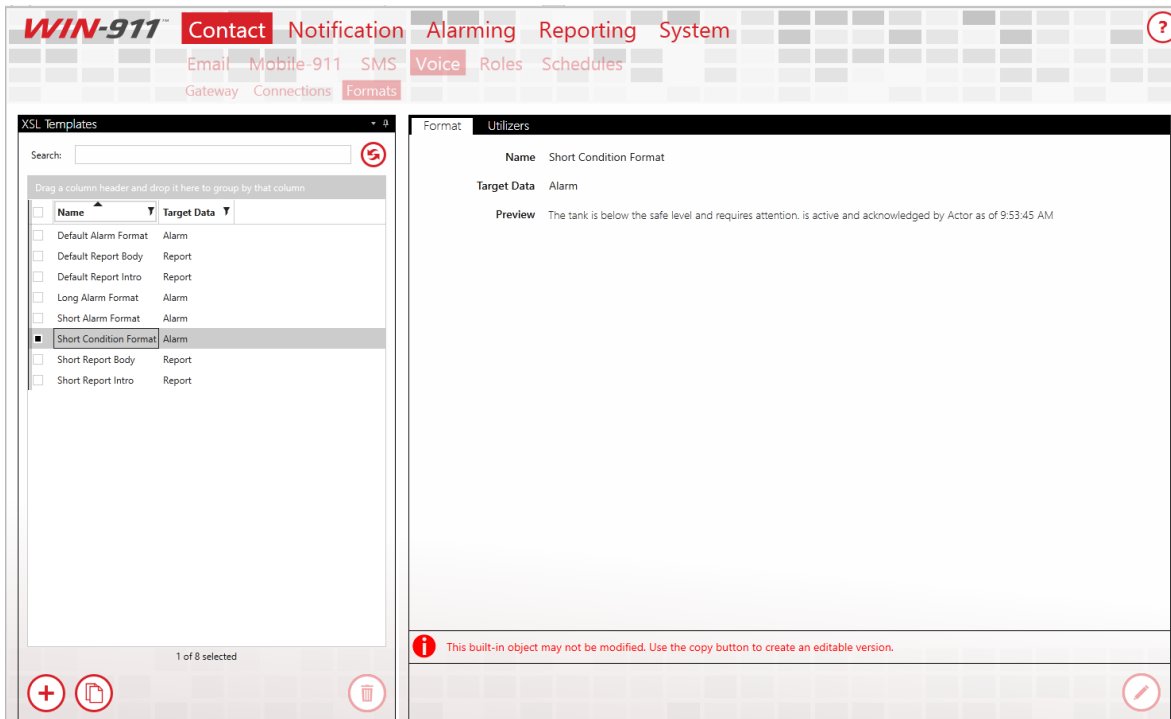

Format

WIN-911, when installed, will initially have eight Voice Formats. Four of them target alarms while the remaining four target reports. The alarm formats will fundamentally verbalize the alarm state and when the change in alarm state happened. These eight original Formats cannot be edited nor deleted:

- **Default Alarm Format:** an alarm Format that verbalizes the area, followed by the alarm description. Will also verbalize the acknowledgement comment if alarm is acked, the alarm's severity, and the condition for when the alarm is considered active. It concludes with the value of the item that triggered the alarm.
- **Long Alarm Format:** an alarm Format that verbalizes everything the Default Alarm Format does. It will conclude with the labels associated with the triggered alarm.
- **Short Alarm Format:** an alarm Format that starts by verbalizing the area, alarm details, then the condition description. It concludes with the alarm state and timestamp of the alarm.
- **Short Condition Format:** a short alarm Format that starts by verbalizing just the condition description of the triggered alarm, followed by the alarm state and timestamp.
- **Short Report Intro:** a report Format that verbalizes the name of the report.
- **Default Report Intro:** a report Format that verbalizes the report number, followed by the name of the report.
- **Short Report Body:** a report Format that verbalizes basic information from each item in the targeted report.
- **Default Report Body:** a report Format that verbalizes the report items in greater detail. Additional detail includes values that activate each alarm.

To create a new Voice Format from scratch, click on the '+' button located at the bottom left corner of the XSL Templates list. The following workspace will then appear:

The screenshot shows a configuration interface for creating a new Voice Format. At the top, there are two tabs: 'Format' and 'Utilizers'. Below the tabs, the interface is organized into four sections:

- Name:** A text input field with the placeholder text 'Enter a name for this format'.
- Target Data:** Two buttons labeled 'Alarm' and 'Report'.
- Message Part:** Two buttons labeled 'Body' and 'Subject'.
- XSLT:** A text input field with the placeholder text 'Enter your XSLT here. Copy an existing format as a starting point.'

* indicates required fields:

WIN-911 User Guide

- * **Name:** the name for this Format. Must be unique across all defined Voice Formats
- * **Target Data:** determines if this Format is for Alarms or Reports.
- * **Message Part:** determines if the Format has a message body or a Subject.
- * **XSLT:** the XSLT code that will generate the layout for this Format. Must be valid code.

Due to the granular nature of the code syntax, WIN-911 Software strongly recommends copying from one of the eight original Formats to get started. Select a Format from the XSL Template list, then click the Copy button at the bottom of the list right next to the '+' button. You can then tweak the existing XSLT code however you want to get your desired Format.

The screenshot shows a configuration window for a format. The 'Name' field is 'Short Report Body'. The 'Target Data' section has 'Report' selected. The 'Message Part' section has 'Body' selected. The 'XSLT' field contains the following code:

```
<?xml version="1.0" encoding="ISO-8859-1"?>
<xsl:stylesheet version="1.0" xmlns:xsl="http://www.w3.org/1999/XSL/Transform" xmlns:ms="urn:schemas-microsoft-com:xslt" xmlns:dt="urn:schemas-microsoft-com:datatypes" exclude-result-prefixes="ms dt">
  <xsl:output method="xml"/>
  <xsl:template match="Report">
    <p>
      <xsl:for-each select="Items/*">
        <xsl:text>Item number </xsl:text> <xsl:value-of select="Index"/>
        <xsl:choose>
          <xsl:when test="GenericResult/Succeeded = 'true'">
            <xsl:text>: </xsl:text>
            <xsl:if test="Type = 'Data'">
              <xsl:element name="s">
                <xsl:text>The value of </xsl:text>
                <xsl:value-of select="ItemInfo/Name"/>
                <xsl:text> was reported as </xsl:text>
                <xsl:value-of select="Vtq/Value"/>
                <xsl:text> </xsl:text>
                <xsl:value-of select="EngineeringUnits"/>
                <xsl:text>. </xsl:text>
              </xsl:element>
            </xsl:if>
          <xsl:if test="Type = 'Alarm'">
            <xsl:element name="s">
              <xsl:text>The alarm state of </xsl:text>
            <xsl:choose>
              <xsl:when test="ItemInfo/Description" or not(ItemInfo/Description)">
```

After saving a created Format, you can then select it under Voice Connections in the Format tabs. If it targets alarms, it'll show up in the Alarm Format tab combo box, Report Format tab combo box otherwise.

Notes:

- *All Voice Formats that target alarms must target the Body of the message. You will not be able to save Alarm Formats that try to target subjects.*
- *The validity of the XSLT will partially be determined by which 'Target Data' is selected, since 'Alarm' and 'Report' each comply with different XML prefixes.*

Utilizers

The utilizers tab shows which Voice connections make use of the chosen format.

Roles

Roles represent a label for organizing connections based on availability, location, or responsibility. Roles can be used in a notification tactic to notify all connections with something in common.

Note: Roles are utilized by advanced tactics only.

Roles Collection Selector List

On the left side of the role's workspace is a master list of all defined roles. Each role object contains two properties, the Name and Description, that are displayed in columnar format. These properties can be used to sort and filter roles using tools provided within the form.

Role Workspace Editor

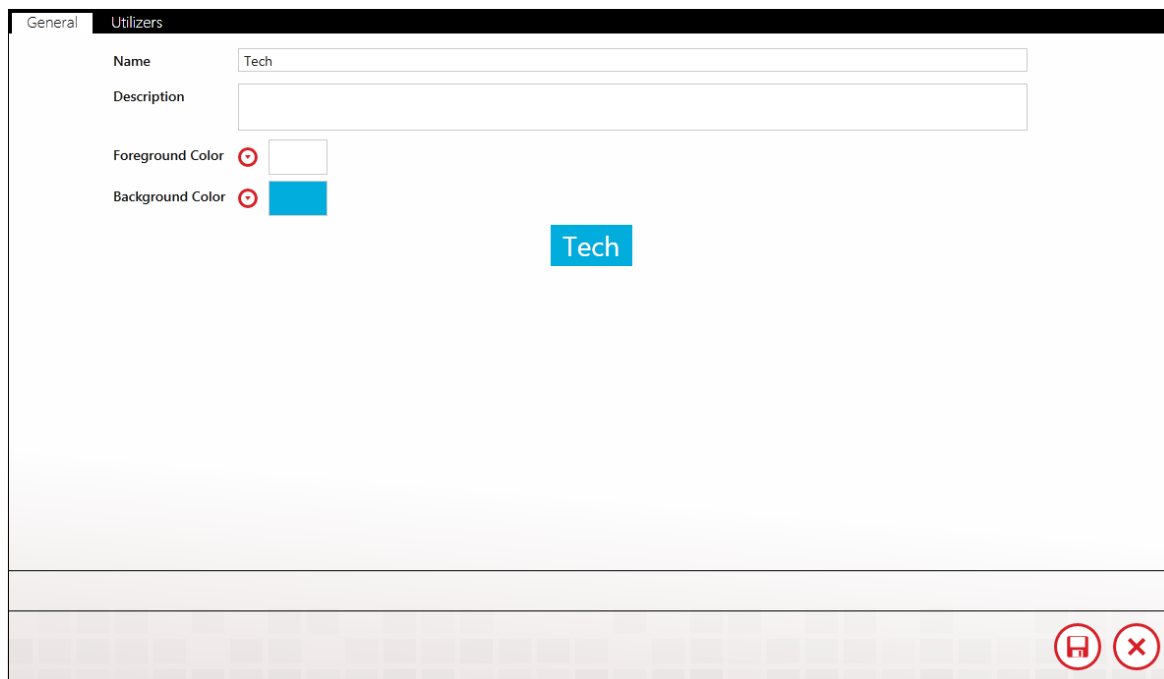

The screenshot shows the 'Role Workspace Editor' window. The 'General' tab is selected, displaying the following fields:

- Name: Tech
- Description: (empty)
- Foreground Color: (white swatch)
- Background Color: (blue swatch)

Below the form, a preview of a blue button with the text 'Tech' is visible. At the bottom right of the workspace, there are two red circular icons: a save icon and a cancel icon.

Clicking one of the edit buttons below the roles list or selecting one of the individual roles will bring up the Role Workspace Editor to the right of the list. This environment allows the WIN-911 Administrator to create roles to meet the exact needs of his/her specifications.

Edit/View Mode

The roles workspace (like any WIN-911 workspace) can be toggled between view mode (which allows the WIN-911 Administrator to view the details of the role) and edit mode (which allows the properties of the role to be changed). In view mode the edit icons appear at the bottom right of the workspace. In edit mode the edit icons are replaced with the save and cancel icons.

Note: The Roles page can be navigated away from while the workspace is in edit mode. No changes will be saved/applied until the Administrator navigates back to the Roles page and clicks the save icon. All changes made prior to the navigation will remain available for saving until the browser session is closed.

Name

Each Role must have a unique name that identifies the particular Role.

Description

An extra text field for organization and administration purposes, similar to a code comment.

Colors

Each role will You have a color pattern to help visually organize the connections. The WIN-911 Administrator can select a background and foreground (text) color for each role. The color picker for the foreground and background colors are invoked by clicking the associated red icon next to the left of the color to be edited. He/She can preview the current selections with the "what-you-see-is-what-get" presentation of the role provided below the color editing tools.

Utilizers

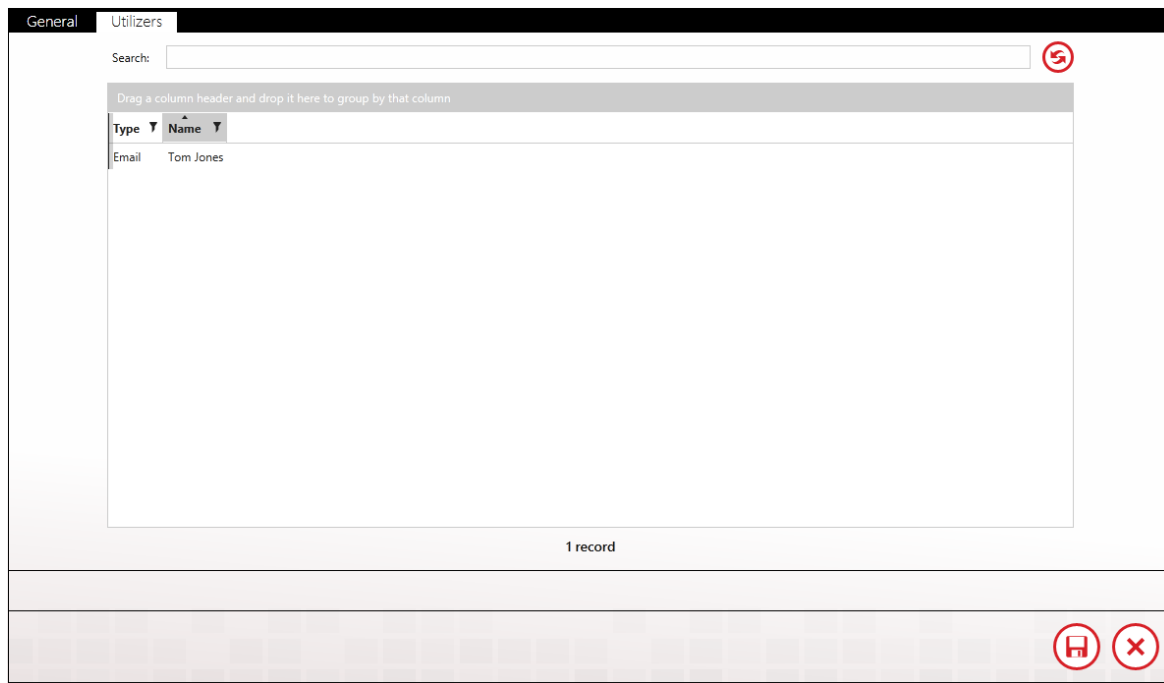

The screenshot displays the 'Utilizers' tab within a software application. At the top, there is a search bar with a red 'S' icon. Below the search bar is a table with the following structure:

Type	Name
Email	Tom Jones

Below the table, it indicates '1 record'. At the bottom right of the interface, there are two red icons: a square with a horizontal line and a circle with an 'X'.

The Utilizers tab is a booking keeping device that lists all of the contacts associated with this role. When utilizers are present WIN-911 prevents the role from being deleted. If you wish to delete the role you will first have to modify the utilizing contacts in a manner that will unlink it from this role. Once all utilizers are cleared, the role can be safely deleted.

Schedules

Schedules define the availability of connections and can be used in a notification tactic to control notifications. They can occupy a single space in time, like an appointment, or be comprised of a pattern of appointments which can recur based on days, weeks, months and even support floating holidays.

WIN-911 provides a suite of predefined common schedules. The default schedule is "Always". These schedules are hard coded and not modifiable. Should these not meet your needs. If the specifications of a particular tactic require a different schedule than the ones provided, the WIN-911 administrator can create a custom schedule.

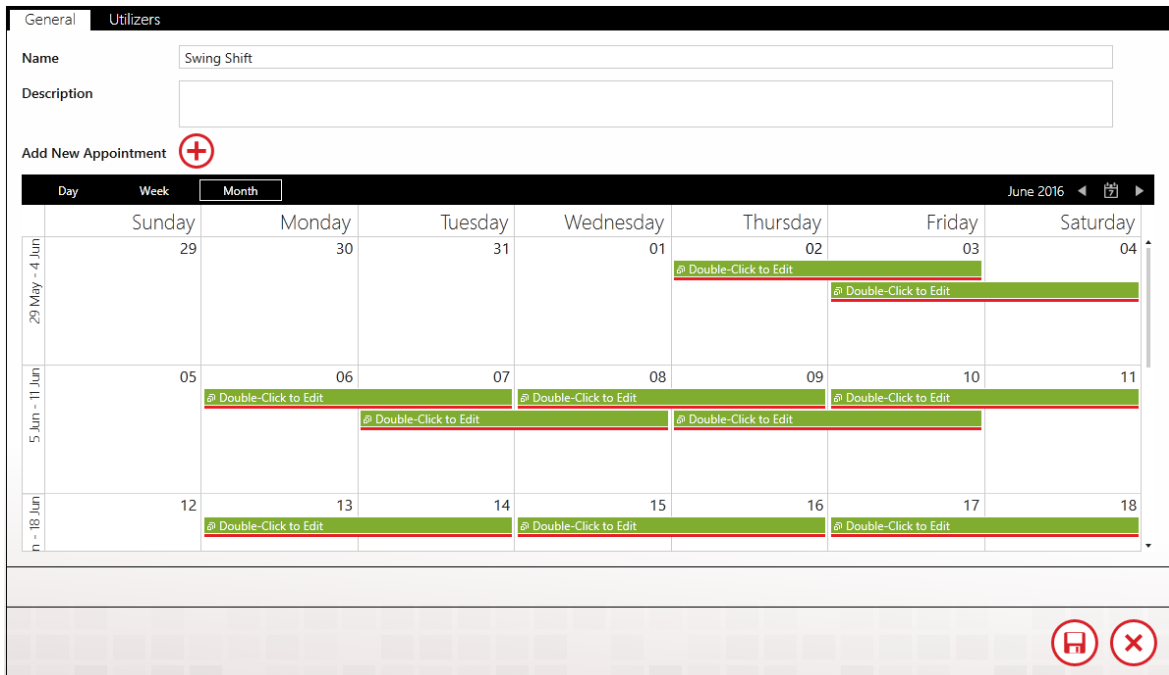

Name

Each schedule must have a unique name that identifies the particular schedule.

Description

An extra text field for organization and administration purposes, similar to a code comment.

Calendar/Agenda

Beneath the description text box is a color-coded calendar display with three view formats: Day, Week, and Month. The default view is month, which is highlighted on the left side of the black view selector bar across the top of the calendar. The view can be toggled by clicking the desired view name. On the right side of the view selector bar is the currently selected date and time and navigation arrows for advancing the view up or down the date and time selection. In this view, the user can navigate to a particular point in time and examine the schedule definition.

Appointments

Each schedule can be comprised of any number of appointments to meet the user's exact needs. Each appointment can have its own subject, description, start and end times, recurrence pattern, category and priority.

Once in edit mode you can add a new appointment by highlighting the date and clicking the "Add New Appointment" icon, followed by "Double-click to Edit". If the appointment is part of a series, the appointment editor asks if you wish to modify this single instance or carry the modification throughout the series.

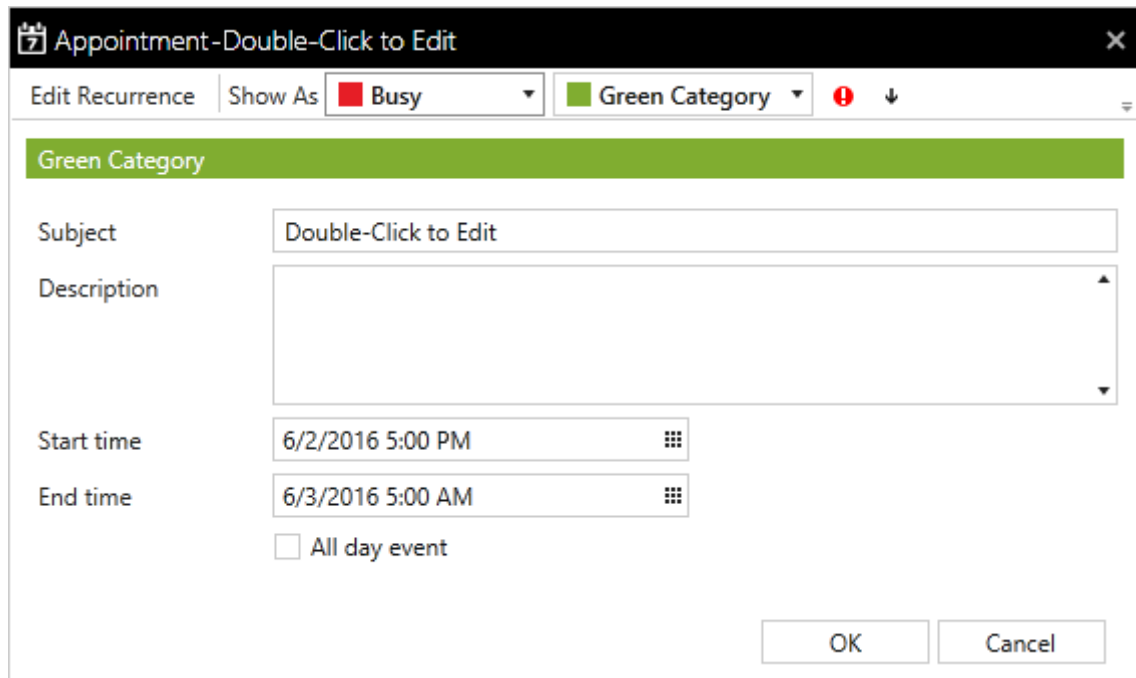

Subject

Each appointment may have a subject/title that identifies the particular appointment. This subject need not be unique.

Start/End time

Input fields to select the beginning and end of a block of time the appointment occupies. The time and date can be entered manually following the provided format by clicking the calendar icon in the right corner of the entry field to bring up a time and date selection dialog box. The dialog only provides start and end times that begin on the hour or half-hour. If you need a finer resolution you will have to enter it manually.

June - 2016							
	Sun	Mon	Tue	Wed	Thu	Fri	Sat
23	29	30	31	1	2	3	4
24	5	6	7	8	9	10	11
25	12	13	14	15	16	17	18
26	19	20	21	22	23	24	25
27	26	27	28	29	30	1	2
28	3	4	5	6	7	8	9

12:00 AM	1:00 AM	2:00 AM	3:00 AM
4:00 AM	5:00 AM	6:00 AM	7:00 AM
8:00 AM	9:00 AM	10:00 AM	11:00 AM
12:00 PM	1:00 PM	2:00 PM	3:00 PM
4:00 PM	5:00 PM	6:00 PM	7:00 PM
8:00 PM	9:00 PM	10:00 PM	11:00 PM

Close

All day event

Check this box to select the entire 24-hour period of the selected day.

Edit Recurrence

If the selected appointment is to be a repeating series or part of a pattern click the edit recurrence button to bring up the recurrence dialogic box. From this window you can edit the appointment time, establish a recurrence pattern designate the span of time the pattern is to be honored.

Appointment-Double-Click to Edit

Appointment time

Start 5:00 PM

End 5:00 AM

Duration 0.5 days

Recurrence pattern

Daily

Weekly

Monthly

Yearly

Recur every 1 week(s) on:

Sunday Monday Tuesday Wednesday

Thursday Friday Saturday

Range of recurrence

No end date

End after 10 occurrences

End by 6/12/2016

Start 6/2/2016

OK Cancel

Categorize

Color-coded attributes that help the administrator visually organize schedules.

Green Category

Clear

- Red Category
- Green Category
- Blue Category
- Purple Category
- Yellow Category
- Olive Category
- Pink Category

Priority

Priority is an optional attribute that designates the appointment as high (red exclamation point) or low (down arrow). Higher priorities take precedence over lower priority appointments.

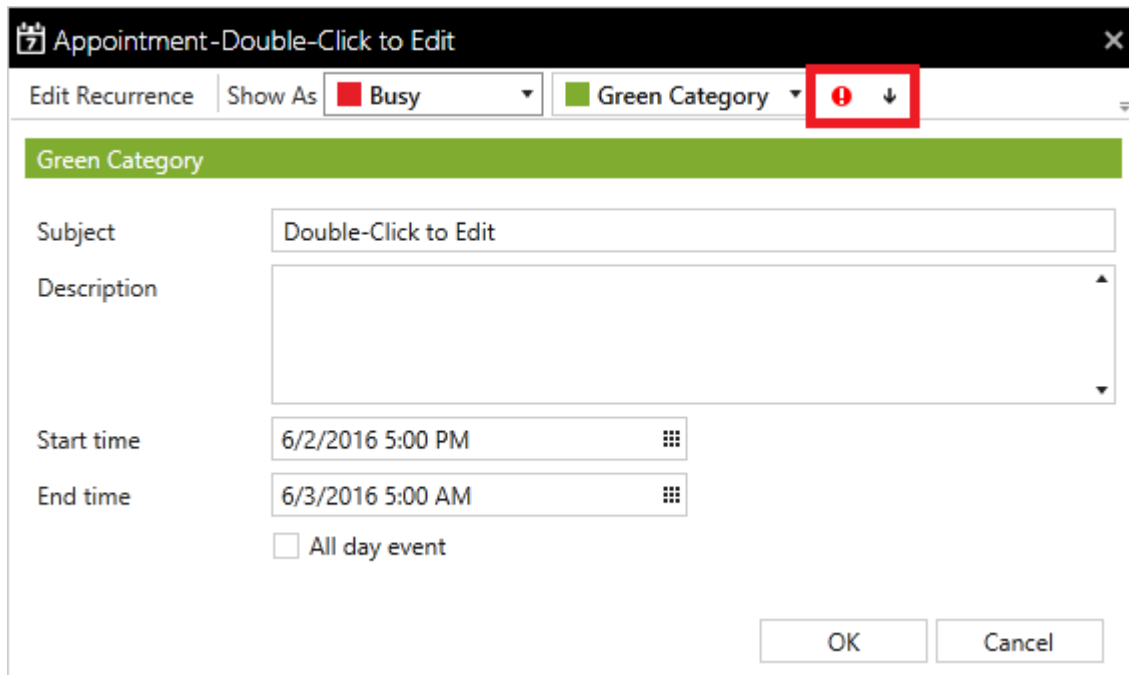

The screenshot shows a dialog box titled "Appointment-Double-Click to Edit". At the top, there are two dropdown menus: "Show As" set to "Busy" (with a red square icon) and "Green Category" (with a green square icon). To the right of the "Green Category" dropdown is a priority dropdown menu, which is highlighted with a red box. This menu contains a red exclamation point icon and a downward arrow icon. Below the dropdowns, the dialog has a green header bar labeled "Green Category". The main area contains fields for "Subject" (containing "Double-Click to Edit"), "Description" (a large empty text area), "Start time" (6/2/2016 5:00 PM), and "End time" (6/3/2016 5:00 AM). There is also an "All day event" checkbox which is unchecked. At the bottom right, there are "OK" and "Cancel" buttons.

Notification

Define how alarm notification should take place. Create and manage schedules and design custom notification strategies.

[Design Basic Tactics](#)

Basic Tactics makes it easy to define a list of connections for notification.

[Design Advanced Tactics](#)

The Advanced Tactics Workspace provides the WIN-911 administrator an easy to use, intuitive development environment that allows him/her to create anything from simple, single-step notification routines to complex logical flowcharts capable of circumstantial decisions and user interaction.

[Manage Strategies](#)

The Strategies Workspace provides the administrator with an easy to use, intuitive form for developing policies that invoke and regulate the tactics developed in the previous workspace based on alarm events and user input.

Basic Tactics

Overview

Basic Tactics are simple callout lists which deliver alarm notifications to the Connections listed within them. When a Basic Tactic is started, the list of connections is processed in the order they appear. Notifications are sent only to connections which are on duty at the time the notification attempt is made. Also, notifications are processed synchronously, that is, WIN-911 waits for each notification attempt to be completed before it continues on to its next action. In the event of a failure to send a notification to a connection, additional attempts may be configured. Delays may be placed between attempts to notify a connection and between different connections.

The screenshot displays the 'Basic Tactics' configuration interface within a web browser. The browser address bar shows the URL: `http://desktop-rbtp4dh/WIN911/#/Notification/Tactics/Basic`. The application header includes the 'WIN-911' logo and navigation tabs: 'Contact', 'Notification', 'Alarming', 'Reporting', and 'System'. Below the header, there are sub-tabs for 'Tactics' and 'Strategies', with 'Basic' and 'Advanced' options under 'Tactics'.

The main configuration area is titled 'Basic Tactics' and includes the following fields and controls:

- Name:** Alert Operators
- Description:** (Empty text field)
- Delay Before Notification:** Minutes: 2, Seconds: 0
- Repeats:** 5
- Callout List:** A table listing connections with their respective notification settings.

Connection	Type	Retries	Delay Between Retries	Delay After
<input type="checkbox"/> Sally Sullivan		3	Minutes: 0, Seconds: 15	Minutes: 0, Seconds: 0
<input type="checkbox"/> Tom Jones		3	Minutes: 0, Seconds: 15	Minutes: 0, Seconds: 0
<input type="checkbox"/> Wayne Smith		3	Minutes: 0, Seconds: 15	Minutes: 0, Seconds: 0
<input type="checkbox"/> Jenny Karnes		3	Minutes: 0, Seconds: 15	Minutes: 0, Seconds: 0

At the bottom of the configuration area, there are several control icons: a plus sign (+), a document icon, two arrows (up and down), and a trash can icon. At the very bottom right, there are save and close buttons represented by a floppy disk icon and an 'X' icon.

Name

Each Tactic, both Basic and Advanced, must have a unique name.

Description

An optional text field which provides additional context for the Tactic.

Delay Before Notification

The amount of time that should elapse before the list is processed. Use this to build in a delay for nuisance alarms. If the Tactic is stopped before the time period defined in this field has elapsed, no notification will occur.

Repeats

The number of times the callout list will be repeated, until it is stopped by a Strategy Policy. Set this to zero, if you wish the list to be processed once. The maximum number of Repeats is 99.

Callout List

This is the list of connections that will be notified and their order. Connections may be listed multiple times, scheduled for retries and spaced out using delays. Use the plus icon to add new connections to your list. The arrows will reorder connections within your list. The trash can icon will remove entries from your list. Use the copy icon to duplicate an entry.

Connection	The name of the connection to be notified.
Type	This icon indicates the type of the connection to be notified.
Retries	The number of additional attempts that should be made to notify the connection, should failures occur.
Delay Between Retries	The amount of time to wait between attempts to notify the connection.
Delay After	The amount of time to wait after the connection has been notified before moving on to the next entry in the list.

Utilizers

Tactics are referenced by Strategies. Tactics which are in use by a Strategy may not be deleted. Use the Utilizers tab to determine where a Tactic is used.

Advanced Tactics

Overview

An Advanced Tactic is a workflow, which may be started by a Strategy. Use these flowcharts to send alarm messages, reports, and acknowledge alarms. A tactic is constructed by dragging and dropping in various blocks into the chart. The following image depicts a tactic, which will send alarm messages to Connections tagged with the "Operators" Role, and, if the alarm has a Severity greater than 900, it will also send a message to Connections tagged with the "Managers" Role.

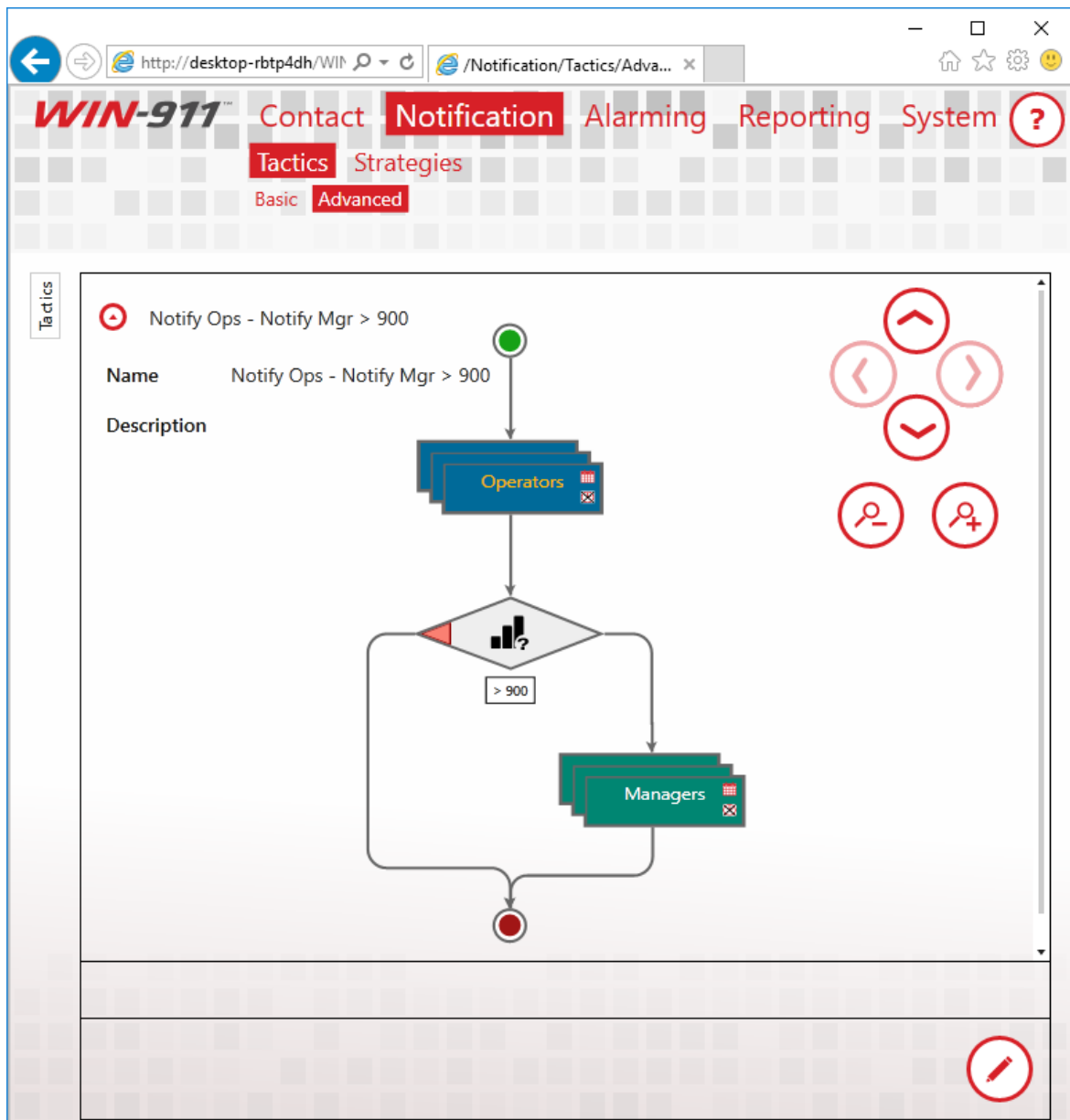

Blocks

There are a variety of blocks available to construct a tactic; each instructs WIN-911 to undertake a different action. Most of the blocks you will use are Notification Blocks, which allow you to send alarm or report messages to connections. There are also Decision Blocks, which enable your Tactic to branch based on the properties of the alarm that triggered the Tactic.

Notification Block



Sends the current alarm to the specified Connection.

Notify All Block



Sends the current alarm to all Connections tagged with the specified Role. If you do not specify a Role, the alarm is sent to Connection within the system.

Report Block

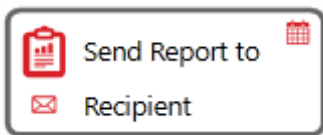

Sends a Report to the specified Connection.

Report All Block



Sends a Report to all Connections tagged with the specified Role. If you do not specify a Role, the Report is sent to every Connection within the system.

Sub-Tactic

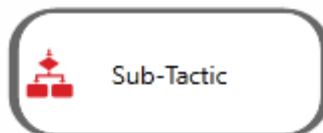

Starts another Tactic. Nesting Tactics recursively is not supported.

Ack-Decision



Branches the Tactic flow based on the acknowledgement state of the current alarm. If the alarm is acknowledged, the right path is taken. If the alarm is unacknowledged, the left path is taken.

Active-Decision



Branches the Tactic flow based on the active state of the current alarm. If the alarm is active, the right path is taken. If the alarm is inactive, the left path is taken.

Schedule Decision

Branches the Tactic flow based on whether or not the specified schedule has an appointment at the time of the evaluation. If the specified schedule has an appointment that coincides with the alarm, the right path is taken. If the Schedule does not, the left path is taken.



Label-Decision

Branches the Tactic flow based on the Labels attached to the current alarm. If the specified Label is attached to the alarm, the right path is taken. If the Label is not attached, the left path is taken.



Severity-Decision

Branches the Tactic flow based on the severity attached to the current alarm. If the severity of the alarm is greater than the value specified, the right path is taken. If the severity is less than or equal to the value specified, the left path is taken.



Timespan-Decision

Branches the Tactic Flow based on the amount of time that has passed since a specified event occurred and the time that the block is executed. The options for the initial event time are: the initial alarm time, the last time the alarm changed state, or the time at which the Tactic was started.



Delay Block

Delays Tactic execution for a specified period.



Ack Block

Acknowledges the current alarm when the block is executed. You may provide an acknowledgement comment. If your Data Source supports it, the comment will be passed along with the acknowledgement.



Loop Block

Loops the blocks placed within the loop for the number of times specified. The maximum is ninety-nine. It's a good idea to pair a Loop Block with a Decision Block so that a specific action can be repeated until some condition exists.



Notification Blocks

Synchronous vs. Asynchronous Notification

Notification Blocks can be configured to execute asynchronously or synchronously. When a block is asynchronous, the alarm message will be dispatched, and the next block will be executed immediately. When a block is configured synchronously, the message is dispatched, and the dispatcher waits to hear a response from the notifier which handles the message. If notification fails, another attempt, if configured, may be made. Delays may be placed between notification attempts as well as between connections. Check the "Wait for Notification to Complete" check box on the Notification Block to make it synchronous.

Schedules

Schedules determine when a Connection is available to receive alarms. This is a property of the Connection and is not specified within the Tactic. You may, however, ignore a Connection's schedule, by checking the "Ignore Schedules" check box on a Notification Block. If the option is enabled, the notification will always be sent. Use this option for extremely important messages.

Strategies

Overview

Strategies define the set of actions to undertake when an alarm event is received. The condition that triggers the action and the action itself are referred to as a Strategy Policy. Alarms pass events into Strategies and the Strategy Policy list determines how WIN-911 will handle your system's alarm.

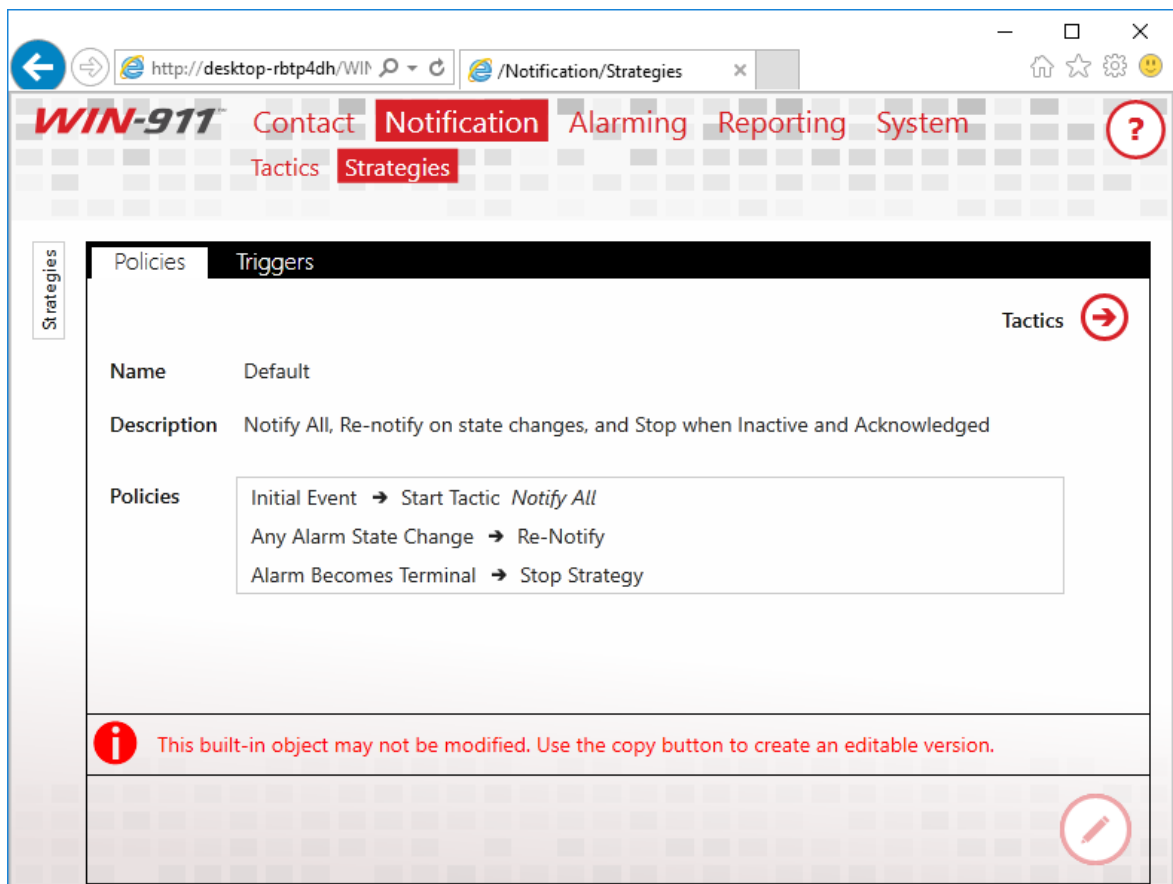

The Default Strategy, pictured above, has three policies. The first specifies that when the initial alarm event is received, a Tactic should be started called "Notify All." This Tactic is configured to notify

WIN-911 User Guide

everyone in your WIN-911 system. The second policy specifies that when any update regarding the alarm is received, WIN-911 should send an updated notification to everyone who has previously received a message for the alarm. The final policy states that when the alarm becomes terminal, that is, when it is inactive and unacknowledged, the Strategy should stop executing.

To reiterate, alarms send events to Strategies, and, if the event matches a specified condition, action is taken by WIN-911. This action is, generally, to start or stop a Tactic. Tactics specify the details regarding the actual notification.

Name

Use this field to provide a unique and informative name for your Strategy. This name will be displayed in your logs and is also displayed in the list of Strategies.

Description

Use this field to provide additional context for your Strategy.

Basic Strategies and Advanced Strategies

The screenshot displays the WIN-911 software interface for configuring a strategy. The main navigation bar includes 'Contact', 'Notification', 'Alarming', 'Reporting', and 'System' tabs, with 'Strategies' selected. The 'Strategies' configuration window is open, showing the following fields and options:

- Name:** A text input field with a red border and a red error message: "The Name field is required."
- Description:** A text input field.
- Start Tactic:** A dropdown menu set to "Notify All".
- Stop Condition:** A dropdown menu set to "Alarm Becomes Terminal".
- Advanced Mode:** A button to toggle between basic and advanced configuration.
- Policies:** A list of rules:
 - Initial Event → Start Tactic *Notify All*
 - Any Alarm State Change → Re-Notify
 - Alarm Becomes Terminal → Stop Strategy
- Checkboxes:**
 - Suppress Voice Notifications on Re-Notify for Inactive Events
 - Suppress Voice Notifications on Re-Notify for Acknowledged Events
 - Automatically acknowledge on return to normal
 - Renotify on any state change

The interface also features a 'Tactics' dropdown menu, a 'Policies' section, and a footer with a license expiration notice: "The Dispatcher Module's evaluation license will expire in 29 days. Please contact WIN-911 Software to obtain a permanent licence : sales@win911.com | 512-326-1011 or toll free 800-331-8740 | http://www.win911.com/".

All new Strategies begin as Basic Strategies. This is done to aid new users as they learn how Strategies function. A Basic Strategy has three policies, only two of which are configurable. The initial event must always start a Tactic, which you must select. Any alarm state change must always notify previously notified connections. Lastly, the Stop Condition is selectable. If a Basic Strategy does not meet your needs, simply click the Advanced Mode button and the full range of configuration will be unlocked. Once you press the Advanced Mode button, you cannot revert the Strategy to Basic Mode.

Policy Conditions

Policy Conditions are used to determine when WIN-911 should take action regarding your alarm. When an event regarding your alarm is received that matches one of the Conditions you've specified some action may be taken. The list of available Conditions can be found in the table below.

Note: An Alarm Lifetime ID is a unique identifier that is assigned to each individual alarm which remains with it throughout its lifecycle. It is an internal representation and is not normally visible to the user (although it can be viewed using the WIN-911 Log Viewer). The lifecycle of the alarm varies with the source that owns it. Some sources treat alarms by grouping all the varying states into the same lifecycle. For example, a Hi alarm that transitions to a HiHi alarm is considered the same alarm but with a different property. Other sources will treat the new HiHi alarm as a brand new (and independent) alarm, with its own Alarm lifecycle. In this lifecycle treatment, each alarm state must be individually acknowledge (Hi and HiHi). In the former lifecycle treatment a single acknowledgement will apply to all variations of the alarm.

Initial Event	Initial Event is defined as, a new <i>Any Alarm State Change</i> event which contains a new Alarm Lifetime ID. For a definition of a State Change event see " <i>Any Alarm State Change</i> " below.
Any Alarm State Change	State Change is defined as, a change to <i>Active, Inactive, Acknowledged, Unacknowledged</i> or a change in <i>Condition</i> . For a definition of a change in Condition see " <i>Any Condition Change</i> " below.
Alarm Becomes Active	A transition to an <i>Active state regardless of acknowledgement</i> . Includes <i>Active Acknowledged</i> and <i>Active Unacknowledged</i> events.
Alarm Becomes Inactive	A transition to an <i>Inactive state regardless of acknowledgement</i> . Includes <i>Inactive Acknowledged</i> and <i>Inactive Unacknowledged</i> events.
Alarm Becomes	A transition to <i>Acknowledged</i> regardless of <i>Active</i>

Acknowledged	state. Includes <i>Active Acknowledged</i> and <i>Inactive Acknowledged</i> events.
Alarm Becomes Unacknowledged	A transition to <i>Unacknowledged</i> regardless of <i>Active</i> state. Includes <i>Active Unacknowledged</i> and <i>Inactive Unacknowledged</i> events.
Alarm Becomes Suppressed	A transition from <i>Unsuppressed</i> to <i>Suppressed</i> .
Alarm Becomes Unsuppressed	A transition from <i>Suppressed</i> to <i>Unsuppressed</i> .
Any Condition Change	<i>Condition</i> changes are only supported with GE iFIX and GE CIMPLICITY. A <i>Condition Change</i> must retain the same Alarm Lifetime ID. <i>Condition Changes</i> can represent a change from HI to HIHI or LO to LOLO. A <i>Condition Change</i> from HI to HIHI will replace the HI alarm with HIHI, instead of creating a new Alarm Lifetime ID for the HIHI alarm.
Event Quality Changes	<i>Event Quality Changes</i> are defined as a change in quality, as reported by the data source. Quality updates are either GOOD, BAD, or UNCERTAIN. GE CIMPLICITY is the only source that does not support <i>Event Quality Changes</i> .
Upon Timer	A timer will start when the Strategy instance begins its execution, even if no policy conditions are satisfied. After the time specified has elapsed, the action will be triggered. This timer will execute only once. The timer is canceled when the Strategy instance is stopped.
Upon Repeating Timer	A timer will start when the Strategy instance begins its execution, even if no policy conditions are satisfied. After the time specified has elapsed, the action will be triggered. The timer will then restart. This timer will execute indefinitely until the Strategy instance is stopped.
Alarm Becomes Terminal	<i>Terminal</i> is defined as an <i>Inactive Acknowledged</i> event.

Policy Condition Notes

- If a single event matches both the *Initial Event* condition and *Any Alarm State Change* condition, only the *Initial Event* policy will execute.

Example:

Event: Active Unacknowledged Alarm with a new Alarm Lifetime ID (Initial Event)

In this case, both conditions are met, but only the *Initial Event -> Start Tactic* will execute. *Re-notify* will be ignored.

Policies	Condition	→	Action
✓	Initial Event	→	Start Tactic
✗	Any Alarm State Change	→	Re-Notify

Additional UI elements: "Notify All" button and a red circle containing three dots (⋮).

- If a single event matches both the *Initial Event* condition and any policy condition with an action to *Stop Strategy*, only the policy with an action to *Stop Strategy* will execute.

Example:

Event: Active Acknowledged Alarm with a new Alarm Lifetime ID (Initial Event)

In this case, both conditions are met, but only the *Alarm Becomes Acknowledged -> Stop Strategy* will execute. *Restart Active Tactic* will be ignored.

Policies	Condition	→	Action
✗	Initial Event	→	Restart Active Tactic
✓	Alarm Becomes Acknowledged	→	Stop Strategy

Additional UI elements: "Notify All" button and a red circle containing three dots (⋮).

- If a single event matches both the *non-Initial Event* condition and any policy condition with an action to *Stop Strategy*, only the policy with an action to *Stop Strategy* will execute, except for *Re-Notify* and *Ack* (which can execute concurrently).

Example:

Event: InActive Acknowledge Alarm with existing Alarm Lifetime ID (Any State Change)

In this case, three conditions are met. The *Any Alarm State Change -> Reotify & Alarm Becomes Acknowledged -> Stop Strategy* will execute concurrently. *Stop Tactic* will be ignored.

Policies	Condition	→	Action
✓	Any Alarm State Change	→	Re-Notify
✗	Alarm Becomes Inactive	→	Stop Tactic Notify All ⋮
✓	Alarm Becomes Acknowledged	→	Stop Strategy

Policy Actions

The actions which may be taken after a matching event is received are listed below.

Start Tactic	If an instance of the specified Tactic is not currently executing for this Strategy Instance, start one. If the specified Tactic is already executing for this Strategy instance, allow the original one to continue. <i>Start Tactic</i> action will not restart an already executing Tactic.
Restart Active Tactic	<p>If an instance of the specified Tactic is not currently executing for this Strategy instance, start one. If the specified Tactic is already executing for this Strategy, restart the Tactic.</p> <ul style="list-style-type: none"> Restarting Advanced Tactics - Finish execution of the current block, then move back to the Tactic's Start block. If the current block is a Notify All block, all connections within that group will be notified before restarting the Tactic. If the current block is a Timer block, the Timer will need to expire before restarting the Tactic. Restart Basic Tactics - Finish execution of the current notification, stop the Tactic, then move back to the beginning of the callout list.
Re-Notify	Perform notification(s) of the current alarm event to all connections for which some Tactic of this Strategy instance has attempted notification (even if unsuccessful).
Stop Tactic	<p>Instruct the specified Tactic to stop.</p> <ul style="list-style-type: none"> Stopping Advanced Tactics - The stop will occur after finishing the execution of a notification block. If the current block is a Notify All block, all connections within that group will be notified before stopping the Tactic. Timer blocks are stopped immediately.

	<ul style="list-style-type: none"> Stopping Basic Tactics - The stop will occur after the current notification attempt and before any retries or delays.
Stop All Tactics	Instructs all Tactics, executing for this Strategy instance, to stop. See " <i>Stop Tactic</i> " above for details about stopping Advanced and Basic Tactics.
Stop Strategy	Stop all Tactics and all Timers. Stop evaluating Policies. A <i>Stop Strategy</i> action must be defined for a Strategy.
Ack	Acknowledge the current alarm event. Ack can be used for auto acknowledging a defined event condition such as <i>Alarm Becomes Inactive</i> .

Policy Action Notes:

- All satisfied Policy Conditions are executed in order of their Policy Actions. Multiple satisfied Policy Conditions with the same Policy Action are executed in arbitrary order.

Policy Action Order:

Stop Tactic > Stop All Tactics > Re-Notify > Ack > Start Tactic > Restart Active Tactic > Stop Strategy

Example:

Event: Active Unacknowledged alarm (both new and existing Alarm Lifetime IDs will behave the same)

In this case, the *Stop Tactic* action will be performed first, before the *Start Tactic* action. If the specified Tactic is not running, the *Stop Tactic* will not perform an action and the *Start Tactic* will execute.

Policies	Condition	→	Action	
2nd	Alarm Becomes Active	→	Start Tactic	Notify All 
1st	Alarm Becomes Active	→	Stop Tactic	Notify All 

Triggers

The list of alarms and filters which are associated with the Strategy are displayed on this tab. Strategies which are in use may not be deleted.

Use this tab to track down where a Strategy is referenced, so that you may delete it.

Alarming

Create, manage, and organize the alarms monitored by WIN-911.

OPC DA Settings

Setup your OPC DA Sources by defining connection settings and alarm conditions.

FactoryTalk A&E Settings

Setup your FactoryTalk Alarm and Event Sources by defining connection settings and alarm subscriptions.

CIMPLICITY Settings

Setup a direct connect with your CIMPLICITY Projects.

iFIX Settings

Setup your iFIX Source by defining Connection Settings and Alarm Conditions.

InTouch Settings

Setup remote and local connections to InTouch applications for alarm and data monitoring.

InTouch Edge HMI Settings

Setup a local connection to a InTouch Edge HMI Project alarm and data monitoring.

System Platform Settings

Setup a local connection to a single System Platform Galaxy for alarm monitoring.

[Organize with Labels](#)

Labels represent a label for organizing alarms based on location, device, functions, severity, or other logical grouping. Labels can be used in a notification tactic to control notification.

OPC DA Overview

The OPC DA data connection allows WIN-911 to connect to a wide variety of HMI/SCADA systems by using a generic data exchange medium, OPC DA server. WIN-911 serves as a generic OPC DA client. WIN-911 only supports Data Access (DA) servers not Alarm and Event (A&E) servers. WIN-911 is capable of browsing tags in an OPC DA server and importing them into the WIN-911 configuration, where tag browsing is available.

If at any time WIN-911 loses connection to the OPC server, WIN-911 will attempt to re-establish its connection and continue to do so until the server is back online, and the data is restored.

The OPC DA server passes raw values, or "Items", to WIN-911 on a pass-by-exception basis. Alarm events are derived from set-points (e.g. "On", "Off", "50 >", "4 <", etc.) that you enter and which WIN-911 will compare to the Items. When an Item meets or exceeds the set-point an alarm event is triggered by WIN-911.

The OPC DA connection also supports watchdog alarms. Watchdog alarms are based on an item's value NOT changing within a specified period of time. This type of alarm is useful for monitoring the operational status of a server/device. OPC DA servers only update clients when item value's change. If a server stops responding the client can only assume that the data has not changed but is still valid. Watchdog's are provided to guard against this by triggering an alarm event when an item's value fails to change within a specified amount of time.

WIN-911 can monitor an item's changing value by setting the time-out value greater

The OPC DA Conversation

There are three parts to an OPC DA Address: The Machine Name or IP Address, Server Class, and the ItemID. The Machine Name specifies the network node that the server resides on, the Server Class specifies the server that contains the data, and the ItemID is the specific data point within the server.

Connecting and Reconnecting to OPC DA Servers

The OPC DA data source will automatically connect to a properly registered OPC DA server when it becomes available on the target machine.

If an established server connection is broken, the OPC DA data source will attempt to reconnect when:

- Communication to the remote computer breaks due to loss of network connection.
- The remote computer running the OPC DA server is shut down or restarted.
- The OPC DA server indicates a failure to WIN-911.
- The OPC DA server asks WIN-911 to disconnect, e.g. for internal reconfiguration.
- The OPC DA server is not properly registered on the target machine - permanently, or even temporarily, when a new version is being installed.

Preparing Your Computer for Remote OPC DA

Setup DCOM

WIN-911 User Guide

Run the DCOM configuration utility by selecting Start and typing *dcomcnfg* in the *Search Programs and Files* text entry box. Highlight Component Services, then Computers, then right-click My Computer and select Properties which will bring up the Component Services dialog. Select the Default Properties tab and check Enable Distributed COM on this computer. In addition, make sure that the Default Authorization Level shows Connect and the Default Impersonation Level is set to Identify. Uncheck the additional security for reference tracking box (match the settings below). Set default security right by selecting the Default Security tab.

Configure Access Permissions for the computer's DCOM via the Default COM Security tab. On the Access Permission window you can add individual users and groups to grant access to this particular computer on the DCOM level. Make sure you select the correct domain or workgroup user list from the pull-down menu. Here you select your computer's domain or workgroup. For initial test purposes include Everyone in the Grant Access list.

Configure OPC DA Sources

Specify how to connect to your OPC DA sources.

The screenshot shows a configuration window for OPC DA sources. It features several input fields and buttons:

- Name:** A text field containing "OPC Server".
- Description:** An empty text field.
- Source Type:** Two radio buttons are present. The first, "Single Source Definition", is selected and highlighted with a black background. The second is "Group of Redundant Sources".
- Machine Name:** A text field containing "MyComputer" with a red circular menu icon to its right.
- Server Class:** A text field containing "OPCDA.Server.v1.x" with a red circular menu icon to its right.
- Footer:** A row of small, light-colored buttons, with a red circular save icon and a red circular close icon on the right side.

Name

Each data source must have a unique name that distinguishes it from the others.

Description

An optional text field for providing the user with context. Such information can contain location data (like Lift Station 22), or an

explanation of the event that conveys useful information to the user that is not provided elsewhere.

Single Source Definition vs. Group of Redundant Sources

Single Source Definition is the default OPC DA source type which interfaces a single server. If the source is an array of redundant servers you will need to use to specify each server that is part of the Group.

Machine Name

Select the computer that hosts your OPC DA server. You can use the browse button to the right to browse for your server. Type "localhost" if the OPC DA server is on the same machine as WIN-911.

Server Class

Enter the OPC DA server name. You can type the name manually or you can use the browse button to the right to select the server you wish to connect to.

Configure OPC DA Alarms

Configure alarm conditions on data provided by an OPC DA source. Alarms represent specific alarm conditions such as a tank level exceeding a high limit, or a valve being opened that would normally be closed and require an alarm responder to be notified. Alarms trigger a notification strategy.

Item

The screenshot shows the 'Item Alarms' configuration window. The fields are as follows:

Field	Value
Name	Gate Valve
Description	
Area	
Source	OPC Server
Item ID	SCADA.FreshWaterTank.GateValve
Update Rate	1,000 ms
Units	
Item Labels	+

Name

Each item must have a unique name. When WIN-911 delivers alarm messages, this is the name it will use. The name can be independent of the Item ID, which must match the syntax of the OPC DA server and is often cryptic.

Description

An extra text field for organization and administration purposes. It is intended to allow for elaboration on the information concerning the alarm/item. Such information can contain location data (like Lift Station 22), or a description of the data that provides additional context.

Area

The area is an optional attribute that can be assigned to help identify the item in environments that may have multiple sections with similar functions, such as a wastewater treatment plant with multiple lift stations. An area example would be "Lift Station 22". When importing from WIN-911 Version 7, the grouping name will be imported as the area.

Source

Select the OPC DA server name.

ItemID

The "ItemID" is the name of the tag as it exists within the OPC DA server and is the name that WIN-911 uses to communicate with the server. You can type the name in manually using the text entry box provided, but it is highly recommended that you use the browse button to the right and select the ItemID directly from the server for the sake of convenience and the prevention of errors.

Update Rate

You can set the update rate at which the OPC DA data source module refreshes its data. The default value is 1.000 ms.

Units

The Units field is optional. Use it to add engineering units. to your notifications.

Item Labels (for use by Advanced Tactics)

The "Item Labels" are optional attributes for organizing alarms in a logical manner. They can represent function, location, severity, or other such category that serves the project requirements. [See Labels.](#)

Alarms

The screenshot shows the 'Alarms' configuration window for an 'Item'. The form contains the following fields and controls:

- Name:** Text input field containing 'is Open'. A red trash can icon is to its right.
- Description:** Empty text input field.
- Condition:** A dropdown menu set to 'Item Value', followed by an equals sign, another dropdown menu, and a text input field containing '0'. A red right arrow icon is to its right.
- Strategy:** A dropdown menu set to 'Default'. A red right arrow icon is to its right.
- Units:** Empty text input field.
- Severity:** A horizontal slider bar with a red vertical marker in the middle and a text input field containing '500' on the right.
- Item Labels:** A section with a 'Labels' text input field and a red plus sign icon to its left. A red right arrow icon is to the right of the labels section.
- Bottom Bar:** A light gray bar at the bottom right containing a red save icon and a red close icon.

Note: Each individual item can be assigned any number of alarm conditions.

Name

Each alarm must have a unique name. When WIN-911 delivers alarm messages, this is the name it will use.

Description

An optional text field for providing the user with context. Such information can contain location data (like Lift Station 22), or an explanation of the event that conveys useful information to the user that is not provided elsewhere.

Condition

The value or state of the OPC DA item that defines the alarm condition.

Item Value: Alarm based on the item's value. The relationship can be equal to, not equal to, greater than, less than, or a combination thereof.

Quality: Alarm based on the OPC DA item's attribute.

Watchdog: Alarm based on an item's value NOT changing within a specified period of time. This type of alarm is useful for monitoring the operational status of a server/device. OPC DA only updates clients when value's change. If a server stops responding the client can only assume that the data has not changed but is still valid. Watchdog's are provided to guard against this by creating an alarm event when an item's value fails to change within a specified amount of time.

Strategy

The strategy that WIN-911 invokes when the alarm event occurs.

Severity

A number from 1 to 1000 that designates that urgency of an alarm event. It can be used as an organizational tool and be used in a tactic to determine how an alarm is dispatched. The default severity is 500.

Units

The Units field is optional. Use it to add engineering units to your notifications.

Alarm Labels

The "Alarm Labels" are optional attributes for organizing alarms in a logical manner. They can represent function, location, severity, or other such category that serves the project requirements. [See Labels.](#)

Import from OPC DA Server

Import items from an OPC DA server on your local network. The OPC DA server should be configured as a source before it can be browsed for items to import.

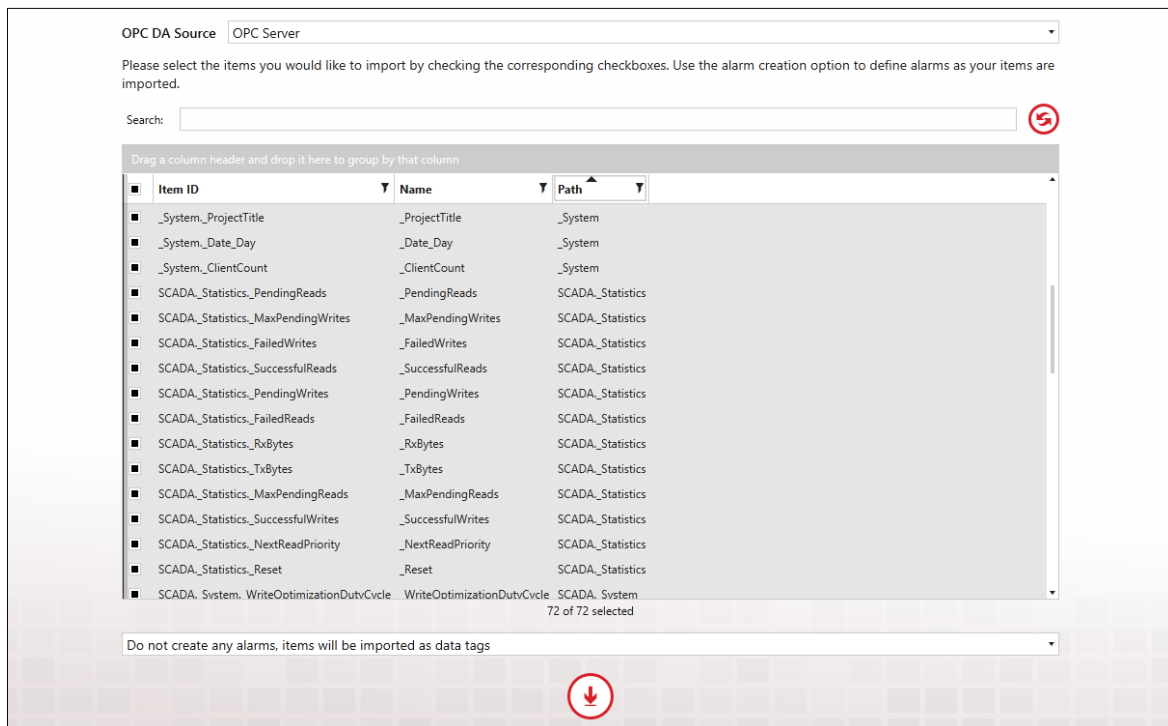

OPC DA Source

Use the pull-down list to select the OPC DA server that you would like to conduct the import from. If there are no servers in the list, you will have to create one in the OPC DA Sources workspace.

See [Configure OPC DA Sources](#).

OPC DA Item Import

If the OPC DA server supports browsing then the OPC DA module will generate a list of all items available for importing. Select the items you would like to import by checking the corresponding check boxes. You can also create alarms on selected items while importing.

Import Item List

In the center of the import items workspace is a master list of all importable items. Each import item object contains three properties, the Name, ItemID, and Path, that are displayed in columnar format. These properties can be used to sort and filter import items using tools provided within the form. The active sorting column is indicated by a black triangle in the middle of the column header.

Selecting Import Items

The import item(s) is selected by clicking the check box to the left of the import item's properties. Multiple import items can be selected per import.

Sorting

When the name column header has a black triangle pointing down, the import items will be arranged by name in descending alphabetical order. Clicking on the triangle will reverse the list and cause it to be arranged in ascending order. A third click on the triangle will deselect the column. Any property column can be sorted.

Search

The search field will filter the import items collection selector list by suppressing the display of import items that do not contain the character string entered. Any property column can be searched. The search field will be highlighted yellow while the search filter is in session.

Filtering

On the right side of the property column heading is a black filter symbol. Clicking it causes a custom filter design form to appear. This form provides several options the WIN-911 administrator can use to exclude unwanted import items from being listed in the collection selector. "And/Or" expressions can be created that key on the selected property data for inclusion or exclusion. The selected property (Name or Description) column header will be highlighted yellow while the custom filter is applied. Any property column can be filtered.

Grouping

Dragging and dropping a property column header into the grey area above the import items list will cause the collection selector to group the import items accordingly. The collection selector now lists the title of the selected object in bold font with a drop-down arrow to the left. Click on the drop-down arrow and the collection selector will drop a list of all the import items that contain a particular object title. Groups can be compounded by dragging another object into the "Group by" field. Grouping can be removed by hovering over the group title and clicking the "X" that appears to the right of the title. Any property can be grouped.

Select Import Alarm Condition

Each import can be configured to automatically set an alarm condition, that will be assigned to each of the selected items by using the pull-down selector beneath the import item selection list. The alarm condition will be assigned the Default (Notify All) strategy. The alarm condition options are as follows:

- Do not create any alarms, items will be imported as data tags (default selection).
- Create an alarm on value = 0
- Create an alarm on value = 1
- Create an alarm on value "not equal to" 0
- Create quality alarm

Note: Caution should be used when automatically assigning alarm types to bulk imports. Upon completion of the import all new alarms will immediately go live and any that are in alarm condition will be subject to the default strategy "Notify All".

CIMPLICITY Projects

CIMPLICITY Version

Note: WIN-911 supports CIMPLICITY versions 10 and 11. You must select the version during product installation. If you change your CIMPLICITY version later you must uninstall the WIN-911 CIMPLICITY module, remap the remaining modules (see [WIN-911 Network Module Mapper](#)) and install the newer version using the WIN-911 Installer.

Project

Project Name

Enter the name of the CIMPLICITY project you wish to monitor. The name is case sensitive and must match the project name as it appears in CIMPLICITY.

Username/Password

CIMPLICITY users can be assigned a password to enhance operational security. If a password is configured for the WIN-911 username enter it here, otherwise leave this field empty.

Health Alarm

WIN-911 User Guide

The health alarm monitors WIN-911's connection with the project. If the project connection is lost WIN-911 will trigger an alarm that can be dispatched an alarm notifier

Description

Enter the text of the alarm message you wish to be dispatched on the event of a data source connection loss.

Strategy

Select the strategy you wish WIN-911 to use when dispatching the health alarm notification.

Severity

A numeric attribute from 1 to 1000 that designates that urgency of an alarm event. It can be used as an organizational tool and be used in a tactic to determine how an alarm is dispatched and which alarm has priority over another. The default severity is 500.

Labels (for use by Advanced Tactics)

Labels are optional attributes for organizing alarms in a logical manner. They can represent function, location, severity, or other such category that serves the project requirements. ([See Labels](#))

Filters

WIN-911 provides the CIMPLICITY user with two methods of alarm monitoring: Filters, and Points. Filters allow WIN-911 to subscribe to a range of possible alarm events based on criteria the user defines here.

The advantage of using alarm points over filters is that individual points are subject to having its alarm criteria modified which may cause a previously defined alarm filter to reject the new alarm. In situations where a point and a filter both match an alarm event, the point setting will take priority over the filter and dispatch the alarm.

Filters specify which CIMPLICITY alarm events will be handled by WIN-911 and which strategy will be utilized when handling them (See "Tactics" and "Strategies" in the Notification section). The user is able to create subscriptions for All Alarms, or subscribe based on Point ID, Class Names, or Class Orders.

If more than one subscription is set up for an alarm event, the event will be handled based on the first matching filter defined. If all properties of the filter are not satisfied by an alarm event, WIN-911 will move on to the next filter until a matching filter is found. The filter workspace also allows the user to attach Labels to the alarms.

All Alarms

If All Alarms is selected (default), all CIMPLICITY alarm event messages for this filter will match the subscription and will be sent to WIN-911 for remote notification as per the selected strategy.

Point ID

Each point in a CIMPLICITY project has a unique Point ID.

WIN-911 User Guide

Your filter can be set to allow all Point IDs or you can restrict certain events base on criteria you specify here. When defining specific Point ID criteria you have the option to use a "Wildcard" to include certain events based on your input, or a "RegEx" to exclude certain names. For example, "T*" would match all alarm events with an alarm name that starts with "T" while "*pump*" would match all events containing the string "pump" in their name. Any alarm event that does not meet this criterion will cause the event to be rejected by the filter.

Class Names

Alarm Classes are a group of alarms with similar characteristic. Class names (Class ID) can be up to 5 characters in length, must be unique, and cannot include the \$ or | characters.

Your filter can be set to allow all class names, or you can restrict certain events base on criteria you specify here. When defining specific Class Name criteria, you have the option to use a "Wildcard" to include certain events based on your input, or a "RegEx" to exclude certain names. For example, a wildcard with criteria of "T*" would match all alarm events with a class name that starts with "T" while "*pump*" would match all events containing the string "pump" in their name. Any alarm event that does not meet this criterion will cause the event to be rejected by the filter.

Resource IDs

Your filter can be set to allow all Resource IDs or you can restrict certain events base on criteria you specify here.

Class Orders

An alarm Class Order is a numeric priority that ranges from 0 to 9999, where 0 is the highest priority and 9999 is the lowest.

You can select an order range (e.g. 200-400) or a specific order value (e.g. 800). Any alarm event that does not meet this criterion will cause the event to be rejected by the filter.

Combinations

The filters are evaluated based on the sum total of all criteria specified. For example, a filter with a specified class order of "700-900" and a Point ID of "T" would match all alarm events with a class order range of "700-900" and a Point ID that starts with "T". Since the Class Name was not specified no alarm event would be rejected based on Class Name.

Strategy

Select defined Strategy to dispatch alarms for this filter.

Labels

Labels are optional attributes for organizing alarms in a logical manner. They can represent function, location, severity, or other such category that serves the project's alarming requirements. ([See Labels](#))

Watchdogs

Cimplicity supports watchdog timers which may be used to alert users when communications are lost between WIN-911 and Cimplicity. WIN-911 must monitor an alarm condition that cycles in and out of alarm on a specified time interval. The watchdog timer would then be set to

WIN-911 User Guide

a value greater than the interval. If the timer expires prior to the change of alarm state, WIN-911 will trigger the watchdog.

Name

Enter a name for this watchdog.

Description

An extra text field for context concerning the Watchdog Alarm.

Point ID

Each Point ID can have up to 32 characters, any combination of uppercase letters and numbers, and special characters, with some restriction (see CIMPLICITY documentation for these).

Timeout

Specify the timeout interval that WIN-911 will wait for an alarm condition change to occur before triggering the Watchdog. Enter time (in seconds) from "5" to "900".

Severity

Select severity level the alarm will be assigned ("0" through "1000").

Strategy

Select defined Strategy (See "Notification" for information on setting up Strategies").

CIMPLICITY Points

WIN-911 provides the CIMPLICITY user with two methods of alarm monitoring: 1) Filters, and 2) Points. Filters allow WIN-911 to subscribe to a range of possible alarm events based on criteria the user defines in the CIMPLICITY Filters Workspace (see CIMPLICITY Projects>Filters). The advantage of using alarm points is that individual points are subject to having its criteria modified which may cause a previously defined WIN-911 filter to reject the new alarm event. In the case where a filter is set that matches the Points configuration, the Points configuration takes priority over the Filter and will process the alarm rather than producing two alarm events, one for the filter and one for point.

Point

Name

The "Name" field is a unique WIN-911 property that can be associated with the Cimplicity point. Its purpose is to make the point name easier to read if the Cimplicity Point ID is cryptic. This name must be unique and is independent of CIMPLICITY's Point ID.

Description

An optional text field for providing the user with context. Such information can contain location data (like Lift Station 22), or an explanation of the event that conveys useful information to the user that is not provided elsewhere.

Project

Select the CIMPLICITY project that contains this point.

Point ID

Each Point ID can have up to 32 characters, any combination of upper-case letters and numbers, and special characters, with some restriction (see CIMPLICITY documentation for these).

Strategy

Select the strategy you wish WIN-911 to use when dispatching the health alarm notification.

Labels (for use by Advanced Tactics)

Labels are optional attributes for organizing alarms in a logical manner. They can represent function, location, severity, or other such category that serves the project requirements.

Conditions

You may optionally define conditions in order to provide condition specific labels and description.

Condition

The value or state of the CIMPLICITY point that constitutes an alarm event. The state can be selected from the following options: Lo, LoLo, Normal, Hi, and HiHi.

Description

Enter the text of the alarm message you wish to be dispatched on the event of a data source connection loss.

iFIX Sources

Source

Source Health Alarms Filters Watchdogs Heartbeat



You must configure iFIX to launch the alarm queue and source runtime. [Learn More](#)

Queue Name

iFIX Security Mode **No Security** Specify Credentials

Shutdown with iFix

Ignore COMM Alarms

You must configure iFIX to launch the alarm queue and source at runtime.

Queue Name

To integrate WIN-911 with iFIX you must configure the iFIX System Configuration Utility (SCU) to start two executables as part of the iFIX startup sequence: the alarm queue and the WIN-911 iFIX runtime source. The queue must be started before the runtime source. The two applications must be launched before WIN-911 may import blocks from iFIX and are also required for remote alarm notification. Follow the instructions below to make sure that iFIX launches both of these applications at start up, and in the proper order.

1. Open the iFIX SCU.
2. Open the Configure > Tasks...
3. Click the browse button to the right of the Filename text box.

WIN-911 User Guide

4. *Browse to the WIN-911 iFIX runtime source path. By default, the path is : "C:\Program Files (x86)\WIN-911 Software\WIN-911\iFIX." and select "AlmUserQ.exe."*
5. *In the command line text box enter "/nWIN911 /s6000" without quotations. (Take note that there is no space between "/n" and "WIN911" or between "/s" and "6000.")*
6. *Set the start up mode to "background."*
7. *Click the add button.*
8. *Once again, click the Filename browse button and navigate to the WIN-911 iFIX runtime source path.*
9. *Select "WIN911_Source_iFIX_Runtime_WPFHost.exe."*
10. *Leave the Command Line field blank (see note below) and set the start up mode to "background."*
11. *Click the "add" button.*
12. *Click the "OK" button at the bottom of Task Configuration page.*
13. *Save the changes you've made in the SCU with the File > Save menu option.*

iFIX Security Mode

iFIX can be configured to require security credentials for access to their SCADA. When iFIX is configured for security WIN-911 will require valid credentials (including permission to read and write to the database) in the form of a username and password. See your network administrator for obtaining credentials for your WIN-911 system.

Shutdown with iFIX

When iFIX shuts down, it likewise shuts down any program that is connected to it, including the WIN-911 iFIX Runtime. This action prevents any Watchdog alarm from triggering. We provide an option to allow the WIN-911 iFIX Runtime to persist through an iFIX shutdown, and hence, trigger Watchdog alarms upon timeout. However, this selection will prevent iFIX from being restarted until the WIN-911 iFIX Runtime is shutdown.

WIN-911 does not recommend deselecting this option as it will prevent subsequent launching of iFIX. Thus, the default setting is to allow iFIX to shutdown WIN-911 as part of its normal shutdown routine.

Ignore COMM Alarms

COMM and No Data alarms are types of alarms that can be classified by the user as nuisance alarms that do not need to be dispatched to remote personnel. This option, when selected, will cause WIN-911 to ignore these types of alarms, even if iFIX does not. This is a global setting that affects all alarms that WIN-911 monitors from the entire user queue (ALMUSERQ.EXE).

Note: iFIX 6.0 now includes the extended capability to shelve alarms in the Alarm Summary Object. With alarm shelving enabled, you can temporarily suppress selected alarms from the active alarms list in the alarm summary object for a fixed period of time. WIN-911 can use the event of shelving and unshelving alarms to trigger remote notification policies when using Advanced Strategies > Alarm Becomes Suppressed (Shelved) and Alarm Becomes Unsuppressed (Unshelved). See [Advanced Strategies > Policy Conditions](#).

Health Alarms

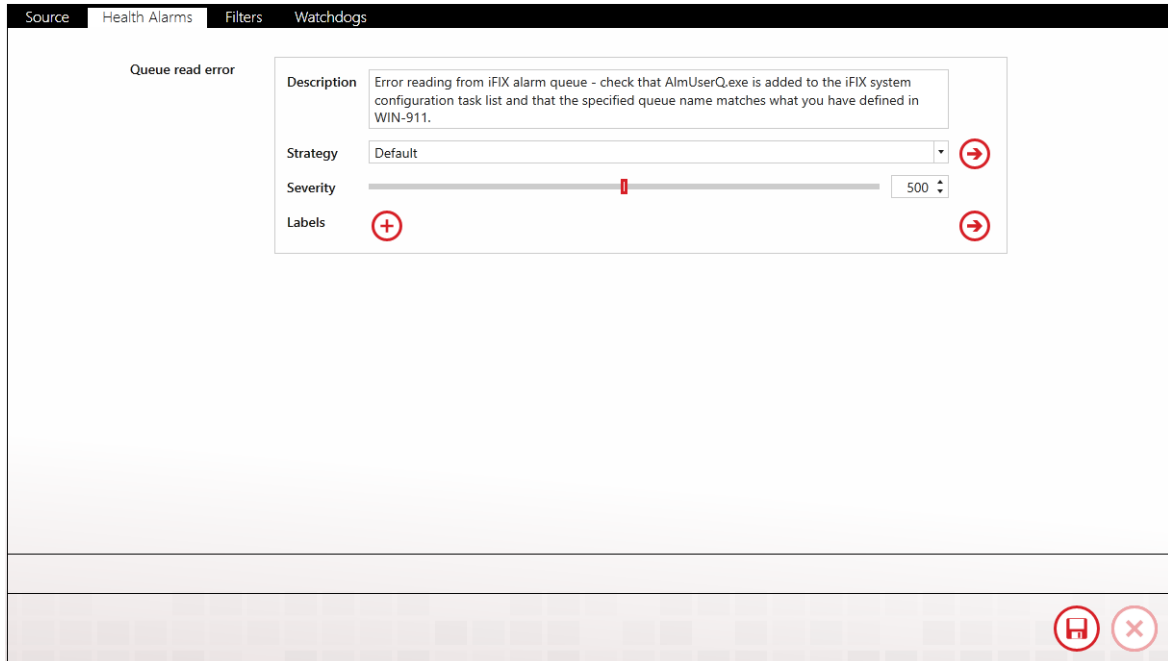

Description

The text of the health alarm can be modified by the WIN-911 Administrator by editing the contents of the description text entry box.

Strategy

The strategy selector pull-down list assigns the strategy that WIN-911 will use to dispatch health alarm messages.

Severity

You can select a specific severity value (e.g. 800) to associate with Health Alarms.

Alarm Priority to Severity Map

Critical: 1000

HiHi: 900

High: 700

Medium: 500

Low: 300

LoLo: 100

Info: 0

Labels (for use by Advanced Tactics)

Labels are optional attributes for organizing alarms in a logical manner. They can represent function, location, severity, or other such category that serves the project requirements.

Filters

WIN-911 provides the iFIX user with two methods of alarm monitoring: 1) Filters, and 2) Blocks. Filters allow WIN-911 to subscribe to a range of possible alarm events based on criteria the user defines here. This section focuses on the development of alarm filters.

The advantage of using alarm blocks (rather than filters) is that WIN-911 will synchronize alarm states upon startup; however, this initialization can be very time consuming. In general, filters are preferred. Filters consume fewer resources and are easier to

WIN-911 User Guide

maintain. In the case where a filter is set that matches an alarm block configuration, the block configuration takes priority over the filter and will process the alarm rather than dispatching two alarm events, one for the filter and one for the block.

Filters specify which iFIX alarm events will be handled by WIN-911 and which strategy will be utilized when handling them (See "Tactics" and "Strategies" in the Notification section). The user is able to create subscriptions for All Alarms (default), or selections based on Block Names, or Specific Areas.

If more than one filter is set up for an alarm event, the event will be handled based on the first matching filter defined. If all properties of the filter are not satisfied by an alarm event, WIN-911 will move on to the next filter until a matching filter is found. The filter workspace also allows the user to attach Labels to the alarms matching the filter.

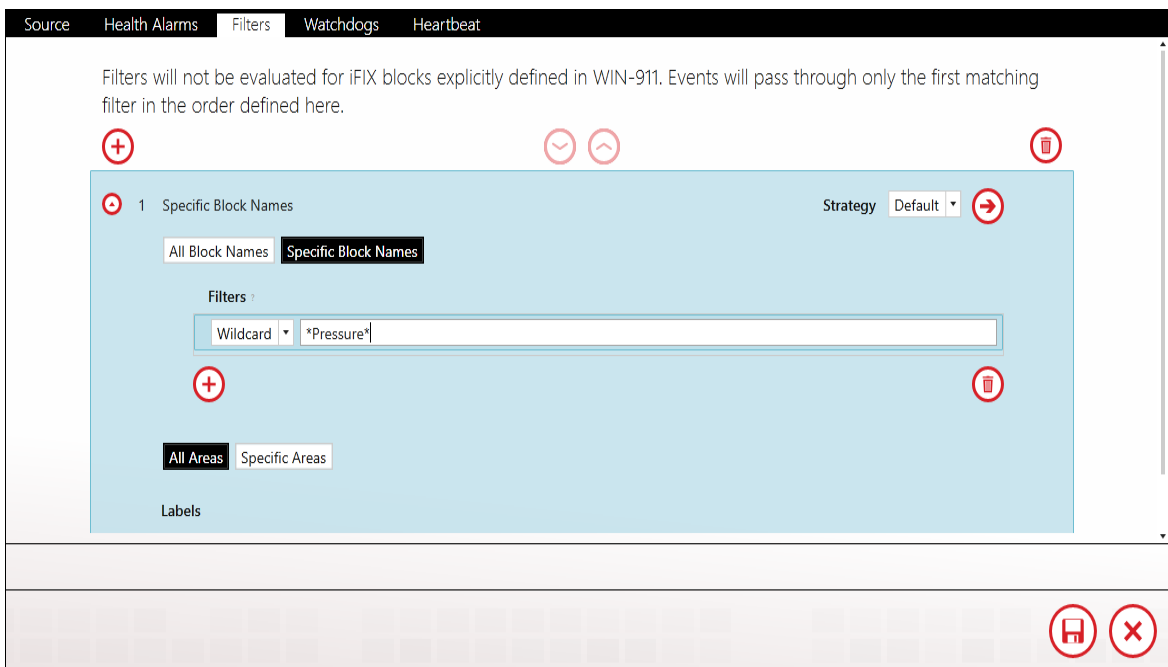

All Block Names

If All Block Names is selected (default), all iFIX alarm event messages for this filter will match the subscription and will be sent to WIN-911 for remote notification as per the selected strategy.

Specific Block Names

Each block in an iFIX project has a unique block name that identifies it. It can have up to 32 characters (256, iFIX 6 and above), any combination of upper-case letters and numbers, and special characters, with some restriction (see iFIX documentation for these).

Your filter can be set to allow all block names, or you can restrict certain events base on criteria you specify here. When defining specific block name criteria, you have the option to use a "Wildcard" to include certain events based on your input, or a "RegEx" (regular expression) to exclude certain names. In a wildcard search, "T*" would match all alarm events with an alarm name that starts with "T" while "*pump*" would match all events containing the string "pump" in their name. Any alarm event that does not meet this criterion will cause the event to be rejected by the filter. If more than one filter criterion is specified, the alarm is considered to match the filter if any criterion is matched.

All Areas

If All Areas is selected (default), all iFIX alarm event messages for this filter will match the subscription and will be sent to WIN-911 for remote notification as per the selected strategy.

Specific Areas

Each Area in an iFIX project has a unique area name that identifies it. Each area name can have up to 32 characters, any combination of upper-case letters and numbers, and special characters, with some restriction (see iFIX documentation for these).

Labels

Labels are optional attributes for organizing alarms in a logical manner. They can represent function, location, severity, or other such category that serves the project's alarming requirements.

Combinations

The filters are evaluated based on all criteria specified. For example, a filter with a specified block name WASTEWATER and an alarm area that contains the letter "T" would match only alarm events with a block name of WASTEWATER and an alarm area that contains the letter "T".

Strategy

Select defined Strategy (See "Notification" for information on setting up Strategies").

Watchdog

WIN-911 provides watchdog timers which may be used to alert users when communications are lost between WIN-911 and an iFIX tag. WIN-911 will monitor the specified tag, expecting an alarm event or value change message to appear in the queue within a specified

period of time. When the value or alarm state fails to change within the specified period of time the Watchdog alarm will become active.

Note: Ensure all Watchdogs are configured with database blocks that are dedicated to this unique purpose. Combining Watchdog blocks with other SCADA functions will cause the Watchdog not to function properly.

The screenshot shows the 'Watchdogs' configuration window. It has a navigation bar with 'Source', 'Health Alarms', 'Filters', 'Watchdogs', and 'Heartbeat'. The main area contains the following fields and controls:

- Name:** Text input field containing 'Watchdog'. A trash icon is to its right.
- Description:** Text input field containing 'No value change has been received for this block within the specified timeout period.'
- Node Name:** Dropdown menu showing 'FIX'.
- Tag Name:** Text input field containing 'WATCHDOG'. A refresh icon is to its right.
- Timeout:** Text input field containing '90 sec'.
- Strategy:** Dropdown menu showing 'Default'. A refresh icon is to its right.
- Severity:** A horizontal slider with a red indicator and a numeric input field showing '500'.
- Labels:** A plus icon, a green 'Safety' label, and a red 'x' icon. A refresh icon is to the right.

At the bottom left, there is a plus icon and the text: 'Click the plus icon to add a new Watchdog.' At the bottom right, there are icons for save, close, and refresh.

Name

Enter a name for this watchdog.

Description

An extra text field communicated with the alarm event notification.

Node Name

The node of the block to be monitored. Each can have up to 32 characters (256, iFIX 6 and above), any combination of upper-case

WIN-911 User Guide

letters and numbers, and special characters, with some restriction (see iFIX documentation for these).

Tag Name

The tagname of the block to be monitored. Each can have up to 32 characters (256, iFIX 6 and above), any combination of upper-case letters and numbers, and special characters, with some restriction (see iFIX documentation for these).

Timeout

Enter time (in seconds) from "5" to "900".

Strategy

Select defined Strategy (See "Notification" for information on setting up Strategies").

Severity

Select severity level the alarm will be assigned ("0" through "1000").

Alarm Priority to Severity Map

Critical: 1000

HiHi: 900

High: 700

Medium: 500

Low: 300

LoLo: 100

Info: 0

Labels

Labels are optional attributes for organizing alarms in a logical manner. They can represent function, location, severity, or other such category that serves the project's alarming requirements.

Heartbeat (Optional)

WIN-911 can indicate its operational status by writing a periodically changing value to an integer value in your SCADA. We call this function a 'Heartbeat' because it provides a 'vital-sign' to iFIX, allowing for corrective action to be taken.

The Heartbeat takes the form of an Integer value that ramps from 0 to 9 on a time period of your choosing. After the value reaches 9 it resets to one, and the process is repeated, ad infinitum. If the value fails to update within the specified time, you can assume that WIN-911 is in an impaired state and no longer able to receive alarm event information.

Note: the heartbeat is the only WIN-911 function that will write data to iFIX. We recommend AR block type for this function.

WIN-911 User Guide

Source Health Alarms Filters Watchdogs Heartbeat



Enable Heartbeat

A heartbeat can be used to write an incrementing numeric value (1 - 9) to an AI Block upon a timer tick. When the value does not increment after the Write Interval, you can determine when the WIN-911 iFIX Data Source has either stopped running or disconnected from iFIX and take corrective action.

Node Name

Tag Name

Write Interval

Node Name

The node of the block to which WIN-911 will write. It can have up to 32 characters (256, iFIX 6 and above), any combination of upper-case letters and numbers, and special characters, with some restriction (see iFIX documentation for these).

Tag Name

The tagname of the block to which WIN-911 will write. Each can have up to 32 characters (256, iFIX 6 and above), any combination of upper-case letters and numbers, and special characters, with some restriction (see iFIX documentation for these).

Timeout

Enter time (in minutes) from "1" to "60."

Setting up a Heartbeat

1. Create an analog block which allows input (i.e. AR) in your iFIX Workspace > Database Manager.
2. Create Visual Basic Script that monitors the value and triggers recovery procedures/methods when the heartbeat fails.
3. WIN-911 Workspace > Alarming > iFIX > Source > Heartbeat > Enable Heartbeat.
4. Enter the node name of the SCADA project.
5. Enter the name of the tagname of the block you created in step 1.
6. Set the heartbeat update rate (in Minutes) with the *Write Interval* combo-box.
7. Save your edits in the WIN-911 Workspace.

iFIX Blocks

WIN-911 provides the iFIX user with two methods of alarm monitoring: 1) Filters, and 2) Blocks. Filters are the preferred option as they allow WIN-911 to subscribe to a range of possible alarm events based on criteria the user defines in the iFIX Filters Workspace (see iFIX>Source>Filters). This section focusses on the development of individual iFIX Blocks.

Block

The screenshot shows the 'Block Alarm States' configuration window. The fields are as follows:

- Name:** Hopper 1
- Description:** Use iFIX Setting (with a 'Specify' button)
- Node Name:** FIX
- Tag Name:** HOPPER1
- Strategy:** Default
- Block Labels:** Building2 (with a red 'x' icon)

On the right side, there are three red circular icons: an ellipsis, a right arrow, and a right arrow with a red 'x'. At the bottom right, there are two red circular icons: a save icon and a close icon.

Name

The "Name" field is a unique WIN-911 property that can be associated with the iFIX Blocks. Its purpose is to make the block name easier to consume if the iFIX block name is cryptic. This name must be unique

but is independent of iFIX Tag Name and only used when dispatching alarm notifications.

Description

Enter the text of the alarm message you wish to be dispatched with alarm events for this block. The user can opt to use the iFIX description or can specify a custom description for use by WIN-911.

Node Name

Select the iFIX node that contains this block. The name is case sensitive and must match the node name as it appears in iFIX.

Tag Name

Each block in an iFIX configuration has a unique tag name that identifies it. Each can have up to 32 characters, any combination of upper-case letters and numbers, and special characters, with some restriction (see iFIX documentation for these).

Strategy

Select the strategy you wish WIN-911 to use when dispatching alarm events for this block. ([See Strategies](#))

Block Labels (for use by Advanced Tactics)

Labels are optional attributes for organizing alarms in a logical manner. They can represent function, location, severity, or other such category that serves the project requirements. ([See Labels](#))

Alarm States

You may optionally define alarm states in order to provide alarm state specific labels and descriptions.

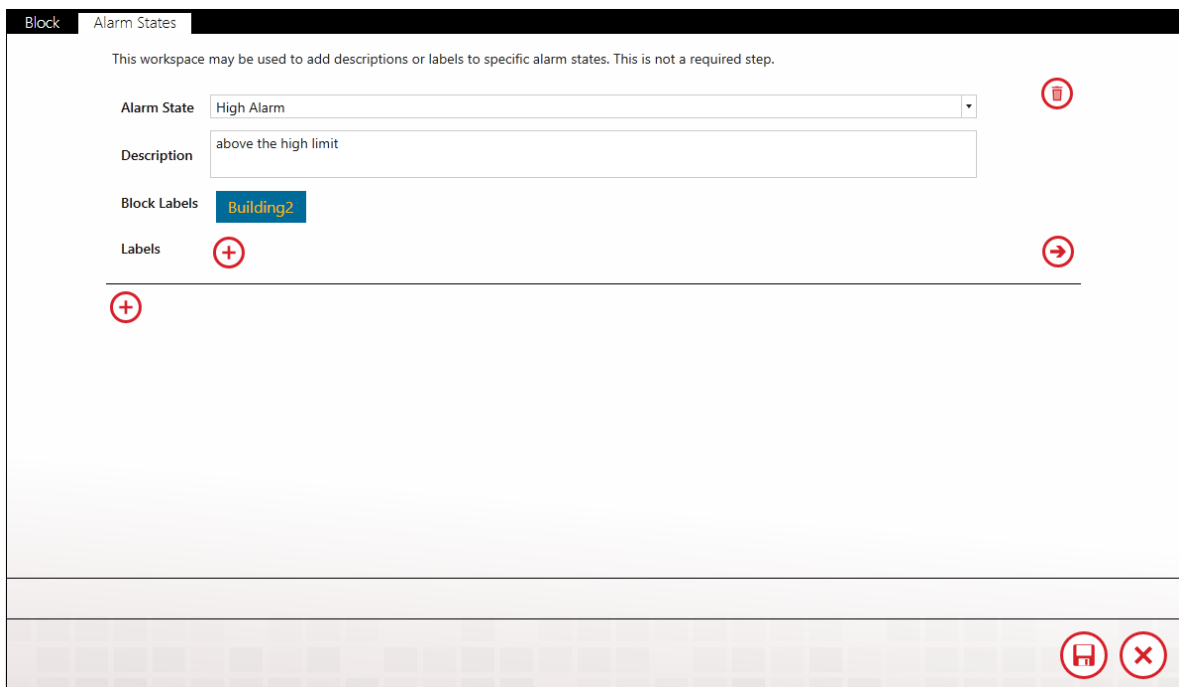

The screenshot shows a software interface for configuring alarm states. At the top, there are two tabs: "Block" and "Alarm States", with "Alarm States" being the active tab. Below the tabs, a message reads: "This workspace may be used to add descriptions or labels to specific alarm states. This is not a required step." The main configuration area contains several fields: "Alarm State" is a dropdown menu currently set to "High Alarm"; "Description" is a text input field containing "above the high limit"; "Block Labels" is a blue button labeled "Building2"; and "Labels" is a section with a red plus icon in a circle. To the right of the "Alarm State" field is a red trash can icon. To the right of the "Labels" section is a red right-pointing arrow icon. At the bottom right of the interface, there are two red icons: a save icon (floppy disk) and a close icon (X).

Alarm State

The state on which to provide customer labels and/or descriptions. The state can be selected from the following options: Lo, LoLo, Normal, Hi, and HiHi.

Description

Enter the text of the alarm message you wish for alarm events with this state.

Block Labels (for use by Advanced Tactics)

Labels are optional attributes for organizing alarms in a logical manner. They can represent function, location, severity, or other such category that serves the project requirements. ([See Labels](#))

iFIX Imports

Logical Node and Attribute Selection

Import blocks from an iFIX database on your network.

The iFIX client on the WIN-911 host and all applicable iFIX SCADA servers must be running in order to conduct a block import.

You must define a strategy other than the default strategy before importing iFIX blocks. This is required in order to ensure a large number of blocks are not accidentally imported and immediately dispatched to everyone in the WIN-911 contact library. You may still conduct the import and assign all blocks to the Default strategy. This requirement is merely a safeguard to force verification of your intent.

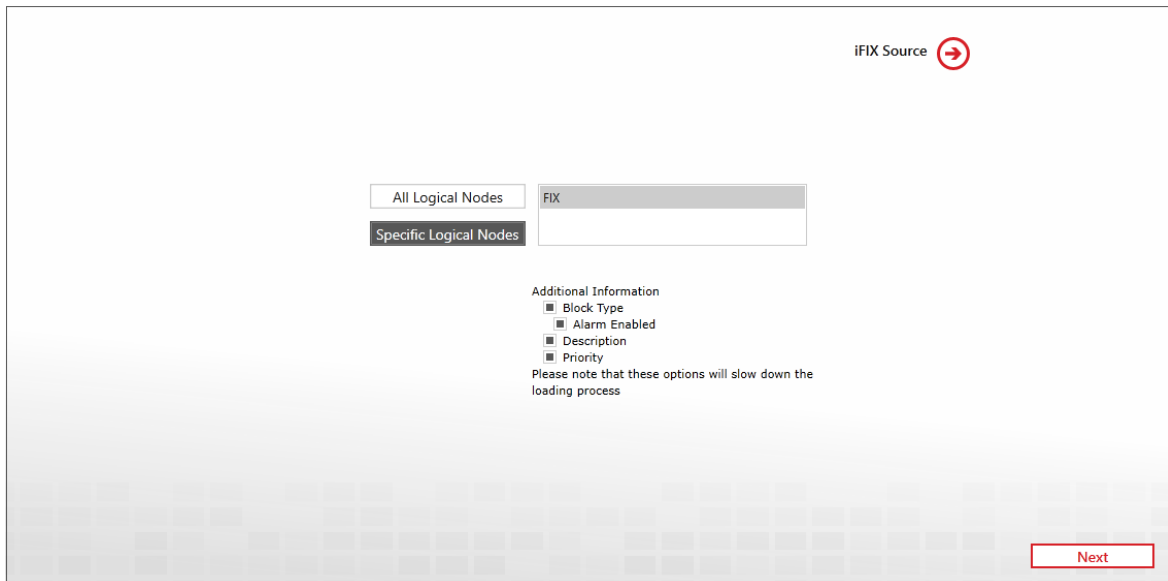

All Logical Nodes

This selection will allow the selection of blocks from all logical nodes on your iFIX network.

Specific Logical Nodes

This selection filters the available block list to blocks residing on specified logical nodes. The nodes may then be selected from the available nodes list on the right.

Additional information can be gathered to help organize and refine the import process. This can include block types (AA, AD, DI, etc.), alarm descriptions, whether or not alarming has been enabled, Descriptions, and Priority. Please note that these options will slow down the loading process.

Once your nodes and additional information are selected, click next to proceed to block selection page by clicking the Next button on the bottom right. You can always return to this page by clicking the previous button on the bottom left.

Block Selection

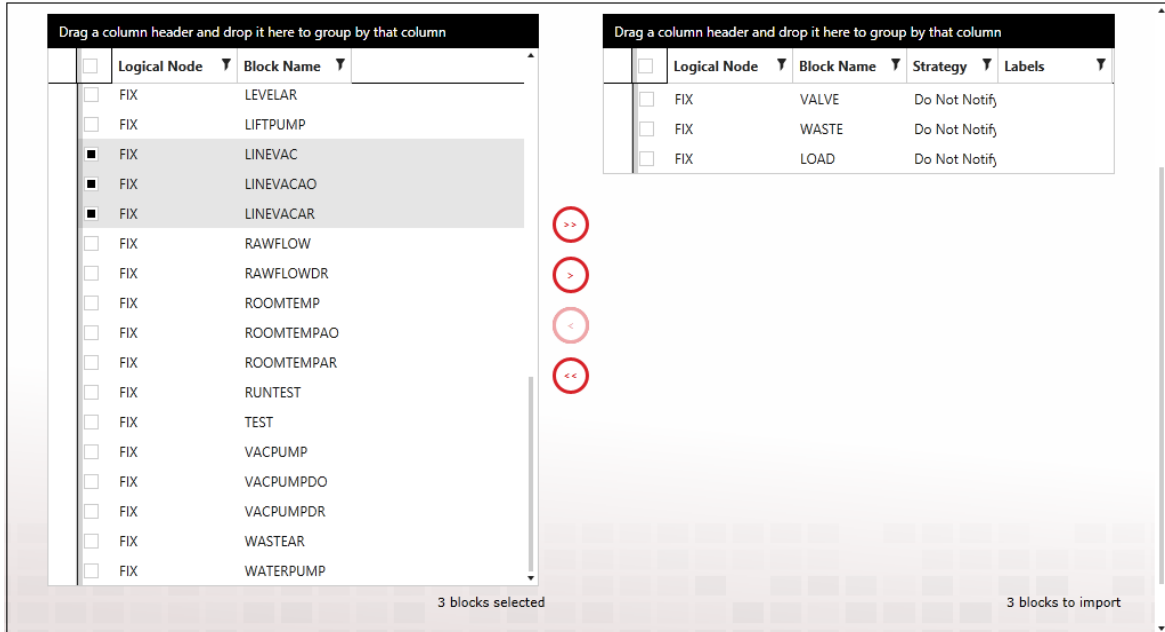

The block selection page provides the WIN-911 Administrator with a powerful tool to quickly and accurately import mass data, apply labels and assign strategies with as few steps as possible.

Start by selecting the strategy you want to assign to all of the blocks collected in this section. You can repeat any portion of the import to gather different blocks to assign to other strategies. Once a block has been imported it will no longer show up in the available blocks list. Thus, everything shown in the available blocks list is NOT currently a part of your WIN-911 configuration. Once a block (or list of multiple blocks) are selected they are moved to the selected blocks list on the right by clicking the red arrows on the column between the two lists.

Once your selection is complete you can execute the import by clicking the finish button on the bottom right. Until that button is clicked no blocks are imported.

Import Results

After the import is complete WIN-911 presents a report that details the result of the process. From this page the user can continue with further block imports by clicking the Import More button provided on the bottom right or navigate to the iFIX Blocks tab by clicking the red arrow under the results report.

FactoryTalk A&E Subscriptions

WIN-911 provides FactoryTalk A&E with a list of common properties that describe the kinds of alarms that WIN-911 is interested in monitoring. This method is powerful because a single subscription can be defined to handle a multitude of possible alarm events. For example, you can say to FactoryTalk, "send me all alarms with a priority of 95 or greater". Contrast this to defining a tag entry in WIN-911 for every tag you want WIN-911 to monitor. Subscriptions can be created to match against FactoryTalk names, classes, and/or severities. Subscriptions may be used across multiple servers to fetch existing alarms within. By default, a Subscription named 'All Alarms' is included.



Discussion: Subscription Logic

In to filter the collection of events coming from the source, Subscriptions allow for the definition of filter Criteria, e.g. alarms with high severity belonging to class A or class B. Such Criteria fall into three Categories for FTAE, 1) Name, 2) Class, 3) Groups, and 4) Severity. Each category has an "All" option, which, as the name implies, is unrestricted. Each category also has a "Specific" option, which puts restrictions on the parent category. These restrictions are defined by the criteria the WIN-911 user authors.

A "Specific Category" will have at least one criteria rule which places restrictions on what type of alarm will qualify for this subscription. So what does WIN-911 do when multiple criteria are assigned? The alarm candidate will have to match one or more rule to qualify in a specific category. It does not have to match them all. This is to say that the criteria are logically "OR" d together, because the alarm candidate must match one "OR" the other.

Categories themselves follow a slightly different logic. For an alarm candidate to match the particular subscription, the alarm must have a match for each category. This is to say that the categories are "AND" d together, since the alarm candidate must be a match for the Names "AND" Classes "AND" Severities. If the candidate does not have at least one match for the Classes category, the alarm does get credit for the Classes category and thus, is rejected by the subscription.

In short: the Names, Classes, Groups, and Severities categories are be ANDed. The filter criteria under each category shall be ORed.

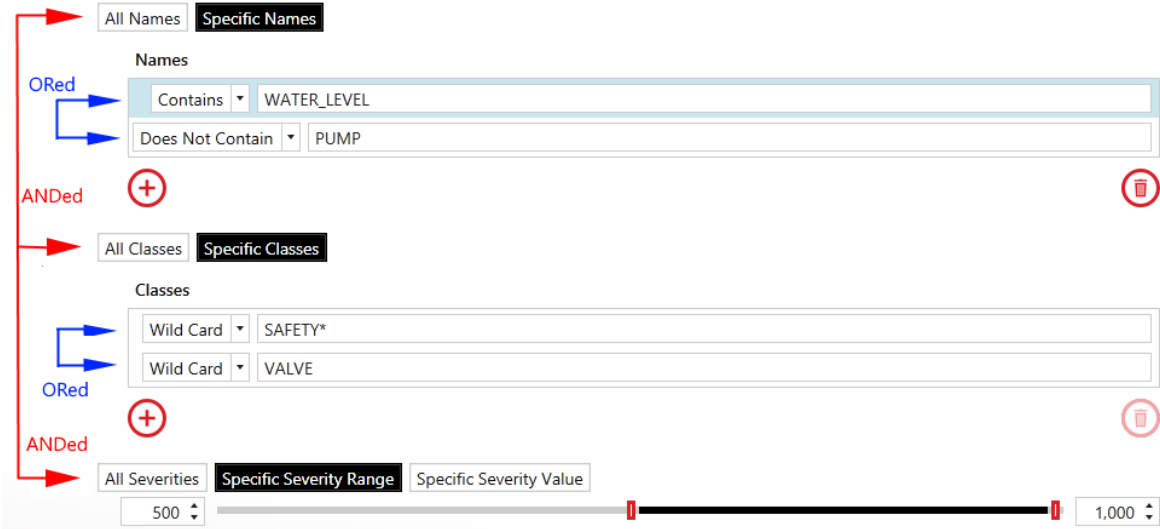

Subscription

By default, Subscriptions will match all alarms when first created.

Users can click the radio buttons to modify the filtering criteria. In the example below, specific Names and Severities are being targeted.

The screenshot shows a configuration interface for a subscription. At the top, there is a text input field labeled "Name" containing the text "Sub 1". Below this, there are two radio buttons: "All Names" and "Specific Names", with "Specific Names" selected. Under the "Names" section, there are two input fields: "Wild Card" with an asterisk (*) and "Regular Expression" with the value "[a-z]*". Below the "Names" section, there are two radio buttons: "All Classes" and "Specific Classes", with "Specific Classes" selected. Under the "Classes" section, there are three radio buttons: "All Severities", "Specific Severity Range", and "Specific Severity Value", with "Specific Severity Range" selected. Below these, there is a range slider with a minimum value of 499 and a maximum value of 1,000. At the bottom left, there is a "Labels" section with a plus sign icon, and at the bottom right, there is a right arrow icon.

Whenever multiple categories of filtering are defined, the subscription will be considered a match if and only if every category matches. In the example above, both the Name and Severity filter categories must match for the subscription to be considered matching.

String Filters

Four types of string filters exist. They can be used to match against FactoryTalk Names and the Classes that your FactoryTalk Tags are assigned to in FactoryTalk Alarm & Events. String filters are case-sensitive.

A close-up of a filter input field. It contains a dropdown menu labeled "Wild Card" and an asterisk (*) character.

The first and, easiest to use is the wildcard filter. Enter any string literal to match it exactly. Enter an asterisk to match any character any

number of times. Enter a question mark to match any character one time.

1. "Tank" will only match the string "Tank"
2. "*tank" will match any string that ends with "tank." E.g. "Watertank," "Brite tank."
3. "z?g" will match any string that begins with "z," ends with "g," and has one and only one letter between them. E.g. "zig," "zag."
- 4.



A screenshot of a search filter interface. It features a dropdown menu with the text "Regular Expression" and a small downward-pointing triangle to its right. To the right of the dropdown is a text input field containing the text "Tank?".

5.

Regular expressions can be used. Regular expressions are an advanced method of pattern matching. There are many resources available online that document their use.

Two screenshots of search filter interfaces. The first screenshot shows a dropdown menu with the text "Contains" and a small downward-pointing triangle to its right, followed by a text input field containing the text "overflow". The second screenshot shows a dropdown menu with the text "Does Not Contain" and a small downward-pointing triangle to its right, followed by a text input field containing the text "temp".

'Contains' will match any string that contains the substring you enter exactly. 'Does Not Contain' will match the opposite.

-  Click the 'Add' button to create a new string filter under the respective category (e.g. tagname) with default values.
-  Click the 'Delete' button to delete the selected string filter under the respective category.

Name

Whenever a Contains/Does Not Contain criterion is defined within this category, that criterion determines the category match. Whenever multiple criteria within this category are defined, the category will be considered a match if ANY Wildcard/Regular Expression criteria match.

Classes

FactoryTalk organizes its alarms into classes. Whenever a Contains/Does Not Contain criterion is defined within this category, that criterion determines the category match. Whenever multiple criteria within this category are defined, the category will be considered a match if ANY Wildcard/Regular Expression criteria match.

Groups

FactoryTalk organizes its alarms into groups. Whenever a Contains/Does Not Contain criterion is defined within this category, that criterion determines the category match. Whenever multiple criteria within this category are defined, the category will be considered a match if ANY Wildcard/Regular Expression criteria match.

Severity



Severity filters are supported for FactoryTalk Alarm & Events. They can be created to match an inclusive range.



They can also be created to match a specific Severity.



Labels

-  Click the 'Add' button to the right of 'Labels' to add new Labels to this Subscription. At runtime, alarms matching the Subscription will have the specified set of Labels attached.
-  Click the 'Navigate' button to navigate to the Labels workspace. If any changes have been made to the Subscriptions tab, they will persist until the user navigates back to the Subscriptions tab.
-  Click the 'Delete Label' button to delete the Label on the left.

Utilizers

This tab simply shows the user which Applications are currently using the Subscription that they are viewing. A Subscription cannot be deleted while in use.

FactoryTalk Applications



Connection

A screenshot of the 'Connection' configuration window. The window has three tabs: 'Connection', 'Routes', and 'Watchdogs'. The 'Connection' tab is active. The form contains the following fields and controls:

- Name: Brushy Creek MUD
- Description: (empty)
- Application Type: Local (selected), Network (selected)
- Application Name: BRUSHY_CREEK
- Username: WIN911
- Password: (masked with dots)
- Test Connection: (button)
- Language: English (United States) (dropdown menu)
- Subscribe to: Alarms (selected), Alarms and Events (selected)
- Good Quality Events Only: (checkbox, unchecked)

At the bottom right of the window, there are two circular icons: a save icon and a close icon.

Name

Enter a name for this connection. This name identifies this FTAE connection to WIN-911. It must be unique and should be meaningful and descriptive to the WIN-911 user.

Description

An optional text field for providing the user with context. Such information can contain location data (like Lift Station 22), or an explanation of the connection that conveys useful information to the user that is not provided elsewhere.

Application Type

Match the type of application to that of FactoryTalk. If it is a stand-alone system then select Local, but if FactoryTalk is running as a network application then Network should be selected.

Application Name

Match the FactoryTalk application name (as it appears within FactoryTalk).

Username/Password

Specify a FactoryTalk account user name and password for this application that has permission to access the FactoryTalk A&E Server. You may consider creating one especially one WIN-911.
Note: The password is encrypted.

Test Connection

Use this button to validate the Application, username, and password that was entered above. A success message indicates the connection parameters are correctly entered.

Language

Use the Language setting to match WIN-911 to the FTAE Application Language. Use the browse button to the right to select a different language.

Note: If the language setting is modified from the original (say, English-to-French), you may need to enter a French text string somewhere in your FactoryTalk Application before it will be selectable in WIN-911.

Subscribe to

Alarms: WIN-911 will only monitor actual FTAE Alarms and disregard Events.

Alarms and Events: WIN-911 will monitor both FTAE Alarms and Events.

Good Quality Events Only

Select this option to ignore bad or uncertain quality alarms.

Routes

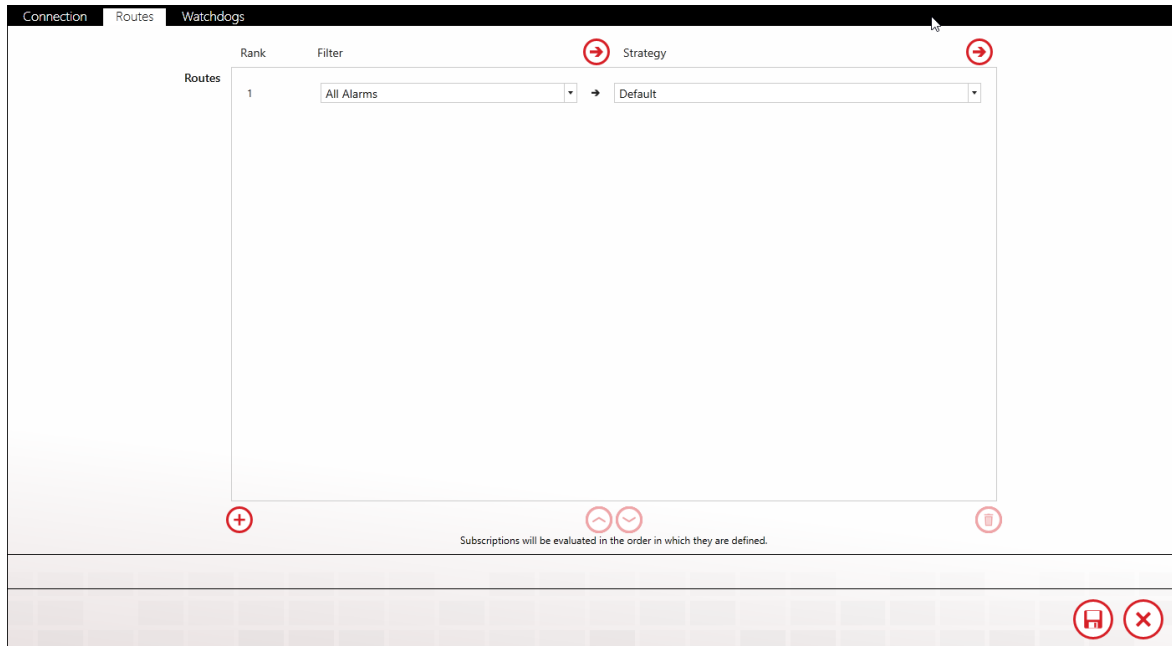

Routes forward alarms from a Subscription to a particular Strategy. This feature allows you to use Subscriptions across multiple Applications without redefining Subscription logic. A single alarm will match only one Subscription. Routes are evaluated in the order they are ranked.

See Subscriptions for a detailed explanation of their usage.



Click the 'Navigate' buttons to configure Subscriptions or Strategies.



Click the 'Add' button to add a new Route to the Application.



Click the 'Up' button to move the selected Route up a rank.



Click the 'Down' button to move the selected Route down a rank



Click the 'Delete' button to remove the selected Route from the Application.

Watchdog

Connection Routes Watchdogs

Name 



Description

Class

Timeout



Severity

Strategy 

Labels   

 Click the plus icon to add a new Watchdog.

 The Factory Talk A&E Application Name field is required.

FactoryTalk A&E supports watchdog timers which may be used to alert users when communications are lost between WIN-911 and FactoryTalk A&E. WIN-911 must monitor a changing alarm condition as opposed to a changing data value. The watchdog timer would then be set to a value greater than the interval of the reoccurring alarm condition.

To use a Watchdog, create a recurring alarm in FactoryTalk A&E with a Class name of "watchdog" (case sensitive).

Name

Enter a name for this watchdog.

Description

An optional text field for providing the user with context. Such information can contain location data (like Lift Station 22), or an explanation of the connection that conveys useful information to the user that is not provided elsewhere.

Class

Defaults to watchdog.

Timeout

Enter time (in seconds) from "5" to "900".

Severity

Select severity level the alarm will be assigned ("0" through "1000").

Strategy

Select defined Strategy (See "Notification" for information on setting up Strategies").

Labels

WIN-911 User Guide

Labels are optional attributes for organizing alarms in a logical manner. They can represent function, location, severity, or other such category that serves the project requirements.

System Platform Requirements

Supported Versions of System Platform

See the [WIN-911 Compatibility matrix](#).

Configuring System Platform for WIN-911

WIN-911 interfaces with System Platform using MXAccess and the Wonderware Alarm Toolkit. Each have their specific requirements for proper functionality. For MXAccess, this means WIN-911 must run on a deployed platform and an MXAccess license must be available. If you do not have an MXAccess license for System Platform, a license is available here, [MXAccess for SP](#).

WIN-911 requires the InTouch alarm provider to be enabled for each of the WinPlatforms you desire WIN-911 to monitor.

1. Open the ArchestrA IDE by connecting to your Galaxy.
2. Double-click on the WinPlatform on the Deployment tab.
3. Click the "Enable InTouch alarm provider". (See figure below)
4. Save and Close the WinPlatform.
5. If you are using multiple WinPlatforms, repeat steps 2 - 4 for the remaining WinPlatforms.

WIN-911 User Guide

InTouch alarm provider 

Enable InTouch alarm provider 

Register using "Galaxy_<Galaxy name>" instead of "Galaxy" 

Alarm areas (blank for all): 

Communication Failure Alarm Priority: 

[System Platform Subscriptions](#)

[System Platform Galaxies](#)

[System Platform Descriptions](#)

System Platform Subscriptions

WIN-911 provides System Platform with a list of common properties that describe the kinds of alarms that WIN-911 is interested in monitoring. This method is powerful because a single subscription can be defined to handle a multitude of possible alarm events. For example, you can say to System Platform, "send me all alarms with a priority of 95 or greater". Contrast this to defining a tag entry in WIN-911 for every tag you want WIN-911 to monitor. Subscriptions can be created to match against System Platform Areas, Object/Attributes, and Priorities. Subscriptions may be used across multiple servers to fetch existing alarms within. By default, a Subscription named 'All Alarms' is included.



Discussion: Subscription Logic

In order to filter the collection of events coming from the source, Subscriptions allow for the definition of filter Criteria, e.g. alarms with high severity belonging to class A or class B. Such Criteria fall into three Categories for System Platform, 1) Areas, 2) Objects/Attributes, and 3) Priorities. Each category has an "All" option, which, as the name implies, is unrestricted. Each category also has a "Specific" option, which puts restrictions on the parent category. These restrictions are defined by the criteria the WIN-911 user authors.

A "Specific Category" will have at least one criteria rule which places restrictions on what type of alarm will qualify for this subscription. So what does WIN-911 do when multiple criteria are assigned? The alarm candidate will have to match one or more rule to qualify in a specific category. It does not have to match them all. This is to say that the criteria are logically "OR"d together, because the alarm candidate must match one "OR" the other.

Categories themselves follow a slightly different logic. For an alarm candidate to match the particular subscription, the alarm must have a match for each category. This is to say that the categories are "AND"d together, since the alarm candidate must be a match for the Names "AND" Classes "AND" Severities. If the candidate does not have at least one match for the Classes category, the alarm does get credit for the Classes category and thus, is rejected by the subscription.

In short: the Areas, Objects/Attributes, and Priorities categories are be ANDed. The filter criteria under each category shall be ORed.

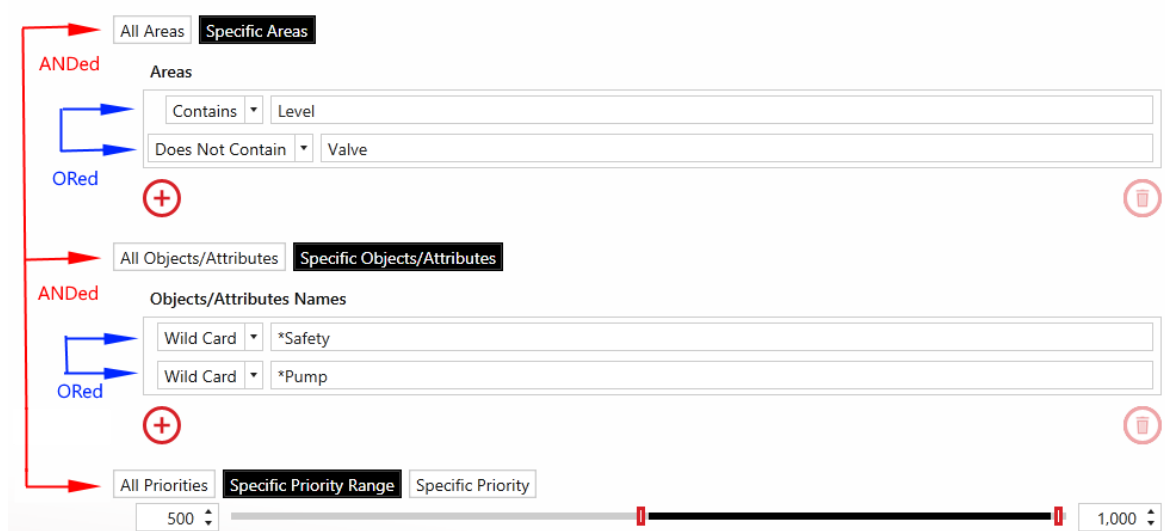

Navigate to the Subscriptions workspace under Alarming > System Platform > Subscriptions to get started.

Subscriptions

By default, Subscriptions will match all alarms when first created. Users can click the radio buttons to modify the filtering criteria. In the example below, specific Areas and Priorities are being targeted.

Name

All Areas **Specific Areas**

Areas

All Objects/Attributes Specific Objects/Attributes

All Priorities **Specific Priority Range** Specific Priority

Labels

Whenever multiple categories of filtering are defined, the subscription will be considered a match if and only if every category matches. In the example above, both the Area and Priority filter categories must match for the subscription to be considered matching

String Filters

Four types of string filters exist. They can be used to match against System Platform Areas and the Objects/Attributes that help define particular alarm events assigned to your Galaxies. String filters are case-sensitive.

WIN-911 User Guide

The first and, easiest to use is the wildcard filter. Enter any string literal to match it exactly. Enter an asterisk to match any character any number of times. Enter a question mark to match any character one time.

- "Tank" will only match the string "Tank"
- "*tank" will match any string that ends with "tank." E.g. "Watertank," and "Brite tank."
- "z?g" will match any string that begins with "z," ends with "g," and has one and only one letter between them. E.g. "zig," "zag."



Regular Expression ▼ Tank?

Regular expressions can be used. Regular expressions are an advanced method of pattern matching. There are many resources available online that document their use.

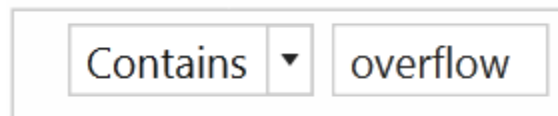

Contains ▼ overflow



Does Not Contain ▼ temp

'Contains' will match any string that contains the substring you enter exactly. 'Does Not Contain' will match the opposite.



Click the 'Add' button to create a new string filter under the respective category (e.g. Area) with default values.



Click the 'Delete' button to delete the selected string filter under the respective category.

Areas

System Platform organizes its alarms by areas, which is a hierarchical structure that begins with a root area(s). These areas can contain child areas called descendants. Descendants can also have their own descendants and so on. WIN-911 queries alarms based on their areas. When an area is queried, its immediate alarms and those of its descendants are fetched. **The alarm message will list the immediate area for that alarm, even if that area is a descendant of the actual area being queried.**

Whenever multiple criteria within this category are defined, the category will be considered a match if ANY filter criterion specified as Contains/Does Not Contain matches or if ALL Wildcard/Regular Expression criteria match.

Objects/Attributes

Object instances are the specific devices in your environment (like a simple valve to a complex reactor) that are derived from templates in the IDE.

Attributes are data values that describe various aspects of their associated object.

Whenever multiple criteria within this category are defined, the category will be considered a match if ANY filter criterion specified as Contains/Does Not Contain matches or if ALL Wildcard/Regular Expression criteria match.

Priority Filters



Priority filters are supported for System Platform. They can be created to match an inclusive range.

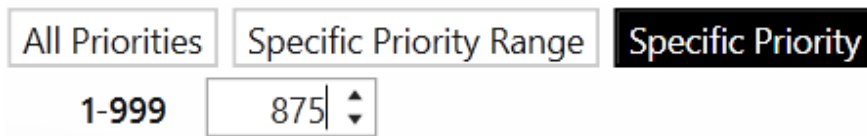

They can also be created to match a specific Priority.



Labels

-  Click the 'Add' button to the right of 'Labels' to add new Labels to this Subscription. At runtime, alarms matching the Subscription will have the specified set of Labels attached.
-  Click the 'Navigate' button to navigate to the Labels workspace. If any changes have been made to the Subscriptions tab, they will persist until the user navigates back to the Subscriptions tab.
-  Click the 'Delete Label' button to delete the Label on the left.

Utilizers

This tab simply shows the user which Galaxies are currently using the Subscription they are viewing. A Subscription cannot be deleted while in use.

[System Platform Requirements](#)

System Platform Subscriptions

[System Platform Galaxies](#)

[System Platform Descriptions](#)

System Platform Galaxies



Connection Details

Name

This setting should match the name of Galaxy name defined in the Archestra IDE.

Enable Galaxy_<galaxy> Query Syntax

This selection should match the setting in your WinPlatform, as defined in the General tab (pictured above) of WinPlatform settings in the Archestra IDE.

Ack Message Method

In order to meet your specific operational needs, WIN-911 provides three options for delivering an acknowledgement message to System Platform. These options affect the way the alarm comment appears after the acknowledgement executes.

- Append Alarm Comment with Ack Message
- Replace Alarm Comment with Ack Message
- Use Alarm Comment as Ack Message

Enable Authentication

System Platform can be configured to require authentication from clients (like WIN-911) that wish to connect. If the Galaxy is configured with this requirement you will need to create credentials (Username and Password) that WIN-911 can use. Check the provided box and enter the credentials in the respective text-entry fields.

Ignore COMM Alarms

WIN-911 User Guide

With this setting selected, WIN-911 will not dispatch any COMM alarms associated with this Galaxy.

Areas

System Platform organizes its alarms by areas, which is a hierarchical structure that begins with a root area(s). These areas can contain child areas called descendants. Descendants can also have their own descendants and so on. WIN-911 queries alarms based on their areas. When an area is queried, its immediate alarms and those of its descendants are fetched.



Use the Enter Area button to enter the name of the desired area.



To delete an area, highlight it and click the Delete Area button.

Subscription Routes

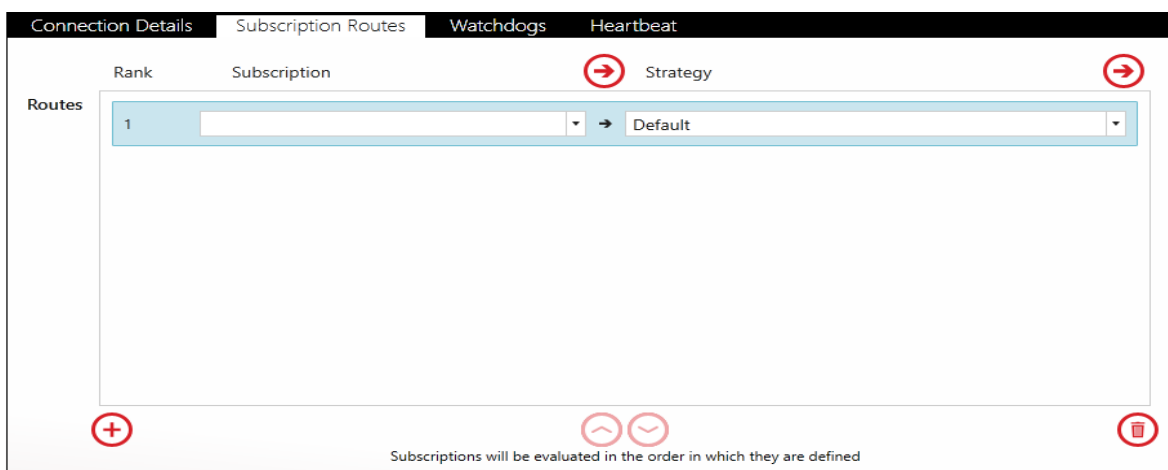

Subscription Routes forward alarms from a Subscription to a particular Strategy. Routes are evaluated in the order they are ranked. An alarm

event may match several subscriptions but will be handled by the first ranking subscription route defined by this stack. If an alarm event matches the subscriptions in routes 2 and 3, then route 2 will dispatch the alarm message and route 3 will not ever see this event.



Click the 'Navigate' buttons to configure Subscriptions or Strategies.



Click the 'Add' button to add a new Route to the Galaxy.



Click the 'Up' button to move the selected Route up a rank.



Click the 'Down' button to move the selected Route down a rank.



Click the 'Delete' button to remove the selected Route from the Galaxy.

Watchdogs

WIN-911 provides Watchdogs as a method for ensuring the functionality and connectivity of devices and programs that WIN-911 monitors for alarm activity. This is a unique type of alarm engine that is independent of other software because it exists solely within WIN-911 and is not part of an integrated data source's alarm engine. Rather, its purpose is to monitor health and availability of the data source itself. This is accomplished by configuring WIN-911 to monitor a changing alarm event over a period of time, like a heartbeat. With a Watchdog alarm, the System Platform's alarm condition is not dispatched by WIN-911, but rather its failure to change within the prescribed time period.

WIN-911 User Guide

Connection Details Subscription Routes **Watchdogs** Heartbeat

Click the Add button below to define a new Watchdog Alarm. These alarms will become active when there is no alarm activity from the specified device in your Galaxy connection for the amount of time specified.

Name: My Watchdog

Description: is not responding

Area: Perseus

Device Name: PLC5

Timeout: 90 sec

Strategy: Default

Severity: 500

Labels: +

Name

Enter a unique, user friendly name to identify this watchdog configuration. This is the name that will be most prominently displayed in the alarm notification. This field is required.

Description

The description field is an optional field that can provide the user with additional information concerning the alarm.

Area

Enter the Galaxy Area that this Watchdog is associated with. This field is required.

Device Name

The full syntax of the alarm (Object.Attribute) in your Galaxy that the Watchdog is intended to monitor. In the following example the object name is *PLC5* and the Attribute name is *RAMP001*. Thus, you would enter *PLC5.RAMP001* for your device name. This field is required.

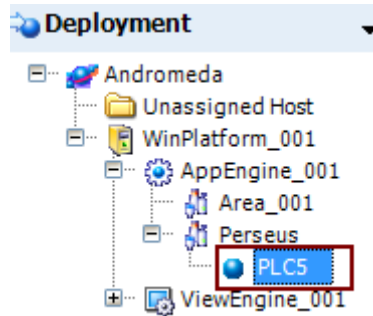

Object Name

The image shows a configuration window for an attribute named 'RAMP001'. The 'Name' field is 'RAMP001'. The 'Data type' is 'Integer'. The 'Writeability' is 'User writeable'. The 'Initial value' is '0'. Under 'Available features', 'Limit alarms' is checked. Below this, there is a table for 'Limit alarms' with columns for 'Limit', 'Priority', and 'Alarm message'. There are four rows for 'HiHi', 'Hi', 'Lo', and 'LoLo' limits, each with a checked checkbox, a numerical limit value, a priority of 500, and an alarm message field.

	Limit	Priority	Alarm message
<input checked="" type="checkbox"/> HiHi	90.0	500	me.RAMP001.Description ...
<input checked="" type="checkbox"/> Hi	75.0	500	me.RAMP001.Description ...
<input checked="" type="checkbox"/> Lo	25.0	500	me.RAMP001.Description ...
<input checked="" type="checkbox"/> LoLo	10.0	500	me.RAMP001.Description ...

Alarm deadband: 0.0
Time deadband: 00:00:00.0000000

Attribute Name

Timeout

The time span during which WIN-911 expects the alarm condition to change for this tag.

Strategy

The Strategy to execute when the Watchdog alarm activates.



Click the 'Navigate' button to the right of the 'Strategy' combo box to go to the Strategies workspace in order to configure Strategies.

Severity

The Severity assigned to this Watchdog alarm.

Labels

The Labels assigned to this Watchdog alarm.



Click the 'Add' button to the right of 'Labels' to attach Labels to the Watchdog.



Click the 'Navigate' button to the right of the Label collection to configure Labels in the Labels workspace.



Click the 'delete' button at the top-right corner to remove the Watchdog from the Galaxy.



Click the 'X' button to the right of an attached Label to remove it from the Watchdog.

Heartbeat

The screenshot shows a configuration interface for a 'Heartbeat' function. The top navigation bar includes 'Project Details', 'Subscription Routes', 'Health', 'Watchdogs', and 'Heartbeat'. The 'Heartbeat' section is expanded, showing a 'Project Connection' area with the following fields:

- Description:** WIN-911 is unable to communicate with your InTouch Edge HMI Project. Please check that your project is running and that the server is available on the local network.
- Strategy:** Default
- Severity:** 500
- Labels:** (indicated by a red plus icon)

At the bottom right of the configuration area, there are two red circular icons: one with a house symbol and one with an 'X' symbol.

WIN-911 can indicate its operational status by writing a periodically changing value to an integer attribute in your Galaxy. We call this function a 'Heartbeat' because it provides a 'vital-sign' to your Galaxy, allowing for corrective action to be taken.

The Heartbeat takes the form of an Integer value that ramps from 0 to 9 on a period of your choosing. After the value reaches 9 it resets to one, and the process is repeated, ad infinitum. If the attribute fails to update within the specified time, you can assume that WIN-911 is in

an impaired state and no longer able to receive alarm event information.

Note: the heartbeat is the only WIN-911 function that will write data to System Platform.

To setup a heartbeat:

1. Create an attribute in your Archestra IDE > Device that is a type of Integer which allows input.
2. Create QuickScript that monitors the attribute value and triggers recovery procedures/methods when the heartbeat fails.
3. WIN-911 Workspace > Alarming > System Platform > Galaxy > Heartbeat > Enable Heartbeat.
4. Enter the name of the attribute you created in step 1.
5. Set the heartbeat update rate (in Minutes) with the *Write Interval* combo-box.
6. Save your edits in the WIN-911 Workspace.

The Heartbeat Suspension feature is provided as a means of forcing a heartbeat failure in the event of a '*partial communications failure*' between your System Platform Application and WIN-911. WIN-911's System Platform Data Source leverages two Wonderware Toolkits. The MxAccess toolkit provides System Platform with information from WIN-911, like alarm acknowledgment requests and heartbeat data. The '*Alarm Toolkit*' provides System Platform alarm information to WIN-911. If the Alarm Toolkit stops responding while MxAccess remains, your Application will still be receiving a healthy heartbeat from WIN-911 even while WIN-911 is not receiving alarm events.

To setup heartbeat suspension:

1. Create a separate attribute within your Galaxy that allows input. You can use a Discrete, for example.
2. Set the attribute with an alarm condition that cycles in and out of alarm on a periodic basis. In our Discrete example, you can set the alarm state for 'On.'

3. You will need to determine what amount of time you wish to check WIN-911 for alarm coverage. Let's say every 5 minutes in this scenario.
4. You will need to provide a way to write data to the attribute you created in step 1. You can use QuickScript, or another source of data like OPC. In this example, this data will need to be toggled at a rate that is less than the desired timeout, say every four minutes.
5. WIN-911 Workspace > Alarming > System Platform > Galaxies > Heartbeat > Enable Heartbeat Suspension.
6. Enter the name of the attribute you created in step 1.
7. Set the suspension timeout (in Minutes) with the *Timeout* combo box.
8. Save your edits in the WIN-911 Workspace.

This will result in a 'dummy-alarm' that WIN-911 will be advised of every four minutes. As long as this cycle continues, the heartbeat will continue to update, and you can assume that WIN-911 is alive and capable of carrying out its duties. If the suspension timeout elapses without a new alarm being detected, WIN-911 will stop the heartbeat.

[System Platform Requirements](#)

[System Platform Subscriptions](#)

[System Platform Descriptions](#)

System Platform Descriptions



System Platform Descriptions provides the user with an optional tool for enhancing information conveyed to the alarm notification recipient. By default, alarm descriptions are provided by System Platform at the time of the alarm event. Use these settings to replace the System Platform descriptions in the WIN-911 alarm notifications.

Alarm Name	<input type="text" value="Tank_001.Pressure.Dev.Major"/>
Condition Description	<input type="text" value="Major Deviation Alarm"/>
Object/Attribute Description	<input type="text" value="Pressure of Tank #1"/>

WIN-911 > Alarming > System Platform > Descriptions

Alarm Name

Enter the Tagname (Object.Attribute) exactly as it appears in the Archestra IDE. In the example pictured below, you would enter *Tank_001.Pressure.Dev.Major*.

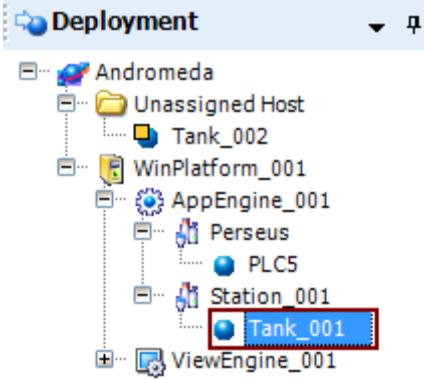

Object

A screenshot of an attribute configuration form. The 'Name' field is 'Pressure.Dev.Major'. The 'Description' field contains 'the attribute is'. The 'Data type' is set to 'Double' with an 'Array' checkbox. The 'Writeability' is set to 'User writeable'. The 'Initial value' is '0.0' and the 'Eng units' field is empty. There are lock and shield icons on the right side of the form.

Attribute

Condition Description

Enter a custom description to use in place of the System Platform Alarm message. In the example pictured below, "me.Pressure.Dev.Major.Description" would be replaced in the notification message with what is entered here. This will not affect anything in System Platform.

A screenshot of a 'Deviation alarms' configuration window. It features a table with columns for 'Tolerance' and 'Priority', and an 'Alarm message' column. The 'Alarm message' column contains 'me.Pressure.Dev.Major.Description'. Below the table are input fields for 'Target' (50.0), 'Deviation deadband' (0.0), and 'Settling period' (00:00:30.0000000).

	Tolerance	Priority	Alarm message
<input checked="" type="checkbox"/> Minor	10.0	500	me.Pressure.Dev.Major.Description ...
<input checked="" type="checkbox"/> Major	15.0	500	me.Pressure.Dev.Major.Description ...

Target: 50.0
Deviation deadband: 0.0
Settling period: 00:00:30.0000000

Alarm Message

Object/Attribute Description

Enter a custom description of the Object/Attribute to be used in place of what is configured in the Archestra IDE. In the example pictured below, "the object is out of tolerance" would be replaced in the notification message with what is entered here. This will not affect anything in System Platform.

Name: Pressure.Dev.Major

Description: the attribute is

Data type: Double Array

Writeability: User writeable

Initial value: 0.0 Eng units:

Description

[System Platform Requirements](#)

[System Platform Subscriptions](#)

[System Platform Galaxies](#)

InTouch Subscriptions

WIN-911 provides InTouch with a list of common properties that describe the kinds of alarms that WIN-911 is interested in monitoring.

This method is powerful because a single subscription can be defined to handle a multitude of possible alarm events. For example, you can say to InTouch, "send me all alarms with a priority of 95 or greater".

Contrast this to defining a tag entry in WIN-911 for every tag you want WIN-911 to monitor. Subscriptions can be created to match against InTouch Tagnames, Groups, and Priorities. Subscriptions may be used across multiple servers to fetch existing alarms within. By default, a Subscription named 'All Alarms' is included.



Discussion: Subscription Logic

In order to filter the collection of events coming from the source, Subscriptions allow for the definition of filter Criteria, e.g. alarms with high severity belonging to class A or class B. Such Criteria fall into three Categories for InTouch, 1) Tagnames, 2) Groups, and 3) Priorities. Each category has an "All" option, which, as the name implies, is unrestricted. Each category also has a "Specific" option, which puts restrictions on the parent category. These restrictions are defined by the criteria the WIN-911 user authors.

A "Specific Category" will have at least one criteria rule which places restrictions on what type of alarm will qualify for this subscription. So what does WIN-911 do when multiple criteria are assigned? The alarm candidate will have to match one or more rule to qualify in a specific category. It does not have to match them all. This is to say that the criteria are logically "OR"d together, because the alarm candidate must match one "OR" the other.

Categories themselves follow a slightly different logic. For an alarm candidate to match the particular subscription, the alarm must have a match for each category. This is to say that the categories are "AND"d together, since the alarm candidate must be a match for the Tagnames "AND" Groups "AND" Priorities. If the candidate does not have at least one match for the Groups category, the alarm does get credit for the Groups category and thus, is rejected by the subscription.

In short: the Tagnames, Groups, and Priorities categories are be ANDed. The filter criteria under each category shall be ORed.

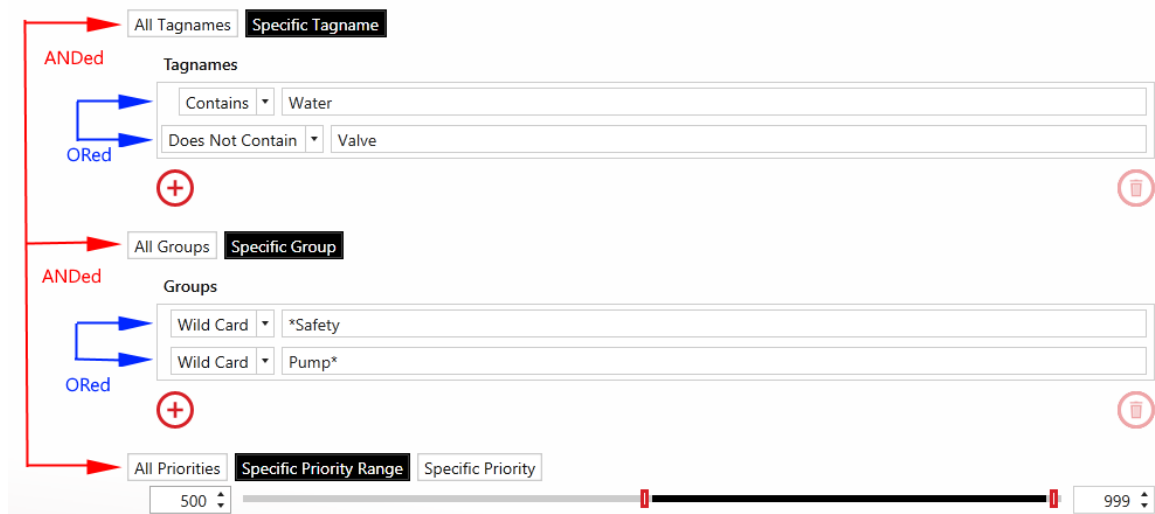

Navigate to the Subscription workspace under Alarming > InTouch > Subscriptions to get started.

Subscription

By default, Subscriptions will match all alarms when first created.

Users can click the radio buttons to modify the filtering criteria. In the example below, specific Tagnames and Priorities are being targeted.

Name

All Tagnames
 Specific Tagname

Tagnames

*
 \${a-z}*

All Groups
 Specific Group

All Priorities
 Specific Priority Range
 Specific Priority

Labels

Whenever multiple categories of filtering are defined, the subscription will be considered a match if and only if every category matches. In the example above, both the Tagname and Priority filter categories must match for the subscription to be considered matching.

String Filters

Four types of string filters exist. They can be used to match against InTouch Tagnames and the Groups that your InTouch Tags are assigned to in InTouch. String filters are case-sensitive.

▼

The first and, easiest to use is the wildcard filter. Enter any string literal to match it

WIN-911 User Guide

exactly. Enter an asterisk to match any character any number of times. Enter a question mark to match any character one time.

6. "Tank" will only match the string "Tank"
7. "*tank" will match any string that ends with "tank." E.g. "Watertank," "Brite tank."
8. "z?g" will match any string that begins with "z," ends with "g," and has one and only one letter between them. E.g. "zig," "zag."



Regular Expression ▼ Tank?

Regular expressions can be used. Regular expressions are an advanced method of pattern matching. There are many resources available online that document their use.

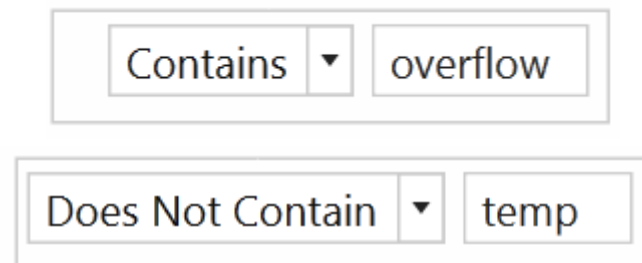

Contains ▼ overflow

Does Not Contain ▼ temp

'Contains' will match any string that contains the substring you enter exactly. 'Does Not Contain' will match the opposite.



Click the 'Add' button to create a new string filter under the respective category (e.g. tagname) with default values.



Click the 'Delete' button to delete the selected string filter under the respective category.

Tagnames

Tagnames reflect the name assigned to each tag within the InTouch product. Whenever multiple criteria within this category are defined, the category will be considered a match if ANY filter criterion specified as Contains/Does Not Contain matches or if ALL Wildcard/Regular Expression criteria match.

Groups

InTouch organizes its alarms into groups, which are organized in a hierarchical structure that begins with the "\$System" Group. Whenever multiple criteria within this category are defined, the category will be considered a match if ANY filter criterion specified as Contains/Does Not Contain matches or if ALL Wildcard/Regular Expression criteria match.

Priority Filters

Priority filters are supported for InTouch. They can be created to match an inclusive range.



They can also be created to match a specific Priority.



Labels



Click the 'Add' button to the right of 'Labels' to add new Labels to this Subscription. At runtime, alarms matching the Subscription will have the specified set of Labels attached.



Click the 'Navigate' button to navigate to the Labels workspace. If any changes have been made to the Subscriptions tab, they will persist until the user navigates back to the Subscriptions tab.



Click the 'Delete Label' button to delete the Label on the left.

Utilizers



This tab simply shows the user which Applications are currently using the Subscription that they are viewing. A Subscription cannot be deleted while in use.

InTouch Applications



Application

Specify the connection criteria in the Applications tab.

Application	Watchdogs	Subscription Routes	Heartbeat
Name	InTouch_App		
Node Name	localhost		⋮
	<input type="checkbox"/> Specify SuiteLink Node Name		
 			

Name

Enter the name of your InTouch Application.

Node Name

WIN-911 will connect to the single running Application on this specified Node. If your Application is running on the local machine, use "localhost." Otherwise, enter its host name or IP address. The IP address should be static; if using a dynamic address, the user will have to update the address each time the IP changes.



You may browse for machines by clicking the Browse button.

SuiteLink Node Name

In the event that your InTouch Application network is configured such that the SuiteLink node is separate from the WindowViewer node, you will have to provide WIN-911 with the location of the SuiteLink node. Enter the node in the provided text box after selecting the 'Specify SuiteLink Node Name' check box. There are two formats to choose from: 1) RDShostname or 2) RDShostname:clientIPAddress.

Watchdogs

Application
Watchdogs
Subscription Routes
Heartbeat



Click the Add button below to define a new Watchdog Alarm. These alarms will become active when there is no alarm activity from the specified tag in your InTouch application for the amount of time specified.

Name 



Description

Tagname



Timeout 

Strategy  

Severity 

Labels  







WIN-911's InTouch Source supports Watchdog alarms. They monitor a changing value (or changing alarm state) within your Application. If an update is not received within the specified Timeout period, the watchdog will become an active alarm. Watchdogs can thus be used to monitor the operation and connectivity of critical devices.

Watchdogs have a configurable Severity from 0 – 1000 inclusively and may also have Labels attached. Watchdogs are associated with a Strategy for alarm escalation.

 Click the 'Add' button at the bottom of the Watchdog collection to add a new Watchdog configuration to the Application.

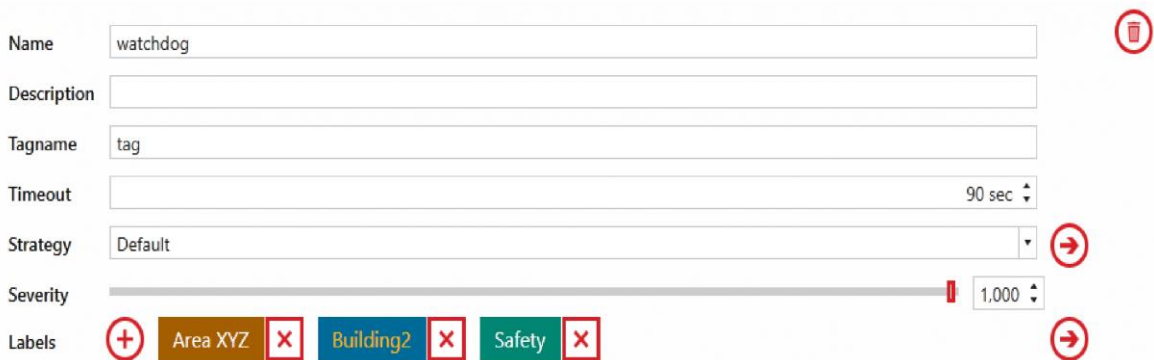
Each Watchdog will have the following configuration:



The screenshot shows a configuration form for a Watchdog. The fields are: Name (text input with 'watchdog'), Description (text input), Tagname (text input with 'tag'), Timeout (text input with '90 sec' and a dropdown arrow), Strategy (dropdown menu with 'Default' and a right-pointing arrow icon), Severity (slider bar with '1,000' and a dropdown arrow), and Labels (a row of three colored buttons: 'Area XYZ' (orange), 'Building2' (blue), and 'Safety' (green), each with a red 'X' icon and a red circle with a plus sign icon to its left). A red circle with a trash icon is located to the right of the Name field.

* indicates required fields.

***Name:** the friendly name for this Watchdog configuration. Provide a user-friendly name here, as this is the name that will be most prominently displayed in alarm notifications.

Description: a description for this configuration.

***Tagname:** InTouch Tag that WIN-911 will monitor for a changing value (or changing alarm state). This field must match the name of the tag as it is configured in InTouch.





***Timeout:** the elapsed time (seconds) when WIN-911 will periodically check the tag for a changed value.

***Strategy:** the strategy to execute when the Watchdog alarm activates.

 Click the 'Navigate' button to the right of the 'Strategy' combo box to go to the Strategies workspace in order to configure Strategies.

***Severity:** the severity associated with this Watchdog alarm.

Labels: the list of Labels associated with this Watchdog.

-  Click the 'Add' button to the right of 'Labels' to attach Labels to the Watchdog.
-  Click the 'Navigate' button to the right of the Label collection to configure Labels in the Labels workspace.
-  Click the 'delete' button at the top-right corner to remove the Watchdog from the Application.
-  Click the 'X' button to the right of an attached Label to remove it from the Watchdog.

Subscription Routes

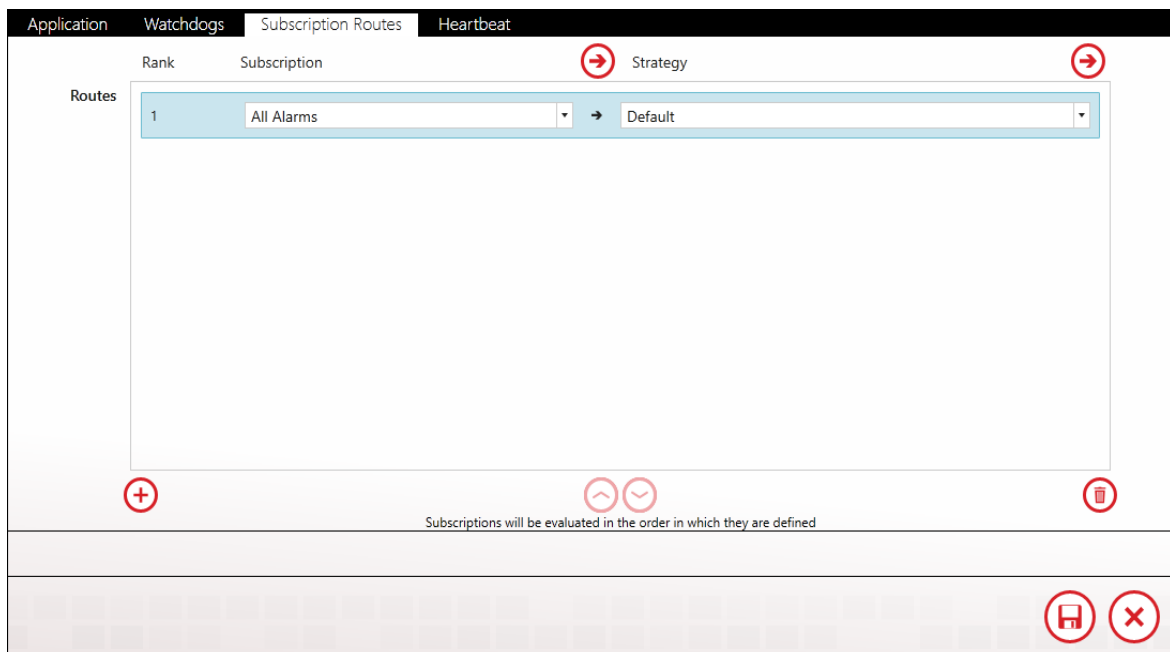

Subscription Routes forward alarms from a Subscription to a particular Strategy. This feature allows you to use Subscriptions across multiple Applications without redefining Subscription logic. A single alarm will

WIN-911 User Guide

match only one Subscription. Routes are evaluated in the order they are ranked.

Subscriptions are the preferred method of configuration for fetching alarms from InTouch Applications. See the [Subscriptions](#) for a detailed explanation of their usage.



Click the 'Navigate' buttons to configure Subscriptions or Strategies.



Click the 'Add' button to add a new Route to the Application.



Click the 'Up' button to move the selected Route up a rank.



Click the 'Down' button to move the selected Route down a rank.



Click the 'Delete' button to remove the selected Route from the Application.

Heartbeat

WIN-911 can indicate its operational status by writing a periodically changing value to a tag in your InTouch Tagname Dictionary. We call this function a 'Heartbeat' because it provides a 'vital-sign' to your Application, allowing for corrective action to be taken.

The Heartbeat takes the form of an Integer value that ramps from 0 to 9 on a period of your choosing. After the value reaches 9 it resets to

one, and the process is repeated ad infinitum. If the tag fails to update within the specified time, you can assume that WIN-911 is in an impaired state and no longer able to receive alarm event information.

Note: the heartbeat is the only WIN-911 function that will write data to InTouch.

To setup a heartbeat:

1. Create a tag in your InTouch - Windowmaker > Tools > Tagname Dictionary that is a type of Integer which allows input (i.e. Memory Integer).
2. Create InTouch QuickScript that monitors the Tag value and triggers recovery procedures/methods when the heartbeat fails.
3. WIN-911 Workspace > Alarming > InTouch > Applications > Heartbeat > Enable Heartbeat.
4. Enter the Tagname of the InTouch Tag you created in step 1.
5. Set the heartbeat update rate (in Minutes) with the *Write Interval* combo-box.
6. Save your edits in the WIN-911 Workspace.

The Heartbeat Suspension feature is provided as a means of forcing a heartbeat failure in the event of a '*partial communications failure*' between your InTouch Application and WIN-911. WIN-911's InTouch Data Source leverages two Wonderware Toolkits. The '*SuiteLink toolkit*' provides InTouch with data from WIN-911, like alarm acknowledgment requests and heartbeat data. The '*Alarm Toolkit*' provides InTouch alarm information to WIN-911. If the Alarm Toolkit stops responding while SuiteLink remains, your InTouch Application will still be receiving a healthy heartbeat from WIN-911 even while WIN-911 is not receiving alarm events.

To setup heartbeat suspension:

1. Create a separate tag in your InTouch - Windowmaker > Tools > Tagname Dictionary that allows input. You can use a Memory Discrete, for example.
2. Set that tag with an alarm condition that cycles in and out of alarm on a periodic basis. In our Memory Discrete example, you can set the alarm state for 'On.'

WIN-911 User Guide

3. You will need to determine what amount of time you wish to check WIN-911 for alarm coverage. Let's say every 5 minutes in this scenario.
4. You will need to provide a way to write data to the tag you created in step 1. You can use InTouch QuickScript, or another source of data like OPC. In this example, the data will need to be toggled at a rate that is less than the desired timeout, say every four minutes.
5. WIN-911 Workspace > Alarming > InTouch > Applications > Heartbeat >Enable Heartbeat Suspension.
6. Enter the tagname you created in step 1.
7. Set the suspension timeout (in Minutes) with the Timeout combo box.
8. Save your edits in the WIN-911 Workspace.

This will result in a 'dummy-alarm' that WIN-911 will be advised of every four minutes. As long as this cycle continues, the heartbeat will continue to update and you can assume that WIN-911 is alive and capable of carrying out its duties. If the suspension timeout elapses without a new alarm being detected, WIN-911 will stop the heartbeat.

InTouch Tags

WIN-911 supports Subscriptions for InTouch alarms, which provide an easy to configure means of subscribing to alarms. As they require less maintenance, we recommend you use Subscriptions over tag definitions. You must, however, use Tag definitions to support reporting.

WIN-911 can connect to all types of InTouch Tags. Alarms are supported for both Discrete and Analog Tags. Message Tag support is included for reporting purposes.

Tags may be imported from an InTouch DBDump. They may also be created manually. When manually creating a Tag in WIN-911, you must first specify the Tag type. Once the Tag type has been set, it cannot be changed. If you wish to change the Tag type, simply delete the Tag and recreate it as the desired type.

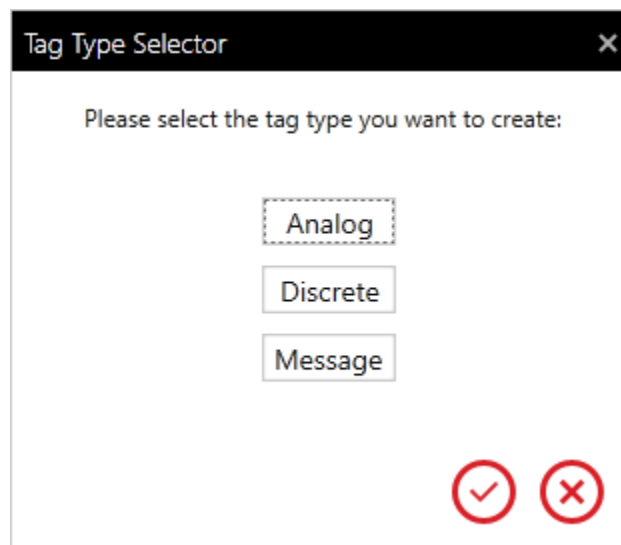

General

The screenshot displays the WIN-911 Alarming/InTouch/Tags configuration window. The browser address bar shows the URL `http://desktop-rbtp4dh/WIN/Alarming/InTouch/Tags`. The main navigation bar includes **WIN-911** and tabs for Contact, Notification, **Alarming**, Reporting, and System. Below this, there are links for OPC DA, RtOI, **InTouch**, CIMPPLICITY, FactoryTalk A&E, iFIX, Labels, Subscriptions, Applications, **Tags**, and Import. The main content area is titled 'Tag Alarm' and contains the following fields:

- Name:** Water Tank Level
- Tagname:** TankLevel
- Description:** Use InTouch Tag Comment (with a 'Specify' button below it)
- Application:** My Application (with a right-pointing arrow icon)
- Labels:** (with a plus sign icon and a right-pointing arrow icon)

At the bottom right of the form, there are two red circular icons: a Save icon and a Cancel icon.

Name

The Name field serves as a unique identifier for InTouch Tags. This field is user defined and may be independent of the InTouch Tagname. Provide a user-friendly name here, as this is the name that will be most prominently displayed in alarm notifications.

Tagname

The Tagname field must match the tagname of the Tag as it appears within InTouch. Tagnames must be unique within an Application. Comparison is case-sensitive.

Application

Select the Application which hosts the Tag you've created.

Labels

Attach Labels to your Tag as a means of organization. See the [Labels](#) for more information regarding Labels.

Alarm

WIN-911 supports four types of alarms for tags: level, rate of change, deviation and discrete. Level, rate of change, and deviation alarms belong to analog Tags, and discrete alarms belong to discrete Tags.

For the sake of brevity, only the discrete alarm condition will be discussed. For analog tags: level alarms have four conditions: HiHi, Hi, Lo, and LoLo; deviation alarms have two: Major Deviation and Minor Deviation; rate of change alarms have only one condition, just like discrete alarms. Each alarm condition has the following configuration:

WIN-911 User Guide

The screenshot shows a configuration panel for an alarm. At the top, there is a 'Strategy' dropdown menu set to 'Default', with a red circular arrow icon to its right. Below this is a checkbox labeled 'Discrete Enabled' which is currently unchecked. Underneath the checkbox is a 'Description' text input field with the placeholder text 'Enter alarm comment to override InTouch Alarm comment'. At the bottom, there is a 'Labels' section with a red circular plus icon to its left, a green button labeled 'Safety', and a red circular minus icon to its right. A red circular arrow icon is also present to the right of the 'Labels' section.

Strategy

Select the Strategy that will dispatch this alarm.



Click the 'Navigate' button on the right to configure Strategies in the Strategies workspace.

'Alarm' Enabled

Enable the alarm by checking this box. Any alarm may be independently disabled. For instance, it is possible to define an analog tag with a rate of change alarm, while the level alarm is disabled.

Description

You may provide an alarm description to add additional context to your alarms. If you leave the description field blank, your alarm description will match your InTouch alarm comment.

Labels may be attached to any alarm condition. See the [Labels](#) for more information regarding labels.



Click the 'Add' button to attach Labels to the associated condition.



Click the 'X' button to delete the Label to the left.



Click the 'Navigate' button on the right to configure Labels in the Labels workspace.

InTouch Import



Select Application

Select the application you would like to import tags and alarms to. If you haven't yet created an application, use the arrow to navigate to the application workspace to create a new one.

InTouch App 



Please upload a CSV file. To obtain a CSV file, perform a DBDump in InTouch.

Before proceeding, you must have an InTouch Application defined.



Click the Navigation button to go to the Applications workspace and configure an InTouch Application to WIN-911.

You will also need to upload a CSV file that contains Tag definitions.

DBDump

To perform a DBDump in InTouch, start the InTouch Application Manager (by default located at '**C:\Program Files (x86)\Wonderware\InTouch**') and select one of your defined Applications.

Name	Path	Resolution	Versi...	Application ...	Applic...	Date Modified	Description
Demo Application 1024 X 768	c:\programdata\intouchdemos\demoapp1...	1024 x 768	11.1....	Stand Alone	323	12/7/2015 1...	Demo Application of "Now famous" InTou...
Demo Application 1280 x 1024	c:\programdata\intouchdemos\demoapp1...	1280 x 1024	11.1....	Stand Alone	335	12/7/2015 1...	Demo Application of "Now famous" InTou...
Demo Application 800 X 600	c:\programdata\intouchdemos\demoapp1...	800 x 600	11.1....	Stand Alone	257	12/7/2015 1...	Demo Application of "Now famous" InTou...
New InTouch application	c:\users\public\wonderware\intouch appli...	1920 x 1080	11.1....	Modern	10	8/17/2016 9...	New InTouch application

After that, go to 'File' -> 'DBDump'. Make sure you have an Application selected, or this option will be disabled. You will see the following dialog:

CSV File to Dump To:

Application directory: c:\...\newapp OK

Name of CSV Dump file: DB.CSV Cancel

Files: ANDRE.CSV
andre2.CSV

Directories: [..]
[Symbols]

Drives: [-a-]
[-c-]
[-d-]

Group output by types

Hit 'OK', then the dump file will be saved under **'C:\Users\Public\Wonderware\Intouch Applications\[Name of selected Application's directory]*'**.

*Refers to the directory name you specified when you first created the Application:

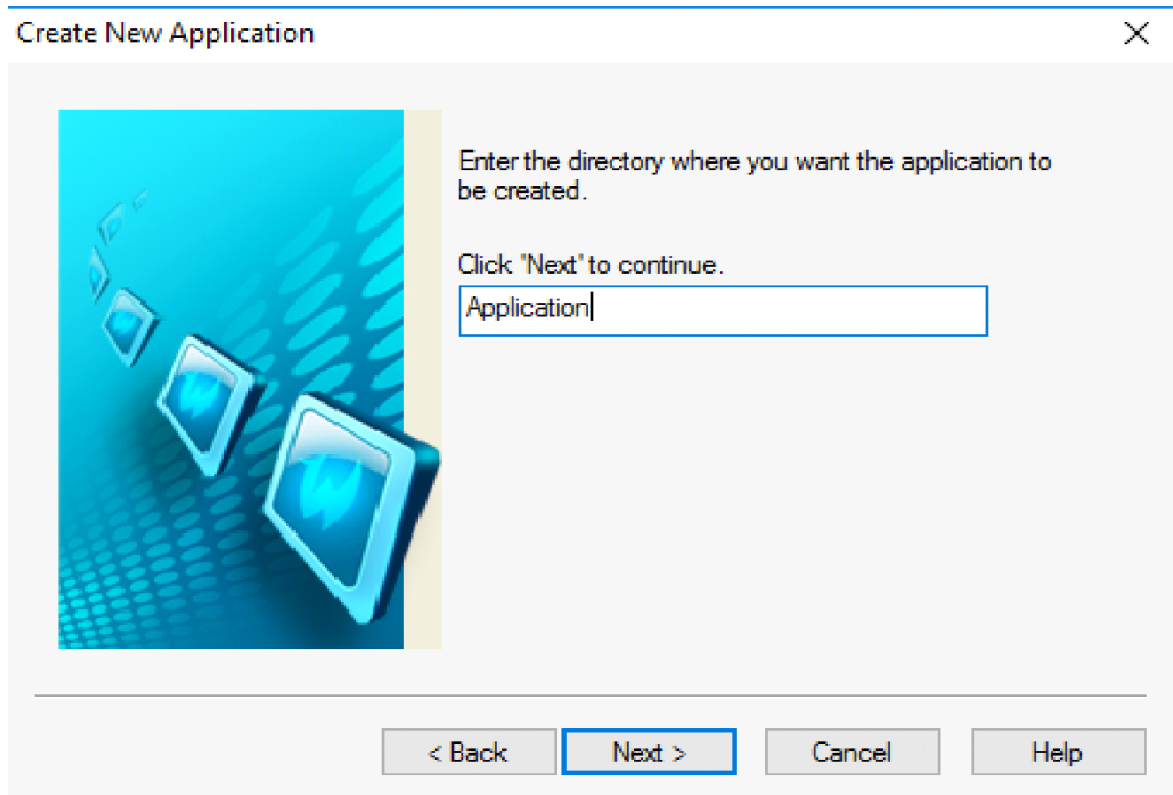

Back on the Import workspace, click on this Upload button to open File Explorer. Navigate to '**C:\Users\Public\Wonderware\Intouch Applications\[Name of selected Application's directory]**', then open the CSV dump file you just created. Once the file is uploaded, the workspace will tell you how many Tags are defined in the file.

If any of the Tags have already been configured under the selected Application, the workspace will let you know about this, too. Tag definitions must be unique within Applications; the same Tagname can be defined multiple times across your entire InTouch system, as long as each definition is inside a different Application.



If the CSV file contains at least one Tag to import to the selected Application, the Next button will

enable. Click on it to enter the Tag selection phase.

Select Tags

The available Tags will appear on the left grid:

Available Tags

Drag a column header and drop it here to group by that column

	Tagname ▼	Type ▼	Group ▼	Number of Alarms ▼
	analog2	Analog	\$System	7
▶	discrete1	Discrete	\$System	0
	FacePD	Analog	\$System	0
	hgxhgh	Analog	\$System	4
	intouchanalog1	Analog	\$System	4

Labels may be attached to any Tag. See the [Labels](#) for more information regarding Labels.



Click the 'Add' button to attach Labels to the selected Tags.



Click the 'X' button to delete the Label to the left.



Click the 'Navigate' button on the right to configure Labels in the Labels workspace.

Tags to Import

Drag a column header and drop it here to group by that column

	Tagname ▾	Type ▾	Group ▾	Number of Alarms ▾	Labels ▾
	analog2	Analog	\$System	7	Building2
▶	discrete1	Discrete	\$System	0	Building2

Next

The Next button will enable once you have at least one Tag under 'Tags to Import'. Click 'Next' to advance to the Alarm selection phase.

Select Alarms



You'll see the same type of screen here. This time, you will select the alarms from the Tags you chose from the previous step.

Available Alarms

Drag a column header and drop it here to group by that column

	TagName ▾	Type ▾	Limits ▾	Priority ▾	Labels from Parent Tag ▾
	analog2	ROC	RateOfChange: 10	1	Building2
	analog2	Deviation	MajorDeviation: 50, MinorDeviation: 0	1	Building2
	analog2	Level	HiHiLevel: 90, HiLevel: 60, LoLevel: 40, LoLoLevel: 20	1	Building2

Each limit under 'Limits' refers to a different alarm. They are separated by commas. For each distinct Tag, the total number of limits should equal the 'Number of Alarms' from the previous grid.

-  Click this button to move all available alarms to the 'Alarms to Import' grid and attach the selected Strategy plus additional Label(s) to them.
-  Click this button to move the selected alarms from 'Available Alarms' to 'Alarms to Import' and attach the selected Strategy plus additional Label(s) to them.



Click this button to remove the selected alarms from 'Alarms to Import' back to 'Available Alarms'.



Click this button to remove all 'Alarms to Import' back to 'Available Alarms'.

Labels

Labels may be attached to any Tag. See the [Labels](#) for more information regarding Labels.



Click the 'Add' button to attach Labels to the selected Tags.



Click the 'X' button to delete the Label to the left.



Click the 'Navigate' button on the right to configure Labels in the Labels workspace.

Strategies

Select the Strategy that will dispatch the selected alarms.



Click the 'Navigate' button on the right to configure Strategies in the Strategies workspace.

Alarms to Import

Drag a column header and drop it here to group by that column						
	TagName	Type	Limits	Priority	Strategy	All labels
▶	analog2	Deviation	MajorDeviation: 50, MinorDeviation: 0	1	Do Not Notify	Building2
	analog2	ROC	RateOfChange: 10	1	Do Not Notify	analog Building2



Once you have at least one alarm under 'Alarms to Import', click 'Next' to import the selected tags and alarms into your WIN-911 configuration.

Import Progress

Upon a successful import, the workspace will say 'Import Complete!' at the end of the message:

```
Importing 6 tags and 9 alarms...  
Saving packaged objects to configuration...  
Discrete tags saved to configuration.  
Integer/Real tags saved to configuration.  
Message tags saved to configuration.  
Import Complete!
```

100

If any errors occur during this process, the progress message will reflect those errors. Import progress for each Tag is independent from progress of the others. Thus, if one Tag fails to import, the others should still continue. The number at the bottom indicates the real-time percentage of the import that is complete.

InTouch Runtime



When connecting to your InTouch HMI, the user has two modes of operation to choose from, 1) run as a desktop application (WIN911.Source.InTouch.Runtime), or 2) as a Windows Service (WIN911.Source.InTouchRuntime.WPFHost). Each has its own advantages, so *choose advisedly*.

Note: The WIN-911.Source.InTouch.Runtime.WPFHost.exe application and the WIN-911 InTouch Runtime service both require InTouch HMI 10.1 or newer (no license needed) installed locally.

*Note: It is **invalid to run both** the WPFHost executable and the WIN-911 InTouch Runtime service at the same time. If both executables are run there will be no warning or feedback presented to the user and all alarming will be dysfunctional.*

Connecting as an Application (Default)

The WIN-911 InTouch runtime will run as an application, which means a user must always be logged into a Windows session. If you close the runtime (or log out), WIN-911 will stop receiving alarms.

WIN-911 User Guide

To begin monitoring InTouch alarm events, WIN-911 must connect to a running HMI via the WIN-911 InTouch module. To do this, first start your InTouch application (WindowViewer), then start WIN-911 InTouch.

If WIN-911's connection to InTouch is broken, WIN-911 will reconnect once InTouch is available again.

Connecting as a Service

The new WIN-911 InTouch Runtime service is installed with a startup setting of "Disabled". To use it you will need to change the properties for the startup setting to "Automatic" via the Windows Service Control Manager.

When the WIN-911 InTouch Runtime Windows service is running there is no requirement for a user login or Windows session if the targeted InTouch HMI is remote. If the InTouch HMI is local you will need to import the reg found in the WIN-911 install media media's Support folder, named "Session0LegacyMode.reg".

If you later decide to monitor a remote InTouch HMI system or use the WPFHost application instead of the Windows service locally, you will need to manually edit the following registry value:

"HKEY_LOCAL_MACHINE\SOFTWARE\WOW6432Node\Wonderware\AlarmManager\Session0LegacyMode". Change the value to "1" (one).

InTouch Edge HMI Overview

The InTouch Edge HMI data source provides a means of seamlessly connecting to Wonderware's InTouch Edge HMI information services. The WIN-911 data source interface to InTouch Edge HMI provides access to both tag data and alarm conditions maintained in the InTouch Edge HMI Tag Database.

Multiple data sources can be configured for InTouch Edge HMI. This allows the user to connect to multiple projects. InTouch Edge HMI supports the ability to reconnect to InTouch Edge HMI Services if the connection is lost.

Subscriptions allow WIN-911 to subscribe to alarm events according to filters created by the WIN-911 user. InTouch Edge HMI Subscriptions are configured using Alarm Worksheet Numbers, Messages, Tagnames, Priorities, and Selections. The use of Subscriptions (as opposed to individual tags) expedites the WIN-911 alarm configuration process and is far less demanding on your computer's resources.

Compatibility

WIN-911 supports InTouch Edge HMI, InduSoft Web Studio versions 8.1, 8.1 SP1 & 8.1 SP3

Note: WIN-911 is not compatible with version 8.1 SP2.

InTouch Edge HMI Terminology

WIN-911 User Guide

- **Project:** The name which encompasses the cumulative instance of the InTouch Edge HMI that WIN-911 is monitoring.
- **Tags:** Variables used by the HMI to receive and store data obtained from communication with the plant floor devices and from which alarms are derived.
- **Groups:** Organizational property used to associate alarms.
- **Alarm Worksheet Number:** property used to identify a particular Group Worksheet.
- **Message:** The message that was displayed when the alarm became active.
- **Priority:** Ranking of alarm urgency from 0 to 255, with 0 being the highest priority.
- **Studio Manager:** Primary HMI executable that contains the Tag Database, Drivers, OPC Clients, TCP/IP Server, Alarm and Trending modules, etc.
- **Selections:** Alias associated with alarms to provide a string value that can be used to categorize, filter, and sort alarms.

Prerequisites

- WIN-911 must be installed on a computer with network access to an InTouch Edge HMI Project Runtime.
- WIN-911 must be installed with the InTouch Edge HMI data source option.
- The *InTouch Edge HMI TCP/IP Server Runtime* must be running for WIN-911 to connect. Set its startup mode to Automatic (InTouch Edge HMI > Home > Tasks > TCP/IP Server Runtime).
- The HMI Project must be running.

General Architecture

The WIN-911's InTouch Edge HMI data source interfaces with the HMI's TCP/IP Server Runtime. This server provides access to tag data and alarming, which allows WIN-911 to dispatch alarm notifications and respond to report queries made by remote users. The TCP/IP Server Runtime facilitates data connection during startup and re-connection in the event that the connection is broken.

Establishing a Connection

InTouch Edge HMI

Set TCP/IP Server Runtime to start automatically. This can be done by navigating to *InTouch Edge HMI Studio Manager > Home tab > Tasks > TCP/IP Server Runtime > Startup > Automatic*.

If you are using the InTouch Edge HMI Security option, create a user with credentials that WIN-911 will use to access the project. This can be done by navigating to *InTouch Edge HMI Studio Manager > Project Explorer > Global tab > Security > Users*.

Verify the Project's TCP port (1234 is default). This can be found by navigating to *InTouch Edge HMI Studio Manager > Project Explorer > MyProjectName > Project Settings > Communication > TCP Port*.

When connecting WIN-911 to a remotely located HMI, be sure to enable remote security and remote debugging tools. This option is found by opening the *InTouch Edge HMI Studio Manager > Project Explorer > Global tab > Security > Groups*.

WIN-911

Navigate to Alarming > InTouch Edge HMI > Projects > Project Details tab. Enter the Project Name, Server Host, and Port number, as verified in the HMI. If security is enabled, then enter the valid username and password after enabling *Security*.

You can test your connection settings using the *Test Connection* button. If the test fails, fall back to the verification portion of the setup and ensure that all of the parameters are set properly and that the Project is running.

Maintaining a Connection

Data source connectivity is of paramount importance for WIN-911 to perform its primary functions. Three tools are provided to detect and respond to data source disconnections: Health, Watchdogs, and Reconnect.

Health and Watchdog alarm notifications are methods of detecting and alerting users of a disconnect condition. See [Health](#) and [Watchdog](#) sections for more information.

Reconnect is the logic that WIN-911 performs in response to a disconnect condition. WIN-911's InTouch Edge HMI module will attempt to connect to the data source periodically until the connection is reestablished. This function (and Health alarm) is automatic and requires no configuration by the WIN-911 user.

Priority vs. Severity

The native alarm priority schema for InTouch Edge HMI spans 0 to 255, with 0 being the most extreme ranking for an alarm. This is in contrast to WIN-911's native alarm severity schema, which ranges from 0 to 1000, with 1000 being the extreme. WIN-911 internally maps InTouch Edge HMI's 0 priority to WIN-911's 1000 severity and HMI's 255 to WIN-911's 0, in a linear fashion. To avoid confusion, the WIN-911 Administrator must keep these distinctions in mind when configuring two portions of your WIN-911 Project: Alarm Formats and Severity Decision Blocks.

Alarm Formats

The native InTouch Edge HMI Priority and the WIN-911 Severity are distinct from each other but serve the same purpose: to evaluate the urgent nature of the alarm in contrast to others. Both of these rankings can be displayed to the recipient of a WIN-911 alarm notification and can thus be a source of confusion.

If you wish to standardize the priority displayed in the notification by using the native HMI schema, you will need to create a custom format to assign to your connections. Below is an example of how to do that using the Email Formats:

Open the WIN-911 User Manual by clicking the *Help* button at the upper right of the WIN-911 Configuration GUI and navigate to *WIN911 > Alarming > InTouch Edge HMI > InTouch Edge HMI Alarm Event Mapping* using the tree in the left pane.

Look to the right column of the mapping table, titled *InTouch Edge HMI Properties*. Scroll down the column until you find '*Priority*'. Follow the '*Priority*' row horizontally across to the left column (WIN-911 Property) where you will find the property name '<NativeSeverity/>.'. Make a note of this property.

Open the WIN-911 Configuration and navigate to *Contact > Email > Formats* and select the '*HTML Long*' name in the XSL Templates list. This will open the format workspace.

Now select the *Copy* button on the lower left side of the templates list. The Format Worksheet will transition into edit mode with the elements appearing in raw XSLT code.

Change the name of the Format to '*ITEHMI HTML Long*.'

Scroll about halfway down the XSLT map and search for the code block that references *Severity*.

```
-----  
        </tr>  
        <tr>  
            <td style="padding-left: 12px; width: 14em;">Description: </td><td><xsl:value-of  
select="NotificationEvent/AlarmEvent/Condition/Description"/></td>  
        </tr>  
        <tr>  
            <td style="padding-left: 12px; width: 14em;">Severity: </td><td><xsl:value-of  
select="NotificationEvent/AlarmEvent/Condition/Severity"/></td>  
        </tr>  
        <tr>  
            <td style="padding-left: 12px; width: 14em;">Category: </td><td><xsl:value-of  
select="NotificationEvent/AlarmEvent/Condition/Category"/></td>  
        </tr>
```

Change the first occurrence of *Severity* to *Priority* and the second to *NativeSeverity*.

```
-----  
        </tr>  
        <tr>  
            <td style="padding-left: 12px; width: 14em;">Description: </td><td><xsl:value-of  
select="NotificationEvent/AlarmEvent/Condition/Description"/></td>  
        </tr>  
        <tr>  
            <td style="padding-left: 12px; width: 14em;">Priority: </td><td><xsl:value-of  
select="NotificationEvent/AlarmEvent/Condition/NativeSeverity"/></td>  
        </tr>  
        <tr>  
            <td style="padding-left: 12px; width: 14em;">Category: </td><td><xsl:value-of  
select="NotificationEvent/AlarmEvent/Condition/Category"/></td>  
        </tr>
```

Save your changes and you can now choose ITEHMI *HTML LONG*, which will display the native HMI priority instead of the WIN-911 Severity.

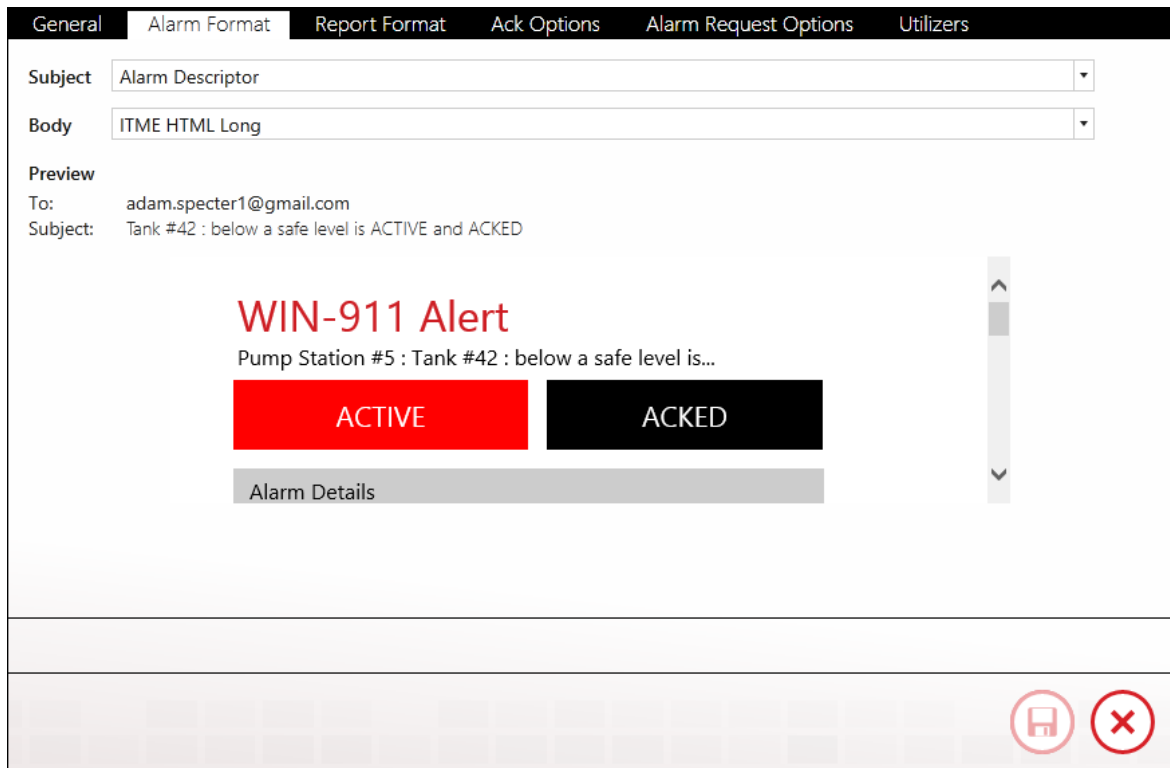

Severity Decision Block

Be aware when utilizing Severity Decision Blocks that the parameter you set uses the WIN-911 Severity rather than the HMI Priority. If you wish to base a decision route on a mid-range HMI Priority, say 128, you must first render that number into the WIN-911 Severity, which would be 500, as shown below.



WIN-911 User Guide

After dragging a Severity Decision Block onto an Advanced Tactic, double-click on the block to open the edit palette, select the Edit button and set the slider to 500. Now close the palette by clicking the OK (check) button then save the change.

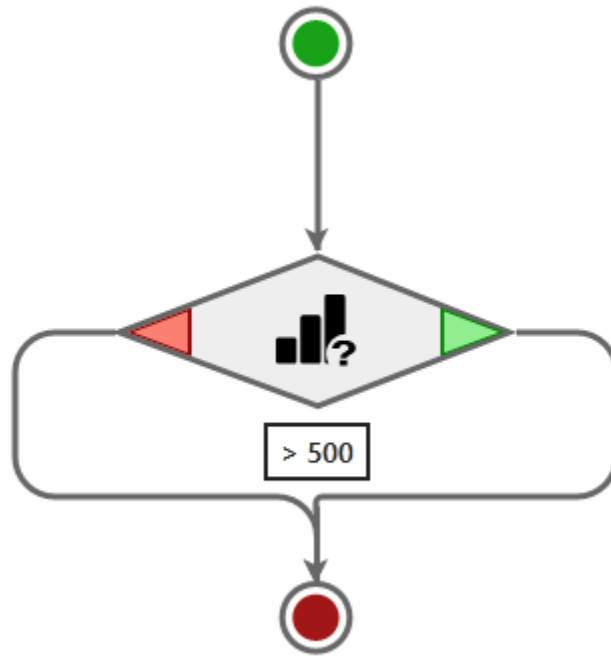

The figure is rendered in WIN-911 native and indicates the decision route is going to make a right-hand turn if the Severity is above 500. If it were rendered in native HMI the figure would indicate a right-hand turn would occur when the Priority is less than 128.

InTouch Edge HMI Quick Start

This section addresses how to set a very basic WIN-911 configuration capable of dispatching InTouch Edge HMI alarm conditions. There are two ways the WIN-911 InTouch Edge HMI data source module can receive alarm information: Subscriptions and Tags. Both will be addressed.

Assumptions in this section include:

- WIN-911 and InTouch Edge HMI are both deployed on the same computer.
- A WIN-911 notification method (Email, SMS, Mobile-911, or Voice) has already been configured.
- The Default Strategy will server as our notification rule.
- InTouch Edge HMI is running a project named *MyProject* with default settings and no security. It will have two tags, Digit01 and Digit02 in its tag database and set to alarm on a value of one.

Common Setup Steps

Open the WIN-911 Configuration and navigate to *Alarming > InTouch Edge HMI > Projects*. Select the  *Create* button at the lower left corner and the Project Workspace will appear.

WIN-911 User Guide

Project Details Health Watchdogs Subscription Routes

Name

Server ...

Port

Enable Security

The Name field is required.

Enter the name *"MyProject"* in the Name box.

Enter *'localhost'* (or system name or IP) in the Server box.

Leave the Port and Security settings unchanged.

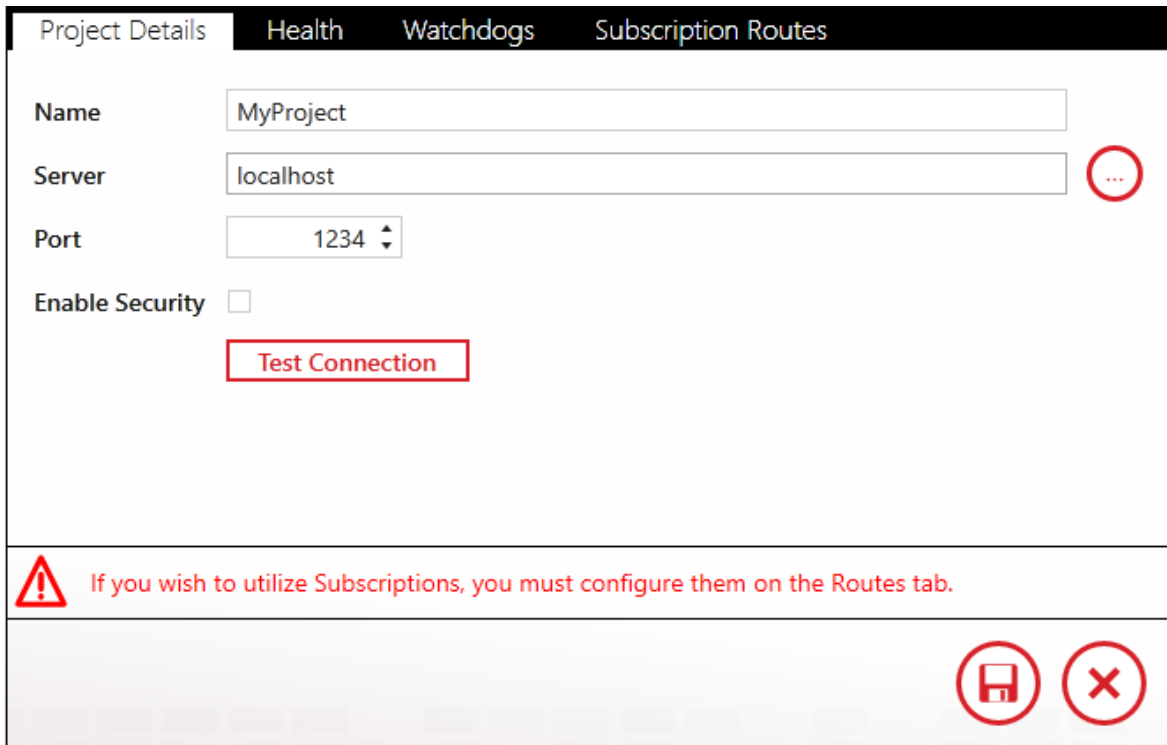

Click the *Test Connection* button.

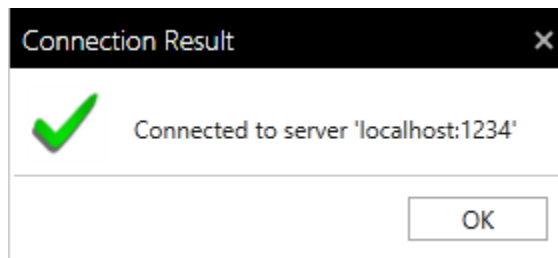

Subscriptions & Routes Method

Subscriptions provide a method of defining a range of tags to monitor based on shared attributes, like Groups, portions of tagnames, messages, and priorities, so that one subscription can handle a multitude alarm conditions.

Subscription Routes map a subscription to a notification rule (Strategy) which dispatches the alarm to a remote user for corrective action.

Subscription Routes are stacked in a hierarchy that evaluates incoming alarms by parsing their attributes and matching against the Subscription definitions in descending order. The first matching Subscription will catch the alarm and route it to the Strategy for notification. At that point the alarm is considered handled and the subscription routes ranked below it are ignored.

The 'All Alarms' subscription that comes pre-loaded with the InTouch Edge HMI data source can be used to subscribe to all alarms in an InTouch Edge HMI Project. Thus, it will behave like a wild-card, accepting any alarm condition that is passed to in by InTouch Edge HMI. We will use that for our example.

Select the Subscription Routes tab.

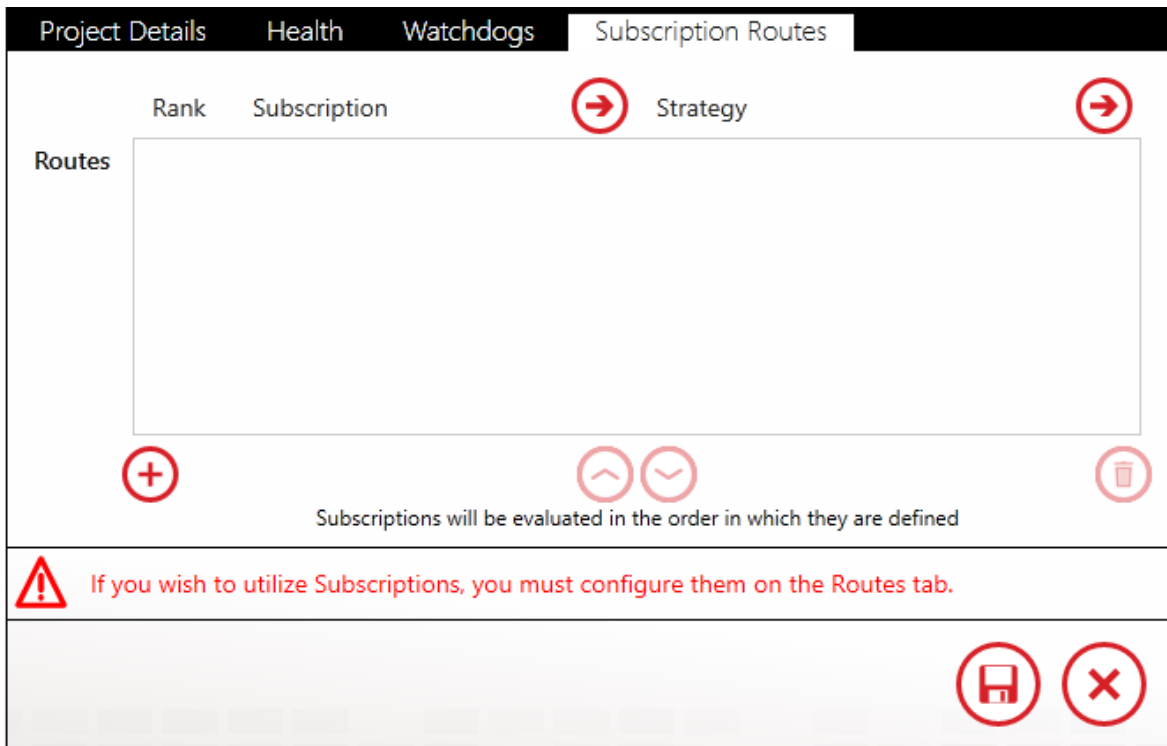

The Subscription Routes tab appears in edit mode. Select the  *Add new route* button at the bottom left and a pre-configured route appears with a rank of one.

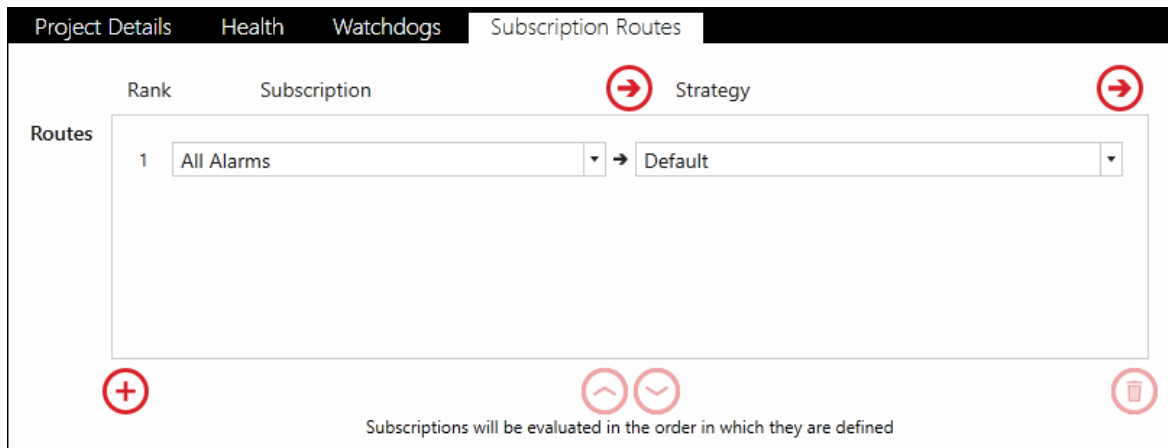

In the default route, the '*All Alarms*' subscription is set to dispatch every alarm in the InTouch Edge HMI project using the *Default* strategy. When you  Save the Project, the configuration will 'go live.'

Tags Method - Import Utility

WIN-911 also provides a "one-to-one" item monitoring schema called Tags. With this option, the user defines each tag individually. This method offers a higher level of customizing than Subscriptions but is more labor and resource intensive. Another advantage of using the tags option is its support of tag value data, in addition to alarm conditions. Thus, you can use tags to create WIN-911 Reports that can amplify information dispatched to users in the field.

Tags can be used in addition to Subscriptions, where tags take priority over subscriptions that might otherwise handle notification.

Continuing with our example, navigate to *Alarms > InTouch Edge HMI > Imports*.

A confirmation box appears with a message concerning Subscriptions. Click the *I Understand* box followed by *Next*.

WIN-911 User Guide

Select the Project you would like to import tags to. If you haven't yet configured a Project, use the arrow to navigate to the Projects workspace to create one.

MyProject 

Browse for the tag file associated with this project.

tagl.json 

The Project Selection page appears with your project name auto fed into the combo box and the accompanying *tagl.json* file below. Use the red edit tools to the right if the proper selections are not in place.

Note: The default location of the 'tag file' is *C: > Users > 'logged-in username' > Documents > InTouch Machine Edition v8.1 Projects > 'my project name' > Database.*

Select *Next* on the bottom right.

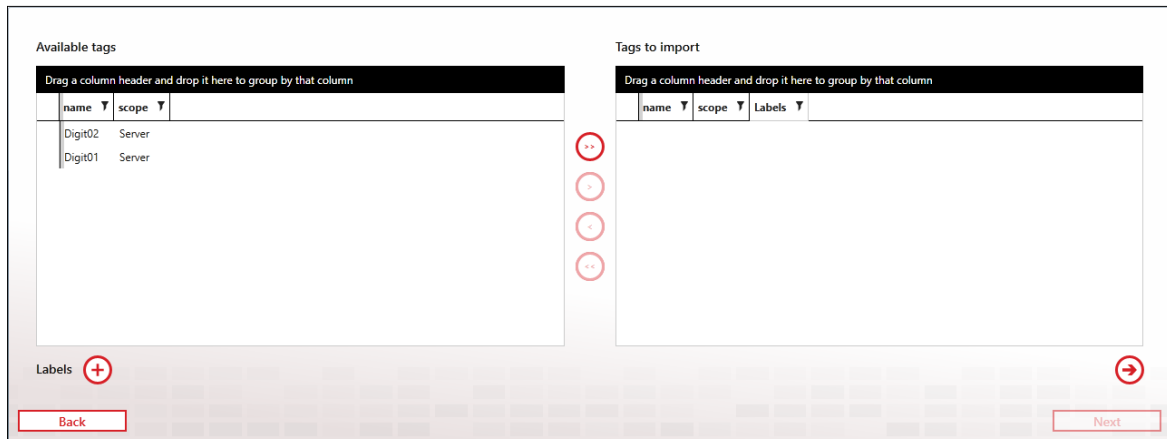



Available tags

Drag a column header and drop it here to group by that column		
name	scope	
Digit02	Server	
Digit01	Server	

Tags to import

Drag a column header and drop it here to group by that column		
name	scope	Labels

Labels 

Back 

Next

The tag selection page appears with the two resident tags, *Digit01* and *Digit02* in the left column. Highlight *Digit02* followed by the single  Add button to move it over to the *Tags to import* column.

Leave *Digit01* in the left column and click the *Next* button.

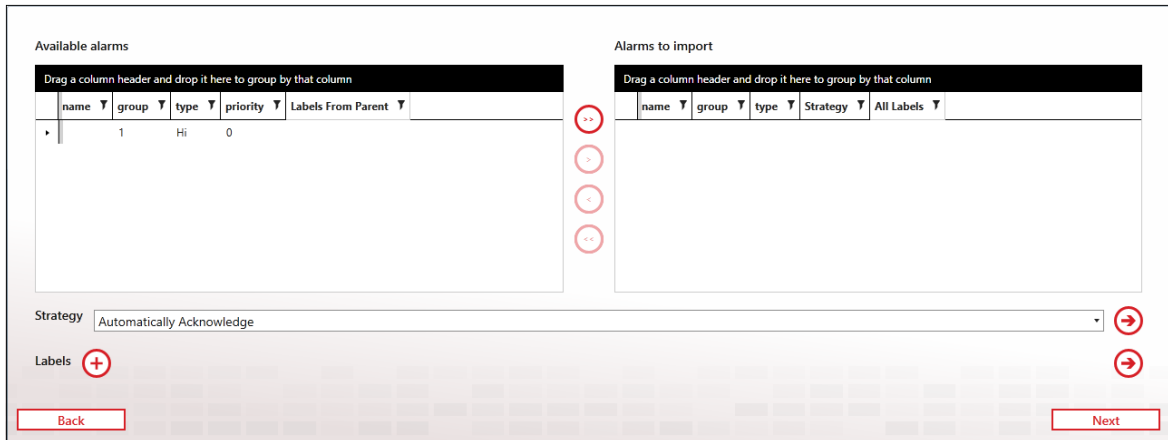

The alarm selection page appears with the alarm associated with *Digit02* in the left column and the Automatically Acknowledge Strategy auto fed. Use the  *Add all* button to move the alarm into the right column. The pre-selected strategy will suffice so use the *Next* button at the bottom right to execute the import.

Importing 1 tags 1 alarms...
 Saving packaged objects to configuration...
 Tags saved to configuration.
 Import complete!
 100% complete

After the import process concludes an import report page appears. At this point the tag is being monitored for live data. Although the *Digit02* tag qualifies for the 'All Alarms' subscription, it is handled by the *Automatically Acknowledge* strategy, since tags take priority over subscriptions in the escalation hierarchy. So anytime *Digit02* enters an alarm condition, WIN-911 will immediately acknowledge it, preventing any remote notification.

Tags - Manual Entry

Rather than importing the tags from the 'tag file', you can enter the tags manually by navigating to *Alarming > InTouch Edge HMI > Tags*. Click the  *Create* button and fill in the following pages:

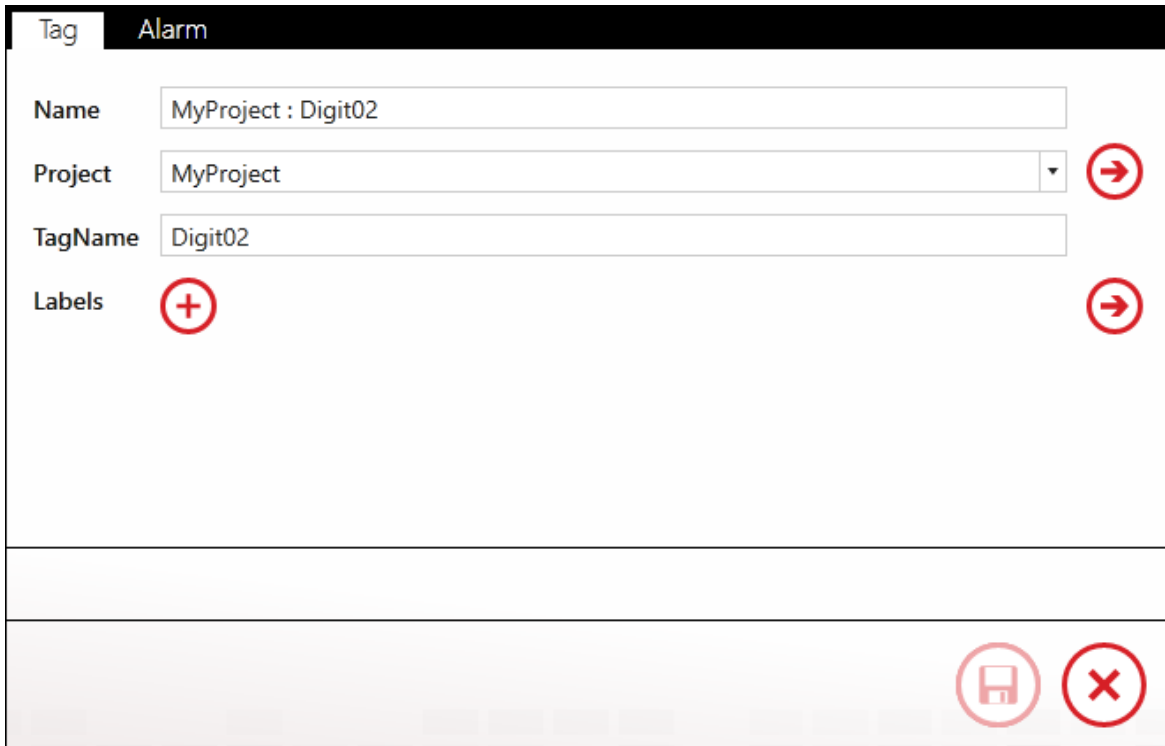

The screenshot shows a form titled 'Tag' with a sub-tab 'Alarm'. The form contains the following fields and controls:

- Name:** Text input field containing 'MyProject : Digit02'.
- Project:** Dropdown menu containing 'MyProject', with a right-pointing arrow icon to its right.
- TagName:** Text input field containing 'Digit02'.
- Labels:** A plus sign icon (+) with a right-pointing arrow icon to its right.

At the bottom right of the form, there are two circular icons: a save icon (floppy disk) and a cancel icon (X).

1. Enter a unique WIN-911 name for the tag. Since native tagnames can be cryptic, the name attribute provides a more user-friendly rendering of the tag. This is the name that is sent to the user in the notification message and is independent to the *TagName* (defined below).
2. Select the *Project* name (defined above) that contains the *Tag Database* that the tag being defined resides.
3. Enter the *TagName* exactly as it appears in the *InTouch Edge HMI Tag Database*. If the tag is not correctly entered, WIN-911 will not be able to connect to it.
4. Select the *Alarm* tab.

Tag
Alarm

Click the Add button below to create a new alarm for this tag.

Alarm Type

Strategy

Description

Labels













5. Select the *Alarm Type* using the combo-box.
6. Select the Strategy to dispatch the alarm message using the combo-box.
7. Enter the optional description in the text-entry box.
8.  Save your edits.

Note: Multiple alarm conditions can be defined on a single tag.

InTouch Edge HMI Alarm Acknowledgement

InTouch Edge HMI alarms can be remotely acknowledged via WIN-911 users notification devices. When alarms occur, the WIN-911 user will receive a notification through their notification device (Mobile-911, Email, Voice, SMS, etc.). The user can respond to the message using his device by sending an acknowledgement request back to InTouch Edge HMI. The user must be granted acknowledgement permission within the WIN-911 Configuration. If the InTouch Edge HMI project is set with the security option enabled, then WIN-911 must likewise be configured with valid credentials to connect to the project and, hence, acknowledge alarms.

InTouch Edge HMI Subscriptions

Subscriptions are the preferred method of fetching alarm events from InTouch Edge HMI. By this method, WIN-911 provides InTouch Edge HMI with a list of common properties that describe the kinds of alarms that WIN-911 is interested in monitoring. This method is powerful because a single subscription can be defined to handle a multitude of possible alarm events. For example, you can say to InTouch Edge HMI, "send me all alarms with a priority of 95 or greater". Contrast this to defining a tag entry in WIN-911 for every tag you want WIN-911 to monitor. WIN-911 supports the tag method (see tags) but you should be aware of the benefits of subscriptions over tags, as listed below:

Advantages of using Subscriptions

- Easier to define and maintain due to its scalability (one subscription to many alarms vs. one tag entry to one alarm)
- Significantly easier on system resources since a single subscription can handle the alarm events of any number of tags.

Advantages of using Tags

- Tags can provide data values for reports
- A single tag can handle differing alarm types (Hi vs. HiHi) in a unique manner by providing specific descriptions and strategies for each
- When there is overlap between a Tag entry and a Subscription, the Tag takes priority in alarm handling and the Subscription is ignored

Subscriptions can be created to match against InTouch Edge HMI Alarm Worksheet Numbers, Messages, Tagnames, and/or Priorities. Subscriptions may be used across multiple Projects to fetch alarms. By

default, a Subscription named 'All Alarms' is included. It is a read-only wildcard that will match against all InTouch Edge HMI alarms.

Once defined, subscriptions are assigned to [Subscription Routes](#) to handle alarm notification delivery. The subscription routes are defined by navigating to *Alarming > InTouch Edge HMI > Projects > Subscription Routes*.



Navigate to the Subscriptions workspace under *Alarming > InTouch Edge HMI > Subscriptions* to get started.

Subscriptions

By default, Subscriptions will match all alarms when first created. Users can click the radio buttons to modify the filtering criteria. In the example below, specific Tagnames and Priorities are being targeted.

Name

All Alarm Worksheet Numbers
 Specific Alarm Worksheet Numbers

All Messages
 Specific Messages

All Tagnames
 Specific Tagnames

Tagnames

All Priorities
 Specific Priority Range
 Specific Priority

All Selections
 Specific Selections

Labels

Whenever multiple categories of filtering are defined, the subscription will be considered a match if and only if every category matches. In the example above, both the Tagname and Priority filter categories must match for the subscription to be considered matching.

String Filters

Four types of string filters exist. They can be used to match against InTouch Edge HMI Tagnames and the Alarm Worksheet Numbers that your InTouch Edge HMI Tags are assigned to InTouch Edge HMI . String filters are not case-sensitive.

WIN-911 User Guide

The first and, easiest to use is the wildcard filter. Enter any string literal to match it exactly. Enter an asterisk to match any character any number of times. Enter a question mark to match any character one time.

- "Tank" will only match the string "Tank"
- "*tank" will match any string that ends with "tank". E.g. "Watertank," "Britetank."
- "z?g" will match any string that begins with "z," and ends with "g," and has only one letter between them. E.g. "zig," and "zag."



A screenshot of a filter input field. On the left, a dropdown menu is open, showing 'Regular Expression' selected. To the right of the dropdown, the text 'Tank?' is entered into the input field.

Regular expressions can be used. Regular expressions are an advanced method of pattern matching. There are many resources available online that document their use. Unlike the other options, Regular Expressions are case sensitive.

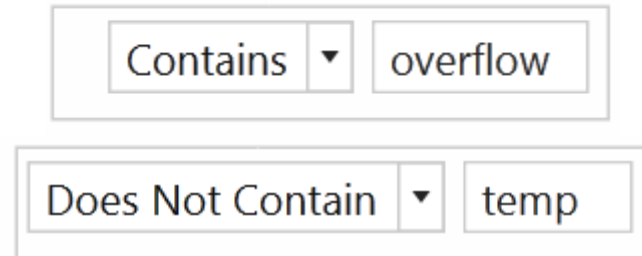

Two screenshots of filter input fields. The top one shows a dropdown menu with 'Contains' selected and the text 'overflow' entered. The bottom one shows a dropdown menu with 'Does Not Contain' selected and the text 'temp' entered.

'Contains' will match any string that contains the substring you enter exactly. 'Does Not Contain' will match the opposite.



Click the 'Add' button to create a new string filter under the respective category (e.g. tagname) with default values.



Click the 'Delete' button to delete the selected string filter under the respective category.

Alarm Worksheet Numbers

Alarms are created on *Alarm Worksheets* in the InTouch Edge HMI IDE. The worksheets are identified with numbers. The number can be found by navigating *Project Explorer > Alarms > Sheet*. The figure below shows an *Alarm Worksheet Number* of 001.

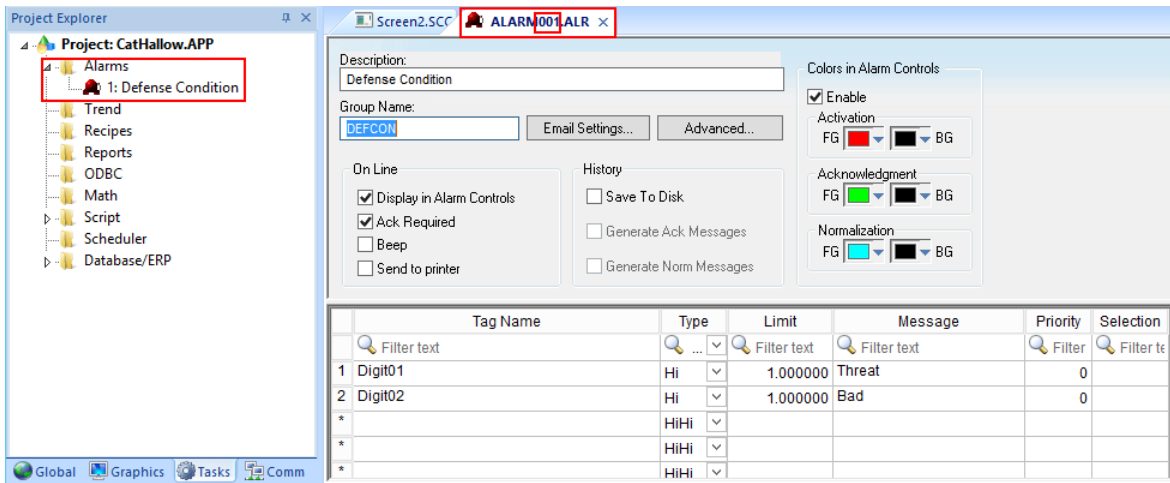

Users shall be able to filter on *All Alarm Worksheet Numbers* or *Specific Alarm Worksheet Numbers* using the following expressions, **Single Number** and/or an inclusive **Range of Numbers**.

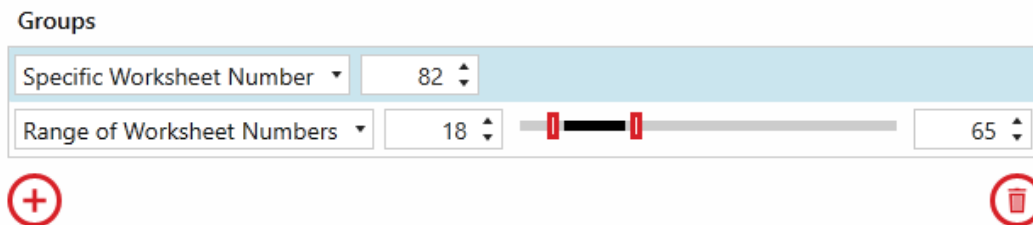

Messages

Messages are optional attributes that can be added to InTouch Edge HMI tags. WIN-911 can filter on messages by matching against portions of the string as dictated by Wildcard/Regular Expression criteria. The figure below shows where alarm *Messages* are created and edited in the InTouch Edge HMI IDE.

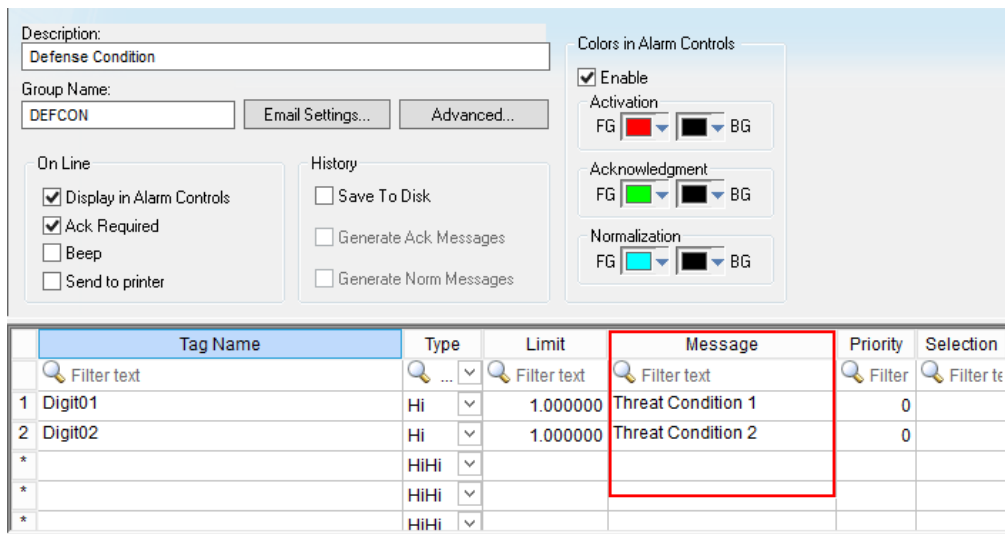

Tagnames

Tagnames reflect the name assigned to each tag within the InTouch Edge HMI project. Whenever multiple criteria within this category are defined, the category will be considered a match if ANY filter criterion matches. The figure below shows where alarm *Tag Names* are created and edited in the InTouch Edge HMI IDE.

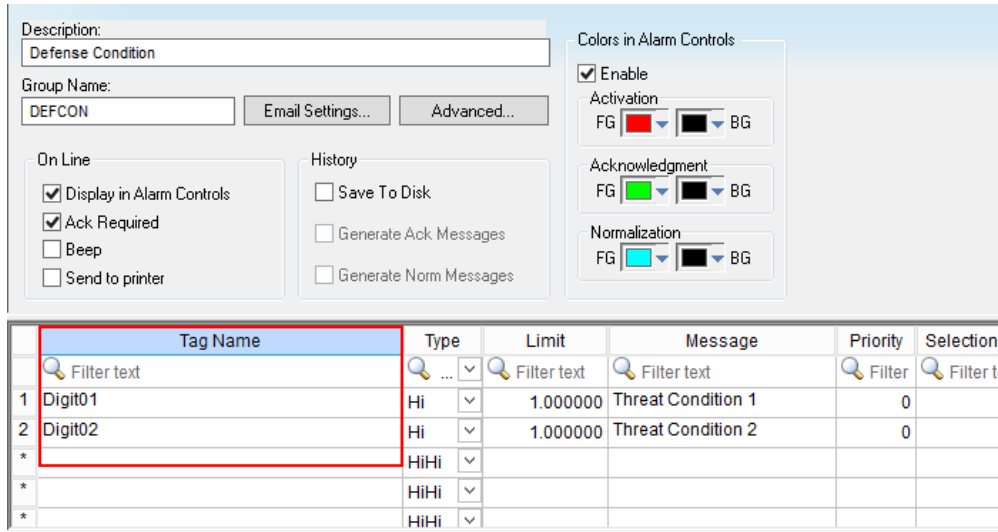

Priorities

Priority filters are supported for InTouch Edge HMI . They can be created to match an inclusive range. The figure below shows where alarm *Priorities* are created and edited in the InTouch Edge HMI IDE.

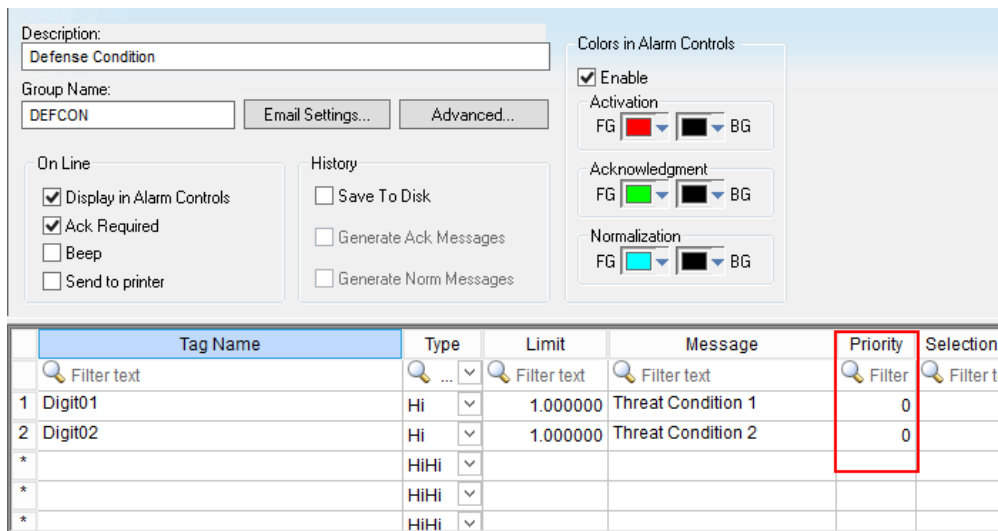

Use the slider or combo boxes to specify a *Priority Range* or *Specific Priority*.



They can also be created to match a specific Priority.

Selections

An alias associated with the alarm (e.g., AreaA, AreaB, etc) whose contents can be used to filter/sort alarms. Whenever multiple criteria within this category are defined, the category will be considered a match if ANY filter criterion matches. The figure below shows where an alarm Selection can be created and edited in the InTouch Edge HMI IDE.

	Tag Name	Type	Limit	Message	Priority	Selection
	Filter text	...	Filter text	Filter text	Filter	Filter text
1	Analog01	Hi	50.000000		10	AreaA
*		HIHI				
*		HIHI				
*		HIHI				
*		HIHI				

Labels



Click the 'Add' button to the right of 'Labels' to add new Labels to this Subscription. At runtime, alarms matching the Subscription will have the specified set of Labels attached.



Click the 'Navigate' button to navigate to the Labels workspace. If any changes have been made to the Subscriptions tab, they will persist until the user navigates back to the Subscriptions tab.



Click the 'Delete Label' button to delete the Label on the left.

Utilizers

This tab simply shows the user which *Projects* are currently using the *Subscription* that they are viewing. A *Subscription* cannot be deleted while in use.

InTouch Edge HMI Project

Project Details	Subscription Routes	Health	Watchdogs	Heartbeat
--------------------	---	------------------------	---------------------------	-----------

The InTouch Edge HMI Project Details workspace defines the parameters WIN-911 requires establishing a connection to the InTouch Edge HMI Project that you wish to monitor for alarm events. It specifies the location and any credentials required by the Project to successfully pass data to and from the SCADA during runtime operations.



Navigate to *Alarming > InTouch Edge HMI > Projects: Project Details*.

The screenshot shows the 'Project Details' configuration window. It includes a navigation bar with tabs: Project Details, Subscription Routes, Health, Watchdogs, and Heartbeat. The main area contains the following elements:

- Name:** A text input field containing 'MyProject'.
- Server:** A text input field containing 'localhost' with a browse button (three dots in a circle) to its right.
- Port:** A spinner control set to '1234'.
- Enable Security:** An unchecked checkbox.
- Test Connection:** A red-bordered button.
- Custom Fields:** A section titled 'Select Alarm Custom Field(s) to include in notifications' with a 'Learn More' button. It lists ten custom fields (Custom01 to Custom10) with unchecked checkboxes.
- Footer:** A grey bar at the bottom right containing a save icon (floppy disk) and a close icon (X in a circle).

Name

Enter a unique, user friendly name to identify the particular InTouch Edge HMI Project you wish to connect with. This name does not have to be the actual Project name as determined by InTouch Edge HMI, but it is recommended, especially if you are connecting to multiple projects.

Server

Enter the syntactically correct server name that this project resides on. You can use 'localhost' if the project is located on the WIN-911 host. There is a browse button provided for your convenience.

Port

Enter the TCP port as specified by the InTouch Edge HMI project settings. You can enter the port number directly into the text-box or use the stepper (up/down arrows) located to the right. The default port is '1234', but can be modified by the user in the communications tab of the project settings. To view the project settings, open the *InTouch Edge HMI > Project Explorer > right-click on the Project > Project Settings > Communication*. The TCP port is located on the upper-left.

The screenshot shows the 'Project Settings' dialog box with the 'Communication' tab selected. The 'TCP' section has a 'Port' field containing '1234' and a 'Send Period (ms)' field containing '100'. Below these are checkboxes for 'Enable binary control' and 'Preloading tags from server'. The 'Preloading tags from server' section includes 'Timeout when executing on remote: 3000 ms' and 'Timeout when executing on local: 1000 ms', with a 'Preload all tags' checkbox. The 'Driver and OPC' section has a dropdown set to 'Send every state'. The 'Tag Integration' section has a 'Source' dropdown and 'Add...', 'Remove', and 'Configure...' buttons. The 'Execution Environment' section has a 'Timeout (ms): 30000' field and an 'Enable File Compression' checkbox. The 'OPC UA Server' section has an 'Endpoint URL' field with 'opc.tcp:// [NodeName] : 48010'. Below this are 'Identity' checkboxes for 'Enable anonymous login' and 'Enable Username/Password'. The 'Security Policies' section has checkboxes for 'None', 'Basic256' (checked), and 'Basic128Rsa15', with a 'Mode' dropdown set to 'Sign, Sign and Encr'. The 'Certificates' section has buttons for 'Self-Signed Certificate Information' and 'Certificate Store Management', and an 'Automatically trust client certificates' checkbox. The 'Stack trace level' dropdown is set to 'Error'. At the bottom are 'OK' and 'Cancel' buttons.

The port can be set to any valid TCP port (0 <-> 65535).

Username

WIN-911 must log into InTouch Edge HMI 's security system using a valid InTouch Edge HMI user. 'Guest' is the default entry.

Password

InTouch Edge HMI security can be optionally enhanced with the inclusion of a user-defined password. If InTouch Edge HMI is configured with a password you must enter it here before WIN-911 will be recognized as a valid user.

Test Connection

Use the *Test Connection* button to verify the server and port settings. The InTouch Edge HMI Runtime must be running for the test to be valid. If it initially fails, verify that the InTouch Edge HMI Project is running, then check the server and port settings against those in the InTouch Edge HMI *Studio Project Settings* > *Communication* tab.

Custom Fields

You can include Custom Fields from your project in your alarm notification as additional alarm descriptors, or they can be used to embed URLs with a hyperlink label. If you plan on using URLs, you will need to use the following syntax for use with WIN-911 Mobile.

Label, URL

E.g., Link to HMI Screen, <http://myserver/ITEH81/index.html>

WIN-911 User Guide

If you only need to provide an additional description, you don't need to use this syntax.

WIN-911 Mobile instructions

Custom Fields are not enabled by default, so you will need to modify the Alarm Details format in your app to include the Attachments alarm property.

Instructions for other notifiers

If your not using WIN-911 Mobile, you can still use Custom Fields, but you will need to include the following XSL in your alarm format.

```
<xsl:for-each
select="NotificationEvent/AlarmEvent/Attachments/AttachmentInfo">
  <xsl:text>Custom Field; </xsl:text>
  <xsl:value-of select="Description"/>
  <xsl:text>&#xD;&#xA; </xsl:text>
  <xsl:text>URL; </xsl:text>
  <xsl:value-of select="Location"/>
  <xsl:text>&#xD;&#xA; </xsl:text>
</xsl:for-each>
```

InTouch Edge HMI Health Alarm

Project Details	Subscription Routes	Health	Watchdogs	Heartbeat
-------------------------------------	---	------------------------	---------------------------	-----------

Datasource connectivity is critically important to WIN-911's ability to dispatch alarms events and provide production data. Situations can occur where WIN-911 loses its connection to the datasource (for any number of reasons), leaving it unable to fulfill its primary function. To guard against such things, you are provided with an InTouch Edge HMI Health Alarm. This is a special alarm event that is derived from WIN-911's interface with InTouch Edge HMI and alerts the user when connection to the SCADA is broken.

Note: The InTouch Edge HMI Health alarm will cover the vast majority of connection issues. It is recommended as matter of best practices, to enhance connection monitoring with a Watchdog.



Navigate to *Alarming > InTouch Edge HMI > Projects: Health*.

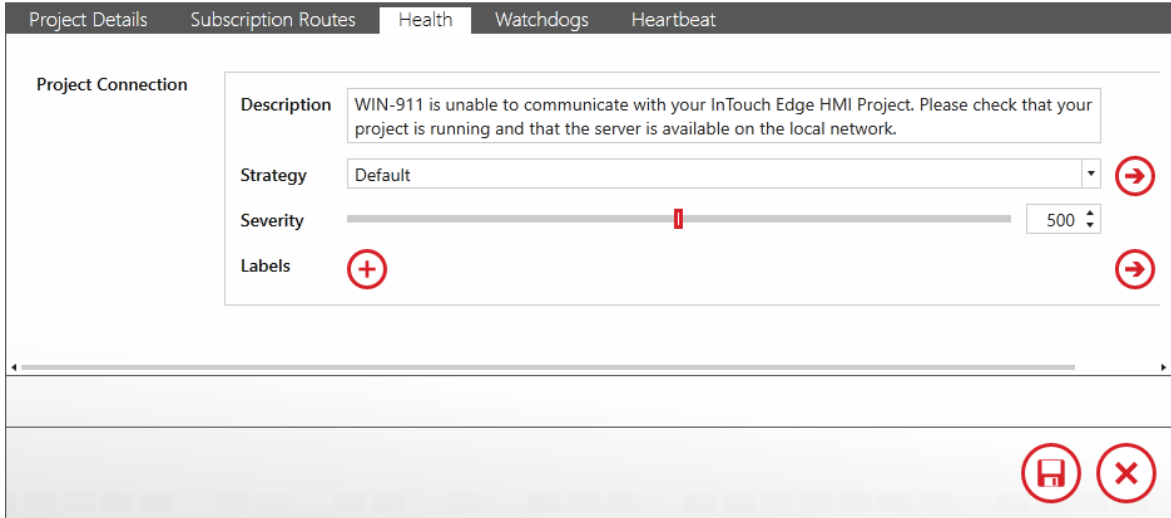

Description

The description field provides the recipient useful context for this unique alarm condition. The default string appears pre-loaded and can be edited as needed by the WIN-911 administrator.

Strategy

Select the Strategy that will dispatch this alarm.



Click the 'Navigate' button on the right to configure Strategies in the Strategies workspace.

Severity

The severity is a user configurable property that alerts the recipient of the importance of the alarm event. Use the slider or the number stepper to set the alarm's severity ranking between 0 and 1000, with 1000 being the most extreme. Due to the critical nature of this alarm, WIN-911 recommends a high severity ranking.

Labels

Labels may be attached to any alarm condition. See the [Labels](#) for more information regarding labels.



Click the 'Add' button to attach Labels to the associated condition.



Click the 'X' button to delete the Label to the left.



Click the 'Navigate' button on the right to configure Labels in the Labels workspace.

InTouch Edge HMI Watchdogs

Project Details	Subscription Routes	Health	Watchdogs	Heartbeat
-------------------------------------	---	------------------------	-----------	-----------

Device connectivity is critically important to WIN-911's ability to dispatch alarms events and provide production data. Situations can occur where WIN-911 or InTouch Edge HMI loses its connection to a device (for any number of reasons), leaving it in an impaired state. To guard against such things, you are provided with Watchdog Alarms.

Watchdog Alarms are special monitoring tools provided by WIN-911 to help ensure the operation and availability of devices in your production environment. The Watchdog will monitor a changing value from specific InTouch Edge HMI tags and activate when a set period of time elapses without the tag value updating. The recipient of the Watchdog alarm can assume that the associated device is offline.

WIN-911 actively polls a tag's value within the platforms database. It expects a valid response which it compares to a previous value, as defined by the Watchdog timeout.

To setup a Watchdog:

1. Create a tag within InTouch Edge HMI that is set to increment at a set rate, say, 30 seconds.
2. Create a Watchdog in *WIN-911 > Alarming > InTouch Edge HMI > Projects > Watchdogs* and give it a unique name that will be recognized by the recipient.
3. Enter the syntactically correct tagname in the respective field.

4. Set a timeout, in seconds, which is greater than the increment rate specified in step 1, say, 45 seconds.
5. Select the strategy you want to handle notifications when the Watchdog activates.
6. Enter a severity that properly conveys the significance of the Watchdog.

It is worth noting that Watchdog alarms are not part of the InTouch Edge HMI alarm system, but rather separate from and in addition to the alarms managed by the SCADA. WIN-911 polls these tags, evaluates alarm conditions and handles all related processing. With InTouch Edge HMI native alarm types, WIN-911 is a passive recipient of alarm information.

Note: A Watchdog alarm can also be used in conjunction with your Health alarm to monitor WIN-911's connection to InTouch Edge HMI. Although the Health alarm will cover the vast majority of connection issues, it is recommended as matter of best practices, to enhance connection monitoring with independent Watchdogs.



Navigate to *Alarming > InTouch Edge HMI > Projects: Watchdogs*.

WIN-911 User Guide

Project Details Subscription Routes Health Watchdogs Heartbeat

Click the Add button to define a new Watchdog Alarm. These alarms will become active when there is no activity from the specified tag for the amount of time specified.

Name

Description

TagName

Timeout

Strategy

Severity

Labels

Name

The name is a user-defined property that identifies the alarm to the recipient. There is no syntax requirement imposed on this text-entry field except that it must be unique to the project.

Description

The description field provides the recipient useful context for this unique alarm condition. The default string appears pre-loaded and can be edited as needed by the WIN-911 administrator.

TagName

InTouch Edge HMI tag that WIN-911 will monitor for a changing value (or changing alarm state). This field must match the name of the tag as it is configured in InTouch Edge HMI.

Timeout

The elapsed time (seconds) when WIN-911 will periodically check the tag for a changed value. The value range must be greater than the expected change rate of the tag's value. It is recommended that the tag's data type be a value other than Boolean. A good candidate would be a ramping integer.

Strategy

Select the Strategy that will dispatch this alarm.



Click the 'Navigate' button on the right to configure Strategies in the Strategies workspace.

Severity

The severity is a user configurable property that alerts the recipient of the importance of the alarm event. Use the slider or the number stepper to set the alarm's severity ranking between 0 and 1000, with 1000 being the most extreme. Due to the critical nature of this alarm, WIN-911 recommends a high severity ranking.

Labels

Labels may be attached to any alarm condition. See the [Labels](#) for more information regarding labels.



Click the 'Add' button to attach Labels to the associated condition.

WIN-911 User Guide



Click the 'X' button to delete the Label to the left.



Click the 'Navigate' button on the right to configure Labels in the Labels workspace.

InTouch Edge HMI Subscription Routes

Project Details	Subscription Routes	Health	Watchdogs	Heartbeat
---------------------------------	---------------------	------------------------	---------------------------	-----------

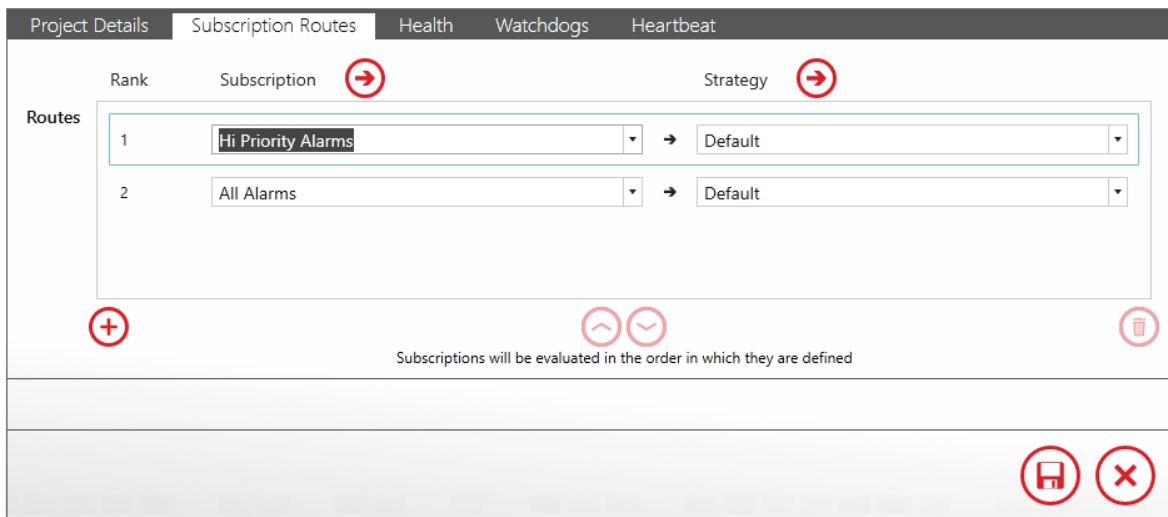

Subscription Routes forward alarms from a Subscription to a particular Strategy. This feature allows you to use Subscriptions across multiple Projects without redefining Subscription logic. An alarm will be handled by the first qualifying Subscription. Subscription Routes are evaluated in the order they are ranked.

Subscriptions are the preferred method of configuration for fetching alarms from InTouch Applications. See the [Subscriptions](#) for a detailed explanation of their usage.

WIN-911 User Guide



Click the 'Navigate' button to configure Subscriptions or Strategies.



Click the 'Add' button to add a new Route to the Application.



Click the 'Up' button to move the selected Route up a rank.



Click the 'Down' button to move the selected Route down a rank



Click the 'Delete' button to remove the selected Route from the Application.

InTouch Edge HMI Import



The InTouch Edge HMI Import workspace provides the user with a tool to easily populate your WIN-911 database with tags and alarms. This tool is powerful because it allows you to conduct mass imports quickly and effectively while eliminating the probability of syntax errors that are prone to happen when tags are entered manually.

Note: Subscriptions provide a more convenient method of alarm configuration than importing tags. Tag definitions are only required for report functionality and advanced scenarios.

Note: WIN-911 does not support importing arrayed tags.

Navigate to *Alarming > InTouch Edge HMI > Imports* to get started.

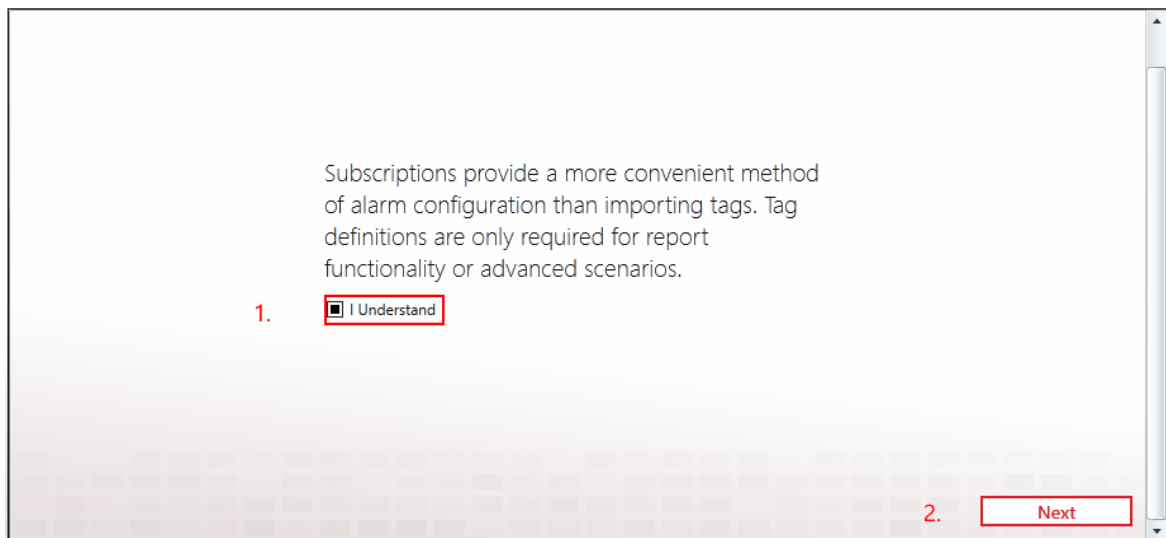



WIN-911 User Guide

1. Read the recommendation then acknowledge by clicking the "I Understand" check box.
2. The 'Next' button becomes enabled. Click it to advance to the next step.

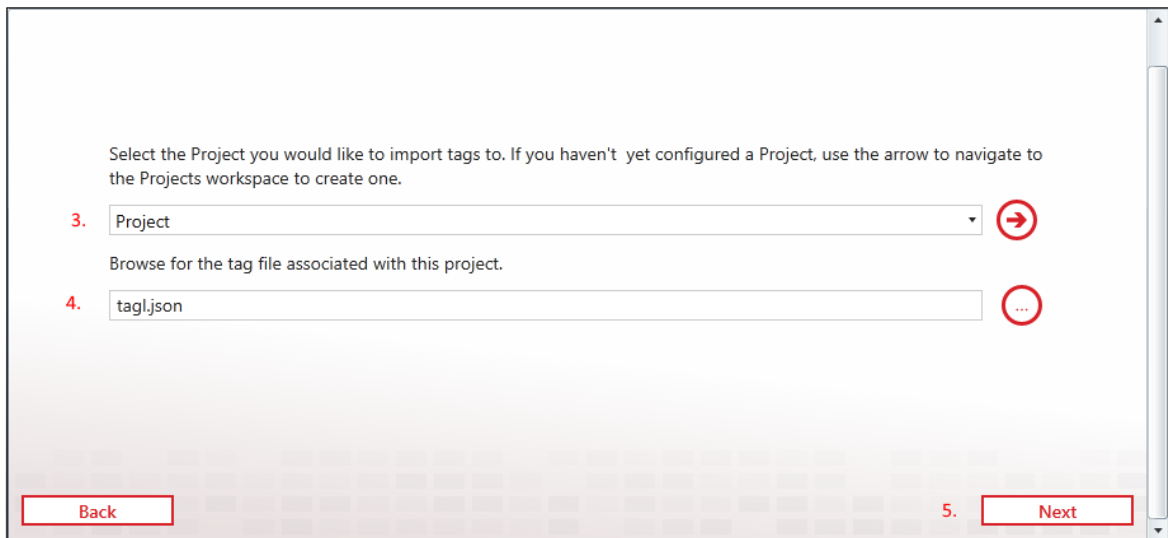





InTouch Edge HMI stores its configuration in the tagl.json file which is typically located by navigating to *MyPC > Local Disk (C:) > Users > username > Documents > InTouch Machine Edition v8.1 Projects > project name > Database*.

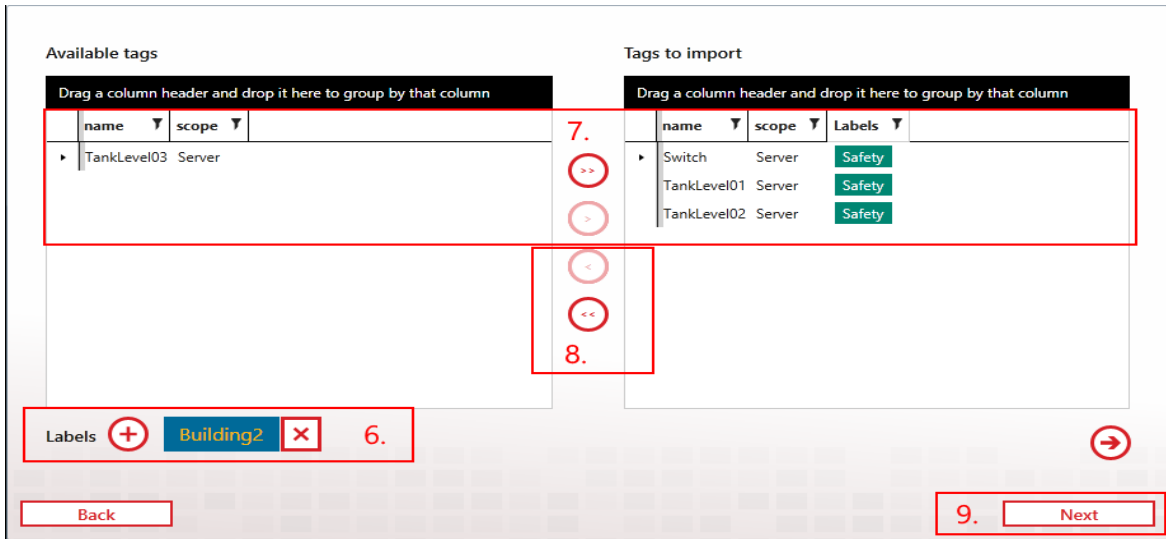

3. Select the InTouch Edge HMI project from the combo-box or use the  *Create or modify projects* button to create or modify a project in the Project Details workspace.
4. Select the 'tagl.json' file associated with the InTouch Edge HMI project. Use the  browse button to locate the file.
5. Click the Next button to advance to the next step.

The Tag Selection workspace appears. Here you will designate the tags you want WIN-911 to monitor by migrating them from the *Available tags* list (left) to the *Tags to import* list (right). You can also assign Labels to the tags using the  *Attach Labels* button at the bottom left.



6. Use the  *Add Labels* button to attach Labels to tags as part of the import process. A  *Create or modify labels* button is provided to take you to the Labels workspace if necessary. If labels are desired, this step must be done prior to continuing.
7. Use the  *Add All* button to move all available tags to the right column, or use the  *Add* to move individual tags. Use the  *Remove* button to selectively return tags, one at a time.
8. Use the  *Remove All* button the send all the alarms in the import column back to the right-hand column or use the  *Remove* button the selectively return alarms, one at a time.
9. Click the Next button to advance to the next step.

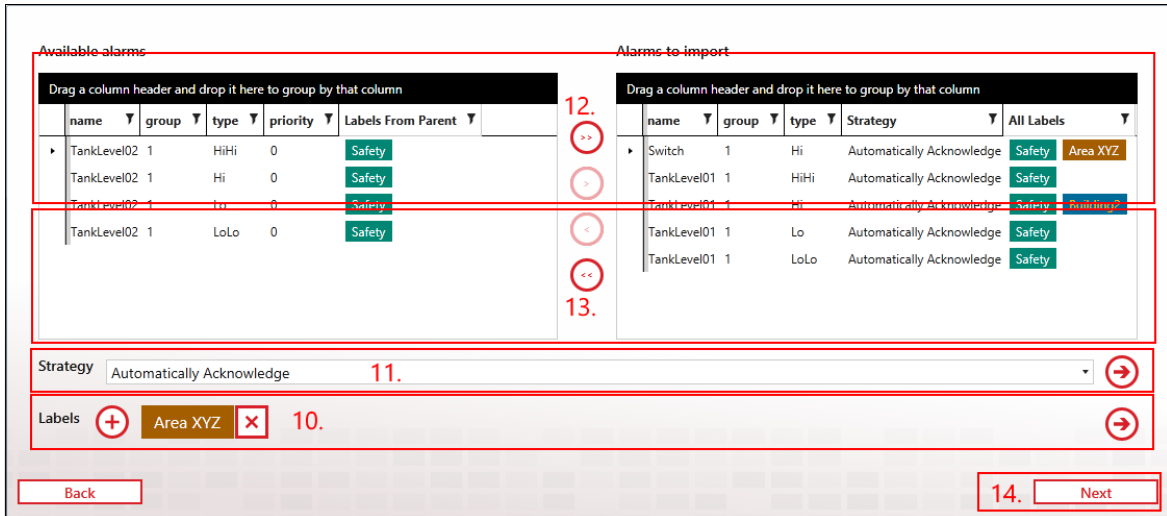

10. Use the Add Labels button to attach Labels to tags as part of the import process. A Create or modify labels button is provided to take you to the Labels workspace if necessary.
11. Use the Strategy combo-box to select the strategy you want to handle these alarms. A Create or modify strategies button is provided to take you to the Strategies workspace if necessary.
12. Select the desired alarms from the left column and use the Add All button to move all available alarms to the right column or use the Add button the selectively add alarms, one at a time. Be sure you select a strategy before you add alarms.
13. Use the Remove All button the send all the alarms in the import column back to the right-hand column or use the Remove button the selectively return alarms, one at a time.
14. Click the Next button to execute the import.

The import will now execute and generate an import report that details the number of tags and alarms that have been successfully imported.

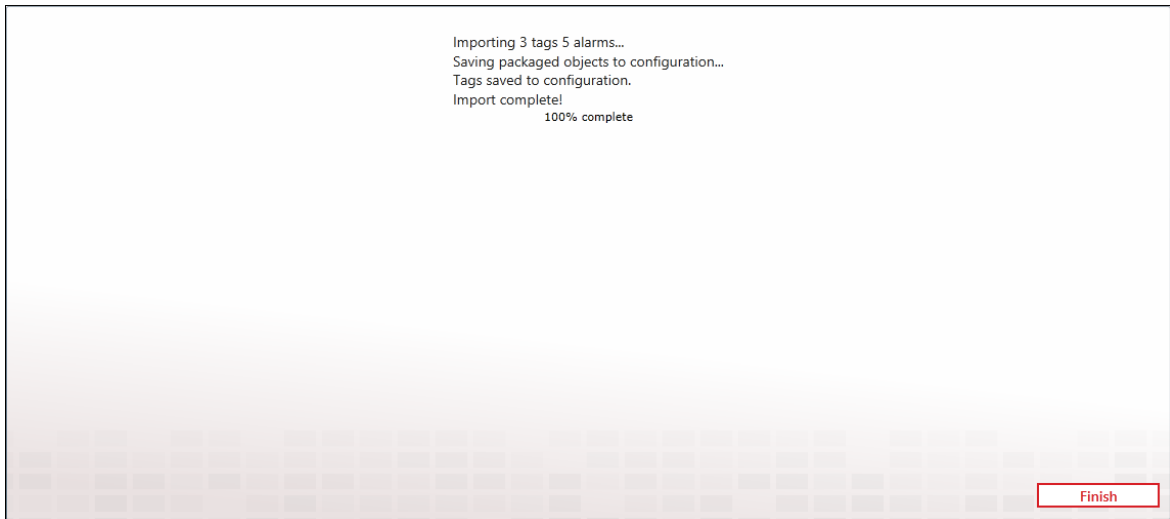

15. Click the Finish button to conclude the import.

InTouch Edge HMI Tags

Note: Subscriptions provide a more convenient method of alarm configuration than tags. Tag definitions are only required for report functionality and advanced scenarios.

An InTouch Edge HMI tag is an individual data object with properties that can include values, descriptions, alarm conditions, and acknowledgment states. The value data types can be Boolean, Integer, Real, and String. The alarm types can be Hi, HiHi, Lo, LoLo, Rate of Change, Major Deviation and Minor Deviation. Each alarm state has its own acknowledgment state, so if a tag is experiencing both a Hi and a HiHi alarm, and the HiHi alarm condition gets acknowledged, the Hi alarm remains unacknowledged. WIN-911 does not support String alarms.

WIN-911 breaks tag configuration into two tabs: Tag and Alarm. The tag tab defines the name and location of the tag. The alarm tab specifies which alarm conditions WIN-911 will monitor for remote notification tasking. A tag can be defined without alarming. This is done when the user would like to provide a tag value in the form of a report. There can also be one or more alarm conditions that WIN-911 can dispatch. Boolean alarms are handled as a Hi alarm with a value of one.

Note: Deleting a Project within WIN-911 will cause the mass deletion of all the associated tags and alarms.



To get started, navigate to Alarming > InTouch Edge HMI > Tags. The Tag collection appears with existing tags populating the Tags column. Use the *Create* button to generate a new tag. Highlight an existing tag and use the *Copy* button to create a new tag based on it or the *Edit* button to modify the tag.

Name

The Name field serves as a unique identifier for InTouch Edge HMI Tags. This field is user defined and may be independent of the TagName. Make the name user-friendly, as this is the name that will be most prominently displayed in alarm notifications.

Imported tags are automatically assigned a name using the convention: 'Project:Tag.'

Project

Select the InTouch Edge HMI Project which hosts the Tag you've created with the combo-box. There is an  *Add or modify projects* button to the right that will take you to the Projects workspace.

TagName

The TagName field must match the tagname as it appears within InTouch Edge HMI. A TagName must be unique within the Project. Comparison is case-sensitive.

Labels

Attach Labels to your Tag as a means of organization. See the [Labels](#) for more information regarding Labels.

Alarm Type

Use the combo-box to select the type of alarm this tag will be monitored for. The available types are Hi, Hi Hi, Lo, Lo Lo, Rate of Change, Major Deviation, and Minor Deviation. A  *Delete* button is located to the right to remove this alarm type.

Strategy

Select the Strategy that will dispatch this alarm. Use the  *Create or modify strategy* button to go to the Strategy workspace.

Description

Use this field to enter useful information that conveys context or special instruction to the recipient.

Labels

Attach Labels to your Tag as a means of organization. See the [Labels](#) for more information regarding Labels.

InTouch Edge HMI Alarm Event Mapping

The following table is a map of InTouch Edge HMI alarm properties to WIN-911 alarm properties.

WIN-911 Property	Comment	ITEHMI Property
<AlarmEvent>		
<AlarmLifetimeld/>		TagName + Type + StartTime
<ActiveTime/>	Time at which the last transition from terminal to active occurred.	StartTime
<Alarm>		
<NativeId/>	Tag name and the alarm type concatenated, e.g. "tank.level."	TagName + Type
<Name/>	Tag Name. FriendlyName (whatever is entered in the GUI)	TagName
<Description/>	Project Tag Description	Empty (description not provided by toolkit)
<Area/>	Group	Group
<SourceName/>	Name of Web Studio Project as configured in WIN-911.	See left
<System/>	System	See left
<SubSystem/>	PeerGroup	See left
<SourceType/>	ModuleType	See left
</Alarm>		
<Condition>		
<Name/>	Name of the Alarm Type. HiHi, Hi, Lo, LoLo, Rate, Dev+, Dev-	Type (mapped to friendly string)
<Category/>	The category of the alarm.	Type (raw)

WIN-911 User Guide

	HiHi, Hi, Lo, LoLo, Rate, Dev+, Dev-	
<Description/>	Alarm Description	Message
<NativeSeverity/>	Setting as configured within Project.	Priority
<Severity/>	Setting as configured within Project.	1000 – (Priority*3.92)
<Limit/>	Setting as configured within Project.	Empty (not provided by toolkit)
<LimitType/>	Setting as configured within Project.	string
<LimitOperator/>	Setting as configured within Project.	Empty
<EngineeringUnits/>	Setting as configured within Project.	Empty (not provided by toolkit)
</Condition>		
<Vtq>		
<Value/>	Value of the Tag	Value.ToString()
<ValueType/>	The type of the Project tag.	"Double"
<EventTime/>	The time the last change to active, acknowledged or condition was received.	EventTime
<Quality/>	The Project Tag's quality	Empty (always good)
</Vtq>		
<State>		
<IsAcked/>	The ack field for the corresponding alarm category	! AckReq
<IsActive/>	The Alarm field	Active
<IsSuppressed/>		false
</State>		
<Changes>		
<ChangeAcked/>	Calculated internally.	
<ChangeActive/>	Calculated internally.	
<ChangeQuality/>	Calculated internally.	
<ChangeValue/>	Calculated internally.	

InTouch Edge HMI Alarm Event Mapping

<ChangeCondition/>	false	
<ChangeSuppressed/>	Not supported.	
</Changes>		
<Attachments>		
<Actor/>	The actor received from the notifier module.	UserName
<Comment/>	The actor received from the notifier module.	Comment
</Attachments>		

|

Labels

Overview

Labels can be attached to alarms as a method of organization. They can also be used in Advanced Tactics to change the flow of notification.

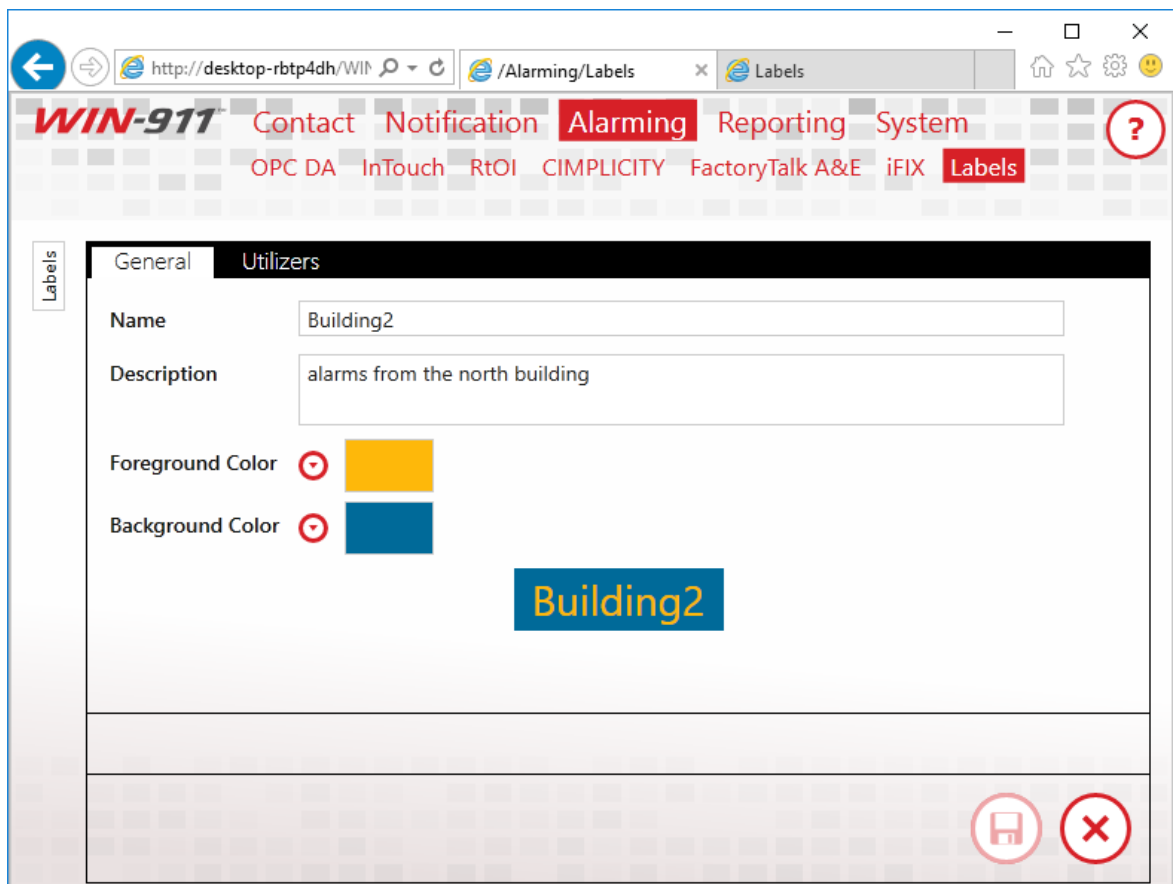

Name

This is a unique identifier for the Label. Make it as descriptive as possible.

Description

The Description adds extra context to your Label. This is an optional field.

Colors

Each Label may be assigned a foreground and a background color. This is a great way to make Labels visually distinctive in Notifiers which can display them, like Email or the Log Viewer.

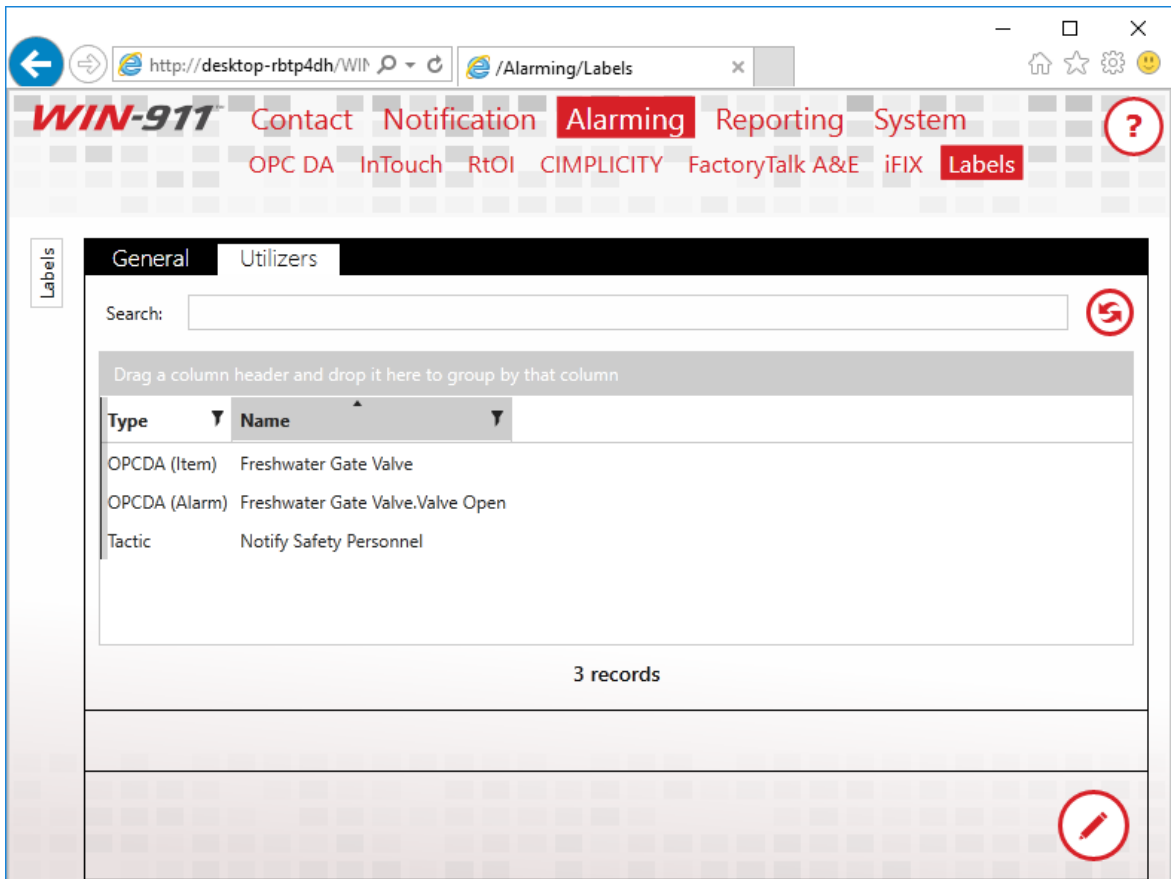

The screenshot shows a web browser window with the URL `http://desktop-rbtp4dh/WIN/Alarming/Labels`. The page features a navigation menu with tabs for **Contact**, **Notification**, **Alarming** (highlighted), **Reporting**, and **System**. Below this, there are sub-tabs for **OPC DA**, **InTouch**, **RtOI**, **CIMPLICITY**, **FactoryTalk A&E**, **iFIX**, and **Labels** (highlighted). The main content area is titled "Labels" and has two sub-tabs: **General** and **Utilizers**. A search bar is present with a refresh icon. Below the search bar is a table with the following data:

Type	Name
OPCDA (Item)	Freshwater Gate Valve
OPCDA (Alarm)	Freshwater Gate Valve.Valve Open
Tactic	Notify Safety Personnel

At the bottom of the table, it indicates "3 records". There are also icons for help (question mark) and edit (pencil) in the interface.

Utilizers

WIN-911 User Guide

Labels may be applied to alarms, filters, or data items and referenced in Advanced Tactics by Decision Blocks. The list of items which reference the Label is displayed here. If a Label is in use, it may not be deleted. Use this screen to determine where the current Label is referenced.

Reporting

Reports provide operational data that is not necessarily associated with alarm conditions. Reports can be dispatched in accordance with a strategy or in response to a query from a remote user.

Reports can be used to:

- query current operating conditions
- provide additional context to alarm events
- organize information

Note: Not all data sources support Reporting.

The screenshot shows a configuration window for a report. The title bar reads 'Reports Utilizers'. The 'Number' field is set to 3, and the 'Name' field is 'Fresh Water Storage 3'. The 'Description' field is empty. Below these fields is a table of items:

Number	Type	Alarm Point	Name	Source	Area	Condition	Severity
<input type="checkbox"/> 1	Data	SCADA.FreshWaterTank.GateValve	SCADA.FreshWaterTank.GateValve	OPCDA			
<input type="checkbox"/> 2	Data	SCADA.Wastewater.LiftPump.OnState	SCADA.Wastewater.LiftPump.OnState	OPCDA			
<input type="checkbox"/> 3	Data	SCADA.Wastewater.Tank.Level	SCADA.Wastewater.Tank.Level	OPCDA			
<input type="checkbox"/> 4	Data	SCADA.FreshWaterTank.Level	SCADA.FreshWaterTank.Level	OPCDA			
<input type="checkbox"/> 5	Data	SCADA.FreshWaterTank.PumpFlow	SCADA.FreshWaterTank.PumpFlow	OPCDA			

At the bottom of the table, there are several control icons: a red circle with a plus sign (+), a red circle with an up arrow (^), a red circle with a down arrow (v), a red circle with a trash can icon, and a red circle with an 'x' icon. At the bottom right of the window, there are two more icons: a red circle with a save icon (floppy disk) and a red circle with an 'x' icon.

Number

Each report must have a unique number that distinguishes it from the others. When WIN-911 delivers a report, this number will be used to

identify it. This number may also be used to request the report (instead of requesting by name).

Name

Each report must have a unique name.

Description

An extra text field for organization and administration purposes. The description can contain location data (like Lift Station 22), or a description of the data/alarm that adds additional context.

Items and Alarms

Select the items and/or alarms to be included in a Report. Clicking the  button in edit mode will bring up the Items/Alarms selection form. A search filter is provided at the top of the item list to limit the displayed items based on the selected property and text entered in the search text entry box.

Rectangular Table

Items Alarms

Search:

Drag a column header and drop it here to group by that column

<input type="checkbox"/>	Name	Alarm Point	Source	Area	Labels
<input type="checkbox"/>	Pump	Pump	OPCDA		
<input checked="" type="checkbox"/>	SCADA.FreshWaterTank.GateValve	SCADA.FreshWaterTank.GateValve	OPCDA		
<input type="checkbox"/>	SCADA.FreshWaterTank.Level	SCADA.FreshWaterTank.Level	OPCDA		
<input checked="" type="checkbox"/>	SCADA.Wastewater.Tank.Level	SCADA.Wastewater.Tank.Level	OPCDA		

2 of 4 selected

✓ ✗

System

Info

Serial Number: This number specifies information about the software which may be required when contacting WIN-911 Software.

Support Code: The support code identifies what support services this product is entitled to. It may be required when contacting WIN-911 Software for support.



Standby, Activate WIN-911

WIN-911 can be put into "Standby", which stops WIN-911 from conducting alarm notifications. From "Standby" WIN-911 can then be activated by clicking the "Activate" button, causing the remote notifications to resume.

System Info

Info

System Info is a pooling of platform-specific information that is useful for administrative and support efforts. Here, in one, convenient location, you will find important information that pertains to your specific installation, including licensing and support numbers (important to have when contacting WIN-911 Software), installed modules, and contact information.

Release Version:	4.19.16
License:	Demo (Expires in 29 days)
Serial Number	0
Support Code	12345678 
SQL Server:	WIN-JL419KQ9AST\WIN911
Language	English 

Installed Modules:

- Dispatcher
- Email
- Mobile
- Navigation
- OPC DA
- Reporting

WIN-911 Software
2024 E. St. Elmo Rd.
Austin, TX 78744
<http://win911.com>

Support:
+1-512-326-1011 ext. 3
<http://win911.com/support/>

Release Version

WIN-911 User Guide

The version of the WIN-911 product deployed on this system.

License

The license identifies whether your WIN-911 system is valid and what features are enabled. The license may change over the lifecycle of the WIN-911 system.

Serial Number

The Serial Number is a platform-unique number that identifies the particular installation on a physical machine. It remains constant throughout the lifecycle of the WIN-911 system and is often required when calling WIN-911 Software for sales/technical support.

Support Code

The support code indicates the status of the support contract associated with this WIN-911 system. Support contracts are purchased for a span of time and require renewal when they expire. Please contact WIN-911 Software to review your options with a sales representative (contact info below). New installations include the first six-months of technical support, after which, annual support contracts are available for purchase.

SQL Server

WIN-911 stores configuration information in a pool of SQL databases. The SQL Server entry identifies the particular instance of the SQL Server this WIN-911 system utilizes.

Language

This is the language with which the WIN-911 Workspace will be presented. It can be changed using the edit button to the right. Please

note that you may have to reboot for the change to be properly processed.

Installed Modules

The Install Modules table lists all of the WIN-911 modules that have been installed on this WIN-911 system.

Contact Information

WIN-911 Software's physical address, website, phone number, etc.

Standby & Activate

Standby, Activate WIN-911

WIN-911 can be put into "Standby", which stops WIN-911 from conducting alarm notifications. From "Standby" WIN-911 can then be activated by clicking the "Activate" button, causing the remote notifications to resume.

WIN-911 Log Viewer

WIN-911 activity can be monitored using the *WIN-911 Log Viewer*. This tool displays alarm events and notification activity that WIN-911 is conducting, presented in a convenient format that allows the user to view, sort, and trace WIN-911 activity. The Log Viewer has two presentations, *Alarms* and *Notifications*. The presentations list the same data but differ somewhat by their perspectives, giving the user different ways to sort through and analyze the data. It can be used to acknowledge alarms, monitor WIN-911's operation status, and troubleshoot escalation routines.

Alarms

The *Alarms* view is organized from the perspective of the alarm life-cycle and catalog events that result from it.

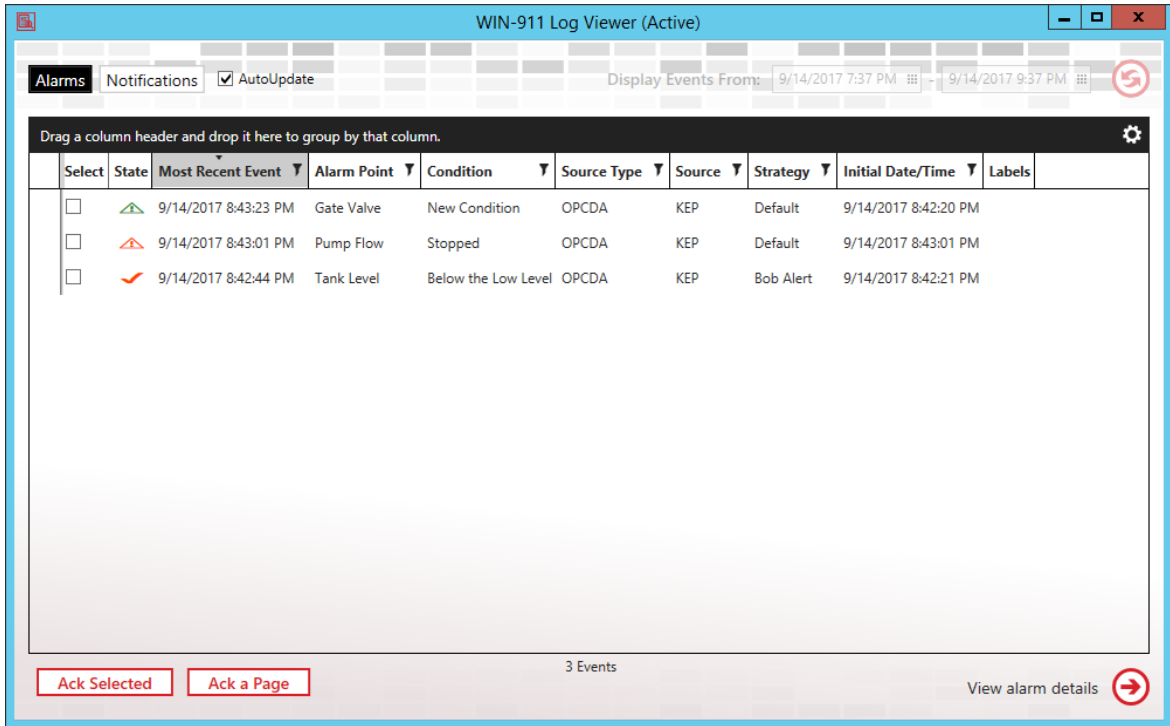

Located in the upper banner of the WIN-911 Log Viewer is an indicator that displays the operational mode of WIN-911. Valid indications should be Active or Standby.

AutoUpdate

When AutoUpdate is selected, the Viewer dynamically refreshes every five seconds, ensuring the user a near-live experience of current WIN-911 activity. All alarms in a terminal state (ended their life-cycle) are suppressed, clearing the view for current alarms. When AutoUpdate is not selected, the viewer enters a static state and shows all of the alarm events that occurred within the selected time period, including alarms that are no longer active. It allows the user to look back at a segment of time that is determined using the *Display Events From* date/time brackets.

Settings

The user can customise the display by selecting which columns of data to include. Click on the gear icon located on the upper-right. From the selection list you can choose to include columns by checking the box to the right of the option. The available columns depend on the selected view and include:

- Select: Check-box that selects the associated alarm event.
- State: Icon indicating Active/Inactive, Acknowledged/Unacknowledged
- Most Recent Event: Date and time of the most recent activity concerning the associated alarm event.
- AlarmLifetimeld: WIN-911 assigns each alarm event an internal GUID that identifies it. This GUID is referred to as AlarmLifetimeld and is included as an option for display.
- Alarm Point: Tagname of point name of the individual alarm
- Condition: High, HiHi, Low, LoLo, Opened, Closed, etc.
- Source Type: The type of data source or SCADA (HMI) that the alarm event originates from.
- Source: Specific data server that the alarm event originates from.
- Strategy: the name of the strategy that the alarm event is assigned.
- Initial: Date/Time when the alarm event is triggered.
- Labels: Label assigned to the alarm event for organization and remote notification processing.

WIN-911 Log Viewer Collection Selector List

Alarm event entries can be grouped, filtered, and sorted using the tools located across the top of the view window. The black bar running across the top is a grouping workspace where column headers can be dragged and dropped. In the column headers themselves is a filtering tool to right of the column titles. This combination of tools allows the user a virtually unlimited array of ways to focus the view window to meet his/her specific needs.

Alarms View

The Alarm view has two pages that the user can toggle between, the alarm event list (default), and the alarm details. The alarm event list displays, in AutoUpdate mode, displays all current alarm event. With AutoUpdate unselected the display lists all alarm events that occurred between the time and brackets selected by the user. The alarm details page expands the focus of the selected alarm event, giving the user a multi-tabbed display that allows the user to drill-down into various details of the alarm event. The tabs include Notification, Acknowledgement, Strategy Execution, Tactic Execution, and State Change.

Alarms View with AutoUpdate

WIN-911 Log Viewer (Active)

Alarms Notifications AutoUpdate Display Events From: 9/14/2017 7:37 PM -- 9/14/2017 9:37 PM

Drag a column header and drop it here to group by that column.

Select	State	Most Recent Event	Alarm Point	Condition	Source Type	Source	Strategy	Initial Date/Time	Labels
<input type="checkbox"/>		9/14/2017 8:43:23 PM	Gate Valve	New Condition	OPCDA	KEP	Default	9/14/2017 8:42:20 PM	
<input checked="" type="checkbox"/>		9/14/2017 8:43:01 PM	Pump Flow	Stopped	OPCDA	KEP	Default	9/14/2017 8:43:01 PM	
<input type="checkbox"/>		9/14/2017 8:42:44 PM	Tank Level	Below the Low Level	OPCDA	KEP	Bob Alert	9/14/2017 8:42:21 PM	

1 of 3 Events

Ack Selected Ack a Page View alarm details

WIN-911 Log Viewer in AutoUpdate mode. This mode will only show current (in-progress) alarms. The view is automatically refreshed every

five seconds. Alarms can be acknowledged by selecting the desired alarms(s) and clicking the Ack Selected button at the lower left corner of the viewer. When in the Alarms view, you can toggle the viewer into alarm details mode by double-clicking the desired alarm event.

Acknowledging Alarms with WIN-911 Log Viewer (optional - configurable)

Alarms can be acknowledged in a selective manner by clicking the selection box followed by the "Ack Selected" button. The alarms can also be acknowledged a page-at-a-time, with the "Ack a Page" button. This will acknowledge all the alarm that are visible on the page.

When acknowledging an alarm from the WIN-911 Log Viewer, select the desired alarm and click the Ack Selected button.

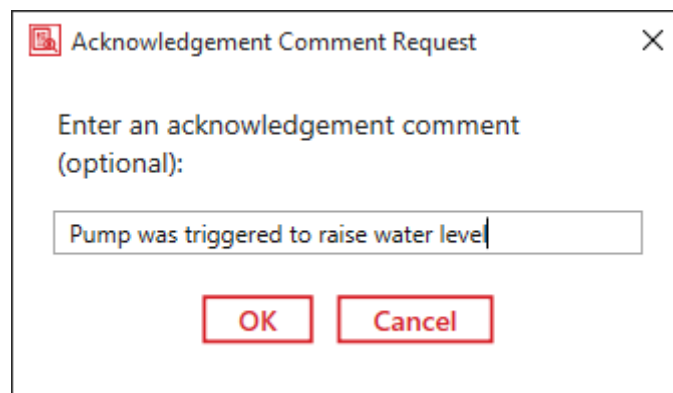

A confirmation pop-up box will appear and present the actor with the option to add a comment. Click OK to process the acknowledgement.

The ability to perform this action with the WIN-911 Log Viewer is configurable by the WIN-911 administrator. The default setting is to allow the Log Viewer to ack. However, this can be disabled by changing the following setting.

WIN-911 User Guide

Open the File Explorer (with file name extensions visible) and find the file titled "WIN911.Log.Viewer.exe.config". The default location is shown below.

```
C:\Program Files (x86)\WIN-911 Software\WIN-911  
Enterprise\Dispatcher\WIN911.Log.Viewer.exe.config
```

Open the file with Notepad and scroll to the bottom where you will find a block titled "<applicationSettings>".

```
<applicationSettings>  
  <WIN911.Log.Viewer.Properties.Settings>  
    <setting name="ShowAckButtons" serializeAs="String">  
      <value>True</value>  
    </setting>  
  </WIN911.Log.Viewer.Properties.Settings>  
</applicationSettings>  
</configuration>
```

Change "<value>*True*</value>" to "<value>*False*</value>", then save and close the file. The next time you open the WIN-911 Log Viewer the Acknowledge button will not be present. To re enable the button, simply restore the <value> to *True*.

Alarms View without AutoUpdate

WIN-911 Log Viewer (Active)

Alarms Notifications AutoUpdate

Display Events From: 9/14/2017 7:37 PM - 9/14/2017 9:37 PM

Drag a column header and drop it here to group by that column.

Select	State	Most Recent Event	Alarm Point	Condition	Source Type	Source	Strategy	Initial Date/Time	Labels
<input type="checkbox"/>		9/14/2017 8:43:23 PM	Gate Valve	New Condition	OPCDA	KEP	Default	9/14/2017 8:42:20 PM	
<input type="checkbox"/>		9/14/2017 8:43:01 PM	Pump Flow	Stopped	OPCDA	KEP	Default	9/14/2017 8:43:01 PM	
<input type="checkbox"/>		9/14/2017 8:42:44 PM	Tank Level	Below the Low Level	OPCDA	KEP	Bob Alert	9/14/2017 8:42:21 PM	
<input type="checkbox"/>		9/14/2017 8:28:03 PM	Gate Valve	New Condition	OPCDA	KEP	Default	9/14/2017 8:27:44 PM	
<input type="checkbox"/>		9/14/2017 8:26:54 PM	Pump Flow	Stopped	OPCDA	KEP	Default	9/14/2017 8:26:54 PM	

5 Events

Ack Selected Ack a Page View alarm details

This mode will display the entire history of the alarm events life cycle (current and expired) that occurred within the selected date and time as specified by user via the input tool located at the upper right. You can toggle into the alarm details page by double-clicking on the desired alarm event.

Alarm Details View, Notification Tab

WIN-911 User Guide

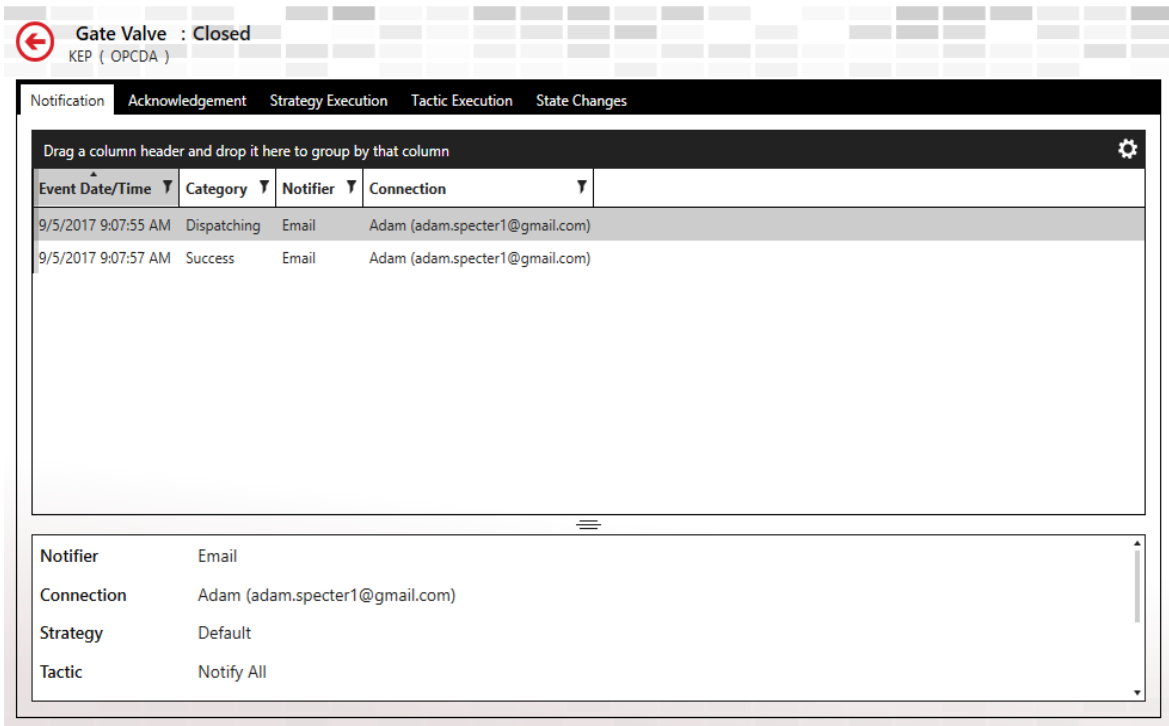

The Notification tab will list the notification tasks that have been dispatched by the dispatcher and the results of the task as reported back by the notifier module.

There are handles located on the borders of each viewing window that allows the users to modify the viewing area. When the amount of data exceeds what can be displayed at one time scroll bars appear to the right and bottom that the user can scroll through the full extent of the contents.

Alarm Details View, Acknowledgement Tab

The screenshot shows the 'Acknowledge' tab of the WIN-911 Log Viewer. At the top, a status bar indicates 'Tank Pump : Pump is on' with 'KEP (OPCDA)' below it. The main interface has a dark header with tabs: 'Notification', 'Acknowledge', 'Strategy Execution', 'Tactic Execution', and 'State Changes'. The 'Acknowledge' tab is active, displaying a table of acknowledgement activity. The table has two columns: 'Event Date/Time' and 'Actor'. Two entries are listed, both from '9/5/2017 9:32:06 AM' by 'WIN-911 Log Viewer'. To the right of the table, the 'Actor' is 'WIN-911 Log Viewer' and the 'Comment' is 'water level decreasing'. At the bottom of the window, there is a red-bordered 'Acknowledge' button.

Event Date/Time	Actor
9/5/2017 9:32:06 AM	WIN-911 Log Viewer (via source)
9/5/2017 9:32:06 AM	WIN-911 Log Viewer

Actor: WIN-911 Log Viewer
Comment: water level decreasing

Acknowledge

The acknowledgement tab will list all of the acknowledgement activity associated with the selected alarm event. If the alarm is yet unacknowledged then the Acknowledge button will be available at the bottom. The information will include time and date of the activity and the actor.

Note: The Acknowledge button is an optional setting. It can be disabled by following the settings listed above in the "Acknowledging Alarms with WIN-911 Log Viewer" section.

Alarm Details View, Strategy Execution Tab

WIN-911 User Guide

The screenshot shows the WIN-911 interface. At the top, there is a red circular icon with a white arrow pointing left, followed by the text "Tank Pump : Pump is on" and "KEP (OPCDA)". Below this, there is a navigation bar with five tabs: "Notification", "Acknowledgement", "Strategy Execution", "Tactic Execution", and "State Changes". The "Strategy Execution" tab is currently selected. Below the navigation bar, the text "Strategy: Default" is displayed. A table with three columns is shown: "Event Date/Time", "Policy Trigger", and "Policy Action". The table contains four rows of data:

Event Date/Time	Policy Trigger	Policy Action
9/5/2017 9:10:20 AM	Initial Event	StartTactic (Notify All)
9/5/2017 9:10:40 AM	AnyStateChange (Active Changed)	Notify Previous
9/5/2017 9:32:06 AM	Alarm Becomes Terminal	Stop Strategy
9/5/2017 9:32:06 AM	AnyStateChange (Ack Changed)	Notify Previous

The strategy execution tab lists all of the strategy's activity as processed by the policies triggered. Information includes the time/date, policy trigger, and policy action.

Alarm Details View, Tactic Execution Tab

← Tank Pump : Pump is on
KEP (OPCDA)

Notification Acknowledgement Strategy Execution **Tactic Execution** State Changes

Tactic: Notify All

Event Date/Time	Details
9/5/2017 9:10:20 AM	Tactic Starting...
9/5/2017 9:10:20 AM	StartBlock BlockIdentifier: O
9/5/2017 9:10:20 AM	NotifyAllBlock BlockIdentifier: Ov
9/5/2017 9:10:20 AM	NotifyAllBlock BlockIdentifier: Ov Identified 1 connections (or
9/5/2017 9:10:20 AM	NotifyAllBlock BlockIdentifier: Ov Finished all notification disp
9/5/2017 9:10:20 AM	NotifyAllBlock BlockIdentifier: Ov Dispatching notification to
9/5/2017 9:10:20 AM	Tactic Terminated
9/5/2017 9:10:20 AM	EndBlock BlockIdentifier: OvX

No Item Selected

The tactic execution tab lists the activities of each of the tactics that have been triggered by the controlling strategy. Information includes event time/date and details.





Alarm Details View, State Change Tab

WIN-911 User Guide



The State Change tab lists the states of the alarm event. The information includes event time/date, alarm state icon and state change text.

The various states include:

-  Active and unacknowledged
-  Inactive and unacknowledged
-  Active and acknowledged
-  Inactive and acknowledged

Notifications

The *Notifications* view breaks out the notification process, step-by-step, by listing them chronologically.

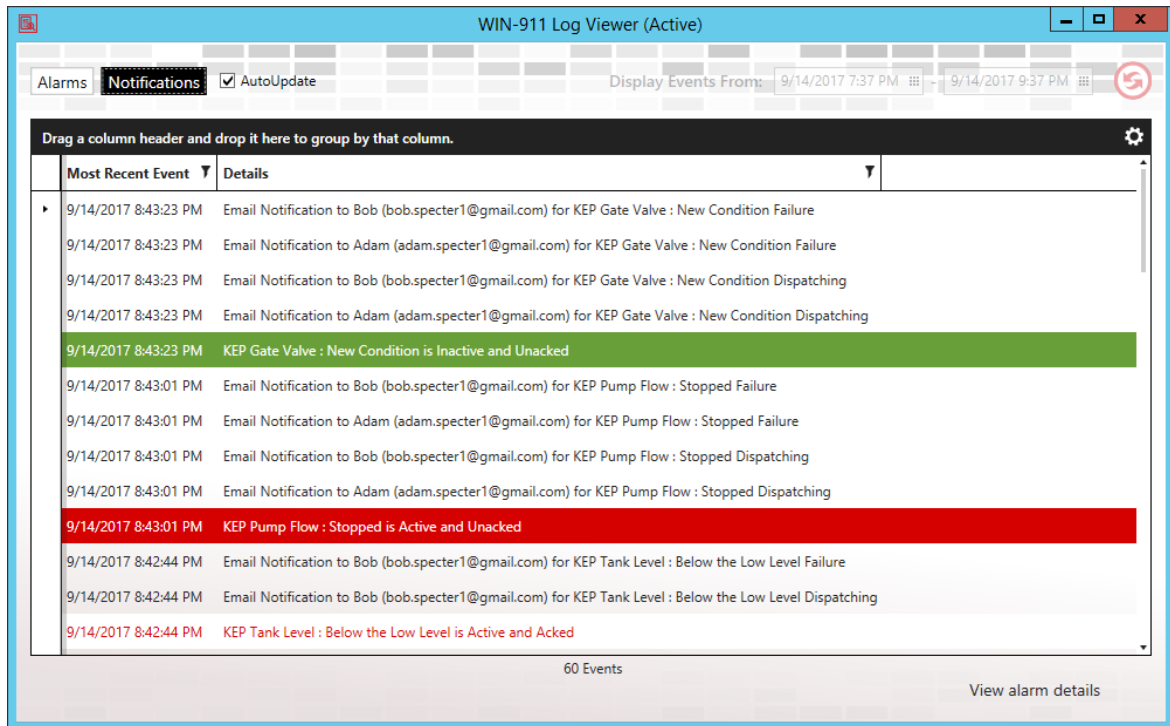

The view has two columns of data: the time-date column for sorting, and the details column. You can view it with the AutoUpdate option and focus your view on current events, or without for a historical view that includes everything, active or otherwise.

Alarm events are color-coded to represent the state of the alarm at the time of the event.

Active, Unacknowledged

Active, Acknowledged

Inactive, Unacknowledged

Inactive, Acknowledged (Terminal)

WIN-911 and Redundancy

Any "best practices" method for ensuring operational integrity should include the consideration of redundancy in the event that critical software or hardware fails. WIN-911 should be considered a mission-critical part of your operational nucleus and therefore have a plan for emergency situations where WIN-911 is no longer able to dispatch alarm events.

WIN-911 does not currently have redundancy logic that is able to determine the need for and/or execute a failover. But it does provide the system administrator with tools that can be used by third-party software to evaluate the health of WIN-911 and perform a failover when such a need should arise. These tools can provide information about the state of WIN-911 and change the operational mode of WIN-911 from Standby to Active or Active to Standby.

WIN-911 has two modes of operation, Active and Standby. Active is the default mode and actively monitors alarm events and dispatches remote alarm notifications. Standby is a mode that will suspend all remote notifications but does actively monitor alarm events. The mode of operation can be polled by third-party software and modified based on the results of the poll.

The tools are found in the Standby Activate folder (C:\Program Files (x86)\WIN-911 Software\WIN-911\Standby Activate). There you will find three command-line applications, Activate, IsActive, and Standby.

Activate: this command-line application, upon execution, will change the mode of operation for the local WIN-911 from Standby to Active. Once the mode is set to active the local WIN-911 will commence remote alarm notifications.

IsActive: this command-line application, upon execution, will query the local WIN-911 instance for its operational mode. There are two valid responses, Active (indicating that it is conducting remote notifications) or Standby (indicating that it is monitoring alarms but not conducting remote notifications). If the application does not receive a valid response from WIN-911 in a timely fashion then the querying application can assume that WIN-911 is not capable of responding.

Standby: this command-line application, upon execution, will change the mode of operation for the local WIN-911 from Active to Standby. Once the mode is set to standby the local WIN-911 will stop all remote alarm notifications while continuing to monitor alarms.

Trouble Shooting

WIN-911 Component's Operational Status

WIN-911 is designed to be an "always on" service that is available for alarm notification tasking and configuration editing at all times. However, components of WIN-911 can be shutdown manually or by the operating system under extraordinary circumstances.

Each module of WIN-911 is composed of an Application Server, which runs in IIS and a runtime executable that runs in the system's services. Thus, the dispatcher module is composed of a dispatcher application server and a dispatcher runtime executable. Each component is capable of running independently of the other. So, the application server can be running in IIS and the runtime service can be stopped (or vice-versa).

If there is any question about the operational status of the WIN-911 system, it can be verified by checking Services to ensure all modules labeled "WIN-911" are started and in automatic startup mode. The application servers can likewise be checked in the Internet Information Services (IIS) Manager.

WIN-911 AppServer's Operational Status

View the application server's status by clicking Start and entering *IIS* in the *Search programs and files* field. This will bring up the Internet Information Service (IIS) Manager. In the Connections tree (left pane) highlight Application Pools. This will bring up the list and status of application pools. Check that the following are started:

- WIN-911.Dispatcher
- WIN-911.Notifier.Email
- WIN-911.Source.OpcDa
- WIN-911.Reporting
- NavigationAppPool
- WIN-911.Notifier.Voice
- WIN-911.Notifier.Mobile911
- WIN-911.Source.iFIX
- WIN-911.Source.FTAE
- WIN-911.Source.Cimplicity
- WIN-911.Notifier.SMS

WIN-911 Services Status

View the services status by clicking *Start* and entering *Services* in the *Search programs and files* field. This will bring up the Services administration window. Scroll to the W section of the list and check that the following are started:

- WIN-911 Dispatcher Runtime
- WIN-911 Email Runtime
- WIN-911 OPC DA Source Runtime
- WIN-911 Reporting Runtime
- WIN-911 Cimplicity Runtime
- WIN-911 FTAE Runtime
- WIN-911 Mobile-911 Runtime
- WIN-911 Navigation Runtime
- WIN-911 Voice Runtime
- WIN-911 SMS Runtime

WIN-911 Diagnostic Information

WIN-911 User Guide

WIN-911 writes information, error, and warning messages to the event logger within the operating system and these messages can be queried using the Event Viewer and the WIN-911 Dispatcher Diagnostic tool.

There are three modes of detail intensity that the WIN-911 Administrator can choose from while testing and troubleshooting: Default or Debug. The default setting logs standard information, warnings and errors, while debug logs finer details concerning the program activity. These options are set as follows:

1. Stop all WIN-911 AppServers (IIS) and WIN-911 Runtime Services (listed above).
2. Open Windows Explorer and navigate to *c:\inetpub\wwwroot\Dispatcher*.
3. Open *Web.config* with Notepad and use the *Edit\Find* tool to locate string "*loggingFlags*".
4. Change the *loggingFlags* value from "*Default*" to "*Debug*".
5. Save this file and close *Notepad*.
6. Navigate back one folder to *wwwroot* and repeat steps 2 through 6 for any other module you are troubleshooting.
7. Start all WIN-911 modules (AppServers and Runtime Services) and conduct troubleshooting.

Once troubleshooting is complete you will want to return your "*loggingFlags*" back to the "*Default*" setting. Use the procedure listed above but replace the words "*Debug*" with "*Default*".

Event Viewer

To view system messages click *Start* and enter *Event Viewer* in the *Search programs and files* text box. This will bring up the event viewer. Dispatcher messages are written to the *Windows Logs>Application* log. All other module messages are written to the *Applications and Services Logs>WIN-911*. System messages concerning WIN-911 will appear in the center pane with options to view general and detailed information

about the selected message. These messages can be used to troubleshoot issues and can be attached an Email message that can send to WIN-911 Tech Support for evaluation.

Note: Error message generated by Mobile-911 Server are written to Applications and Services Logs>Mobile-911.

WIN-911 Log Viewer

WIN-911 Software developed a convenient tool for viewing system messages concerning the dispatcher module which is the main engine of WIN-911, responsible for executing strategies and tactics. The Log Viewer presents a verbose history of strategies and their related tactics by capturing a snap-shot of events and messages at the time the diagnostics tool was launched. It can be refreshed by relaunching the tool.

Select the event you wish to evaluate. Each event has six properties (Initial Date/Time, Alarm Point, Condition, Source Type, Source, and Strategy) that can be filtered as well as time window with a beginning and end time to constrain the viewer presentation.

Double-click on the desired event to bring up a detailed list of diagnostic information. The data is divided into notification, acknowledgement, strategy and tactics execution groups. A red background on an event indicates the presence of an error that was logged during the event. A yellow background indicates the presence of a warning.

Remote Standby & Activate

Overview

The Standby status of a WIN-911 Dispatcher module can be both accessed and controlled across the network through the utilization of three simple applets. These applets are particularly useful when scripting hot backup failovers within your SCADA system or for displaying the Standby status of one or more WIN-911 systems within your HMI. Details of the applets and their behavior follow.

Target

By default, each applet targets the WIN-911 Dispatcher installed on the local computer. This can be easily modified in the .config XML file accompanying each applet. Simply open the appropriate configuration file with a text editor and change the endpoint address (highlighted in the figure below) from localhost to the name or IP address of the target system. Typically the computer name is recommended as IP addresses can be dynamic.

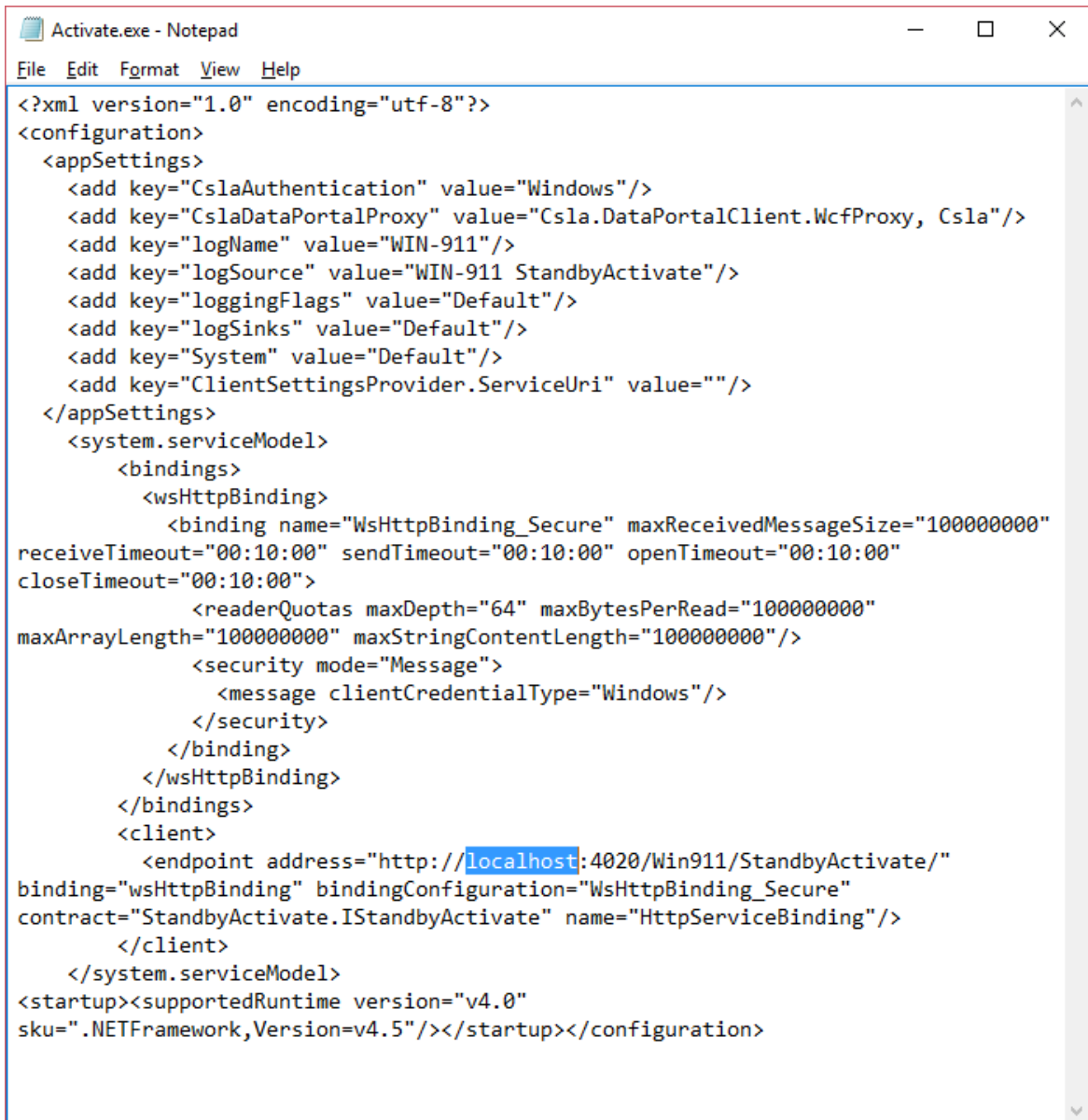

```

Activate.exe - Notepad
File Edit Format View Help
<?xml version="1.0" encoding="utf-8"?>
<configuration>
  <appSettings>
    <add key="CsIaAuthentication" value="Windows"/>
    <add key="CsIaDataPortalProxy" value="CsIa.DataPortalClient.WcfProxy, CsIa"/>
    <add key="logName" value="WIN-911"/>
    <add key="logSource" value="WIN-911 StandbyActivate"/>
    <add key="loggingFlags" value="Default"/>
    <add key="logSinks" value="Default"/>
    <add key="System" value="Default"/>
    <add key="ClientSettingsProvider.ServiceUri" value=""/>
  </appSettings>
  <system.serviceModel>
    <bindings>
      <wsHttpBinding>
        <binding name="WsHttpBinding_Secure" maxReceivedMessageSize="100000000"
receiveTimeout="00:10:00" sendTimeout="00:10:00" openTimeout="00:10:00"
closeTimeout="00:10:00">
          <readerQuotas maxDepth="64" maxBytesPerRead="100000000"
maxArrayLength="100000000" maxStringContentLength="100000000"/>
          <security mode="Message">
            <message clientCredentialType="Windows"/>
          </security>
        </binding>
      </wsHttpBinding>
    </bindings>
    <client>
      <endpoint address="http://localhost:4020/Win911/StandbyActivate/"
binding="wsHttpBinding" bindingConfiguration="WsHttpBinding_Secure"
contract="StandbyActivate.IStandbyActivate" name="HttpServiceBinding"/>
    </client>
  </system.serviceModel>
<startup><supportedRuntime version="v4.0"
sku=".NETFramework,Version=v4.5"/></startup></configuration>

```

NOTE: The default install location for these applets is a protected directory and will require elevated privileges to make configuration file edits. You can run your text editor as Administrator or make a copy of the applets to a more accessible directory.

Applets can be copied onto machines across the network from WIN-911. When copying an applet to another location on the network, be sure to also copy its configuration file and its two DLL dependencies. Copying the utility directory in its entirety is recommended.

Moreover, multiple copies of an applet can be made on a single machine to target different WIN-911 Dispatcher instances. Simply copy both the exe and its configuration file and rename the copies to match one another (e.g. Activate2.exe with Activate2.exe.config or Activate_Secondary.exe with Activate_Secondary.exe.config). You can now edit each configuration file to target different WIN-911 Dispatcher instances.

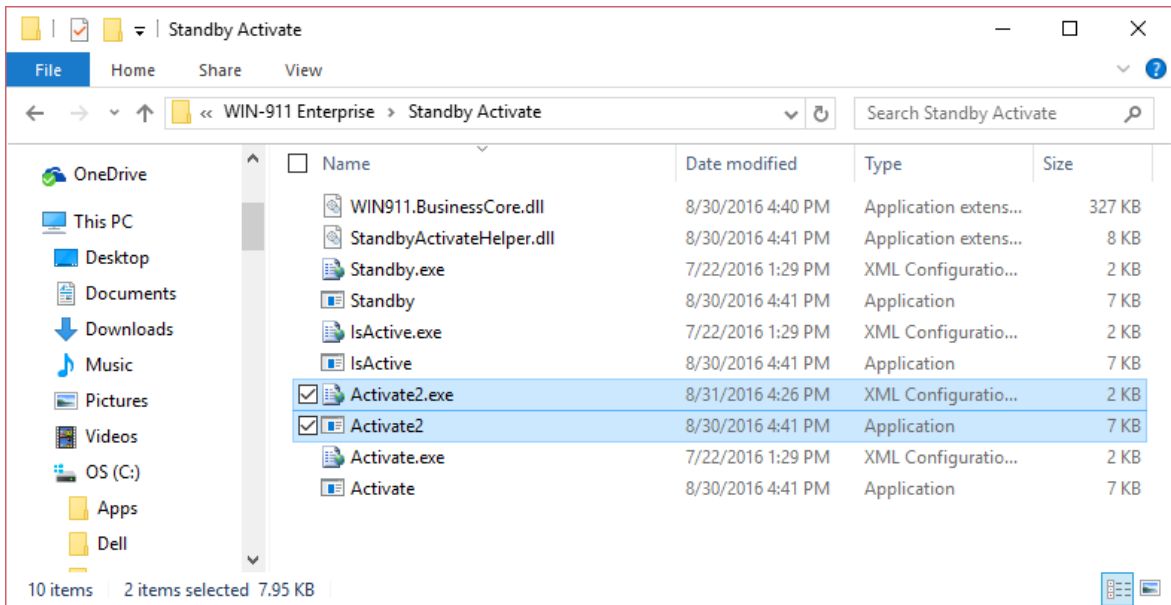

Network/Security Considerations

The applets use WCF for communication with the WIN-911 Dispatcher. By default, communications are secured at the message level by Windows and take place over HTTP on TCP port 4020. As such, the account under which the applets are executed must have credentials recognizable to the WIN-911 system (i.e. same domain or same username and password). Additionally, your network domain policy and firewalls should be adjusted to permit communication. These defaults can be changed by your system administrator – see the

following resource for more information:

[https://msdn.microsoft.com/en-us/library/ms733027\(v=vs.110\).aspx](https://msdn.microsoft.com/en-us/library/ms733027(v=vs.110).aspx)

Standby.exe

Description: This applet attempts to place the targeted WIN-911 Dispatcher in standby mode. Note that a Dispatcher already in standby mode will still indicate success when this applet is executed against it.

Success Return Code: 0

Success Console Output: localized string similar to "Dispatcher set to standby mode."

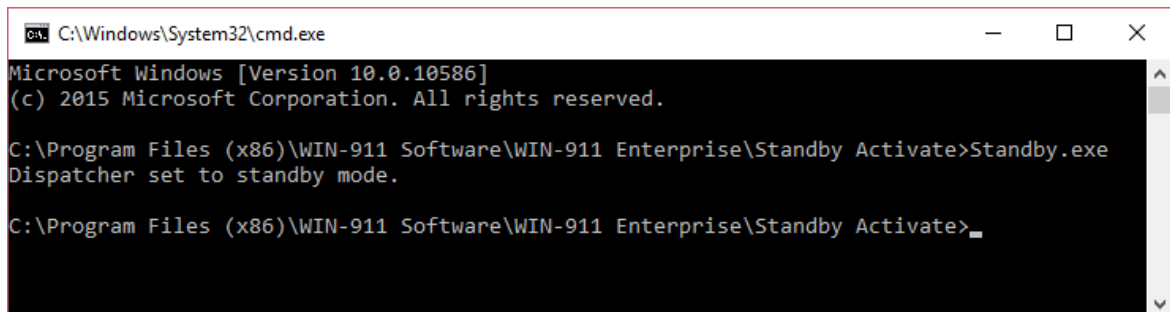

```
C:\Windows\System32\cmd.exe
Microsoft Windows [Version 10.0.10586]
(c) 2015 Microsoft Corporation. All rights reserved.

C:\Program Files (x86)\WIN-911 Software\WIN-911 Enterprise\Standby Activate>Standby.exe
Dispatcher set to standby mode.

C:\Program Files (x86)\WIN-911 Software\WIN-911 Enterprise\Standby Activate>
```

Failure Return Code: 1

Failure Console Output: localized string similar to "Unable to set mode."

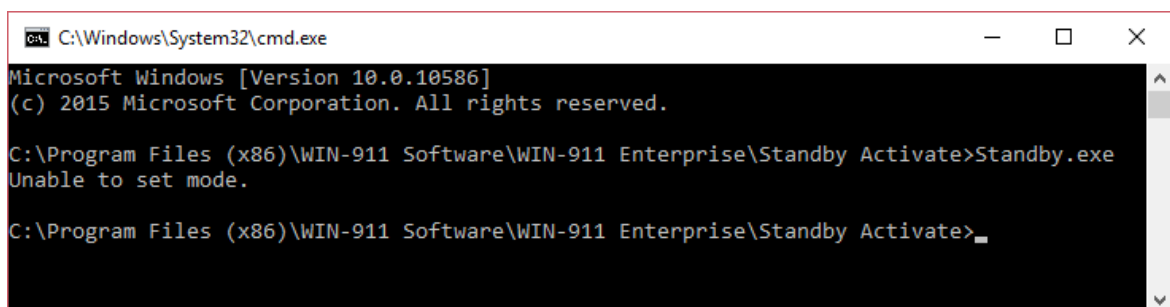

```
C:\Windows\System32\cmd.exe
Microsoft Windows [Version 10.0.10586]
(c) 2015 Microsoft Corporation. All rights reserved.

C:\Program Files (x86)\WIN-911 Software\WIN-911 Enterprise\Standby Activate>Standby.exe
Unable to set mode.

C:\Program Files (x86)\WIN-911 Software\WIN-911 Enterprise\Standby Activate>
```

Activate.exe

Description: This applet attempts to place the targeted WIN-911 Dispatcher in active mode. Note that a Dispatcher already in active mode will still indicate success when this applet is executed against it.

Success Return Code: 0

Success Console Output: localized string similar to "Dispatcher set to active mode."

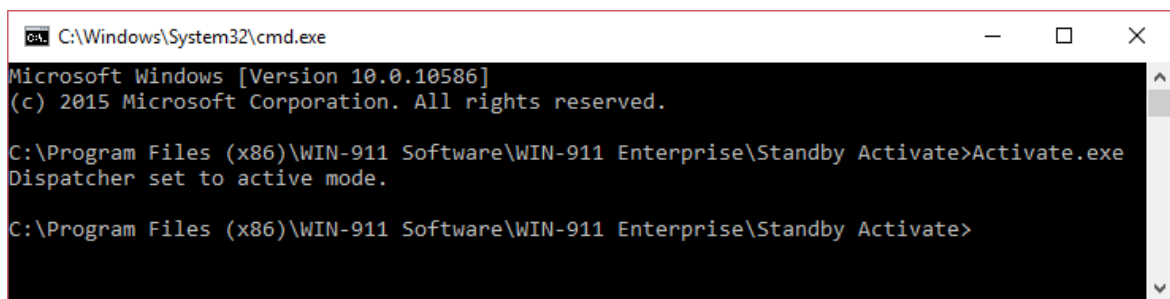

```
C:\Windows\System32\cmd.exe
Microsoft Windows [Version 10.0.10586]
(c) 2015 Microsoft Corporation. All rights reserved.

C:\Program Files (x86)\WIN-911 Software\WIN-911 Enterprise\Standby Activate>Activate.exe
Dispatcher set to active mode.

C:\Program Files (x86)\WIN-911 Software\WIN-911 Enterprise\Standby Activate>
```

Failure Return Code: 1

Failure Console Output: localized string similar to "Unable to set mode."

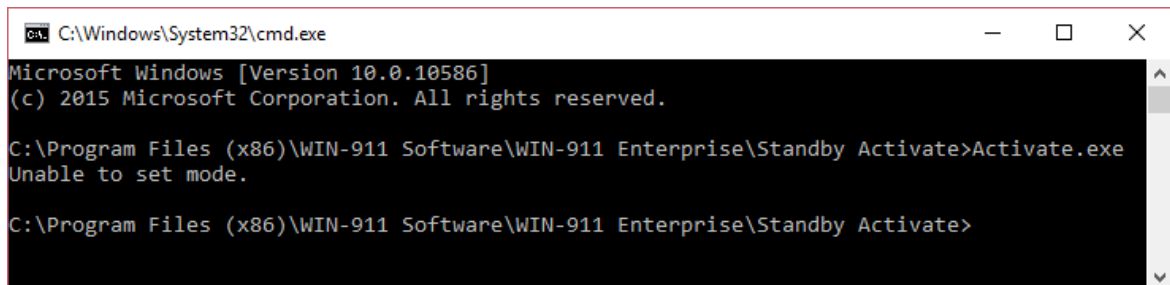

```
C:\Windows\System32\cmd.exe
Microsoft Windows [Version 10.0.10586]
(c) 2015 Microsoft Corporation. All rights reserved.

C:\Program Files (x86)\WIN-911 Software\WIN-911 Enterprise\Standby Activate>Activate.exe
Unable to set mode.

C:\Program Files (x86)\WIN-911 Software\WIN-911 Enterprise\Standby Activate>
```

IsActive.exe

Description: This applet attempts to request the current standby status of the targeted WIN-911 Dispatcher.

Success Return Code (Active): 0

Success Console Output (Active): localized string similar to "Active"

Success Return Code (Standby): 1

Success Console Output (Standby): localized string similar to "Standby"

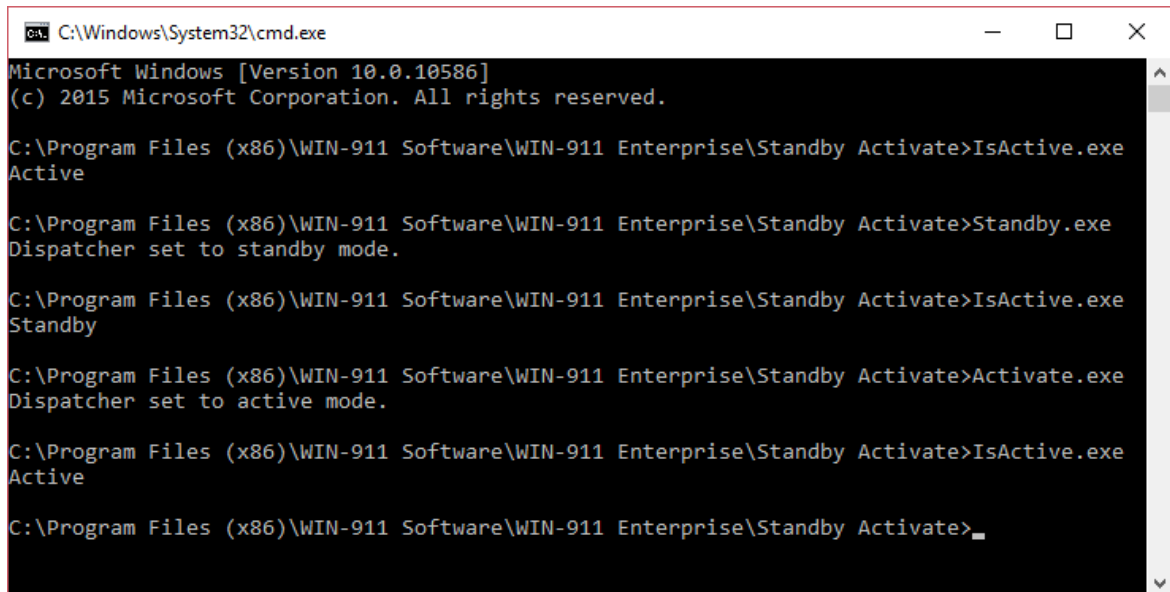

```
C:\Windows\System32\cmd.exe
Microsoft Windows [Version 10.0.10586]
(c) 2015 Microsoft Corporation. All rights reserved.

C:\Program Files (x86)\WIN-911 Software\WIN-911 Enterprise\Standby Activate>IsActive.exe
Active

C:\Program Files (x86)\WIN-911 Software\WIN-911 Enterprise\Standby Activate>Standby.exe
Dispatcher set to standby mode.

C:\Program Files (x86)\WIN-911 Software\WIN-911 Enterprise\Standby Activate>IsActive.exe
Standby

C:\Program Files (x86)\WIN-911 Software\WIN-911 Enterprise\Standby Activate>Activate.exe
Dispatcher set to active mode.

C:\Program Files (x86)\WIN-911 Software\WIN-911 Enterprise\Standby Activate>IsActive.exe
Active

C:\Program Files (x86)\WIN-911 Software\WIN-911 Enterprise\Standby Activate>_
```

Failure Return Code: -1

Failure Console Output: localized string similar to "Unknown"

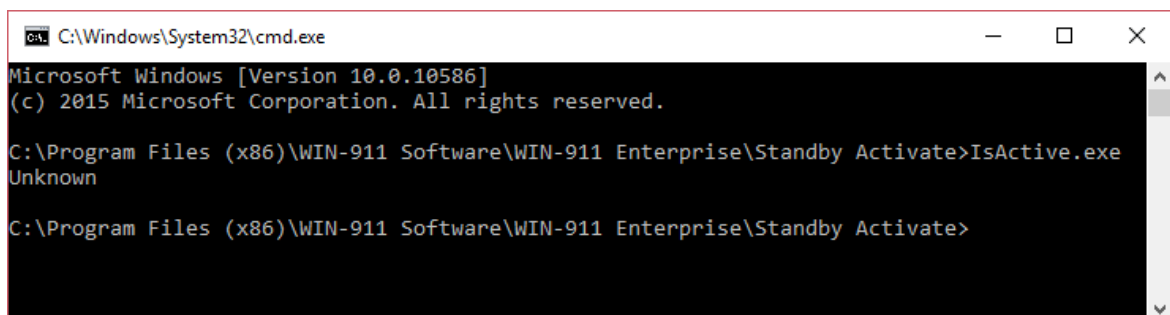

```
C:\Windows\System32\cmd.exe
Microsoft Windows [Version 10.0.10586]
(c) 2015 Microsoft Corporation. All rights reserved.

C:\Program Files (x86)\WIN-911 Software\WIN-911 Enterprise\Standby Activate>IsActive.exe
Unknown

C:\Program Files (x86)\WIN-911 Software\WIN-911 Enterprise\Standby Activate>
```

WIN-911 Network Module Mapper

Overview

WIN-911 is organized as a logical system comprising several interdependent modules. These modules can be installed collectively on a local, standalone platform or distributed across several computers, depending on your needs. These modules need to know the location of the other members of the logical system. For standalone systems, the WIN-911 installation process will create a module map automatically for you. However, you may wish to modify your WIN-911 system during the lifetime of the product, in which case, you will need to remap the WIN-911 modules using this tool.

The mapper scans the network looking for logical systems and records the location of each module. If the system is distributed across a network, then each computer in the system will need to have Auto Discovery enabled to be included in the scan.

This program may never be needed and is only provided for those special cases where the "Logical System" is required to change after the initial install. If a user decides to add a new module to the Logical system, the Main install will handle the remapping of the system after the new module is added. The most common case where the Module Mapper is required is when one or more of the modules are removed from the Logical system.

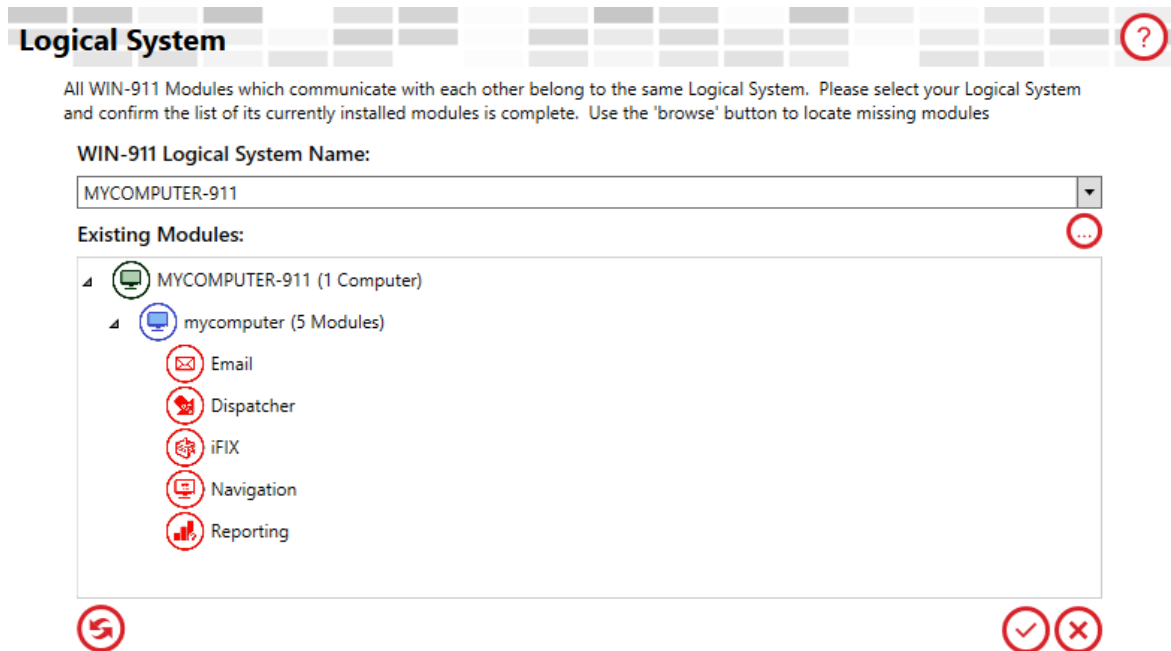

The module map, pictured above, maps six modules (red) spread across two computers (blue). These comprise a logical system named "Alarm Alert Manager" (green).

WIN-911 Logical System Name

Use this combo-box to select the Logical System you want to map.

Existing Modules

When the WIN-911 Logical System Mapper is launched it automatically scans your network for WIN-911 modules (this may take several minutes). When the scan completes, the modules are listed in a tree structure organized by Logical System > Computer > Module. If any modules are missing you can use the browse button  to search individual computers manually. Hovering over an individual module icons will show that module's version. Compatible modules are displayed in red.

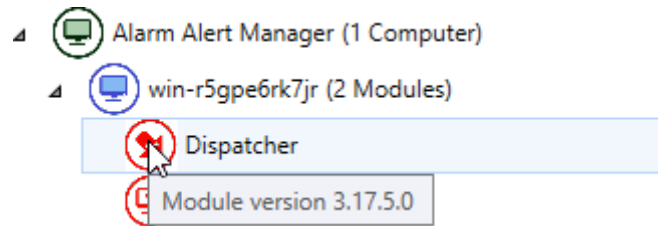

WIN-911 User Guide

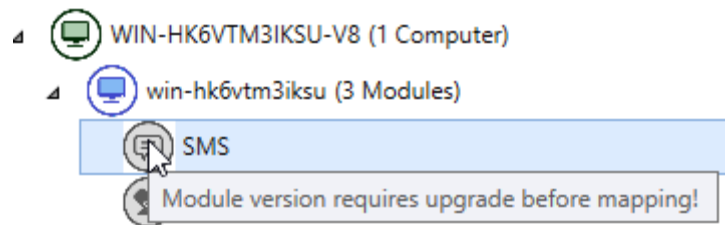

Modules that are incompatible with the Logical System appear in grey. These modules cannot be added to your system and must be upgraded before saving.



Miscellaneous Buttons

-  Refresh
-  Accept/Save
-  Cancel

Role Editor Utility

The WIN-911 Role Editor Utility is a console application that can modify or query Roles associated with a WIN-911 Connection. Execution of the utility may be scripted through your SCADA/HMI project, allowing operators to affect Role changes in WIN-911 without ever leaving the HMI. When combined with the role-based notification of Advanced Tactics, operators can even control whom will receive notifications.

Note: Advanced Tactics require an Advanced license.

Install Location

The Role Utility consists of two components which are installed with the Dispatcher module, an executable and its corresponding configuration file.

EXE

```
C:\Program Files (x86)\WIN-911 Software\WIN-911  
Enterprise\Dispatcher\Roleutility.exe
```

Config

```
C:\Program Files (x86)\WIN-911 Software\WIN-911  
Enterprise\Dispatcher\Roleutility.exe.config
```

Syntax

```
1 roleutility.exe cmd={add|remove|removeall|query}  
  notifier={email|sms|voice|mobile|mobile911} connectionid=<Connection ID>  
  roleid=<Role ID>
```

Arguments

cmd=add

Adds a Role to a Connection.

cmd=remove

Removes a Role from a Connection.

cmd=removeall

Removes all Roles from a Connection.

cmd=query

Returns all Roles assigned to a connection.

notifier

Specify the Notifier the Connection belongs to (email, sms, voice, or mobile911).

connectionid

Specify the Connection ID to modify (Must be a GUID). Connection IDs are located in the Connection IDs respective notifier SQL database. (See WIN-911 Connection GUIDs section below)

roleid

Specify the Role ID to add or remove from a Connection (Must be a GUID). Role IDs are located in the dispatcher SQL database table, RoleEntries. (See WIN-911 Role GUIDs section below)

Examples

Note: In the following examples, we are using randomly generated GUIDs. When you run the utility, you must use the GUID from your WIN-911 database.

Add Role to an Email Connection

```
1 roleutility.exe cmd=add notifier=email connectionid=974a8c2c-01e3-4aab-9955-3c8d4613eb15 roleid=54194883-f98f-4387-9af6-abbeef761aa5
```

Remove Single Role from an Email Connection

```
1 roleutility.exe cmd=remove notifier=email connectionid=974a8c2c-01e3-4aab-9955-3c8d4613eb15 roleid=54194883-f98f-4387-9af6-abbeef761aa5
```

Remove All Roles from an Email Connection

```
1 roleutility.exe cmd=removeall notifier=voice connectionid=974a8c2c-01e3-4aab-9955-3c8d4613eb15
```

Query Roles on an Email Connection

```
1 roleutility.exe cmd=query notifier=email connectionid=974a8c2c-01e3-4aab-9955-3c8d4613eb15
```

Where to Find GUIDs

The GUID (globally unique identifier) for a WIN-911 Connection and optional WIN-911 Role must be provided when running the Role

Utility. GUIDs for both Roles and Connections can be found in the WIN-911 configuration databases stored in MS SQL Server. The directions below will walkthrough locating GUIDs for Roles and Connections using MS SQL Server Management Studio.

Note: Before you can locate the GUIDs in your SQL databases, you must first create the Roles and Connections that you plan to use with WIN-911 Workspaces.

Accessing SQL Server

During installation of WIN-911, the installer offered to install a local instance of SQL Server Express with SQL Server Management Studio. If selected, an SQL instance named "WIN911" was created on the WIN-911 PC. If not selected, an SQL instance was manually entered. The SQL instance targeted by WIN-911 can be identified by launching WIN-911 Workspace and navigating to System / Info.

If the WIN-911 installer was used to install SQL Server, only the Windows user account used during installation has sysadmin permissions. The credentials of this account will be needed to login to the "WIN911" instance.

- Launch MS SQL Server Management Studio using a Windows account with access to the SQL instance.
 - If you are not sure which account to login with, open Windows Services, locate one of the WIN-911 services, the Windows account listed under the Log On As column can be used.
- After MS SQL Server Studio has launched, connect to the SQL Instance where your WIN-911 databases are located.
 - Again, if the WIN-911 Installer installed SQL Server Express for you, you will use "<SERVERNAME>\WIN911"

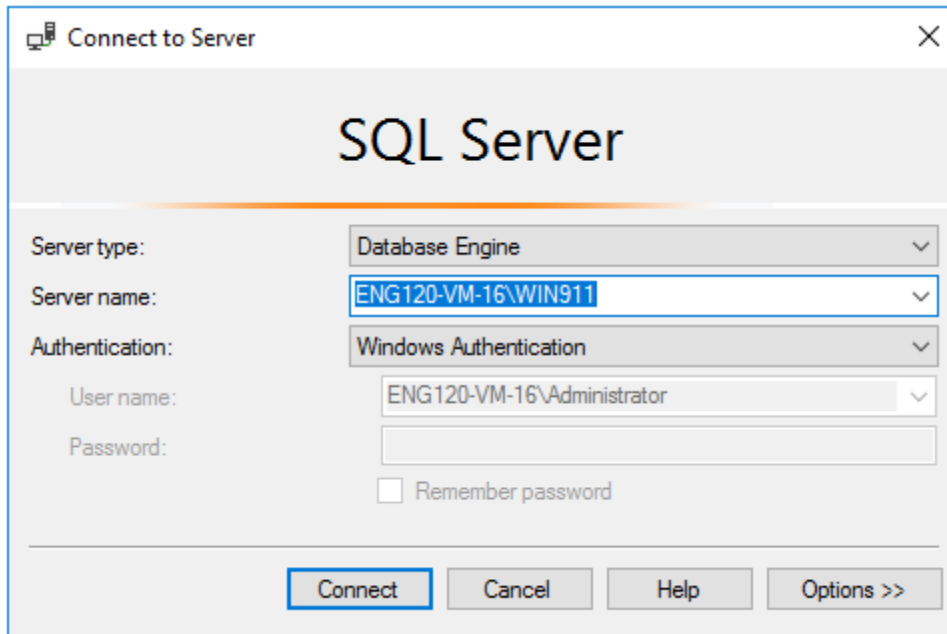

WIN-911 Role GUIDs

Roles are configured in the Dispatcher module, as such, their GUIDs are located in the Dispatcher's database.

- Using the Object Explorer in SQL Management Studio, expand WIN-911 Instance, Databases, ComputerName-911.Default.Dispatcher, and Tables
- Locate and right-click the dbo.RoleEntities table and click "Select Top 1000 Rows", this query will return a list of the Roles configured in the WIN-911 system.
- The GUIDs are located in the Id column.
 - The Name column displays the friendly name of the Role

	Id	Name	Description	ForegroundColor	BackgroundColor
1	9229DB32-0B5C-4343-B0AB-81153565FCB3	Managers	Managers of all levels	#FFFFFF	#FF008672
2	8450BE4A-A3D6-4694-99A5-C89835BCA6CD	Operators	Field Operators	#FFFE80A	#FF006A99

- When specifying the roleid for the Role Utility, use only the GUIDs that appear in this list.

WIN-911 Connection GUIDs

WIN-911 User Guide

Each WIN-911 Notifier has a database with the following naming convention, ComputerName-911.Default.NotifierName. Within each of these databases exists a table with the Connection IDs needed to run the Role Utility.

Database Name	Table Name
ComputerName-911.Default.Email	dbo.EmailConnectionEntities
ComputerName-911.Default.SMS	dbo.SmsConnectionEntities
ComputerName-911.Default.Voice	dbo.VoiceConnectionEntities
ComputerName-911.Default.Mobile911	dbo.Mobile911ConnectionEntities

For the purpose of this document, we'll use the Mobile-911 Notifier as an example.

- Using the Object Explorer in SQL Management Studio, expand WIN-911 Instance, Databases, ComputerName-911.Default.Mobile911, and Tables.
- Locate and right-click the dbo.Mobile911ConnectionEntities table and click "Select Top 1000 Rows", this query will return a list of the Mobile-911 Connections configured in the WIN-911 system.
- The GUIDs are located in the Id column.
 - The Name column displays the friendly name of the Connection

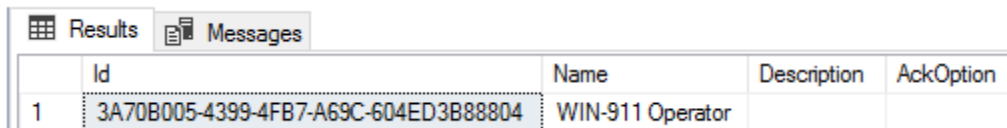

Id	Name	Description	AckOption
1	WIN-911 Operator		

- When specifying the connectionid for the Role Utility, use only the GUIDs that appear in this list.

Utility Configuration File

The Role Utility's configuration file, RoleUtility.exe.config, contains two pieces of information that are required for successful communication with the SQL Instance the utility is targeting, the SQL connection string and WIN-911 System Name. You may need to modify this information if the SQL instance you are using changes, or you are targeting

multiple WIN-911 systems from one PC. For example, if you are running a WIN-911 Hot Backup and you'd like to make changes to both systems, you will need to make a copy of the utility exe and config file and place the copies in a separate folder. One utilities' config would point to the primary WIN-911 while the other config would point to the backup.

Note: The configuration file is a plain text file, you can use Notepad for edits

Connection String

When the utility is installed, the connection string is created by the installer and it points to the SQL instance specified during installation. If you need to target a different SQL instance, you will need to update the Server value with the new instance name.

Default Connection String XML

```
<connectionStrings>  
<add name="RoleUtilityDataContext" providerName="System.Data.SqlClient"  
connectionString="Server=ServerName\WIN911;Database=;Integrated  
Security=True;MultipleActiveResultSets=true" />  
</connectionStrings>
```

The Connection String also specifies the authentication that will be used when communicating to the SQL instance. The default string specifies Windows Authentication, meaning, the Windows user account running the utility will be used to authenticate with the SQL instance. If you find this problematic while scripting the utility in your HMI application, you can modify the Connection String to contain login credentials for the SQL Instance. You will need to create a local SQL user in your SQL instance and ensure they have read/write privileges.

Remove the **Integrated Security** parameter and replace it with the **User Id** and **Password** parameters.

Connection String with User ID and Password HTML

```
<connectionStrings>  
<add name="RoleUtilityDataContext"  
providerName="System.Data.SqlClient"connectionString="Server=ServerName\WI  
N911;Database=;UserId=myUsername;Password=myPassword;MultipleActiveResul  
tSets=true" />  
</connectionStrings>
```

WIN-911 System Name

The configuration file also targets the WIN-911 System Name, which is the name of the server running WIN-911 appended with "-911". E.g. "ServerName-911" If you are targeting a different WIN-911 system, you must update this property in the config file.

XML

```
<add key="System" value="ServerName-911" />
```

Schedule Editor Utility

The WIN-911 Schedule Utility is a console application that can modify or query Schedules associated with a WIN-911 Connection. Execution of the utility may be scripted through your SCADA/HMI project, allowing operators to make Schedule changes in WIN-911 without leaving the HMI.

Install Location

The Schedule Utility consists of two components which are installed with the Dispatcher module, an executable and its corresponding configuration file.

EXE

```
C:\Program Files (x86)\WIN-911 Software\WIN-911
Enterprise\Dispatcher\Scheduleutility.exe
```

Config

```
C:\Program Files (x86)\WIN-911 Software\WIN-911
Enterprise\Dispatcher\Scheduleutility.exe.config
```

Syntax

```
1 scheduleutility.exe cmd={update|query} notifier={email|sms|voice|mobile911}
   connectionid= <Connection ID> scheduleid= <Schedule ID>
```

Arguments

cmd=update

Update Schedule for the Connection ID

cmd=query

Returns Schedule ID assigned to a Connection.

notifier

Specify the Notifier the Connection belongs to (email, sms, voice, or mobile911).

connectionid

Specify the Connection ID to target (Must be a GUID). Connection IDs are locate Connection IDs respective notifier SQL database. (See WIN-911 Connection GUIDs section below)

scheduleid

Specify the Schedule ID to assign to a Connection (Must be a GUID). Schedule IDs are located in the Dispatcher SQL database table, ScheduleEntities. (See WIN-911 Schedule GUIDs section below)

Examples

Note: In the following examples, we are using randomly generated GUIDs. When you run the utility, you must use the GUID from your WIN-911 database.

Update Schedule on Email Connection to a different Schedule

```
1 scheduleutility.exe cmd=update notifier=email connectionid=974a8c2c-01e3-
```

```
4aab-9955-3c8d4613eb15 scheduleid=4964b0e9-9323-4699-90da-63ffc657b5ed
```

Query Schedule for an Email Connection

```
1 scheduleutility.exe cmd=query notifier=email connectionid=974a8c2c-01e3-4aab-9955-3c8d4613eb15
```

Where to Find GUIDs

The GUIDs (globally unique identifier) for WIN-911 Connections and Schedules must be provided when running the Schedule Utility. GUIDs for both Schedules and Connections can be found in the WIN-911 configuration databases stored in MS SQL Server. The directions below will walkthrough locating GUIDs for Schedules and Connections using MS SQL Server Management Studio.

Note: Before you can locate the GUIDs in your SQL databases, you must first create the Schedules and Connections that you plan to use with WIN-911 Workspaces.

Accessing SQL Server

During installation of WIN-911, the installer offered to install a local instance of SQL Server Express with SQL Server Management Studio. If selected, an SQL instance named "WIN911" was created on the WIN-911 PC. If not selected, an SQL instance was manually entered. The SQL instance targeted by WIN-911 can be identified by launching WIN-911 Workspace and navigating to System / Info.

WIN-911 User Guide

If the WIN-911 installer was used to install SQL Server, only the Windows user account used during installation has sysadmin permissions. The credentials of this account will be needed to login to the "WIN911" instance.

- Launch MS SQL Server Management Studio using a Windows account with access to the SQL instance.
 - If you are not sure which account to login with, open Windows Services, locate one of the WIN-911 services, the Windows account listed under the Log On As column can be used.
- After MS SQL Server Studio has launched, connect to the SQL Instance where your WIN-911 databases are located.
 - Again, if the WIN-911 Installer installed SQL Server Express for you, you will use "<SERVERNAME>\WIN911"

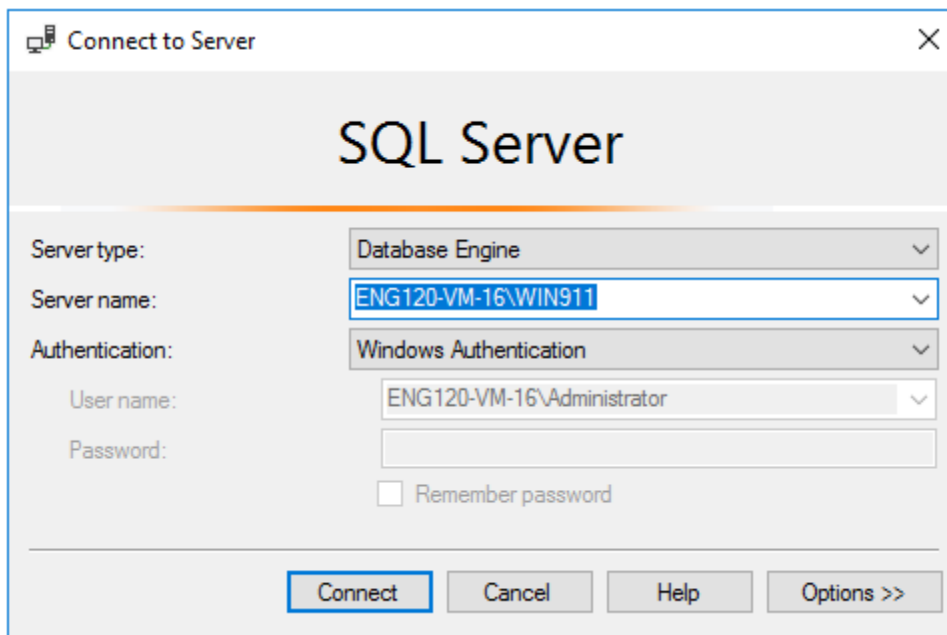

WIN-911 Schedule GUIDs

Schedules are configured in the Dispatcher module, as such, their GUIDs are located in the Dispatcher's database.

- Using the Object Explorer in SQL Management Studio, expand WIN-911 Instance, Databases, ComputerName-911.Default.Dispatcher, and Tables.

- Locate and right-click the dbo.ScheduleEntities table and click "Select Top 1000 Rows", this query will return a list of the Schedules configured in the WIN-911 system.
- The GUIDs are located in the Id column.
 - The Name column displays the friendly name of the Schedule.

	Id	Name	Description
1	A71E96F8-90D2-3BD4-B8F7-44727703FE7C	Off Hours	All times except Weekdays {
2	3C3BBAB3-F57B-3911-9F47-A51F4E17BE35	Never	No appointments scheduled
3	8E6BB9C9-66BB-3ED7-8EA9-BC8A7A4EEF93	Daily 12 hour	Every day 8:00am-8:00pm
4	8022B228-E613-3A12-9FA0-C8672D279FF6	Weekends	All day, Saturday and Sunda
5	FC6A54F3-CC1D-3454-A0EB-C95AB45D7954	Nightly 12 hour	Every night 8:00pm-8:00am
6	20BFC8FC-509C-3B25-B62E-CC0F8BBB3413	Standard Hours	Weekdays 8:00am-5:00pm
7	911F7DB8-232A-32AB-99DD-E18D1820FFD7	Always	All day, every day
8	CE713D27-699D-3DB2-A5B5-F2A87C182C72	Weekdays	All day, Monday-Friday

- When specifying the scheduleid for the Schedule Utility, use only the GUIDs that appear in this list.

WIN-911 Connection GUIDs

Each WIN-911 Notifier has a database with the following naming convention, ComputerName-911.Default.NotifierName. Within each of these databases exists a table with the Connection IDs needed to run the Role Utility.

Database Name	Table Name
ComputerName-911.Default.Email	dbo.EmailConnectionEntities
ComputerName-911.Default.SMS	dbo.SmsConnectionEntities
ComputerName-911.Default.Voice	dbo.VoiceConnectionEntities
ComputerName-911.Default.Mobile911	dbo.Mobile911ConnectionEntities

For the purpose of this document, we'll use the Mobile-911 Notifier as an example.

WIN-911 User Guide

- Using the Object Explorer in SQL Management Studio, expand WIN-911 Instance, Databases, ComputerName-911.Default.Mobile911, and Tables.
- Locate and right-click the dbo.Mobile911ConnectionEntities table and click "Select Top 1000 Rows", this query will return a list of the Mobile-911 Connections configured in the WIN-911 system.
- The GUIDs are located in the Id column.
 - The Name column displays the friendly name of the Connection

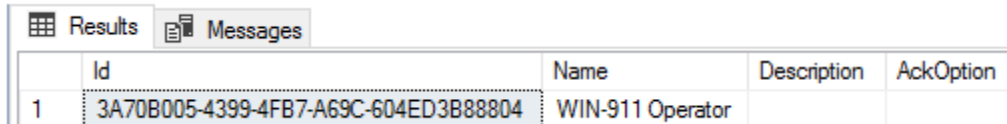

	Id	Name	Description	AckOption
1	3A70B005-4399-4FB7-A69C-604ED3B88804	WIN-911 Operator		

- When specifying the connectionid for the Schedule Utility, use only the GUIDs that appear in this list.

Utility Configuration File

The Schedule Utility's configuration file, ScheduleUtility.exe.config, contains two pieces of information that are required for successful communication with the SQL Instance the utility is targeting, the SQL connection string and WIN-911 System Name. You may need to modify this information if the SQL instance you are using changes, or you are targeting multiple WIN-911 systems from one PC. For example, if you are running a WIN-911 Hot Backup and you'd like to make changes to both systems, you will need to make a copy of the utility exe and config file and place the copies in a separate folder. One utilities' config would point to the primary WIN-911 while the other config would point to the backup.

Note: The configuration file is a plain text file, you can use Notepad for edits

Connection String

When the utility is installed, the connection string is created by the installer and it points to the SQL instance specified during installation. If you need to target a different SQL instance, you will need to update the Server value with the new instance name.

Default Connection String XML

```
<connectionStrings>  
<add name="ScheduleUtilityDataContext" providerName="System.Data.SqlClient"  
connectionString="Server=ServerName\WIN911;Database=;Integrated  
Security=True;MultipleActiveResultSets=true" />  
</connectionStrings>
```

The Connection String also specifies the authentication that will be used when communicating to the SQL instance. The default string specifies Windows Authentication, meaning, the Windows user account running the utility will be used to authenticate with the SQL instance. If you find this problematic while scripting the utility in your HMI application, you can modify the Connection String to contain login credentials for the SQL Instance. You will need to create a local SQL user in your SQL instance and ensure they have read/write privileges.

Remove the **Integrated Security** parameter and replace it with the **User Id** and **Password** parameters.

Connection String with User ID and Password HTML

```
<connectionStrings>  
<add name="ScheduleUtilityDataContext"  
providerName="System.Data.SqlClient"connectionString="Server=ServerName\WI  
N911;Database=;UserId=myUsername;Password=myPassword;MultipleActiveResul  
tSets=true" />  
</connectionStrings>
```

WIN-911 System Name

The configuration file also targets the WIN-911 System Name, which is the name of the server running WIN-911 appended with "-911". E.g. "ServerName-911" If you are targeting a different WIN-911 system, you must update this property in the config file.

XML

```
<add key="System" value="ServerName-911" />
```

Legal Notice

Copyright © 1993 - 2020

U.S. Patent No. 9,535,570

All Rights Reserved

No part of this publication may be reproduced, transmitted, transcribed, stored in retrieval system, or translated into any language or computer language, in any form or by any means, electronic, mechanical, magnetic, optical, chemical, manual, or otherwise, without the written permission of WIN-911 Software (a DBA of Specter Instruments, Inc.) 4020 2024 E St. Elmo Rd., Austin, Texas 78744. The software described in this document is furnished under a license agreement or nondisclosure agreement. The software may be used or copied only in accordance with the terms of agreement.

DISCLAIMER

WIN-911 SOFTWARE MAKES NO REPRESENTATION OR WARRANTIES WITH RESPECT TO THE CONTENTS HEREOF AND SPECIFICALLY DISCLAIMS ANY IMPLIED WARRANTIES OF MERCHANTABILITY OR FITNESS FOR ANY PURPOSE. Further, WIN-911 Software reserves the right to revise this publication and to make changes from time to time in the content hereof without obligation of WIN-911 Software to notify any person of such revision or changes.

NOTICE TO USER

This manual should not be construed as any representation or warranty with respect to the software named herein. Occasionally changes or variations exist in the software that are not reflected in the manual. Generally, if such changes or variations are known to exist and to affect the product significantly, a release note or README.DOC file accompanies the manual and distribution drive(s). In that event, be

sure to read the release note or README.DOC file before using the product. TRADEMARKS

WIN-911® and Mobile-911™ are trademarks of WIN-911 Software. Windows XP®, Server 2003®, Vista®, Server 2008®, Windows 7® , Windows 8®, Windows 10®, and Server 2016® are trademarks of Microsoft Corporation.

Microsoft®, Silverlight®, .NET Framework®, and MS® are registered trademarks of Microsoft Corporation.

Cepstral® is a registered trademark of Cepstral, LLC

iOS® is a registered trademark of Apple Incorporated

Android® is a registered trademark of Google Incorporated

Blackberry® is a registered trademark of Research In Motion Limited

Proficy®, Cimplicity®, Intellution®, Dynamics®, and iFIX® are trademarks of GE.

GoXam™ is a registered trademark of Northwoods Software

Ozeki™ is a registered trademark of Ozeki Informatics Ltd.