

Wire Pulling Grips

Wire pulling grips from Klein combine strength and durability to lead the world in creating an extremely high-quality line of grips. With ease-of-use and lasting quality, Klein wire-pulling grips set the mark.

FOR PROFESSIONALS... SINCE 1857®

Wire Pulling Grips



Introduction to Wire Pulling Grips

Quality

Trust the quality and reliability of Klein grips. All authentic Klein Grips are manufactured, inspected and tested in the USA, in company owned plants by American workers. From the custom drop-forged quality steel to machining and heat treating, to pulling rated load and final inspection, Klein Grips are designed to help linemen get their jobs done.

Features:



Drop-forged, quality US steel.

Heat treated for strength and durability.

Several jaw contours available for a wide variety of cables.

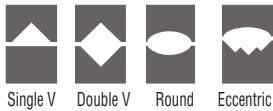

Single V Double V Round Eccentric



Reliability

Before leaving our manufacturing plant, each and every authentic Klein Grip is individually hand inspected and actuated for proper function. Grips are rigorously tested using the Magnflux method and pulled to rated load to ensure the highest quality and reliability for which Klein Tools is known.

Grip Recommendation

Klein Tools offers a service of recommending the proper grip for a particular application based on a sample of cable. This service is free of charge. All that we require is a minimum 3' (about 1 meter) length of cable.

Klein Tools has been manufacturing grips for over 135 years. All authentic Klein Grips are manufactured, and tested in the USA.

If there is ever a question about the safe condition of any grip, please contact Klein Tools Customer Service at 847.821.5500 or 800.553.4676.

Please contact customer service for further details.



Recommended Care and Maintenance

Grip Cleaning, Lubricating and Inspecting

The following guidelines have been established to keep all grips in good working condition.

Cleaning



Step 1. Use the Klein Grip Cleaning Wire Brush Set (Cat. No. 25450) or emery cloth to clean the surfaces of grip jaws (photo #1).



Step 2. Spray Degreaser on the grip jaws, all joints and moving parts (photo #2).



Step 3. Use the Klein Grip Cleaning Wire Brush to remove dirt and debris from the grip jaws (photo #3).

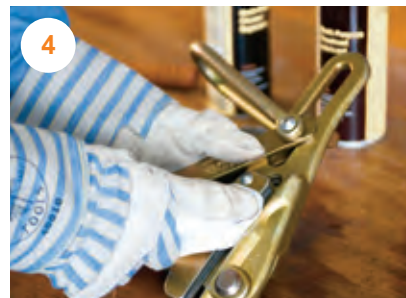

Step 4. Wipe grips dry with soft cloth. Repeat all cleaning steps as necessary until grip is completely clean (photo #4).

Lubricating

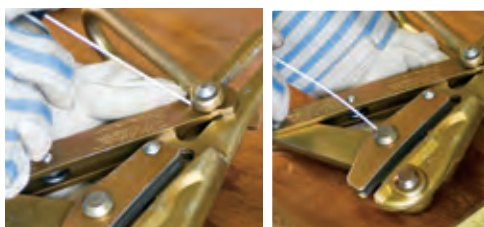
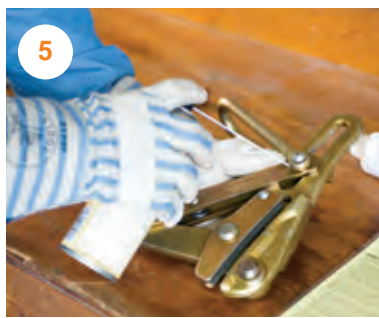

Step 5. Apply Lubricant to all joints and moving parts. Do not lubricate gripping surfaces of jaws (photos left #5).

Step 6. Carefully inspect jaw condition, proper alignment of jaws and all parts, and possible distortion caused by exceeding safe-load specifications. Grips should operate smoothly. Spring-loaded grips should lock open with loop handle in "Down" position and should close automatically with loop handle "Up." The Klein parallel jaw grip may be tested by opening and closing the jaws by hand, exercising proper caution. All parts and rivets should be checked for distortion (illustration #6).

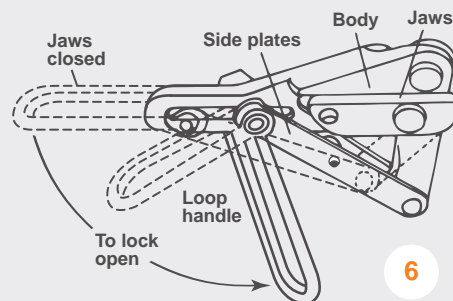

Never repair any grip. Grips that are bent, misaligned, or otherwise distorted should be discarded and replaced.

If there is ever a question about the safe condition of any grip, please contact Klein Tools Customer Service directly at **847-821-5500** or **800-553-4676**.

Note: Aluminum strand conductors may have a die-grease coating which can deposit on grip jaws. New aluminum conductors should be wiped clean before grip application. Grip jaws should be wiped clean of all grease before use.



Types of Wire Pulling Grips

Klein Chicago[®], Parallel Jaw and Haven's[®] Grips are widely used in the power, communications, and general construction fields to pull wire and cable. The grips maintain temporary tension until the wire or cable can be permanently terminated.

Klein Chicago[®] Grips

Authentic Chicago Grips are designed for use on aluminum, copper, weatherproof coated wire, PVC covered conductors and messenger and guy strand.

- *Locking loop handles. The locking feature allows the jaws to be held in an open position for easy placement on wire or cable.*
- *Available in Round, Double V and Single V jaw contours.*



1656-30

Parallel Jaw Grips

Lightweight compact parallel jaw grips pull an exceptionally wide range of cable types and sizes.

- *Latch helps maintain cable position.*
- *Large-diameter eye accommodates large hooks on hoists, winches and tackle blocks.*
- *Available in Round and Double V jaw contours.*



KT4500

Haven's[®] Grips

Haven's Grips are designed for use when a light, compact grip is desired and where conductor deformation is not a factor.

- *Knurled eccentric jaw applies gripping pressure to 1/4" of cable area.*
- *Some models include a swing latch that holds cable securely in jaw.*
- *Recommended for messenger and guy strand and wire rope.*
- *1625 Series can be used for wire rope.*

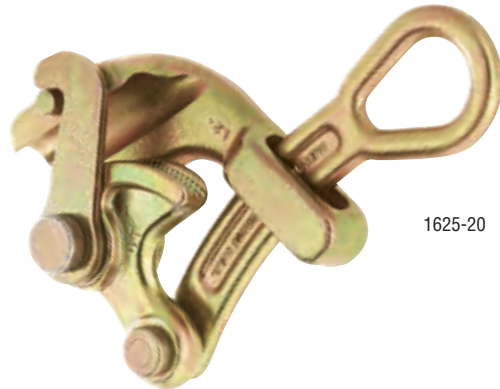

1625-20

Hot-line Latch

The hot-line latch is designed for placing a grip on cable with a hot-line stick. The three notches in the hot-line latch adjust the balance of the grip to better match the direction of the cable sag.

- *When stick is removed, latch closes automatically to guard against grip accidentally disengaging from wire.*
- *Standard hot-line grips are not supplied with springs or lock-open features.*

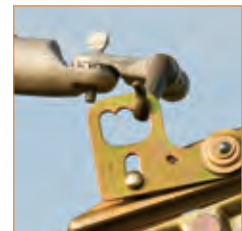

All dimensions are in inches and (millimeters) unless otherwise specified.

▲WARNING: Grips are to be used for temporary installation, not for permanent anchorage.







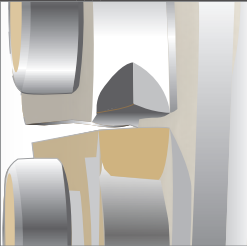

▲WARNING: When used on/or near energized lines, ground, insulate, or isolate grip before pulling.

▲WARNING: Do not exceed rated capacity.

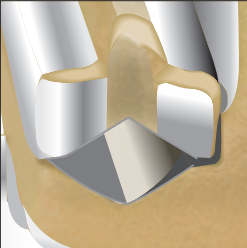
▲WARNING: Always match proper size and type of grip to application.

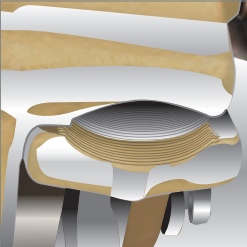
▲WARNING: Before each use, clean jaw area and inspect grip for proper operation to avoid slippage.

Types of Jaw Contours

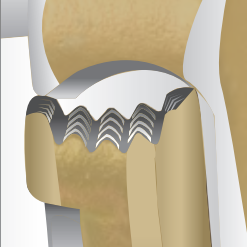
 Single V		Recommended for:			
		Steel Strand			
		Cat. No.			
 <ul style="list-style-type: none"> Simple three-point contact jaws. Designed for use on small diameter bare wire and cable (solid and stranded). 	1613-30				
 Double V		Recommended for:			
		Steel Strand	Wide Range of Cables		
		Cat. No.	Cat. No.		
 <ul style="list-style-type: none"> Four-point contact provides greater gripping pressure and assures proper alignment of wire and cable within the jaws. Designed for high strength messenger and guy strand and extra high-strength cables and conductors, as well as a wide range of cables. 	1613-40 and 1613-40H, 1628-16, 1628-16AT (Bell System) 1628-17, 1628-18, 1684-5 1684-5AT (Bell System) 1684-5H, 1692-5 1692-5AT (Bell System) 1684-74 and S1684-74H (EHS Cable) 1684-5F	1671-10, 1672-10, 1686-10, 1686-20			
 Round		Recommended for:			
		ACSR and AAC	Weatherproof and PVC Covered Copper	Steel Strand	Wide Range of Cables
		Cat. No.	Cat. No.	Cat. No.	Cat. No.
 <ul style="list-style-type: none"> Round jaws provide maximum contact and gripping power to minimize conductor deformation. (Smooth and knurled styles). Recommended for use on bare aluminum, ACSR, AAC and copper conductors as well as a wide range of cables. 	1628-16P SERIES, 1628-30 SERIES, 1628-40 SERIES, 1628-50 SERIES, 1656-20 and 1656-20H, 1656-30 and 1656-30H, 1656-40 and 1656-40H, 1656-50 and 1656-50H, 1656-60 and 1656-60H, 1678-20, 1678-30, 1678-40, 1678-50	 1611-20, 1611-30, 1611-40, 1611-50 Notched Jaw	 1659-5AT Serpentine Jaw	1685-20, 1685-31	
		 1659-20, 1659-30, 1659-40, 1659-50 Serpentine Jaw			
 Eccentric		Recommended for:			
		Steel Strand			
		Cat. No.			
 <ul style="list-style-type: none"> Eccentric jaw applies gripping pressure to 1/4" of cable area. Recommended for use when conductor deformation is not an issue. Available only on the Haven's® Grips. 	1604-10, 1604-20, 1604-20L, 1625-20 (For Wire Rope), 1625-20 1 (For Wire Rope), 1625-20 7/8 (For Wire Rope)				

Selecting the Proper Grip

Three basic factors are needed in order to determine the proper grip for each specific application:

1. Type of wire or cable (ACSR, ACSS, AAC, Copper, Steel Strand).
2. AWG or MCM (Diameter) of wire or cable.
3. Maximum safe load required.

Authentic Klein Grips are organized according to these three factors to make it easy for you to choose the proper grip.



ACSR (Aluminum Conductor Steel Reinforced)

See facing page
for grip details.

For Cable Diameter

MAXIMUM SAFE LOAD

4 AWG - 636 MCM

.250" - .953" (6.35 mm - 24.21 mm)

AWG or MCM Cable Size	Diameter inches (mm)	No. of Alum. & Steel Strands	Code Word	MAXIMUM SAFE LOAD			
				A 4,500 lbs (2041 kg)	B 8,000 lbs (3629 kg)	C 15,000 lbs (6803 kg)	D 20,000 lbs (9072 kg)
				Cat. No.	Cat. No.	Cat. No.	Cat. No.
4	.250" (6.35 mm)	6 x 1	Swan	1656-20, 1656-20H & S1656-20H			
4	.257" (6.53 mm)	7 x 1	Swanate	1656-20, 1656-20H & S1656-20H			
2	.316" (8.03 mm)	6 x 1	Sparrow	1656-20, 1656-20H, S1656-20H, 1656-30, 1656-30H & S1656-30H		1628-16PE*	
2	.325" (8.26 mm)	7 x 1	Sparate	1656-20, 1656-20H, S1656-20H, 1656-30, 1656-30H & S1656-30H		1628-16PE*	
1	.354" (9.02 mm)	6 x 1	Robin	1656-20, 1656-20H, S1656-20H, 1656-30, 1656-30H & S1656-30H		1628-16PF*	
1/0	.398" (10.11 mm)	6 x 1	Raven	1656-20, 1656-20H, S1656-20H, 1656-30, 1656-30H & S1656-30H		1628-16PG*	
2/0	.447" (11.35 mm)	6 x 1	Quail	1656-30, 1656-30H & S1656-30H		1628-16PG*	
3/0	.502" (12.75 mm)	6 x 1	Pigeon	1656-30, 1656-30H & S1656-30H		1628-16PH*	
4/0	.563" (14.30 mm)	6 x 1	Penguin		1656-40, 1656-40H & S1656-40H	1628-16PI*	
266.8 MCM	.609" (15.47 mm)	18 x 1	Waxwing		1656-40, 1656-40H & S1656-40H	1628-16PJ*	
266.8 MCM	.642" (16.31 mm)	26 x 7	Partridge		1656-40, 1656-40H & S1656-40H	1628-16PK*	
300 MCM	.680" (17.27 mm)	26 x 7	Ostrich		1656-40, 1656-40H & S1656-40H	1628-16PK*	
336.4 MCM	.684" (17.37 mm)	18 x 1	Merlin		1656-40, 1656-40H & S1656-40H	1628-16PK*	
336.4 MCM	.720" (18.31 mm)	26 x 7	Linnet		1656-40, 1656-40H & S1656-40H	1628-16PL*	
336.4 MCM	.741" (18.82 mm)	30 x 7	Oriole			1628-16PL*	
397.5 MCM	.743" (18.87 mm)	18 x 1	Chickadee		1656-50, 1656-50H & S1656-50H	1628-16PL*	
397.5 MCM	.772" (19.61 mm)	24 x 7	Brant		1656-50, 1656-50H & S1656-50H	1628-16PM*	
397.5 MCM	.783" (19.89 mm)	26 x 7	Ibis		1656-50, 1656-50H & S1656-50H	1628-16PM*	
397.5 MCM	.806" (20.47 mm)	30 x 7	Lark		1656-50, 1656-50H & S1656-50H	1628-16PM*	
477 MCM	.814" (20.68 mm)	18 x 1	Pelican		1656-50, 1656-50H & S1656-50H	1628-16PM*	
477 MCM	.846" (21.49 mm)	24 x 7	Flicker		1656-50, 1656-50H & S1656-50H	1628-16PN*	1628-30N*
477 MCM	.858" (21.79 mm)	26 x 7	Hawk		1656-50, 1656-50H & S1656-50H	1628-16PN*	1628-30N*
556.5 MCM	.879" (22.33 mm)	18 x 1	Osprey		1656-60, 1656-60H & S1656-60H	1628-16PN*	1628-30N*
477 MCM	.883" (22.43 mm)	30 x 7	Hen		1656-60, 1656-60H & S1656-60H	1628-16PN*	1628-30N*
556.5 MCM	.914" (23.22 mm)	24 x 7	Parakeet		1656-60, 1656-60H and S1656-60H		1628-300*
556.5 MCM	.927" (23.55 mm)	26 x 7	Dove		1656-60, 1656-60H & S1656-60H		1628-300*
636 MCM	.940" (23.88 mm)	18 x 1	Kingbird		1656-60, 1656-60H & S1656-60H		1628-300*
556.5 MCM	.953" (24.21 mm)	30 x 7	Eagle		1656-60, 1656-60H & S1656-60H		1628-300*
605 MCM	.953" (24.21 mm)	24 x 7	Peacock		1656-60, 1656-60H & S1656-60H		1628-300*

"S" is for spring. "H" is for hot latch.

*Special order only. Please allow 30 days for delivery. These are not returnable.

All dimensions are in inches and (millimeters) unless otherwise specified.

▲WARNING: Grips are to be used for temporary installation, not for permanent anchorage.

▲WARNING: When used on/or near energized lines, ground, insulate, or isolate grip before pulling.

▲WARNING: Do not exceed rated capacity.

▲WARNING: Always match proper size and type of grip to application.

▲WARNING: Before each use, clean jaw area and inspect grip for proper operation to avoid slippage.



ACSR (Aluminum Conductor Steel Reinforced)

Chicago® Grip – 1656 Series

- Round, smooth inside jaw contour on this series of grips is ideal for bare ACSR.
- Smooth jaws grip with maximum contact and are less likely to cause cable deformation.

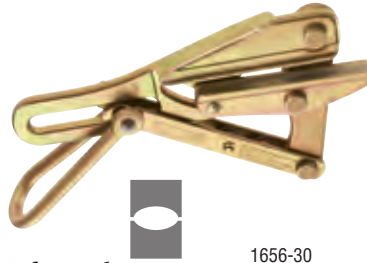

1656-30

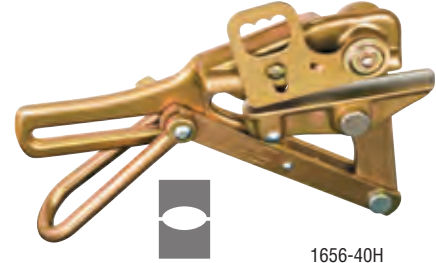

1656-40H

A 4,500 lbs. (2,041 kg) Maximum Safe Load

Cat. No.	Hot Latch Model No.	Hot Latch/Spring Model No.	Min. to Max. Cable AWG	Min. to Max. Cable Diameter inches (mm)	Jaw Length	Approx. Weight Each
1656-20	1656-20H	S1656-20H	4 - 1/0	.250" - .398" (6.35 mm - 10.11 mm)	4" (102 mm)	3 lbs. (1.36 kg)
1656-30	1656-30H	S1656-30H	2 - 3/0	.325" - .502" (8.25 mm - 12.75 mm)	4-3/4" (121 mm)	3.75 lbs. (1.70 kg)

B 8,000 lbs. (3,629 kg) Maximum Safe Load

Cat. No.	Hot Latch Model No.	Hot Latch/Spring Model No.	Min. to Max. Cable AWG or MCM	Min. to Max. Cable Diameter inches (mm)	Jaw Length	Approx. Weight Each
1656-40	1656-40H	S1656-40H	4/0 - 336.4 MCM	.563" - .720" (14.30 mm - 18.29 mm)	5-1/2" (140 mm)	8.30 lbs. (3.76 kg)
1656-50	1656-50H	S1656-50H	397.5 MCM - 477 MCM	.743" - .858" (18.82 mm - 21.79 mm)	5-1/2" (140 mm)	8.30 lbs. (3.76 kg)
1656-60	1656-60H	S1656-60H	477 MCM - 636 MCM	.879" - .953" (22.33 mm - 24.21 mm)	5-1/2" (140 mm)	8.20 lbs. (3.71 kg)

Chicago® Grip – 1628-16P and 1628-30 Series

- Round jaws are shaped to provide maximum contact with the cable, virtually eliminating cable deformation.
- Designed for large-diameter ACSR cables.

C 15,000 lbs. (6,803 kg) Maximum Safe Load

Cat. No.	Min. to Max. Cable AWG or MCM	Min. to Max. Cable Diameter inches (mm)	Jaw Length	Approx. Weight Each
1628-16PE*	2	.316" - .325" (8.03 mm - 8.25 mm)	7-1/4" (184 mm)	17 lbs. (7.73 kg)
1628-16PF*	1	.354" (8.99 mm)	7-1/4" (184 mm)	17 lbs. (7.73 kg)
1628-16PG*	1/0 - 2/0	.398" - .447" (10.11 mm - 11.35 mm)	7-1/4" (184 mm)	17 lbs. (7.73 kg)
1628-16PH* ‡	3/0	.502" (12.75 mm)	7-1/4" (184 mm)	17 lbs. (7.73 kg)
1628-16PI*	4/0	.563" (14.30 mm)	7-1/4" (184 mm)	17 lbs. (7.73 kg)
1628-16PJ*	266.8 MCM	.609" (15.47 mm)	7-1/4" (184 mm)	17 lbs. (7.73 kg)
1628-16PK*	266.8 MCM - 336.4 MCM	.642" - .684" (16.31 mm - 17.37 mm)	7-1/4" (184 mm)	17 lbs. (7.73 kg)
1628-16PL*	336.4 MCM - 397.5 MCM	.720" - .743" (18.29 mm - 18.87 mm)	7-1/4" (184 mm)	17 lbs. (7.73 kg)
1628-16PM*	397.5 MCM - 477 MCM	.772" - .814" (19.61 mm - 20.68 mm)	7-1/4" (184 mm)	17 lbs. (7.73 kg)
1628-16PN*	477 MCM - 556.5 MCM	.846" - .883" (21.49 mm - 22.43 mm)	7-1/4" (184 mm)	17 lbs. (7.73 kg)

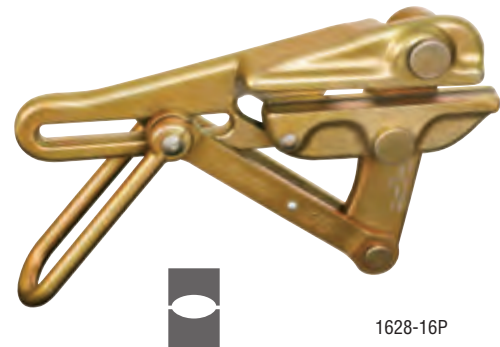

1628-16P

‡ The "H" suffix does not mean Hot Latch, this is only for Cat. No. 1628-16PH

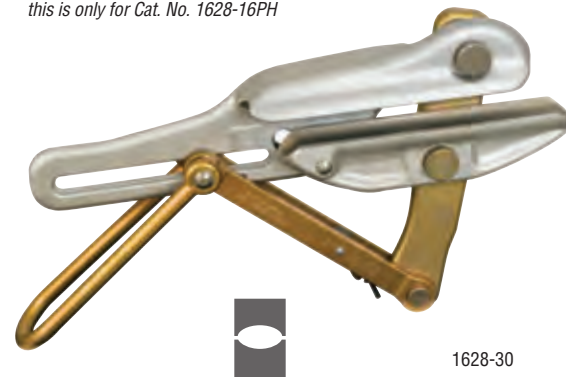

1628-30

D 20,000 lbs. (9,072 kg) Maximum Safe Load

Cat. No.	Min. to Max. Cable MCM	Min. to Max. Cable Diameter inches (mm)	Jaw Length	Approx. Weight Each
1628-30N**	477 MCM - 556.5 MCM	.846" - .883" (21.49 mm - 22.43 mm)	10-3/4" (273 mm)	27 lbs. (12.27 kg)
1628-300**	556.5 MCM - 636 MCM	.914" - .953" (23.22 mm - 24.21 mm)	10-3/4" (273 mm)	27 lbs. (12.27 kg)

*These grips are special order only. Please allow 30 days for delivery. These are not returnable.

** Maximum safe stringing tension 12,500 lbs to minimize cable deformation.

All dimensions are in inches and (millimeters) unless otherwise specified.

WARNING: Grips are to be used for temporary installation, not for permanent anchorage.

WARNING: When used on/or near energized lines, ground, insulate, or isolate grip before pulling.

WARNING: Do not exceed rated capacity.

WARNING: Always match proper size and type of grip to application.

WARNING: Before each use, clean jaw area and inspect grip for proper operation to avoid slippage.



ACSR (Aluminum Conductor Steel Reinforced)

For Cable Diameter

605 - 2515 MCM

.966" - 1.88" (24.54 mm - 47.75 mm)

MAXIMUM SAFE LOAD

See facing page
for grip details.

MCM Cable Size	Diameter inches (mm)	No. of Alum. & Steel Strands	Code Word	MAXIMUM SAFE LOAD				
				A 5,500 lbs (2,495 kg) Cat. No.	B 8,000 lbs (3,636 kg) Cat. No.	C 20,000 lbs (9,072 kg) Cat. No.	D 25,000 lbs (11,340 kg) Cat. No.	E 25,000 lbs. with bolt on jaw (11,340 kg) Cat. No.
605 MCM	.966" (24.54 mm)	26 x 7	Squab		1678-20	1628-30P*		1628-50P*
636 MCM	.977" (24.82 mm)	24 x 7	Rook		1678-20	1628-30P*		1628-50P*
636 MCM	.991" (25.15 mm)	26 x 7	Grosbeak		1678-20	1628-30P*		1628-50P*
605 MCM	.994" (25.25 mm)	30 x 19	Teal		1678-20	1628-30P*		1628-50P*
605 MCM	.994" (25.25 mm)	30 x 7	Wood Duck		1678-20	1628-30P*		1628-50P*
666.6 MCM	1.00" (25.40 mm)	24 x 7	Flamingo		1678-20	1628-30P*		1628-50P*
666.6 MCM	1.014" (25.76 mm)	26 x 7	Gannet		1678-20	1628-30P*		1628-50P*
636 MCM	1.019" (25.88 mm)	30 x 19	Egret		1678-20	1628-30R*		1628-50R*
636 MCM	1.019" (25.88 mm)	30 x 7	Scoter		1678-20	1628-30R*		1628-50R*
795 MCM	1.040" (26.41 mm)	36 x 1	Coot	1678-30		1628-30R*		1628-50R*
715.5 MCM	1.051" (26.70 mm)	26 x 7	Starling	1678-30		1628-30R*		1628-50R*
795 MCM	1.063" (27.00 mm)	45 x 7	Tern	1678-30		1628-30R*		1628-50R*
715.5 MCM	1.081" (27.46 mm)	30 x 19	Redwing	1678-40		1628-30S*		1628-50S*
795 MCM	1.092" (27.76 mm)	54 x 7	Condor	1678-40		1628-30S*		1628-50S*
795 MCM	1.092" (27.74 mm)	24 x 7	Cuckoo	1678-40		1628-30S*		1628-50S*
795 MCM	1.107" (28.14 mm)	26 x 7	Drake	1678-40		1628-30S*		1628-50S*
900 MCM	1.131" (28.73 mm)	45 x 7	Ruddy	1678-40		1628-30S*		1628-50S*
795 MCM	1.140" (28.96 mm)	30 x 19	Mallard	1678-40		1628-30S*		1628-50S*
900 MCM	1.162" (29.51 mm)	54 x 7	Canary	1678-50		1628-30T*		1628-50T*
954 MCM	1.165" (29.59 mm)	20 x 7	Corncrake	1678-50		1628-30T*		1628-50T*
954 MCM	1.165" (29.59 mm)	45 x 7	Rail	1678-50		1628-30T*		1628-50T*
954 MCM	1.175" (29.85 mm)	48 x 7	Towhee	1678-50		1628-30T*		1628-50T*
954 MCM	1.196" (30.38 mm)	54 x 7	Cardinal	1678-50		1628-30T*		1628-50T*
954 MCM	1.196" (30.38 mm)	24 x 7	Redbird	1678-50		1628-30T*		1628-50T*
1033.5 MCM	1.212" (30.81 mm)	45 x 7	Ortolan			1628-30U*	1628-40U*	1628-50U*
1033.5 MCM	1.245" (31.65 mm)	54 x 7	Curlew			1628-30U*	1628-40U*	1628-50U*
1113 MCM	1.258" (31.95 mm)	45 x 7	Bluejay			1628-30U*	1628-40U*	1628-50U*
1113 MCM	1.292" (32.84 mm)	54 x 19	Finch				1628-40W*	1628-50W*
1192.5 MCM	1.302" (33.07 mm)	45 x 7	Bunting				1628-40W*	1628-50W*
1272 MCM	1.317" (33.45 mm)	36 x 1	Skylark				1628-40W*	1628-50W*
1192.5 MCM	1.337" (33.99 mm)	54 x 19	Grackle				1628-40X*	1628-50X*
1272 MCM	1.345" (34.16 mm)	45 x 7	Bittern				1628-40X*	1628-50X*
1272 MCM	1.381" (35.10 mm)	54 x 19	Pheasant				1628-40X*	1628-50X*
1351.5 MCM	1.386" (35.20 mm)	45 x 7	Dipper				1628-40X*	1628-50X*
1351.5 MCM	1.424" (36.17 mm)	54 x 19	Martin				1628-40Y*	1628-50Y*
1431 MCM	1.427" (36.25 mm)	45 x 7	Bobolink				1628-40Y*	1628-50Y*
1431 MCM	1.465" (37.21 mm)	54 x 19	Plover				1628-40Z*	1628-50Z*
1590 MCM	1.504" (38.15 mm)	45 x 7	Lapwing				1628-40Z*	1628-50Z*
1590 MCM	1.544" (39.24 mm)	54 x 19	Falcon				1628-40A*	1628-50A*
1780 MCM	1.602" (40.69 mm)	84 x 19	Chukar					1628-50B*
2034.5 MCM	1.681" (42.70 mm)	72 x 7	Mockingbird					1628-50C*
2167 MCM	1.735" (44.12 mm)	72 x 7	Kiwi					1628-50D*
2156 MCM	1.762" (44.75 mm)	84 x 19	Bluebird					1628-50D*
2312 MCM	1.802" (45.77 mm)	76 x 19	Thrasher					1628-50E*
2515 MCM	1.88" (47.75 mm)	76 x 19	Joree					1628-50F*

*Special order only. Please allow 30 days for delivery. These are not returnable.

All dimensions are in inches and (millimeters) unless otherwise specified.

⚠WARNING: Grips are to be used for temporary installation, not for permanent anchorage.

⚠WARNING: When used on/or near energized lines, ground, insulate, or isolate grip before pulling.

⚠WARNING: Do not exceed rated capacity.

⚠WARNING: Always match proper size and type of grip to application.

⚠WARNING: Before each use, clean jaw area and inspect grip for proper operation to avoid slippage.



ACSR (Aluminum Conductor Steel Reinforced)

Chicago® Grip – 1678 Series

- Round jaws shaped to provide maximum contact with circumference of cable, less likely to cause cable deformation.
- Supplied with spring and locking loop handles, allowing jaws to be held in open position for easier placement on cable.

A 5,500 lbs. (2,495 kg) Maximum Safe Load

Cat. No.	Min. to Max. Cable MCM	Min. to Max. Cable Dia. in. (mm)	Jaw Length	Approx. Wt. Ea.
1678-30	715.5 MCM - 795 MCM	1.040" - 1.063" (26.42 mm - 27.00 mm)	5-11/16" (144 mm)	8.20 lbs. (3.71 kg)
1678-40	795 MCM - 900 MCM	1.081" - 1.140" (27.46 mm - 28.96 mm)	5-11/16" (144 mm)	8.20 lbs. (3.71 kg)
1678-50	900 MCM - 954 MCM	1.162" - 1.196" (29.51 mm - 30.38 mm)	5-11/16" (144 mm)	7.90 lbs. (3.58 kg)

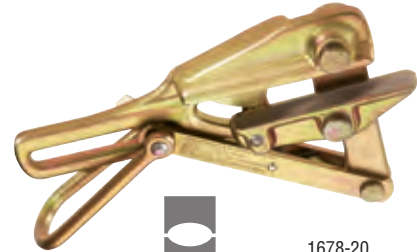

1678-20

B 8,000 lbs. (3,629 kg) Maximum Safe Load

Cat. No.	Min. to Max. Cable MCM	Min. to Max. Cable Dia. in. (mm)	Jaw Length	Approx. Wt. Ea.
1678-20	605 MCM - 666.6 MCM	.966" - 1.019" (24.54 mm - 25.88 mm)	5-11/16" (144 mm)	8.30 lbs. (3.71 kg)

Chicago® Grip – 1628 Series

- Round jaws are shaped to provide maximum contact with the cable, virtually eliminating cable deformation.

C 20,000 lbs. (9,072 kg) Maximum Safe Load

Cat. No.	Min. to Max. Cable MCM	Min. to Max. Cable Dia. in. (mm)	Jaw Length	Approx. Wt. Each
1628-30P*	605 MCM - 666.6 MCM	.966" - 1.014" (24.54 mm - 25.76 mm)	10-3/4" (273 mm)	27 lbs. (12.27 kg)
1628-30R*	636 MCM - 795 MCM	1.019" - 1.063" (25.88 mm - 27.00 mm)	10-3/4" (273 mm)	27 lbs. (12.27 kg)
1628-30S*	715.5 MCM - 900 MCM	1.081" - 1.140" (27.46 mm - 28.96 mm)	10-3/4" (273 mm)	27 lbs. (12.27 kg)
1628-30T*	900 MCM - 954 MCM	1.162" - 1.196" (29.51 mm - 30.38 mm)	10-3/4" (273 mm)	27 lbs. (12.27 kg)
1628-30U*	1033.5 MCM - 1113 MCM	1.212" - 1.258" (30.75 mm - 31.95 mm)	10-3/4" (273 mm)	27 lbs. (12.27 kg)

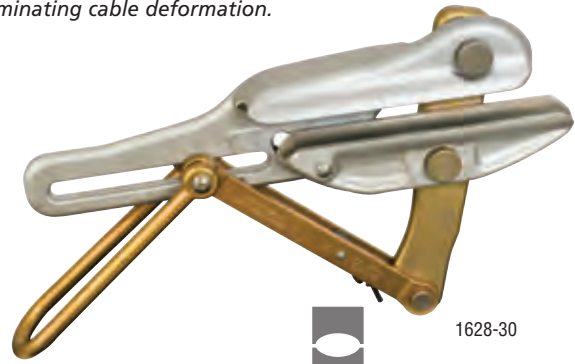

1628-30

D 25,000 lbs. (11,340 kg) Maximum Safe Load

Cat. No.	Min. to Max. Cable MCM	Min. to Max. Cable Dia. in. (mm)	Jaw Length	Approx. Wt. Each
1628-40U*	1033.5 MCM - 1113 MCM	1.212" - 1.258" (30.75 mm - 31.95 mm)	10-3/4" (273 mm)	34 lbs. (15.45 kg)
1628-40W*	1113 MCM - 1272 MCM	1.292" - 1.317" (32.82 mm - 33.45 mm)	10-3/4" (273 mm)	34 lbs. (15.45 kg)
1628-40X*	1192.5 MCM - 1351.5 MCM	1.337" - 1.386" (33.96 mm - 35.20 mm)	10-3/4" (273 mm)	34 lbs. (15.45 kg)
1628-40Y*	1351.5 MCM - 1431 MCM	1.424" - 1.427" (36.17 mm - 36.25 mm)	10-3/4" (273 mm)	34 lbs. (15.45 kg)
1628-40Z*	1431 MCM - 1590 MCM	1.465" - 1.504" (37.21 mm - 38.20 mm)	10-3/4" (273 mm)	34 lbs. (15.45 kg)
1628-40A*	1590 MCM	1.544" (39.22 mm)	10-3/4" (273 mm)	34 lbs. (15.45 kg)

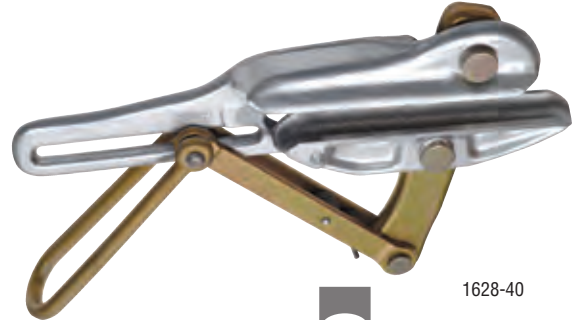

1628-40

*These grips are special order only. Please allow 30 days for delivery. These are not returnable.

E 25,000 lbs. (11,340 kg) Maximum Safe Load with bolt on jaw

Cat. No.	Min. to Max. Cable MCM	Min. to Max. Cable Dia. in. (mm)	Jaw Length	Approx. Wt. Each
1628-50P*	605 MCM - 666.6 MCM	.966" - 1.014" (24.54 mm - 25.76 mm)	10-3/4" (273 mm)	34 lbs. (15.45 kg)
1628-50R*	636 MCM - 795 MCM	1.019" - 1.063" (25.88 mm - 27.00 mm)	10-3/4" (273 mm)	34 lbs. (15.45 kg)
1628-50S*	715.5 MCM - 900 MCM	1.081" - 1.140" (27.46 mm - 28.96 mm)	10-3/4" (273 mm)	34 lbs. (15.45 kg)
1628-50T*	900 MCM - 954 MCM	1.162" - 1.196" (29.51 mm - 30.38 mm)	10-3/4" (273 mm)	34 lbs. (15.45 kg)
1628-50U*	1033.5 MCM - 1113 MCM	1.212" - 1.258" (30.75 mm - 31.95 mm)	10-3/4" (273 mm)	34 lbs. (15.45 kg)
1628-50W*	1113 MCM - 1272 MCM	1.292" - 1.317" (32.82 mm - 33.45 mm)	10-3/4" (273 mm)	34 lbs. (15.45 kg)
1628-50X*	1192.5 MCM - 1351.5 MCM	1.337" - 1.386" (33.96 mm - 35.20 mm)	10-3/4" (273 mm)	34 lbs. (15.45 kg)
1628-50Y*	1351.5 MCM - 1431 MCM	1.424" - 1.427" (36.17 mm - 36.25 mm)	10-3/4" (273 mm)	34 lbs. (15.45 kg)
1628-50Z*	1431 MCM - 1590 MCM	1.465" - 1.504" (37.21 mm - 38.20 mm)	10-3/4" (273 mm)	34 lbs. (15.45 kg)
1628-50A*	1590 MCM	1.544" (39.22 mm)	10-3/4" (273 mm)	34 lbs. (15.45 kg)
1628-50B*	1780 MCM	1.602" (40.69 mm)	10-3/4" (273 mm)	34 lbs. (15.45 kg)
1628-50C*	2034.5 MCM	1.681" (42.70 mm)	10-3/4" (273 mm)	34 lbs. (15.45 kg)
1628-50D*	2156 MCM - 2167 MCM	1.735" - 1.762" (44.12 mm - 44.75 mm)	10-3/4" (273 mm)	34 lbs. (15.45 kg)
1628-50E*	2312 MCM	1.802" (45.77 mm)	10-3/4" (273 mm)	34 lbs. (15.45 kg)
1628-50F*	2515 MCM	1.88" (47.75 mm)	10-3/4" (273 mm)	34 lbs. (15.45 kg)



- Removable bolt on floating jaw, secured by a slotted nut and cotter pin. Jaw provides increased cable coverage.

Note: Jaw must be removed to insert cable.



ACSS (Aluminum Conductor Steel Supported)

Chicago® Grip – 1628-50 Series

- Round jaws shaped to provide maximum contact with circumference of cable, less likely to cause cable deformation.
- Supplied with spring and locking loop handles, allowing jaws to be held in open position for easier placement on cable.
- Removable bolt on floating jaw, secured by a slotted nut and cotter pin. Jaw provides increased cable coverage.

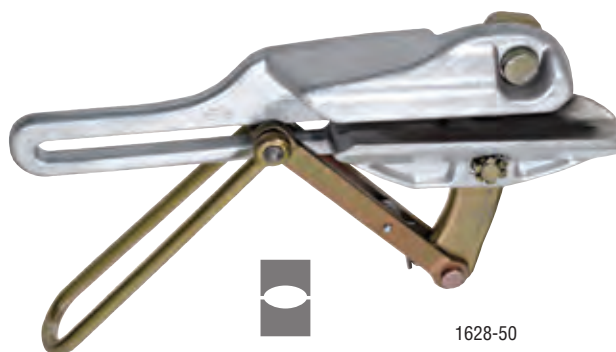

1628-50

E 25,000 lbs. (11,340 kg) Maximum Safe Load with bolt on jaw

For Cable Diameter

605 - 2515 MCM

.966" - 1.88" (24.54 mm - 47.75 mm)

				E					E
				25,000 lbs. (11,340 kg) with bolt on jaw					25,000 lbs. (11,340 kg) with bolt on jaw
MCM Cable Size	Diameter inches (mm)	No. of Alum. & Steel Strands	Code Word	Cat. No.	MCM Cable Size	Diameter inches (mm)	No. of Alum. & Steel Strands	Code Word	Cat. No.
605 MCM	.966" (24.54 mm)	26 x 7	Squab/ACSS	1628-50P*	1033.5 MCM	1.212" (30.81 mm)	45 x 7	Ortolan/ACSS	1628-50U*
636 MCM	.977" (24.82 mm)	24 x 7	Rook/ACSS	1628-50P*	1033.5 MCM	1.245" (31.65 mm)	54 x 7	Curlew/ACSS	1628-50U*
636 MCM	.991" (25.15 mm)	26 x 7	Grosbeak/ACSS	1628-50P*	1113 MCM	1.258" (31.95 mm)	45 x 7	Bluejay/ACSS	1628-50U*
605 MCM	.994" (25.25 mm)	30 x 7	Wood Duck/ACSS	1628-50P*	1113 MCM	1.292" (32.84 mm)	54 x 19	Finch/ACSS	1628-50W*
605 MCM	.994" (25.25 mm)	30 x 19	Teal/ACSS	1628-50P*	1192.5 MCM	1.302" (33.07 mm)	45 x 7	Bunting/ACSS	1628-50W*
666.6 MCM	1.00" (25.40 mm)	24 x 7	Flamingo/ACSS	1628-50P*	1192.5 MCM	1.337" (33.99 mm)	54 x 19	Grackle/ACSS	1628-50X*
666.6 MCM	1.014" (25.76 mm)	26 x 7	Gannet/ACSS	1628-50P*	1272 MCM	1.345" (34.16 mm)	45 x 7	Bittern/ACSS	1628-50X*
636 MCM	1.019" (25.88 mm)	30 x 19	Egret/ACSS	1628-50R*	1272 MCM	1.381" (35.10 mm)	54 x 19	Pheasant/ACSS	1628-50X*
636 MCM	1.019" (25.88 mm)	30 x 7	Scoter/ACSS	1628-50R*	1351.5 MCM	1.386" (35.20 mm)	45 x 7	Dipper/ACSS	1628-50X*
715.5 MCM	1.051" (26.70 mm)	26 x 7	Starling/ACSS	1628-50R*	1351.5 MCM	1.424" (36.17 mm)	54 x 19	Martin/ACSS	1628-50Y*
795 MCM	1.063" (27.00 mm)	45 x 7	Tern/ACSS	1628-50R*	1431 MCM	1.427" (36.25 mm)	45 x 7	Bobolink/ACSS	1628-50Y*
715.5 MCM	1.081" (27.46 mm)	30 x 19	Redwing/ACSS	1628-50S*	1431 MCM	1.465" (37.21 mm)	54 x 19	Plover/ACSS	1628-50Z*
795 MCM	1.092" (27.74 mm)	24 x 7	Cuckoo/ACSS	1628-50S*	1590 MCM	1.504" (38.15 mm)	45 x 7	Lapwing/ACSS	1628-50Z*
795 MCM	1.092" (27.76 mm)	54 x 7	Condor/ACSS	1628-50S*	1590 MCM	1.544" (39.24 mm)	54 x 19	Falcon/ACSS	1628-50A*
795 MCM	1.107" (28.14 mm)	26 x 7	Drake/ACSS	1628-50S*	1780 MCM	1.602" (40.69 mm)	84 x 19	Chukar/ACSS	1628-50B*
900 MCM	1.131" (28.73 mm)	45 x 7	Ruddy/ACSS	1628-50S*	2034.5 MCM	1.681" (42.70 mm)	72 x 7	Mockingbird/ACSS	1628-50C*
795 MCM	1.140" (28.96 mm)	30 x 19	Mallard/ACSS	1628-50S*	2167 MCM	1.735" (44.12 mm)	72 x 7	Kiwi/ACSS	1628-50D*
900 MCM	1.162" (29.51 mm)	54 x 7	Canary/ACSS	1628-50T*	2156 MCM	1.762" (44.75 mm)	84 x 19	Bluebird/ACSS	1628-50D*
954 MCM	1.165" (29.59 mm)	20 x 7	Corncrake/ACSS	1628-50T*	2312 MCM	1.802" (45.77 mm)	76 x 19	Thrasher/ACSS	1628-50E*
954 MCM	1.165" (29.59 mm)	45 x 7	Rail/ACSS	1628-50T*					
954 MCM	1.175" (29.85 mm)	48 x 7	Towhee/ACSS	1628-50T*					
954 MCM	1.196" (30.38 mm)	54 x 7	Cardinal/ACSS	1628-50T*					

*Klein Tools recommends using the 1628-50 series grips for ACSS cable. Special order only. **Application must be confirmed prior to ordering.** Please allow 30 days for delivery. Jaw must be removed to insert cable.



Note: Jaw must be removed to insert cable.

All dimensions are in inches and (millimeters) unless otherwise specified.

⚠WARNING: Grips are to be used for temporary installation, not for permanent anchorage.

⚠WARNING: When used on/or near energized lines, ground, insulate, or isolate grip before pulling.

⚠WARNING: Do not exceed rated capacity.

⚠WARNING: Always match proper size and type of grip to application.

⚠WARNING: Before each use, clean jaw area and inspect grip for proper operation to avoid slippage.



ACSS/TW (Aluminum Conductor Steel Supported/Trapezoidal Wire)

For Cable Diameter

795 - 2627.3 MCM

.960" - 1.762" (24.38 mm - 44.75 mm)

E
25,000 lbs.
with bolt on jaw

MCM Cable Size	Diameter inches (mm)	No. of Alum. & Steel Strands	Code Word	Cat. No
795 MCM	.960" (24.38 mm)	17 x 7	Tern/ACSS/TW	1628-50P*
768.2 MCM	.977" (24.82 mm)	20 x 7	Maumee/ACSS/TW	1628-50P*
795 MCM	.980" (24.89 mm)	18 x 7	Puffin/ACSS/TW	1628-50P*
795 MCM	.993" (25.22 mm)	20 x 7	Condor/ACSS/TW	1628-50P*
762.8 MCM	.990" (25.15 mm)	20 x 7	Wabash/ACSS/TW	1628-50P*
795 MCM	1.010" (25.65 mm)	20 x 7	Drake/ACSS/TW	1628-50P*
954 MCM	1.049" (26.64 mm)	30 x 7	Phoenix/ACSS/TW	1628-50R*
957.2 MCM	1.060" (26.92 mm)	32 x 7	Kettle/ACSS/TW	1628-50R*
954 MCM	1.061" (26.94 mm)	32 x 7	Rail/ACSS/TW	1628-50R*
946.7 MCM	1.077" (27.36 mm)	35 x 7	Fraser/ACSS/TW	1628-50R*
954 MCM	1.084" (27.53 mm)	20 x 7	Cardinal/ACSS/TW	1628-50S*
1033.5 MCM	1.089" (27.66 mm)	30 x 7	Snowbird/ACSS/TW	1628-50S*
966.2 MCM	1.092" (27.73 mm)	21 x 7	Columbia/ACSS/TW	1628-50S*
959.6 MCM	1.108" (28.14 mm)	22 x 7	Suwannee/ACSS/TW	1628-50S*
1033.5 MCM	1.102" (27.99 mm)	32 x 7	Ortolan/ACSS/TW	1628-50S*
1033.5 MCM	1.129" (28.68 mm)	21 x 7	Curlew/ACSS/TW	1628-50S*
1113 MCM	1.129" (28.68 mm)	30 x 7	Avocet/ACSS/TW	1628-50S*
1113 MCM	1.143" (29.03 mm)	33 x 7	Bluejay/ACSS/TW	1628-50T*
1168.1 MCM	1.155" (29.34 mm)	30 x 7	Cheyenne/ACSS/TW	1628-50T*
1158 MCM	1.165" (29.59 mm)	33 x 7	Gennessee/ACSS/TW	1628-50T*
1192.5 MCM	1.167" (29.64 mm)	30 x 7	Oxbird/ACSS/TW	1628-50T*
1192.5 MCM	1.181" (29.99 mm)	33 x 7	Bunting/ACSS/TW	1628-50T*
1113 MCM	1.185" (30.10 mm)	38 x 19	Finch/ACSS/TW	1628-50T*
1158.4 MCM	1.196" (30.38 mm)	25 x 7	Hudson/ACSS/TW	1628-50T*
1272 MCM	1.203" (30.56 mm)	30 x 7	Scissortail/ACSS/TW	1628-50T*
1272 MCM	1.203" (30.56 mm)	30 x 7	Catawba/ACSS/TW	1628-50T*
1257.1 MCM	1.213" (30.81 mm)	35 x 7	Nelson/ACSS/TW	1628-50U*
1272 MCM	1.220" (30.99 mm)	35 x 7	Bittern/ACSS/TW	1628-50U*
1192.5 MCM	1.225" (31.12 mm)	38 x 19	Grackle/ACSS/TW	1628-50U*
1233.6 MCM	1.245" (31.62 mm)	38 x 19	Yukon/ACSS/TW	1628-50U*
1371.5 MCM	1.248" (31.70 mm)	30 x 7	Truckee/ACSS/TW	1628-50U*
1351.5 MCM	1.256" (31.90 mm)	35 x 7	Dipper/ACSS/TW	1628-50U*
1272 MCM	1.264" (32.11 mm)	39 x 19	Pheasant/ACSS/TW	1628-50U*
1359.7 MCM	1.269" (32.23 mm)	36 x 7	Mackenzie/ACSS/TW	1628-50W*
1431 MCM	1.291" (32.79 mm)	36 x 7	Bobolink/ACSS/TW	1628-50W*
1467.8 MCM	1.292" (32.82 mm)	33 x 7	St. Croix/ACSS/TW	1628-50W*
1334.6 MCM	1.293" (32.84 mm)	39 x 19	Thames/ACSS/TW	1628-50W*
1351.5 MCM	1.300" (33.02 mm)	39 x 19	Martin/ACSS/TW	1628-50W*
1455.3 MCM	1.302" (33.07 mm)	36 x 7	Miramichi/ACSS/TW	1628-50W*
1569 MCM	1.334" (33.88 mm)	33 x 7	Platte/ACSS/TW	1628-50X*
1431 MCM	1.337" (33.96 mm)	39 x 19	Plover/ACSS/TW	1628-50X*
1433.6 MCM	1.338" (33.99 mm)	39 x 19	Merrimack/ACSS/TW	1628-50X*
1557.4 MCM	1.345" (34.16 mm)	36 x 7	Potomac/ACSS/TW	1628-50X*
1590 MCM	1.358" (34.49 mm)	36 x 7	Lapwing/ACSS/TW	1628-50X*
1533.3 MCM	1.382" (35.10 mm)	39 x 19	Rio Grande/ACSS/TW	1628-50X*
1657.4 MCM	1.386" (35.20 mm)	36 x 7	Schuylkill/ACSS/TW	1628-50X*
1590 MCM	1.408" (35.76 mm)	42 x 19	Falcon/ACSS/TW	1628-50Y*
1622 MCM	1.424" (36.17 mm)	39 x 19	Pecos/ACSS/TW	1628-50Y*
1758.6 MCM	1.427" (36.25 mm)	37 x 7	Pee Dee/ACSS/TW	1628-50Y*
1780 MCM	1.445" (36.70 mm)	37 x 19	Chukar/ACSS/TW	1628-50Y*
1730.6 MCM	1.465" (37.21 mm)	39 x 19	James/ACSS/TW	1628-50Z*
1949.6 MCM	1.504" (38.20 mm)	42 x 7	Athabaska/ACSS/TW	1628-50Z*
1926.9 MCM	1.545" (39.24 mm)	42 x 19	Cumberland/ACSS/TW	1628-50A*
2153.8 MCM	1.602" (40.69 mm)	64 x 19	Powder/ACSS/TW	1628-50B*
2156 MCM	1.608" (40.84 mm)	64 x 19	Bluebird/ACSS/TW	1628-50B*
2627.3 MCM	1.762" (44.75 mm)	64 x 19	Santee/ACSS/TW	1628-50D*

*Klein Tools recommends using the 1628-50 series grips for ACSS and ACSS/TW cable. Special order only.
Application must be confirmed prior to ordering. Please allow 30 days for delivery. Jaw must be removed to insert cable.

Wire Pulling Grips



AAC (All Aluminum Conductor)

See facing page
for grip details.

For Cable Diameter

4 AWG - 650 MCM

.231" - .928" (5.87 mm - 23.57 mm)

MAXIMUM SAFE LOAD

AWG or MCM Cable Size	Diameter inches (mm)	No. of Alum. Strands	Code Word	MAXIMUM SAFE LOAD			
				A 4,500 lbs (2041 kg)	B 8,000 lbs (3629 kg)	C 15,000 lbs (6803 kg)	D 20,000 lbs (9072 kg)
				Cat. No.	Cat. No.	Cat. No.	Cat. No.
4	.231" (5.87 mm)	7	Rose	1656-20, 1656-20H and S1656-20H			
2	.292" (7.42 mm)	7	Iris	1656-20, 1656-20H and S1656-20H			
1	.328" (8.33 mm)	7	Pansy	1656-20, 1656-20H, S1656-20H, 1656-30, 1656-30H and S1656-30H		1628-16PE*	
1/0	.369" (9.36 mm)	7	Poppy	1656-20, 1656-20H, S1656-20H, 1656-30, 1656-30H and S1656-30H		1628-16PF*	
2/0	.414" (10.51 mm)	7	Aster	1656-30, 1656-30H and S1656-30H		1628-16PG*	
3/0	.465" (11.81 mm)	7	Phlox	1656-30, 1656-30H and S1656-30H		1628-16PH*	
4/0	.522" (13.25 mm)	7	Oxlip	1656-30, 1656-30H and S1656-30H		1628-16PI*	
250 MCM	.567" (14.40 mm)	7	Sneezewort		1656-40, 1656-40H and S1656-40H	1628-16PI*	
250 MCM	.574" (14.58 mm)	19	Valerian		1656-40, 1656-40H and S1656-40H	1628-16PI*	
266.8 MCM	.586" (14.88 mm)	7	Daisy		1656-40, 1656-40H and S1656-40H	1628-16PJ*	
266.8 MCM	.593" (15.05 mm)	19	Laurel		1656-40, 1656-40H and S1656-40H	1628-16PJ*	
300 MCM	.628" (15.95 mm)	19	Peony		1656-40, 1656-40H and S1656-40H	1628-16PJ*	
336.4 MCM	.665" (16.90 mm)	19	Tulip		1656-40, 1656-40H and S1656-40H	1628-16PK*	
350 MCM	.678" (17.22 mm)	19	Daffodil		1656-40, 1656-40H and S1656-40H	1628-16PK*	
397.5 MCM	.724" (18.38 mm)	19	Canna		1656-40, 1656-40H and S1656-40H	1628-16PL*	
450 MCM	.769" (19.53 mm)	19	Goldentuft		1656-50, 1656-50H and S1656-50H	1628-16PM*	
477 MCM	.792" (20.12 mm)	19	Cosmos		1656-50, 1656-50H and S1656-50H	1628-16PM*	
477 MCM	.794" (20.18 mm)	37	Syringa		1656-50, 1656-50H and S1656-50H	1628-16PM*	
500 MCM	.811" (20.60 mm)	19	Zinnia		1656-50, 1656-50H and S1656-50H	1628-16PM*	
500 MCM	.813" (20.65 mm)	37	Hyacinth		1656-50, 1656-50H and S1656-50H	1628-16PM*	
556.5 MCM	.856" (21.73 mm)	19	Dahlia		1656-50, 1656-50H and S1656-50H	1628-16PN*	1628-30N*
556.5 MCM	.858" (21.80 mm)	37	Mistletoe		1656-50, 1656-50H and S1656-50H	1628-16PN*	1628-30N*
600 MCM	.891" (22.63 mm)	37	Meadowsweet		1656-60, 1656-60H and S1656-60H		1628-300*
636 MCM	.918" (23.31 mm)	37	Orchid		1656-60, 1656-60H and S1656-60H		1628-300*
650 MCM	.928" (23.57 mm)	37	Heuchera		1656-60, 1656-60H and S1656-60H		1628-300*

"S" is for spring. "H" is for hot latch.

*Special order only. Please allow 30 days for delivery. These are not returnable.

All dimensions are in inches and (millimeters) unless otherwise specified.

WARNING: Grips are to be used for temporary installation, not for permanent anchorage.

WARNING: When used on/or near energized lines, ground, insulate, or isolate grip before pulling.

WARNING: Do not exceed rated capacity.

WARNING: Always match proper size and type of grip to application.

WARNING: Before each use, clean jaw area and inspect grip for proper operation to avoid slippage.



AAC (All Aluminum Conductor)

Chicago® Grip – 1656 Series

- Round, smooth inside jaw contour on this series of grips is recommended for bare AAC.
- Smooth jaws grip with maximum contact and are less likely to cause cable deformation.

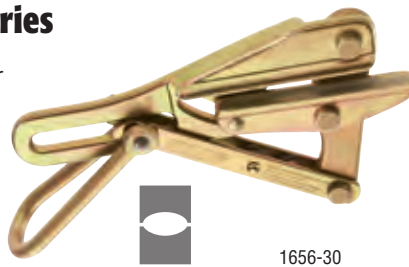

1656-30

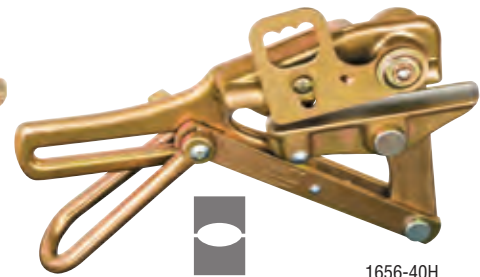

1656-40H

A 4,500 lbs. (2,041 kg) Maximum Safe Load

Cat. No.	Hot Latch Model No.	Hot Latch/Spring Model No.	Min. to Max. Cable AWG	Min. to Max. Cable Diameter inches (mm)	Jaw Length	Approx. Weight Each
1656-20	1656-20H	S1656-20H	4 - 1/0	.231" - .369" (5.87 mm - 9.37 mm)	4" (102 mm)	3 lbs. (1.36 kg)
1656-30	1656-30H	S1656-30H	1 - 4/0	.328" - .522" (8.33 mm - 13.26 mm)	4-3/4" (121 mm)	3.75 lbs. (1.70 kg)

B 8,000 lbs. (3,629 kg) Maximum Safe Load

Cat. No.	Hot Latch Model No.	Hot Latch/Spring Model No.	Min. to Max. Cable MCM	Min. to Max. Cable Diameter inches (mm)	Jaw Length	Approx. Weight Each
1656-40	1656-40H	S1656-40H	250 MCM - 397.5 MCM	.567" - .724" (14.40 mm - 18.39 mm)	5-1/2" (140 mm)	8.30 lbs. (3.76 kg)
1656-50	1656-50H	S1656-50H	450 MCM - 556.5 MCM	.769" - .858" (19.53 mm - 21.79 mm)	5-1/2" (140 mm)	8.30 lbs. (3.76 kg)
1656-60	1656-60H	S1656-60H	600 MCM - 650 MCM	.891" - .928" (22.63 mm - 23.57 mm)	5-1/2" (140 mm)	8.20 lbs (3.71 kg)

Chicago® Grip – 1628-16P and 1628-30 Series

- Designed for large-diameter AAC cables.
- Round jaws are shaped to provide maximum contact with the cable, virtually eliminating cable deformation.

C 15,000 lbs. (6,803 kg) Maximum Safe Load

Cat. No.	Min. to Max. Cable AWG or MCM	Min. to Max. Cable Diameter inches (mm)	Jaw Length	Approx. Weight Each
1628-16PE*	1	.328" (8.33 mm)	7-1/4" (184 mm)	17 lbs. (7.73 kg)
1628-16PF*	1/0	.369" (9.37 mm)	7-1/4" (184 mm)	17 lbs. (7.73 kg)
1628-16PG*	2/0	.414" (10.52 mm)	7-1/4" (184 mm)	17 lbs. (7.73 kg)
1628-16PH* ‡	3/0	.465" (11.81 mm)	7-1/4" (184 mm)	17 lbs. (7.73 kg)
1628-16PI*	250 MCM	.567" - .574" (14.40 mm - 14.58 mm)	7-1/4" (184 mm)	17 lbs. (7.73 kg)
1628-16PJ*	266.8 MCM - 300 MCM	.586" - .628" (14.88 mm - 15.95 mm)	7-1/4" (184 mm)	17 lbs. (7.73 kg)
1628-16PK*	336.4 MCM - 350 MCM	.665" - .678" (16.89 mm - 17.22 mm)	7-1/4" (184 mm)	17 lbs. (7.73 kg)
1628-16PL*	397.5 MCM	.724" (18.39 mm)	7-1/4" (184 mm)	17 lbs. (7.73 kg)
1628-16PM*	450 MCM - 500 MCM	.769" - .813" (19.53 mm - 20.65 mm)	7-1/4" (184 mm)	17 lbs. (7.73 kg)
1628-16PN*	556.5 MCM	.856" - .858" (21.74 mm - 21.79 mm)	7-1/4" (184 mm)	17 lbs. (7.73 kg)



1628-16P

‡ The "H" suffix does not mean Hot Latch, this is only for Cat. No. 1628-16PH

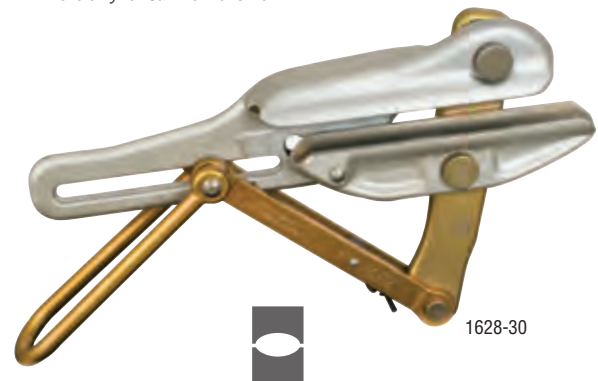

1628-30

D 20,000 lbs. (9,072 kg) Maximum Safe Load

Cat. No.	Min. to Max. Cable MCM	Min. to Max. Cable Diameter inches (mm)	Jaw Length	Approx. Weight Each
1628-30N**	556.5 MCM	.856" - .858" (21.74 mm - 21.79 mm)	10-3/4" (273 mm)	27 lbs. (12.27 kg)
1628-300**	600 MCM - 650 MCM	.891" - .928" (22.63 mm - 23.57 mm)	10-3/4" (273 mm)	27 lbs. (12.27 kg)

** Maximum safe stringing tension 12,500 lbs to minimize cable deformation.

*These grips are special order only. Please allow 30 days for delivery. These are not returnable.

All dimensions are in inches and (millimeters) unless otherwise specified.

⚠WARNING: See facing page.



AAC (All Aluminum Conductor)

For Cable Diameter 700 - 2500 MCM

.963" - 1.823" (24.46 mm - 46.30 mm)

MAXIMUM SAFE LOAD

See facing page
for grip details.

MCM Cable Size	Diameter inches (mm)	No. of Alum. & Steel Strands	Code Word	MAXIMUM SAFE LOAD				
				5,500 lbs (2,268 kg)	8,000 lbs (3,629 kg)	20,000 lbs (9,072 kg)	25,000 lbs (11,340 kg)	25,000 lbs. (11,340 kg) with bolt on jaw
				Cat. No.	Cat. No.	Cat. No.	Cat. No.	Cat. No.
700 MCM	.963" (24.46 mm)	37	Verbena		1678-20	1628-30P*		1628-50P*
700 MCM	.964" (24.49 mm)	61	Flag		1678-20	1628-30P*		1628-50P*
715.5 MCM	.974" (24.73 mm)	37	Violet		1678-20	1628-30P*		1628-50P*
715.5 MCM	.975" (24.76 mm)	61	Nasturtium		1678-20	1628-30P*		1628-50P*
750 MCM	.997" (25.32 mm)	37	Petunia		1678-20	1628-30P*		1628-50P*
750 MCM	.998" (25.35 mm)	61	Cattail		1678-20	1628-30P*		1628-50P*
795 MCM	1.026" (26.07 mm)	37	Arbutus	1678-30		1628-30R*		1628-50R*
795 MCM	1.028" (26.11 mm)	61	Lilac	1678-30		1628-30R*		1628-50R*
800 MCM	1.029" (26.14 mm)	37	Fuchsia	1678-30		1628-30R*		1628-50R*
800 MCM	1.031" (26.19 mm)	61	Heliotrope	1678-30		1628-30R*		1628-50R*
874.5 MCM	1.076" (27.37 mm)	37	Anemone	1678-30		1628-30R*		1628-50R*
874.5 MCM	1.077" (27.36 mm)	61	Crocus	1678-30		1628-30R*		1628-50R*
900 MCM	1.092" (27.74 mm)	37	Cockscomb	1678-40		1628-30S*		1628-50S*
954 MCM	1.124" (28.55 mm)	37	Magnolia	1678-40		1628-30S*		1628-50S*
954 MCM	1.126" (28.60 mm)	61	Goldenrod	1678-40		1628-30S*		1628-50S*
1000 MCM	1.152" (29.26 mm)	61	Camellia	1678-50		1628-30T*		1628-50T
1000 MCM	1.152" (29.26 mm)	37	Hawkweed	1678-50		1628-30T*		1628-50T*
1033.5 MCM	1.170" (29.71 mm)	37	Bluebell	1678-50		1628-30T*		1628-50T*
1033.5 MCM	1.172" (29.76 mm)	61	Larkspur	1678-50		1628-30T*		1628-50T*
1113 MCM	1.216" (30.88 mm)	61	Marigold			1628-30U*	1628-40U*	1628-50U*
1192.5 MCM	1.258" (31.96 mm)	61	Hawthorn			1628-30U*	1628-40U*	1628-50U*
1272 MCM	1.297" (32.94 mm)	61	Narcissus				1628-40W*	1628-50W*
1351.5 MCM	1.339" (34.02 mm)	61	Columbine				1628-40X*	1628-50X*
1431 MCM	1.379" (35.02 mm)	61	Carnation				1628-40X*	1628-50X*
1510.5 MCM	1.417" (35.98 mm)	61	Gladiolus				1628-40Y*	1628-50Y*
1590 MCM	1.454" (36.93 mm)	61	Coreopsis				1628-40Z*	1628-50Z*
1750 MCM	1.524" (38.72 mm)	61	Jessamine				1628-40A*	1628-50A*
2000 MCM	1.630" (41.41 mm)	91	Cowslip					1628-50B*
2250 MCM	1.729" (43.92 mm)	91	Sagebrush					1628-50D*
2500 MCM	1.823" (46.30 mm)	91	Lupine					1628-50E*

** Maximum safe stringing tension 12,500 lbs to minimize cable deformation.

* Special order. Please allow 30 days for delivery. These are not returnable.

Chicago® Grip - 1678 Series

- Round jaws shaped to provide maximum contact with circumference of cable, less likely to cause cable deformation.
- Supplied with spring and locking loop handles, allowing jaws to be held in open position for easier placement on cable.



1678-30

A 5,500 lbs. (2,495 kg) Maximum Safe Load

Cat. No.	Min. to Max. Cable MCM	Min. to Max. Cable Diameter inches (mm)	Jaw Length	Approx. Weight Each
1678-30	795 MCM - 874.5 MCM	1.026" - 1.077" (26.06 mm - 27.36 mm)	5 11/16" (144mm)	8.20 lbs. (3.71 kg)
1678-40	900 MCM - 954 MCM	1.092" - 1.126" (27.74 mm - 28.60 mm)	5 11/16" (144mm)	8.20 lbs. (3.71 kg)
1678-50	1000 MCM - 1033.5 MCM	1.152" - 1.172" (29.26 mm - 29.77 mm)	5 11/16" (144mm)	7.90 lbs. (3.58 kg)

All dimensions are in inches and (millimeters) unless otherwise specified.

⚠WARNING: Grips are to be used for temporary installation, not for permanent anchorage.

⚠WARNING: When used on/or near energized lines, ground, insulate, or isolate grip before pulling.

⚠WARNING: Do not exceed rated capacity.

⚠WARNING: Always match proper size and type of grip to application.

⚠WARNING: Before each use, clean jaw area and inspect grip for proper operation to avoid slippage.



Chicago® Grip – 1678 Series (continued)

B 8,000 lbs. (3,629 kg) Maximum Safe Load

Cat. No.	Min. to Max. Cable MCM	Min. to Max. Cable Diameter inches (mm)	Jaw Length	Approx. Weight Each
1678-20	700 MCM - 750 MCM	.963" - .998" (24.46 mm - 25.35 mm)	5-11/16" (144 mm)	8.30 lbs. (3.71 kg)

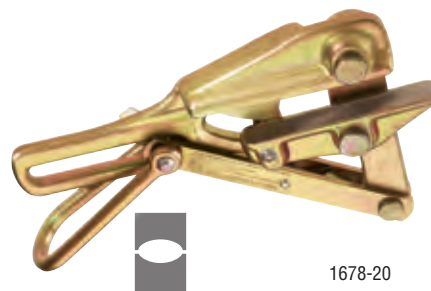

1678-20

Chicago® Grip – 1628 Series

- Round jaws are shaped to provide maximum contact with the cable, virtually eliminating cable deformation.

C 20,000 lbs. (9,072 kg) Maximum Safe Load

Cat. No.	Min. to Max. Cable MCM	Min. to Max. Cable Diameter inches (mm)	Jaw Length	Approx. Weight Each
1628-30P*	700 MCM - 750 MCM	.963" - .998" (24.46 mm - 25.35 mm)	10-3/4" (273 mm)	27 lbs. (12.27 kg)
1628-30R*	795 MCM - 874.5 MCM	1.026" - 1.077" (26.06 mm - 27.36 mm)	10-3/4" (273 mm)	27 lbs. (12.27 kg)
1628-30S*	900 MCM - 954 MCM	1.092" - 1.126" (27.74 mm - 28.60 mm)	10-3/4" (273 mm)	27 lbs. (12.27 kg)
1628-30T*	1000 MCM - 1033.5 MCM	1.152" - 1.172" (29.26 mm - 29.77 mm)	10-3/4" (273 mm)	27 lbs. (12.27 kg)
1628-30U*	1113 MCM - 1192.5 MCM	1.216" - 1.258" (30.89 mm - 31.95 mm)	10-3/4" (273 mm)	27 lbs. (12.27 kg)

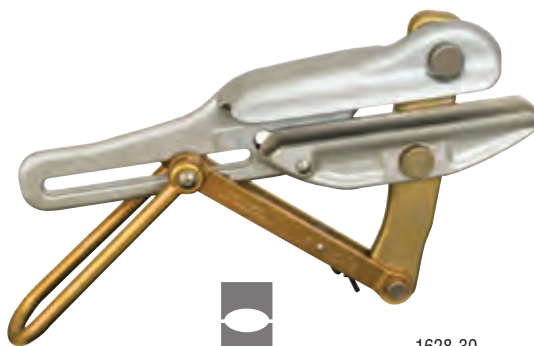

1628-30

D 25,000 lbs. (11,340 kg) Maximum Safe Load

Cat. No.	Min. to Max. Cable MCM	Min. to Max. Cable Diameter inches (mm)	Jaw Length	Approx. Weight Each
1628-40U*	1113 MCM - 1192.5 MCM	1.216" - 1.258" (30.89 mm - 31.95 mm)	10-3/4" (273 mm)	34 lbs. (15.45 kg)
1628-40W*	1272 MCM	1.297" (32.94 mm)	10-3/4" (273 mm)	34 lbs. (15.45 kg)
1628-40X*	1351.5 MCM - 1431 MCM	1.339" - 1.379" (34.01 mm - 35.03 mm)	10-3/4" (273 mm)	34 lbs. (15.45 kg)
1628-40Y*	1510.5 MCM	1.417" (35.99 mm)	10-3/4" (273 mm)	34 lbs. (15.45 kg)
1628-40Z*	1590 MCM	1.454" (36.93 mm)	10-3/4" (273 mm)	34 lbs. (15.45 kg)
1628-40A*	1750 MCM	1.524" (38.71 mm)	10-3/4" (273 mm)	34 lbs. (15.45 kg)

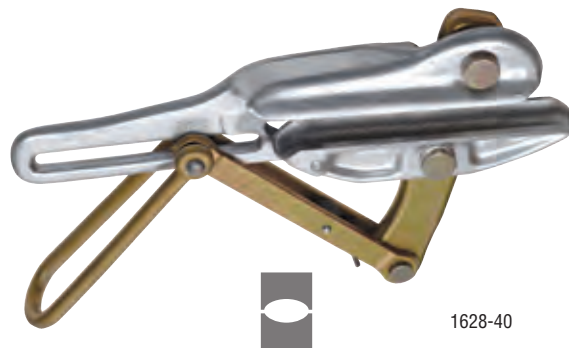

1628-40

E 25,000 lbs. (11,340 kg) Maximum Safe Load with bolt on jaw

Cat. No.	Min. to Max. Cable MCM	Min. to Max. Cable Diameter inches (mm)	Jaw Length	Approx. Weight Each
1628-50P*	700 MCM - 750 MCM	.963" - .998" (24.46 mm - 25.35 mm)	10-3/4" (273 mm)	34 lbs. (15.45 kg)
1628-50R*	795 MCM - 874.5 MCM	1.026" - 1.077" (26.06 mm - 27.36 mm)	10-3/4" (273 mm)	34 lbs. (15.45 kg)
1628-50S*	900 MCM - 954 MCM	1.092" - 1.126" (27.74 mm - 28.60 mm)	10-3/4" (273 mm)	34 lbs. (15.45 kg)
1628-50T*	1000 MCM - 1033.5 MCM	1.152" - 1.172" (29.26 mm - 29.77 mm)	10-3/4" (273 mm)	34 lbs. (15.45 kg)
1628-50U*	1113 MCM - 1192.5 MCM	1.216" - 1.258" (30.89 mm - 31.95 mm)	10-3/4" (273 mm)	34 lbs. (15.45 kg)
1628-50W*	1272 MCM	1.297" (32.94 mm)	10-3/4" (273 mm)	34 lbs. (15.45 kg)
1628-50X*	1351.5 MCM - 1431 MCM	1.339" - 1.379" (34.01 mm - 35.03 mm)	10-3/4" (273 mm)	34 lbs. (15.45 kg)
1628-50Y*	1510.5 MCM	1.417" (35.99 mm)	10-3/4" (273 mm)	34 lbs. (15.45 kg)
1628-50Z*	1590 MCM	1.454" (36.93 mm)	10-3/4" (273 mm)	34 lbs. (15.45 kg)
1628-50A*	1750 MCM	1.524" (38.71 mm)	10-3/4" (273 mm)	34 lbs. (15.45 kg)
1628-50B*	2000 MCM	1.630" (41.40 mm)	10-3/4" (273 mm)	34 lbs. (15.45 kg)
1628-50D*	2250 MCM	1.729" (43.92 mm)	10-3/4" (273 mm)	34 lbs. (15.45 kg)
1628-50E*	2500 MCM	1.823" (46.30 mm)	10-3/4" (273 mm)	34 lbs. (15.45 kg)

*These grips are special order only. Please allow 30 days for delivery. These are not returnable.



- Removable bolt on floating jaw, secured by a slotted nut and cotter pin. Jaw provides increased cable coverage.

Note: Jaw must be removed to insert cable.



Copper – Chicago® Grips

Bare Stranded Chicago® Grips – 1656 Series

- Round, smooth inside jaw contour on this series of grips is ideal for stranded-copper cables.
- Smooth jaws grip with maximum contact and are less likely to cause cable deformation.

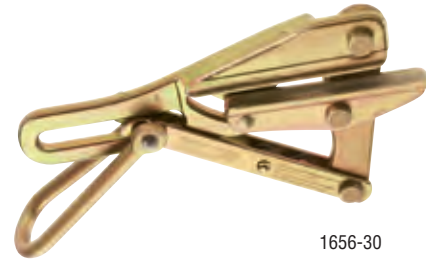

1656-30

Cat. No.	Hot Latch Model No.	Hot Latch/Spring Model No.	Min. to Max. Cable Diameter inches (mm)	Jaw Length	Approx. Weight Each
4,500 lbs. (2,041 kg) Maximum Safe Load					
1656-20	1656-20H	S1656-20H	.20" - .40" (5.08 mm - 10.16 mm)	4" (102 mm)	3 lbs. (1.36 kg)
1656-30	1656-30H	S1656-30H	.31" - .53" (7.87 mm - 13.46 mm)	4 3/4" (121 mm)	3.75 lbs (1.70 kg)
8,000 lbs. (3,629 kg) Maximum Safe Load					
1656-40	1656-40H	S1656-40H	.53" - .74" (13.46 mm - 18.80 mm)	5 1/2" (140 mm)	8.30 lbs (3.76 kg)
1656-50	1656-50H	S1656-50H	.74" - .86" (18.80 mm - 21.84 mm)	5 1/2" (140 mm)	8.30 lbs (3.76 kg)
1656-60	1656-60H	S1656-60H	.86" - .96" (21.84 mm - 24.38 mm)	5 1/2" (140 mm)	8.20 lbs (3.71 kg)



Weatherproof Stranded and Solid Chicago® Grips – 1611 Series

- Round inside jaw contour for weatherproof coated wire.
- Notches in jaw provide firm grip on insulation.



Notched Jaw



1611-30

Cat. No.	Min. to Max. Cable Diameter inches (mm)	Jaw Length	Approx. Weight Each
4,500 lbs. (2,041 kg) Maximum Safe Load			
1611-20	.20" - .40" (5.08 mm - 10.16 mm)	4-3/16" (106 mm)	3 lbs. (1.36 kg)
1611-30	.31" - .53" (7.87 mm - 13.46 mm)	4-3/4" (121mm)	3.75 lbs (1.70 kg)
8,000 lbs. (3,629 kg) Maximum Safe Load			
1611-40	.53" - .74" (13.46 mm - 18.80 mm)	5-11/16" (144 mm)	7.75 lbs (3.52 kg)
1611-50	.74" - .86" (18.80 mm - 21.84 mm)	5-11/16" (144 mm)	7.75 lbs (3.52 kg)

Note: Due to various types of weatherproof coatings available, selection of proper grips is determined by outside diameter of cable.

PVC-Covered Chicago® Grips – 1659 Series

- Specially machined serpentine jaws allow insulated conductor to be inserted through jaws.
- Eliminates necessity of stripping insulation from conductor.
- Round inside-jaw contour.



Serpentine Jaw

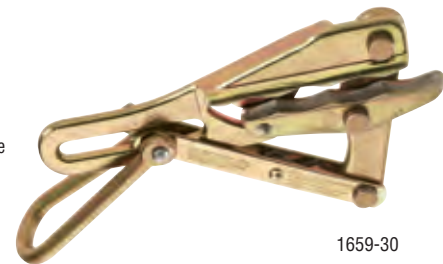

1659-30

Cat. No.	Min. to Max. Cable Diameter inches (mm)	Jaw Length	Approx. Weight Each
4,500 lbs. (2,041 kg) Maximum Safe Load			
1659-20	.20" - .42" (5.08 mm - 10.67 mm)	4-3/16" (106 mm)	3 lbs. (1.36 kg)
1659-30	.31" - .50" (7.87 mm - 12.70 mm)	4-3/4" (121 mm)	3.75 lbs (1.70 kg)
8,000 lbs. (3,629 kg) Maximum Safe Load			
1659-40	.49" - .79" (12.45 mm - 20.07 mm)	5-11/16" (144 mm)	7.75 lbs (3.52 kg)
1659-50	.79" - 1.01" (20.07 mm - 25.56 mm)	5-11/16" (144 mm)	7.75 lbs (3.52 kg)



All dimensions are in inches and (millimeters) unless otherwise specified.

⚠WARNING: Grips are to be used for temporary installation, not for permanent anchorage.

⚠WARNING: When used on/or near energized lines, ground, insulate, or isolate grip before pulling.

⚠WARNING: Do not exceed rated capacity.

⚠WARNING: Always match proper size and type of grip to application.

⚠WARNING: Before each use, clean jaw area and inspect grip for proper operation to avoid slippage.



Bell System B, L, and H Chicago® Grips – 1628, 1659, 1684 & 1692 Series

- All are equipped with chain, toggle and shackle-keeps the grip from falling off of cable.
- 1659 - 5AT is similar to Bell-System type "B" Strand Puller. Designed to pull 1/4" (6.35 mm) figure-8 telephone cable. Also has serpentine jaw.
- 1684 - 5AT is identical to Bell-System type "L" Strand Puller.
- 1628 - 16AT is identical to Bell-System type "H" Strand Puller.



1659-5AT



Serpentine Jaw

Cat. No.	Min. to Max. Cable Diameter inches (mm)	Jaw Length	Approx. Weight Each
5,000 lbs. (2,268 kg) Maximum Safe Load			
1659-5AT ("B" Strand Puller)	.20" - .37" (5.08 mm - 9.40 mm)	5" (127mm)	6.70 lbs. (3.03 kg)
8,000 lbs. (3,629 kg) Maximum Safe Load			
1684-5AT ("L" Strand Puller)	.218" - .550" (5.54 mm - 13.97 mm)	5" (127mm)	6.9 lbs (3.13 kg)
1692-5AT ("L" Strand Puller)	.218" - .550" (5.54 mm - 13.97 mm)	5" (127mm)	6.6 lbs (3.00 kg)
15,000 lbs. (6,803 kg) Maximum Safe Load			
1628-16AT ("H" Strand Puller)	.31" - .62" (7.87 mm - 15.75 mm)	7 1/4" (184 mm)	15.80 lbs (7.16 kg)

*1692-5AT (larger clamping force than 1684-5AT)

Aircraft Cable, EHS (Extra-High-Strength), Messenger, and Guy Strand Chicago® Grips – 1613, 1628, 1684 and 1692 Series

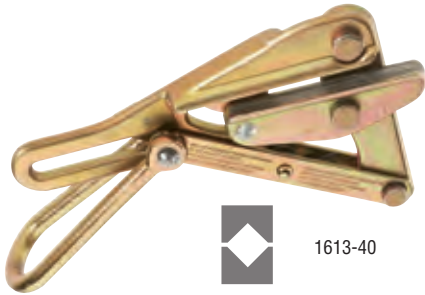

1613-40

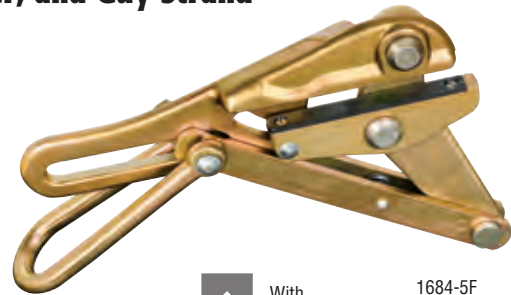

1684-5F



With file insert

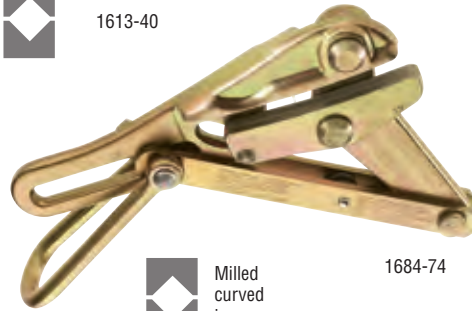

1684-74



Milled curved jaw

- A family of grips designed for cable sizes from .12" (3.10 mm) to 1" (25.4 mm).
- Double V grooves provide four-point contact, reducing chance of slipping and providing proper alignment of wire and cable. (1684-5F is a Single V with file insert.)



Replacement screws (Cat. No. 573) and file (Cat. No. 578)

Cat. No.	Hot Latch Model No.	Hot Latch/Spring Model No.	Min. to Max. Cable Diameter inches (mm)	Jaw Length	Approx. Weight Each
4,500 lbs. (2,041 kg) Maximum Safe Load					
1613-40	1613-40H	S1613-40H	.12" - .37" (3.05 mm - 9.40 mm)	4-3/16" (106 mm)	3 lbs. (1.36 kg)
8,000 lbs. (3,629 kg) Maximum Safe Load					
1684-5F (includes replacement file)	NA	NA	.16" - .550" (4.06 mm - 13.97 mm)	5" (127 mm)	6.25 lbs. (2.84 kg)
1684-5	1684-5H	S1684-5H	.218" - .550" (5.54 mm - 13.97 mm)	5" (127 mm)	6.25 lbs. (2.84 kg)
1692-5 (larger clamping force than 1684-5)	NA	NA	.218" - .550" (5.54 mm - 13.97 mm)	5" (127 mm)	6.40 lbs. (2.89 kg)
8,000 lbs. (3,629 kg) Maximum Safe Load – EHS Specific					
1684-74 (Includes curved jaw)	NA	S1684-74H	.218" - .550" (5.54 mm - 13.97 mm)	5" (127 mm)	6.30 lbs. (2.85 kg)
15,000 lbs. (6,803 kg) Maximum Safe Load					
1628-16	NA	NA	.31" - .62" (7.87 mm - 15.75 mm)	7-1/4" (184 mm)	15.30 lbs. (7.00 kg)
1628-17	NA	NA	.50" - .75" (12.70 mm - 19.05 mm)	7-1/4" (184 mm)	16.30 lbs. (7.40 kg)
1628-18	NA	NA	.75" - 1.00" (19.05 mm - 25.40 mm)	7-1/4" (184 mm)	15.70 lbs. (7.10 kg)

All dimensions are in inches and (millimeters) unless otherwise specified.

▲WARNING: See facing page.



Copper/Steel Strand – Chicago® Grips

Bare Wire

Chicago® Grips – 1613 Series

- Designed for working with solid and stranded bare wire from .08" (2 mm) to .20" (5.1 mm).
- Lightweight, especially economical grip.
- Single "V" groove jaw.

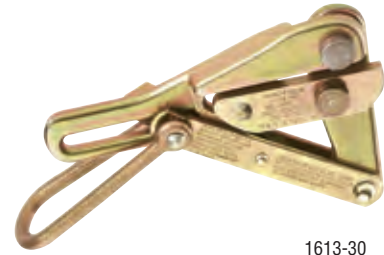

1613-30

Cat. No.	Minimum Cable	Maximum Cable	Maximum Safe Load	Jaw Length	Approx. Weight Each
1613-30	12 B&S solid .08" (2.03 mm)	4 B&S solid .20" (5.08 mm)	1500 lbs. (680 kg)	3" (76 mm)	1.50 lbs. (.68 kg)

Steel Strand – Haven's® Grips

Messenger and Guy Strand Haven's® Grips – 1604 Series

- Designed for use when light, compact grip is desired and where cable deformation is not a factor.
- Gripping pressure of the knurled jaw is applied to 1/4" (6.35 mm) cable area.



1604-20



1604-20L

Cat. No.	Latch Model	Min. to Max. Cable Diameter inches (mm)	Jaw Length	Approx. Weight Each
2,500 lbs. (1,134 kg) Maximum Safe Load				
1604-10	NA	.06" - .25" (1.52 mm - 6.35 mm)	N/A	1 lb. (.45 kg)
5,000 lbs. (2,268 kg) Maximum Safe Load				
1604-20	1604-20L	.125" - .50" (3.18 mm - 12.70 mm)	N/A	2.08 lbs. (1.14 kg)

Wire Rope Haven's® Grips – 1625 Series

- Designed for use when light, compact grip is desired and where cable deformation is not a factor.
- Gripping pressure of the knurled jaw is applied to 1/4" (6.35 mm) cable area.
- All 1625 series have a swing latch to help hold cable in the jaw.



1625-20

Cat. No.	Min. to Max. Cable Diameter inches (mm)	Jaw Length	Approx. Weight Each
8,000 lbs. (3,629 kg) Maximum Safe Load			
1625-20	.28" - .75" (7.11 mm - 19.05 mm)	N/A	4 lbs. (1.81 kg)
1625-20 7/8	.38" - .88" (9.65 mm - 22.35 mm)	N/A	4 lbs. (1.81 kg)
1625-20 1	.50" - 1.00" (12.70 mm - 25.40 mm)	N/A	4 lbs. (1.81 kg)

All dimensions are in inches and (millimeters) unless otherwise specified.

⚠WARNING: Grips are to be used for temporary installation, not for permanent anchorage.

⚠WARNING: When used on/or near energized lines, ground, insulate, or isolate grip before pulling.

⚠WARNING: Do not exceed rated capacity.

⚠WARNING: Always match proper size and type of grip to application.

⚠WARNING: Before each use, clean jaw area and inspect grip for proper operation to avoid slippage.



Parallel Jaw Grips – KT4500, KT4600 and KT4800 Series

- The KT4500, KT4600 and KT4800 Series feature a round serrated jaw.
- KT4501, KT4502, KT4601, KT4602, KT4801, KT4802 are supplied with hot latches.
- Hot latch closes automatically to guard against grip accidentally disengaging from wire.
- Large opening in the handle to accommodate a wide variety of hooks on hoists, winches and tackle blocks.



KT4500



KT4602

Cat. No.	Min. to Max. Cable Diameter inches (mm)	Hot Latch	Spring	Locking Handle	Jaw Length	Approx. Weight Each
5,000 lbs. (2,268 kg) Maximum Safe Load						
KT4500	.180" - .600" (4.57 mm - 15.2 mm)		●		3" (76 mm)	3.75 lbs. (1.70 kg)
KT4501	.180" - .600" (4.57 mm - 15.2 mm)	●	●	●	3" (76 mm)	3.75 lbs. (1.70 kg)
KT4502	.180" - .600" (4.57 mm - 15.2 mm)	●			3" (76 mm)	3.75 lbs. (1.70 kg)
10,000 lbs. (4,536 kg) Maximum Safe Load						
KT4600	.300" - .800" (7.62 mm - 20.3 mm)		●		5" (127 mm)	7 lbs. (3.18 kg)
KT4601	.300" - .800" (7.62 mm - 20.3 mm)	●	●	●	5" (127 mm)	7 lbs. (3.18 kg)
KT4602	.300" - .800" (7.62 mm - 20.3 mm)	●			5" (127 mm)	7 lbs. (3.18 kg)
12,000 lbs. (5,443 kg) Maximum Safe Load						
KT4800	.700" - 1.25" (17.8 mm - 31.8 mm)		●		5-1/8" (130 mm)	9 lbs. (4.1 kg)
KT4801	.700" - 1.25" (17.8 mm - 31.8 mm)	●	●	●	5-1/8" (130 mm)	9 lbs. (4.1 kg)
KT4802	.700" - 1.25" (17.8 mm - 31.8 mm)	●			5-1/8" (130 mm)	9 lbs. (4.1 kg)



All dimensions are in inches and (millimeters) unless otherwise specified.

▲WARNING: Grips are to be used for temporary installation, not for permanent anchorage.

▲WARNING: When used on/or near energized lines, ground, insulate, or isolate grip before pulling.

▲WARNING: Do not exceed rated capacity.

▲WARNING: Always match proper size and type of grip to application.

▲WARNING: Before each use, clean jaw area and inspect grip for proper operation to avoid slippage.



Wide Range of Cables

Parallel Jaw Grips – 1685 Series

- Lightweight, compact grips pull an exceptionally wide range of cable types and sizes.
- Designed with a round inside-jaw contour for maximum contact to minimize cable deformation.
- Lower jaw is serrated to firmly grip insulated cables and conductors.
- Design includes a latch that prevents the grip from falling in case of jaw disengagement from the cable.
- Large-diameter eye accommodates large hooks on hoists, winches and tackle blocks.

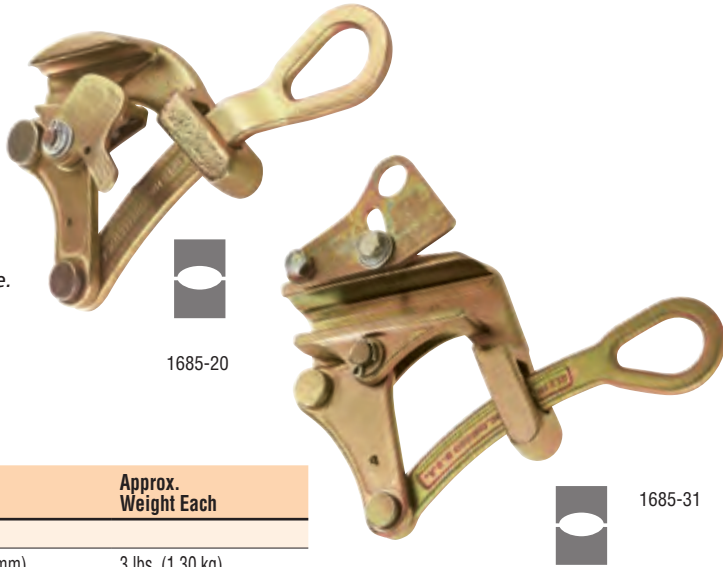

Cat. No.	Min. to Max. Cable Diameter inches (mm)	Jaw Length	Approx. Weight Each
4,500 lbs. (2,041 kg) Maximum Safe Load			
1685-20	.157" - .875" (4 mm - 22 mm)	2-1/2" (64 mm)	3 lbs. (1.30 kg)
7,500 lbs. (3,400 kg) Maximum Safe Load			
1685-31	.625" - 1.250" (16 mm - 32 mm)	4-1/2" (114 mm)	5 lbs. (2.27 kg)

Parallel Jaw Grips – 1686-10, 1686-20, 1671-10 and 1672-10

- Longer jaws achieve a firm hold, reducing possibility of slippage and deformation to cable.
- Designed with a Double V jaw contour, a latch, plus a large-diameter eye that accommodates large hooks on hoists, winches, and tackle blocks.
- When latch is closed, it helps maintain cable position in grip jaws.

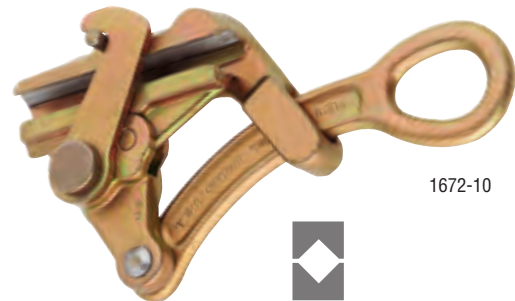

Cat. No.	Min. to Max. Cable Diameter inches (mm)	Jaw Length	Approx. Weight Each
10,000 lbs. (4,536 kg) Maximum Safe Load			
1686-10	.20" - .40" (5.08 mm - 10.16 mm)	4-3/8" (111 mm)	5 lbs. (2.27 kg)
1686-20 Knurled Jaw	.20" - .40" (5.08 mm - 10.16 mm)	4-3/8" (111 mm)	5 lbs. (2.27 kg)
1671-10	.37" - .75" (9.40 mm - 19.05 mm)	4-3/8" (111 mm)	5 lbs. (2.27 kg)
1672-10 Knurled Jaw	.37" - .75" (9.40 mm - 19.05 mm)	4-3/8" (111 mm)	5 lbs. (2.27 kg)

All dimensions are in inches and (millimeters) unless otherwise specified.

▲WARNING: Grips are to be used for temporary installation, not for permanent anchorage.

▲WARNING: When used on/or near energized lines, ground, insulate, or isolate grip before pulling.

▲WARNING: Do not exceed rated capacity.

▲WARNING: Always match proper size and type of grip to application.

▲WARNING: Before each use, clean jaw area and inspect grip for proper operation to avoid slippage.



Interchangeable Jaw Grips & Liners

Interchangeable Jaw Grips & Liners

- Constructed of high strength alloy steel, hot forged, heat treated, and galvanized for toughness, strength and corrosion resistance.
- Suitable for Optical Ground Wire (OPGW) conductors .236" to .906" (6 mm - 23 mm) (Cat. No. 1628-80).
- Offers a full range of interchangeable liners to be inserted between the upper and lower jaws of the grip.

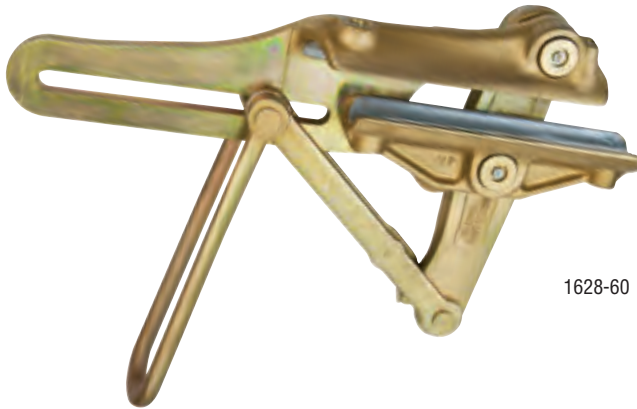

1628-60



1628-80



Lower liner – Aluminum
Upper liner – Aluminum
(Cat. Nos. 1628-60, 1628-70)



Lower liner – Polyurethane
(provides cushioning for the optical cable)
Upper liner – Aluminum
(Cat. No. 1628-80)

- Liners are made to order. Call customer service with details of cable diameter, cable type and working load requirements for availability and lead time.

Cat. No.	Description	Cable Diameter Range	Maximum Working Load	Recommended For:	Weight
1628-60	1628-60 grip body only	.394" to 1.614" (10 mm to 41 mm)	6,750 lbs. (3060 kg.)	conductor cable	38 lbs. (17 kg.)
1628-70	1628-70 grip body only	.236" to .906" (6 mm to 23 mm)	6,750 lbs. (3060 kg.)	conductor cable	15 lbs. (7 kg.)
1628-80	1628-80 OPGW grip body only	.236" to .906" (6 mm to 23 mm)	6,750 lbs. (3060 kg.)	OPGW	15 lbs. (7 kg.)

▲WARNING: Grips are to be used for temporary installation, not for permanent anchorage.

▲WARNING: When used on/or near energized lines, ground, insulate, or isolate grip before pulling.

▲WARNING: Do not exceed capacity.

All dimensions are in inches and (millimeters) unless otherwise specified.

▲WARNING: Always match proper size and type of grip to application.

▲WARNING: Before each use, clean jaw area and inspect grip for proper operation to avoid slippage.



Accessories

Grip-Cleaning Brush Set

- Set of four wire-bristle brushes designed for cleaning Klein wire and cable-pulling grips.
- Brushes have stiff wire bristles.
- Available in round and square shapes and two lengths for efficient cleaning of different jaw configurations.
- Semi-flexible steel shafts set into comfortable wooden handles provide the necessary reach into grip jaws.



25450

Cat. No.	Set Contains	Weight (lbs.)
25450		1.00

Description	Bristle Diameter and Length	Overall Length
round-bristle	3/8" x 3" (10 mm x 76 mm)	12" (305 mm)
square-bristle	3/8" x 3" (10 mm x 76 mm)	12" (305 mm)
round-bristle	1-9/16" x 5" (40 mm x 127 mm)	14" (356 mm)
square-bristle	1-9/16" x 5" (40 mm x 127 mm)	14" (356 mm)

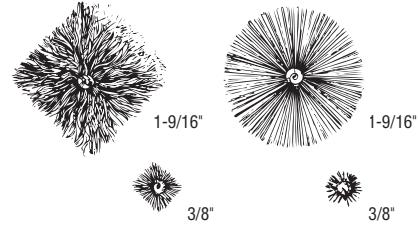

Howe Wire Tool

- Strap is made of tough Klein-Kord®.
- Swivel hook is forged steel with large opening.
- Shank of hook is lengthened to reach under insulator.
- Other end has cam-lock to hold the load at any distance.
- All metal parts are galvanized.
- Max. safe load 500 lbs. (225 kg).



1702-20N

Cat. No.	Description	Weight (lbs.)
1702-20N	Klein-Kord® strap 1" x 7' (25 mm x 2.1 m)	1.95



Introduction – Wire-Mesh Grips

Klein mesh pulling-grips are used for pulling overhead or underground cable, for stringing service or communication lines into buildings, for pulling wire through conduit, and for general underground construction.

Klein grips may be used for pulling bare or insulated wires, and wire rope. They install quickly and easily, and are designed to pass readily through ducts, conduit, blocks, and sheaves.

Klein grips are reusable and do not damage the cable because pulling tension remains uniform along the length of the grip. The mesh will fit either a single cable, or a bundle of cables.

Klein pulling grips are woven of galvanized steel – strong and long lasting.

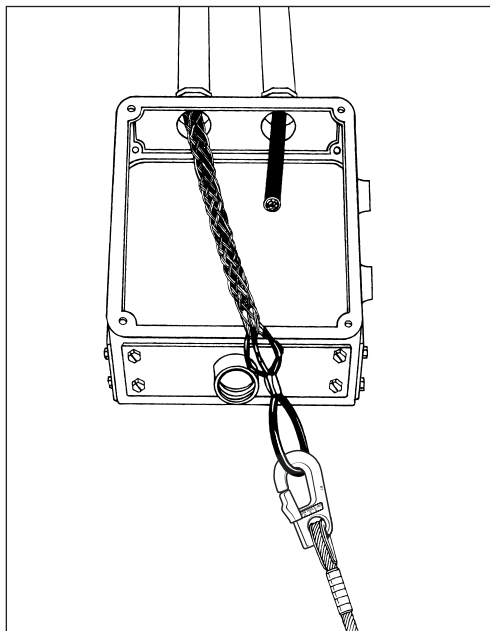

General Application Information

KPJ junior-duty series is used for small-job requirements where pulling tensions are low. Typical uses are to connect insulated building wire bundles to pulling tape, and pull through conduit.

KPL light duty grips are economical for applications such as industrial plant wiring and rewiring jobs, and in underground electrical construction where pulling tensions are low.

KPM medium-duty grips are flexible and easily handled, ideal for use where the exceptional strength of heavy-duty grips is not required.

KP and **KPS** series are recommended for heavy-duty application for underground installations. The **KPS** series has a “rotating eye” to allow twists in the cable to spin out during slack periods.

KSCK medium-duty slack-pulling grips with closed double-weave mesh are used for final placement of underground cable where cable end is available, or for removing cable. Standard lengths are used in restricted space for short pulls. Where space is not restricted, longer lengths are used for higher pulling loads.

KSSK medium-duty slack-pulling grip applications are similar to the **KSCK** series except they are used where cable end is not available. Double-weave split mesh has lace closure.

KSRK light-duty slack-pulling grips are split mesh, single-weave design with rod closure for quick installation. Application areas similar to **KSSK** series, except mesh lengths are shorter and are for lower pulling loads.

Prefix Letter Code

KP	Pulling, Heavy-Duty, Closed-Mesh, Double-Weave, Flexible Eye
KPJ	Pulling, Junior-Duty, Closed-Mesh, Single-Weave, Flexible Eye
KPL	Pulling, Light-Duty, Closed-Mesh, Single-Weave, Flexible Eye
KPM	Pulling, Medium-Duty, Closed-Mesh, Double-Weave, Flexible Eye
KPS	Pulling, Heavy-Duty, with Rotating Eye, Closed-Mesh, Double-Weave
KSCK	Slack-Pulling, Closed-Mesh, Double-Weave, Offset Flexible Eye
KSSK	Slack-Pulling, Split-Mesh, Double-Weave, Lace Closure, Offset Flexible Eye
KSRK	Slack-Pulling, Split-Mesh, Single-Weave, Rod Closure, Offset Flexible Eye

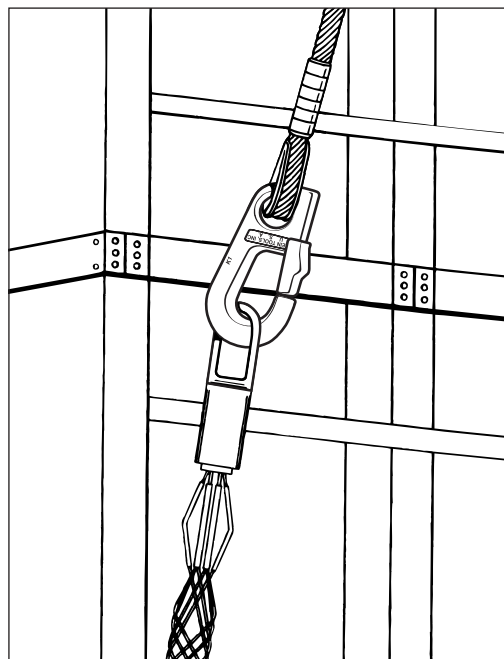

Catalog Number Explanation

KPS	—	050	—	2
Grip Type* and Mesh		Cat. No.** Size Code		Final Digit, if any, refers to mesh length range or actual dimension.

* See Prefix Letter Code explanation.

** On Junior-duty grips, initial digit “0” is omitted in Cat. No.

Example:

Cat. No. **KPS-050-2** is a heavy-duty pulling grip with a rotating eye, for use with cable diameters from .50" to .61", with medium-length mesh.

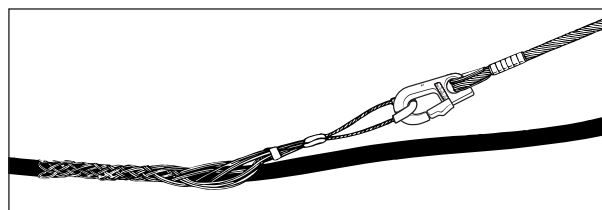

Introduction – Wire-Mesh Grips

How to select proper grip eye and mesh type

There are three basic styles of pulling grips, together with a choice of wire mesh types and lengths to meet a wide variety of pulling requirements.

1. Flexible Eye: Closed Mesh

KPJ/KPL/KPM/KP

This pulling-grip eye allows maximum flexibility to follow the line of pull, and is used when the end of the cable is available. Mesh selection depends on the weight of the material being pulled. Closed-mesh, single weave, flexible-eye grips are offered in lengths for junior-duty and light-duty use; closed-mesh, double-weave, flexible-eye grips are offered for medium-duty and heavy-duty use.

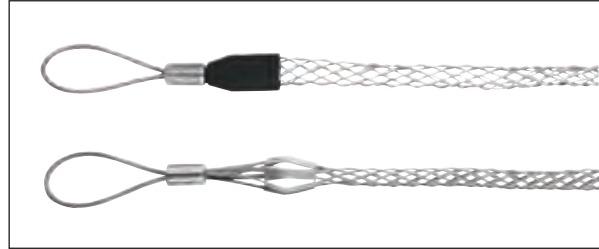

2. Rotating Eye: Closed Mesh

KPS

Recommended for heavier pulling jobs and underground wiring, this pulling grip eye is furnished on double-weave mesh grips in a wide range of lengths. The rotating eye compensates for pulling torque, relieving strain on the cable. **Rotating-eye grips should not be used on rope or as a swivel.**



3. Offset Flexible Eye: Closed and Split Mesh

KSCK/KSSK/KSRK

These slack-pulling grips come in three styles: (1) double-weave closed-mesh (for medium duty where the end of the cable is available), (2) double-weave split-mesh with lace closure (medium duty, where cable end is not available) and (3) single-weave split-mesh with rod closure (light duty, where cable end is not available).

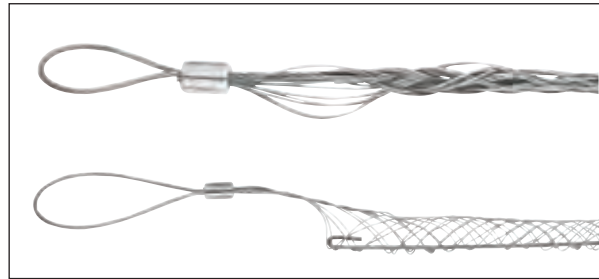

How grips are attached to cable

Closed-mesh grips

Closed-mesh grips simply slip over the cable where the cable end is accessible.

Split-mesh grips

Split-mesh grips are used when the end of the cable is not available. The grip is folded around the cable, and secured with a wire lace or steel rod (supplied with the grip) as follows:

1. Split mesh with lace closure

Start at the lead end of the grip, threading the lace through the first two loops of the split, then pulling it through until ends are centered evenly. Cross the lace ends and thread through next two loops, and so on down the grip. Do not pull lacing too tight. Spacing of laced closure should be about the same as the mesh weave. When the end of the grip is reached, twist lacing strands tightly together; wrap ends of lace around grip, and twist again to secure. Excess may be cut off.

2. Split mesh with rod closure

Split-mesh grips with rod closure can be quickly installed. Simply wrap the grip around the cable, then thread the rod through the loops, using a cork-screw motion. To remove, pull the rod out, and the grip is ready for re-use.

Design Strength

Applications and conditions of use for Klein mesh pulling grips vary so widely that it is impossible to set any meaningful standard for “breaking strength.”

With wire-mesh pulling grips, the holding power achieved is directly related to the length of mesh. The longer the mesh, the firmer the grip on the cable. For smaller-diameter cable, or where the weight to be pulled is less, short mesh grips will serve the purpose.



How to select the proper pulling grip for your application

1. Select the proper pulling-grip series (Prefix Letter Code... e.g. KPS) based on the "General Application Information" descriptions in the Wire-Mesh Grips Introduction on preceding pages.
2. Select grip size based on the outside diameter or circumference of the cable(s) to be pulled. Refer to reference tables (on this and following page) for convenience in determining cable diameters.
3. Use Pulling-Grip Selection Tables (on this and following page) to determine the "Size" portion of the Catalog Number for the cable diameter required. In the ordering tables (see following pages) this "Size" code is incorporated within the catalog number under the various grip-type classifications.

Table 1

Pulling Grip Selection Table for One or More Cables of Equal Diameter to Be Pulled in One Grip

1. Read across on top line for number of cables in one grip.
2. Read down for diameter of each cable.
3. Use Cat. No. size code to select catalog number of the required size grip.

Example:

3 Cables, each with diameter of 1.31" use grip with Cat. No. Size Code 250.

Cable Diameters in Decimal Inches

1 Cable	2 Cables	3 Cables	4 Cables	5 Cables	6 & 7 Cables	8 Cables	9 Cables	Cat. No. Size Code	Grip Diam. Range
0.25-0.37	0.16-0.25	0.15-0.22	0.12-0.20	0.11-0.14	0.10-0.11	0.09-0.10	0.06-0.09	025	0.12-0.37
0.37-0.50	0.25-0.36	0.22-0.33	0.20-0.28	0.14-0.25	0.11-0.25	0.10-0.20	0.09-0.19	037	0.37-0.50
0.50-0.62	0.27-0.36	0.26-0.33	0.24-0.28	0.21-0.25	0.19-0.22	0.17-0.20	0.15-0.19	050	0.50-0.62
0.62-0.75	0.36-0.45	0.33-0.36	0.28-0.31	0.25-0.29	0.22-0.26	0.20-0.23	0.19-0.22	062	0.62-0.75
0.75-1.00	0.45-0.60	0.36-0.49	0.31-0.42	0.29-0.38	0.26-0.34	0.23-0.31	0.22-0.31	075	0.75-1.00
1.00-1.25	0.60-0.76	0.49-0.63	0.42-0.54	0.38-0.48	0.34-0.43	0.31-0.39	0.29-0.36	100	1.00-1.25
1.25-1.50	0.76-0.91	0.63-0.76	0.54-0.65	0.48-0.58	0.43-0.52	0.39-0.46	0.36-0.43	125	1.25-1.50
1.50-1.75	0.91-1.08	0.76-0.89	0.65-0.77	0.58-0.67	0.52-0.60	0.46-0.54	0.43-0.49	150	1.50-1.75
1.75-2.00	1.08-1.23	0.89-1.02	0.77-0.88	0.67-0.77	0.60-0.69	0.54-0.62	0.49-0.57	175	1.75-2.00
2.00-2.50	1.23-1.54	1.02-1.28	0.88-1.10	0.77-0.96	0.69-0.86	0.62-0.77	0.57-0.72	200	2.00-2.50
2.50-3.00	1.54-1.84	1.28-1.53	1.10-1.32	0.96-1.16	0.86-1.03	0.77-0.93	0.72-0.86	250	2.50-3.00
3.00-3.50	1.84-2.15	1.53-1.79	1.32-1.54	1.16-1.35	1.03-1.20	0.93-1.08	0.86-1.00	300	3.00-3.50
3.50-4.00	2.15-2.45	1.79-2.05	1.54-1.76	1.35-1.54	1.20-1.37	1.08-1.24	1.00-1.14	350	3.50-4.00

Cable Diameters in Fractional Inches

1 Cable	2 Cables	3 Cables	4 Cables	5 Cables	6 & 7 Cables	8 Cables	9 Cables	Cat. No. Size Code	Grip Diam. Range
1/4-3/8	1/64-1/4	5/32-7/32	1/8-13/64	7/64-9/64	3/32-7/64	3/32-7/64	1/16-3/32	025	1/8-3/8
3/8-1/2	1/4-23/64	7/32-21/64	13/64-9/32	9/64-1/4	7/64-1/4	7/64-13/64	3/32-3/16	037	3/8-1/2
5/8-3/4	23/64-29/64	21/64-23/64	9/32-5/16	1/4-19/64	7/32-17/64	13/64-15/64	3/16-7/32	050	1/2-5/8
1/2-5/8	17/64-23/64	7/64-21/64	15/64-9/32	7/32-1/4	3/16-7/32	11/64-13/64	5/32-3/16	062	5/8-3/4
3/4-1	29/64-39/64	23/64-31/64	5/16-27/64	19/64-3/8	17/64-11/32	15/64-5/16	7/32-5/16	075	3/4-1
1-1-1/4	39/64-49/64	31/64-5/8	27/64-35/64	3/8-31/64	11/32-7/16	5/16-25/64	19/64-23/64	100	1-1-1/4
1-1/4-1-1/2	49/64-29/32	5/8-49/64	35/64-21/32	31/64-37/64	7/16-33/64	25/64-15/32	23/64-7/16	125	1-1/4-1-1/2
1-1/2-1-3/4	29/32-1-5/64	49/64-57/64	21/32-49/64	37/64-43/64	33/64-39/64	15/32-35/64	7/16-31/64	150	1-1/2-1-3/4
1-3/4-2	1-5/64-1-15/64	57/64-1-1/64	49/64-7/8	43/64-49/64	39/64-11/16	35/64-5/8	31/64-37/64	175	1-3/4-2
2-2-1/2	1-15/64-1-35/64	1-1/64-1-9/32	7/8-1-3/32	49/64-31/32	11/16-55/64	5/8-49/64	37/64-23/32	200	2-2-1/2
2-1/2-3	1-35/64-1-27/32	1-9/32-1-17/32	1-3/32-1-21/64	31/32-1-5/32	55/64-1-1/32	49/64-15/16	23/32-55/64	250	2-1/2-3
3-3-1/2	1-27/32-2-5/32	1-17/32-1-51/64	1-21/64-1-35/64	1-5/32-1-23/64	1-1/32-1-13/64	15/16-1-5/64	55/64-1	300	3-3-1/2
3-1/2-4	2-5/32-2-29/64	1-51/64-2-3/64	1-35/64-1-49/64	1-23/64-1-35/64	1-13/64-1-3/8	1-5/64-1-15/64	1-1-9/64	350	3-1/2-4



Introduction – Wire-Mesh Grips

Table 2

Pulling-Grip Selection Table for Cables of Different Diameters to Be Pulled in One Grip

Grip Circumference Range		Cat. No. Size Code	Grip Diameter Range	
Fractional Inches	Decimal Inches		Fractional Inches	Decimal Inches
25/32–1-11/64	.78–1.17	025	1/8–3/8	.12–.37
1-11/64–1-37/64	1.17–1.57	037	3/8–1/2	.37–.50
1-37/64–1-15/16	1.57–1.94	062	1/2–5/8	.50–.62
1-37/64–2-3/8	1.57–2.37	050	5/8–3/4	.62–.75
2-3/8–3-5/32	2.37–3.15	075	3/4–1	.75–1.00
3-5/32–3-15/16	3.15–3.94	100	1–1-1/4	1.00–1.25
3-15/16–4-23/32	3.94–4.72	125	1-1/4–1-1/2	1.25–1.50
4-23/32–5-33/64	4.72–5.51	150	1-1/2–1-3/4	1.50–1.75
5-33/64–6-19/64	5.51–6.29	175	1-3/4–2	1.75–2.00
6-19/64–7-55/64	6.29–7.86	200	2–2-1/2	2.00–2.50
7-55/64–9-7/16	7.86–9.43	250	2-1/2–3	2.50–3.00
9-7/16–11-1/64	9.43–11.01	300	3–3-1/2	3.00–3.50
11-1/64–12-37/64	11.01–12.58	350	3-1/2–4	3.50–4.00

“Grip Circumference Range” refers to circumference of all cables held together.

1. Determine grip circumference range by measuring circumference of bundle of cables to be held.
2. Read down to locate correct range.
3. Read across for catalog number size code.

Example:

For four cables together with circumference of 6.35", use grip containing catalog number size code "200".

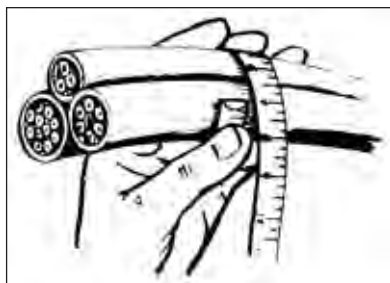

Table 4

Reference Table: AWG Wire Sizes

For your convenience, the following are representative Portable Cord diameters.

AWG Wire Size & Type	Conductors							
	2		3		4		5	
	①	②	①	②	①	②	①	②
18 SO, STO	3.90	.390	.410	.405	.440	.435	.500	.495
18 SJO, SJTO	.310	.300	.330	.330	.360	.360	–	–
16 SO, STO	.410	.405	.430	.430	.490	.485	.530	.525
16 SJO, SJTO	.330	.330	.340	.360	.390	.390	–	–
14 SO, STO	.530	.530	.560	.560	.610	.605	.680	.685
12 SO, STO	.610	.605	.640	.640	.680	.670	.750	.730
10 SO, STO	.650	.640	.690	.695	.750	.820	.815	–
8 SO, STO	.810	.810	.910	.910	.990	.990	1.080	1.080
6 SO, STO	.930	.930	1.010	1.010	1.100	1.100	1.200	1.200

Table 3

Reference Table: Dimension Conversions for Ordering Tables

Decimal Inches	Fractional Inches	Metric Dimensions (mm)
0.12–0.24	1/8–15/64	3.17–5.95
0.25–0.36	1/4–23/64	6.35–9.13
0.37–0.49	3/8–31/64	9.52–12.30
0.50–0.61	1/2–39/64	12.70–15.48
0.62–0.74	5/8–47/64	15.88–18.65
0.75–0.99	3/4–63/64	19.05–25.00
1.00–1.24	1–1-15/64	25.40–31.35
1.25–1.49	1-1/4–1-31/64	31.75–37.70
1.50–1.99	1-1/2–1-63/64	38.10–50.40
2.00–2.49	2–2-31/64	50.80–63.10
2.50–2.99	2-1/2–2-63/64	63.50–75.80
3.00–3.49	3–3-31/64	76.20–88.50
3.50–3.99	3-1/2–3-63/64	88.90–101.20

Table 5

Reference Table: AWG or MCM Wire Sizes

This table is to be used as a guide only. Sizes may vary by manufacturer.

AWG OR MCM	Diameter	
	TTHN	THW
14	.105	.162
12	.122	.179
10	.153	.199
8	.201	.259
6	.257	.323
4	.328	.372
3	.356	.401
2	.388	.433
1	.450	.508
1/0	.491	.549
2/0	.537	.595
3/0	.588	.647
4/0	.646	.705
250	.716	.788
300	.771	.843
350	.822	.895
400	.869	.942
500	.955	1.03
600	–	1.12
700	–	1.19
750	–	1.22
1000	–	1.38



Single-Weave, Flexible-Eye Pulling Grips



Cable Dia. *	KPJ Junior Duty				KPL Light Duty			
	Cat. No.	Mesh Length	Maximum Safe Load	Wt.	Short Length			
					Cat. No.	Mesh Length	Maximum Safe Load	Wt.
.50"-.61"	KPJ-50	8.5"	260 lbs. (118 kg)	.05 lbs.	—	—	—	—
.75"-.99"	KPJ-75	10"	560 lbs. (254 kg)	.10 lbs.	—	—	—	—
1.00"-1.24"	KPJ-100	11.5"	780 lbs. (354 kg)	.28 lbs.	—	—	—	—
1.25"-1.49"	—	—	—	—	KPL-125-1	14"	1060 lbs. (481 kg)	.40 lbs.
1.50"-1.74"	—	—	—	—	KPL-150-1	15"	1360 lbs. (617 kg)	.40 lbs.
2.00"-2.49"	—	—	—	—	KPL-200-1	18"	1700 lbs. (771 kg)	.65 lbs.

KPJ-62

*For equivalent cable diameters in fractional inches and in metric dimensions (mm), see Dimensions Conversion Reference Table 3.

Double-Weave, Flexible-Eye Pulling Grips



Cable Dia. *	KPM Medium Duty				KP Heavy Duty								
	Cat. No.	Mesh Length	Maximum Safe Load	Wt.	Short Length				Medium Length				
					Cat. No.	Mesh Length	Maximum Safe Load	Wt.	Cat. No.	Mesh Length	Maximum Safe Load	Wt.	
.50"-.61"	KPM-050	13"	480 lbs. (218 kg)	.10 lbs.	—	—	—	—	—	—	—	—	—
.75"-.99"	KPM-075	16"	1030 lbs. (467 kg)	.20 lbs.	KP-075-24	24"	1360 lbs. (617 kg)	.50 lbs.	KP-075-36	36"	1360 lbs. (617 kg)	.74 lbs.	
1.00"-1.37"	KPM-100	18"	1420 lbs. (644 kg)	.40 lbs.	—	—	—	—	—	—	—	—	
1.00"-1.49"	—	—	—	—	KP-100-24	24"	1920 lbs. (871 kg)	1.1 lbs.	KP-100-36	36"	1920 lbs. (871 kg)	1.0 lbs.	
1.50"-1.99"	—	—	—	—	—	—	—	—	KP-150-36	36"	3280 lbs. (1488 kg)	1.6 lbs.	

KPM-075

*For equivalent cable diameters in fractional inches and in metric dimensions (mm), see Dimensions Conversion Reference Table 3.

Double-Weave, Rotating-Eye Pulling Grips



Cable Dia. *	KPS Heavy Duty							
	Medium Length				Medium-Long Length			
	Cat. No.	Mesh Length	Maximum Safe Load	Wt.	Cat. No.	Mesh Length	Maximum Safe Load	Wt.
.50"-.61"	KPS-050-2	16"	1120 (508 kg)	.45 lbs.	—	—	—	—
.62"-.74"	KPS-062-2	16"	1360 (617 kg)	.50 lbs.	—	—	—	—
.75"-.99"	KPS-075-2	20"	1360 (617 kg)	.85 lbs.	—	—	—	—
1.00"-1.24"	KPS-100-2	20"	2560 (1161 kg)	1.9 lbs.	—	—	—	—
1.00"-1.49"	—	—	—	—	KPS-100-3	33"	3280 (1488 kg)	2.4 lbs.
1.25"-1.49"	KPS-125-2	21"	2560 (1161 kg)	1.9 lbs.	—	—	—	—
1.50"-1.99"	KPS-150-2	25"	3280 (1488 kg)	2.2 lbs.	KPS-150-3	34"	3280 (1488 kg)	2.5 lbs.
2.00"-2.49"	KPS-200-2	26"	5440 (2468 kg)	4.1 lbs.	KPS-200-3	36"	5440 (2468 kg)	4.7 lbs.
2.50"-2.99"	KPS-250-2	28"	6600 (2994 kg)	5.3 lbs.	—	—	—	—
3.00"-3.49"	KPS-300-2	30"	8200 (3720 kg)	6.1 lbs.	—	—	—	—
3.50"-3.99"	KPS-350-2	32"	9600 (4355 kg)	6.8 lbs.	—	—	—	—

KPS-062-1

*For equivalent cable diameters in fractional inches and in metric dimensions (mm), see Dimensions Conversion Reference Table 3.

⚠WARNING: Do NOT exceed maximum safe load as listed on the label attached to the product.

⚠WARNING: Always match proper size and type of grip to application.

⚠WARNING: Do NOT use on live circuits.

⚠WARNING: Always inspect equipment before use.



Wire-Mesh Grips

Slack-Pulling, Offset Flexible-Eye Pulling Grips



KSSK-100-1

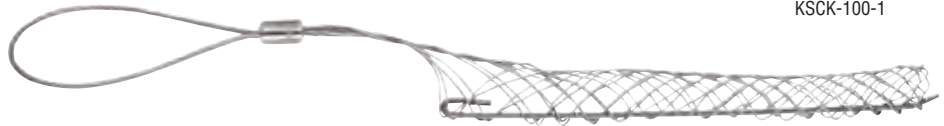

KSRK-062-1

Cable Dia. *	KSSK Medium Duty – Standard Length				KSSK Medium Duty – Standard Length			
	Cat. No.	Mesh Length	Maximum Safe Load	Wt.	Cat. No.	Mesh Length	Maximum Safe Load	Wt.
.75"–.99"	—	—	—	—	KSSK-075-1	12"	500 lbs. (227 kg)	.30 lbs.
1.00"–1.24"	KSSK-100-1	15"	800 lbs. (363 kg)	.50 lbs.	KSSK-100-1	15"	700 lbs. (318 kg)	.25 lbs.
1.25"–1.49"	—	—	—	—	KSSK-125-1	16"	800 lbs. (363 kg)	.25 lbs.

*For equivalent cable diameters in fractional inches and in metric dimensions (mm), see Dimensions Conversion Reference Table 3.



▲WARNING: Do NOT exceed maximum safe load as listed on the label attached to the product.

▲WARNING: Do NOT use on live circuits.

▲WARNING: Always match proper size and type of grip to application.

▲WARNING: Always inspect equipment before use.