

Applications

For municipal and industrial water supply in water works, pressure boosting installations, irrigation and sprinkler plants; as boiler feed pumps and condensate pumps, cooling water and hot water circulation pumps; for high pressure water in hydraulic presses, as fire pumps etc.

Construction

Horizontal high pressure centrifugal pumps in ring sectional design, single- or multistage, vertically split suction, discharge and stage casings. The individual casing parts are sealed by O-rings and are clamped together by external tie bolts.

The pump feet are cast integrally with the suction and discharge casings, and are arranged beneath the pump.

Bearings

The bearings are enclosed in two bearing housings, flanged onto each end of the pump. On the suction end of all pump sizes a cylindrical roller bearing with spacer sleeve is fitted; on the discharge side of sizes 32 and 40 a deep groove ball bearing, sizes 50 and up an angular ball bearing is fitted.

The rotating assembly is hydraulically balanced by means of back vanes or balance holes at the rear of the impeller; the residual axial thrust being absorbed by a ball bearing at the discharge side.

Shaft Seal

The shaft is fitted with renewable protective sleeves in the region of the stuffing box.

Uncooled soft-packed stuffing boxes are used for temperatures up to 110°C (230°F); for temperatures above 110°C (230°F) up to 140°C (285°F) a cooled soft-packed stuffing box is used, where the temperature on the stuffing box is kept within permissible limits with the aid of the cooling liquid. Furthermore, special stuffing boxes for connection of sealing liquid from an outside source are available.

Uncooled mechanical seal up to 110°C (230°F) maximum.

Nozzle orientation

The suction nozzle is horizontal, right-hand side when viewed from driving end, and the discharge nozzle is top, vertical.

The suction flange is machined according to DIN 2533, NP 16 or BS 4504 table 16/11. The discharge flange is machined according to DIN 2535, NP 40 or BS 4504 table 40/1.

Drive

Direct drive by electric motor through a flexible coupling.

The suction end of the pump is the driving end, direction of rotation is clockwise; the pump can be driven from the discharge side (direction of rotation is counterclockwise), or two shaft stubs can be provided, one at each end.

Materials of Construction

Part No.	Part Designation	Material Combinations							
		(01)	(02)	(03)	(04)	(05)	(06)	(08)	(22)
106/107	Suction-/Discharge casing	GG-25							
230	Impeller	GG-25	GCuSn10	GG-25	GCuSn10	GG-25	GCuSn10	GG-25	GCuSn10
171.1/2	Diffuser	GG-25							
210	Shaft	O80M40Q				431S29			
524.1/2	Shaft protection sleeve	GGZ-20	GCuSn10	316S16	GGZ-20	GCuSn10	316S16	GGZ-20	GCuSn10
502	Casing wear ring	GG							
	Seal	Packed gland		Mechanical	Packed gland		Mechanical	Packed gland	

Direction of Rotation

Clockwise seen from the drive end.

Delivery Heads/Pressures

	32 - 65	80 - 150
Max. delivery head at shut-off	300 m	300 m
Max. suction pressure	10 bar	10 bar
Max. total discharge pressure at shut-off	30 bar	28 bar
Test Pressure		
Suction casing	16 bar	16 bar
Discharge/stage casing	45	37.5

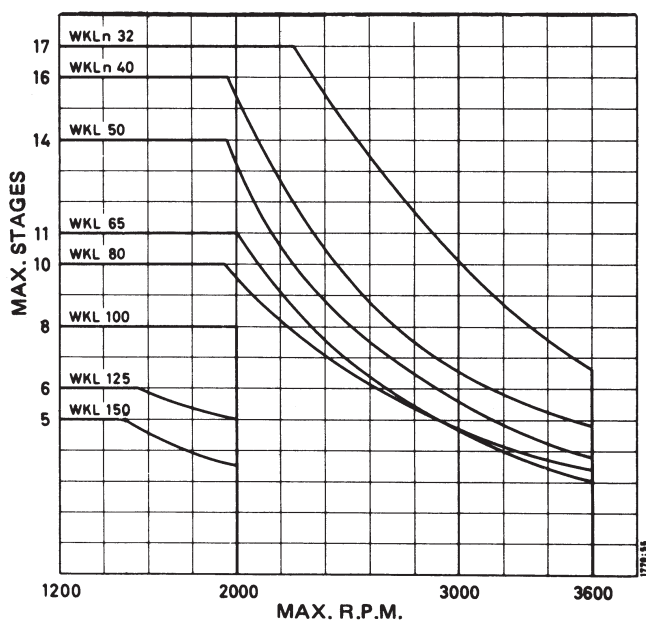

Layout

Selection of pump size and design according to:

Capacity	Q	m ³ /h
Total head	H	m
NPSH	H _H	m
Medium handled		
Temperature	t	°C
Density	kp/dm ³	
Viscosity	mm ² /s	

Handled medium, temperature and pump discharge pressure are decisive for selection of material.

A preselection can be made by using the selection charts.

Precise determination can only be obtained from individual performance curves, for:

Head, Quantity, Efficiency, Power and NPSH req.

Safety Margin Power

up to	1,5 kW	20% approx.
up	15,0 kW	15% approx.
above	15,0 kW	10% approx. reserve power margin.

The mode of operation and the upper limit in conjunction with it will be decisive factors in the selection of an appropriate driver.

The values of the performance curves refer in principle to liquids with a density of 1 kp/dm³ and a viscosity of 1 mm²/s. Liquids with a higher viscosity influence the hydraulics data. Keep within the efficiency factor 0,5.

All single curves are determined with reference to the theoretical speed of 1450 and 2900 r.p.m. Thus conversion to the respective rated speed of the drive is necessary.

NPSH

The NPSH req values specified are certified values for all project calculations and on no account may lower values be adopted. The 10% safety margin included in these specified values, with a minimum of 0,5 metre (1.65 feet) is designed to cover tolerances of measurement and make allowances for manufacturing scatter (NPSH cannot be measured with the same degree of precision as for instance the total head H). NPSH available must be greater than NPSH req with the exception of self-regulating condensate pumps.

Explanations of the Impeller Diameter:

Open dimension = impeller is turned off; i.e. 185Ø

Dimensions in brackets = impeller is turned out;

i.e. 185Ø (180Ø).

Open dimension and dimension in brackets = impeller is

turned off and turned out; i.e. 175Ø (170Ø).

Flow

Recommended Range of Selection

Min Flow Q = 0,5 Q opt.

Max Flow Q = 1,4 Q opt.

Minimum Flow

To protect the pump against damage caused when running the pump in adverse operating conditions resulting in "steaming" of the pump contents predetermined minimum flow requirements can be as stated below.

t = -10° to +100°C ≈ 15% of Q opt.

t = 100° to 140°C ≈ 20% of Q opt.

Plant requirements outside the above parameters or applications that require further investigation are to be referred back to KSB.

Piping Plan Layout

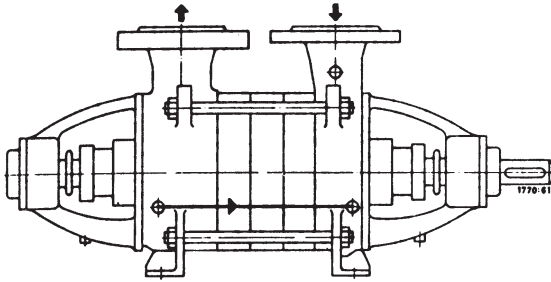

Arrangement 11

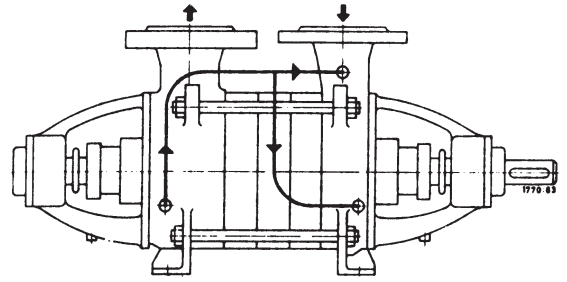

Arrangement 13

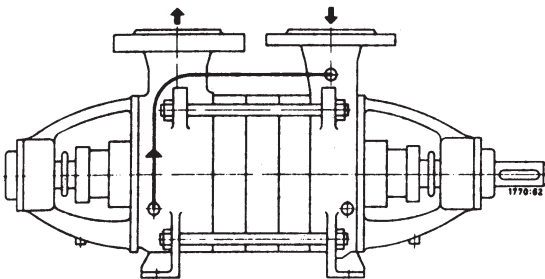

Arrangement 12

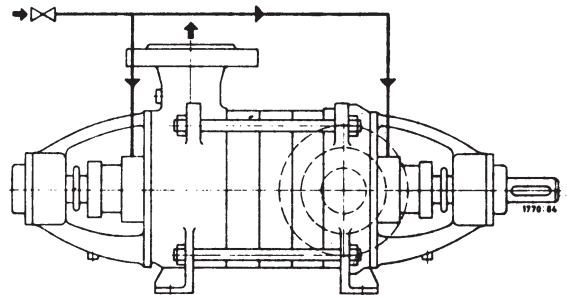

Arrangement 14

VARIATION	DISCHARGE PRESSURE	PUMP SIZE	SEAL FLUSHING DRILLING SUCTION HOUSING TO PUMP INTERNAL	SEAL FLUSHING PIPING	BALANCE LINE PIPING	SEAL FLUSHING AND BALANCE PIPING LINE	SEAL FLUSHING EXTERNAL SUPPLY CONNECTION
NEGATIVE SUCTION OR SUCTION PRESSURE NOT EXCEEDING 1 BAR	≤ 15 Bar	Size 32 to 65	-	arrgt. 11	-	-	X
		80 from 2 stages n ≤ 2100 R/min	plugged	arrgt. 11	-	-	
		80/1 stages, n ≤ 2100 R/min	open	-	-	-	
		80 n > 2100 R/min					
	> 15 Bar	100 to 150	plugged	arrgt. 11	-	-	
		Stages 80 to 150: stage 1 with blank stages	-	arrgt. 11	-	-	
SUCTION PRESSURE EXCEEDING 1 BAR	≤ 15 Bar	32 to 65	-	-	-	-	
		80 to 150	open	-	-	-	
	> 15 Bar	32 and 40	-	-	-	-	
		50 and 65	-	-	arrgt. 12	-	
		80 to 150	open	-	arrgt. 11	arrgt. 11	
			-	-	-	-	
CONDENSATE VACUUM OPERATION	≤ 15 Bar	32 to 65	-	-	-	-	
		80 to 150	plugged	-	-	-	
	> 15 Bar	32 and 40	-	-	-	-	
		50 and 80	plugged (only size 80)	-	-	-	
		100 to 150	plugged	-	arrgt. 12	-	suction and disch. arrgt. 14

Dimension Table

High Pressure Centrifugal Pumps
WKLn 32 to 150
with uncooled stuffing box

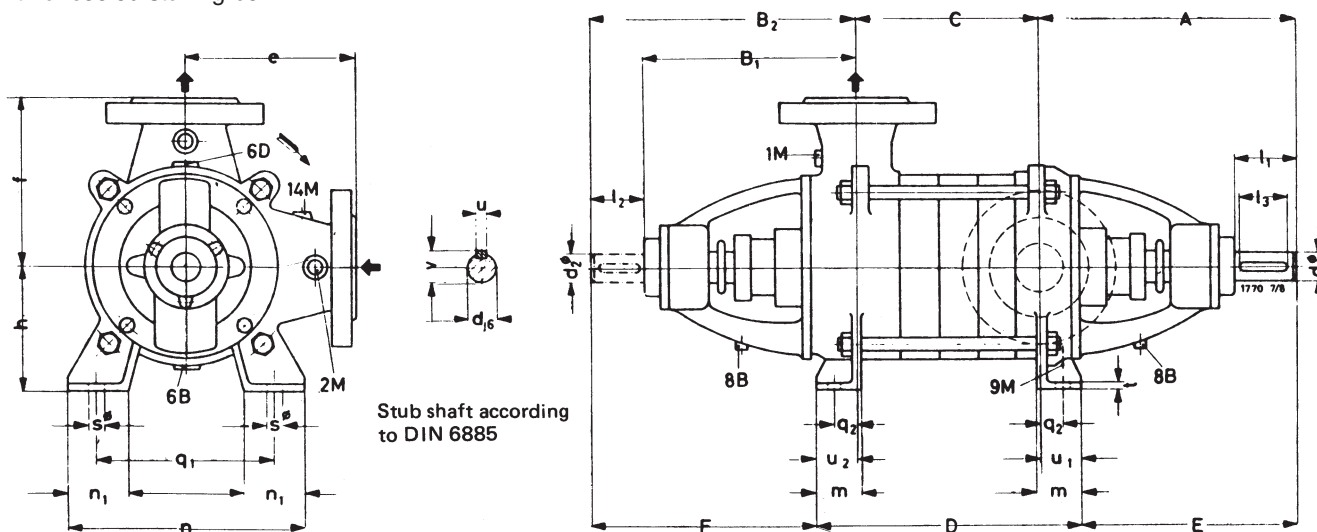

Pump Size	Pump dimensions																				Stub shaft						
	Nominal Bore Suction	Nominal Bore Dis-charge	A	B ₁	B ₂)	D	E	F	e	f	h	m	n	n ₁	q ₁	q ₂	s∅	t	u ₁	u ₂	d ₁ ∅	d ₂ ∅	l ₁	l ₂)	l ₃	v	u
32	40	32	250	183	252	C + 120	190	192	160	160	132	60	256	60	205	35	14	12	60	60	30	25	65	63	45	32,9	8
40	50	40	250	183	252	C + 120	190	192	180	180	132	60	280	60	240	35	14	12	60	60	30	25	65	63	45	32,9	8
50	65	50	285	220	295	C + 92	239	249	180	180	135	50	280	60	230	30	15	12	46	46	35	28	60	60	50	38,3	10
65	80	65	290	220	295	C + 102	239	244	200	200	155	55	300	70	250	35	15	14	51	51	35	28	60	60	50	38,3	10
80	100	80	320	250	335	C + 120	260	275	265	265	210	60	370	70	310	40	14	14	60	60	40	35	85	85	75	43,1	12
100	125	100	360	275	380	C + 140	290	310	300	300	250	75	440	80	370	45	14	14	70	70	45	40	95	95	80	48,5	14
125	150	125	420	300	440	C + 170	335	355	375	375	300	85	550	95	460	51	18	18	85	85	50	45	125	125	90	53,3	14
150	200	150	485	355	500	C + 200	385	400	425	425	350	100	650	100	550	65	23	18	100	100	60	48	140	140	90	64,2	18

Pump Size	Pump dimension C at a number of stages																
	1	2	3	4	5	6	7	8	9	10	11	12	13	14	15	16	17
32	82	130	178	226	274	322	370	418	466	514	562	610	658	706	754	802	850
40	82	130	178	226	274	322	370	418	466	514	562	610	658	706	754	802	
50	73	128	183	238	293	348	403	458	513	568	623	678	733	788			
65	87	147	207	267	327	387	447	507	567	627	687						
80	110	193	276	359	442	525	608	691	774	857	940	1023	1106				
100	135	235	335	435	535	635	735	835	935								
125	165	280	395	510	625	740											
150	215	360	505	650	795												

) For pumps which can be driven from both ends

Connection sizes

	Pump Size	32	40	50	65	80	100	125	150
1 M	Pressure gauge	R 1/2"	R 1/2"	R 1/2"	R 1/2"	R 1/2"	R 1/2"	R 1/2"	R 1/2"
2 M	Vacuum gauge	R 1/2"	R 1/2"	R 1/2"	R 1/2"	R 1/2"	R 1/2"	R 1/2"	R 1/2"
6 D	Priming and venting	R 3/8"	R 3/8"	R 3/8"	R 3/8"	R 1/2"	R 1/2"	R 1/2"	R 1/2"
6 B	Drain	R 3/8"	R 3/8"	R 3/8"	R 3/8"	R 1/2"	R 1/2"	R 1/2"	R 1/2"
8 B	Leakage drain	R 1/2"	R 1/2"	R 1/2"	R 1/2"	R 1/2"	R 1/2"	R 1/2"	R 1/2"
9 M	Connection of sealing liquid	R 1/8"	R 1/8"	R 1/8"	R 1/8"	R 3/8"	R 3/8"	R 3/8"	R 3/8"
14 M	Connection of balance liquid	R 1/8"	R 1/8"	R 1/8"	R 1/8"	R 3/8"	R 3/8"	R 3/8"	R 3/8"

R = B.S.P.
All Dimensions are in millimeters

WKLn 32 up to 65

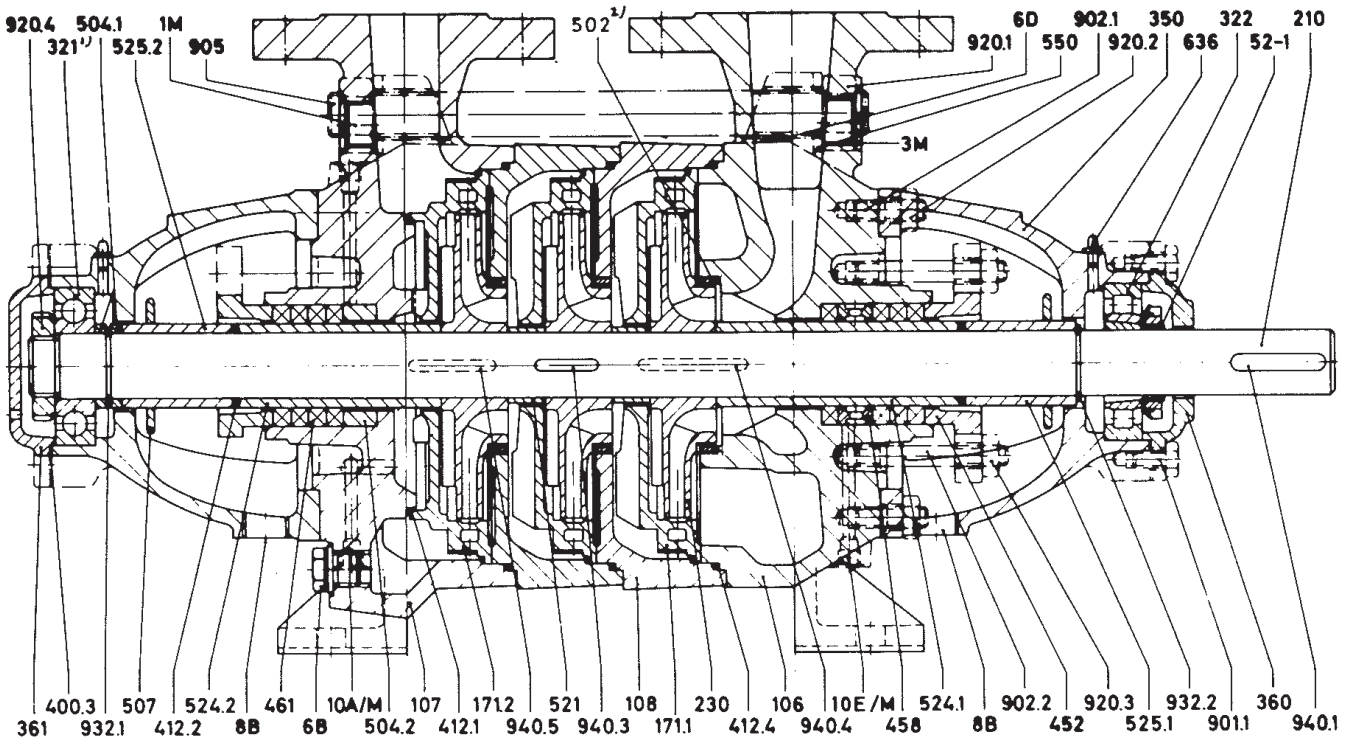
 Construction with uncooled soft-packed stuffing box (N) $t \leq 110^\circ\text{C}$ (230°F)

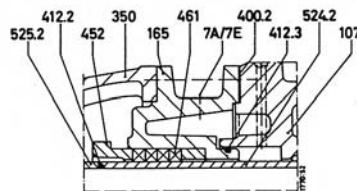
Cross section of stuffing box

 Cooled soft-packed stuffing box (HW),
 $t > 110^\circ\text{C}$ up to 140°C
 (230 up to 285° F)

Part No.	Designation	Part No.	Designation	Part No.	Designation
106	Suction casing	461	Stuffing box packing	902.1/2	Stud
107	Discharge casing	478 ³⁾	Spring-right hand (Suction side)	905	Tiebolt
108	Stage casing	479	Spring-left hand (Discharge side)	920.1/2/3	Hexagonal nut
165	Cooling cover	502 ²⁾	Casing wear ring	920.4	Grooved nut
171.1	Diffuser	504.1/2	Spacer ring	932.1/2	Circlip
171.2	Diffuser, last stage	507	Thrower	932.1/3/4	Key
210	Shaft	521	Stage sleeve	940.5/6	Key
230	Impeller	52-1	Clamping sleeve	1M	Pressure gauge
321 ³⁾	Deep groove ball bearing	523.1 ¹⁾	Shaft sleeve (Suction side)	3M	Pressure vacuum gauge
322	Cylindrical roller bearing	524.1	Shaft protecting sleeve (Suction side)	6B	Drain
350	Bearing housing	524.2	Shaft protecting sleeve (Discharge side)	6D	Priming and venting
360	Bearing cover	525.1	Spacer sleeve (Suction side)	7A	Cooling liquid outlet
361	Bearing end cover	525.2	Spacer sleeve (Discharge side)	7E	Cooling liquid inlet
400.2/3	Flat gasket	550	Disc	8B	Leakage drain
412.1/3	O-ring	636	Grease nipple	10A	Sealing liquid outlet
412.4	O-ring	901.1	Hexagonal head bolt	10E	Sealing liquid inlet
452	Stuffing box gland			10M	Connection for sealing liquid from an outside source
458	Lantern ring				

1) not shown in drawing

2) fitted from size 50 up

3) size 50 and 65 fitted with 320 Angular Contact Bearing

WKLn 80 up to 150

Construction with uncooled soft-packed stuffing box (N) $t \leq 110^\circ\text{C}$ (230°F)

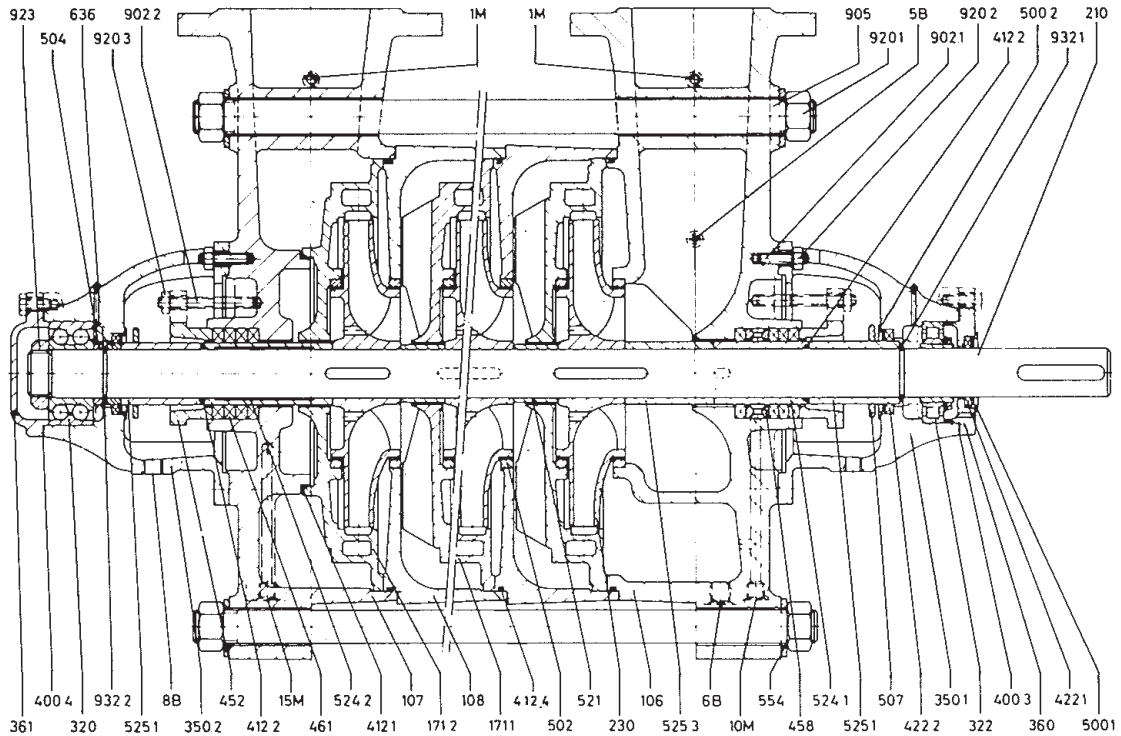

Cross section of stuffing box

Cooled soft-packed stuffing box (HW),
 $t > 110^\circ\text{C}$ up to 140°C
 (230 up to 285°F)

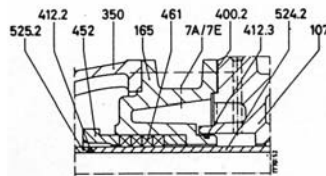

Part No.	Designation	Part No.	Designation	Part No.	Designation
106	Suction casing	502	Casing wear ring (WKLn 50 to 150)	901.1	Hexagonal head bolt
107	Discharge casing	504	Spacer ring	902.1/2/3 ⁴⁾	Stud
108	Stagecasing	507	Thrower	905	Tiebolt
165	Cooling cover	521	Stage sleeve	920.1/2/3	Hexagonal nut
171.1	Diffuser	52-1	Clamping sleeve	920.4	Grooved nut (Nut with two flats WKLn 80 up to 150)
171.2	Diffuser, last stage	523.1 ¹⁾	Shaft sleeve (Suction side)	932.1/2	Circlip
210	Shaft	524.1	Shaft protecting sleeve (Suction side)	940.1/3/4	Key
320	Angular contact ball bearing	524.2	Shaft protecting sleeve (Discharge side)	940.5/6	Key (940.5 omitted on WKLn 125 and 150)
230	Impeller	525.1	Spacer sleeve (Suction side)	1M	Pressure gauge
321	Deep groove ball bearing	525.2	Spacer sleeve (Discharge side)	3M	Pressure vacuum gauge
322	Cylindrical roller bearing	525.3	Spacer sleeve (size 150 on stuffing box construction N; Sizes 100 to 150 on stuffing box construction HW)	6B	Drain
350.1/2	Bearing housing	525.4 ¹⁾	Spacer sleeve (sizes 100 and 150 on stuffing box construction HW)	6D	Priming and venting
360	Bearing cover	543	Spacer bush	7A	Cooling liquid outlet
361	Bearing end cover	550	Disc	7E	Cooling liquid inlet
400.2/3	Flat gasket	636	Grease nipple	8B	Leakage drain
412.1/2/3	O-ring			10A	Sealing liquid outlet
412.4	O-ring			10E	Sealing liquid inlet
422.1/2	Felt ring (WKLn 125 and 150)			10M	Connection of sealing liquid from an outside source
452	Stuffing box gland			14A	Balance liquid outlet
458	Lantern ring			14E	Balance liquid inlet
461	Stuffing box packing				
478 ¹⁾	Spring-right hand (Suction side)				
500.1/2	End ring (WKLn125 and 150)				

1) Not shown in drawing

2) Stud 902.3 from WKLn 100 onwards

Selection chart

Performance Characteristics

Selection chart 2900 1/min

Number of stages for uncooled and cooled stuffing box constructions

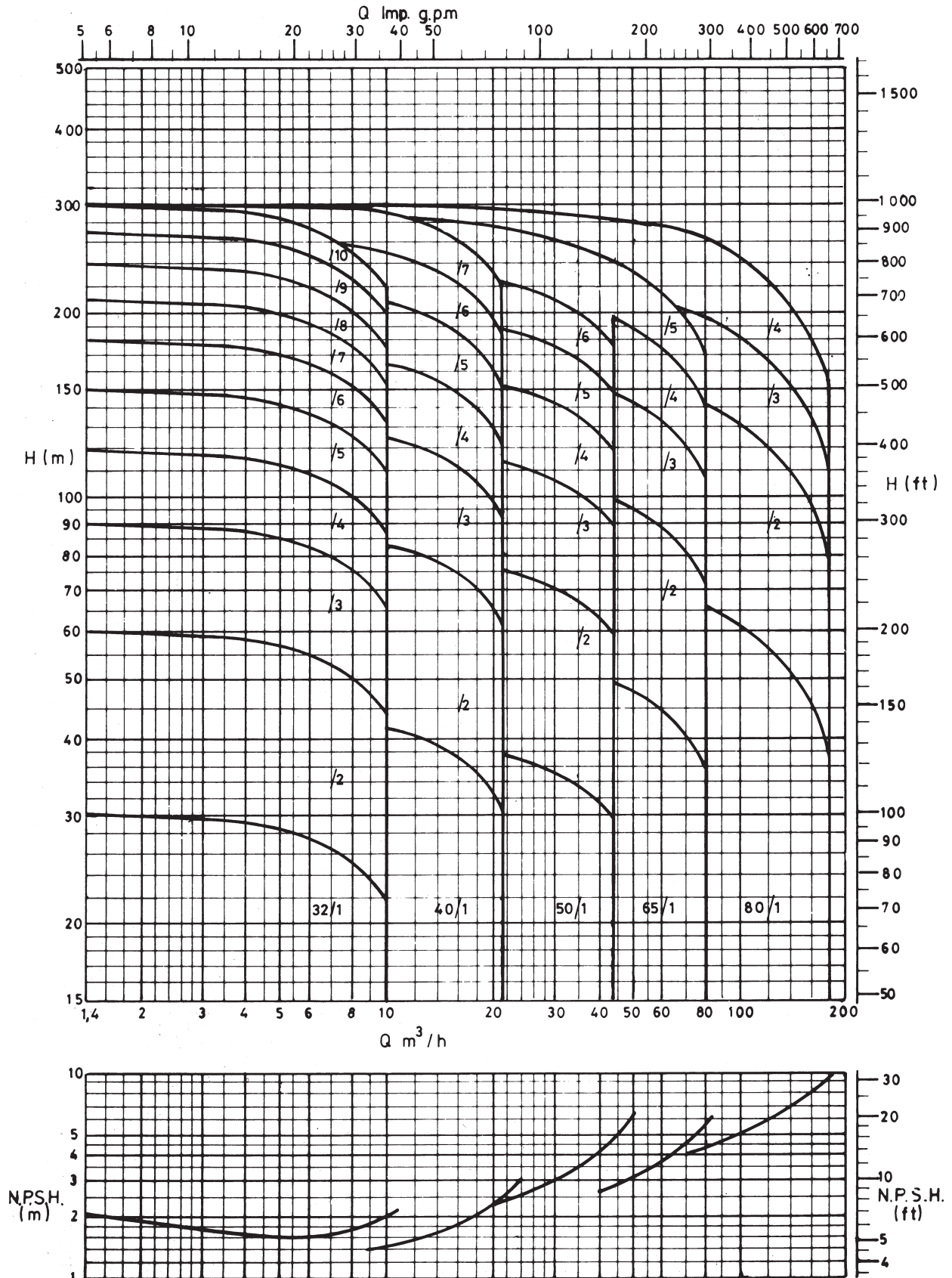

Selection chart

Selection chart 1450 1/min

Number of stages for construction with uncooled stuffing box.

For construction with cooled stuffing box reduction of number of stages for size 32 to 65 = 2, sizes 80 to 150 = 1

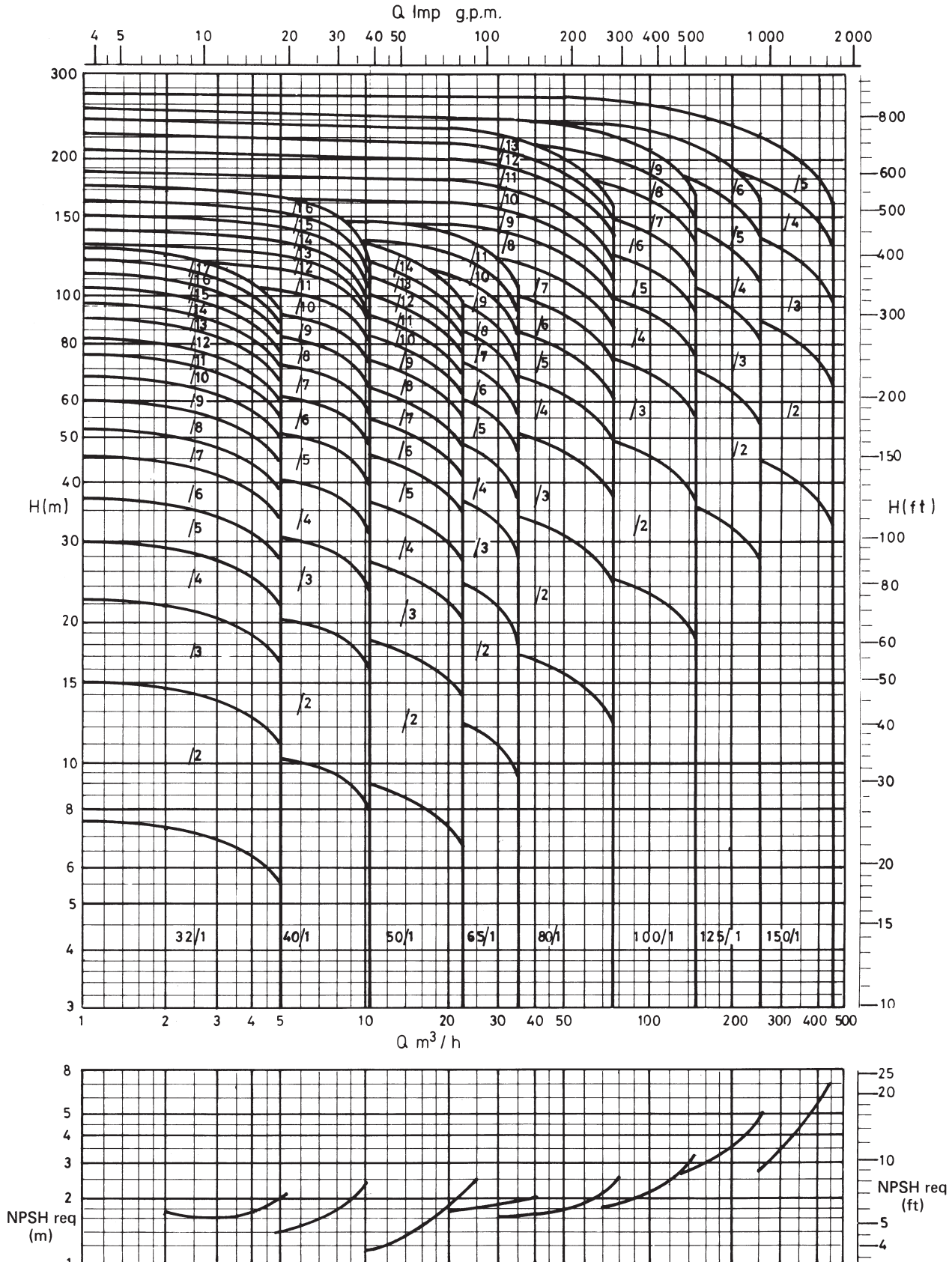

WKLn 32

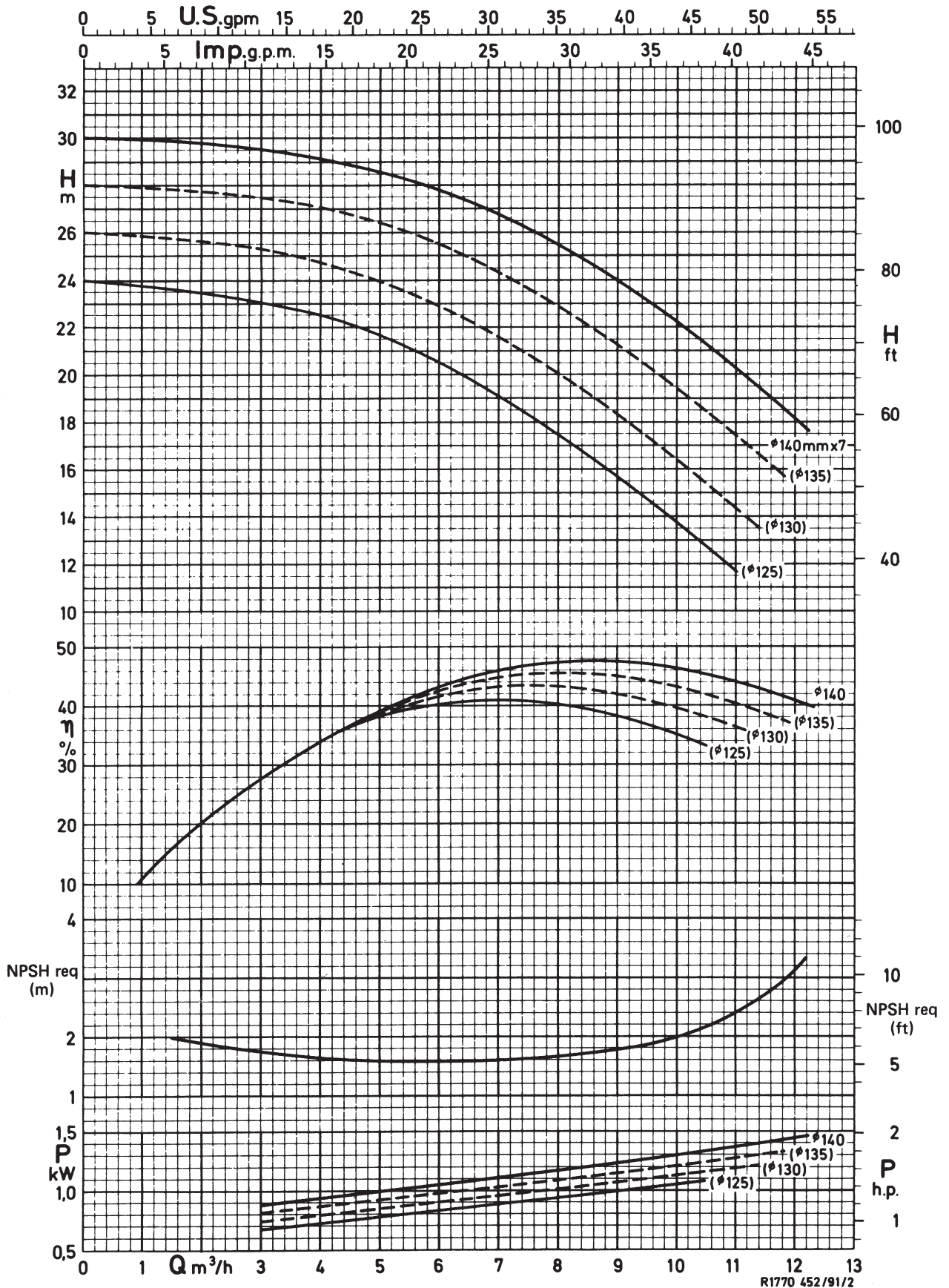

R1770 452/91/2

WKLn 40

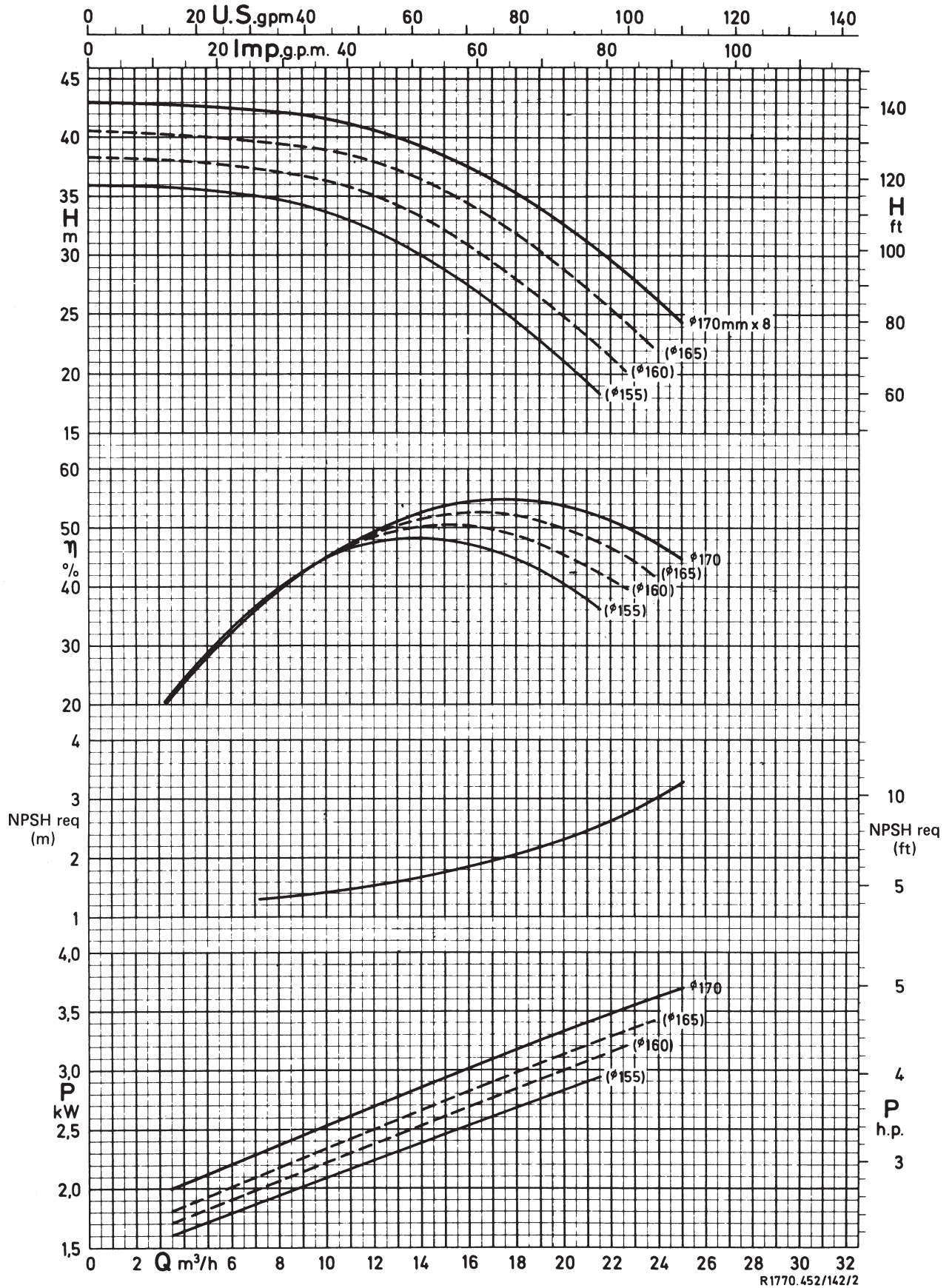

WKLn 50

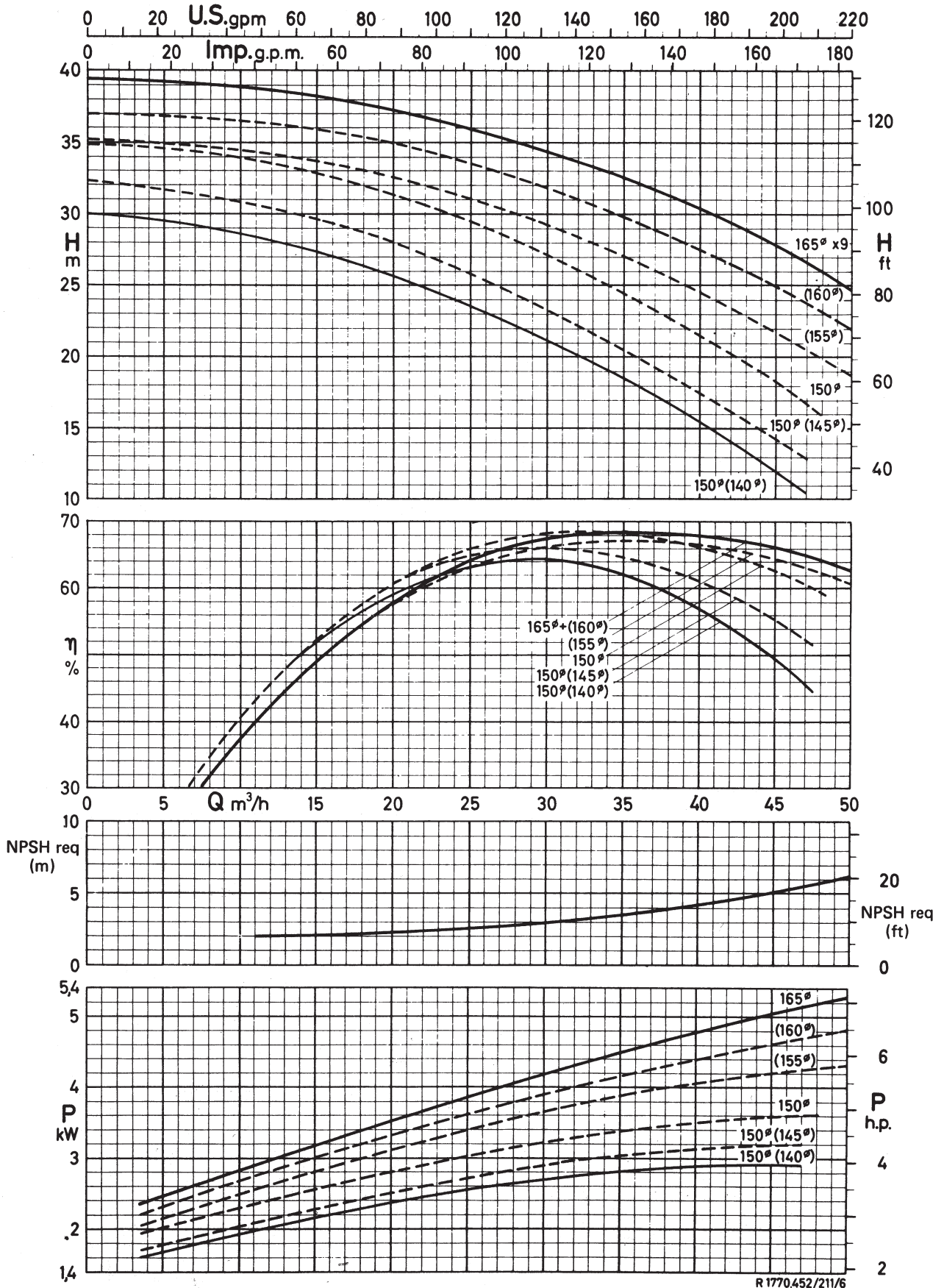

R 1770452/211/6

WKLn 65

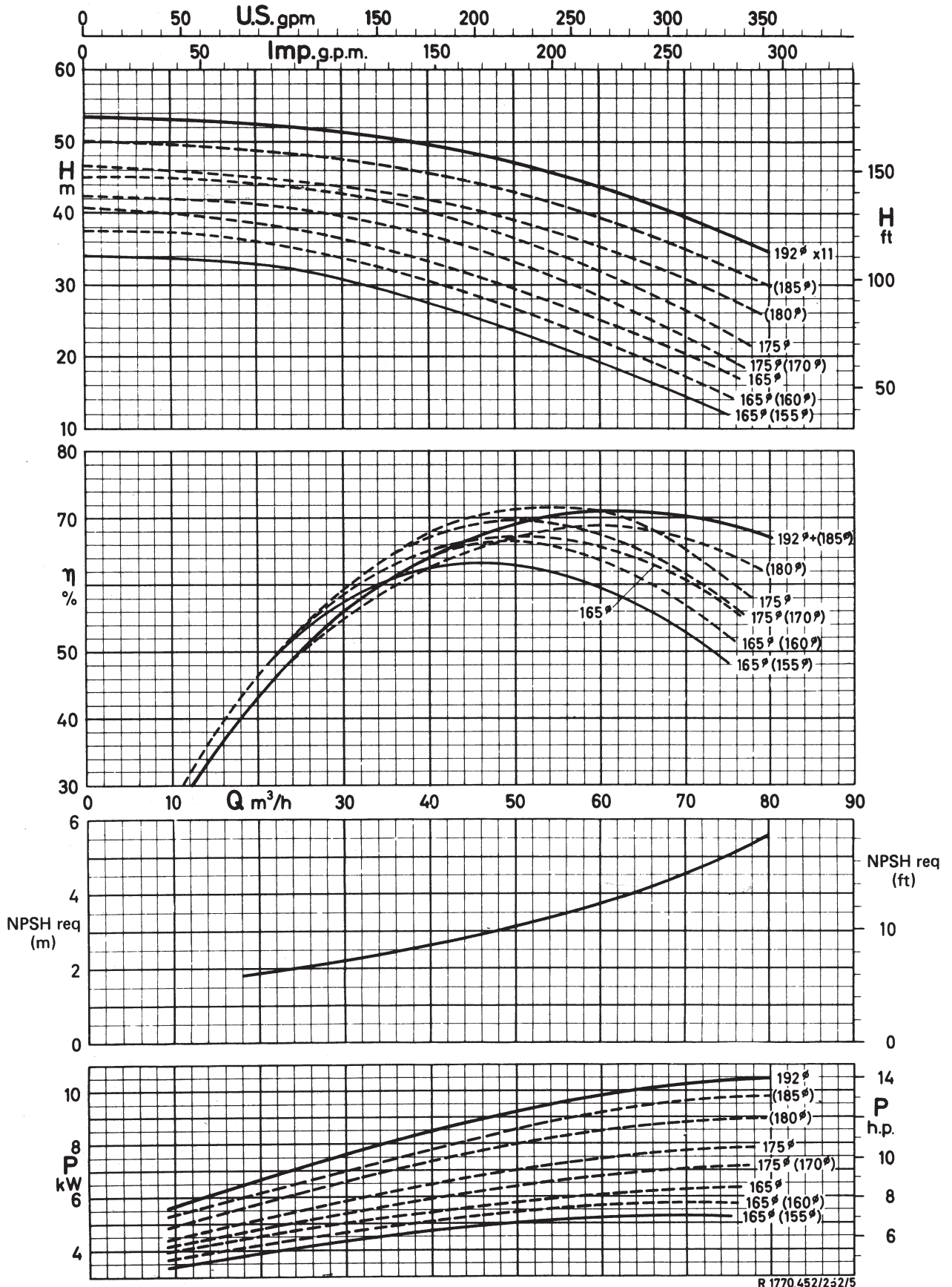

WKLn 80

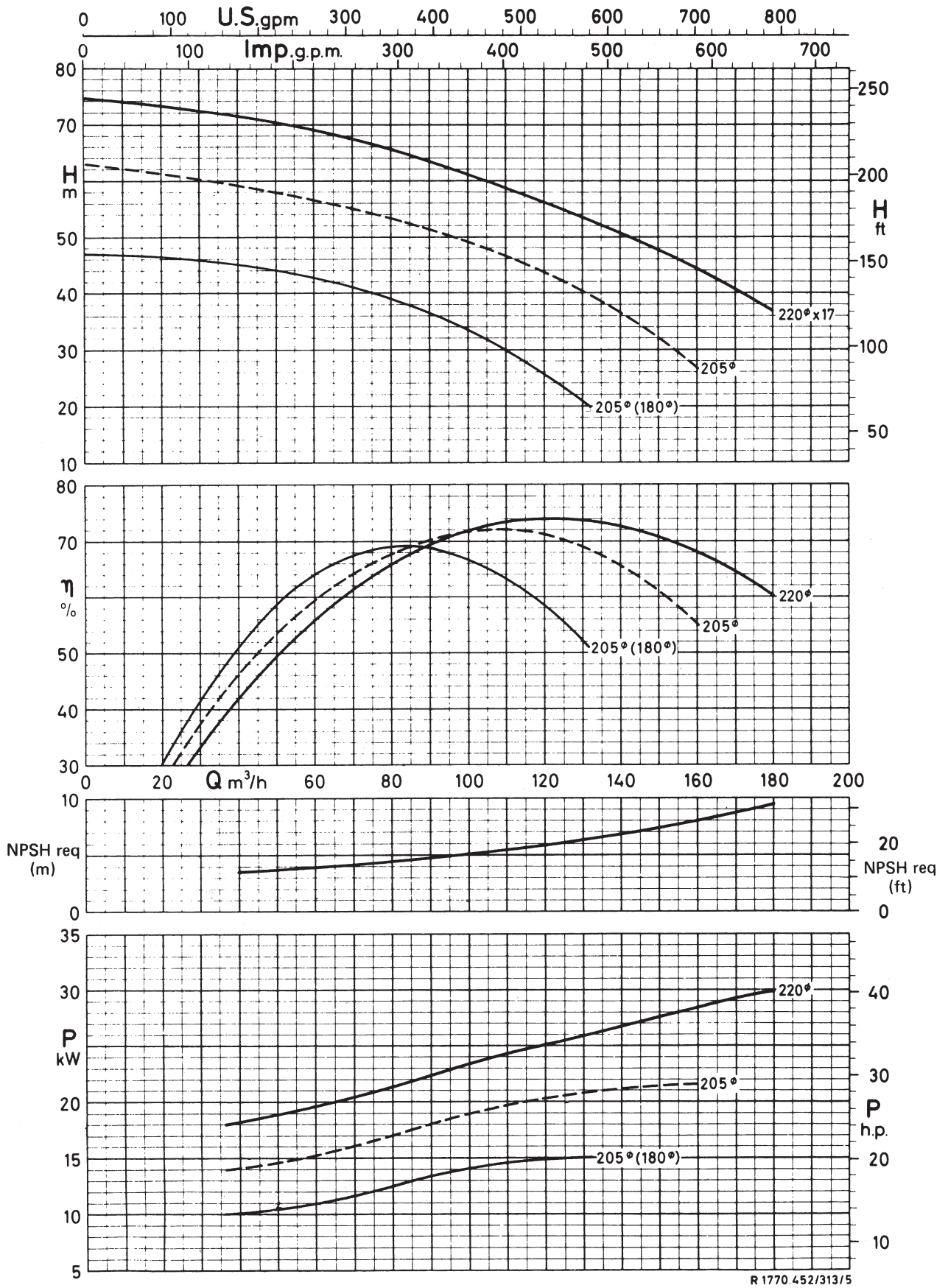

WKLn 32

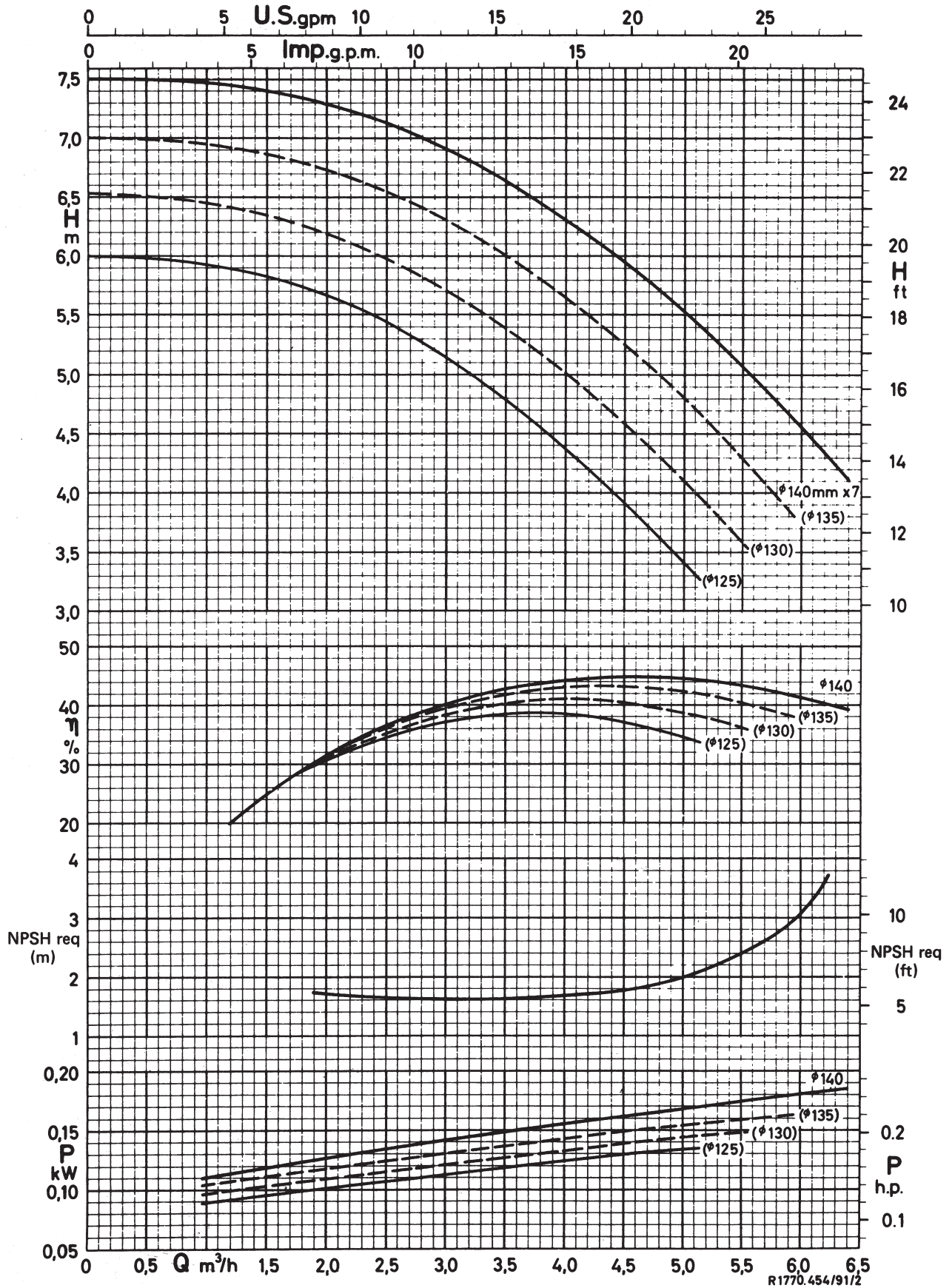

R1770.454/91/2

WKLn 40

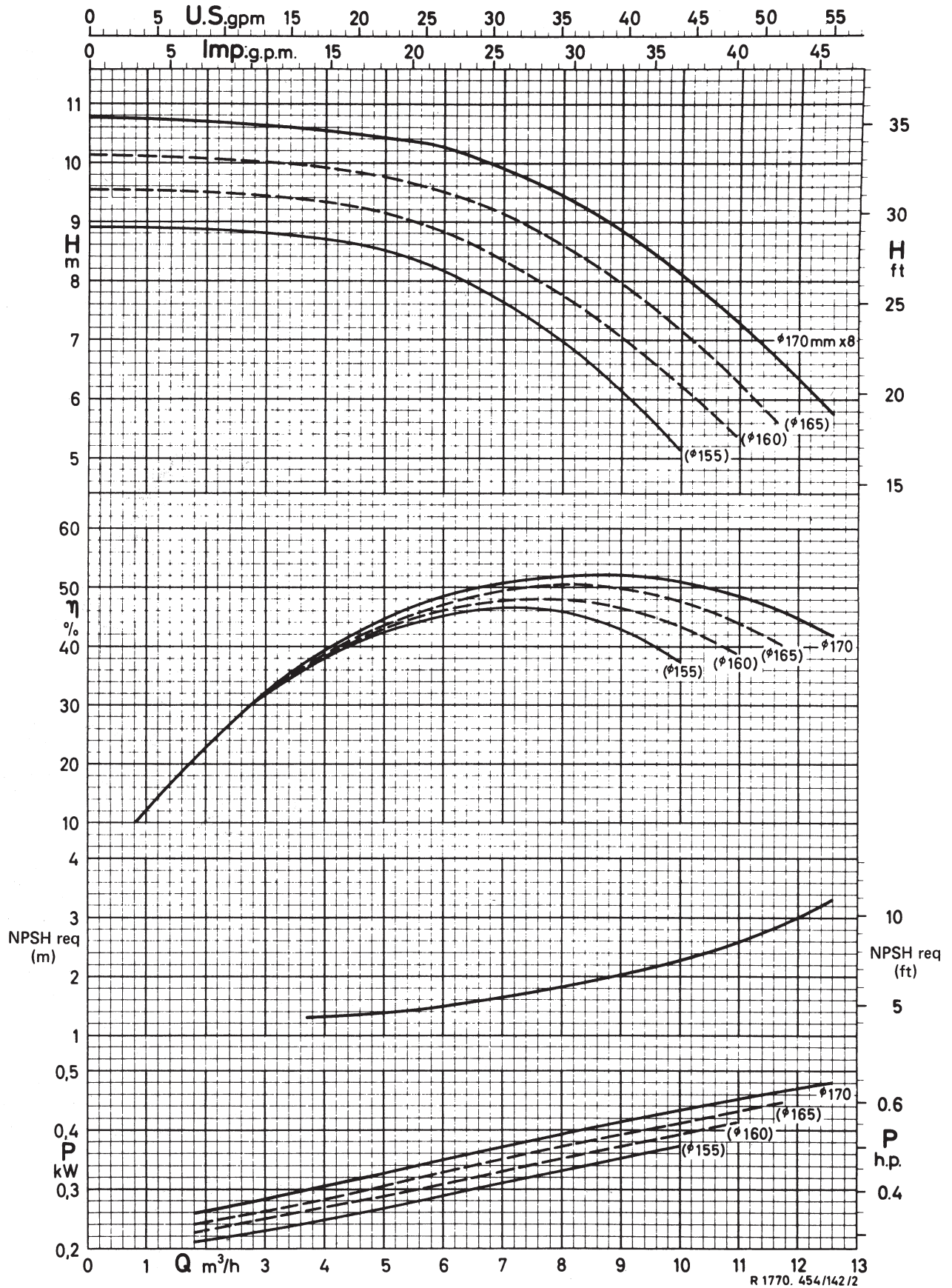

R 1770. 454/142/2

WKLn 50

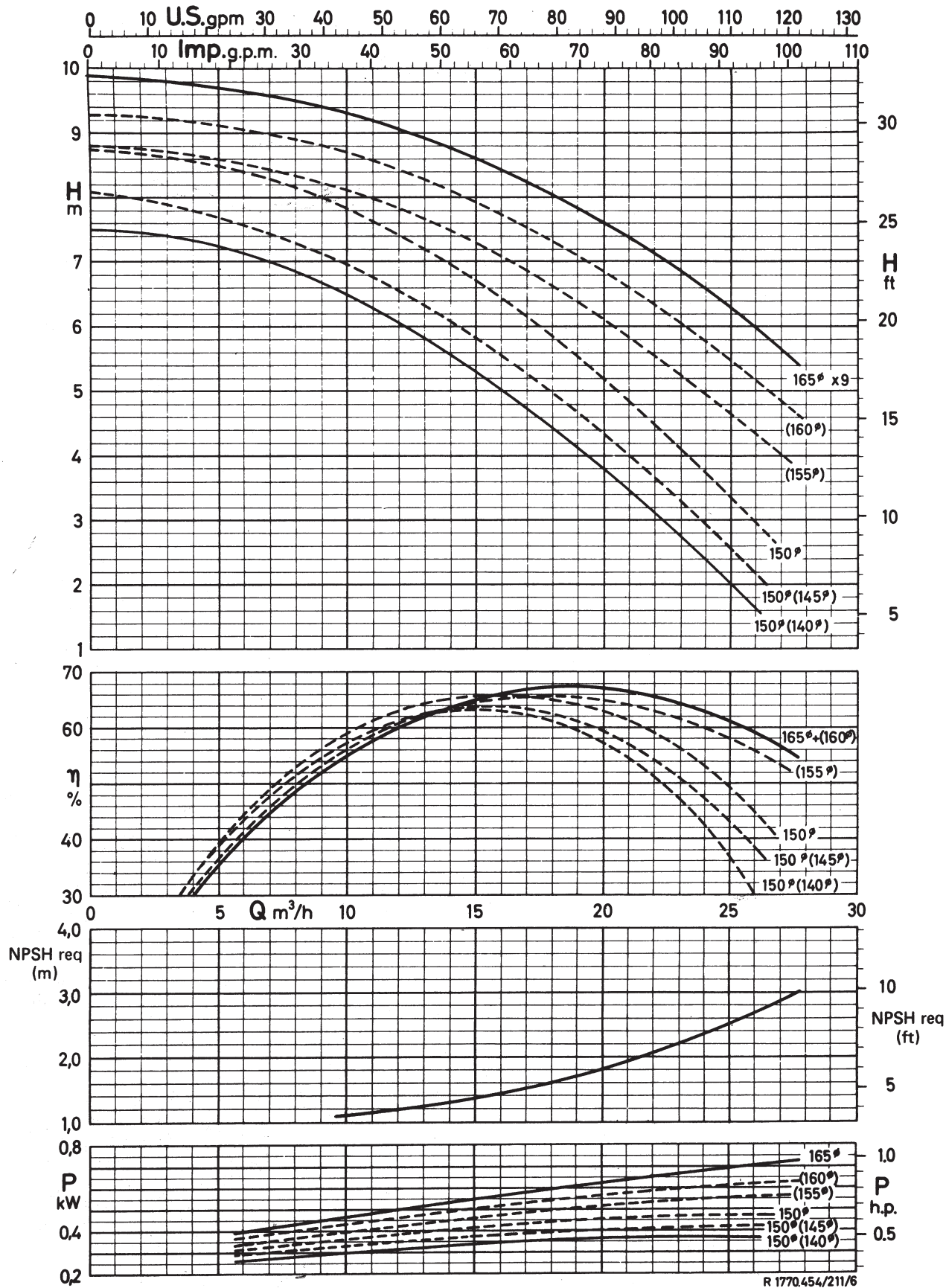

R 1770.454/211/6

WKLn 65

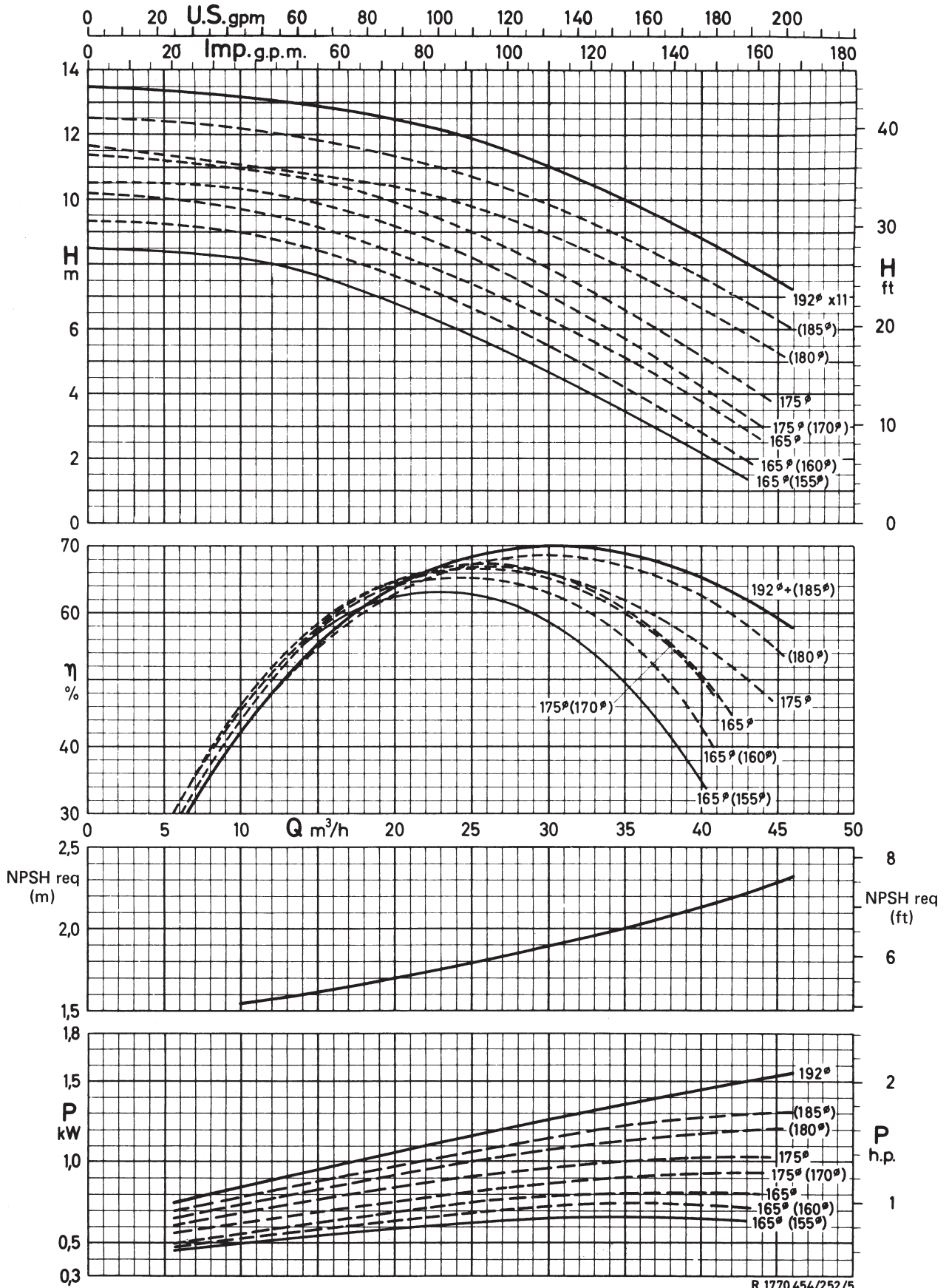

WKLn 80

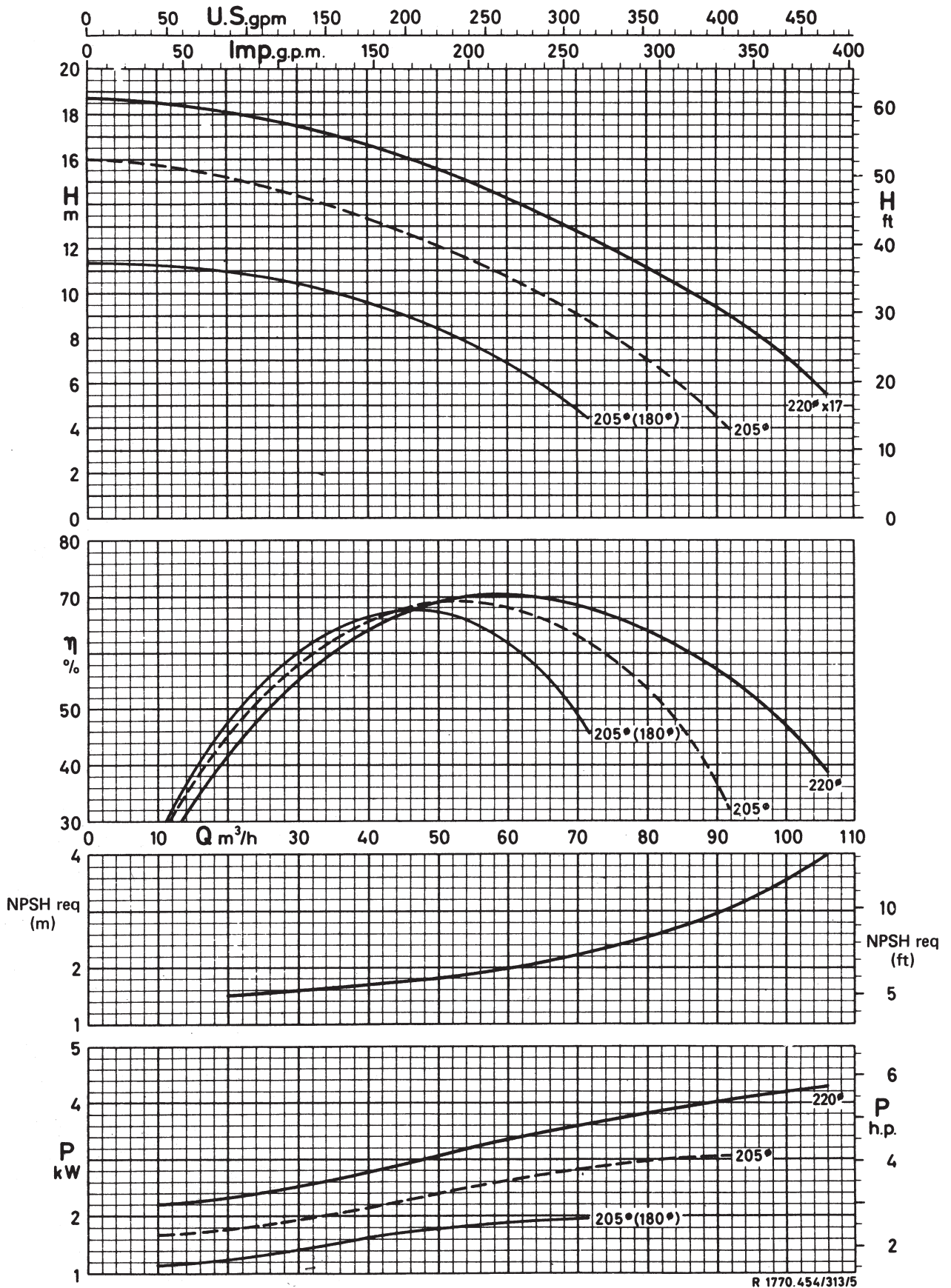

WKLn 100

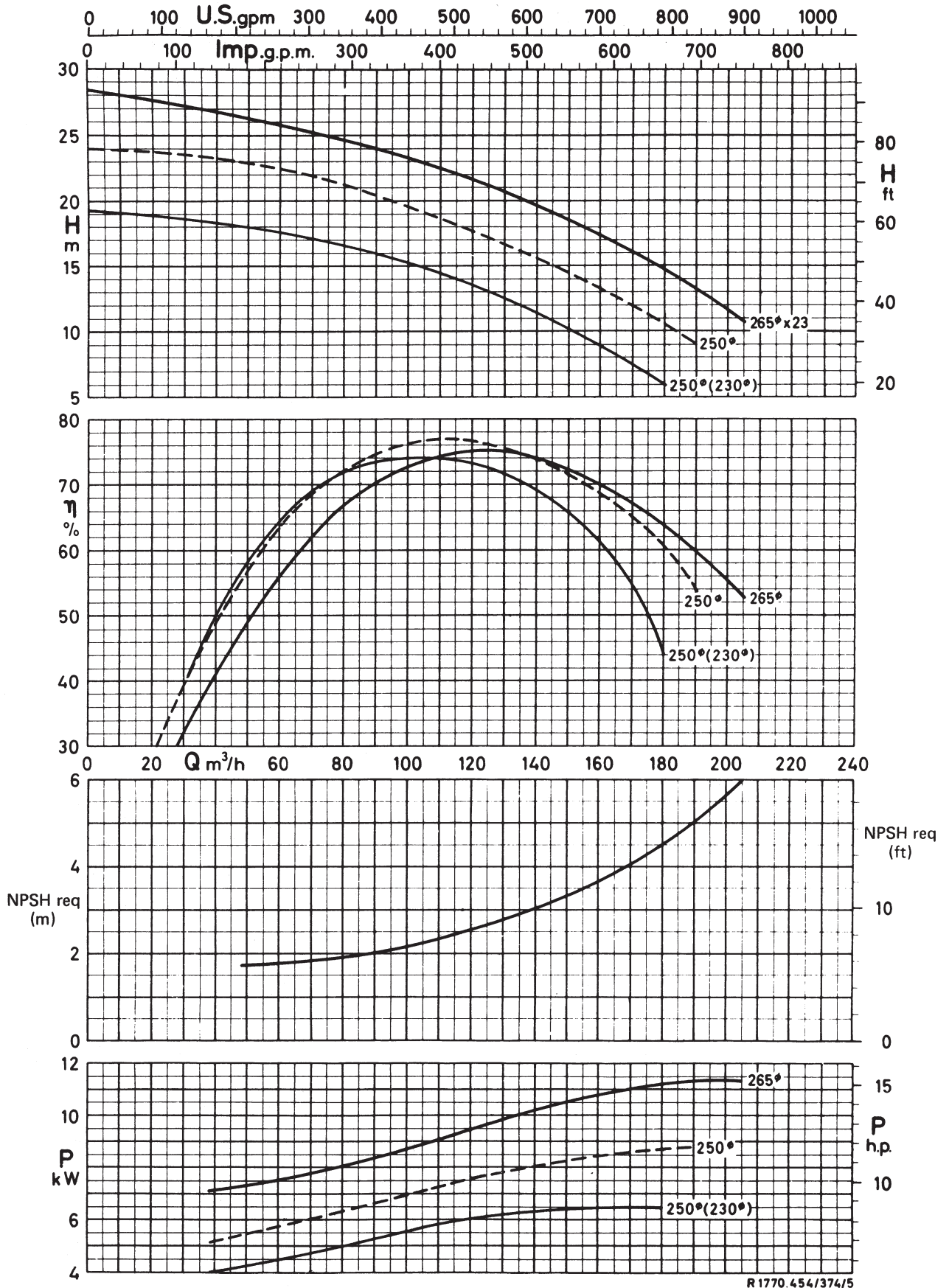

R 1770.454/374/5

WKLn 125

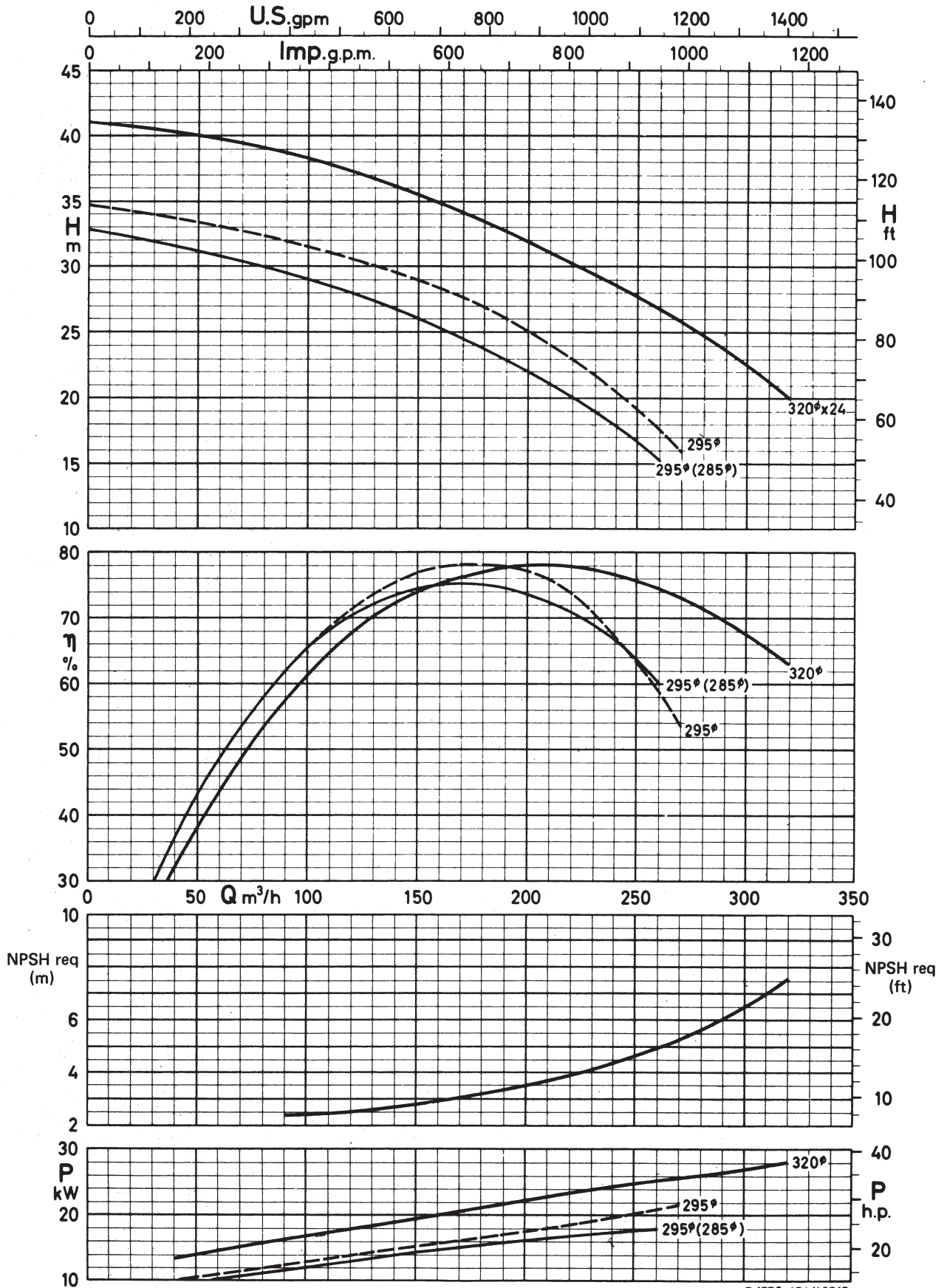

R 1770.454/425/5

WKLn 150

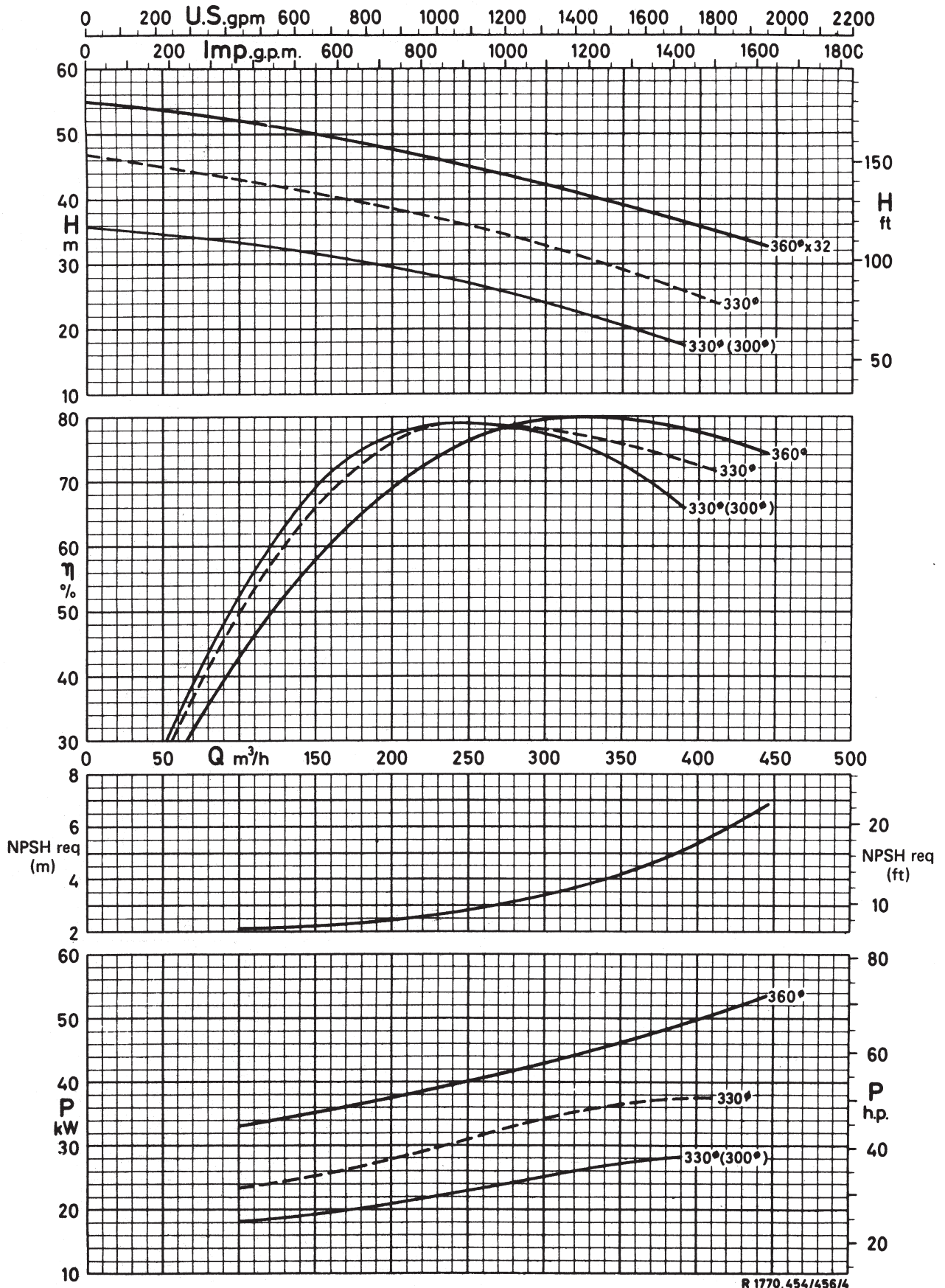

R 1770.454/456/4

