

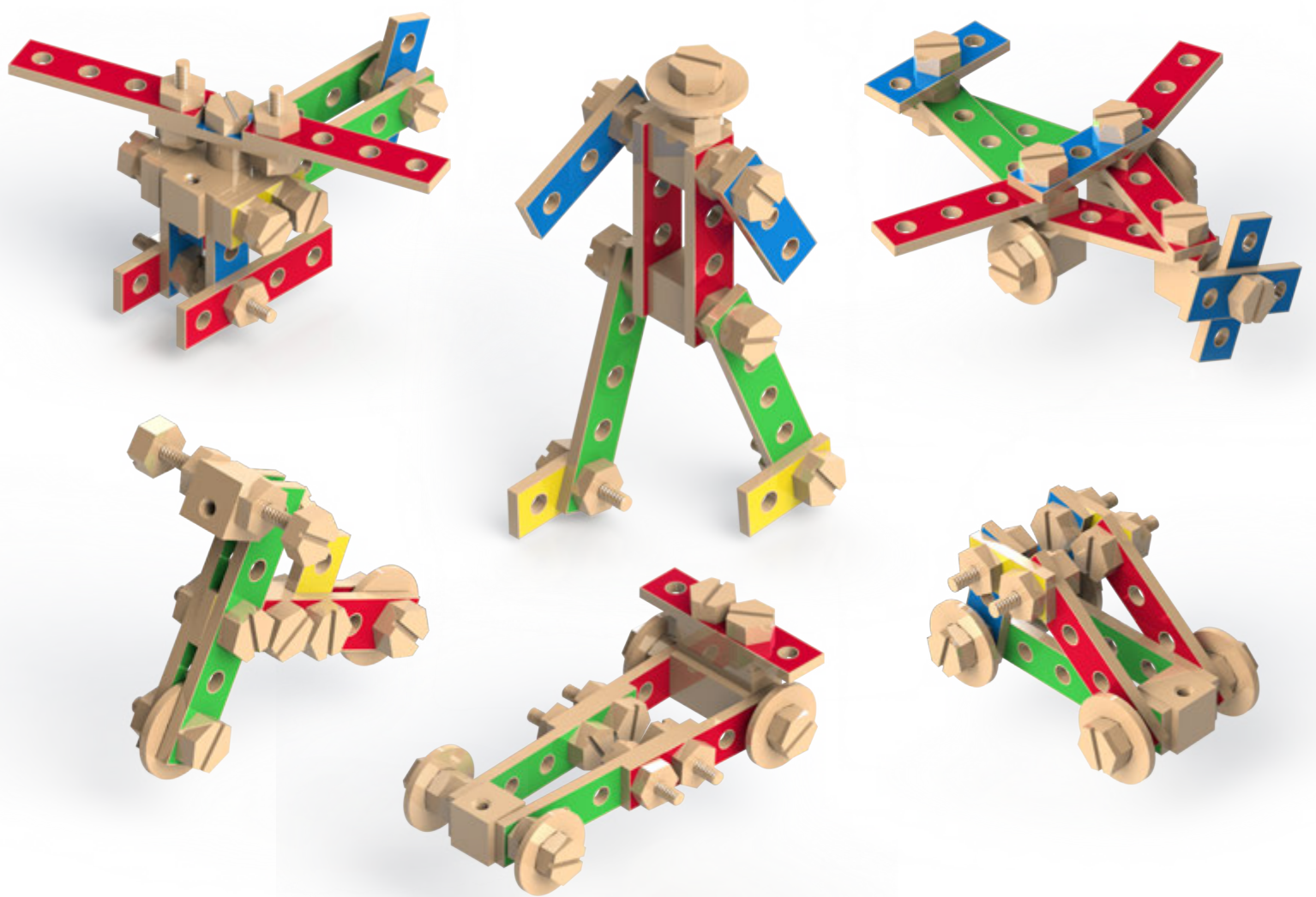

WOODEN PROJECT WORKBENCH

Model Instruction Booklet



Ages 3+

Building Set Includes:

saw



wrench



screwdriver



hammer



12 bolts

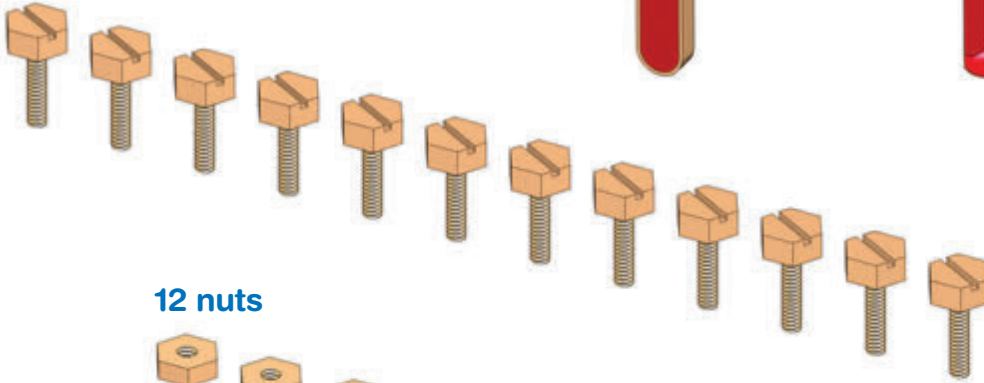

12 nuts

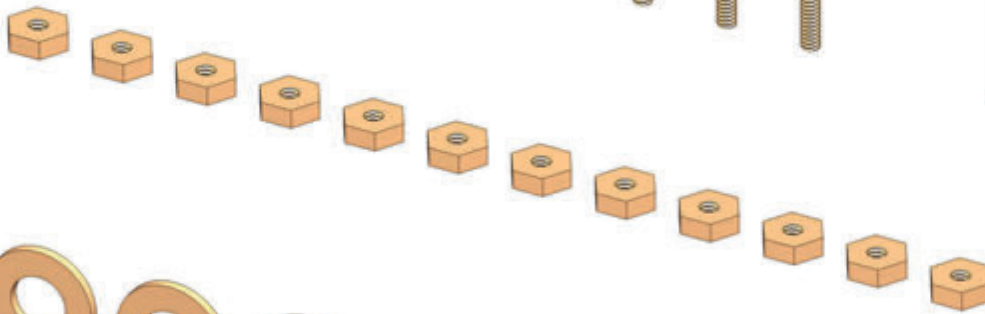

sawing board

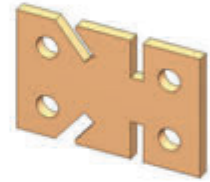

4 wheels



4 hubs



4 connector blocks

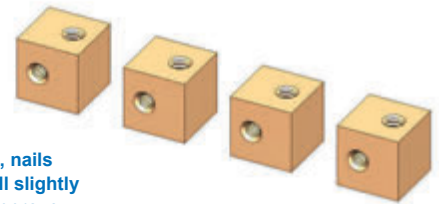

4 nails

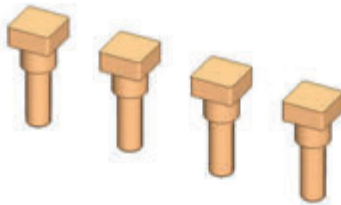

PLEASE NOTE: Due to natural variations in wood, nails may initially be tight in nail holes. Repeated use will slightly expand the holes to make nail removal easier. To improve ease of use, rub nails along the edge of a bar of soap.

4 yellow building strips

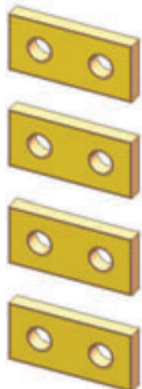

4 blue building strips



4 red building strips

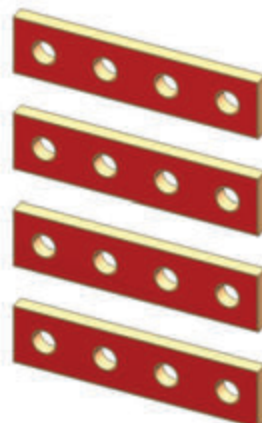

2 green building strips

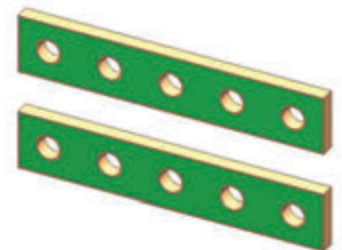

***Pieces are not to scale.**

Construct These Amazing Models!

Make the projects below by following the step-by-step diagrams outlined in this booklet. All of the building pieces, hardware, and hand tools you need are included. Have fun building and playing with these models, or design your own creative projects! Adult assistance may be needed.

Dune Buggy

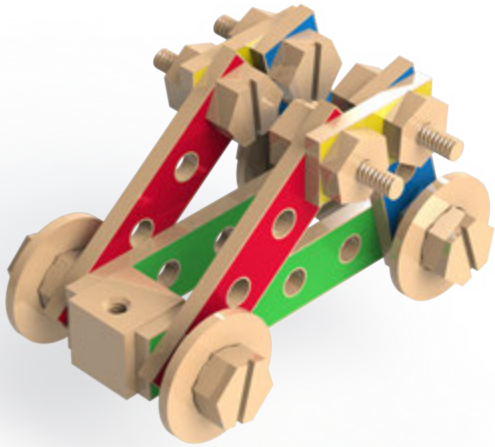

Helicopter



Motorcycle

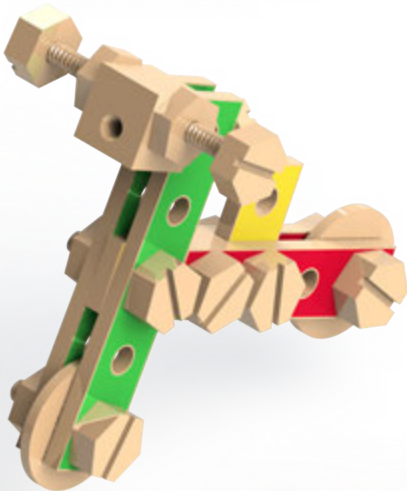

Robot



Race Car

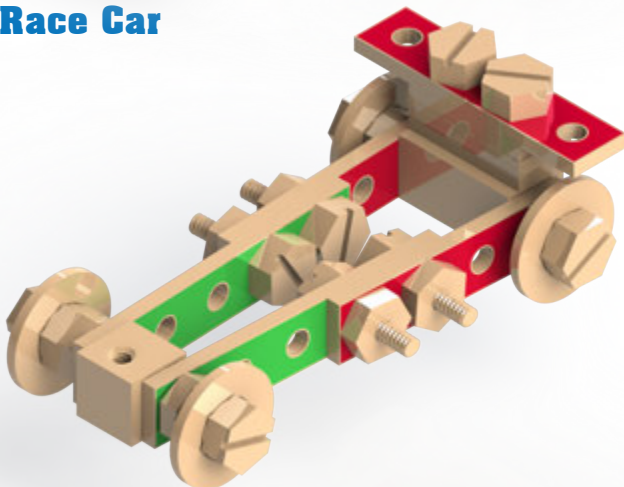

Airplane

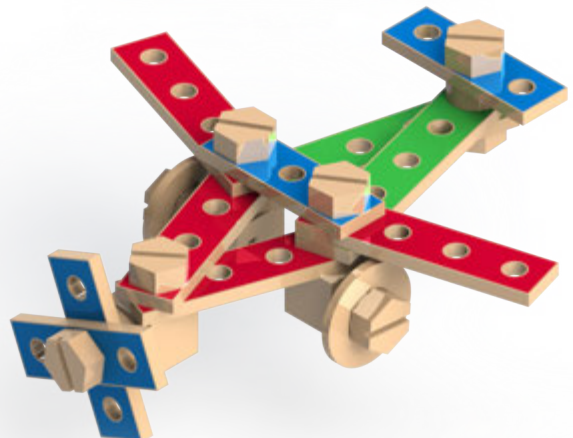

DUNE BUGGY

Parts Needed

2 green building strips



2 red building strips



2 blue building strips



2 yellow building strips



2 connector blocks



8 nuts



8 bolts



4 wheels



4 hubs



Step 1

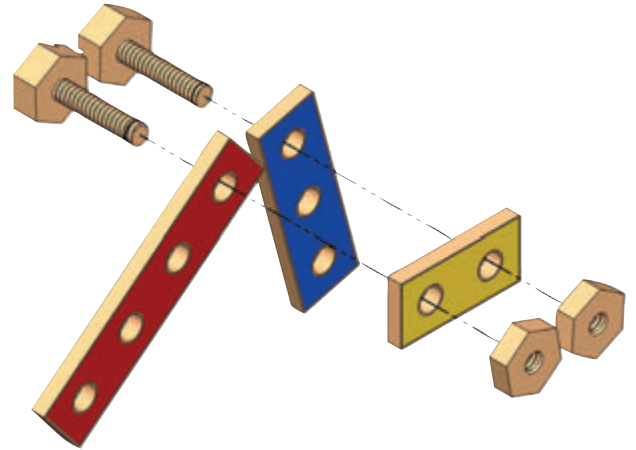

Step 2

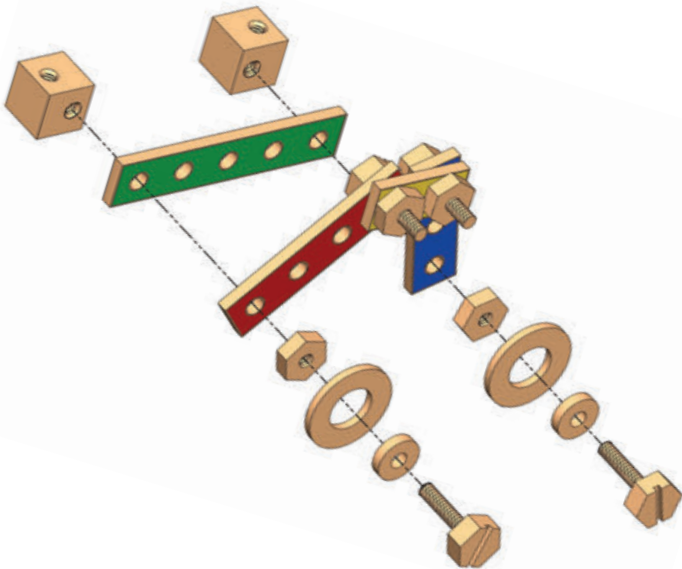

Step 3

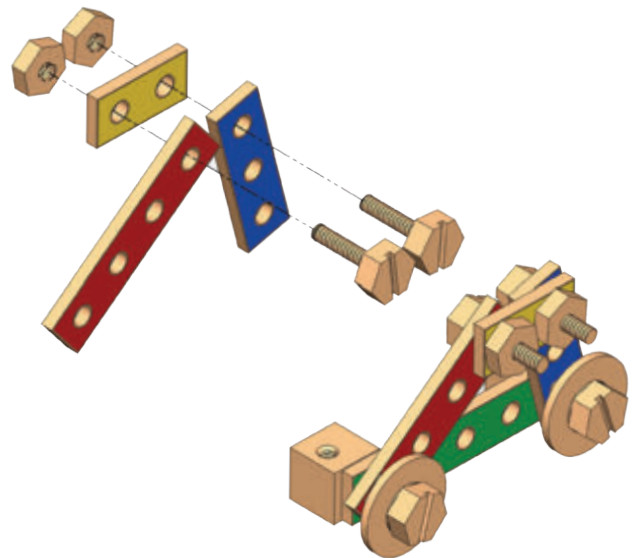

Step 4

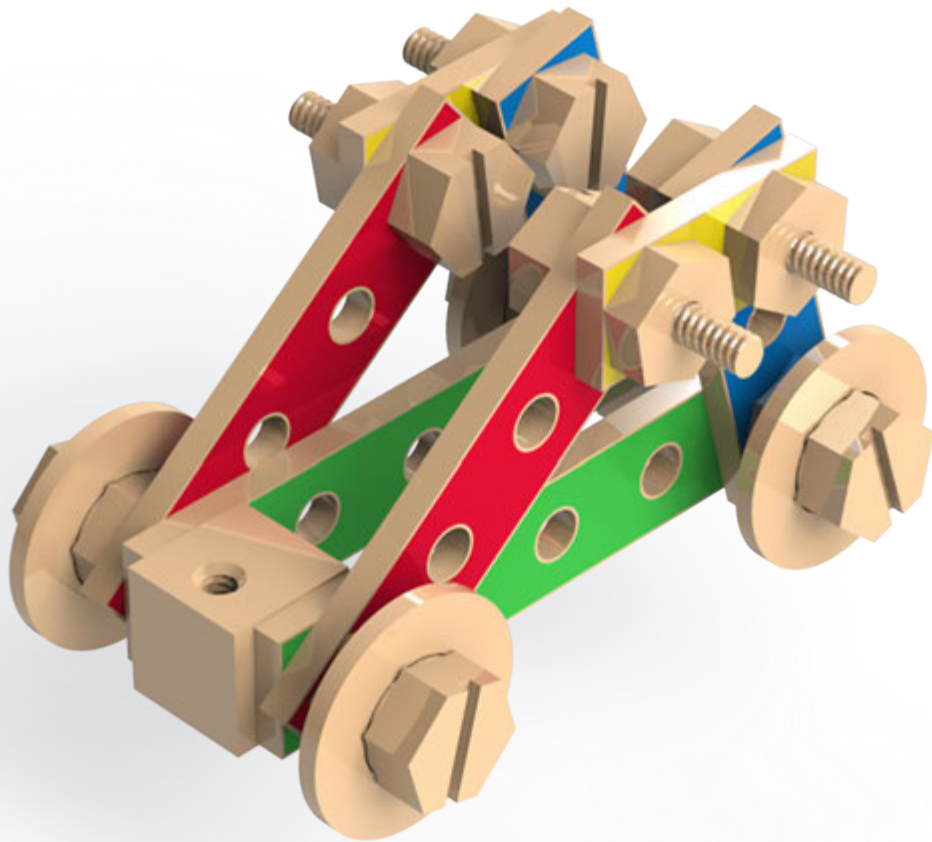
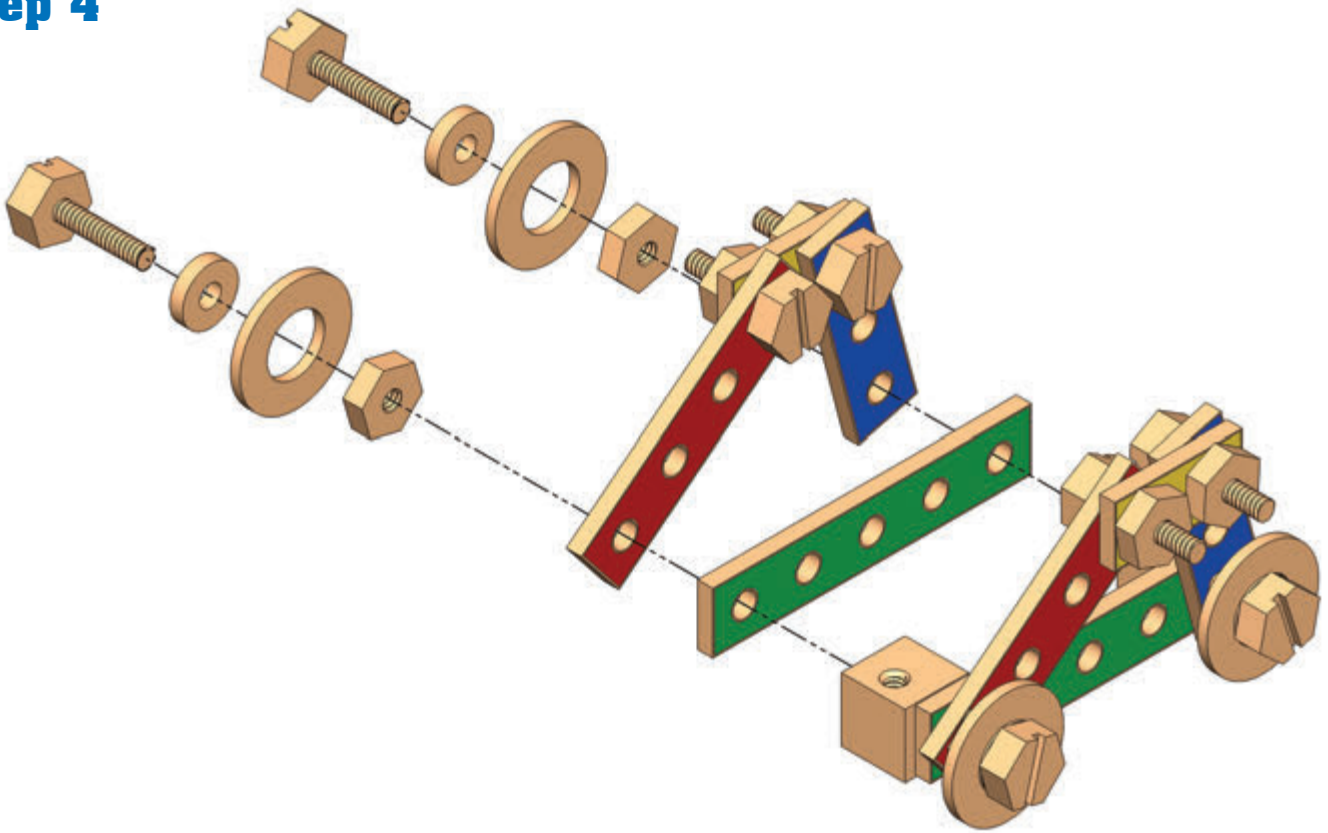

MOTORCYCLE

Parts Needed

2 green building strips



2 red building strips



2 yellow building strips



1 connector block



7 nuts



8 bolts

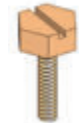

2 wheels



2 hubs



Step 1

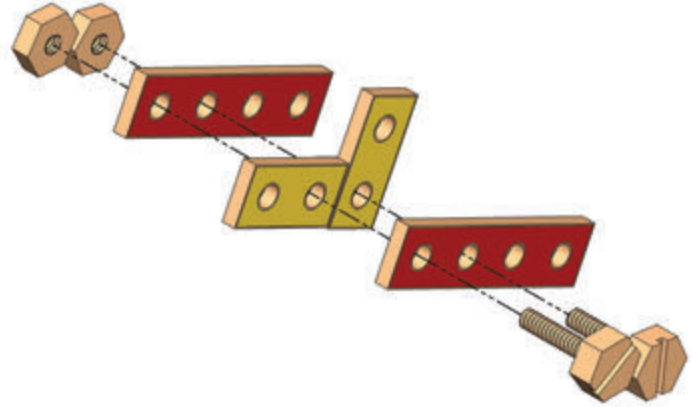

Step 2

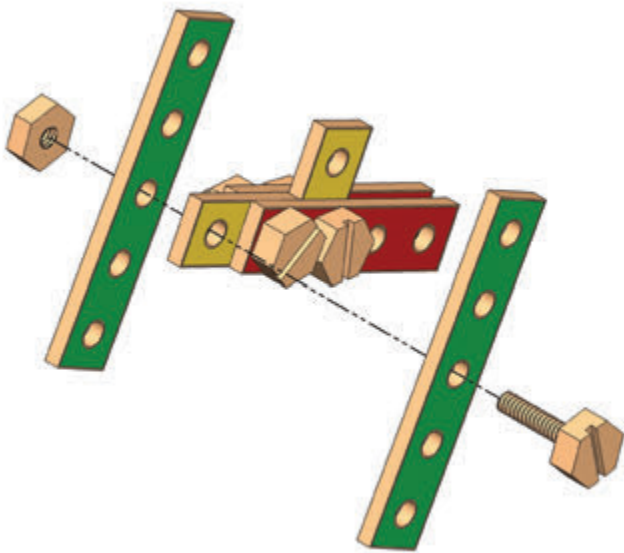

Step 3

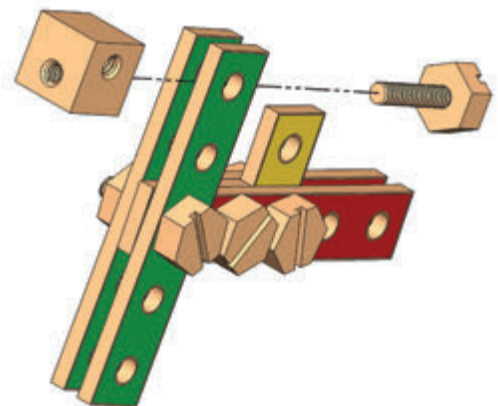

Step 4

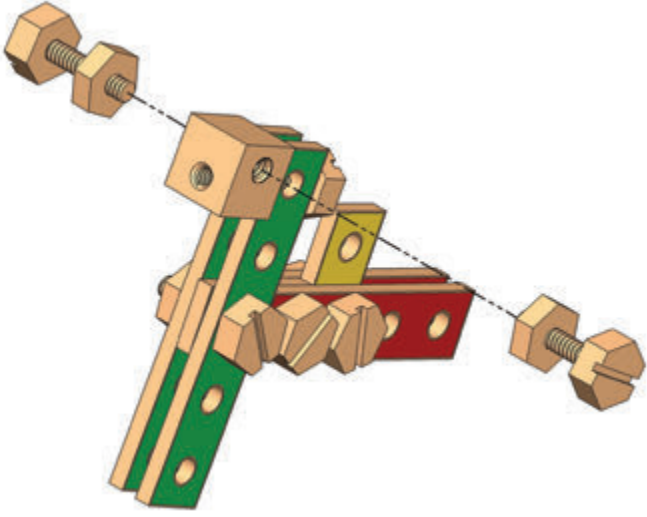

Step 5

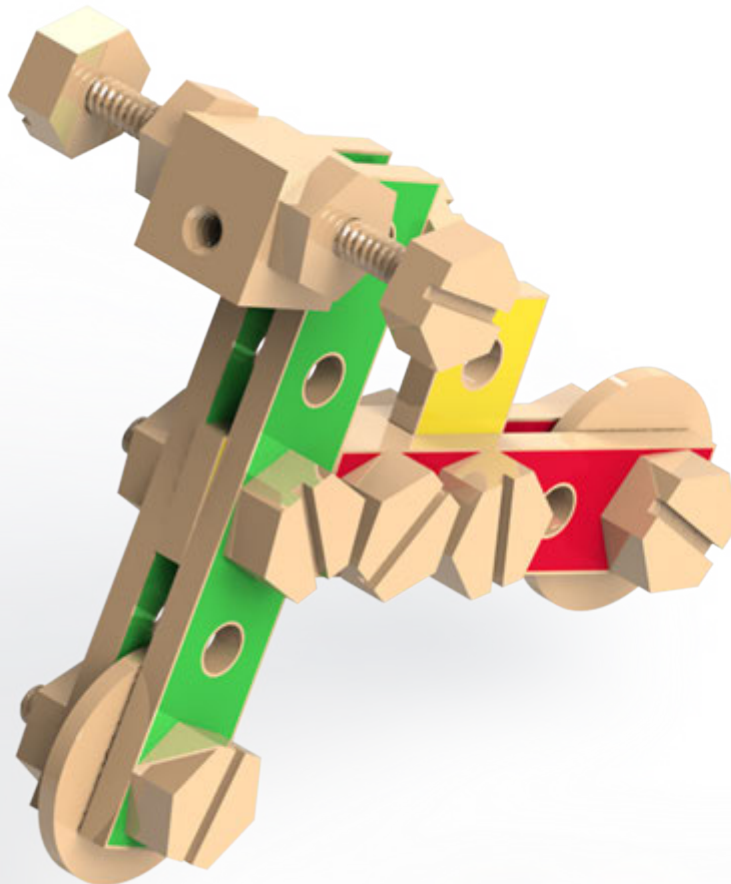
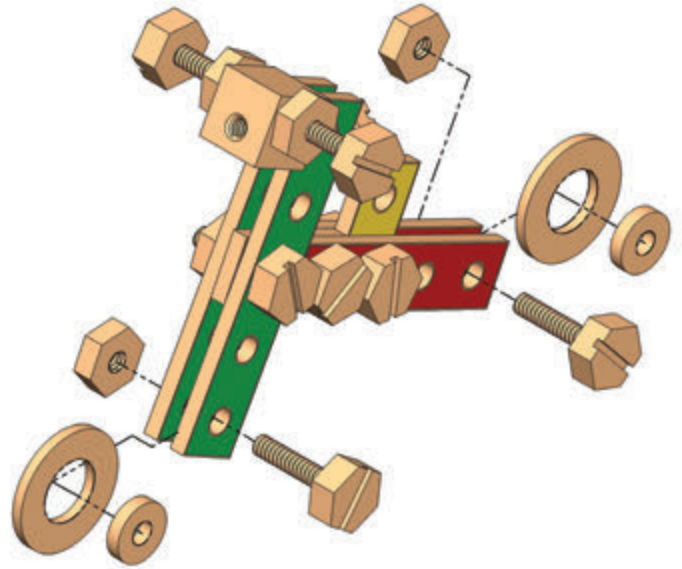

RACE CAR

Parts Needed

2 green building strips



3 red building strips



3 yellow building strips



3 connector blocks



10 nuts



10 bolts



4 wheels



4 hubs



Step 1

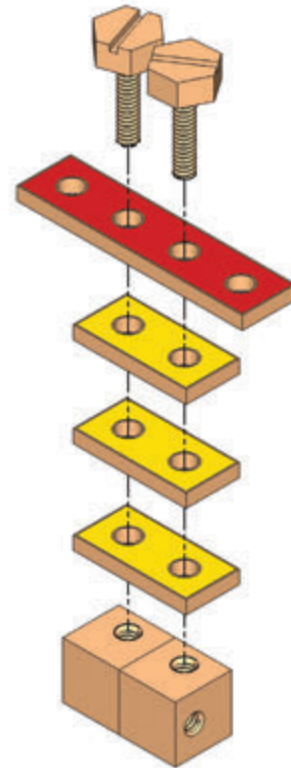

Step 2

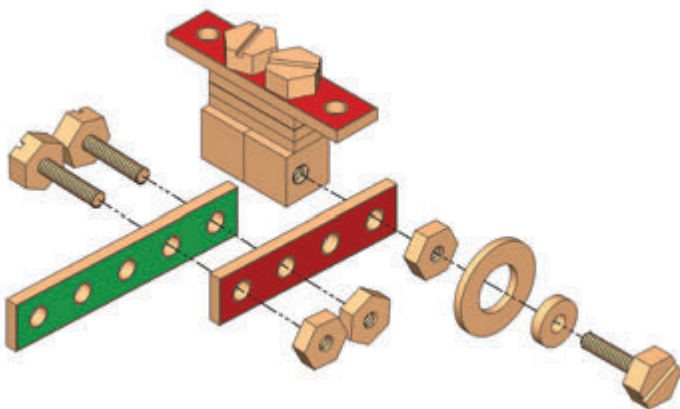

Step 3

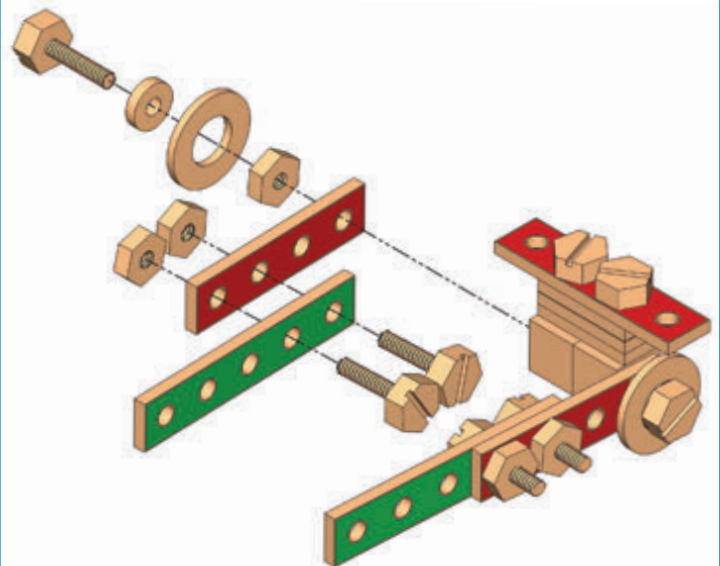

Step 4

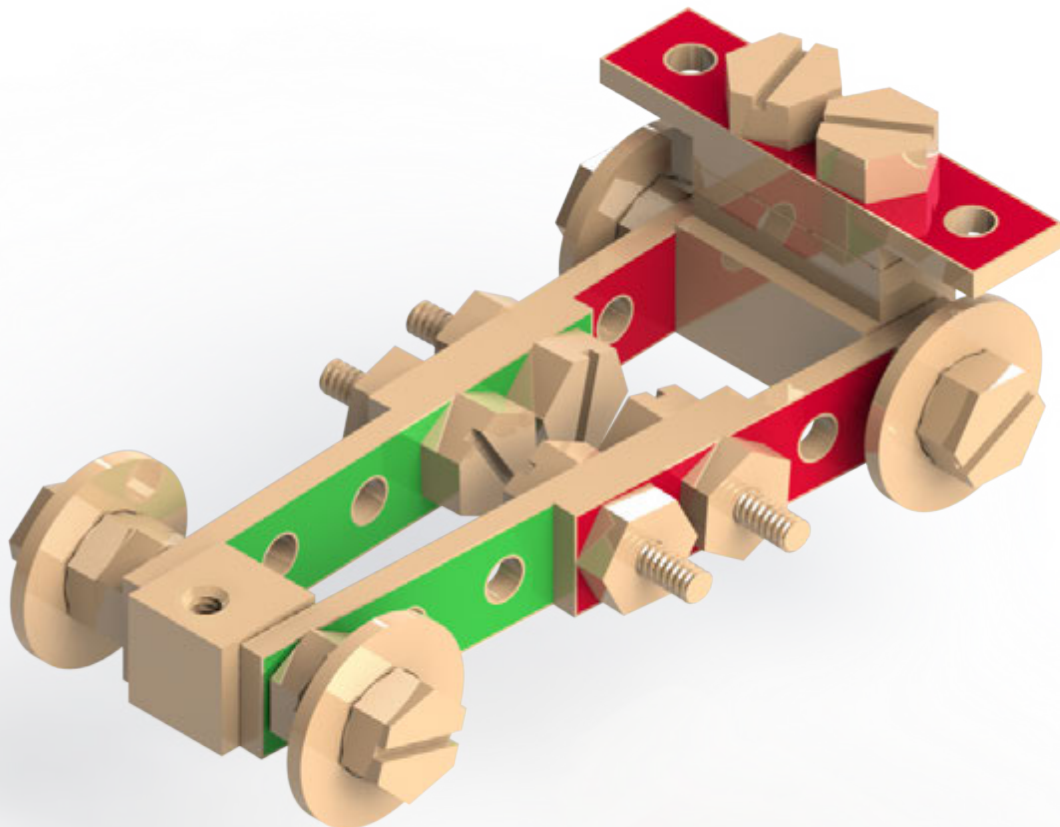
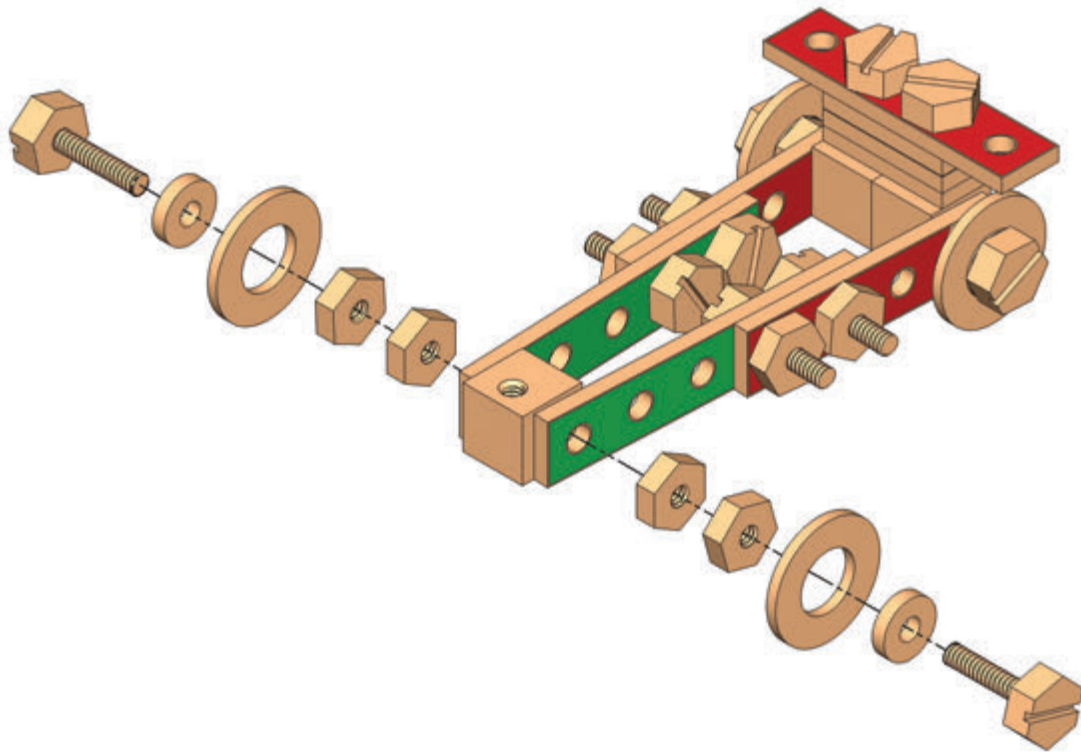

HELICOPTER

Parts Needed

2 green building strips



2 connector blocks



4 red building strips



10 nuts



4 blue building strips



10 bolts



4 yellow building strips



3 hubs



Step 1

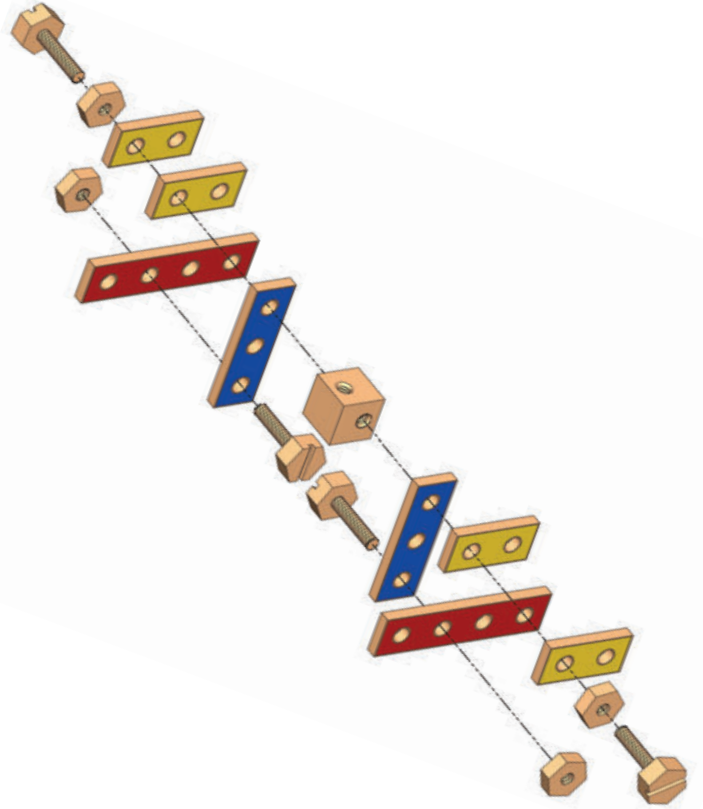

Step 2

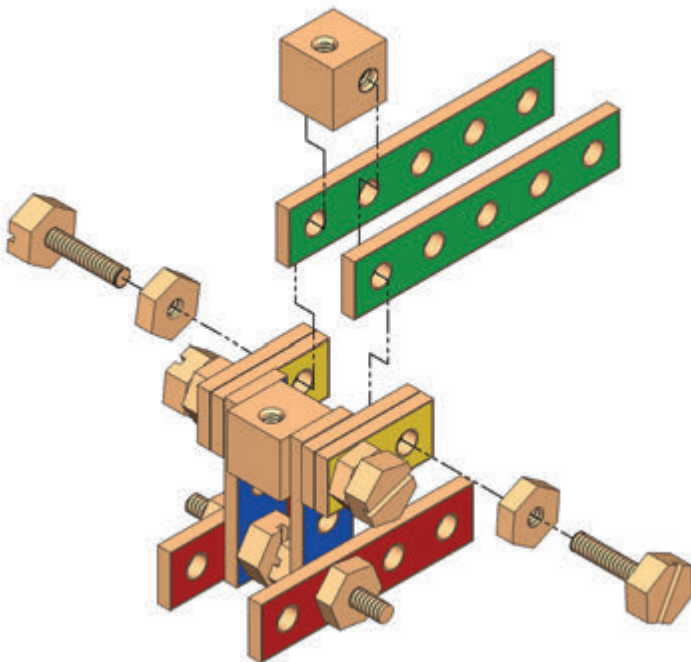

Step 3

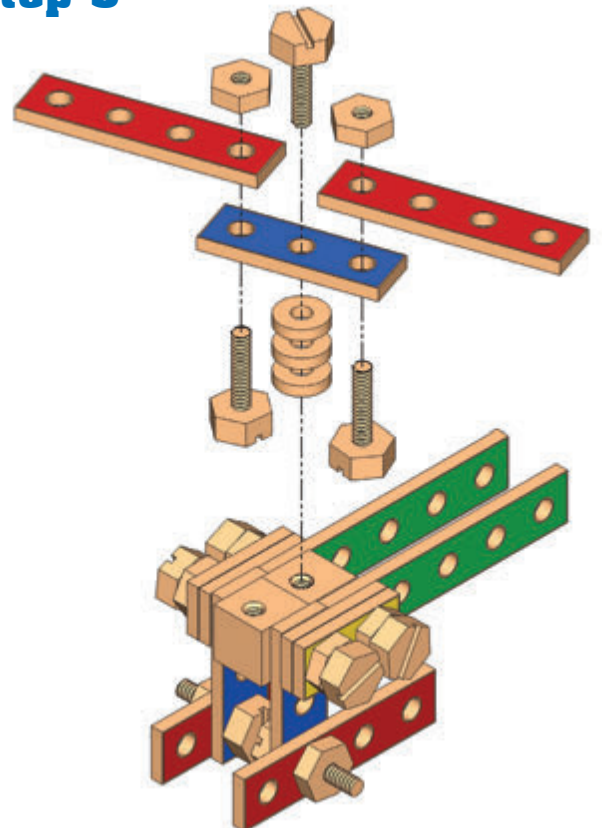

Step 4

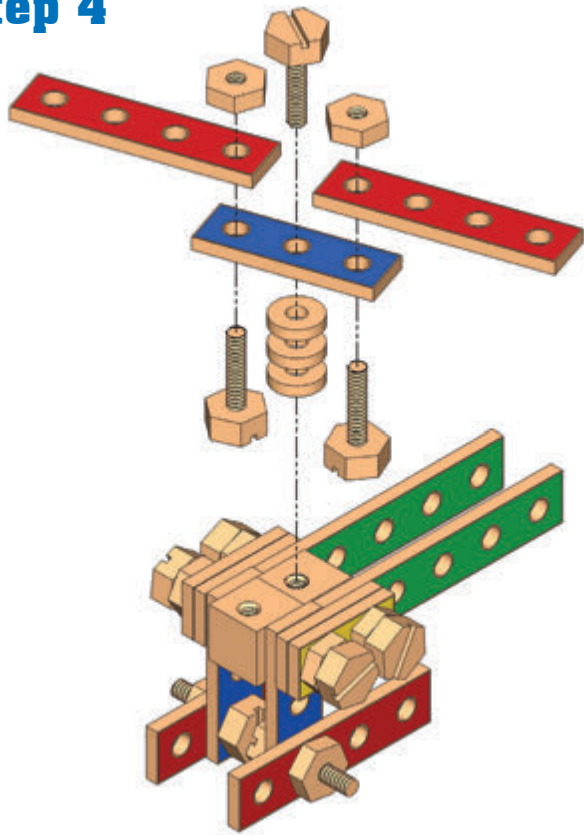

Step 5

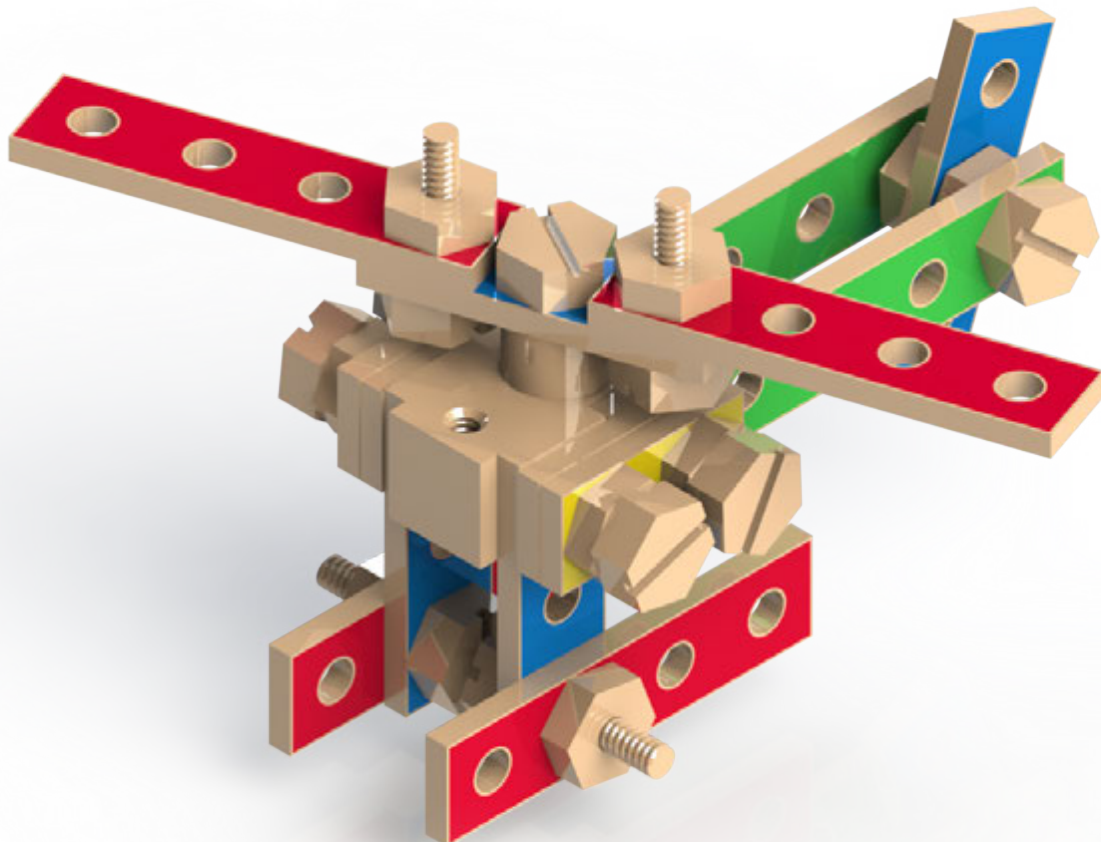
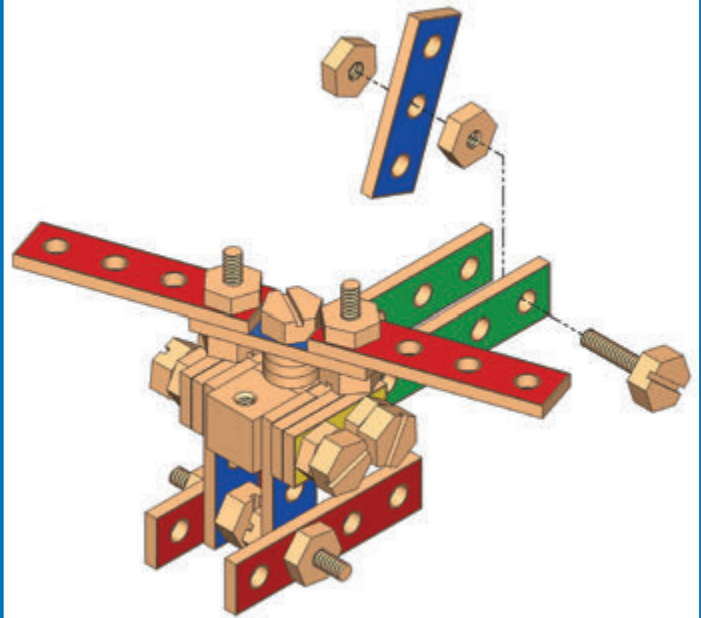

ROBOT

Parts Needed

2 green building strips



2 red building strips



2 blue building strips



2 yellow building strips



2 connector blocks



10 nuts



7 bolts



1 wheel



3 hubs



Step 1

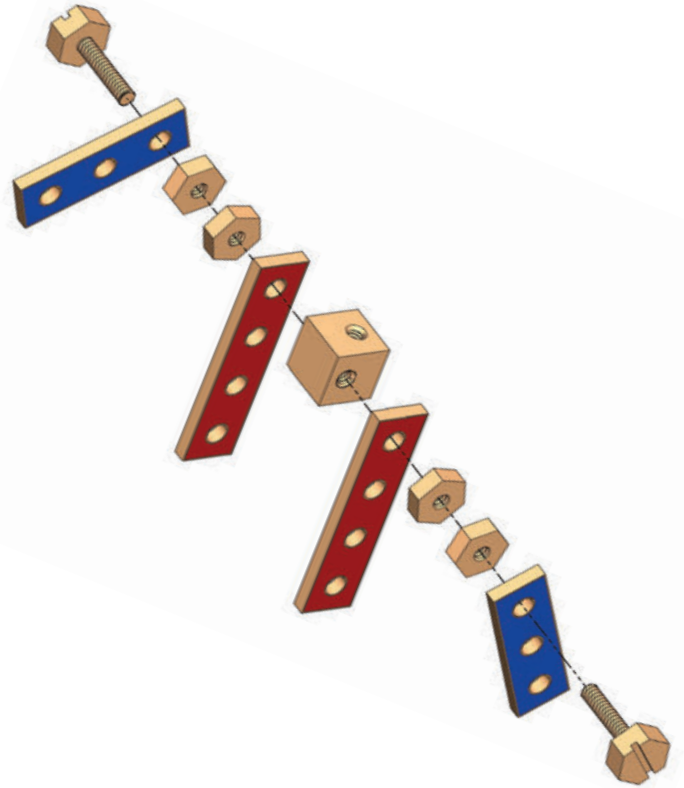

Step 2

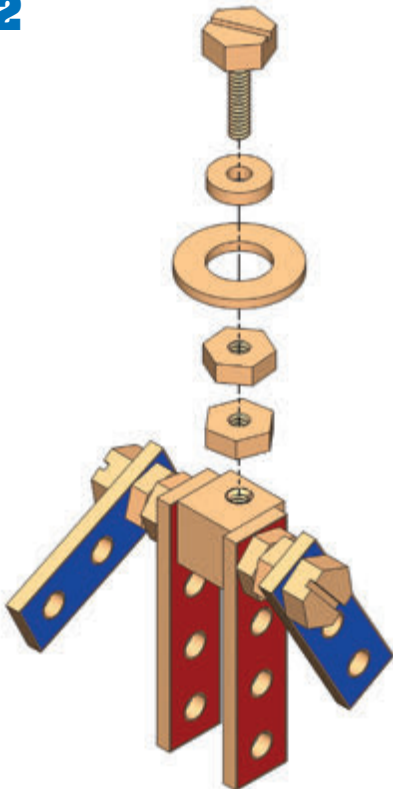

Step 3

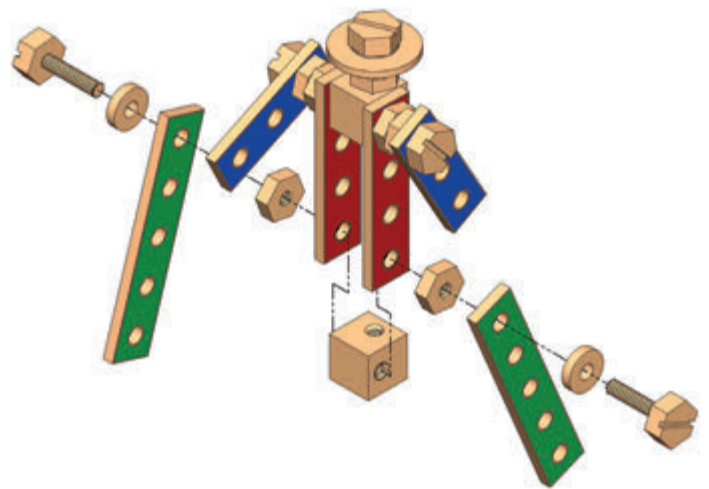

Step 4

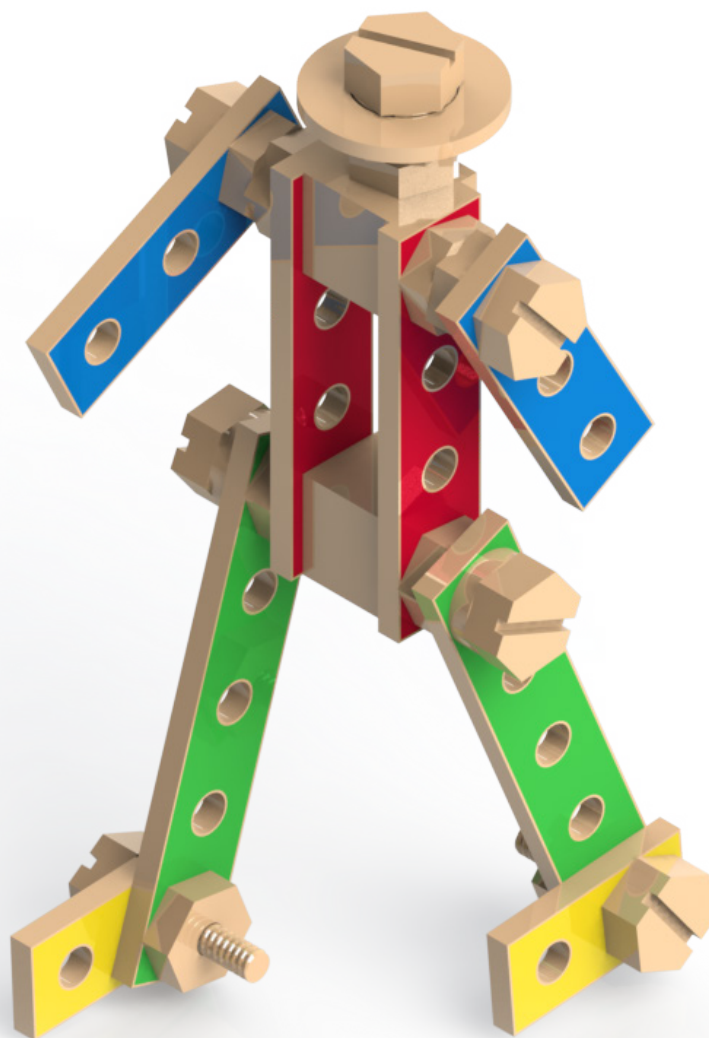
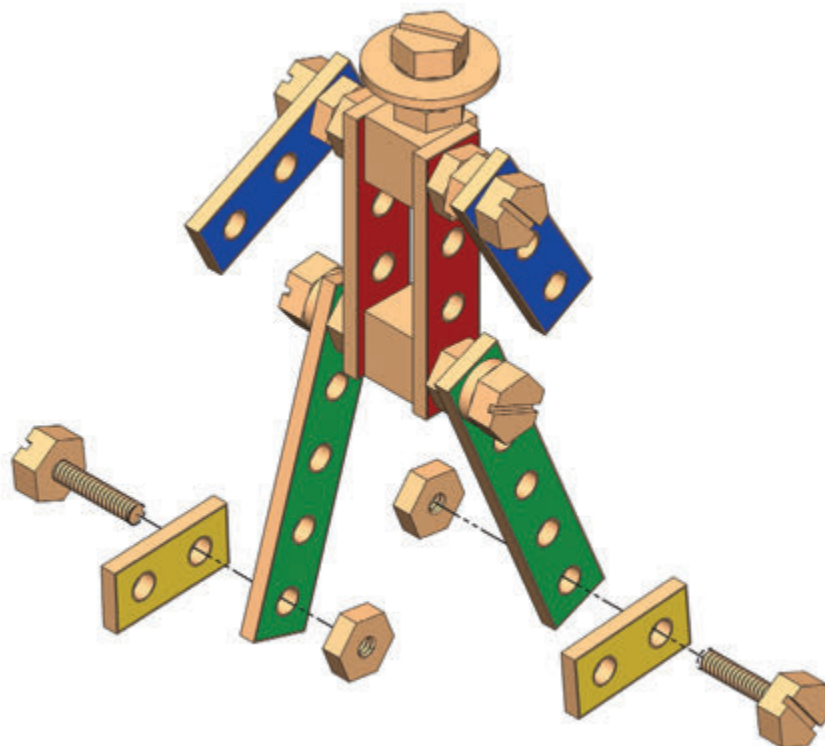

AIRPLANE

Parts Needed

2 green building strips



4 red building strips



4 blue building strips



2 connector blocks



4 nuts



7 bolts



2 wheels



4 hubs



Step 1

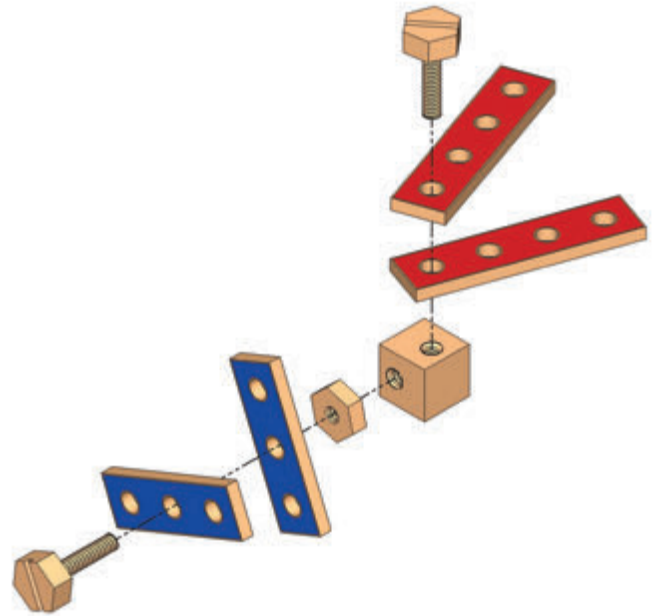

Step 2

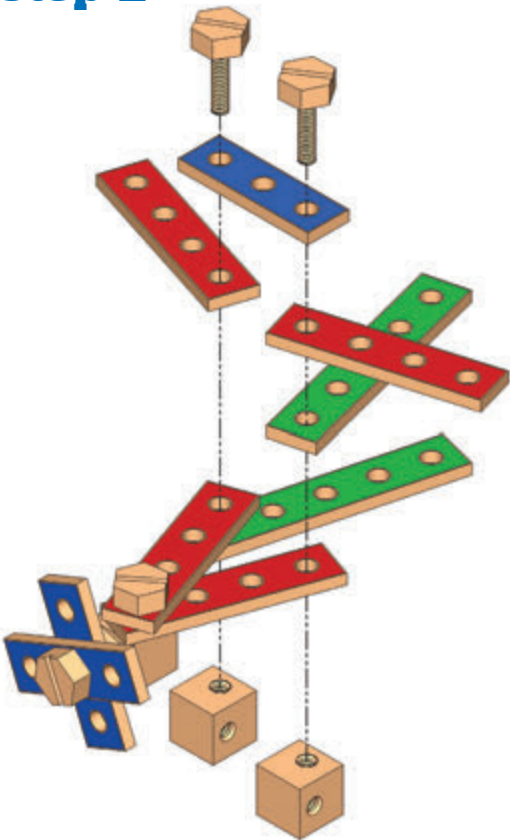

Step 3

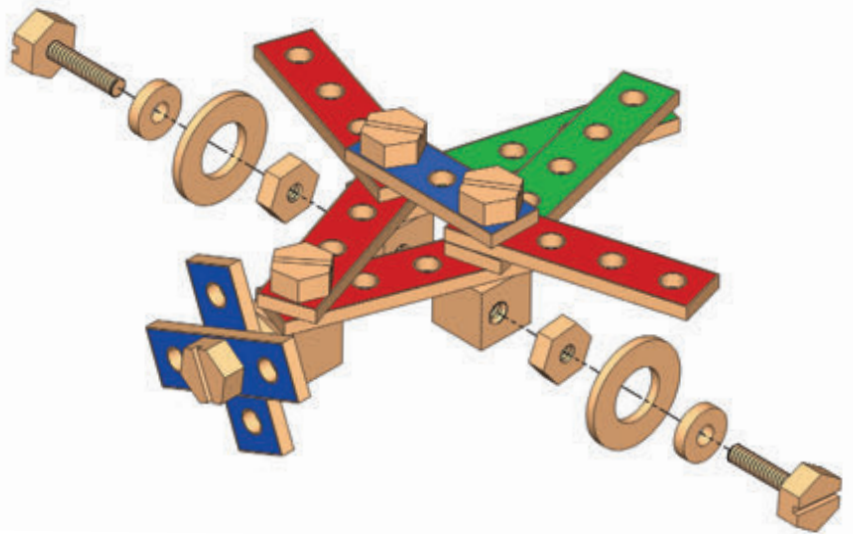

Step 4

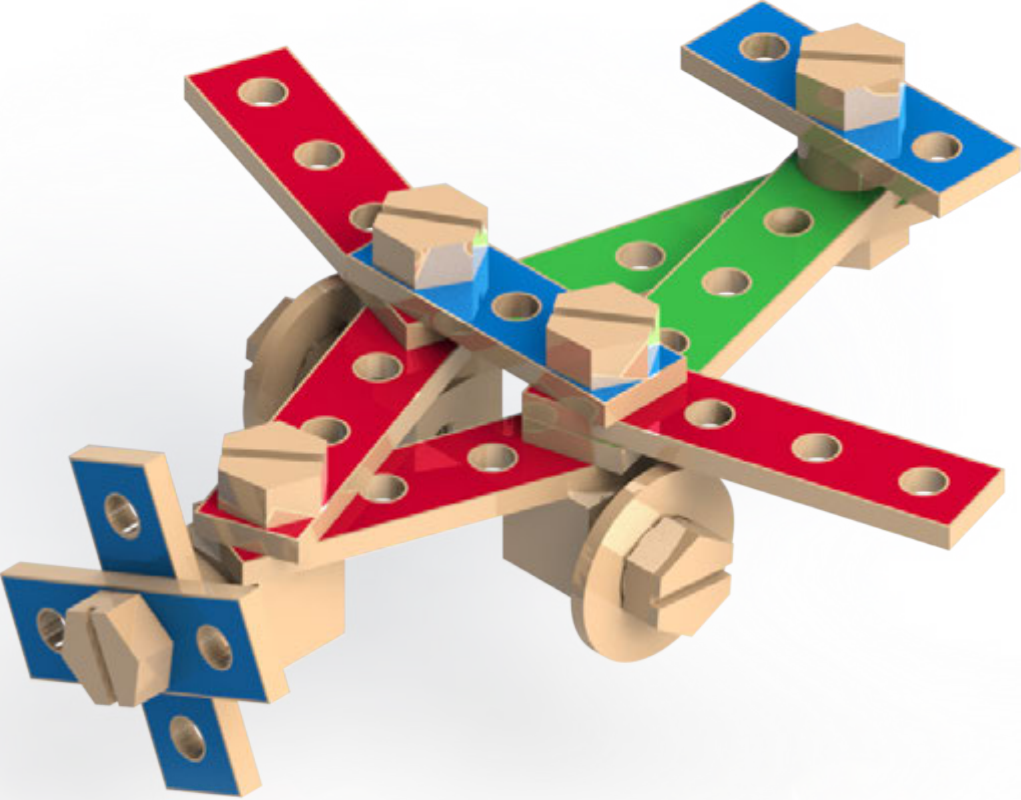
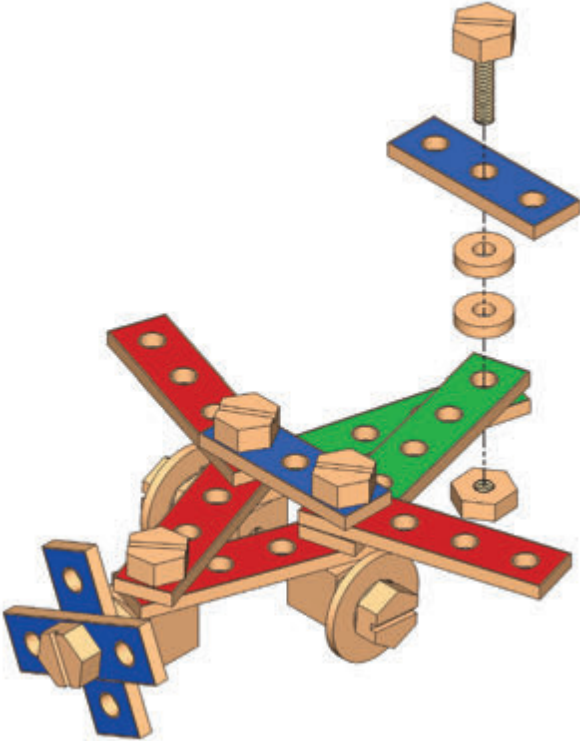

Wooden Project Work Bench
#2369

Melissa & Doug[®]

We ♥ feedback! Call us: 1-800-284-3948

MelissaAndDoug.com

Melissa & Doug products meet or exceed all U.S. toy testing standards and pass our high quality requirements.

© Melissa & Doug, LLC, P.O. Box 590, Westport, CT 06881