

1-1 Word Problem Practice

Points, Lines, and Planes

- 1. STREETS** The map shows some of the roads in downtown Little Rock. Lines are used to represent streets and points are used to represent intersections. Four of the street intersections are labeled. What street corresponds to line AB ?

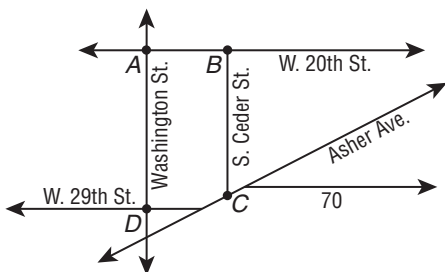

- 2. FLYING** Marsha plans to fly herself from Gainesville to Miami. She wants to model her flight path using a straight line connecting the two cities on the map. Sketch her flight path on the map shown below.



- 3. MAPS** Nathan's mother wants him to go to the post office and the supermarket. She tells him that the post office, the supermarket and their home are collinear, and the post office is between the supermarket and their home. Make a map showing the three locations based on this information.

- 4. ARCHITECTURE** An architect models the floor, walls, and ceiling of a building with planes. To locate one of the planes that will represent a wall, the architect starts by marking off two points in the plane that represents the floor. What further information can the architect give to specify the plane that will represent the wall?

CONSTRUCTION For Exercises 5 and 6, use the following information.

Mr. Riley gave his students some rods to represent lines and some clay to show points of intersection. Below is the figure Lynn constructed with all of the points of intersection and some of the lines labeled.

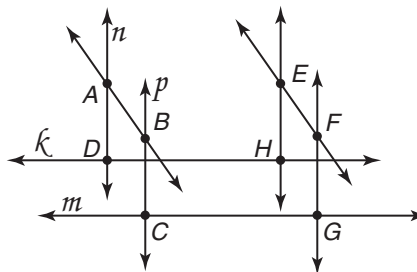

- 5.** What is the intersection of lines k and n ?
- 6.** Name the lines that intersect at point C .
- 7.** Are there 3 points that are collinear and coplanar? If so, name them.

1-2 Word Problem Practice

Linear Measure and Precision

- 1. MEASURING** Vera is measuring the size of a small hexagonal silver box that she owns. She places a standard 12 inch ruler alongside the box. About how long is one of the sides of the box?

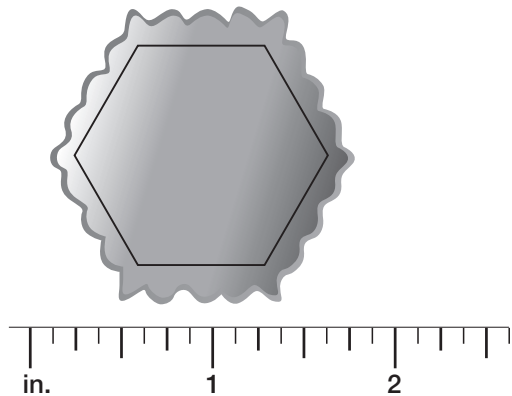

- 2. WALKING** Marshall lives 2300 yards from school and 1500 yards from the pharmacy. The school, pharmacy, and his home are all collinear, as shown in the figure.

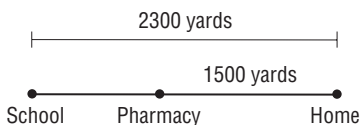

What is the total distance from the pharmacy to the school?

- 3. HIKING TRAIL** A hiking trail is 20 kilometers long. Park organizers want to build 5 rest stops for hikers with one on each end of the trail and the other 3 spaced evenly between. How much distance will separate successive rest stops?

- 4. RAILROADS** A straight railroad track is being built to connect two cities. The measured distance of the track between the two cities is 160.5 miles. Find the precision for this measurement and explain its meaning.

BUILDING BLOCKS For Exercises 5 and 6, use the following information.

Lucy's younger brother has three wooden cylinders. They have heights 8 inches, 4 inches, and 6 inches and can be stacked one on top of the other.

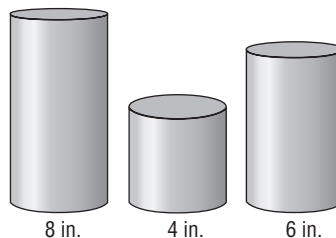

- 5.** If all three cylinders are stacked one on top of the other, how high will the resulting column be? Does it matter in what order the cylinders are stacked?
- 6.** What are all the possible heights of columns that can be built by stacking some or all of these cylinders?

1-3 Word Problem Practice

Distance and Midpoints

1. **CAMPGROUND** Troop 175 is designing their new campground by first mapping everything on a coordinate grid. They have found a location for the mess hall and for their cabins. They want the bathrooms to be halfway between these two. What will be the coordinates of the location of the bathrooms?

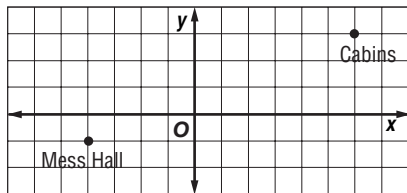

2. **PIZZA** Calvin's home is located at the midpoint between Fast Pizza and Pizza Now. Fast Pizza is a quarter mile away from Calvin's home. How far away is Pizza Now from Calvin's home? How far apart are the two pizzerias?

3. **SPIRALS** Caroline traces out the spiral shown in the figure. The spiral begins at the origin. What is the shortest distance between Caroline's starting point and her ending point?

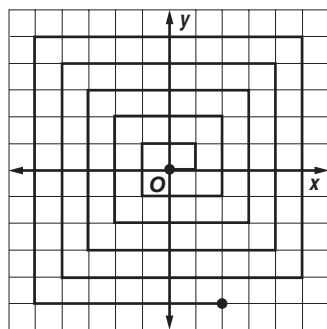

4. **WASHINGTON, D.C.** The United States Capitol is located 800 meters south and 2300 meters to the east of the White House. If the locations were placed on a coordinate grid, the White House would be at the origin. What is the distance between the Capitol and the White House? Round your answer to the nearest meter.

MAPPING For Exercises 5 and 6, use the following information.

Ben and Kate are making a map of their neighborhood on a piece of graph paper. They decide to make one unit on the graph paper correspond to 100 yards. First, they put their homes on the map as shown below.

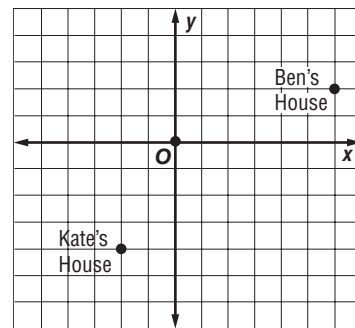

5. How many yards apart are Kate's and Ben's homes?
6. Their friend Jason lives exactly halfway between Ben and Kate. Mark the location of Jason's home on the map.

1-4 Word Problem Practice

Angle Measure

1. LETTERS Lina learned about types of angles in geometry class. As she was walking home she looked at the letters on a street sign and noticed how many are made up of angles. The sign she looked at was **KLINE ST.** Which letter(s) on the sign have an obtuse angle? What other letters in the alphabet have an obtuse angle?

2. SQUARES A square has four right angle corners. Give an example of another shape that has four right angle corners.

3. STARS Melinda wants to know the angle of elevation of a star above the horizon. Based on the figure, what is the angle of elevation? Is this angle an acute, right, or obtuse angle?

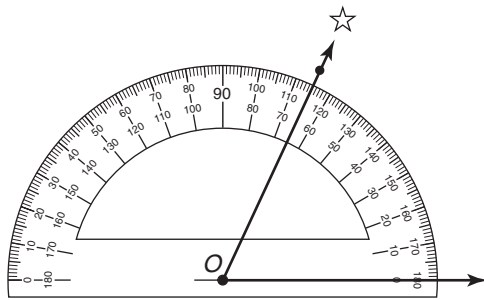

4. CAKE Nick has a slice of cake. He wants to cut it in half, bisecting the 46° angle formed by the straight edges of the slice. What will be the measure of the angle of each of the resulting pieces?

ROADS For Exercises 5–7, use the following figure.

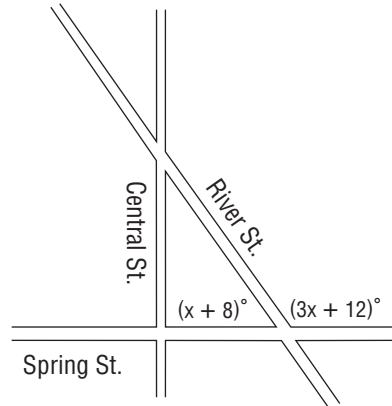

5. Central Street runs north-south and Spring Street runs east-west. What kind of angle do Central Street and Spring Street make?

6. Valerie is driving down Spring Street heading east. She takes a left onto River Street. What type of angle did she have to turn her car through?

7. What is the angle measure Valerie is turning her car when she takes the left turn?

1-5 Word Problem Practice

Angle Relationships

1. **LETTERS** A sign painter is painting a large “X”. What are the measures of angles 1, 2, and 3?

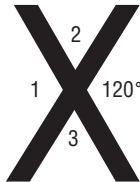

2. **PAPER** Matthew cuts a straight line segment through a rectangular sheet of paper. His cut goes right through a corner. How are the two angles formed at that corner related?

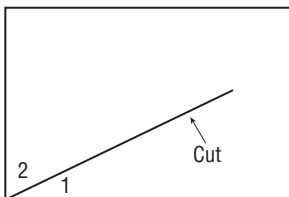

3. **PIZZA** Ralph has sliced a pizza using straight line cuts through the center of the pizza. The slices are not exactly the same size. Ralph notices that two adjacent slices are complementary. If one of the slices has a measure of $2x^\circ$, and the other a measure of $3x^\circ$, what is the measure of each angle?

4. **GLASS** Carlo dropped a piece of stained glass and the glass shattered. He picked up the piece shown on the left.

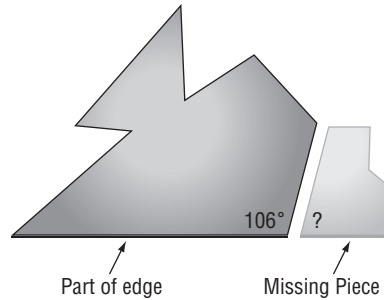

He wanted to find the piece that was adjoining on the right. What should the measurement of the angle marked with a question mark be? How is that angle related to the angle marked 106° ?

LAYOUTS For Exercises 5–7, use the following information.

A rectangular plaza has a walking path along its perimeter in addition to two paths that cut across the plaza as shown in the figure.

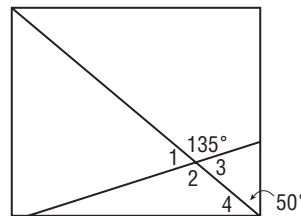

5. Find the measure of angle 1.
6. Find the measure of angle 4.
7. Name a pair of vertical angle in the figure. What is the measure of $\angle 2$?

1-6

Word Problem Practice

Two-Dimensional Figures

- 1. ARCHITECTURE** In the Uffizi gallery in Florence, Italy, there is a room filled with paintings by Bronzino called the Tribune room (*La Tribuna* in Italian). The floor plan of the room is shown below.

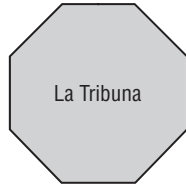

What kind of polygon is the floor plan?

- 2. JOGGING** Vassia decides to jog around a city park. The park is shaped like a circle with a diameter of 300 yards. If Vassia makes one loop around the park, approximately how far has she run?

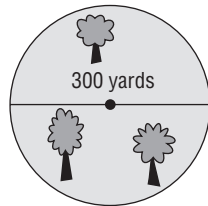

- 3. PORTRAITS** Around 1550, Agnolo Bronzino painted a portrait of Eleonore of Toledo and her son. The painting measures 115 centimeters by 96 centimeters. What is the area of the painting?

- 4. ORIGAMI** Jane takes a square piece of paper and folds it in half making a crease that connects the midpoints of two opposite sides. The original piece of paper was 8 inches on a side. What is the perimeter of the resulting rectangle?

STICKS For Exercises 5–7, use the following information.

Amy has a box of teriyaki sticks. They are all 15 inches long. She creates rectangles using the sticks by placing them end to end like the rectangle shown in the figure.

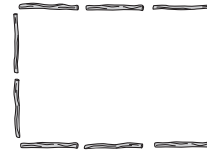

- 5.** How many different rectangles can she make that use exactly 12 of the sticks? What are their dimensions?
- 6.** What is the perimeter of each rectangle listed in Exercise 5?
- 7.** Which of the rectangles in Exercise 5 has the largest area?

1-7 Word Problem Practice

Three-Dimensional Figures

1. KEPLER For some time, Johannes Kepler thought that the Platonic solids were related to the orbits of the planets. He made models of each of the Platonic solids. He made a frame of each of the platonic solids by fashioning together wooden edges. How many wooden edges did Kepler have to make for the cube?

2. OCTAGONAL BUILDINGS Thomas Jefferson built an octagonal building in 1805 in Virginia. In fact, the building is roughly shaped like a regular octagonal prism. Complete the following table.

Attributes of a Regular Octagonal Prism	
No. of Vertices	
No. of Edges	
No. of Faces	

3. TRASH CANS A cylindrical trash can is 30 inches high and has a base radius of 7 inches. What is the outside surface area of this trash can, including the top of the lid? Round your answer to the nearest square inch.

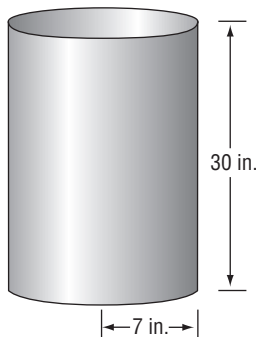

4. ALGAE Ronald owns a fish tank in the shape of a rectangular box. The tank is 18 inches high, 14 inches deep, and 30 inches long. Ronald went on a one-month vacation. When he returned he found that the sides and bottom of his fish tank were covered with algae. What is the area that was covered?

SILOS For Exercises 5–7, use the following information.

A silo is shaped like a cylinder with a cone on top. The radii of the bases of the cylinder and cone are both equal to 8 feet. The height of the cylindrical part is 25 feet and the height of the cone is 6 feet.



5. What is the volume of the cylindrical part of the silo? Round your answer to the nearest cubic foot.

6. What is the volume of the conical part of the silo? Round your answer to the nearest cubic foot.

7. What is the volume of the entire silo? Round your answer to the nearest cubic foot.

2-1 Word Problem Practice

Inductive Reasoning and Conjecture

- 1. RAMPS** Rodney is rolling marbles down a ramp. Every second that passes, he measures how far the marbles travel. He records the information in the table shown below.

Second	1st	2nd	3rd	4th
Distance (cm)	20	60	100	140

Make a conjecture about how far the marble will roll in the fifth second.

- 2. PRIMES** A prime number is a number other than 1 that is divisible by only itself and 1. Lucille read that prime numbers are very important in cryptography, so she decided to find a systematic way of producing prime numbers. After some experimenting, she conjectured that $2^n - 1$ is a prime for all whole numbers $n > 1$. Find a counterexample to this conjecture.

- 3. GENEALOGY** Miranda is developing a chart that shows her ancestry. She makes the three sketches shown below. The first dot represents herself. The second sketch represents herself and her parents. The third sketch represents herself, her parents, and her grandparents.



Sketch what you think would be the next figure in the sequence.

- 4. MEDALS** Barbara is in charge of the award medals for a sporting event. She has 31 medals to give out to various individuals on 6 competing teams. She asserts that at least one team will end up with more than 5 medals. Do you believe her assertion? If you do, try to explain why you think her assertion is true, and if you do not, explain how she can be wrong.

PATTERNS For Exercises 5–7, use the following information.

The figure shows a sequence of squares each made out of identical square tiles.

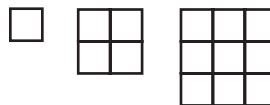

- 5.** Starting from zero tiles, how many tiles do you need to make the first square? How many tiles do you have to add to the first square to get the second square? How many tiles do you have to add to the second square to get the third square?
- 6.** Make a conjecture about the list of numbers you started writing in your answer to Exercise 5.
- 7.** Make a conjecture about the sum of the first n odd numbers.

2-2 Word Problem Practice

Logic

1. HOCKEY Carol asked John if his hockey team won the game last night and if he scored a goal. John said “yes.” Carol then asked Peter if he or John scored a goal at the game. Peter said “yes.” What can you conclude about whether or not Peter scored?

2. CHOCOLATE Nash has a bag of miniature chocolate bars that come in two distinct types: dark and milk. Nash picks a chocolate out of the bag. Consider these statements:
p: the chocolate bar is dark chocolate
q: the chocolate bar is milk chocolate
 Is the following statement true?

$$\sim(\sim p \wedge \sim q)$$

3. VIDEO GAMES Harold is allowed to play video games only if he washes the dishes or takes out the trash. However, if Harold does not do his homework, he is not allowed to play video games under any circumstance. Complete the truth table.

p: Harold has washed the dishes
q: Harold has taken out the trash
r: Harold has done his homework
s: Harold is allowed to play video games

<i>p</i>	<i>q</i>	<i>r</i>	<i>s</i>
T	T	T	
T	T	F	
T	F	T	
T	F	F	
F	T	T	
F	T	F	
F	F	T	
F	F	F	

4. CIRCUITS In Earl’s house, the dining room light is controlled by two switches according to the following table.

Switch A	Switch B	Light
up	up	off
up	down	on
down	up	on
down	down	off

If up and on are considered true and down and off are considered false, write an expression that gives the truth value of the light as a function of the truth values of the two switches.

READING For Exercises 5–7, use the following information.

Two hundred people were asked what kind of literature they like to read. They could choose among novels, poetry, and plays. The results are shown in the Venn diagram.

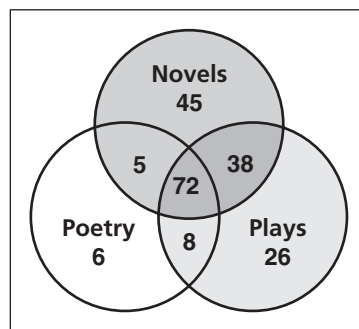

5. How many people said they like all three types of literature?

6. How many like to read poetry?

7. What percentage of the people who like plays also like novels and poetry?

2-3 Word Problem Practice

Conditional Statements

1. TANNING Maya reads in a paper that people who tan themselves under the Sun for extended periods are at increased risk of skin cancer. From this information, can she conclude that she will not increase her risk of skin cancer if she avoids tanning for extended periods of time?

2. PARALLELOGRAMS Clark says that being a parallelogram is equivalent to being a quadrilateral with equal opposite angles. Write his statement in if-then form.

3. AIR TRAVEL Ulma is waiting to board an airplane. Over the speakers she hears a flight attendant say “If you are seated in rows 10 to 20, you may now board.” What are the inverse, converse, and the contrapositive of this statement?

4. MEDICATION Linda’s medicine bottle says “If you are pregnant, then you cannot take this medicine.” What are the inverse, converse, and the contrapositive of this statement?

VENN DIAGRAMS For Exercises 5–8, use the following information.

Jose made this Venn diagram to show how rectangles, squares, and rhombi are related. (A rhombus is a quadrilateral with four sides of equal length.)

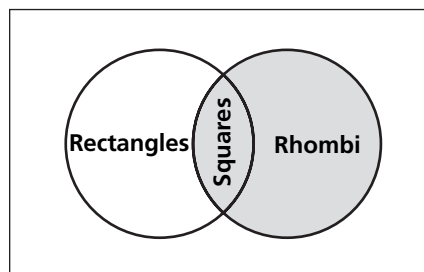

Let Q be a quadrilateral. For each problem tell whether the statement is true or false. If it is false, provide a counterexample.

5. If Q is a square, then Q a rectangle.

6. If Q is not a rectangle, then Q is not a rhombus.

7. If Q is a rectangle but not a square, then Q is not a rhombus.

8. If Q is not a rhombus, then Q is not a square.

2-4 Word Problem Practice

Deductive Reasoning

1. **SIGNS** Two signs are posted on a haunted house.

**NO ONE
UNDER
5
ALLOWED**

**NO ONE
UNDER 8
ALLOWED
WITHOUT A
PARENT**

Inside the haunted house, you find a child with his parent. What can you deduce about the age of the child based on the house rules?

2. **LOGIC** As Laura's mother rushed off to work, she quickly gave Laura some instructions. "If you need me, try my cell . . . if I don't answer it means I'm in a meeting, but don't worry, the meeting won't last more than 30 minutes and I'll call you back when it's over." Later that day, Laura needed her mother, but her mother was stuck in a meeting and couldn't answer the phone. Laura concludes that she will have to wait no more than 30 minutes before she gets a call back from her mother. What law of logic did Laura use to draw this conclusion?
3. **MUSIC** Composer Ludwig van Beethoven wrote 9 symphonies and 5 piano concertos. If you lived in Vienna in the early 1800s, you could attend a concert conducted by Beethoven himself. Write a valid conclusion to the hypothesis *If Mozart could not attend a concert conducted by Beethoven, . . .*

4. **DIRECTIONS** Hank has an appointment to see a financial advisor on the fifteenth floor of an office building. When he gets to the building, the people at the front desk tell him that if he wants to go to the fifteenth floor, then he must take the red elevator. While looking for the red elevator, a guard informs him that if he wants to find the red elevator he must find the replica of Michelangelo's David. When he finally got to the fifteenth floor, his financial advisor greeted him asking, "What did you think of the Michelangelo?" How did Hank's financial advisor conclude that Hank must have seen the Michelangelo statue?

LAWS For Exercises 5 and 6, use the following information.

The law says that if you are under 21, then you are not allowed to drink alcoholic beverages and if you are under 18, then you are not allowed to vote. For each problem give the possible ages of the person described or state that the person cannot exist.

5. John cannot drink wine legally but is allowed to vote.
6. Mary cannot vote legally but can drink beer legally.

2-5 Word Problem Practice

Postulates and Paragraph Proofs

1. ROOFING Noel and Kirk are building a new roof. They wanted a roof with two sloping planes that meet along a curved arch. Is this possible?

2. AIRLINES An airline company wants to provide service to San Francisco, Los Angeles, Chicago, Dallas, Washington D. C., and New York City. The company CEO draws lines between each pair of cities in the list on a map. No three of the cities are collinear. How many lines did the CEO draw?

3. TRIANGULATION A sailor spots a whale through her binoculars. She wonders how far away the whale is, but the whale does not show up on the radar system. She sees another boat in the distance and radios the captain asking him to spot the whale and record its direction. Explain how this added information could enable the sailor to pinpoint the location of the whale. Under what circumstance would this idea fail?

4. POINTS Carson claims that a line can intersect a plane at only one point and draws this picture to show his reasoning.

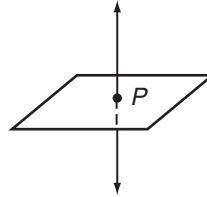

Zoe thinks it is possible for a line to intersect a plane at more than one point. Who is correct? Explain.

FRIENDSHIPS For Exercises 5 and 6, use the following information.

A small company has 16 employees. The owner of the company became concerned that the employees did not know each other very well. He decided to make a picture of the friendships in the company. He placed 16 points on a sheet of paper in such a way that no 3 were collinear. Each point represented a different employee. He then asked each employee who their friends were and connected two points with a line segment if they represented friends.

- What is the maximum number of line segments that can be drawn between pairs among the 16 points?
- When the owner finished the picture, he found that his company was split into two groups, one with 10 people and the other with 6. The people within a group were all friends, but nobody from one group was a friend of anybody from the other group. How many line segments were there?

2-6

Word Problem Practice

Algebraic Proof

Lesson 2-6

1. DOGS Jessica and Robert each own the same number of dogs. Robert and Gail also own the same number of dogs. Without knowing how many dogs they own, one can still conclude that Jessica and Gail each own the same number of dogs. What property is used to make this conclusion?

2. MONEY Lars and Peter both have the same amount of money in their wallets. They went to the store together and decided to buy some cookies, splitting the cost equally. After buying the cookies, do they still have the same amount of money in their wallets? What property is relevant to help you decide?

4. MANUFACTURING A company manufactures small electronic components called diodes. Each diode is worth \$1.50. Plant A produced 4,443 diodes and Plant B produced 5,557 diodes. The foreman was asked what the total value of all the diodes was. The foreman immediately responded "\$15,000." The foreman would not have been able to compute the value so quickly if he had to multiply \$1.50 by 4,443 and then add this to the result of \$1.50 times 5,557. Explain how you think the foreman got the answer so quickly?

4. FIGURINES Pete and Rhonda paint figurines. They can both paint 8 figurines per hour. One day, Pete worked 6 hours while Rhonda worked 9 hours. How many figurines did they paint that day? Show how to get the answer using the Distributive Property.

AGE For Exercises 5 and 6, use the following information.

William’s father is eight years older than 4 times William’s age. William’s father is 36 years old.

5. Let x be William’s age. Translate the given information into an algebraic equation involving x .

6. Fill in the missing steps and justifications for each step in finding the value of x .

Algebraic Steps	Properties
$4x + 8 = 36$	Original equation
_____	Subtraction Property
$4x = 28$	_____
$\frac{4x}{4} = \frac{28}{4}$	_____
_____	Substitution Property

2-7 Word Problem Practice

Proving Segment Relationships

1. FAMILY Maria is 11 inches shorter than her sister Nancy. Brad is 11 inches shorter than his brother Chad. If Maria is shorter than Brad, how do the heights of Nancy and Chad compare? What if Maria and Brad are the same height?

2. DISTANCE Martha and Laura live 1,400 meters apart. A library is opened between them and is 500 meters from Martha.

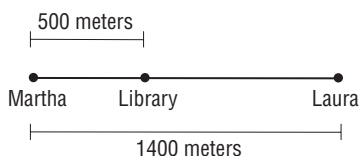

How far is the library from Laura?

3. LUMBER Byron works in a lumber yard. His boss just cut a dozen planks and asked Byron to double check that they are all the same length. The planks were numbered 1 through 12. Byron took out plank number 1 and checked that the other planks are all the same length as plank 1. He concluded that they must all be the same length. Explain how you know plank 7 and plank 10 are the same length even though they were never directly compared to each other?

4. NEIGHBORHOODS Karla, John, and Mandy live in three houses that are on the same line. John lives between Karla and Mandy. Karla and Mandy live a mile apart. Is it possible for John to be a mile from both Karla and Mandy?

LIGHTS For Exercises 5 and 6, use the following information.

Five lights, $A, B, C, D,$ and $E,$ are lined up in a row. The middle light is the midpoint of the second and fourth light and also the midpoint of the first and last light.

5. Draw a figure to illustrate the situation.

6. Complete this proof.

Given: C is the midpoint of \overline{BD} and $\overline{AE}.$

Prove: $AB = DE$

Statement	Reason
1. C is the midpoint of \overline{BD} and $\overline{AE}.$	1. Given
2. $BC = CD$ and	2. _____
3. $AC = AB + BC,$ $CE = CD + DE$	3. _____
4. $AB = AC - BC$	4. _____
5. _____	5. Substitution Property
6. $DE = CE - CD$	6. _____
7. _____	7. _____

2-8

Word Problem Practice

Proving Angle Relationships

1. ICOSAHEDRA For a school project, students are making a giant icosahedron, which is a large solid with many identical triangular faces. John is assigned quality control. He must make sure that the measures of all the angles in all the triangles are the same as each other. He does this by using a precut template and comparing the corner angles of every triangle to the template. How does this assure that the angles in all the triangles will be congruent to each other?

2. VISTAS If you look straight ahead at a scenic point, you can see a waterfall. If you turn your head 25° to the left, you will see a famous mountain peak. If you turn your head 35° more to the left, you will see another waterfall. If you are looking straight ahead, through how many degrees must you turn your head to the left in order to see the second waterfall?

3. TUBES A tube with a hexagonal cross section is placed on the floor.

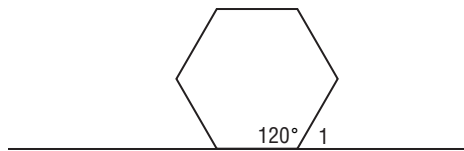

What is the measure of $\angle 1$ in the figure given that the angle at one corner of the hexagon is 120° ?

4. PAINTING Students are painting their rectangular classroom ceiling. They want to paint a line that intersects one of the corners as shown in the figure.

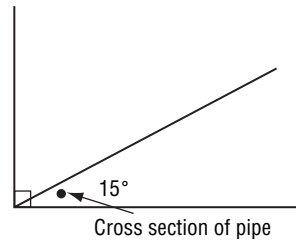

They want the painted line to make a 15° angle with one edge of the ceiling. Unfortunately, between the line and the edge there is a water pipe making it difficult to measure the angle. They decide to measure the angle to the other edge. Given that the corner is a right angle, what is the measure of the other angle?

For Exercises 5–7, use the following information.

Clyde looks at a building from point E . $\angle AEC$ has the same measure as $\angle BED$.

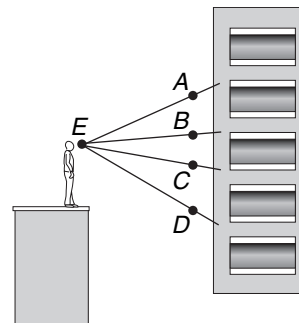

- The measure of $\angle AEC$ is equal to the sum of the measures of $\angle AEB$ and what other angle?
- The measure of $\angle BED$ is equal to the sum of the measures of $\angle CED$ and what other angle?
- Is it true that $m\angle AEB$ is equal to $m\angle CED$?

3-1 Word Problem Practice

Parallel Lines and Transversals

- 1. FIGHTERS** Two fighter aircraft fly at the same speed and in the same direction leaving a trail behind them. Describe the relationship between these two trails.

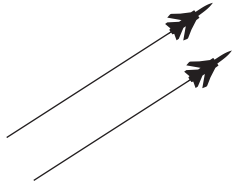

- 2. ESCALATORS** An escalator at a shopping mall runs up several levels. The escalator railing can be modeled by a straight line running past horizontal lines that represent the floors.

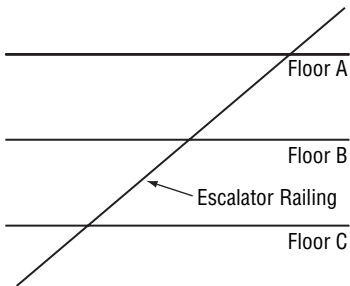

Describe the relationships of these lines.

- 3. DESIGN** Carol designed the picture frame shown below. How many pairs of parallel segments are there among various edges of the frame?

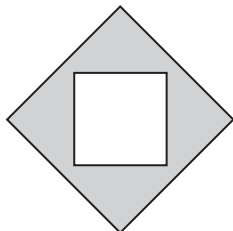

- 4. NEIGHBORHOODS** John, Georgia, and Phillip live nearby each other as shown in the map.

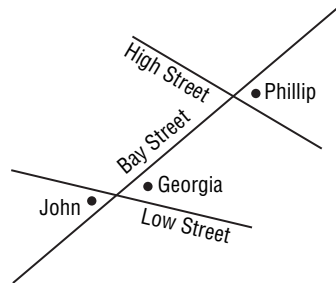

Describe how their corner angles relate to each other in terms of alternate interior, alternate exterior, corresponding, consecutive interior, or vertical angles.

MAPPING For Exercises 5 and 6, use the following figure.

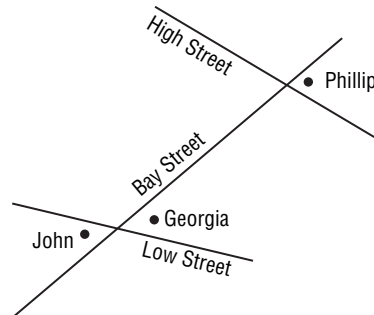

- 5.** Connor lives at the angle that forms an alternate interior angle with Georgia's residence. Add Connor to the map.
- 6.** Quincy lives at the angle that forms a consecutive interior angle with Connors' residence. Add Quincy to the map.

3-2 Word Problem Practice

Angles and Parallel Lines

- 1. RAMPS** A parking garage ramp rises to connect two horizontal levels of a parking lot. The ramp makes a 10° angle with the horizontal. What is the measure of angle 1 in the figure?

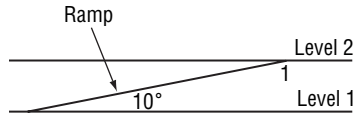

- 2. BRIDGES** A double decker bridge has two parallel levels connected by a network of diagonal girders. One of the girders makes a 52° angle with the lower level as shown in the figure. What is the measure of angle 1?

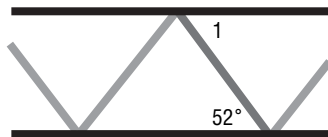

- 3. CITY ENGINEERING** Seventh Avenue runs perpendicular to both 1st and 2nd Streets, which are parallel. However, Maple Avenue makes a 115° angle with 2nd Street. What is the measure of angle 1?

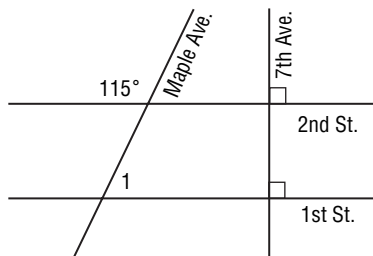

- 4. PODIUMS** A carpenter is building a podium. The side panel of the podium is cut from a rectangular piece of wood.

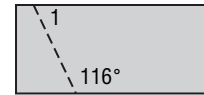

The rectangle must be sawed along the dashed line in the figure. What is the measure of angle 1?

SECURITY For Exercises 5 and 6, use the following information.

An important bridge crosses a river at a key location. Because it is so important, robotic security cameras are placed at the locations of the dots in the figure. Each robot can scan x degrees. On the lower bank, it takes 4 robots to cover the full angle from the edge of the river to the bridge. On the upper bank, it takes 5 robots to cover the full angle from the edge of the river to the bridge.

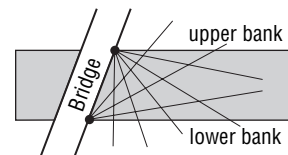

- 5.** How are the angles that are covered by the robots at the lower and upper banks related? Derive an equation that x satisfies based on this relationship.
- 6.** How wide is the scanning angle for each robot? What are the angles that the bridge makes with the upper and lower banks?

3-3 Word Problem Practice

Slopes of Lines

1. **HIGHWAYS** A highway on-ramp rises 15 feet for every 100 horizontal feet traveled. What is the slope of the ramp?

2. **DESCENT** An airplane descends at a rate of 300 feet for every 5000 horizontal feet that the plane travels. What is the slope of the path of descent?

3. **ROAD TRIP** Jenna is driving 400 miles to visit her grandmother. She manages to travel the first 100 miles of her trip in two hours. If she continues at this rate, how long will it take her to drive the remaining distance?

4. **WATER LEVEL** Before the rain began, the water in a lake was 268 inches deep. The rain began and after four hours of rain, the lake was 274 inches deep. The rain continued for one more hour at the same intensity. What was the depth of the lake when the rain stopped?

CITY BLOCKS For Exercises 5–8, use the following information.

The figure shows a map of part of a city consisting of two pairs of parallel roads. If a coordinate grid is applied to this map, Ford Street would have a slope of -3 .

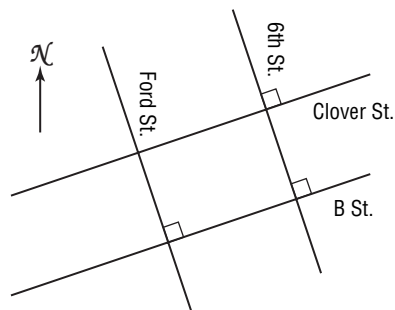

5. The intersection of B Street and Ford Street is 150 yards east of the intersection of Ford Street and Clover Street. How many yards south is it?

6. What is the slope of 6th Street? Explain.

7. What are the slopes of Clover and B Streets? Explain.

8. The intersection of B Street and 6th Street is 600 yards east of the intersection of B Street and Ford Street. How many yards north is it?

3-4 Word Problem Practice**Equations of Lines**

1. GROWTH At the same time each month over a one year period, John recorded the height of a tree he had planted. He then calculated the average growth rate of the tree. The height h in inches of the tree during this period was given by the formula $h = 1.7t + 28$, where t is the number of months. What are the slope and y -intercept of this line and what do they signify?

2. DRIVING Ellen is driving to a friend's house. The graph shows the distance (in miles) that Ellen was from home t minutes after she left her house.

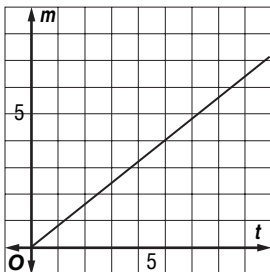

Write an equation that relates m and t .

3. COST Carla has a business that tests the air quality in artist's studios. She had to purchase \$750 worth of testing equipment to start her business. She charges \$50 to perform the test. Let n be the number of jobs she gets and let P be her net profit. Write an equation that relates P and n . How many jobs does she need to make \$750?

4. PAINT TESTING A paint company decided to test the durability of its white paint. They painted a square all white with their paint and measured the reflectivity of the square each year. Seven years after being painted, the reflectivity was 85%. Ten years after being painted, the reflectivity dropped to 82.9%. Assuming that the reflectivity decreases steadily with time, write an equation that gives the reflectivity R (as a percentage) as a function of time t in years. What is the reflectivity of a fresh coat of their white paint?

ARTISTRY For Exercises 5–7, use the following information.

Gail is an oil painter. She paints on canvases made from Belgian linen. Before she paints on the linen, she has to prime the surface so that it does not absorb the oil from the paint she uses. She can buy linen that has already been primed for \$21 per yard, or she can buy unprimed linen for \$15 per yard, but then she would also have to buy a jar of primer for \$30.

- Let P be the cost of Y yards of primed Belgian linen. Write an equation that relates P and Y .
- Let U be the cost of buying Y yards of unprimed linen and a jar of primer. Write an equation that relates U and Y .
- For how many yards would it be less expensive for Gail to buy the primed linen?

3-5

Word Problem Practice

Proving Lines Parallel

1. RECTANGLES Jim made a frame for a painting. He wants to check to make sure that opposite sides are parallel by measuring the angles at the corners and seeing if they are right angles. How many corners must he check in order to be sure that the opposite sides are parallel?

2. BOOKS The two gray books on the bookshelf each make a 70° angle with the base of the shelf.

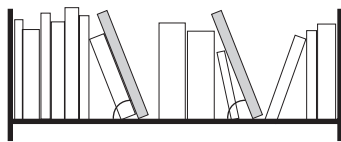

What more can you say about these two gray books?

3. PATTERNS A rectangle is cut along the slanted, dashed line shown in the figure. The two pieces are rearranged to form another figure. Describe as precisely as you can the shape of the new figure. Explain.

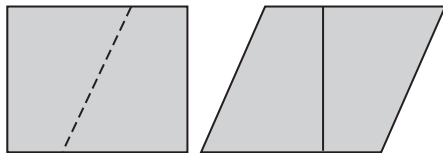

4. FIREWORKS A fireworks display is being readied for a celebration. The designers want to have four fireworks shoot out along parallel trajectories. They decide to place two launchers on a dock and the other two on the roof of a building.

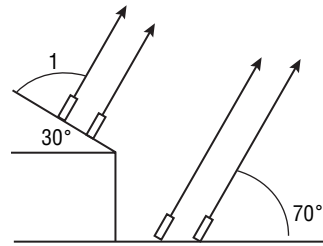

To pull off this display, what should the measure of angle 1 be?

SIGNS For Exercises 5 and 6, use the following information.

Harold is making a giant letter “A” to put on the rooftop of the “A is for Apple” Orchard Store. The figure shows a sketch of the design



5. What should the measures of angles 1 and 2 be so that the horizontal part of the “A” is truly horizontal?

6. When building the “A,” Harold makes sure that angle 1 is correct, but when he measures angle 2, it is not correct. What does this imply about the “A”?

3-6 Word Problem Practice

Perpendiculars and Distance

1. DISTANCE What does it mean if the distance between a point P and a line l is zero? What does it mean if the distance between two lines is zero?

2. DISTANCE Paul is standing in the schoolyard. The figure shows his distance from various classroom doors lined up along the same wall.

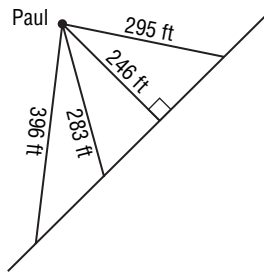

How far is Paul from the wall itself?

3. SEASHELLS Mason is standing on the seashore. He believes that if he makes a wish and throws a seashell back into the ocean, his wish will come true. Mason is standing at the origin of a coordinate plane and the shoreline is represented by the graph of the line $y = 1.5x + 13$. Each unit represents 1 meter. How far does Mason need to be able to throw the seashell to throw one into the ocean? Round your answer to the nearest centimeter.

4. SUPPORTS Two support beams are modeled by the lines $y = 2x + 10$ and $y = 2x + 15$. What is the distance between these two lines?

RESCUE For Exercises 5–7, use the following information.

Rachel sees a baseball heading straight for her friend Brad. Brad has no idea that he is about to be hit by a baseball.

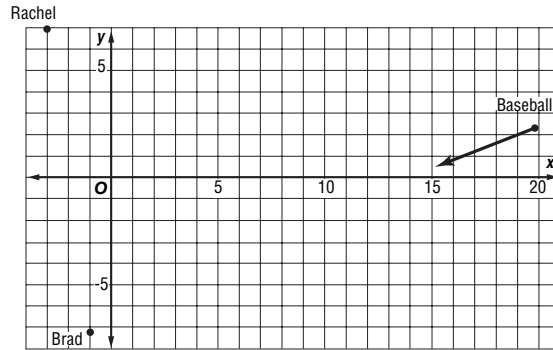

Rachel decides to run and intercept the baseball. Rachel is located at $(-3, 7)$. Brad is at $(-1, -6.25)$. The baseball is currently at $(20, 2.5)$ and closing fast.

5. What is the equation of the line that passes through Brad and the baseball?

6. If Rachel runs along the path of shortest distance to intercept (i.e. along the line perpendicular to the trajectory of the baseball), what are the coordinates of the point where she will end up when she is between Brad and the baseball?

7. What is the shortest distance that Rachel must run in order to get between her friend and the baseball?

4-1 Word Problem Practice

Classifying Triangles

1. MUSEUMS Paul is standing in front of a museum exhibition. When he turns his head 60° to the left, he can see a statue by Donatello. When he turns his head 60° to the right, he can see a statue by Della Robbia. The two statues and Paul form the vertices of a triangle. Classify this triangle as acute, right, or obtuse.

2. PAPER Marsha cuts a rectangular piece of paper in half along a diagonal. The result is two triangles. Classify these triangles as acute, right, or obtuse.

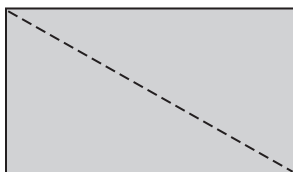

3. WATERSKIING Kim and Cassandra are waterskiing. They are holding on to ropes that are the same length and tied to the same point on the back of a speed boat. The boat is going full speed ahead and the ropes are fully taut.

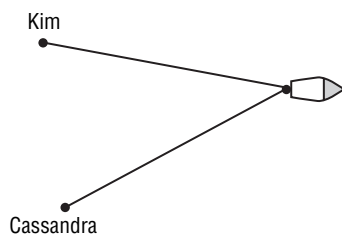

Kim, Cassandra, and the point where the ropes are tied on the boat form the vertices of a triangle. The distance between Kim and Cassandra is never equal to the length of the ropes. Classify the triangle as equilateral, isosceles, or scalene.

4. BOOKENDS Two bookends are shaped like right triangles.

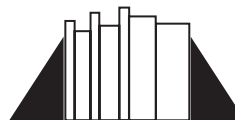

The bottom side of each triangle is exactly half as long as the slanted side of the triangle. If all the books between the bookends are removed and they are pushed together, they will form a single triangle. Classify the triangle that can be formed as equilateral, isosceles, or scalene.

DESIGNS For Exercises 5 and 6, use the following information.

Suzanne saw this pattern on a pentagonal floor tile. She noticed many different kinds of triangles were created by the lines on the tile.

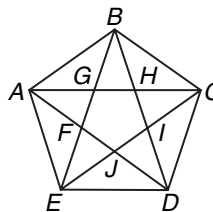

5. Identify five triangles that appear to be acute isosceles triangles.

6. Identify five triangles that appear to be obtuse isosceles triangles.

4-2 Word Problem Practice

Angles of Triangles

1. **PATHS** Eric walks around a triangular path. At each corner, he records the measure of the angle he creates.

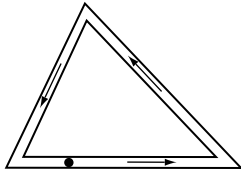

He makes one complete circuit around the path. What is the sum of the three angle measures that he wrote down?

2. **STANDING** Sam, Kendra, and Tony are standing in such a way that if lines were drawn to connect the friends they would form a triangle.

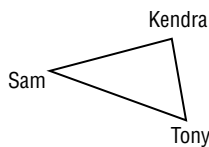

If Sam is looking at Kendra he needs to turn his head 40° to look at Tony. If Tony is looking at Sam he needs to turn his head 50° to look at Kendra. How many degrees would Kendra have to turn her head to look at Tony if she is looking at Sam?

3. **TOWERS** A lookout tower sits on a network of struts and posts. Leslie measured 2 angles on the tower.

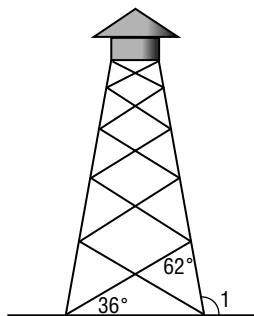

What is the measure of angle 1?

4. **ZOOS** The zoo lights up the chimpanzee pen with an overhead light at night. The cross section of the light beam makes an isosceles triangle.

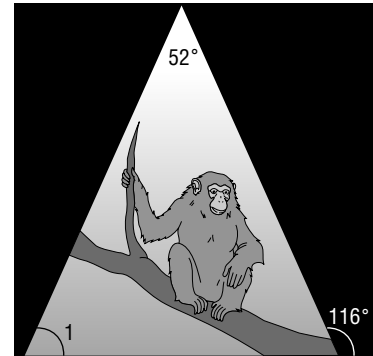

The top angle of the triangle is 52° and the exterior angle is 116° . What is the measure of angle 1?

DRAFTING For Exercises 5 and 6, use the following information.

Chloe bought a drafting table and set it up so that she can draw comfortably from her stool. Chloe measured the two angles created by the legs and the tabletop in case she had to dismantle the table.

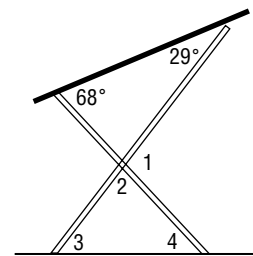

5. Which of the four numbered angles can Chloe determine by knowing the two angles formed with the tabletop? What are their measures?
6. What conclusion can Chloe make about the unknown angles before she measures them to find their exact measurements?

4-3 Word Problem Practice

Congruent Triangles

- 1. PICTURE HANGING** Candice hung a picture that was in a triangular frame on her bedroom wall.

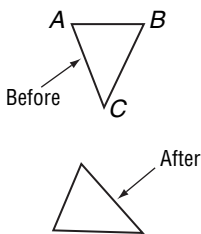

One day, it fell to the floor, but did not break or bend. The figure shows the object before and after the fall. Label the vertices on the frame after the fall according to the “before” frame.

- 2. SIERPINSKI’S TRIANGLE** The figure below is a portion of Sierpinski’s Triangle. The triangle has the property that any triangle made from any combination of edges is equilateral. How many triangles in this portion are congruent to the black triangle at the bottom corner?



- 3. QUILTING** Stefan drew this pattern for a piece of his quilt. It is made up of congruent isosceles right triangles. He drew one triangle and then repeatedly drew it all the way around.

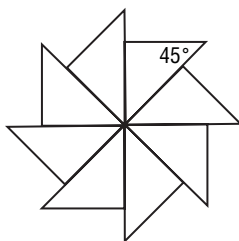

What are the missing measures of the angles of the triangle?

- 4. MODELS** Dana bought a model airplane kit. When he opened the box, these two congruent triangular pieces of wood fell out of it.

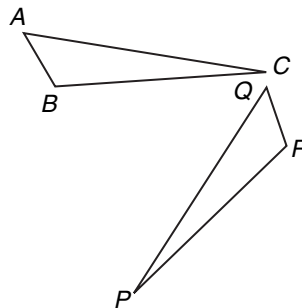

Identify the triangle that is congruent to $\triangle ABC$.

GEOGRAPHY For Exercises 5 and 6, use the following information.

Igor noticed on a map that the triangle whose vertices are the supermarket, the library, and the post office ($\triangle SLP$) is congruent to the triangle whose vertices are Igor’s home, Jacob’s home, and Ben’s home ($\triangle IJB$). That is, $\triangle SLP \cong \triangle IJB$.

- The distance between the supermarket and the post office is 1 mile. Which path along the triangle $\triangle IJB$ is congruent to this?
- The measure of $\angle LPS$ is 40. Identify the angle that is congruent to this angle in $\triangle IJB$.

4-4 Word Problem Practice**Proving Congruence—SSS, SAS**

1. STICKS Tyson had three sticks of lengths 24 inches, 28 inches, and 30 inches. Is it possible to make two noncongruent triangles using the same three sticks? Explain.

2. BAKERY Sonia made a sheet of baklava. She has markings on her pan so that she can cut them into large squares. After she cuts the pastry in squares, she cuts them diagonally to form two congruent triangles. Which postulate could you use to prove the two triangles congruent?

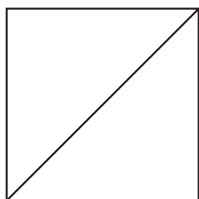

3. CAKE Carl had a piece of cake in the shape of an isosceles triangle with angles 26° , 77° , and 77° . He wanted to divide it into two equal parts, so he cut it through the middle of the 26° angle to the midpoint of the opposite side. He says that because he is dividing it at the midpoint of a side, the two pieces are congruent. Is this enough information? Explain.

4. TILES Tammy installs bathroom tiles. Her current job requires tiles that are equilateral triangles and all the tiles have to be congruent to each other. She has a big sack of tiles all in the shape of equilateral triangles. Although she knows that all the tiles are equilateral, she is not sure they are all the same size. What must she measure on each tile to be sure they are congruent? Explain.

INVESTIGATION For Exercises 5 and 6, use the following information.

An investigator at a crime scene found a triangular piece of torn fabric. The investigator remembered that one of the suspects had a triangular hole in their coat. Perhaps it was a match. Unfortunately, to avoid tampering with evidence, the investigator did not want to touch the fabric and could not fit it to the coat directly.

- 5.** If the investigator measures all three side lengths of the fabric and the hole, can the investigator make a conclusion about whether or not the hole could have been filled by the fabric?
- 6.** If the investigator measures two sides of the fabric and the included angle and then measures two sides of the hole and the included angle can he determine if it is a match? Explain.

4-5 Word Problem Practice**Proving Congruence—ASA, AAS**

1. DOOR STOPS Two door stops have cross-sections that are right triangles. They both have a 20° angle and the length of the side between the 90° and 20° angles are equal. Are the cross-sections congruent? Explain.

2. MAPPING Two people decide to take a walk. One person is in Bombay and the other is in Milwaukee. They start by walking straight for 1 kilometer. Then they both turn right at an angle of 110° , and continue to walk straight again. After a while, they both turn right again, but this time at an angle of 120° . They each walk straight for a while in this new direction until they end up where they started. Each person walked in a triangular path at their location. Are these two triangles congruent? Explain.

3. CONSTRUCTION The rooftop of Angelo's house creates an equilateral triangle with the attic floor. Angelo wants to divide his attic into 2 equal parts. He thinks he should divide it by placing a wall from the center of the roof to the floor at a 90° angle. If Angelo does this, then each section will share a side and have corresponding 90° angles. What else must be explained to prove that the two triangular sections are congruent?

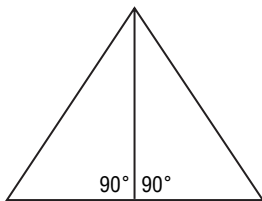

3. LOGIC When Carolyn finished her musical triangle class, her teacher gave each student in the class a certificate in the shape of a golden triangle. Each student received a different shaped triangle. Carolyn lost her triangle on her way home. Later she saw part of a golden triangle under a grate.

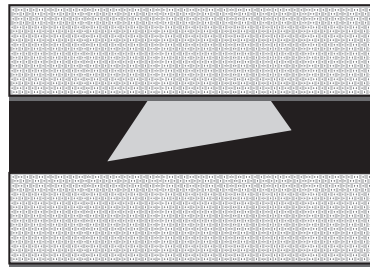

Is enough of the triangle visible to allow Carolyn determine that the triangle is indeed hers? Explain.

PARK MAINTENANCE For Exercises 5 and 6, use the following information.

Park officials need a triangular tarp to cover a field shaped like an equilateral triangle 200 feet on a side.

5. Suppose you know that a triangular tarp has two 60° angles and one side of length 200 feet. Will this tarp cover the field? Explain.

6. Suppose you know that a triangular tarp has three 60° angles. Will this tarp necessarily cover the field? Explain.

4-6

Word Problem Practice

Isosceles Triangles

- 1. TRIANGLES** At an art supply store, two different triangular rulers are available. One has angles 45° , 45° , and 90° . The other has angles 30° , 60° , and 90° . Which triangle is isosceles?

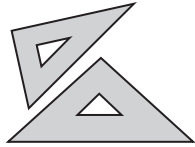

- 2. RULERS** A foldable ruler has two hinges that divide the ruler into thirds. If the ends are folded up until they touch, what kind of triangle results?

- 3. HEXAGONS** Juanita placed one end of each of 6 black sticks at a common point and then spaced the other ends evenly around that point. She connected the free ends of the sticks with lines. The result was a regular hexagon. This construction shows that a regular hexagon can be made from six congruent triangles. Classify these triangles. Explain.

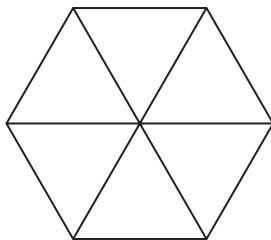

- 4. PATHS** A marble path is constructed out of several congruent isosceles triangles. The vertex angles are all 20° . What is the measure of angle 1 in the figure?

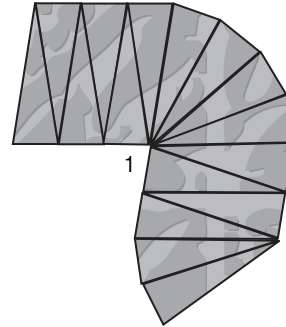

BRIDGES For Exercises 5–7, use the following information.

Every day, cars drive through isosceles triangles when they go over the Leonard Zakim Bridge in Boston. The ten-lane roadway forms the bases of the triangles.

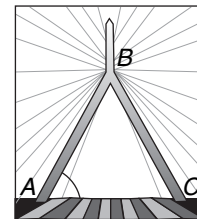

- 5.** The angle labeled A in the picture has a measure of 67° . What is the measure of $\angle B$?
- 6.** What is the measure of $\angle C$?
- 7.** Name the two congruent sides.

4-7 Word Problem Practice**Triangles and Coordinate Proof**

1. SHELVES Martha has a shelf bracket shaped like a right isosceles triangle. She wants to know the length of the hypotenuse relative to the sides. She does not have a ruler, but remembers the Distance Formula. She places the bracket on a coordinate grid with the right angle at the origin. The length of each leg is a . What are the coordinates of the vertices making the two acute angles?

2. FLAGS A flag is shaped like an isosceles triangle. A designer would like to make a drawing of the flag on a coordinate plane. She positions it so that the base of the triangle is on the y -axis with one endpoint located at $(0, 0)$. She locates the tip of the flag at $(a, \frac{b}{2})$. What are the coordinates of the third vertex?

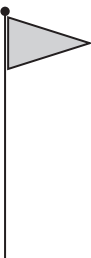

3. BILLIARDS The figure shows a situation on a billiard table.

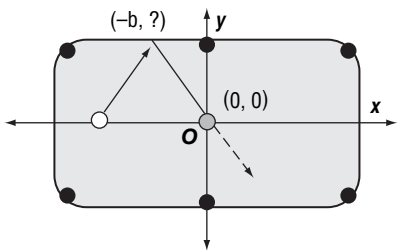

What are the coordinates of the cue ball before it is hit and the point where the cue ball hits the edge of the table?

4. TENTS The entrance to Matt's tent makes an isosceles triangle. If placed on a coordinate grid with the base on the x -axis and the left corner at the origin, the right corner would be at $(6, 0)$ and the vertex angle would be at $(3, 4)$. Prove that it is an isosceles triangle.

DRAFTING For Exercises 5–7, use the following information.

An engineer is designing a roadway. Three roads intersect to form a triangle. The engineer marks two points of the triangle at $(-5, 0)$ and $(5, 0)$ on a coordinate plane.

- Describe the set of points in the coordinate plane that could not be used as the third vertex of the triangle.
- Describe the set of points in the coordinate plane that would make the vertex of an isosceles triangle together with the two congruent sides.
- Describe the set of points in the coordinate plane that would make a right triangle with the other two points if the right angle is located at $(-5, 0)$.

5-1

Word Problem Practice

Bisectors, Medians, and Altitudes

1. BALANCING Johanna balanced a triangle flat on her finger tip. What point of the triangle must Johanna be touching?

2. PICNICS Marsha and Bill are going to the park for a picnic. The park is triangular. One side of the park is bordered by a river and the other two sides are bordered by busy streets. Marsha and Bill want to find a spot that is equally far away from the river and the streets. At what point in the park should they set up their picnic?

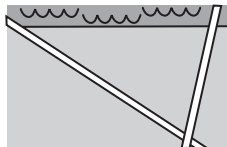

3. MOVING Martin has 3 grown children. The figure shows the locations of Martin's children on a map that has a coordinate plane on it. Martin would like to move to a location that is the same distance from all three of his children. What are the coordinates of the location on the map that is equidistant from all three children?

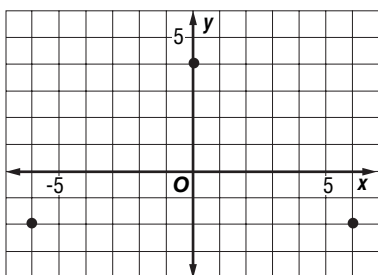

4. NEIGHBORHOOD Amanda is looking at her neighborhood map. She notices that her house along with the homes of her friends Brian, and Cathy can be the vertices of a triangle. The map is on a coordinate grid. Amanda's house is at the point $(1, 3)$ Brian's is at $(5, -1)$, and Cathy's is at $(4, 5)$. Where would the three friends meet if they each left their houses at the same time and walked to the opposite side of the triangle along the path of shortest distance from their house?

PLAZAS For Exercises 5–7, use the following information.

An architect is designing a triangular plaza. For aesthetic purposes, the architect pays special attention to the location of the centroid C and the circumcenter O .

- 5.** Give an example of a triangular plaza where $C = O$. If no such example exists, state that this is *impossible*.
- 6.** Give an example of a triangular plaza where C is inside the plaza and O is outside the plaza. If no such example exists, state that this is *impossible*.
- 7.** Give an example of a triangular plaza where C is outside the plaza and O is inside the plaza. If no such example exists, state that this is *impossible*.

5-2

Word Problem Practice

Inequalities and Triangles

1. DISTANCE Carl and Rose live on the same straight road. From their balconies they can see a flagpole in the distance. The angle that each person's line of sight to the flagpole makes with the road is the same. How do their distances from the flagpole compare?

2. OBTUSE TRIANGLES Don notices that the side opposite the right angle in a right triangle is always the longest of the three sides. Is this also true of the side opposite the obtuse angle in an obtuse triangle? Explain.

3. STRING Jake built a triangular structure with three black sticks. He tied one end of a string to vertex *M* and the other end to a point on the stick opposite *M*, pulling the string taut. Prove that the length of the string cannot exceed the longer of the two sides of the structure.

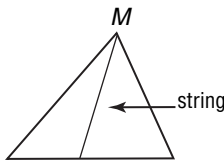

4. SQUARES Matthew has three different squares. He arranges the squares to form a triangle as shown. Based on the information, list the squares in order from the one with the smallest perimeter to the one with the largest perimeter.

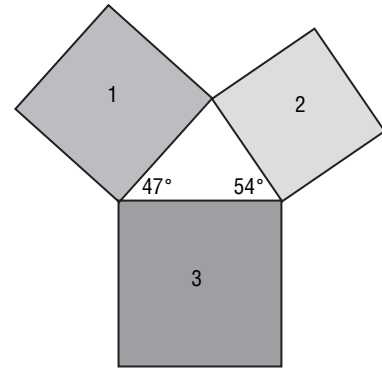

CITIES For Exercises 5 and 6, use the following information.

Stella is going to Texas to visit a friend. As she was looking at a map to see where she might want to go, she noticed the cities Austin, Dallas, and Abilene formed a triangle. She wanted to determine how the distances between the cities were related, so she used a protractor to measure two angles.

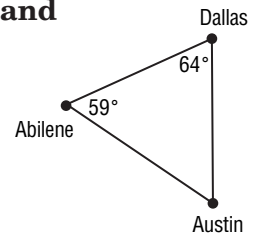

- 5.** Based on the information in the figure, which of the two cities are nearest to each other?
- 6.** Based on the information in the figure, which of the two cities are farthest apart from each other?

5-3 Word Problem Practice**Indirect Proof**

1. CANOES Thirty-five students went on a canoeing expedition. They rented 17 canoes for the trip. Use an indirect proof to show that at least one canoe had more than two students in it.

2. AREA The area of the United States is about 6,000,000 square miles. The area of Hawaii is about 11,000 square miles. Use an indirect proof to show that at least one of the fifty states has an area greater than 120,000 square miles.

3. CONSECUTIVE NUMBERS David was trying to find a common factor other than 1 between various pairs of consecutive integers. Write an indirect proof to show David that two consecutive integers do not share a common factor other than 1.

4. WORDS The words *accomplishment*, *counterexample*, and *extemporaneous* all have 14 letters. Use an indirect proof to show that any word with 14 letters must use a repeated letter or have two letters that are consecutive in the alphabet.

LATTICE TRIANGLES For Exercises 5 and 6, use the following information.

A *lattice point* is a point whose coordinates are both integers. A lattice triangle is a triangle whose vertices are lattice points. It is a fact that a lattice triangle has an area of at least 0.5 square units.

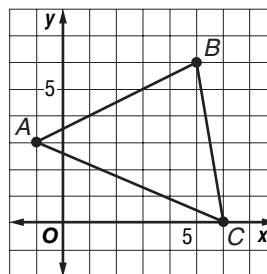

5. Suppose $\triangle ABC$ has a lattice point in its interior. Show that the lattice triangle can be partitioned into three smaller lattice triangles.

6. Prove indirectly that a lattice triangle with area 0.5 square units contains no lattice point. (Being on the boundary does not count as inside.)

5-4

Word Problem Practice

The Triangle Inequality

1. **STICKS** Jamila has 5 sticks of lengths 2, 4, 6, 8, and 10 inches. Using three sticks at a time as the sides of triangles, how many triangles can she make?

Use the figure at the right for Exercises 2 and 3.

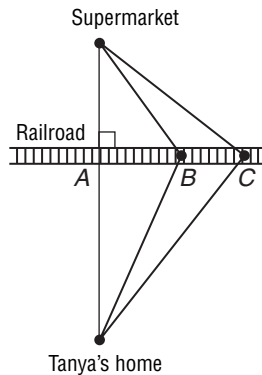

2. **PATHS** To get to the nearest supermarket, Tanya must walk over a railroad track. There are two places where she can cross the track (points A and B). Which path is longer? Explain.

3. **PATHS** While out walking one day Tanya finds a third place to cross the railroad tracks. Show that the path through point C is longer than the path through point B.

4. **CITIES** The distance between New York City and Boston is 187 miles and the distance between New York City and Hartford is 97 miles. Hartford, Boston, and New York City form a triangle on a map. What must the distance between Boston and Hartford be greater than?

TRIANGLES For Exercises 5–7, use the following information.

The figure shows an equilateral triangle ABC and a point P outside the triangle.

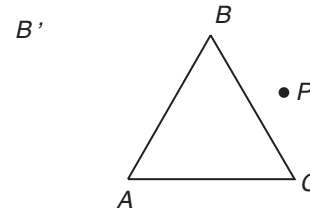

5. Draw the figure that is the result of turning the original figure 60° counterclockwise about A. Denote by P' , the image of P under this turn.
6. Note that $\overline{P'B}$ is congruent to \overline{PC} . It is also true that $\overline{PP'}$ is congruent to \overline{PA} . Why?
7. Show that \overline{PA} , \overline{PB} , and \overline{PC} satisfy the triangle inequalities.

5-5 Word Problem Practice

Inequalities Involving Two Triangles

- 1. CLOCKS** The minute hand of a grandfather clock is 3 feet long and the hour hand is 2 feet long. Is the distance between their ends greater at 3:00 or at 8:00?

- 2. FERRIS WHEEL** A Ferris wheel has carriages located at the 10 vertices of a regular decagon.

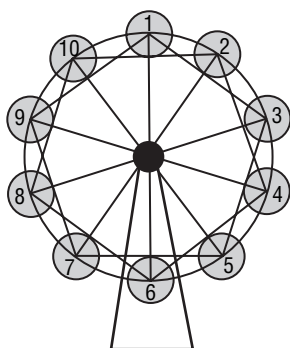

Which carriages are farther away from carriage number 1 than carriage number 4?

- 3. WALKWAY** Tyree wants to make two slightly different triangles for his walkway. He has three pieces of wood to construct the frame of his triangles. After Tyree makes the first concrete triangle, he adjusts two sides of the triangle so that the angle they create is smaller than the angle in the first triangle. Explain how this changes the triangle.

- 4. MOUNTAIN PEAKS** Emily lives the same distance from three mountain peaks: High Point, Topper, and Cloud Nine. For a photography class, Emily must take a photograph from her house that shows two of the mountain peaks. Which two peaks would she have the best chance of capturing in one image?

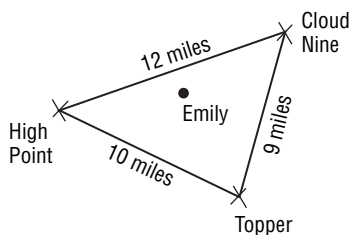

- RUNNERS** For Exercises 5 and 6, use the following information.

A photographer is taking pictures of three track stars, Amy, Noel, and Beth. The photographer stands on a track, which is shaped like a rectangle with semicircles on both ends.

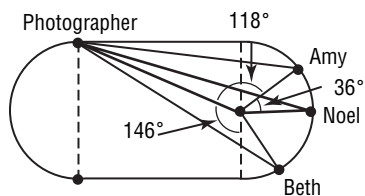

- 5.** Based on the information in the figure, list the runners in order from nearest to farthest from the photographer.
- 6.** Explain how to locate the point along the semicircular curve that the runners are on that is farthest away from the photographer.

6-1

Word Problem Practice

Angles of Polygons

- 1. ARCHITECTURE** In the Uffizi gallery in Florence, Italy, there is a room built by Buontalenti called the Tribune (*La Tribuna* in Italian). This room is shaped like a regular octagon.

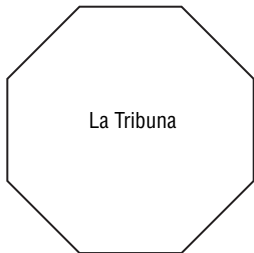

What angle do consecutive walls of the Tribune make with each other?

- 2. BOXES** Jasmine is designing boxes she will use to ship her jewelry. She wants to shape the box like a regular polygon. In order for the boxes to pack tightly, she decides to use a regular polygon that has the property that the measure of its interior angles is half the measure of its exterior angles. What regular polygon should she use?

- 3. THEATER** A theater floor plan is shown in the figure. The upper five sides are part of a regular dodecagon.

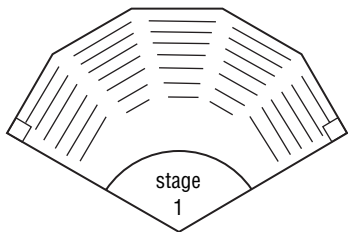

Find $m\angle 1$.

- 4. ARCHEOLOGY** Archeologists unearthed parts of two adjacent walls of an ancient castle.



Before it was unearthed, they knew from ancient texts that the castle was shaped like a regular polygon, but nobody knew how many sides it had. Some said 6, others 8, and some even said 100. From the information in the figure, how many sides did the castle really have?

POLYGON PATH For Exercises 5–7, use the following information.

In Ms. Ricketts' math class, students made a "polygon path" that consists of regular polygons of 3, 4, 5, and 6 sides joined together as shown.

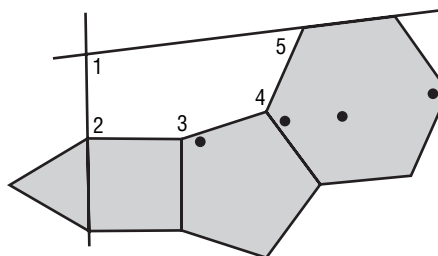

5. Find $m\angle 2$ and $m\angle 5$.
6. Find $m\angle 3$ and $m\angle 4$.
7. What is $m\angle 1$?

6-2

Word Problem Practice

Parallelograms

1. **WALKWAY** A walkway is made by adjoining four parallelograms as shown.

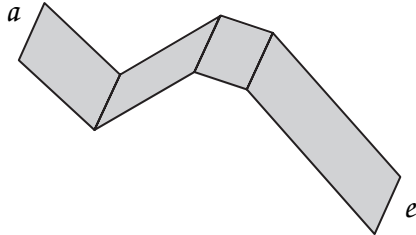

Are the end segments a and e parallel to each other? Explain.

2. **DISTANCE** Gracie, Kenny, Teresa, and Travis live at the four corners of block shaped like a parallelogram. Gracie lives 3 miles away from Kenny. How far apart do Teresa and Travis live from each other?

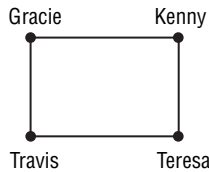

3. **SOCCER** Four soccer players are located at the corners of a parallelogram. Two of the players in opposite corners are the goalies. In order for goalie A to be able to see the three others, she must be able to see a certain angle x in her field of vision.

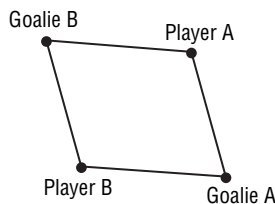

What angle does the other goalie have to be able to see in order to keep an eye on the other three players?

4. **VENN DIAGRAMS** Make a Venn diagram showing the relationship between squares, rectangles, and parallelograms.

SKYSCRAPERS For Exercises 5 and 6, use the following information.

On vacation, Tony's family took a helicopter tour of the city. The pilot said the newest building in the city was the building with this top view. He told Tony that the exterior angle by the front entrance is 72° . Tony wanted to know more about the building, so he drew this diagram and used his geometry skills to learn a few more things. The front entrance is next to vertex B .

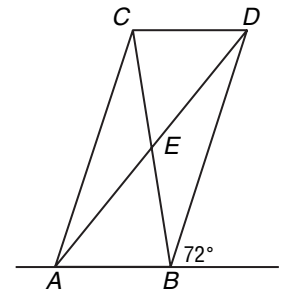

5. What are the measures of the four angles of the parallelogram?
6. How many pairs of congruent triangles are there in the figure? What are they?

6-3 Word Problem Practice

Tests for Parallelograms

- 1. BALANCING** Nikia, Madison, Angela, and Shelby are balancing themselves on an “X”-shaped floating object. To balance themselves, they want to make themselves the vertices of a parallelogram.

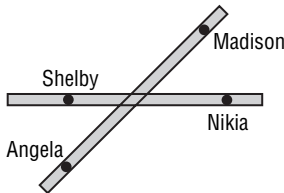

In order to achieve this, do all four of them have to be the same distance from the center of the object? Explain.

- 2. COMPASSES** Two compass needles placed side by side on a table are both 2 inches long and point due north. Do they form the sides of a parallelogram?
- 3. FORMATION** Four jets are flying in formation. Three of the jets are shown in the graph. If the four jets are located at the vertices of a parallelogram, what are the three possible locations of the missing jet?

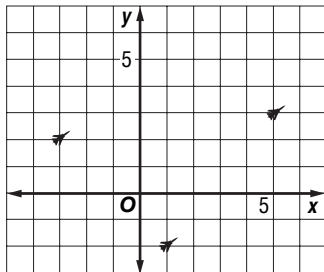

- 4. STREET LAMPS** When a coordinate plane is placed over the Harrisville town map, the four street lamps in the center are located as shown. Do the four lamps form the vertices of a parallelogram? Explain.

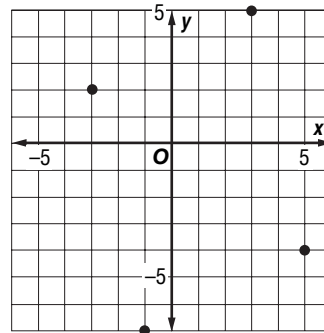

PICTURE FRAME For Exercises 5–7, use the following information.

Aaron is making a wooden picture frame in the shape of a parallelogram. He has two pieces of wood that are 3 feet long and two that are 4 feet long.

- 5.** If he connects the pieces of wood at their ends to each other, in what order must he connect them to make a parallelogram?
- 6.** How many different parallelograms could he make with these four lengths of wood?
- 7.** Explain something Aaron might do to specify precisely the shape of the parallelogram.

6-4

Word Problem Practice

Rectangles

- 1. FRAMES** Jalen makes the rectangular frame shown

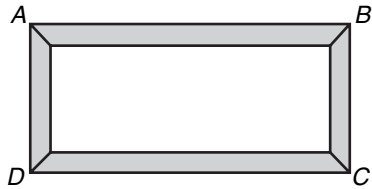

In order to make sure that it is a rectangle, Jalen measures the distances BD and AC . How should these two distances compare if the frame is a rectangle?

- 2. BOOKSHELFS** A bookshelf consists of two vertical planks with five horizontal shelves. Are each of the four sections for books rectangles? Explain.



- 3. LANDSCAPER** A landscaper is marking off the corners of a rectangular plot of land. Three of the corners are in place as shown.

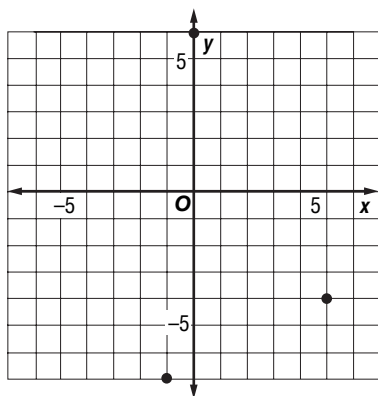

What are the coordinates of the fourth corner?

- 4. SWIMMING POOLS** Antonio is designing a swimming pool on a coordinate grid. Is it a rectangle? Explain.

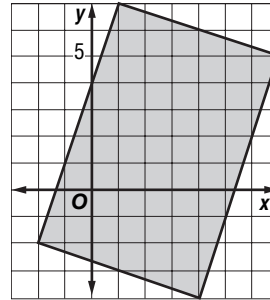

- PATTERNS** For Exercises 5 and 6, use the following information.

Veronica made the pattern shown out of 7 rectangles with four equal sides. The side length of each rectangle is written inside the rectangle.

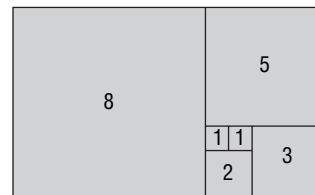

- 5.** How many rectangles can be formed using the lines in this figure?
- 6.** If Veronica wanted to extend her pattern by adding another rectangle with 4 equal sides to make a larger rectangle, what are the possible side lengths of rectangles that she can add?

6-5 Word Problem Practice

Rhombi and Squares

- 1. TRAY RACKS** A tray rack looks like a parallelogram from the side. The levels for the trays are evenly spaced.

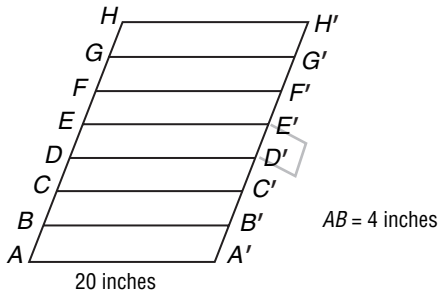

What two labeled points form a rhombus with base AA' ?

- 2. SLICING** Charles cuts a rhombus along both diagonals. He ends up with four congruent triangles. Classify these triangles as acute, obtuse, or right.

- 3. WINDOWS** The edges of a window are drawn in the coordinate plane.

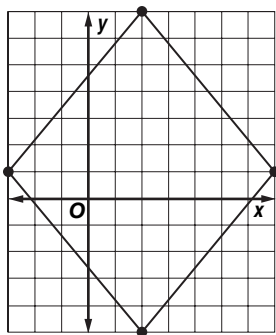

Determine whether the window is a square or a rhombus.

- 4. SQUARES** Mackenzie cut a square along its diagonals to get four congruent right triangles. She then joined two of them along their long sides. Show that the resulting shape is a square.

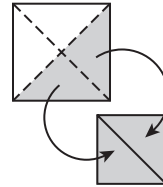

DESIGN For Exercises 5 and 6, use the following information.

Tatianna made the design shown. She used 32 congruent rhombi to create the flower-like design at each corner.

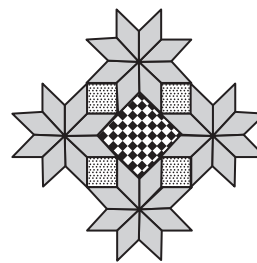

- What are the angles of the corner rhombi?
- What kinds of quadrilaterals are the dotted and checkered figures?

6-6 Word Problem Practice

Trapezoids

1. PERSPECTIVE Artists use different techniques to make things appear to be 3-dimensional when drawing in two dimensions. Kevin drew the walls of a room. In real life, all of the walls are rectangles. In what shape did he draw the side walls to make them appear 3-dimensional?

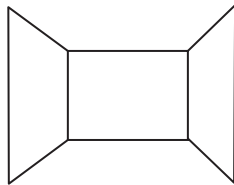

2. PLAZA In order to give the feeling of spaciousness, an architect decides to make a plaza in the shape of an isosceles trapezoid. Three of the four corners of the plaza are shown in the coordinate plane. If the fourth corner is in the first quadrant, what are its coordinates?

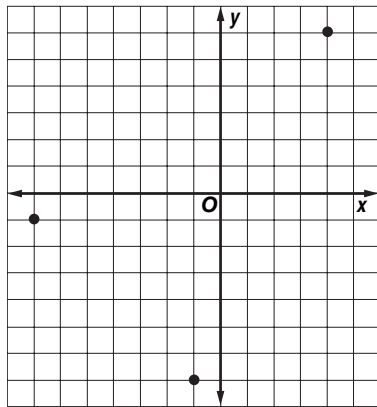

3. AIRPORTS A simplified drawing of the reef runway complex at Honolulu International Airport is shown below.

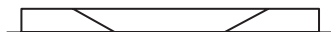

How many trapezoids are there in this image?

4. LIGHTING A light outside a room shines through the door and illuminates a trapezoidal region $ABCD$ on the floor.



Under what circumstances would trapezoid $ABCD$ be isosceles?

RISERS For Exercises 5 and 6, use the following information.

A riser is designed to elevate a speaker. The riser consists of 4 trapezoidal sections that can be stacked one on top of the other to produce trapezoids of varying heights.

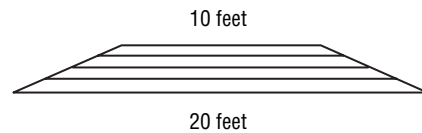

All of the stages have the same height. If all four stages are used, the width of the top of the riser is 10 feet.

5. If only the bottom two stages are used, what is the width of the top of the resulting riser?
6. What would be the width of the riser if the bottom three stages are used?

6-7

Word Problem Practice

Coordinate Proof and Quadrilaterals

1. DRAFTING An engineer is making a drawing of an isosceles trapezoid in a coordinate plane. She places three of the vertices at $(0, 0)$, $(a, 0)$, and (b, c) , where $0 < b < 0.5a$ and $c > 0$. Where in the first quadrant can she place the fourth point?

2. ZIGZAGS If the zigzag pattern of parallelograms is continued by adding one more parallelogram to the right, what would be the coordinates of the new parallelogram's vertices?

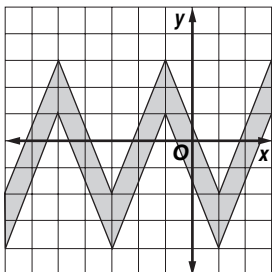

3. SUPPORTS The four plotted points represent the locations of four support columns for a building.

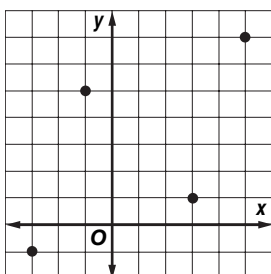

Classify the quadrilateral whose vertices are at these four points. Explain.

4. SQUARES Prove that the quadrilateral with vertices (a, b) , $(-b, a)$, $(-a, -b)$, and $(b, -a)$ is a square, where a and b are positive numbers.

AXES For Exercises 5–7, use the following information.

Sara used a geometry program to draw quadrilateral $ABCD$ on a coordinate graph that did not have any other lines except the x -axis and y -axis. She was able to drag the vertices to create different quadrilaterals. Let a , b , c , and d be positive integers and consider the points $A = (a, 0)$, $B = (0, b)$, $C = (-c, 0)$, and $D = (0, -d)$.

5. Describe the conditions of a , b , c , and d so that quadrilateral $ABCD$ is a square.

6. Describe the conditions of a , b , c , and d so that quadrilateral $ABCD$ is a rhombus.

7. Describe the conditions of a , b , c , and d so that quadrilateral $ABCD$ is an isosceles trapezoid.

7-1 Word Problem Practice

Proportions

- 1. MODELS** Luke wants to make a scale model of a Boeing 747 jetliner. He wants every foot of his model to represent 50 feet. Complete the following table.

Part	Actual length (in.)	Model length (in.)
Wing Span	2,537	
Length	2,782	
Tail Height	392	7.84

(Source: www.boeing.com)

- 2. RATIOS** Sixteen students went on a week-long hiking trip. They brought with them 320 specially baked, protein-rich, cookies. What is the ratio of cookies to students?
- 3. PHOTOGRAPHS** Tracy is 4 feet tall and her father is 6 feet tall. In a photograph of the two of them standing side by side, Tracy's image is 2 inches tall.

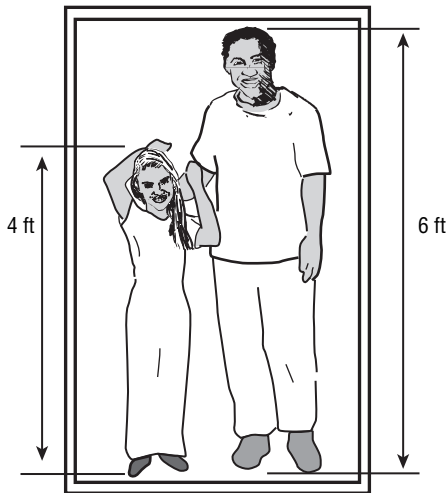

Although their images are much smaller, the ratio of their heights remains the same. How tall is Tracy's father's image in the photo?

- 4. CARS** A car company builds two versions of one of its models—a sedan and a station wagon. The ratio of sedans to station wagons is 11 : 2. A freighter begins unloading the cars at a dock. Tom counts 18 station wagons and then overhears a dock worker call out, "Okay, that's all of the wagons . . . bring out the sedans!" How many sedans were on the ship?

MAPS For Exercises 5–7, use the following information.

Carlos makes a map of his neighborhood for a presentation. The scale of his map is 1 inch : 125 feet.

- 5.** How many feet do 4 inches represent on the map?
- 6.** Carlos lives 250 feet away from Andrew. How many inches separate Carlos' home from Andrew's on the map?
- 7.** During a practice run in front of his parents, Carlos realizes that his map is far too small. He decides to make his map 5 times as large. What would be the scale of the larger map?

7-2 Word Problem Practice

Similar Polygons

- 1. PANELS** When closed, an entertainment center is made of four square panels. The three smaller panels are congruent squares.

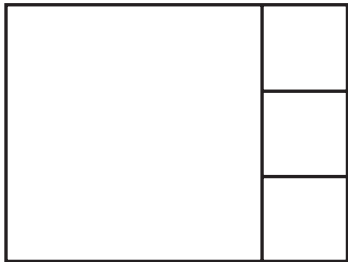

What is the scale factor of the larger square to one of the smaller squares?

- 2. DOWNSPOUTS** During a storm, one of the downspouts on Mr. Herrera's house was broken and needed to be replaced. Unfortunately, the downspout was too damaged to measure its length and it was too difficult to measure the height of the gutter. Luckily, Mr. Herrera had a scale model of his house. If the downspout in the model was $1\frac{1}{2}$ feet long and the scale factor was 20, how long was the actual downspout?
- 3. ORIGAMI** Baxter uses an 8-inch square piece of origami paper to make an origami model of a chicken. When finished, the chicken stands 4 inches high. Baxter wants to make another origami chicken, only this time he wants to make it 12 inches high instead. What size piece of paper should he use to do this?

- 4. ENLARGING** Camille wants to make a pattern for a four-pointed star with dimensions twice as long as the one shown. Help her by drawing a star with dimensions twice as long on the grid below.

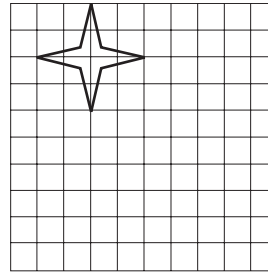

BIOLOGY For Exercises 5–7, use the following information.

A paramecium is a small single-cell organism. The paramecium magnified below is actually one tenth of a millimeter long.

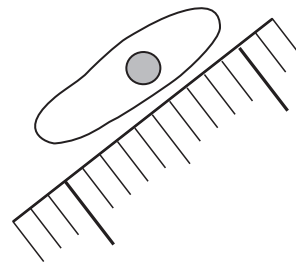

- 5.** If you want to make a photograph of the original paramecium so that its image is 1 centimeter long, by what scale factor should you magnify it?
- 6.** If you want to make a photograph of the original paramecium so that its image is 15 centimeters long, by what scale factor should you magnify it?
- 7.** By approximately what scale factor has the paramecium been enlarged to make the image shown?

7-3 Word Problem Practice

Similar Triangles

- 1. MINIATURES** Marla likes her chair so much that she decides to make a miniature replica of it for her pet hamster. Find the value of x .

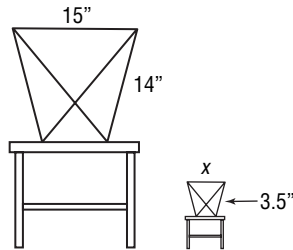

- 2. MODELS** Jim has a scale model of his sailboat. The figure shows drawings of the original sailboat and the model. Find x .

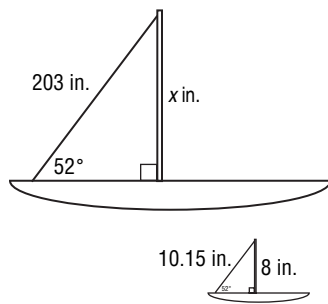

- 3. GEOMETRY** Georgia draws a regular pentagon and starts connecting its vertices to make a 5-pointed star. After drawing three of the lines in the star, she becomes curious about two triangles that appear in the figure, $\triangle ABC$ and $\triangle BCE$. They look similar to her. Prove that this is the case.

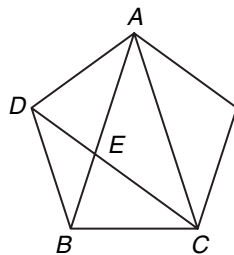

- 4. SHADOWS** A radio tower casts a shadow 8 feet long at the same time that a vertical yardstick casts a shadow half an inch long. How tall is the radio tower?

MOUNTAIN PEAKS For Exercises 5 and 6, use the following information.

Gavin and Brianna want to know how far a mountain peak is from their houses. They measure the angles between the line of site to the peak and to each other's houses and carefully make the drawing shown.

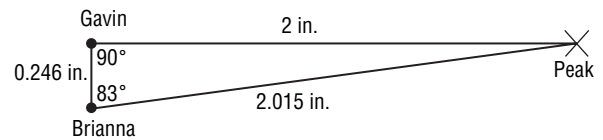

The actual distance between Gavin and Brianna's house is $1\frac{1}{2}$ miles.

- 5.** What is the actual distance of the mountain peak from Gavin's house? Round your answer to the nearest tenth of a mile.
- 6.** What is the actual distance of the mountain peak from Brianna's house? Round your answer to the nearest tenth of a mile.

7-4 Word Problem Practice

Parallel Lines and Proportional Parts

- 1. CARPENTRY** Jake is fixing an A-frame. He wants to add a horizontal support beam halfway up and parallel to the ground. How long should this beam be?

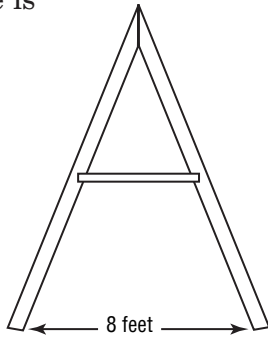

- 2. STREETS** In the diagram, Cay Street and Bay Street are parallel. Find x .

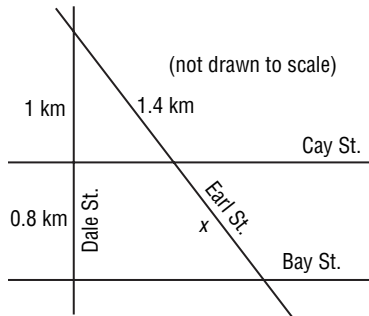

- 3. JUNGLE GYMS** Prassad is building a two-story jungle gym according to the plans shown. Find x .

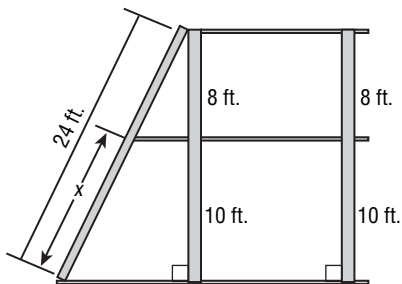

- 4. FIREMEN** A cat is stuck in a tree and firemen try to rescue it. Based on the figure, if a fireman climbs to the top of the ladder, how far away is the cat?

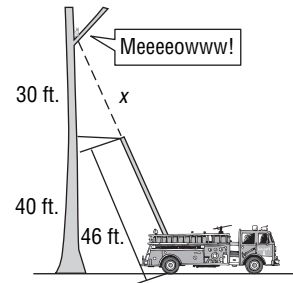

EQUAL PARTS For Exercises 5 and 6, use the following information.

Nick has a stick that he would like to divide into 9 equal parts. He places it on a piece of grid paper as shown. The grid paper is ruled so that vertical and horizontal lines are equally spaced.

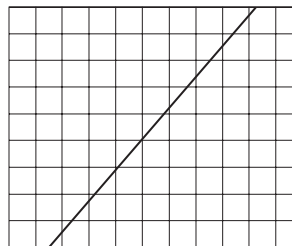

- 5.** Explain how he can use the grid paper to help him find where he needs to cut the stick.
- 6.** Suppose Nick wants to divide his stick into 5 equal parts utilizing the grid paper. What can he do?

7-5 Word Problem Practice

Parts of Similar Triangles

1. JOGGING Macy wants to jog around Triangle Park. On a scale map, the park has a perimeter of 11 inches. The scale of the map is 1 inch : 100 yards. What is the perimeter of the actual park?

2. TENTS Jana went camping and stayed in a tent shaped like a triangle. In a photo of the tent, the base of the tent is 6 inches and the altitude is 5 inches. The actual base was 12 feet long. What was the height of the actual tent?

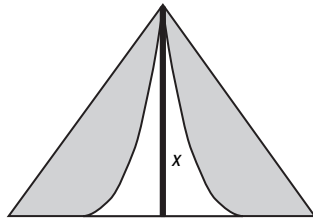

3. PLAYGROUND The playground at Hank's school has a large right triangle painted in the ground. Hank starts at the right angle corner and walks toward the opposite side along an angle bisector and stops when he gets to the hypotenuse.

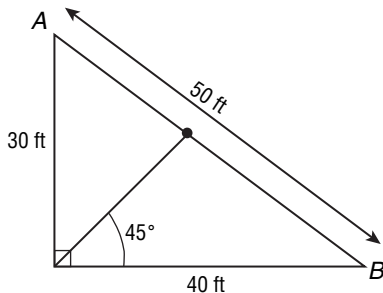

How much farther from Hank is point B versus point A ?

4. FLAG POLES A flag pole attached to the side of a building is supported with a network of strings as shown in the figure.

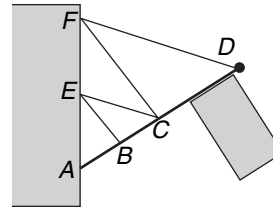

The rigging is done so that $AE = EF$, $AC = CD$, and $AB = BC$. What is the ratio of CF to BE ?

COPIES For Exercises 5 and 6, use the following information.

Gordon made a photocopy of a page from his geometry book to enlarge one of the figures. The actual figure that he copied is shown below.

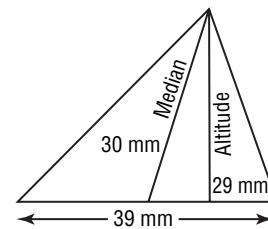

The photocopy came out poorly. Gordon could not read the numbers on the photocopy, although the triangle itself was clear. Gordon measured the base of the enlarged triangle and found it to be 200 millimeters.

- What is the length of the drawn altitude of the enlarged triangle? Round your answer to the nearest millimeter.
- What is the length of the drawn median of the enlarged triangle? Round your answer to the nearest millimeter.

8-1 Word Problem Practice

Geometric Mean

1. **SQUARES** Wilma has a rectangle of dimensions ℓ by w . She would like to replace it with a square that has the same area. What is the side length of the square with the same area as Wilma's rectangle?

2. **EQUALITY** Gretchen computed the geometric mean of two numbers. One of the numbers was 7 and the geometric mean turned out to be 7 as well. What was the other number?

3. **VIEWING ANGLE** A photographer wants to take a picture of a beach front. His camera has a viewing angle of 90° and he wants to make sure two palm trees located at points A and B in the figure are just inside the edges of the photograph.

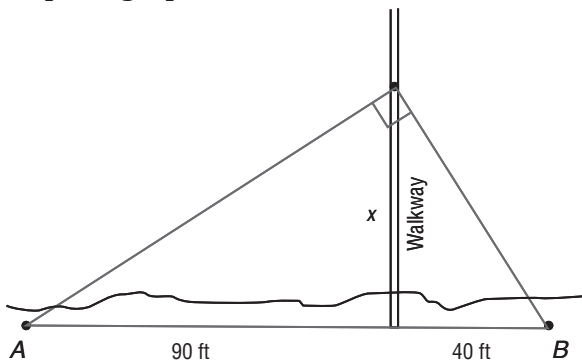

He walks out on a walkway that goes over the ocean to get the shot. If his camera has a viewing angle of 90° , at what distance down the walkway should he stop to take his photograph?

4. **EXHIBITIONS** A museum has a famous statue on display. The curator places the statue in the corner of a rectangular room and builds 15-foot-long railing in front of the statue. Use the information below to find how close visitors will be able to get to the statue.

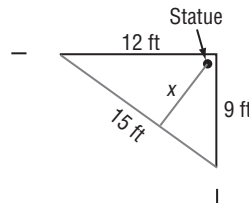

CLIFFS For Exercises 5–7, use the following information.

A bridge connects to a tunnel as shown in the figure. The bridge is 180 feet above the ground. At a distance of 235 feet along the bridge out of the tunnel, the angle to the base and summit of the cliff is a right angle.

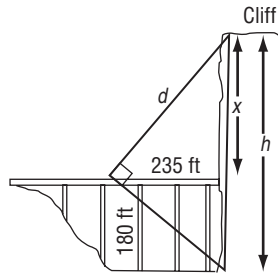

- What is the height of the cliff? Round to the nearest whole number.
- How high is the cliff from base to summit? Round to the nearest whole number.
- What is d ? Round to the nearest whole number.

8-2 Word Problem Practice

The Pythagorean Theorem and Its Converse

- SIDEWALKS** Construction workers are building a marble sidewalk around a park that is shaped like a right triangle. Each marble slab adds 2 feet to the length of the sidewalk. The workers find that exactly 1071 and 1840 slabs are required to make the sidewalks along the short sides of the park. How many slabs are required to make the sidewalk that runs along the long side of the park?
- RIGHT ANGLES** Clyde makes a triangle using three sticks of lengths 20 inches, 21 inches, and 28 inches. Is the triangle a right triangle? Explain.
- TETHERS** To help support a flag pole, a 50-foot-long tether is tied to the pole at a point 40 feet above the ground. The tether is pulled taut and tied to an anchor in the ground. How far away from the base of the pole is the anchor?
- FLIGHT** An airplane lands at an airport 60 miles east and 25 miles north of where it took off.

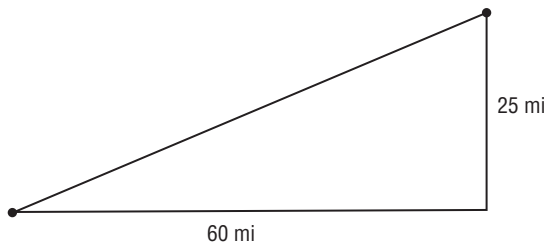

How far apart are the two airports?

PYTHAGOREAN TRIPLES For Exercises 5–7, use the following information.

Ms. Jones assigned her fifth-period geometry class the following problem.

Let m and n be two positive integers with $m > n$. Let $a = m^2 - n^2$, $b = 2mn$, and $c = m^2 + n^2$.

- Show that there is a right triangle with side lengths a , b , and c .

- Complete the following table.

m	n	a	b	c
2	1	3	4	5
3	1			
3	2			
4	1			
4	2			
4	3			
5	1			

- Find a Pythagorean triple that corresponds to a right triangle with a hypotenuse $25^2 = 625$ units long. (*Hint:* Use the table you completed for Exercise 6 to find two positive integers m and n with $m > n$ and $m^2 + n^2 = 625$.)

8-3 Word Problem Practice

Special Right Triangles

- ORIGAMI** A square piece of paper 150 millimeters on a side is folded in half along a diagonal. The result is a 45° - 45° - 90° triangle. What is the length of the hypotenuse of this triangle?
- ESCALATORS** A 40-foot-long escalator rises from the first floor to the second floor of a shopping mall. The escalator makes a 30° angle with the horizontal.

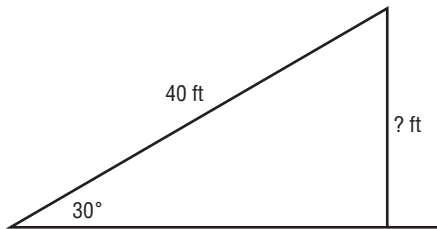

How high above the first floor is the second floor?

- HEXAGONS** A box of chocolates shaped like a regular hexagon is placed snugly inside of a rectangular box as shown in the figure.

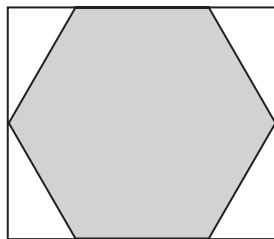

If the side length of the hexagon is 3 inches, what are the dimensions of the rectangular box?

- WINDOWS** A large stained glass window is constructed from six 30° - 60° - 90° triangles as shown in the figure.

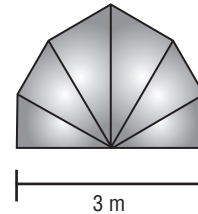

What is the height of the window?

MOVIES For Exercises 5–7, use the following information.

Kim and Yolanda are watching a movie in a movie theater. Yolanda is sitting x feet from the screen and Kim is 15 feet behind Yolanda.

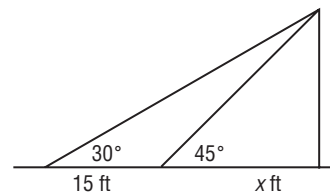

The angle that Kim's line of sight to the top of the screen makes with the horizontal is 30° . The angle that Yolanda's line of sight to the top of the screen makes with the horizontal is 45° .

- How high is the top of the screen in terms of x ?
- What is $\frac{x+15}{x}$?
- How far is Yolanda from the screen? Round your answer to the nearest tenth.

8-4 Word Problem Practice

Trigonometry

1. **RADIO TOWERS** Kay is standing near a 200-foot-high radio tower.

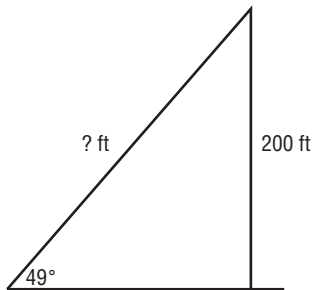

Use the information in the figure to determine how far Kay is from the top of the tower. Express your answer as a trigonometric function.



2. **RAMPS** A 60-foot ramp rises from the first floor to the second floor of a parking garage. The ramp makes a 15° angle with the ground.

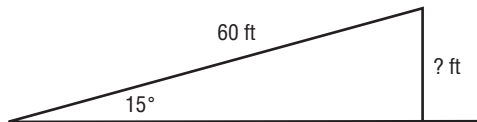

How high above the first floor is the second floor? Express your answer as a trigonometric function.

3. **TRIGONOMETRY** Melinda and Walter were both solving the same trigonometry problem. However, after they finished their computations, Melinda said the answer was $52 \sin 27^\circ$ and Walter said the answer was $52 \cos 63^\circ$. Could they both be correct? Explain.

4. **LINES** Jasmine draws line m on a coordinate plane.

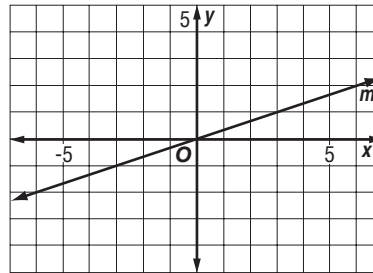

What angle does m make with the x -axis? Round your answer to the nearest degree.

NEIGHBORS For Exercises 5–7, use the following information.

Amy, Barry, and Chris live on the same block. Chris lives up the street and around the corner from Amy, and Barry lives at the corner between Amy and Chris. The three homes make a right triangle.

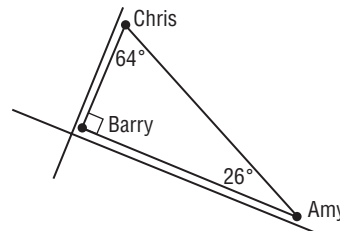

- Give two trigonometric expressions for the ratio of Barry's distance from Amy to Chris' distance from Amy.
- Give two trigonometric expressions for the ratio of Barry's distance from Chris to Amy's distance from Chris.
- Give a trigonometric expression for the ratio of Amy's distance from Barry to Chris' distance from Barry.

8-5 Word Problem Practice

Angles of Elevation and Depression

1. **LIGHTHOUSES** Sailors on a ship at sea spot the light from a lighthouse. The angle of elevation to the light is 25° .

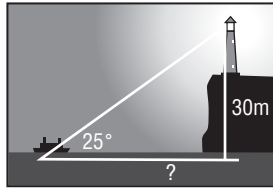

The light of the lighthouse is 30 meters above sea level. How far from the shore is the ship? Round your answer to the nearest meter.

2. **RESCUE** A hiker dropped his backpack over one side of a canyon onto a ledge below. Because of the shape of the cliff, he could not see exactly where it landed.

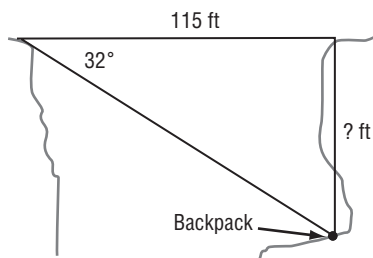

From the other side, the park ranger reports that the angle of depression to the backpack is 32° . If the width of the canyon is 115 feet, how far down did the backpack fall? Round your answer to the nearest whole number.

3. **AIRPLANES** The angle of elevation to an airplane viewed from the control tower at an airport is 7° . The tower is 200 feet high and the pilot reports that the altitude is 5200 feet. How far away from the control tower is the airplane? Round your answer to the nearest foot.

4. **PEAK TRAM** The Peak Tram in Hong Kong connects two terminals, one at the base of a mountain, and the other at the summit. The angle of elevation of the upper terminal from the lower terminal is about 15.5° . The distance between the two terminals is about 1365 meters. About how much higher above sea level is the upper terminal compared to the lower terminal? Round your answer to the nearest meter.

HELICOPTERS For Exercises 5–7, use the following information.

Jermaine and John are watching a helicopter hover above the ground.

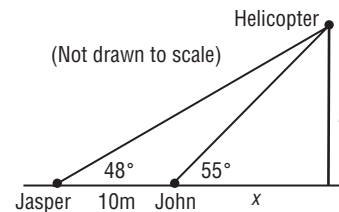

Jermaine and John are standing 10 meters apart.

- Find two different expressions that can be used to find the h , height of the helicopter.
- Equate the two expressions you found for Exercise 5 to solve for x . Round your answer to the nearest hundredth.
- How high above the ground is the helicopter? Round your answer to the nearest hundredth.

8-6 Word Problem Practice

The Law of Sines

1. **ALTITUDES** In triangle ABC , the altitude to side AB is drawn.

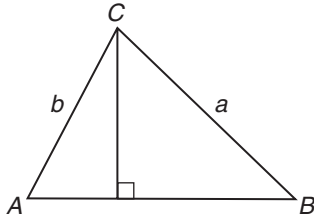

Give two expressions for the length of the altitude in terms of a , b , and the sine of the angles A and B .

2. **MAPS** Three cities form the vertices of a triangle. The angles of the triangle are 40° , 60° , and 80° . The two most distant cities are 40 miles apart. How close are the two closest cities? Round your answer to the nearest tenth of a mile.

3. **PHOTOS** Greg took a photograph of the view from his city apartment. The building on the left is the Rocket Tower and the building on the right is the Cloud Scratcher.



Greg's camera has a 60° viewing angle. Greg knows that he is 2 miles from the Cloud Scratcher and that the Rocket Tower is 3 miles from the Cloud Scratcher. How far is Greg from the Rocket Tower? Round your answer to the nearest hundredth.

4. **BOATING** A boat heads out to sea from a port that sits along a straight shoreline. The boat heads in a direction that makes a 70° angle with the shoreline. After sailing for 3 miles, the skipper looks back at the shore and sees his house. The house, like the port, also sits on the shore. The lines of sight to the port and to his home make an 80° angle. How far is the skipper's home from the port? Round your answer to the nearest tenth of a mile.

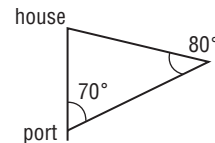

ISLANDS For Exercises 5 and 6, use the following information.

Oahu is a Hawaiian Island. Off of the coast of Oahu, there is a very tiny island known as Chinaman's Hat. Keoki and Malia are observing Chinaman's Hat from locations 5 kilometers apart.

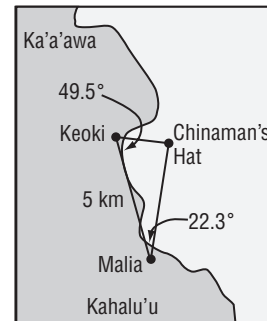

Use the information in the figure to answer the following questions.

5. How far is Keoki from Chinaman's Hat? Round your answer to the nearest tenth of a kilometer.
6. How far is Malia from Chinaman's Hat? Round your answer to the nearest tenth of a kilometer.

8-7 Word Problem Practice

The Law of Cosines

1. **RIGHT TRIANGLES** Triangle ABC is a right triangle with right angle at B . Let a be the length of the side opposite A , b be the length of the side opposite B , and c be the length of the side opposite C .

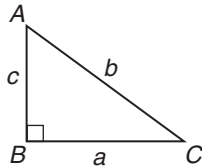

Rewrite the Law of Cosines with respect to the right angle B in simplest form.

2. **LANDSCAPING** Hanna wants to fence a triangular lot as shown. What is the length of the missing side? Round your answer to the nearest foot.

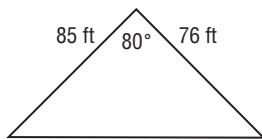

3. **STATUES** Gail was visiting an art gallery. In one room, she stood so that she had a view of two statues, one of a man, and the other of a woman. She was 40 feet from the statue of the woman, and 35 feet from the statue of the man. The angle created by the lines of sight to the two statues was 21° . What is the distance between the two statues? Round your answer to the nearest tenth.

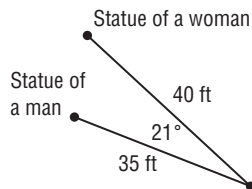

4. **CARS** Two cars start moving from the same location. They head straight, but in different directions. The angle between where they are heading is 43° . The first car travels 20 miles and the second car travels 37 miles. How far apart are the two cars? Round your answer to the nearest tenth.

CITIES For Exercises 5–7, use the following information.

The cities of Denver, Oklahoma City, and Albuquerque form the vertices of a triangle.

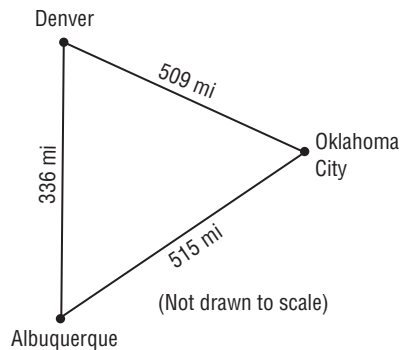

Use the information in the figure and round your answers to the nearest tenth of a degree.

- What is the measure of the angle at Albuquerque?
- What is the measure of the angle at Oklahoma City?
- What is the measure of the angle at Denver?

9-1 Word Problem Practice

Reflections

1. **REFLECTIONS** Vincent is making a star with a horizontal line of symmetry. Complete the star by drawing the reflected image of the figure over line m .

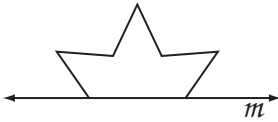

2. **LINES OF SYMMETRY** Maria placed a paper cutout on a table and then left to get some glue. Her friend James flipped over the cutout without telling Maria. Still, when Maria came back it was impossible for her to be able to see that anything had been changed. Draw a line through the figure that represents the line over which James must have flipped the figure.

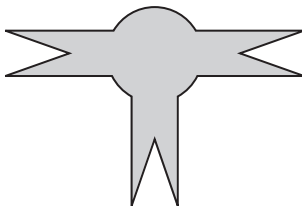

3. **SYMMETRY** Martha made the figure shown. How many lines of symmetry does the figure have?

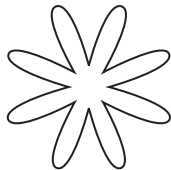

4. **INTERIOR DESIGN** Wilfred hired an interior designer to layout the furniture in his bedroom. The designer produced the plan shown in the figure. Unfortunately, Wilfred's window is located on the opposite wall from the plan. Wilfred decides to just reflect the plan over the vertical line through the center of the room. Draw the reflected plan.

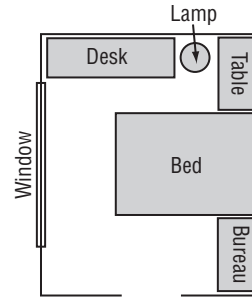

TRIANGLES For Exercises 5 and 6, use the following information.

Casey drew this triangle on the coordinate plane.

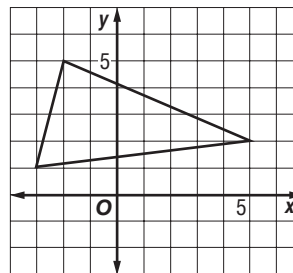

5. What are the vertices of the image of this triangle if it is reflected over the y -axis?
6. What are the vertices of the image of this triangle if it is reflected over the line $y = x$?

9-2 Word Problem Practice

Translations

1. **TRANSLATIONS** Wynette wants to see the translation of the five-sided figure shown. Draw the translation so that the indicated vertex is translated to the location of the dot.

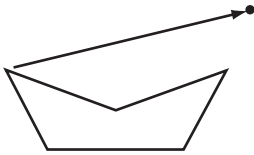

2. **WALLPAPER** A wallpaper design consists of repeated translations of a single isosceles triangle. The pattern is shown overlaid on a coordinate plane. The space above the triangle around the coordinate (5, 1) should be filled with a missing triangle. What are the coordinates of the vertices of the triangle that fill this space consistently with the rest of the pattern?

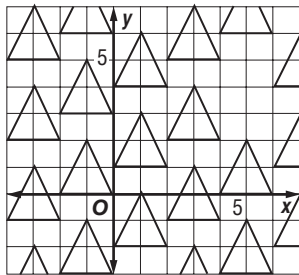

3. **REFLECTIONS** Gus reflects an object twice. The first step is to reflect it over the line $y = -1$. Then Gus completes the composite reflection by reflecting it over the line $y = 1$. The net effect is a translation of the object. Describe this translation.

4. **A TALE OF TWO TRANSLATIONS** Lacy performs the translation $(x, y) \rightarrow (x + 5, y + 3)$ to an object in the coordinate plane. Kyle performs the translation $(x, y) \rightarrow (x - 4, y + 2)$ to the same object after Lacy. What single translation could have been done to achieve the same effect as Lacy and Kyle's combined translations? Would the result have been different if Kyle did his translation first?

SQUARES AND CIRCLES For Exercises 5 and 6, use the following figure.

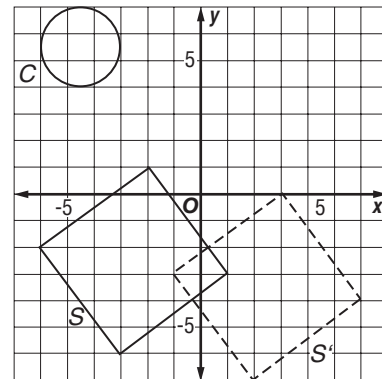

5. The image of square S under a translation is square S'. Describe this translation.
6. Draw the image of the circle C under the same translation that you described in Exercise 5.

9-3 Word Problem Practice

Rotations

1. **ROTATIONS** What is the order of rotational symmetry of the figure shown below?

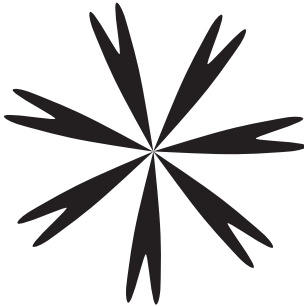

2. **FLYERS** Nicki is making a flyer that contains a large capital “M”.

M

She decides that she needs to rotate the “M” clockwise by 60° . Draw the rotated image.

3. **REFLECTIONS** Marge reflects an object twice. The first step is to reflect it in the line $y = 0$. Then Marge completes the composite reflection by reflecting it in the line $y = x$. The net effect is a rotation of the object. Describe this rotation.
4. **MAGNITUDES** A circular dial with the digits 0 through 9 evenly spaced around its edge can be rotated clockwise 36° . How many times would you have to perform this rotation in order to bring the dial back to its original orientation?

PLACE SETTINGS For Exercises 5-7, use the following figure.

Kelly is designing how she wants to put the place settings for her party. She wants the tables to be set up symmetrically with the design that is on the table. First she places plates as shown.

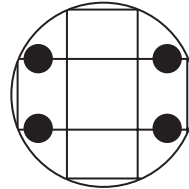

5. What is the order and magnitude of the rotational symmetry of the figure?
6. Make the least possible number of additions of plates to the figure so that the table has rotational symmetry of order 4 around its center.

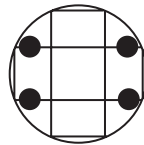

7. Is it possible to rearrange the locations of the 4 plates in the original figure so that (1) their distance from the center of the table does not change, (2) their centers remain somewhere on the rectangle design, and (3) the resulting figure has a rotational symmetry of order 4? If so, draw the figure. If not, explain why.

9-4 Word Problem Practice

Tessellations

1. **DESIGN** Henry drew a regular tessellation using congruent squares. Then, inside of each square he drew diagonal lines connecting the vertices of the square to that square's center. Describe the resulting tessellation.

2. **BRICK WALLS** Gordon wants to add a brick wall to his backyard. He wants to use rectangular bricks, but he does not want to use them all in the same orientation. Give an example of a tessellation using 2 by 1 rectangles with some oriented horizontally and some oriented vertically.

3. **CIRCLES** A tessellation cannot be made using congruent circles. However, it is possible to tessellate the plane using circles together with other shapes. Show how this can be done by using congruent circles together with congruent copies of one other shape.

4. **TILES** Show how to make a tessellation of tiles using the tile shape shown.

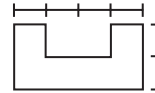

- QUILTS** For Exercises 5 and 6, use the following information.

Mona has been assigned a special math project that requires her to find an example of a tessellation in a real life situation. She recently completed a quilt using cloth pieces shaped like decagons.

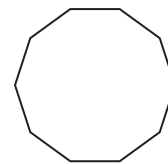

5. Is it possible the quilt is an example of a tessellation?
6. Justify the solution to Exercise 5.

9-5 Word Problem Practice

Dilations

1. **CENTERS** Margot superimposed the image of the dilation of a figure on its original figure as shown.

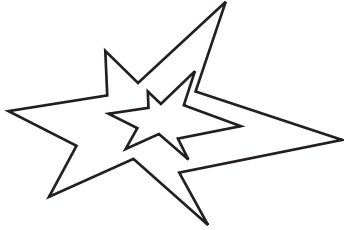

Identify the center of this dilation. Explain how you can find it.

2. **SCALE FACTORS** Tyrone drew a shape together with one of its dilations on the same coordinate plane as shown.

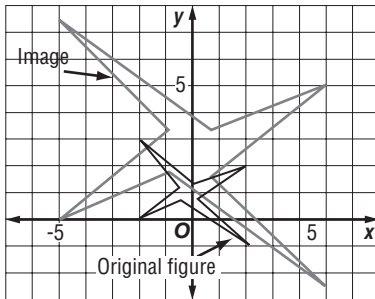

What is the scale factor of the dilation?

3. **DILATIONS** Cara is making images for a poster. She wants to thicken the five pointed star shown by dilating it, and then filling in the space between the original and its image. Sketch the dilated image with the indicated center and a scale factor of 1.5.



4. **COORDINATES** Leila drew a polygon with coordinates $(-1, 2)$, $(1, 2)$, $(1, -2)$, and $(-1, -2)$. She then dilated the image and obtained another polygon with coordinates $(6, 12)$, $(6, -12)$, $(-6, -12)$, and $(-6, 12)$. What was the scale factor and center of this dilation?

FLOOR PLANS For Exercises 5 and 6, use the following information.

Fred drew the floor plan of his house on a coordinate plane. He decided he wanted to make it smaller because he wanted to include more.

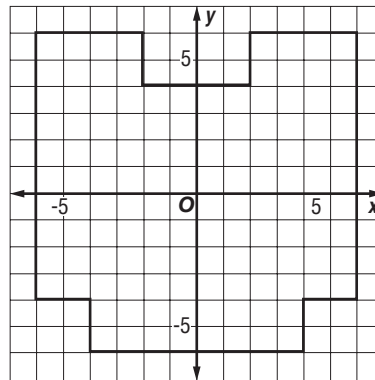

5. Graph the image of Fred's floor plan after a dilation centered at $(0, 0)$ with scale factor 0.5.
6. The perimeter of the image is 26 units. What is the perimeter of the original figure?

9-6 Word Problem Practice

Vectors

- WIND** The vector \vec{v} represents the speed and direction that the wind is blowing. Suddenly the wind picks up and doubles its speed, but the direction does not change. Write an expression for a vector that describes the new wind velocity in terms of \vec{v} .
- TRANSLATIONS** Beth has a square with coordinates $(-3, 2)$, $(-4, 3)$, $(-3, 4)$, and $(-2, 3)$. She wants to move it to another place using a translation by the vector $\vec{v} = \langle 7, -5 \rangle$. What are the coordinates of the image?
- SWIMMING** Jan is swimming in a triathlon event. When the ocean water is still, her velocity can be represented by the vector $\langle 2, 1 \rangle$ miles per hour. During the competition, there was a fierce current represented by the vector $\langle -1, -1 \rangle$ miles per hour. What vector represents Jan's velocity during the race?
- POLYGONS** Draw a regular polygon around the origin. For each side of the polygon, associate a vector whose magnitude is the length of the corresponding side and whose direction points in the clockwise motion around the origin. What vector represents the sum of all these vectors? Explain.

BASEBALL For Exercises 5 and 6, use the following information.

Rick is in the middle of a baseball game. His teammate throws him the ball, but throws it far in front of him. He has to run as fast as he can to catch it. As he runs, he knows that as soon as he catches it, he has to throw it as hard as he can to the teammate at home plate. He has no time to stop. In the figure, \vec{x} is the vector that represents the velocity of the ball *after* Rick throws it and \vec{v} represents Rick's velocity because he is running. Assume that Rick can throw just as hard when running as he can when standing still.

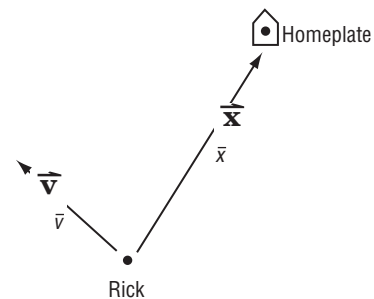

- What vector would represent the velocity of the ball if Rick threw it the same way but he was standing still?
- The angle between \vec{x} and \vec{v} is 89° . By running, did it help Rick get the ball to home plate faster than he would have normally been able to if he were standing still?

10-1 Word Problem Practice

Circles and Circumference

1. **WHEELS** Zack is designing wheels for a concept car. The diameter of the wheel is 18 inches. Zack wants to make spokes in the wheel that run from the center of the wheel to the rim. In other words, each spoke is a radius of the wheel. How long are these spokes?

2. **CAKE CUTTING** Kathy slices through a circular cake. The cake has a diameter of 14 inches. The slice that Kathy made is straight and has a length of 11 inches.

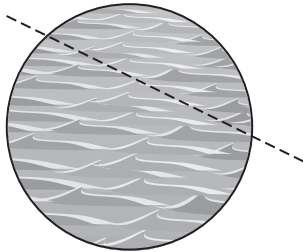

Did Kathy cut along a *radius*, a *diameter*, or a *chord* of the circle?

3. **COINS** Three identical circular coins are lined up in a row as shown.

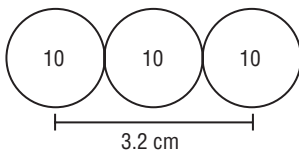

The distance between the centers of the first and third coins is 3.2 centimeters. What is the radius of one of these coins?

4. **PLAZAS** A rectangular plaza has a surrounding circular fence. The diagonals of the rectangle pass from one point on the fence through the center of the circle to another point on the fence.

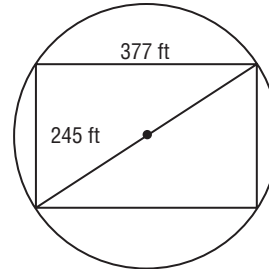

Based on the information in the figure, what is the diameter of the fence? Round your answer to the nearest tenth of a foot.

EXERCISE HOOPS For Exercises 5 and 6, use the following information.

Taiga wants to make a circular loop that he can twirl around his body for exercise. He will use a tube that is 2.5 meters long.

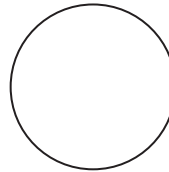

5. What will be the diameter of Taiga's exercise hoop? Round your answer to the nearest thousandth of a meter.

6. What will be the radius of Taiga's exercise hoop? Round your answer to the nearest thousandth of a meter.

10-2 Word Problem Practice

Measuring Angles and Arcs

1. **CONDIMENTS** A number of people in a park were asked to name their favorite condiment for hot dogs. The results are shown in the circle graph.

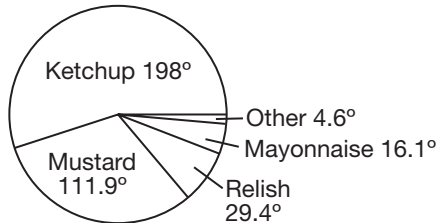

What was the second most popular hot dog condiment?

2. **CLOCKS** Shiatsu is a Japanese massage technique. One of the beliefs is that various body functions are most active at various times during the day. To illustrate this, they use a Chinese clock that is based on a circle divided into 12 equal sections by radii.

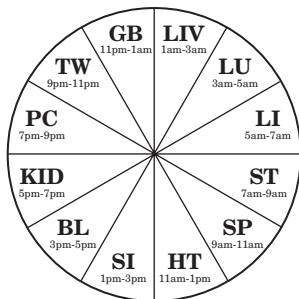

What is the measure of any one of the 12 equal central angles?

3. **PIES** Yolanda has divided a circular apple pie into 4 slices by cutting the pie along 4 radii. The central angles of the 4 slices are $3x$, $6x - 10$, $4x + 10$, and $5x$ degrees. What exactly are the numerical measures of the central angles?

4. **RIBBONS** Cora is wrapping a ribbon around a cylinder-shaped gift box. The box has a diameter of 15 inches and the ribbon is 60 inches long. Cora is able to wrap the ribbon all the way around the box once, and then continue so that the second end of the ribbon passes the first end. What is the central angle formed between the ends of the ribbon? Round your answer to the nearest tenth of a degree.

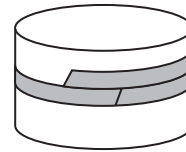

BIKE WHEELS For Exercises 5 and 6, use the following information.

Lucy had to buy a new wheel for her bike. The bike wheel has a diameter of 20 inches.

5. If Lucy rolls the wheel one complete rotation along the ground, how far will the wheel travel? Round your answer to the nearest hundredth of an inch.
6. If the bike wheel is rolled along the ground so that it rotates 45° , how far will the wheel travel? Round your answer to the nearest hundredth of an inch.
7. If the bike wheel is rolled along the ground for 10 inches, through what angle does the wheel rotate? Round your answer to the nearest tenth of a degree.

10-3 Word Problem Practice

Arcs and Chords

1. **HEXAGON** A hexagon is constructed as shown in the figure.

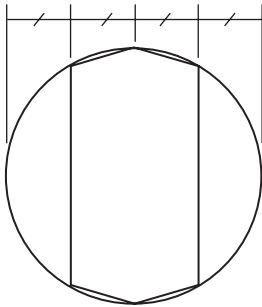

How many different chord lengths occur as side lengths of the hexagon?

2. **FENCING** A contractor is hired to build a fence around a circular park. The contractor traces out 10 radial lines each separated by 36° . He places a post where each line intersects the perimeter of the park. He then connects consecutive posts with a straight fence. The result is a fence that has the shape of a polygon with 10 sides. Is this polygon a regular decagon? Explain.

3. **BIKE PATHS** Carl is planning to visit a circular park. The radius of the park is 8 miles. He is looking at a map of the park and sees that the park has five landmarks along its edge. The landmarks are connected by paths of equal length for biking. These paths form a regular pentagon inscribed in the circle. If Carl bikes along these paths to visit each landmark, how many miles will he bike?

4. **CENTERS** Neil wants to find the center of a large circle drawn in the pavement of the schoolyard. He draws what he thinks is a diameter of the circle and then marks its midpoint and declares that he has found the center. His teacher comes by and asks Neil how he knows that the line he drew is really the diameter of the circle and not a smaller chord. Neil realizes that he does not know for sure. Explain what Neil can do to determine if it is an actual diameter.

A TALE OF TWO TRIANGLES For Exercises 5 and 6, use the following information.

An equilateral triangle is inscribed in a circle with center O . The triangle is then rotated 30° to obtain another equilateral triangle inscribed in the circle.

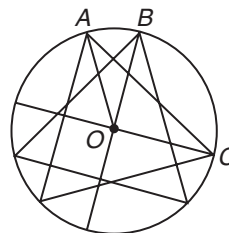

5. What is $m\angle AOC$?
6. Prove that the diameter through B is perpendicular to the diameter through C .

10-4 Word Problem Practice

Inscribed Angles

1. **ARENA** A circus arena is lit by five lights equally spaced around the perimeter.

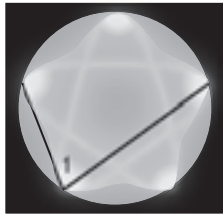

What is $m\angle 1$?

2. **FIELD OF VIEW** The figure shows a top view of two people in front of a very tall rectangular wall. The wall makes a chord of a circle that passes through both people.

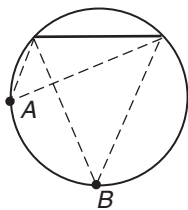

Which person has more of their horizontal field of vision blocked by the wall?

3. **RHOMBI** Paul is interested in circumscribing a circle around a rhombus that is not a square. He is having great difficulty doing so. Can you help him? Explain.

4. **STREETS** Three kilometers separate the intersections of Cross and Upton and Cross and Hope.

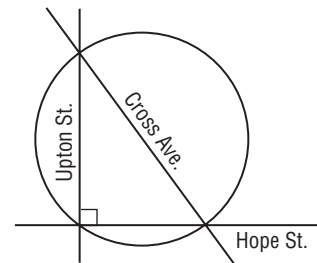

What is the distance between the intersection of Upton and Hope and the point midway between the intersections of Upton and Cross and Cross and Hope?

INSCRIBED HEXAGONS For Exercises 5 and 6, use the following information.

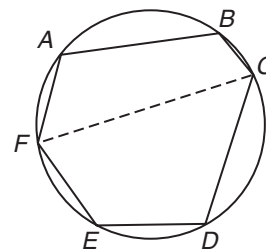

You will prove that the sum of the measures of alternate interior angles in an inscribed hexagon is 360.

5. How are $\angle A$ and $\angle BCF$ related? Similarly, how are $\angle E$ and $\angle DCF$ related?
6. Show that $m\angle A + m\angle BCD + m\angle E = 360^\circ$.

10-5 Word Problem Practice

Tangents

1. **CANALS** The concrete canal in Landtown is shaped like a “V” at the bottom. One day, Maureen accidentally dropped a cylindrical tube as she was walking and it rolled to the bottom of the dried out concrete canal. The figure shows a cross section of the tube at the bottom of the canal.

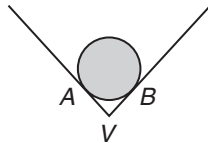

Compare the lengths AV and BV .

2. **PACKAGING** Taylor packed a sphere inside a cubic box. He had painted the sides of the box black before putting the sphere inside. When the sphere was later removed, he discovered that the black paint had not completely dried and there were black marks on the sides of the sphere at the points of tangency with the sides of the box. If the black marks are used as the vertices of a polygon, what kind of polygon results?

3. **TRIANGLES** A circle is inscribed in a 40° - 60° - 80° triangle. The points of tangency form the vertices of a triangle inscribed in the circle. What are the angles of the inscribed triangle?

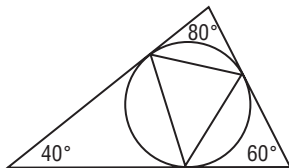

4. **ROLLING** A wheel is rolling down an incline. Twelve evenly spaced diameters form spokes of the wheel.

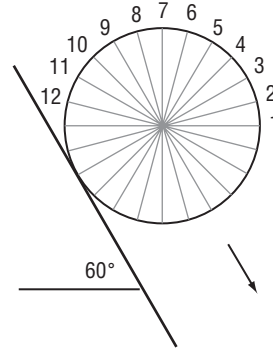

When spoke 2 is vertical, which spoke will be perpendicular to the incline?

DESIGN For Exercises 5 and 6, use the following information.

Amanda wants to make this design of circles inside an equilateral triangle.

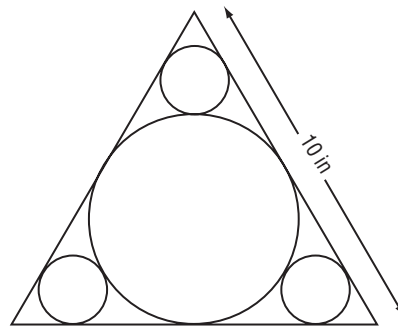

5. What is the radius of the large circle to the nearest hundredth of an inch?
6. What are the radii of the smaller circles to the nearest hundredth of an inch?

10-6 Word Problem Practice

Secants, Tangents, and Angle Measures

1. **TELESCOPES** Vanessa looked through her telescope at a mountainous landscape. The figure shows what she saw. Based on the view, approximately what angle does the side of the mountain that runs from A to B make with the horizontal?

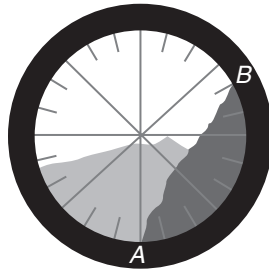

2. **RADAR** Two airplanes were tracked on radar. They followed the paths shown in the figure.

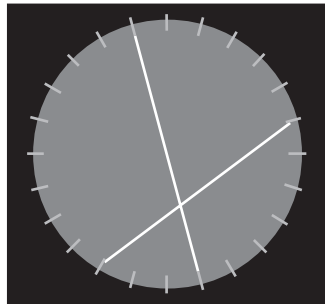

What is the acute angle between their flight paths?

3. **EASELS** Francisco is a painter. He places a circular canvas on his A-frame easel and carefully centers it. The apex of the easel is 30° and the measure of arc BC is 22° . What is the measure of arc AB ?

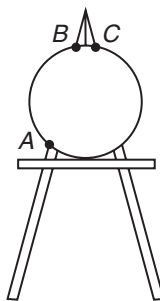

4. **FLYING** When flying at an altitude of 5 miles, the lines of sight to the horizon looking north and south make about a 173.7° angle. How much of the longitude line directly under the plane is visible from 5 miles high?

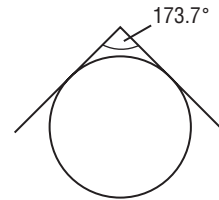

STAINED GLASS For Exercises 5 and 6, use the following information.

Pablo made the stained glass window shown. He used an inscribed square and equilateral triangle for the design.

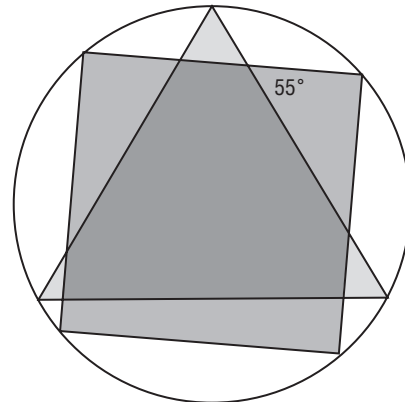

- Label the angle measures on the outer edge of the triangle.
- Label all of the arcs with their degree measure.

10-7 Word Problem Practice

Special Segments in a Circle

1. **ICE SKATING** Ted skated through one of the face-off circles at a skating rink. His path through the circle is shown in the figure.

Given that the face-off circle is 15 feet in diameter, what distance within the face-off circle did Ted travel?

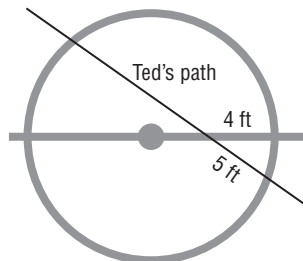

2. **HORIZONS** Assume that Earth is a perfect sphere with a diameter of 7926 miles. From an altitude of a miles, how long is the horizon line h ?

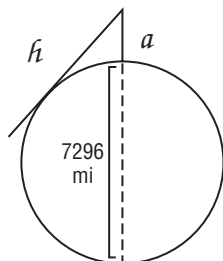

3. **AXLES** The figure shows the cross-section of an axle held in place by a triangular sleeve. A brake extends from the apex of the triangle. When the brake is extended 2.5 inches into the sleeve, it comes into contact with the axle. What is the diameter of the axle?

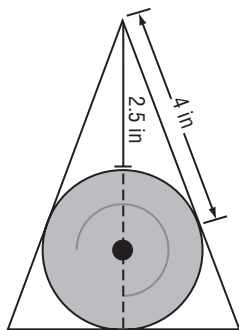

4. **ARCHEOLOGY** Scientists unearthed part of a circular wall. They made the measurements shown in the figure.

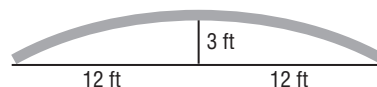

Based on the information in the figure, what was the radius of the circle?

- PIZZA DELIVERY** For Exercises 5 and 6, use the following information.

Pizza Power is located at the intersection of Northern Boulevard and Highway 1 in a city with a circular highway running all the way around its outskirts. The radius of the circular highway is 13 miles. Pizza Power puts the map shown below on its take-out menus.

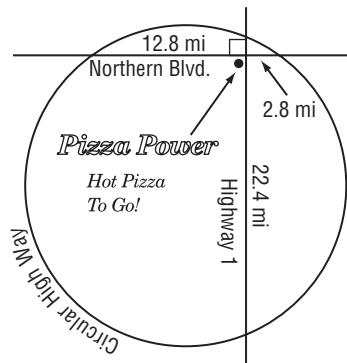

5. How many miles away is the Circular Highway from Pizza Power if you travel north on Highway 1?
6. The city builds a new road along the diameter of Circular Highway that passes through the intersection of Northern Boulevard and Highway 1. Along this new road, about how many miles is it (the shorter way) to the Circular Highway from Pizza Power?

10-8 Word Problem Practice

Equations of Circles

1. **DESIGN** Arthur wants to write the equation of a circle that is inscribed in the square shown in the graph.

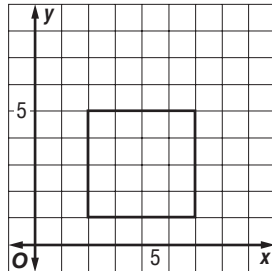

What is the equation of the desired circle?

2. **DRAFTING** The design for a park is drawn on a coordinate graph. The perimeter of the park is modeled by the equation $(x - 3)^2 + (x - 7)^2 = 225$. Each unit on the graph represents 10 feet. What is the radius of the actual park?
3. **WALLPAPER** The design of a piece of wallpaper consists of circles that can be modeled by the equation $(x - a)^2 + (y - b)^2 = 4$, for all even integers b . Sketch part of the wallpaper on a grid.
4. **SECURITY RING** A circular safety ring surrounds a top-secret laboratory. On one map of the laboratory grounds, the safety ring is given by the equation $x^2 + y^2 - 20x + 14y = 175$. Each unit on the map represents 1 mile. What is the radius of the safety ring?

DISTANCE For Exercises 5-7, use the following information.

Cleo lives the same distance from the library, the post office, and her school. The table below gives the coordinates of these places on a map with a coordinate grid where one unit represents one yard.

Location	Coordinates
Library	(-78, 202)
Post Office	(111, 193)
School	(202, -106)

5. What are the coordinates of Cleo's home? Sketch the circle on a map locating all three places and Cleo's home.
6. How far is Cleo's house from the places mentioned?
7. Write an equation for the circle that passes through the library, post office, and school.

11-1 Word Problem Practice

Areas of Parallelograms

1. **PACKAGING** A box with a square opening is squashed into the rhombus shown below.

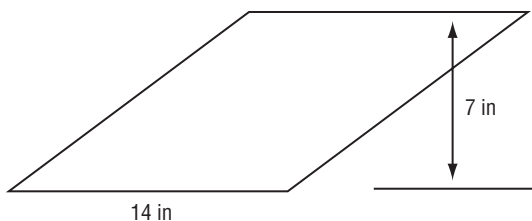

What is the area of the opening?

2. **RUNNING** Jason jogs once around a city block shaped like a parallelogram.

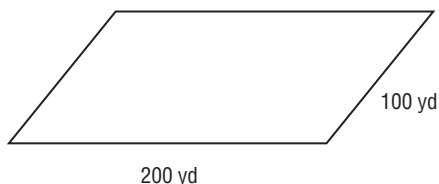

How far did Jason jog?

3. **SHADOWS** A rectangular billboard casts a shadow on the ground in the shape of a parallelogram. What is the area of the ground covered by the shadow? Round your answer to the nearest tenth.

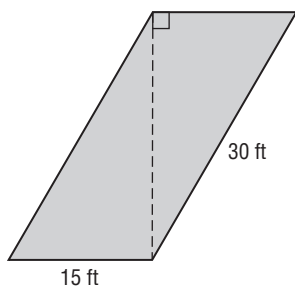

4. **PATHS** A concrete path shown below is made by joining several parallelograms.

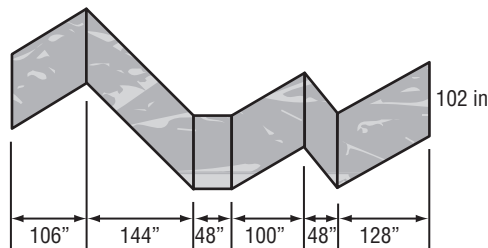

What is the total area of the path?

HIGHWAY SUPPORTS For Exercises 5 and 6, use the following information.

Four columns are being placed at the vertices of a parallelogram to support a highway. Three of the columns are marked on the coordinate plane shown.

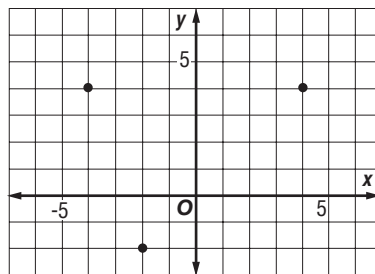

5. What are the coordinates of the three possible locations of the fourth column?
6. What is the area in square units of each of the three parallelograms that result from the possibilities you found in Exercise 5? Explain.

11-2 Word Problem Practice

Areas of Triangles, Trapezoids, and Rhombi

1. **INTERIOR DESIGN** The 10 by 10 square shows an office floor plan composed of four congruent 8-sided cubicles. What is the area of one of these irregular 8-sided cubicles?

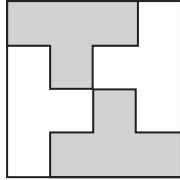

2. **CUTOUTS** Jeremy cut a rhombus out of a 10-inch by 7-inch rectangle. The diagonals of the rhombus are parallel and perpendicular to the sides of the rectangle and are congruent to the length and width of the rectangle, respectively. What is the total area of the four shaded triangles?

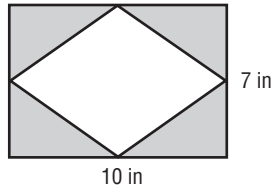

3. **SHARING** Bernard has a piece of cake that is shaped like a right triangle. He needs to cut it into three pieces to share it with two friends. He divides one of the legs into thirds and connects the division points to the opposite vertex of the triangle as shown in the figure. Which piece is the largest?

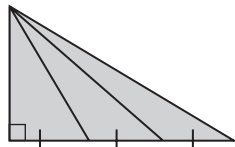

4. **HEXAGONS** Heather makes a hexagon by attaching two trapezoids together as shown. What is the area of the hexagon?

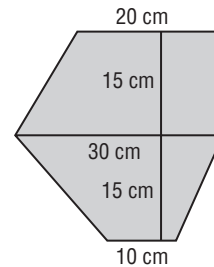

- TILINGS** For Exercises 5 and 6, use the following information.

Tile making often requires an artist to find clever ways of dividing a shape into several smaller, congruent shapes. Consider the isosceles trapezoid shown below.

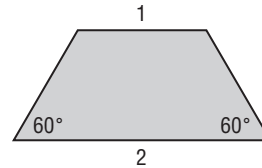

5. Show how to divide the trapezoid into 3 congruent triangles. What is the area of each triangle?

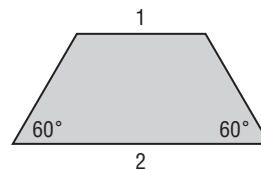

6. Show how to divide the trapezoid into 4 congruent trapezoids. What is the area of each of the smaller trapezoids?

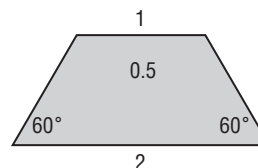

11-3 Word Problem Practice**Areas of Regular Polygons and Circles**

1. **LOBBY** The lobby of a bank features a large marble regular octagon. Each side of the octagon is 15 feet long.



What is the area of the octagon? Round your answer to the nearest tenth.

2. **PORTHOLES** A circular window on a ship has a radius of 8 inches. What is the area of the window? Round your answer to the nearest hundredth.
3. **YIN-YANG SYMBOL** A well-known symbol from Chinese culture is the yin-yang symbol, shown below.

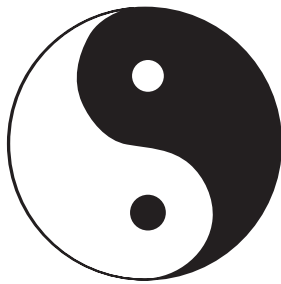

Suppose the large circle has radius r , the small circles have radius $\frac{r}{8}$, and the S-curve is two semicircles each with radius $\frac{r}{2}$. In terms of r , what is the area of the black region?

4. **PYRAMIDS** Martha's clubhouse is shaped like a square pyramid with four congruent equilateral triangles for its sides. All of the edges are 6 feet long. What is the total surface area of the clubhouse including the floor? Round your answer to the nearest hundredth.

POOL DECKS For Exercises 5-7, use the following information.

Ricardo designs a square pool with surrounding pool deck according to the plan shown. The outer edge of the deck is a regular dodecagon with side length 20 feet.

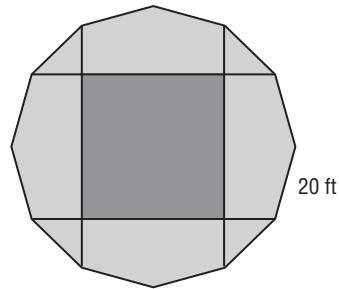

5. What is the length of the apothem of the dodecagonal deck?
6. What is the length of the diagonal of the square pool?
7. What is the area of the deck?

11-4 Word Problem Practice

Areas of Composite Figures

1. **FLOOR PLANS** The floor plan of an L-shaped building is shown in the coordinate plane. Each unit represents 5 meters.

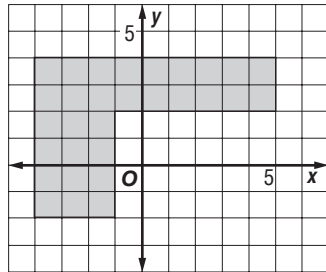

What is the area of the building?

2. **DOG HOUSES** Miranda is building a dog house out of wood. The front view of the dog house is shown on the coordinate plane below.

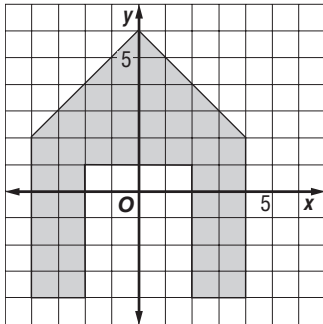

If each unit corresponds to 5 inches, what is the area of the front?

3. **MINIATURE GOLF** The plan for a miniature golf hole is shown below. The right angle in the drawing is a central angle.

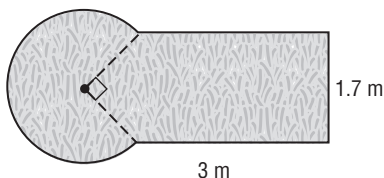

What is the area of the playing surface? Round your answer to the nearest hundredth of a square meter.

4. **TRACK** A running track has an inner and outer edge. Both the inner and outer edge consists of two semicircles joined by two straight line segments. The straight line segments are 100 yards long. The radii of the inner edge semicircles are 25 yards and the radii of the outer edge semicircles are 32 yards. What is the area of the track? Round your answer to the nearest hundredth of a yard.

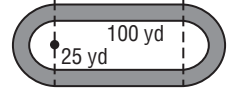

SEMICIRCLES For Exercises 5 and 6, use the following information.

Bridget arranged three semicircles in the pattern shown.

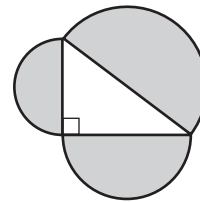

The right triangle has side lengths 6, 8, and 10 inches.

5. What is the total area of the three semicircles? Round your answer to the nearest hundredth of a square inch.
6. If the right triangle had side lengths $\sqrt{21}$, $\sqrt{79}$, and 10 inches, what would the total area of the three semicircles be? Round your answer to the nearest hundredth of a square inch.

11-5 Word Problem Practice

Geometric Probability and Areas of Sectors

1. **DARTS** A dart is thrown at the dartboard shown. Each sector has the same central angle. The dart has equal probability of hitting any point on the dartboard. What is the probability that the dart will land in a shaded sector?

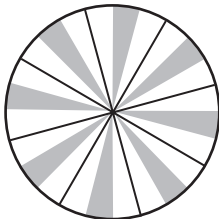

2. **SPINNERS** Jamie, Joe, and Pat celebrate the end of each work week by ordering spring rolls from a Chinese restaurant. The order comes with 4 spring rolls so somebody gets an extra roll. Because Jamie works full time and Joe and Pat work half time, they decide who gets the extra roll by using a spinner that has a 50% chance of coming up Jamie, and 25% chances of coming up either Joe or Pat. Design such a spinner.

3. **RAIN** A container has a square top with a hole as shown. What is the probability that a raindrop that hits the container falls into the hole? Round your answer to the nearest thousandth.

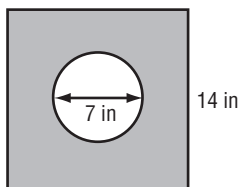

4. **ELECTRON MICROSCOPES** Crystal places a 7 millimeter by 10 millimeter rectangular plate into the sample chamber of an electron microscope. A black and white checkerboard pattern of 1-millimeter squares was painted over the plate to identify different treatments of the material. When she turns on the monitor, she has no idea at what point on the plate she is looking because the white and black contrast does not show up on the screen. If there are 2 more black squares than white squares, what is the probability that she is looking at a white square?

ENTERTAINMENT For Exercises 5 and 6, use the following information.

A rectangular dance stage is lit by two lights that light up circular regions of the stage. The circles have the same radius and each circle passes through the center of the other. The stage perfectly circumscribes the two circles. A spectator throws a bouquet of flowers onto the stage. Assume the bouquet has an equal chance of landing anywhere on the stage. (*Hint: Use inscribed equilateral triangles.*)

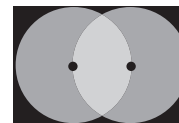

5. What is the probability that the flowers land on a lit part of the stage?
6. What is the probability that the flowers land on the part of the stage where the spotlights overlap?

12-1 Word Problem Practice

Representations of Three-Dimensional Figures

1. **LABELS** Jamal removes the label from a cylindrical soup can to earn points for his school. Sketch the shape of the label.

2. **BLOCKS** Margot's three-year-old son made the magnetic block sculpture shown below in corner view.

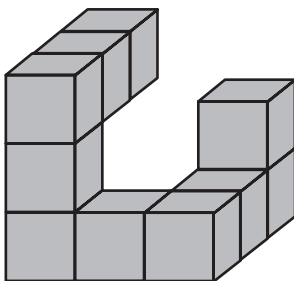

Draw the right view of the sculpture.

3. **CUBES** Nathan marks the midpoints of three edges of a cube as shown. He then slices the cube along a plane that contains these three points. Describe the resulting cross section.

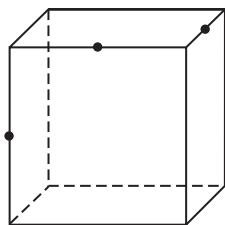

4. **ENGINEERING** Stephanie needs an object whose top view is a circle and whose left and front views are squares. Describe an object that will satisfy these conditions.

DESK SUPPORTS For Exercises 5-7, use the following information.

The figure shows the support for a desk.

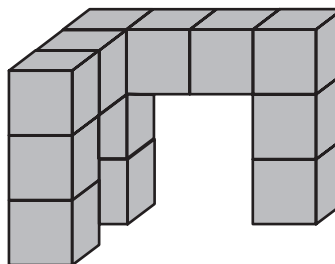

5. Draw the top view.

6. Draw the front view.

7. Draw the right view.

12-2 Word Problem Practice

Surface Areas of Prisms

1. **LOGOS** The Z company specializes in caring for zebras. They want to make a 3-dimensional “Z” to put in front of their company headquarters. The “Z” is 15 inches thick and the perimeter of the base is 390 inches.

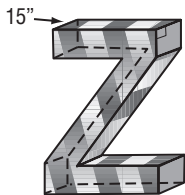

What is the lateral surface area of this “Z”?

2. **STAIRWELLS** Management decides to enclose stairs connecting the first and second floors of a parking garage in a stairwell shaped like an oblique rectangular prism.

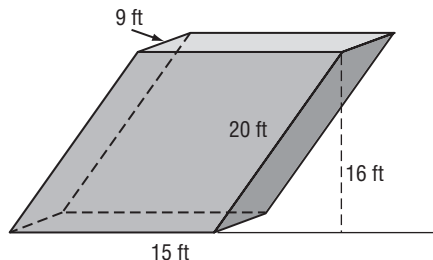

What is the lateral surface area of the stairwell?

3. **CAKES** A cake is a rectangular prism with height 4 inches and base 12 inches by 15 inches. Wallace wants to apply frosting to the sides and the top of the cake. What is the surface area of the part of the cake that will have frosting?

4. **CANDY** A candy maker packages one of its products in a triangular prism. The height of the prism is 10 inches. The base is an equilateral triangle with side length 3 inches. What is the surface area of the package? Round your answer to the nearest hundredth.

WOOD PLANKS For Exercises 5-8, use the following information.

A wood plank is a rectangular prism with length 10 feet and base dimensions 2 inches by 4 inches.

5. What is the surface area of the plank in square inches?
6. Katrina cuts the plank in half lengthwise and obtains two wood planks, each 5 feet long. What is the total surface area of both planks?
7. If instead, Katrina had cut the plank into N equal pieces lengthwise, what would be the total surface area of all N pieces?
8. Katrina wants to cut the plank into two rectangular pieces in a way that will give her the greatest total surface area for the pieces. How should she cut the plank?

12-3 Word Problem Practice

Surface Areas of Cylinders

- DRUMS** A drum is shaped like a cylinder with a height of 5 inches and a radius of 7 inches. What is the surface area of the drum? Round your answer to the nearest hundredth.

- DRINKING GLASSES** A drinking glass is shaped like a cylinder with a height of 7 inches and a diameter of 3 inches.

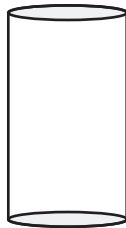

What is the surface area of the drinking glass? Remember that the glass has an open top. Round your answer to the nearest hundredth.

- ORIGAMI** Hank takes a square sheet of paper and rolls it into a cylinder. The square is 10 inches by 10 inches.

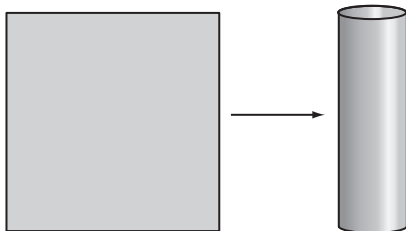

What are the dimensions of the cylinder and what is the lateral area of the cylinder? Round your answers to the nearest hundredth.

- EXHAUST PIPES** An exhaust pipe is shaped like a cylinder with a height of 50 inches and a radius of 2 inches. What is the lateral surface area of the exhaust pipe? Round your answer to the nearest hundredth.

TOWERS For Exercises 5 and 6, use the following information.

A circular tower is made by placing one cylinder on top of another. Both cylinders have a height of 18 inches. The top cylinder has a radius of 18 inches and the bottom cylinder has a radius of 36 inches.

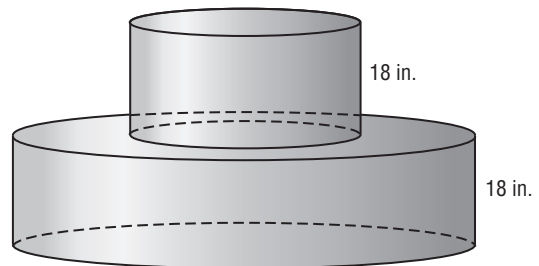

- What is the total surface area of the tower? Round your answer to the nearest hundredth.
- Another tower is constructed by placing the original tower on top of another cylinder with a height of 18 inches and a radius of 54 inches. What is the total surface area of the new tower? Round your answer to the nearest hundredth.

12-4 Word Problem Practice

Surface Areas of Pyramids

1. **PAPER MODELS** Patrick is making a paper model of a castle.

Part of the model involves cutting out the net shown and folding it into a

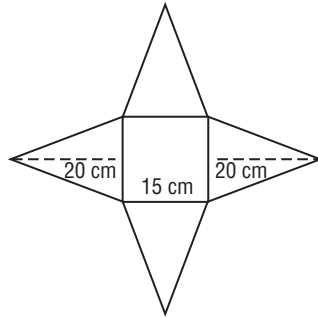

pyramid. The pyramid has a square base. What is the lateral surface area of the resulting pyramid?

2. **TETRAHEDRON** Sung Li builds a paper model of a regular tetrahedron, a pyramid with an equilateral triangle for the base and three equilateral triangles for the lateral faces. One of the faces of the tetrahedron has an area of 17 square inches. What is the total surface area of the tetrahedron?

3. **PAPERWEIGHTS** Daphne uses a paperweight shaped like a pyramid with a regular hexagon for a base. The side length of the regular hexagon is 1 inch. The altitude of the pyramid is 2 inches.

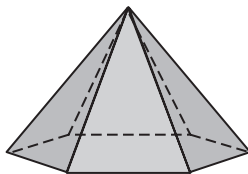

What is the lateral surface area of this pyramid? Round your answers to the nearest hundredth.

4. **DICE** A game needs random numbers between 1 and 8, inclusive. For that reason, the game uses a die in the shape of a regular octahedron. (A regular octahedron can be made by attaching two square pyramids together along their bases.) The lateral faces are congruent equilateral triangles with side length 2 centimeters. What is the surface area of the die?

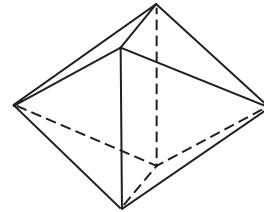

Round your answer to the nearest hundredth.

- CHEESE** For Exercises 5 and 6, use the following information.

A piece of goat cheese is sold in the shape of a square pyramid. The base has a side length of 4 inches and the altitude is 3 inches. Round your answers to the nearest hundredth.

5. Caroline cuts off the tip of the cheese by slicing the pyramid along a plane parallel to the base resulting in a smaller square pyramid with an altitude of 1 inch. What is the surface area of this cheese tip?
6. What is the surface area of the remaining part of the cheese?

12-5 Word Problem Practice**Surface Areas of Cones**

1. **HALF CIRCLES** Charles cuts out a semicircle with a radius of 5 inches from a piece of paper. He then curls it into a cone by joining the two radii on the edge of the semicircle together.

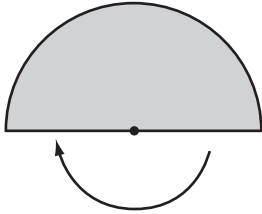

What is the lateral surface area of the resulting cone? Round your answer to the nearest hundredth.

2. **CASTLES** A right circular cone with an altitude of 20 feet and a radius of 6 feet serves as the highest cap of a castle.

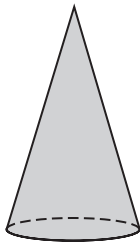

What is the lateral surface area of this cone? Round your answer to the nearest hundredth.

3. **PAINTING** Naomi is asked to paint a number of congruent cones. She is told that the radius of the cones is 6 inches and the altitude of the cones is 2 inches. What is the surface area of the cones? Round your answer to the nearest hundredth.

4. **SPRAY PAINT** A can of spray paint shoots out paint in a cone shaped mist. The lateral surface area of the cone is 65π square inches when the can is held 12 inches from a canvas. What is the area of the part of the canvas that gets sprayed with paint? Round your answer to the nearest hundredth.

MEGAPHONES For Exercises 5-7, use the following information.

A megaphone is formed by taking a cone with a radius of 20 centimeters and an altitude of 60 centimeters and cutting off the tip. The cut is made along a plane that is perpendicular to the axis of the cone and intersects the axis 12 centimeters from the vertex. Round your answer to the nearest hundredth.

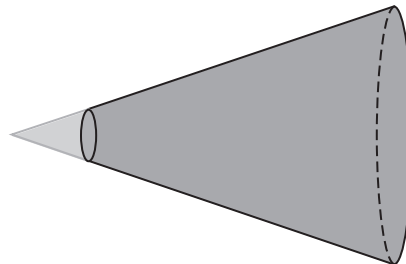

5. What is the lateral surface area of the original cone?
6. What is the lateral surface area of the tip that is removed?
7. What is the lateral surface area of the megaphone?

12-6 Word Problem Practice

Surface Areas of Spheres

- ORANGES** Mandy cuts a spherical orange in half along a great circle. If the radius of the orange is 2 inches, what is the area of the cross section that Mandy cut? Round your answer to the nearest hundredth.
- COFFEE TABLES** A coffee table is made by taking a sphere with a radius of 26 inches and then cutting it along two parallel planes. The two planes are both 10 inches from the center of the sphere. The section of the sphere that contains its center is used as the table.

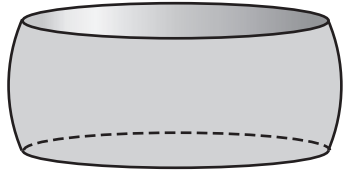

What is the area of the tabletop?

- MOONS OF SATURN** The planet Saturn has several moons. These can be modeled accurately by spheres. Saturn's largest moon Titan has a radius of about 2575 kilometers. What is the approximate surface area of Titan? Round your answer to the nearest tenth.

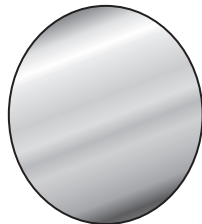

- METEORS** A spherical meteorite lies half exposed in the earth. The diameter of the meteorite is 14 inches. What is the surface area of the exposed surface? Round your answer to the nearest hundredth.

CUBES For Exercises 5-7, use the following information.

Marcus builds a spherical container for a cube. The cube fits snugly inside the sphere so that the vertices of the cube touch the inside of the sphere. The side length of the cube is 2 inches.

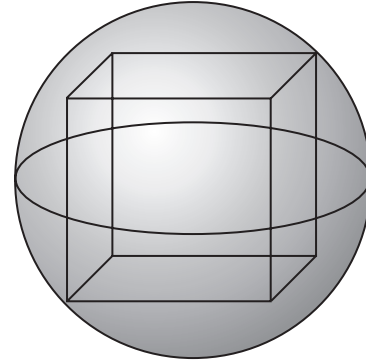

- What is the surface area of the cube?
- What is the surface area of the sphere? Round your answers to the nearest hundredth.
- What is the ratio of the surface area of the cube to the surface area of the sphere? Round your answer to the nearest hundredth.

13-1 Word Problem Practice**Volumes of Prisms and Cylinders**

1. **TRASH CANS** The Meyer family uses a kitchen trash can shaped like a cylinder. It has a height of 18 inches and a base diameter of 12 inches.

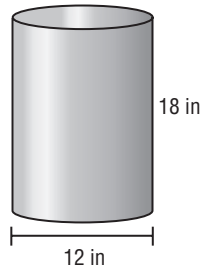

What is the volume of the trash can? Round your answer to the nearest tenth of a cubic inch.

2. **BENCH** Inside a lobby, there is a piece of furniture for sitting. The furniture is shaped like a simple block with a square base 6 feet on each side and a height of $1\frac{3}{5}$ feet.

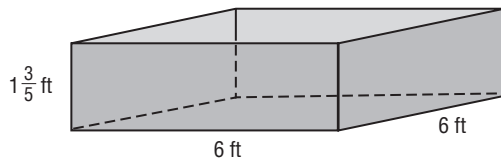

What is the volume of the seat?

3. **FRAMES** Margaret makes a square frame out of four pieces of wood. Each piece of wood is a rectangular prism with a length of 40 centimeters, a height of 4 centimeters, and a depth of 6 centimeters.

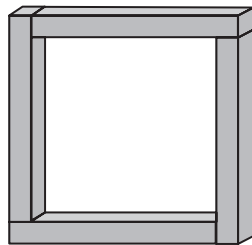

What is the total volume of the wood used in the frame?

4. **PENCIL GRIPS** A pencil grip is shaped like a triangular prism with a cylinder removed from the middle. The base of the prism is a right isosceles triangle with leg lengths of 2 centimeters. The diameter of the base of the removed cylinder is 1 centimeter. The heights of the prism and the cylinder are the same, and equal to 4 centimeters.

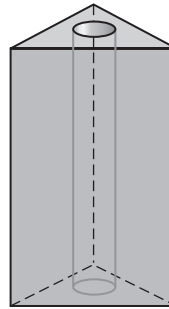

What is the exact volume of the pencil grip?

TUNNELS For Exercises 5 and 6, use the following information.

Construction workers are digging a tunnel through a mountain. The space inside the tunnel is going to be shaped like a rectangular prism. The mouth of the tunnel will be a rectangle 20 feet high and 50 feet wide and the length of the tunnel will be 900 feet.

5. What will the volume of the tunnel be?
6. If instead of a rectangular shape, the tunnel had a semicircular shape with a 50-foot diameter, what would be its volume? Round your answer to the nearest cubic foot.

13-2 Word Problem Practice

Volumes of Pyramids and Cones

1. **ICE CREAM DISHES** The part of a dish designed for ice cream is shaped like an upside-down cone. The base of the cone has a radius of 2 inches and the height is 1.2 inches.

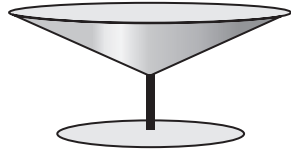

What is the volume of the cone? Round your answer to the nearest hundredth.

2. **GREENHOUSES** A greenhouse has the shape of a square pyramid. The base has a side length of 30 yards. The height of the greenhouse is 18 yards.

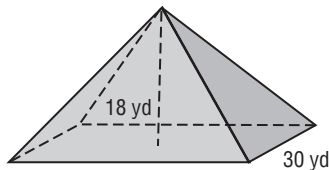

What is the volume of the greenhouse?

3. **TEEPEE** Caitlyn made a teepee for a class project. Her teepee had a diameter of 6 feet. The angle the side of the teepee made with the ground was 65° .

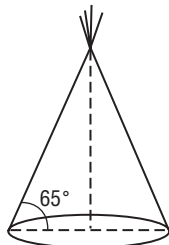

What was the volume of the teepee? Round your answer to the nearest hundredth.

4. **SCULPTING** A sculptor wants to remove stone from a cylindrical block 3 feet high and turn it into a cone. The diameter of the base of the cone and cylinder is 2 feet.

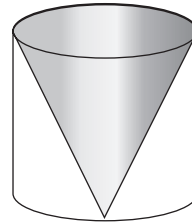

What is the volume of the stone that the sculptor must remove? Round your answer to the nearest hundredth.

STAGES For Exercises 5-7, use the following information.

A stage has the form of a square pyramid with the top sliced off along a plane parallel to the base. The side length of the top square is 12 feet and the side length of the bottom square is 16 feet. The height of the stage is 3 feet.

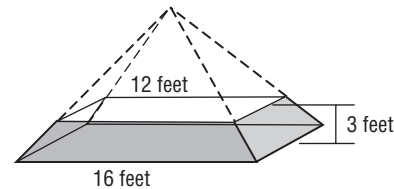

- What is the volume of the entire square pyramid that the stage is part of?
- What is the volume of the top of the pyramid that is removed to get the stage?
- What is the volume of the stage?

13-3 Word Problem Practice**Volumes of Spheres**

1. **BALLS** Many sports use spherical balls. A regulation basketball is a sphere with a diameter of 9 inches. What is the volume of this sphere? Round your answer to the nearest thousandth of a cubic inch.



2. **BILLIARDS** A billiard ball set consists of 16 spheres, each $2\frac{1}{4}$ inches in diameter. What is the total volume of a complete set of billiard balls? Round your answer to the nearest thousandth of a cubic inch.

3. **FRUIT** A cantaloupe is a nearly spherical fruit. Inside, there is a roughly spherical cavity in the center that holds seeds. The flesh surrounds this cavity and extends to the skin of the fruit. The seed cavity is about half the radius of the fruit.

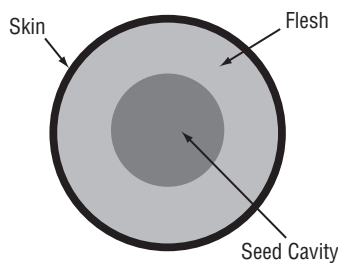

About what percentage of the cantaloupe is edible flesh?

4. **THE ATMOSPHERE** About 99% of Earth's atmosphere is contained in a 31-kilometer thick layer that enwraps the planet. The Earth itself is almost a sphere with radius 6378 kilometers. What is the ratio of the volume of the atmosphere to the volume of Earth? Round your answer to the nearest thousandth.

GLASSES For Exercises 5 and 6, use the following information.

Jordan has two glasses. One is a hemisphere of radius 2 inches. The other is a cylinder with base radius $1\frac{1}{4}$ inches.

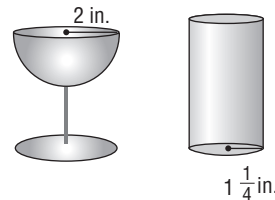

5. What is the volume of the hemispherical glass? Round your answer to the nearest thousandth of a square inch.
6. If the cylindrical glass can hold twice as much water as the hemispherical glass, what is the height of the cylinder? Round your answer to the nearest hundredth of an inch.

13-4 Word Problem Practice***Congruent and Similar Solids***

1. **AQUARIUMS** Manuel has an aquarium that measures 16 inches high, 12 inches deep, and 20 inches long. Abigail has an aquarium that measures 25 inches long, 20 inches high, and 15 inches deep. Are the two aquariums *similar, congruent, or neither*?

2. **SIZES** Earth's diameter is about 3.75 times the diameter of the Moon. How many times as large is Earth compared to the Moon? Round your answer to the nearest hundredth.

3. **MODELS** An architecture firm built a scale model of a building. The scale of the model is 1 inch : 15 inches. The scale model has 3456 square inches of office floor space. How many square feet of office space will the actual building have?

4. **STORAGE** A chemical company wanted to order one cylindrical storage tank 12 feet high with a base diameter of 6 feet. However, because of various cost and shipping factors, the company found it more economical to purchase several cylindrical storage tanks that were only 4 feet high with a base diameter of 2 feet. How many of these smaller tanks must the company purchase to be able to store the volume equivalent of the single large tank?

ICOSAHEDRA For Exercises 5-7, use the following information.

An icosahedron is a Platonic solid that has 20 faces, 30 edges, and 12 vertices. All of the faces of an icosahedron are equilateral triangles. All icosahedra are similar to each other. The figure shows two icosahedra that differ by a scale factor of 5 : 3.

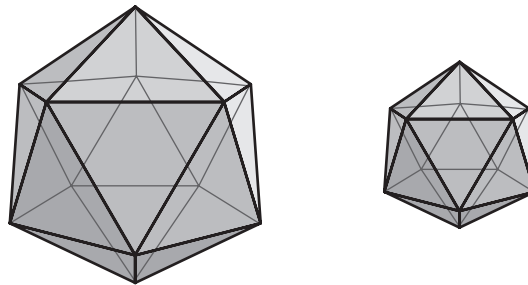

5. What is the ratio of the surface area of the larger icosahedron to the smaller one?
6. What is the ratio of the volume of the larger icosahedron to the smaller one?
7. Suppose the surface area of the larger icosahedron is 100 square feet. What is the surface area of the smaller icosahedron?

13-5 Word Problem Practice

Coordinates in Space

1. **CUBES** Martha needs to specify the coordinates of the vertices of a cube for a computer program. Five of the vertices are located at $(0, 0, 0)$, $(5, 0, 0)$, $(0, 5, 0)$, $(5, 5, 0)$, and $(0, 0, 5)$. What are the coordinates of the remaining three vertices?

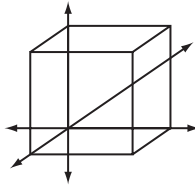

2. **HIKING** Jasmine is going to hike up to the summit of a mountain. The summit is located 4 kilometers east, 2 kilometers north, and 2,375 meters above her current location. How far away is she from the summit? Round your answer to the nearest meter.

3. **ENGINEERING** A bridge is held up by a network of steel rods. In a 3-dimensional model of the network, one of the rods has endpoints located at $(5, 8, -3)$ and $(1, 4, 5)$. Another rod has one endpoint located at $(-5, -2, -6)$ and the other endpoint at the midpoint of the first rod. What are the coordinates of this midpoint?

4. **REFLECTIONS** Norman created a solid that has a plane of symmetry. In other words, if the solid were to be reflected in the plane of symmetry, it would look unchanged. The coordinates of his solid were $(-5, 0, 0)$, $(0, -1, 0)$, $(0, 0, 1)$, $(0, 0, -2)$, $(0, 6, 0)$, and $(5, 0, 0)$. Identify the plane of symmetry.

RECTANGULAR SOLIDS For Exercises 5-8, use the following information.

An architectural plan involves a rectangular solid. The coordinates of one vertex of the solid are $(1, 2, 1)$ and the coordinates of the vertex diagonally opposite are $(3, 5, 4)$. The sides of the solid are parallel or perpendicular to the various coordinate planes. Each unit corresponds to 4 feet.

5. Determine the coordinates of all 8 of the solid's vertices.
6. Sketch a graph of the solid in a 3-dimensional coordinate system.

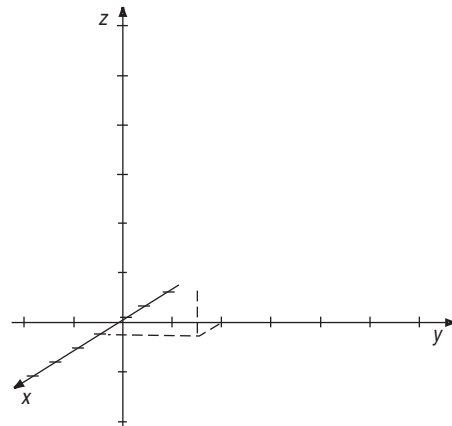

7. What are the dimensions of the solid?
8. What are the surface area and volume of the solid?