

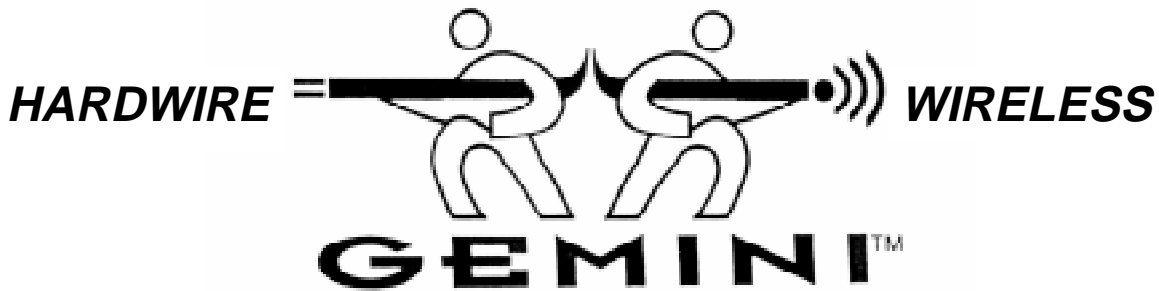

PROGRAMMING INSTRUCTIONS



GEM-P3200 CONTROL PANEL/COMMUNICATOR

Quick Start:

1. Refer to the wiring diagram, connect siren, aux. power, aux. output, remote bus, earth ground, zone and telephone wiring. NOTE: See Installation Instructions (WI817).
2. Connect AC power first and then the battery.
3. Configure the keypad (see page 44).
4. Access the Easy Menu Driven (Dealer Program) Mode:

Press
 Master Security Code (printed on microprocessor can)

Press Until "ACTIVATE PROGRAM Y/N" (GEM-RP1CAe2) or "TURNON PROG Y/N" (GEM-RP2ASe2) appears on LCD screen.

Press To Enter Dealer Program Mode (see page 6).

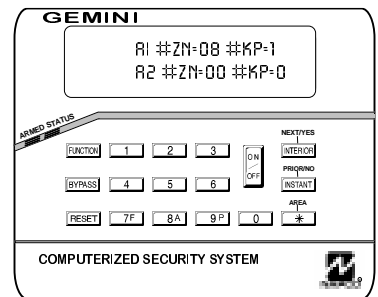

GEM-RP1CA/RP1CAe/RP1CAe2 Keypad

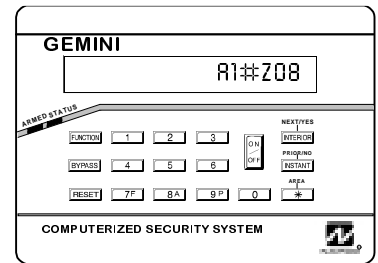

GEM-RP2AS/RP2ASe/RP2ASe2 Keypad

CHANGES FROM PREVIOUS EDITION

The following changes have been made to this manual (WI818B) since the last edition (WI818A).

- ✓ Manual format has been revised.
- ✓ Programming options "RF Transmitters" and "Key fob Transmitters" have been removed from Direct Address Program Mode and are selected only in Easy Menu Driven Program Mode.
- ✓ Programming option "Veri-phone Zones trip Fire Output" (Page 34, Address 2421) has been added.
- ✓ Programming option "Telco Answering Service Override" (Page 34, Address 2421) has been added.
- ✓ Programming option "Keyfob Zone Assignment" (Page 10 & 15) has been added.
- ✓ Programming option "RF Receiver Tamper" (Page 26, Address 0896) has been added.
- ✓ Programming option "Access on Aux. Output" (Page 10 & 15) has been added.
- ✓ Programming option "Disable System Trouble Audible at Keypad" (Page 36, Address 2420) has been added.
- ✓ Programming option "Disable Exit/Entry Urgency Tone at Keypad" (Page 36, Address 2422) has been added.
- ✓ Programming option "Enable Burg. Output on Telco fail only when Armed" (Page 36, Address 2422) has been added.
- ✓ Programming option "Enable Burg. Output for Keyfob Chirp" (page 36, Address 2422) has been added.
- ✓ Programming option "Enable Auxiliary Output Chirp on Keyfob Arm/Disarm" has been renamed to "Enable Output Chirp on Keyfob Arm/Disarm" (Page 36, Address 2421).
- ✓ Programming option Relay Event ID Code "Area 1 Keypad Tamper" has been renamed to "Keypad Tamper" (Page 41).
- ✓ Programming option Relay Event ID Code "Area 2 Keypad Tamper" has been deleted (Page 41).

NOTE: For specific information on any of the listed programming options refer to the Glossary in the GEM-P3200 Installation Instructions (WI817).



NAPCO Security Systems, Inc.
333 Bayview Avenue, Amityville, New York 11701
For Sales and Repairs, call toll free: (800) 645-9445
For direct line to Technical Service, call toll free: (800) 645-9440
Internet: <http://www.napcosecurity.com>

TABLE OF CONTENTS

SYSTEM PROGRAMMING OPTIONS.....	4	<i>User Code Options (Addr 0010-0169)</i>	<i>23</i>
<i>Introduction</i>	<i>4</i>	<i>CS Receiver Opt. (Addr 0520, 0521, 0525, 0526, 0550, 0551, 0575 & 0576).....</i>	<i>25</i>
<i>Downloading from a Computer</i>	<i>4</i>	<i>CS Receiver Tel. Numbers (Addr 0527-0546, 0552-0571, 0577-0596).....</i>	<i>26</i>
EASY MENU DRIVEN PROGRAM MODE.....	5	<i>Download/Callback Options (Addr 4089, 0600-0619, 0625-0647, 1022 & 1023)</i>	<i>26</i>
<i>Dealer Program - Preliminary Information.....</i>	<i>5</i>	<i>CS Subscriber ID Numbers (Addr 0650-0857)</i>	<i>27</i>
<i>Accessing Dealer Program Mode</i>	<i>5</i>	<i>CS Reporting Codes (Addr 0860-0869).....</i>	<i>27</i>
<i>Customizing a Default Program</i>	<i>5</i>	<i>CS Reporting Codes (Addr 0870-0904).....</i>	<i>28</i>
GEM-RP1CAe2 KEYPAD	6	<i>CS Area & System Reporting Opt. (Addr 1024-1027) .</i>	<i>28</i>
<i>Number of Zones & Keypads per Area</i>	<i>6</i>	<i>CS Zone Reporting Codes (Addr 0910-0941).....</i>	<i>29</i>
<i>Local or Central Station Reporting System.....</i>	<i>6</i>	<i>CS User Reporting Codes (Addr 1030-1081).....</i>	<i>30</i>
<i>Central Station Receiver 1 Tel. Number</i>	<i>6</i>	<i>Global System Trbl. Reporting Opt. (Addr 1082-1116) 31</i>	
<i>Central Station Receiver 1 Account Number</i>	<i>6</i>	<i>Area System Trbl. Reporting Opt. (Addr 1120-1137)...</i>	<i>32</i>
<i>Central Station Receiver 1 Format.....</i>	<i>6</i>	<i>Zones 1-16 Options (Addr 1200-1376)</i>	<i>33</i>
<i>Enter User Codes</i>	<i>7</i>	<i>Zones 17-32 Options (Addr 1402-1576)</i>	<i>34</i>
<i>Enter Zone Descriptions</i>	<i>8</i>	<i>System Options (Addr 2415-2419)</i>	<i>35</i>
<i>RF Transmitter Points.....</i>	<i>9</i>	<i>System Options (Addr 2420-2422 & 4084).....</i>	<i>36</i>
<i>Key Fob Transmitters</i>	<i>10</i>	<i>Keypad Options (Addr 2425-2531)</i>	<i>37</i>
<i>Enter Date.....</i>	<i>10</i>	<i>EZM Group Options (Addr 2600-2627).....</i>	<i>38</i>
<i>Enter Time</i>	<i>10</i>	<i>Area Arming Options (Addr 2650 & 2651)</i>	<i>38</i>
GEM-RP2ASe2 KEYPAD	11	<i>Area Output Control Options (Addr 2700-2733)</i>	<i>39</i>
<i>Number of Zones & Keypads per Area</i>	<i>11</i>	<i>Remote Access Logging (Addr 3184).....</i>	<i>39</i>
<i>Local or Central Station Reporting System.....</i>	<i>11</i>	<i>Number of Relay Board Modules (Addr 3777).....</i>	<i>39</i>
<i>Central Station Receiver 1 Tel. Number</i>	<i>11</i>	<i>Ext. Relay Control (Addr 3778-3801 & 2800-2895)</i>	<i>40</i>
<i>Central Station Receiver 1 Account Number</i>	<i>12</i>	<i>RF Rcvrs. & Sup. Timers (Addr 3776 & 3760-3775)....</i>	<i>42</i>
<i>Central Station Receiver 1 Format.....</i>	<i>12</i>	<i>System Reset Features (Addr 4090-4093)</i>	<i>43</i>
<i>Enter User Codes</i>	<i>12</i>	USER PROGRAM MODE.....	44
<i>RF Transmitter Points.....</i>	<i>14</i>	<i>Preliminary Information</i>	<i>44</i>
<i>Key Fob Transmitters</i>	<i>15</i>	<i>Accessing User Program Mode</i>	<i>44</i>
<i>Enter Date.....</i>	<i>15</i>	<i>User Codes</i>	<i>44</i>
<i>Enter Time</i>	<i>15</i>	<i>Zone Descriptions</i>	<i>45</i>
DIRECT ADDRESS PROGRAM MODE.....	16	KEYPAD CONFIGURATION MODE	46
<i>Keypad Programming Overview</i>	<i>16</i>	<i>Keypad Installation.....</i>	<i>46</i>
<i>Accessing Direct Address Program Mode</i>	<i>16</i>	<i>Configuring the Keypads.....</i>	<i>46</i>
<i>What You See on the Keypad.....</i>	<i>16</i>	GEM-P3200 EASY MENU PROG. WORKSHEETS	49
<i>Direct Address Program Mode Keypad Commands</i>	<i>17</i>	KEYPAD PROGRAMMING MODES.....	52
<i>Programming Overview.....</i>	<i>18</i>	PROGRAMMING OPTIONS INDEX.....	57
<i>Direct Address Programming Example.....</i>	<i>19</i>	GEM-P3200 WIRING DIAGRAM.....	64
PROGRAMMING OPTIONS & WORKSHEETS	20		
<i>System Delays (Addr 0000-0002, 2402, 2406 & 2414) 21</i>			
<i>System Delays (Addr 2407, 2408 & 4088).....</i>	<i>21</i>		
<i>System Delays (Addr 2400, 2401, 2403-2405 & 4083) 22</i>			
<i>Keypad System Codes (Addr 0490, 0495 & 0500)</i>	<i>22</i>		

Refer to accompanying GEM-P3200 Installation Instructions (WI817) for installation information.

NOTE: THESE PROGRAMMING INSTRUCTIONS ARE INTENDED AND WRITTEN FOR THE PROFESSIONAL INSTALLER HAVING SUITABLE EXPERIENCE AND INSTALLATION EQUIPMENT. THE UNIT IS DESIGNED TO BE PROGRAMMED USING AN IBM-COMPATIBLE COMPUTER WITH NAPCO PCD3000 SOFTWARE. AFTER PROGRAMMING, BE SURE TO RUN THE PCD3000 ERROR-CHECK UTILITY TO GUARD AGAINST PROGRAMMING CONFLICTS FOR THE TYPE OF SERVICE SELECTED FOR THE INSTALLATION.



SYSTEM PROGRAMMING OPTIONS

INTRODUCTION

The GEM-P3200 control panel may be programmed by various means, each of which will be covered in detail in the sections that follow. Keypad displays shown first are for a GEM-RP1CA/RP1CAe/RP1CAe2, the recommended keypad for programming, then for the GEM-RP2ASe2. The GEM-RP2ASe2 keypad functions similarly; however, because of its reduced display capabilities, messages are abbreviated and will scroll through two or more screens. Zone descriptions cannot be programmed using a GEM-RP2AS/RP2ASe/RP2ASe2 keypad.

- ✓ **Downloading From a Computer.** This is the preferred method. The panel may be downloaded from (or uploaded to) an IBM PC-compatible computer, with a 386 (or higher) microprocessor, either locally or remotely. Napco's PCD3000 Quickloader software, Version Update 3.26 or later features context-sensitive help screens as well as an error-checking utility that prevents programming of incompatible or conflicting data to ensure proper panel operation.
- ✓ **Easy Menu Driven Program (Dealer Program) Mode - Keypad Programming.** The Easy Menu Driven Program Mode allows keypad programming of number of zones in area 1, number of fire zones (both 4-wire and 2-wire), central station reporting, number of entry/exit zones, number of interior zones, number of keypads in area 1, central station telephone number, central station account number, central station receiver format, user codes, rf transmitter points, rf key fob transmitters and zone descriptions. For new panels, a custom default program may be created at the keypad. A menu-driven utility prompts the installer to configure the system. Further detailed customization is done in the Direct Address Program Mode.
- ✓ **Direct Address (Dealer Program) Program Mode - Keypad Programming.** The Direct Address Program Mode is an extension of the Dealer Program Mode wherein data is entered at the keypad by location. This mode is accessed from the Easy Menu Driven Program Mode by pressing the **[RESET]** button at any time.
- ✓ **User Program Mode - Keypad programming.** The User Program Mode is intended for authorized users and is limited to keypad programming of User Codes and Zone Descriptions.

DOWNLOADING FROM A COMPUTER

The control-panel program may be downloaded from the computer by either of the following methods.



Local Downloading

(Note: This procedure should be used after to installation, after peripheral devices are connected.)

For a direct high-speed data transfer to the control panel from a desktop computer, connect the download jack (J1) on the panel to the LOCAL jack (J3) on the Napco PCI2000/3000 computer interface using the supplied 6-conductor cable. (Refer to PCI2000/3000 Installation Instructions WI443 for wiring diagram and procedures.)

Similarly, a high-speed local download may be made in the field using a notebook or laptop computer. Connect J1 on the control panel to a Napco PCI-MINI computer interface using the 6-conductor cable supplied. (Refer to PCI-MINI Installation Instructions WI767.)

Remote Downloading

(Also see PCI2000/3000 Installation Instructions WI443.)



Function Mode. During this procedure, voice contact will be lost, therefore both the installer and the computer operator should be familiar with the operation. When a steady high-pitched tone is heard at the site phone, access the "ACTIVATE DOWNLOAD" Function (see Keypad Programming Modes), then press the **[ON/OFF]** button or the YES (**[INTERIOR]**) button; the site phone will go dead. Hang up the phone and wait for a call from the central station confirming a successful download.

Callback Method. An installed, unattended panel may be programmed or reprogrammed remotely using the Callback-Method Download feature of the PCD3000 software. Remote downloading requires a modem compatible with the PCI2000/3000. Upon answering the call from the computer, the panel will verify the Download Security Code and, if confirmed, will establish a connection. If a Callback Number is programmed into the panel, the panel will automatically disconnect and call the computer at this number before establishing a connection. The panel can support two Callback Numbers to allow downloads from two different offices.

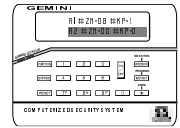
EASY MENU DRIVEN PROGRAM MODE



DEALER PROGRAM - PRELIMINARY INFORMATION

- ☞ Only Keypad #1 may be used for both dealer and user programming, however this keypad may be located in any area.
- ☞ The Master Security Code is *printed on the panel's microprocessor can*. Use this code to enter the Dealer Program Mode to program a custom Dealer Security Code. Record the number, then remove the code label to prevent unauthorized access to the panel. If you forget your Dealer Security Code, use the Master Security Code to enter programming.
- ☞ After entering codes or data, press the save  button. Data will not be stored into memory unless it is pressed.
- ☞ If the keypad is in the Program Mode and no activity is detected for longer than 4 minutes, a steady tone will sound. Silence the sounder by the  button to continue, or by pressing the  button to exit.
- ☞ A panel that has been COLD STARTED (Address Location 4093) performs identically to a new panel.
- ☞ When programming a Two Area System, Direct Address Programming Mode must be used to complete the program.

KEYPAD #1: For ease of programming, it is recommended that a GEM-RP1CA/RP1CAe/RP1CAe2 be used as Keypad #1. (Regardless of which keypad is selected, all *new* keypads are configured as Keypad #1 out of the box.)

If a GEM-RP2AS/RP2ASe/RP2ASe2 is used, configure address jumpers as Keypad #1 (see Configuring the GEM-RP2ASe2 Keypad.). Use the  button to manually scroll through each selected option and at the end of each programming line.

ACCESSING DEALER PROGRAM MODE

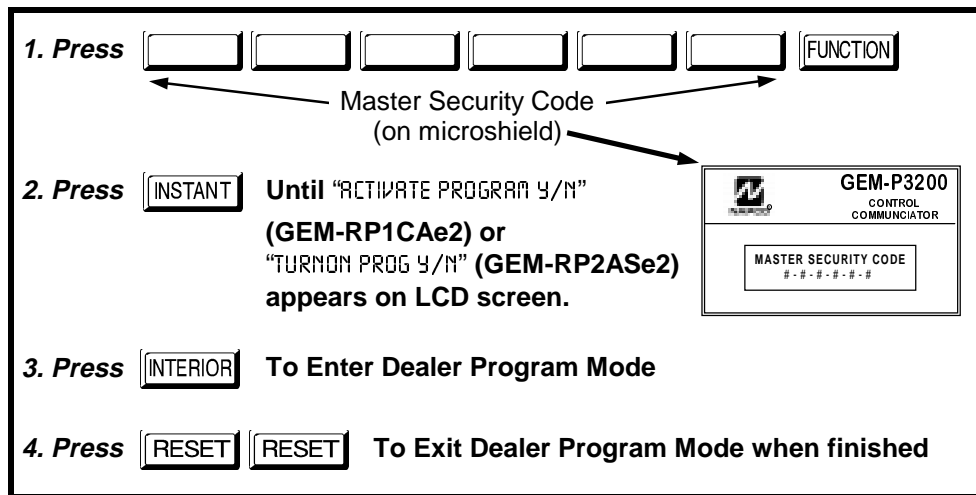



CUSTOMIZING A DEFAULT PROGRAM

For any new panel, you can design a default program that will best suit your application. Using this procedure, you will configure the panel for:

- ✓ Number of Zones per area (in multiples of 4)
- ✓ Number of Keypads per area
- ✓ Type of System (Local or CS Reporting)
- ✓ CS Reporting Features (Telephone Number, Account Number & Receiver Format)
- ✓ User Codes
- ✓ Zone Descriptions
- ✓ RF Transmitter Information (Zone & RF ID number)
- ✓ Date and Time

This procedure will automatically set up system keypads, EZMs, wireless transmitters, etc. After your basic default program has been loaded, you may alter it as necessary in the Direct Address Program Mode in the conventional manner.

NEW PANELS: The custom default program may be created for new panels only. Once the panel has been programmed by any means, the number of areas, zones and keypads will be suppressed and cannot be changed. Should it be necessary to create a new custom default program, (a) from the Dealer Program Mode, press the  button to enter the Direct Address Program Mode; (b) access Location 4091 (Clear Program); (c) press the  button and start over.



A. GEM-RP1CA/RP1CAe/RP1CAe2 Keypad

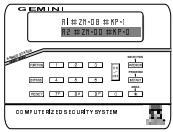

To create your customized default program using a GEM-RP1CA/RP1CAe/RP1CAe2 keypad, enter the following parameters and record your information on the *Easy Menu Programming Worksheet*.

```

R1 #ZN=08 #KP=1
R2 #ZN=00 #KP=0
    
```

(Entry Scrolls)

Number of Zones & Keypads per Area (Appears for New Panel Only)

Use the button to set cursor and the button to select data entry. For Area 1, enter (a) the number of zones (8–24, in multiples of 4), then (b) the number of keypads (1–4). For Area 2 (if used), enter (a) the number of zones (0–24, in multiples of 4), then (b) the number of keypads (0–4). Press to save. Press NEXT () button to proceed.

Notes: (1) The GEM-P3200 is limited to a combined maximum of 32 zones and 7 keypads. However, in this section a maximum of 24 zones and 4 keypads are allowed. (2) The first zone of Area 1 (and Area 2, if selected) will automatically be programmed as Exit/Entry Zones with an entry delay of 30 seconds and an exit delay of 60 seconds. The second zone will be programmed for Exit/Entry Follower. (3) In a single-area system, Zone 8 will be programmed as a 2-Wire Fire Zone. In a two-area system, Zones 7 and 8 will be programmed as 2-Wire Fire Zones and will be common to both areas (set Jumper JP7 to configure the circuit board). (4) All 32 zones and 7 keypads are programmed in Direct Address Program Mode. See Zone and Keypad Options.

```

REPORT ALL ZONES
TO CENTRAL? Y/N
    
```

(Press YES or NO)

Local or Central Station Reporting System (Appears for New Panel Only)

Press YES () button for all zones to report; press NO () button for no zones to report (LOCAL SYSTEM).

```

-----
CENTRAL PHONE #
    
```

(Direct Entry)

Central Station Receiver 1 Telephone Number

Using number buttons, enter telephone number of up to 16 digits including-prefix letters, if necessary, for receiver 1. Use number buttons through for digits 1–9; press the button for a zero and through for letters B–F, respectively. **NOTE:**

Pre-Dial Delay = “D”; Dial-Tone Detection = “E”. Pressing the button will produce a blank space (•). Press to save. Press NEXT () button to proceed. **NOTE:** Central Station Receiver 2 and 3 Telephone Numbers can only be entered in Direct Address Programming. See CS Receiver Options.

```

ACCOUNT # ( ____ )
    
```

(Direct Entry)

Central Station Receiver 1 Account Number

Enter an account number of up to four digits. Use number buttons through for digits 1–9. **NOTE:** Press the button for a zero and press button for a blank space (•). Press to save. Press NEXT () button to proceed. **NOTE:** Central Station Receiver 2 and 3 Account Numbers can only be entered in Direct Address Programming. See CS Reporting Options.

```

RCVR FORMAT {0}
SEE WI FOR INFO
    
```

(Direct Entry)

Central Station Receiver 1 Format

From the table below, enter the central station's receiver format. Use number buttons through . **NOTE:** Press the button for a zero and press for a blank space (•). Press through for letters B–E, respectively.

Press to save. Press NEXT () button to proceed.

DATA ENTRY	CS RECEIVER 1 FORMAT
blank(•)	Ademco Slow, Silent Knight Slow
1	Sescoa, Vertex, DCI, Franklin Fast
2	Radionics Fast
3	Silent Knight Fast
4	Radionics, DCI, Franklin Slow
5	Universal High Speed
8	Radionics BFSK

DATA ENTRY	CS RECEIVER 1 FORMAT
9	FBI 4/3/1
0	Radionics Modem 2
B	SIA
C	Ademco Point ID
D	Ademco Express
E	Pager





NOTE: Modem IIe is available only in Direct Address Programming. Central Station Receiver 2 and 3 Formats can only be entered in Direct Address Programming. See CS Receiver Options.





User# User Code Option /Level Access Control







U01 123 ___ -E3 - ___
 ENTER USER CODE



Enter User Codes (Press the  button to set cursor.)

For default program, enter up to 16 User Codes: up to 8 for Area 1 (Users 01–08) and up to 8 for Area 2 (Users 09–16), with an Authority Level and Access Control Options (if necessary) for each code, as follows. **Note:** Up to 32 users are available using Direct Address Program Mode.

 Press the  button to set the cursor to the User Number. Use the number buttons  through  to enter the User Number.

 Press the  button once to set the cursor to the User Code. Use the number buttons  through  to enter a code of up to 6 digits. Enter up to 6 digits (4 digits is recommended) in the first six boxes from left to right for each user code. Valid entries are: 0-9. **Note:** Press the  button for a zero. No blank spaces in between; leave blank (•) any trailing boxes. If an “Ambush Code” (Address 0495) is entered, *do not* program the first two digits of ANY User Code as the same digits entered for the “Ambush Code”.

 If the programmed code is less than 6 digits, press the  button once to set the cursor to the OPTION/LEVEL. Refer to the tables below for the available User Option and User Level data entries. Enter the user options data in the left digit. Enter the level data (with arming options, if any, added) in the right digit. **Note:** For entries greater than 9, press the   buttons through the   buttons for B through F, respectively.

 For Keypad Access Control, press the  button once again to program applicable keypads. Refer to the tables below, use the number buttons to enter the data for Keypad 1–4 in the right digit; and the data for Keypad 5–8 data in the left digit. (Press the  buttons for blank.)

Example: Enter a code of “123456” as “123456”.

USER OPTIONS

USER CODE (UP TO 6 DIGITS)						USER OPTION	USER LEVEL	ACCESS CONTROL KEYPADS
1	2	3	4	5	6			
1	2	3	4	5	6			

USER OPTIONS				
DATA ENTRIES	BLOCKED VIEW	USER PROGRAM	BYPASS	OVERVIEW
blank (•)		DISABLED		
1	Y			
2		Y		
3	Y	Y		
4			Y	
5	Y		Y	
6		Y	Y	
7	Y	Y	Y	
8				Y
9	Y			Y
0		Y		Y
B	Y	Y		Y
C			Y	Y
D	Y		Y	Y
E		Y	Y	Y
F	Y	Y	Y	Y

DATA ENTRIES	AUTHORITY LEVEL	CODE TYPE
blank (•)	NONE	ARM/DISARM
1	LEVEL 1	ARM/DISARM
2	LEVEL 2	ARM/DISARM
3	LEVEL 3	ARM/DISARM
4	NONE	ARM ONLY
5	LEVEL 1	ARM ONLY
6	LEVEL 2	ARM ONLY
7	LEVEL 3	ARM ONLY
8	NONE	SERVICE
9	LEVEL 1	SERVICE
0	LEVEL 2	SERVICE
B	LEVEL 3	SERVICE

ACCESS CONTROL KEYPADS			
DATA ENTRIES	K.P. 5	K.P. 6	K.P. 7
blank (•)	NONE		
1	Y		
2		Y	
3	Y	Y	
4			Y
5	Y		Y
6		Y	Y
7	Y	Y	Y

ACCESS CONTROL KEYPADS				
DATA ENTRIES	K.P. 1	K.P. 2	K.P. 3	K.P. 4
blank (•)	NONE			
1	Y			
2		Y		
3	Y	Y		
4			Y	
5	Y		Y	
6		Y	Y	
7	Y	Y	Y	
8				Y
9	Y			Y
0		Y		Y
B	Y	Y		Y
C			Y	Y
D	Y		Y	Y
E		Y	Y	Y
F	Y	Y	Y	Y

Note: “Y” indicates option is enabled.

Note: “Y” indicates option is enabled.

Note: Users are assigned to areas in “Enable User Code by Area” (Address 2500-2531) in Direct Address Programming.

USER AUTHORITY LEVEL	
KEYPAD DISPLAY FUNCTION MENU	
FUNCTION	LEVEL*
DISPLAY ZN FAULTS	1
DISPLAY ZN BYPASSED	1
DISPLAY ZN DIRECTORY	1
ACTIVATE BELL TEST	1
DISPLAY PHONE #'S	1
DISPLAY SYS TRBL	1
DISPLAY FIRE ALARM	1
DISPLAY FIRE TRBL	1
DISPLAY OP/CL	3
ACTIVATE OVERVIEW	3**
ACTIVATE CHIME	1
ACTIVATE WATCH	2
RESET SYSTEM TRBL	3
RESET SENSOR MSG	3
START EXIT TIME	1
FAULT FIND	***
ACTIVATE LOCATE	***
EZM ZONE FIND	***
ACTIVATE DIALER TEST	3
DISPLAY ALARM LOG	3
DISPLAY TOTAL LOG	3
DISPLAY FIRE LOG	3
DISPLAY OP/CL LOG	3
DISPLAY SYSTEM LOG	3
AUTOARM IN 1-4HRS	2
DISPLAY AUTARM SCHD	3
ACTIVATE PROGRAM	3**
ACTIVATE DOWNLOAD	3
DISPLY RF XMITTER STAT	1
RELAY CONTROL	1



NOTES:

- * Minimum Level required to access function
- ** Level-3 Code with appropriate user option
- *** Requires Dealer Code

USER OPTIONS	
OPTIONS	EXPLANATION
Disabled	User Code not active in this area.
Blocked View	Allows User Code to block another code from being viewed by another user. An unblocked code cannot view a blocked code, but a blocked code can view all codes. The master user code and the dealer program code can view all codes.
User Program	User Program Option is enabled for Keypad 1 only, wherever it is connected (Area 1 or Area 2). If enabled, Level 3 must also be enabled.
Bypass	Allows User Code to bypass zones.
Overview	This option, along with Level 3 Authorization, enables selection of OVERVIEW mode at a keypad. This Mode provides a system status display of all areas at a glance.
Arm Only	Prevents User Code from disarming this area.
Service	A Service Code has restricted arm/disarm rights; if an area is armed with a Service Code, a "SERVICE ON" appears on the GEM-RP1CAe2 keypad (a "5" on the GEM-RP2ASe2 keypad) and the area can be disarmed with any valid User Code, including a Service Code. If the area is armed with OTHER than a Service Code, it CANNOT be disarmed with a Service Code. This is typically used to allow tradesmen access to premises under control of the owner.
Access	This is normally used to activate a door striker while an area is disarmed. Also program "Access Control on Aux. Output" (Address 2418) and "Aux. Output Access Control Timeout" (Address 2402).

Related User Options: "Ambush Code" (Address 0495), "Panel Access Code" (Address 0490), "Dealer Security Code" (Address 0500) & "Enable User Code by Area" (Address 2500-2531).

Example: Program a code of "2222" for user 02, with User Option of "User Program", User "Level 3" and Access Control Option "Keypad No. 1". Enter "2222" for a user code, "2 3" for user option and "blank(•) 1" for access control option.

CHANGING OR CANCELING A CODE: To change any code, merely program over the existing code as described above and press  to save. Similarly, to cancel a code, blank out each number of the code press  to save to save.





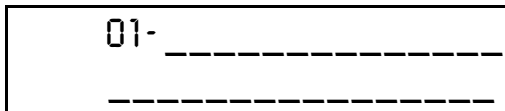

Press  to save each code.

To proceed to the next User Code, set the cursor to the User Number and change it using the number buttons. Program a new User Code as previously described. Press NEXT () button to proceed.

Enter Zone Descriptions



(Direct Entry)

Press the  and  buttons to place the cursor; press the  and  buttons to select the character. For each zone, enter a description of up to two lines. Press  to save each description. To proceed to the next description, place the cursor under the Zone Number (e.g. "01") and change the Zone Number using the  and  buttons. Program a new description as above.

NOTE: Zone Descriptions can only be entered through the GEM-RP1CA/RP1CAe/RP1CAe2 Keypad or by using the Napco Quickloader Software.



Press NEXT () button to proceed.

```

ZN# XMIT# +CS P
ZN01-000000: 0- 0

```

Zone # Mapped to	Xmitter ID	Check Sum	Point #

ID Code number, "A" = ; "B" = ; "C" = ; "D" = ; "E" = ; "F" = . Press  to save. Press NEXT () button to proceed.

```

ZN# XMIT# +CS P
ZN01-000000: 0- 0

```

```

ZN# XMIT# +CS P
ZN01-ENROLL:A--

```

RF Transmitter Points (Press the () button to set cursor.)

(For wireless systems only. Also see *Quick Method*, which follows)

For each transmitter (key fob transmitters also), enter the zone number (01–32) to which the transmitter will be mapped, the 6-digit RF ID #:1-digit checksum number printed on the transmitter and box, the point number (1–4); enter "9" for *unsupervised* (all points). **NOTE:** When programming the

Quick Method. If a receiver is already installed in the panel, Napco transmitter wireless points can be programmed automatically ("enrolled") using the following procedure. **NOTE:** The transmitter point will be enrolled only if the signal strength is 3 or greater.

1. Enter the zone number to which the transmitter point will be mapped.
2. Press the () button to enter the Enroll Mode. The red and green LEDs on the keypad will flash and the window will display as shown at left.
3. Open the loop of the point that is to be programmed (GEM-TRANS2 or GEM-TRANS4 only).

4. Install the transmitter battery. The keypad will beep to indicate that the point has been successfully enrolled. Multi-point transmitters can be mapped to successive zones simultaneously (Example 1) or to selected zones point by point (Example 2).

Example 1. A 4-point transmitter has the RF ID number 410078:1. Map the first three points to Zones 11–13, respectively.

1. Enter the Enroll mode as described in step 2 above.

2. Enter Zone "11".

3. Open the loops of points 1, 2 and 3.

4. Install the transmitter battery. The keypad will beep 3 times to indicate that three points have been programmed.

 Transmitter 410078:1, point 1 will be mapped to Zone 11.

 Transmitter 410078:1, point 2 will be mapped to Zone 12.

 Transmitter 410078:1, point 3 will be mapped to Zone 13.

The keypad will now display Zone 13, the last zone enrolled.

Example 2. A 2-point transmitter has the RF ID number 287613:1. Map point 1 to Zone 6 and point 2 to Zone 9.

1. Enter the Enroll mode as described above.

2. Enter Zone "06".

3. Open point-1 loop.

4. Install the battery. The keypad will beep once to indicate that one point has been programmed. (Transmitter 287613:1, point 1 will be mapped to Zone 6.)

5. Enter Zone "09".

6. Close point-1 loop and open point-2 loop.

7. Remove the transmitter battery, then re-install it. The keypad will beep once to indicate that one point has been programmed. (Transmitter 287613:1, point 2 is mapped to Zone 9.)

KEY FOB ZONE ASSIGNMENT: Key fobs can also be assigned to zones to allow multiple wireless panic buttons on one alarm system, each reporting to a central station, a pager or having a description on the keypad that describes the person holding the key fob, the location where the person holding the key fob is stationed, or the special purpose of the key fob button being depressed. *See the next page on Key fob Zone Assignment.*

```

KF R XMIT# + CS OP
01-0 000000:0 00
    
```

KF #	Area	Xmitter ID	Check Sum	Aux 1&2
------	------	------------	-----------	---------

DATA ENTRY	AUX 1/AUX 2 OPTIONS
0	None
1	Relay Group 1 Toggle
2	Relay Group 2 Toggle
9	Panic
A	Auxiliary
B	Instant
C	Aux. Output Toggle
D	Access on Aux. Output

Key Fob Transmitters (Press the **[FUNCTION]** button to set cursor.)

Keyfobs can be programmed as “Arm/Disarm” devices using their buttons (refer to WI752). For each Key Fob Transmitter, enter:

- the Key Fob Transmitter number (01–08).
- area number to which transmitter is assigned (1 or 2); enter 0 to disable keyfob.

- the 6-digit RF ID # printed on the transmitter (enter all numbers and/or letters, including leading “0”s, if any).
- 1-digit checksum number printed on the transmitter (enter all numbers and/or letters, including leading “0”s, if any).
- Aux-1 Option (see key fob aux 1 & aux 2 options).
- Aux-2 Option (see key fob aux 1 & aux 2 options).

NOTE: Key fobs 1-8 report as Users 25-32.

Note: If the Key Fob is converted for Two Button “Emergency Use” (by cutting an internal jumper), both top or bottom buttons must be depressed to activate an alarm. In this case, the

Aux-1 and Aux-2 cannot be programmed. Press **[ON/OFF]** to save. Press NEXT (**[INTERIOR]**) button to proceed.

Key Fob Zone Assignment (refer to display as shown on the previous page: press the **[INSTANT]** button to go backwards.)

Each of the 4 key fob buttons can be assigned to a zone. For example, On button = point 1; Off button = point 2; A1 = point 3; A2 = point 4. Up to 32 key fobs (using 1 button) or 16 key fobs (using 2 buttons) or 8 key fobs (using all 4 buttons) or any combination up to a maximum of 32 controlled zones can be assigned, providing multiple wireless panic buttons on a system, each reporting to the Central Station or a pager and/or annunciating on a keypad the key fob zone number with description/location. *To assign a key fob to a zone:* program the keyfob as you would a transmitter, entering the keyfob's ID code, check sum and point number at the appropriate zone. The “Quick Method” is not allowed. The zone may be hardwired to a sensor as well as assigned to a key fob (either one will activate the zone alarm output). **NOTE:** If assigning a key fob to a zone, the “ON/OFF” buttons on the key fob will no longer arm/disarm the system. The key fob is converted to a “panic only” device.

```

( MM / DD / YY )
ENTER DATE
    
```

(Direct Entry)

Enter Date (Press the **[FUNCTION]** button to set cursor.)

Enter the current date in the format MM/DD/YY, where MM = the month (01–12); DD=the day (01–31); and YY=the year. Press **[ON/OFF]** to save. Press NEXT (**[INTERIOR]**) button to proceed.

```

( HH : MM A / P )
ENTER TIME
    
```

(Direct Entry)

Enter Time (Press the **[FUNCTION]** button to set cursor.)

Enter the current time in the format HH:MMA/P, where HH=hours (01–12); MM=minutes (00–59). Select Am or Pm by pressing any number button, then press **[ON/OFF]** once again to save.

EXIT DEALER PROGRAM MODE: This completes the custom default program. Press the **[RESET]** button to enter the Direct Address Program Mode for further programming or press the **[RESET]** button once again to end all programming and resume normal keypad operation.

CLEAR PROGRAM: Should it be necessary to create a new custom default program, (a) from the Dealer Program Mode, press the **[RESET]** button to enter the Address Program Mode; (b) access Location 4091 (Clear Program); (c) press **[ON/OFF]** and start over.

A. GEM-RP2AS/RP2ASe/RP2ASe2 Keypad

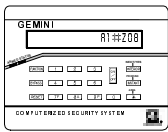

Enter the Master Security Code (printed on microprocessor can) for a new panel or enter your custom Dealer Program Code if programmed. Press NO (**INSTANT**) repeatedly until "TURNON/PROG" is displayed.

NOTE: If you pass "TURNON/PROG", you can scroll back by pressing the **BYPASS** button. Press YES (**INTERIOR**) to enter the Dealer Program Mode. This keypad displays messages in multiple segments. Press the **FUNCTION** button to scroll through each segment.

A1#Z08

A1#KP1

A2#Z00

A2#KPO

(Direct Entry)

Number of Zones & Keypads per Area *(Appears for New Panel Only)*

Press the **FUNCTION** button to scroll screens. Use the **2** button to set cursor and the **3** button to select data entry. For Area 1, enter (a) the number of zones (8–24, in multiples of 4), then (b) the number of keypads (1–4). For Area 2 (if used), enter (a) the number of zones (0–24, in multiples of 4), then (b) the number of keypads (0–4). Press **ON/OFF** to save. Press NEXT (**INTERIOR**) button to proceed.

Note: (1) The GEM-P3200 is limited to a combined maximum of 32 zones and 7 keypads. (2) The first zone of Area 1 (and Area 2, if selected) will automatically be programmed as Exit/Entry Zones with an entry delay of 30 seconds and an exit delay of 60 seconds. The second zone will be programmed for Exit/Entry Follower. (3) In a single-area system, Zone 8 will be programmed as a 2-Wire Fire Zone. In a two-area system, Zones 7 and 8 will be programmed as 2-Wire Fire Zones and will be common to both areas (set Jumper JP7 to configure the circuit board).

REPORT

ALL ZN

Y/N

(Press YES or NO)

Local or Central Station Reporting System *(Appears for New Panel Only)*

Press the **FUNCTION** button to scroll screens. Press YES (**INTERIOR**) button for all zones to report; press NO (**INSTANT**) button for no zones to report (LOCAL SYSTEM).

PHONE#

(_____)

_____)

(Direct Entry)

Central Station Receiver 1 Telephone Number

Press the **FUNCTION** button to scroll screens. Using number buttons, enter telephone number of up to 16 digits including prefix letters, if necessary, for receiver 1. Use number buttons **1** through **9P** for digits 1–9; press the *** 0** button for a zero and *** 1** through *** 5** for letters B–F, respectively. **NOTE:** Pre-Dial Delay = "D"; Dial-Tone Detection = "E". Pressing the **0** button will produce a blank space (•).

Press **ON/OFF** to save. Press NEXT (**INTERIOR**) button to proceed.

NOTE: The GEM-RP2AS/RP2ASe/RP2ASe2 keypad provides a maximum of 10 digits in this mode. To program additional digits, go to the Direct Address Program Mode and continue from Location 0537. Central Station Receiver 2 and 3 Telephone Numbers can only be entered in Direct Address Programming. See CS Receiver Options.

GEM-RP2AS/RP2ASe Keypads: Zones & Keypads per Area, CS Reporting, CS Tel. No. & CS Acct. No.



ACC#

[]

(Direct Entry)

Central Station Receiver 1 Account Number

Press the **[FUNCTION]** button to scroll screens. Enter an account number of up to four digits. Use number buttons **[1]** through **[9P]** for digits 1–9. **NOTE:** Press the **[*]** **[0]** button for a zero and press **[0]** button for a blank space (•). Press **[ON/OFF]** to save. Press NEXT (**[INTERIOR]**) button to proceed.

NOTE: Central Station Receiver 2 and 3 Account Numbers can only be entered in Direct Address Programming. See CS Reporting Options.

REC FMT

[0]

(Direct Entry)

Central Station Receiver 1 Format

Press the **[FUNCTION]** button to scroll screens. From the table below, enter the central station's receiver format. Use number buttons **[1]** through **[9P]**.

NOTE: Press the **[*]** **[0]** button for a zero and press **[0]** for a blank space (•). Press **[*]** **[1]** through **[*]** **[4]** for letters B–E, respectively.

Press **[ON/OFF]** to save. Press NEXT (**[INTERIOR]**) button to proceed.

DATA ENTRY	CS RECEIVER 1 FORMAT
blank(•)	Ademco Slow, Silent Knight Slow
1	Sescoa, Vertex, DCI, Franklin Fast
2	Radionics Fast
3	Silent Knight Fast
4	Radionics, DCI, Franklin Slow
5	Universal High Speed
8	Radionics BFSK

DATA ENTRY	CS RECEIVER 1 FORMAT
9	FBI 4/3/1
0	Radionics Modem 2
B	SIA
C	Ademco Point ID
D	Ademco Express
E	Pager

NOTE: Modem IIe is available only in Direct Address Programming. Central Station Receiver 2 and 3 Formats can only be entered in Direct Address Programming. See CS Receiver Options.

USER01

123 ___

OPT E3

ACC _

(Direct Entry)

Enter User Codes

Press the **[FUNCTION]** button to scroll screens. For default program, enter up to 16 User Codes: up to 8 for Area 1 (Users 01–08) and up to 8 for Area 2 (Users 09–16), with an Authority Level and Access Control Options (if necessary) for each code, as follows. **Note:** Up to 32 users are available using Direct Address Program Mode.

Press the **[FUNCTION]** button to set the cursor to the User Number. Use the number buttons **[1]** through **[9P]** to enter the User Number.

Press the **[FUNCTION]** button once to set the cursor to the User Code. Use the number buttons **[1]** through **[9P]** to enter a code of up to 6 digits. Enter up to 6 digits (4 digits is recommended) in the first six boxes from left to right for each user code. Valid entries are: 0-9. **Note:** Press the **[0]** button for a zero. No blank spaces in between; leave blank (•) any trailing boxes. If an “Ambush Code” (Address 0495) is entered, *do not* program the first two digits of ANY User Code as the same digits entered for the “Ambush Code”.

If the programmed code was less than 6 digits, press the **[FUNCTION]** button once to set the cursor to the OPTION/LEVEL. Refer to the tables shown for the available data entries. Enter the options data in the left digit. Enter the level data (with arming options, if any, added) in the right digit. **Note:** For entries greater than 9, press the **[*]** **[1]** buttons through the **[*]** **[5]** buttons for B through F, respectively.

For Keypad Access Control, press the **[FUNCTION]** button once again to program applicable keypads. Refer to the tables shown, use the number buttons to enter the data for Keypad 1–4 data in the right digit; and the data for Keypad 5–7 data in the left digit. (Press the **[0]** buttons for blank.)

Note: Users are assigned to areas in “Enable User Code by Area” (Address 2500-2531) in Direct Address Programming.

Example: Enter a code of "123456" as "123456".

USER OPTIONS					
USER CODE (UP TO 6 DIGITS)					
1	2	3	4	5	6

USER OPTIONS				
DATA ENTRIES	BLOCKED VIEW	USER PROGRAM	BYPASS	OVERVIEW
blank (*)	DISABLE			
1	Y			
2		Y		
3	Y	Y		
4			Y	
5	Y		Y	
6		Y	Y	
7	Y	Y	Y	
8				Y
9	Y			Y
0		Y		Y
B	Y	Y		Y
C			Y	Y
D	Y		Y	Y
E		Y	Y	Y
F	Y	Y	Y	Y

Note: "Y" indicates option is enabled.

DATA ENTRIES	AUTHORITY LEVEL	CODE TYPE
blank (*)	NONE	ARM/DISARM
1	LEVEL 1	ARM/DISARM
2	LEVEL 2	ARM/DISARM
3	LEVEL 3	ARM/DISARM
4	NONE	ARM ONLY
5	LEVEL 1	ARM ONLY
6	LEVEL 2	ARM ONLY
7	LEVEL 3	ARM ONLY
8	NONE	SERVICE
9	LEVEL 1	SERVICE
0	LEVEL 2	SERVICE
B	LEVEL 3	SERVICE

ACCESS CONTROL KEYPADS			
DATA ENTRIES	K.P. 5	K.P. 6	K.P. 7
blank (*)	NONE		
1	Y		
2		Y	
3	Y	Y	
4			Y
5	Y		Y
6		Y	Y
7	Y	Y	Y

Note: "Y" indicates option is enabled.

ACCESS CONTROL KEYPADS				
DATA ENTRIES	K.P. 1	K.P. 2	K.P. 3	K.P. 4
blank (*)	NONE			
1	Y			
2		Y		
3	Y	Y		
4			Y	
5	Y		Y	
6		Y	Y	
7	Y	Y	Y	
8				Y
9	Y			Y
0		Y		Y
B	Y	Y		Y
C			Y	Y
D	Y		Y	Y
E		Y	Y	Y
F	Y	Y	Y	Y

Note: "Y" indicates option is enabled.

NOTES:

- * Minimum Level required to access function
- ** Level-3 Code with appropriate user option
- *** Requires Dealer Code

KEYPAD DISPLAY FUNCTION MENU	
FUNCTION	LEVEL*
DISPLAY ZN FAULTS	1
DISPLAY ZN BYPASSED	1
DISPLAY ZN DIRECTORY	1
ACTIVATE BELL TEST	1
DISPLAY PHONE #'S	1
DISPLAY SYS TRBL	1
DISPLAY FIRE ALARM	1
DISPLAY FIRE TRBL	1
DISPLAY OP/CL	3
ACTIVATE OVERVIEW	3**
ACTIVATE CHIME	1
ACTIVATE WATCH	2
RESET SYSTEM TRBL	3
RESET SENSOR MSG	3
START EXIT TIME	1
FAULT FIND	***
ACTIVATE LOCATE	***
EZM ZONE FIND	***
ACTIVATE DIALER TEST	3
DISPLAY ALARM LOG	3
DISPLAY TOTAL LOG	3
DISPLAY FIRE LOG	3
DISPLAY OP/CL LOG	3
DISPLAY SYSTEM LOG	3
AUTOARM IN 1-4HRS	2
DISPLAY AUTARM SCHD	3
ACTIVATE PROGRAM	3**
ACTIVATE DOWNLOAD	3
DISPLY RF XMITTER STAT	1
RELAY CONTROL	1



OPTIONS	EXPLANATION
Disabled	User Code not active in this area.
Blocked View	Allows User Code to block another code from being viewed by another user. An unblocked code cannot view a blocked code, but a blocked code can view all codes. The master user code and the dealer program code can view all codes.
User Program	User Program Option is enabled for Keypad 1 only, wherever it is connected (Area 1 or Area 2). If enabled, Level 3 must also be enabled.
Bypass	Allows User Code to bypass zones.
Overview	This option, along with Level 3 Authorization, enables selection of OVERVIEW mode at a keypad. This Mode provides a system status display of all areas at a glance.
Arm Only	Prevents User Code from disarming this area.
Service	A Service Code has restricted arm/disarm rights; if an area is armed with a Service Code, a "SERVICE ON" appears on the GEM-RP1CAe2 keypad (a "5" on the GEM-RP2ASe2 keypad) and the area can be disarmed with any valid User Code, including a Service Code. If the area is armed with OTHER than a Service Code, it CANNOT be disarmed with a Service Code. This is typically used to allow tradesmen access to premises under control of the owner.
Access	This is normally used to activate a door striker while an area is disarmed. Also program "Access Control on Aux. Output" (Address 2418) and "Aux. Output Access Control Timeout" (Address 2402).

Related User Options: "Ambush Code" (Address 0495), "Panel Access Code" (Address 0490) & "Dealer Security Code" (Address 0500).

Press  to save each code.

To proceed to the next User Code, set the cursor to the User Number and change it using the number buttons. Program a new User Code as previously described. Press NEXT () button to proceed.

Example: Program a code of "2222" for user 02, with User Option of "User Program", User "Level 3" and Access Control Option "Keypad No. 1". Enter "2222" for a user code, "2 3" for user option and "blank(*) 1"

CHANGING OR CANCELING A CODE: To change any code, merely program over the existing code as described above and press  to save. Similarly, to cancel a code, blank out each number of the code press  to save.

ZN#01

000000

:0 PTO

(Direct Entry)

ZN#11

ENROLL

:0 PT-

(Direct Entry)

RF Transmitter Points*(For wireless systems only. Also see Quick Method, which follows)*

Press the (FUNCTION) button to set cursor. For each transmitter (key fob transmitters also), enter the zone number (01–32) to which the transmitter will be mapped, the 6-digit RF ID #:1-digit checksum number printed on the transmitter and box, the point number (1–4); enter "9" for unsupervised (all points). **NOTE:** When programming the ID Code number, "A" = [*] [0]; "B" = [*] [1]; "C" = [*] [2]; "D" = [*] [3]; "E" = [*] [4]; "F" = [*] [5]. Press [ON/OFF] to save. Press NEXT (INTERIOR) button to proceed.

Quick Method. If a receiver is already installed in the panel, Napco transmitter wireless points can be programmed automatically ("enrolled") using the following procedure. **NOTE:** The transmitter point will be enrolled only if the signal strength is 3 or greater.

1. Enter the zone number to which the transmitter point will be mapped.
2. Press the [BYPASS] button to enter the Enroll Mode. The red and green LEDs on the keypad will flash and the window will display as shown at left.
3. Open the loop of the point that is to be programmed (GEM-TRANS2 or GEM-TRANS4 only).
4. Install the transmitter battery. The keypad will beep to indicate that the point has been successfully enrolled. Multi-point transmitters can be mapped to successive zones simultaneously (Example 1) or to selected zones point

by point (Example 2).

Example 1. A 4-point transmitter has the RF ID number 410078:1. Map the first three points to Zones 11–13, respectively.

1. Enter the Enroll mode as described in step 2 above.
2. Enter Zone "11".
3. Open the loops of points 1, 2 and 3.
4. Install the transmitter battery. The keypad will beep 3 times to indicate that three points have been programmed.
 - ☞ Transmitter 410078:1, point 1 will be mapped to Zone 11.
 - ☞ Transmitter 410078:1, point 2 will be mapped to Zone 12.
 - ☞ Transmitter 410078:1, point 3 will be mapped to Zone 13.

The keypad will now display Zone 13, the last zone enrolled.

Example 2. A 2-point transmitter has the RF ID number 287613:1. Map point 1 to Zone 6 and point 2 to Zone 9.

1. Enter the Enroll mode as described above.
2. Enter Zone "06".
3. Open point-1 loop.
4. Install the battery. The keypad will beep once to indicate that one point has been programmed. (Transmitter 287613:1, point 1 will be mapped to Zone 6.)
5. Enter Zone "09".
6. Close point-1 loop and open point-2 loop.
7. Remove the transmitter battery, then re-install it. The keypad will beep once to indicate that one point has been programmed. (Transmitter 287613:1, point 2 is mapped to Zone 9.)







KEY FOB ZONE ASSIGNMENT: Key fobs can also be assigned to zones to allow multiple wireless panic buttons on one alarm system, each reporting to a central station, a pager or having a description on the keypad that describes the person holding the key fob, the location where the person holding the key fob is stationed, or the special purpose of the key fob button being depressed. See the next page on Key fob Zone Assignment.

KF0801
AREA 0
000000
:000

(Direct Entry)

Key Fob Transmitters (Press the **[FUNCTION]** button to set cursor.)

Press the **[FUNCTION]** button to set cursor. Keyfobs can be programmed as "Arm/Disarm" devices (refer to WI752). For each Key Fob Transmitter, enter:

-  the Key Fob Transmitter number (01–08).
-  area number to which transmitter is assigned (1 or 2); enter 0 to disable keyfob.
-  the 6-digit RF ID # printed on the transmitter (enter all numbers and/or letters, including leading "0"s, if any).
-  1-digit checksum number printed on the transmitter (enter all numbers and/or letters, including leading "0"s, if any).
-  Aux-1 Option (see key fob aux 1 & aux 2 options).
-  Aux-2 Option (see key fob aux 1 & aux 2 options).

NOTE: Key fobs 1-8 report as Users 25-32.

DATA ENTRY	AUX 1/AUX 2 OPTIONS	DATA ENTRY	AUX 1/AUX 2 OPTIONS
0	None	A	Auxiliary
1	Relay Group 1 Toggle	B	Instant
2	Relay Group 2 Toggle	C	Aux. Output Toggle
9	Panic	D	Access on Aux. Output

Note: If the Key Fob is converted for Two Button "Emergency Use" (by cutting an internal jumper), both top or bottom buttons must be depressed to activate an alarms. In this case, the Aux-1 and Aux-2 cannot be programmed.

Press  to save. Press NEXT **[INTERIOR]** button to proceed.

Key Fob Zone Assignment (refer to display as shown on the previous page: press the **[INSTANT]** button to go backwards.)

Each of the 4 key fob buttons can be assigned to a zone. For example, On button = point 1; Off button = point 2; A1 = point 3; A2 = point 4. Up to 32 key fobs (using 1 button) or 16 key fobs (using 2 buttons) or 8 key fobs (using all 4 buttons) or any combination up to a maximum of 32 controlled zones can be assigned, providing multiple wireless panic buttons on a system, each reporting to the Central Station or a pager and/or annunciating on a keypad the key fob zone number with description/location. *To assign a key fob to a zone:* program the keyfob as you would a transmitter, entering the keyfob's ID code, check sum and point number at the appropriate zone. The "Quick Method" is not allowed. The zone may be hardwired to a sensor as well as assigned to a key fob (either one will activate the zone alarm output). **NOTE:** If assigning a key fob to a zone, the "ON/OFF" buttons on the key fob will no longer arm/disarm the system. The key fob is converted to a "panic only" device.

DATE
07/18
/96

(Direct Entry)

Enter Date

Press the **[FUNCTION]** button to set cursor. Enter the current date in the format MM/DD/YY, where MM = the month (01–12); DD=the day (01–31); and YY=the year. Press  to save. Press NEXT **[INTERIOR]** button to proceed.

TIME
09:10A

(Direct Entry)

Enter Time

Press the **[FUNCTION]** button to set cursor. Enter the current time in the format HH:MMA/P, where HH=hours (01–12); MM=minutes (00–59). Select Am or Pm by pressing any number button, then press  once again to save.

EXIT DEALER PROGRAM MODE: This completes the custom default program. Press the **[RESET]** button to enter the Direct Address Program Mode for further programming or press the **[RESET]** button once again to end all programming and resume normal keypad operation.

GEM-RP2AS/RP2ASe Keypads: Keyfob Transmitters, Date, Time & Exit Dealer Program Mode

DIRECT ADDRESS PROGRAM MODE



This is an extension of the Dealer Program Mode. This method of programming is used in conjunction with the Keypad Programming Worksheets that follow. Refer to these worksheets to identify the 4-digit location (address) of the feature to be programmed. An illustrative example is provided on the next page.

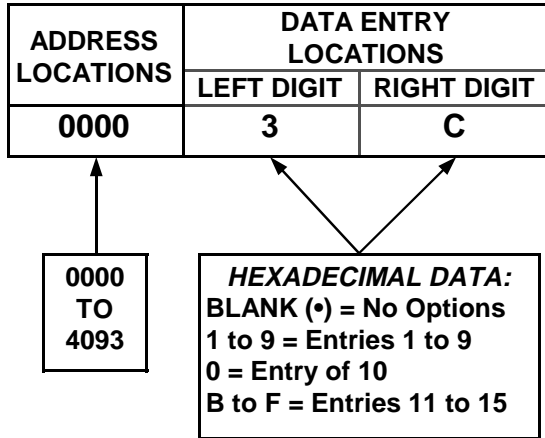

KEYPAD PROGRAMMING OVERVIEW

Direct Address Programming allows you to go directly to the address locations and change the data entries to customize your control panel options. Whereas the Easy Menu Program Mode is a simple quick start guide with limited options, the Direct Address Program Mode is more flexible allowing you to change all the options. It consists of multiple address locations (up to 4093) with two data entry locations each (left and right) as shown in the adjacent diagram.

Accessing Direct Address Program Mode

ACCESSING DIRECT ADDRESS PROGRAM MODE

1. Press
 Master Security Code (printed on microprocessor can) or Dealer Security Code (Address 0500)
2. Press Until "ACTIVATE PROGRAM Y/N" (GEM-RP1CAe2) or "TURNON PROG Y/N" (GEM-RP2ASe2) appears on LCD screen.
3. Press To Enter Dealer Program Mode
4. Press To Exit Easy Menu Driven Program Mode & Enter Direct Address Program Mode

WHAT YOU SEE ON THE KEYPAD

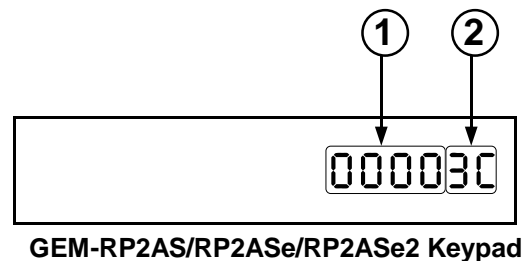
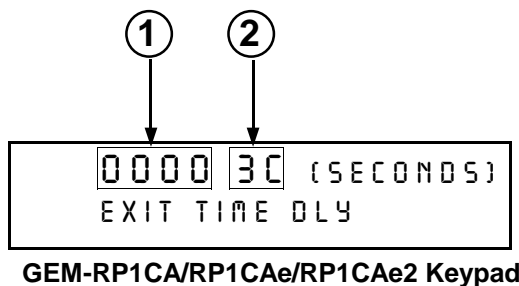

① = ADDRESS LOCATION ② = DATA ENTRY LOCATION (Left and Right Digits)

DIRECT ADDRESS PROGRAM MODE KEYPAD COMMANDS

A. GEM-RP1CA/RP1CAe/RP1CAe2 Keypads

TO ACCESS, PRESS **[RESET]**
IN DEALER PROGRAM MODE.

1. TOGGLE CURSOR TO
4-DIGIT ADDRESS FIELD
USING **[FUNCTION]** BUTTON.

2. ENTER ADDRESS NUMBER
DIRECTLY USING NUMBER
BUTTONS.

3. ENTER DATA DIRECTLY
USING NUMBER BUTTONS.*

4. PRESS **[ON/OFF]** TO SAVE.

TO EXIT, PRESS **[RESET]**.

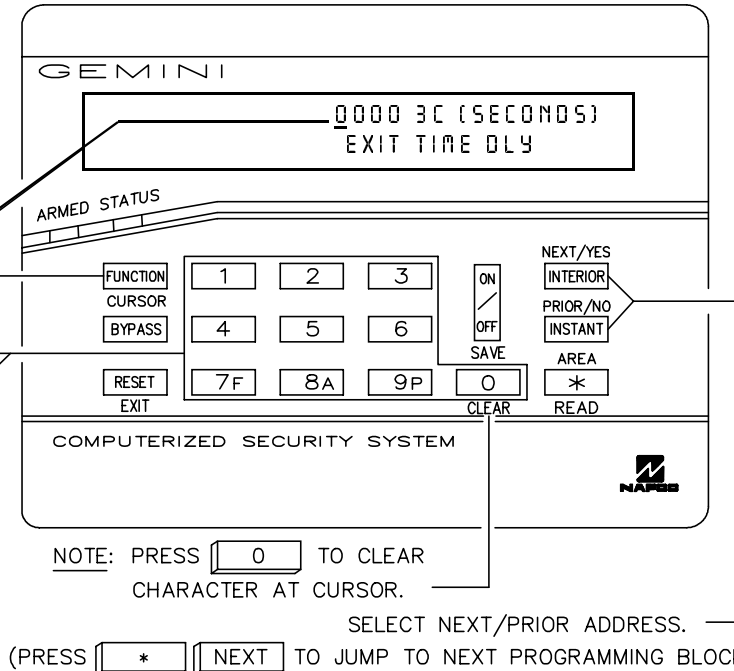

PRESS "[][0]"-"[*][5]" FOR 10-15 (A-F), RESPECTIVELY.

B. GEM-RP2AS/RP2ASe/RP2ASe2 Keypad

TO ACCESS, PRESS **[RESET]**
IN DEALER PROGRAM MODE.

1. TOGGLE CURSOR TO 4-DIGIT
ADDRESS FIELD USING
[FUNCTION] BUTTON.

2. ENTER ADDRESS
NUMBER DIRECTLY
USING NUMBER BUTTONS.

3. ENTER DATA DIRECTLY
USING NUMBER BUTTONS.*

4. PRESS **[ON/OFF]** TO SAVE.

TO EXIT, PRESS **[RESET]**.

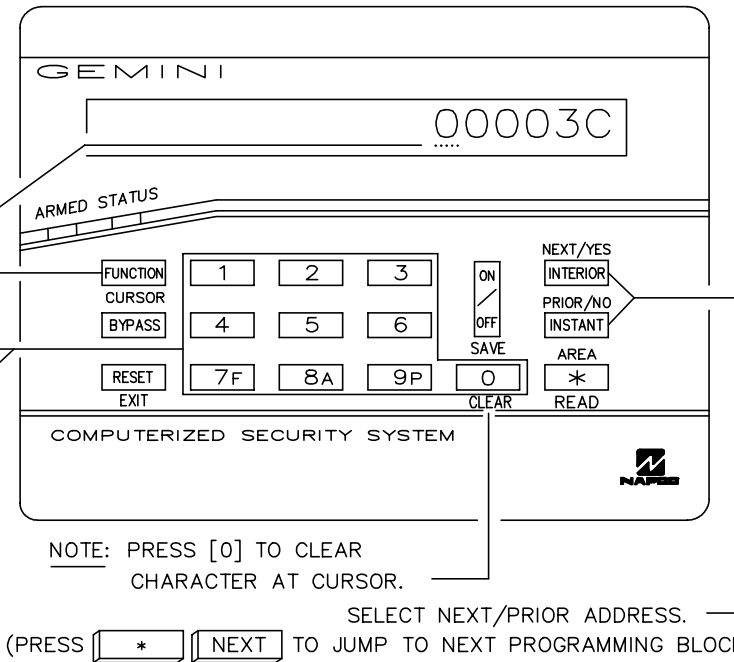

PRESS "[][0]"-"[*][5]" FOR 10-15 (A-F), RESPECTIVELY.

The displays shown on the previous page will appear after a brief delay.

- ☞ Use the the **[BYPASS]** button to toggle the cursor between the 4-digit address field and the data entry locations.
- ☞ Enter the address directly using the number buttons.
- ☞ The contents of the address will be read automatically, along with the feature name and programming information. The cursor will advance to the data field. Enter the required data directly using the number buttons.
- ☞ Press **[ON/OFF]** to save the contents of each address.

EXIT DIRECT ADDRESS PROGRAM MODE: When done, press the **[RESET]** button to exit and resume normal keypad operation.

PROGRAMMING OVERVIEW

The Keypad Programming Worksheets in the back are provided as an address-programming reference to help the installer modify his custom default program or to make minor field alterations to an existing panel program. It is recommended that the panel be uploaded to Napco's Quickloader software following any keypad programming and that the PCD3000's error-check feature be utilized to reduce the possibility of programming omissions or conflicts.

Note: Most of the addresses shown comprise two data entry locations, left and right digits. Program the left digits on the left data-display segment, and the right digit on the right segment. For those addresses having only one programmable nibble, program the right segment only; the left segment should display a blank (•).

Keep the Keypad Programming Worksheets on file for future reference.

General Programming Steps

- ☞ 1. Contact the central station to ascertain receiver format, data format, event codes, subscriber numbers and telephone number(s).
- ☞ 2. Select the desired features by circling  the respective "address" boxes. Refer to the Programming Options and Worksheets for guidance in selecting the "data" (1,2,4,8) to be entered into those boxes.
- ☞ 3. Program the data entered in the boxes on the worksheets into the respective addresses. The display will show the entry numerically, but will display "0" for the number 10, and letters "B", "C", "D", "E", and "F" for the numbers 11 through 15, respectively. To program a 10, press **[*] [0]**. To program 11 through 15, press **[*] [1]** through **[*] [5]**, respectively.

NOTE: See the Direct Address Programming Example on the following page.



DATA ENTRY SELECTIONS (BINARY VALUE CIRCLED) 				ENTRY TOTAL	PRESS 	KEYPAD DISPLAYS
8	4	2	1	blank	[0]	•
8	4	2	①	1	[1]	1
8	4	②	1	2	[2]	2
8	4	②	①	3	[3]	3
8	④	2	1	4	[4]	4
8	④	2	①	5	[5]	5
8	④	②	1	6	[6]	6
8	④	②	①	7	[7F]	7
⑧	4	2	1	8	[8A]	8
⑧	4	2	①	9	[9P]	9
⑧	4	②	1	10	[*] [0]	0
⑧	4	②	①	11	[*] [1]	B
⑧	④	2	1	12	[*] [2]	C
⑧	④	2	①	13	[*] [3]	D
⑧	④	②	1	14	[*] [4]	E
⑧	④	②	①	15	[*] [5]	F



Table 1. Determining data entry for a location (each "nibble"). Numbers in parentheses indicate data for selected zones or features. (See Programming Worksheets that follow.)

Direct Address Programming Example

Example: Program Zones 6, 7 and 8 as Exit/Entry Follower Zones.

DETERMINE THE DATA ENTRIES

1. Referring to ZONE FEATURES in the Programming Worksheets that follow, Exit/Entry Follower for Zones 5 through 8 are located at address 1218, left digit. Circle the data values for Zones 5–8.
2. Add the data values for Zones 6, 7 and 8: $2+4+8=14$. From Tables 1 and 2, "14" (E) is entered as press . The right digit (for Zones 1 through 4, none of which are Exit/Entry Follower Zones) is entered as a blank (•).

ZONE OPTION	ZONES LEFT DATA VALUES				ADDRESS			ZONES RIGHT DATA VALUES			
	SUM = 14 (CIRCLE )				0506			SUM = 0 (CIRCLE )			
	ZN08	ZN07	ZN06	ZN05	L	ADDR	R	ZN04	ZN03	ZN02	ZN01
EXIT/ENTRY FOLLOWER	⑧	④	②	1	E	1218	blank (•)	8	4	2	1

ENTER DATA 

PROGRAM THE DATA ENTRIES

1. Enter the panel's Dealer Security Code (Address 0500), then press the button.
2. Answer NO () to all questions until "ACTIVATE PROGRAM Y/N" is displayed; then press YES ().
NOTE: If you pass "ACTIVATE PROGRAM", scroll backward using the button.
3. Press the button to enter the Address Program Mode. Address "0000" will display.
4. Press to access Address 1218. The data for both digits will display and the cursor will advance to the data field.
5. Press to enter an "E" in the left digit and press to enter a blank (•) in the right digit.
6. Press to save.

Address 1218 is now programmed with "E•".

SYSTEM DELAYS & TIMEOUTS (ADDRESS 0000-0002, 2402, 2406 & 2414)

EXIT DELAY (sec.)	ADDRESS 0000	
	LEFT	RIGHT

[Default = 3C]

ENTRY DELAY 1 (sec.)	ADDRESS 0001	
	LEFT	RIGHT

[Default = 1E]

ENTRY DELAY 2 (sec.)	ADDRESS 0002	
	LEFT	RIGHT

[Default = 1 E]

Aux. Output Access Control Timeout (sec.)	ADDRESS 2402	
	LEFT	RIGHT

ABORT DELAY (sec.)	ADDRESS 2406	
	LEFT	RIGHT

[Default = blank (•) blank (•)]

DATA ENTRIES		DELAY/ TIMEOUT
LEFT	RIGHT	
blank (•)	blank (•)	0 sec.
blank (•)	F	15 sec.
1	E	30 sec.
2	D	45 sec.
3	C	60 sec.
5	0	90 sec.
7	8	120 sec.
↓	↓	↓
F	F	255 sec.

1. Select delay/timeout (0-255 sec.) from the table shown.
2. Enter in corresponding address locations above (left and right digits).
3. For a desired delay/timeout not listed do the following:
 - A. Choose a desired delay/timeout, ex: 20 sec.
 - B. Divide it by 16

$$\begin{array}{r}
 \textcircled{1} \text{ Quotient} \longrightarrow \text{Left Digit} \\
 16 \overline{) 20} \\
 \underline{-16} \\
 \textcircled{4} \text{ Remainder} \longrightarrow \text{Right Digit}
 \end{array}$$

Telephone Line Test Delay (sec.)	ADDRESS 2414	
	LEFT	RIGHT

[Default = blank (•) blank (•)]

EXIT/ENTRY DELAYS: Apply only to zones programmed with the following options "Entry/Exit 1, Entry/Exit 2, Exit/Entry Follower". For UL Installations, the maximum exit delay is 60 seconds and the maximum entry delay is 45 seconds.

PROGRAMMING TIMEOUTS: Either use the tables provide or calculate your own timeout using the steps indicated. **WARNING:** Timers have uncertainty of +/-1sec, so a "time" of 1 second may actually timeout IMMEDIATELY.

SYSTEM DELAYS & TIMEOUTS (ADDRESS 2407, 2408 & 4088)

CHIME TIMEOUT (¼sec.)	ADDRESS 2407	
	LEFT	RIGHT

[Default = blank (•) 2]

AC Fail Report Delay (min.)	ADDRESS 2408	
	LEFT	RIGHT

[Default = blank (•) blank (•)]

Sensor Watch Delay (Hr.)	ADDRESS 4088	
	LEFT	RIGHT

[Default = blank (•) blank (•)]

CHIME TIMEOUT OPTIONS		
DATA ENTRIES		TIMEOUT
LEFT	RIGHT	
blank (•)	blank (•)	0 ¼sec. = 0 sec.
blank (•)	2	2 ¼sec. = ½ sec.
blank (•)	3	3 ¼sec. = ¾ sec.
blank (•)	4	4 ¼sec. = 1 sec.
blank (•)	5	5 ¼sec. = 1.25 sec.
blank (•)	6	6 ¼sec. = 1.5 sec.
blank (•)	7	7 ¼sec. = 1.75 sec.
blank (•)	8	8 ¼sec. = 2 sec.
↓	↓	↓
F	F	255 ¼sec. = 63.25 sec.

AC FAIL REPORT DELAY OPTIONS		
DATA ENTRIES		DELAY
LEFT	RIGHT	
blank (•)	blank (•)	0 min.
blank (•)	1	10 min.
blank (•)	2	20 min.
blank (•)	3	30 min.
blank (•)	4	40 min.
blank (•)	5	50 min.
blank (•)	6	60 min.
blank (•)	7	70 min.
↓	↓	↓
F	F	2550 min. = 42 Hr., 30 min.

SENSOR WATCH OPTIONS		
DATA ENTRIES		DELAY
LEFT	RIGHT	
blank (•)	blank (•)	0 Hr.
blank (•)	1	1 Hr.
blank (•)	2	2 Hr.
blank (•)	3	3 Hr.
blank (•)	4	4 Hr.
blank (•)	5	5 Hr.
blank (•)	6	6 Hr.
blank (•)	7	7 Hr.
↓	↓	↓
F	F	255 Hr.

1. Select delay/timeout from the table shown.
2. Enter in corresponding address locations above (left and right digits).
3. For a desired delay/timeout not listed do the following:
 - A. Choose a desired delay/timeout , ex: 20. **Note:** For Sensor Watch only divide it by 10, ex: 20/10 = 2
 - B. Divide it by 16

$$\begin{array}{r}
 \textcircled{1} \text{ Quotient} \longrightarrow \text{Left Digit} \\
 16 \overline{) 20} \\
 \underline{-16} \\
 \textcircled{4} \text{ Remainder} \longrightarrow \text{Right Digit}
 \end{array}$$

SYSTEM DELAYS & TIMEOUTS (ADDRESS 2400, 2401, 2403-2405 & 4083)

Reset Output Timeout (min.)	ADDRESS 2400	
	LEFT	RIGHT

[Default = blank (•) blank (•)]

Aux. Output Timeout (min.)	ADDRESS 2401	
	LEFT	RIGHT

[Default = blank (•) blank (•)]

Burg. Alarm Output Timeout (min.)	ADDRESS 2403	
	LEFT	RIGHT

[Default = 1 blank (•)]

Pulse Alarm Output Timeout (min.)	ADDRESS 2404	
	LEFT	RIGHT

[Default = 1 blank (•)]

Fire Output Timeout (min.)	ADDRESS 2405	
	LEFT	RIGHT

[Default = blank (•) blank (•)]

DATA ENTRIES		DELAY/TIMEOUT
LEFT	RIGHT	
blank (•)	blank (•)	0 min.
blank (•)	1	1 min.
blank (•)	2	2 min.
blank (•)	3	3 min.
blank (•)	4	4 min.
blank (•)	5	5 min.
blank (•)	6	6 min.
1	blank (•)	16 min.
↓	↓	↓
F	F	255 min.

1. Select delay/timeout (0-255 min.) from the table shown.
2. Enter in corresponding address locations above (left and right digits).
3. For a desired delay/timeout not listed do the following:
 - A. Choose a desired delay/timeout, ex: 20 min.
 - B. Divide it by 16

$$\begin{array}{r}
 \textcircled{1} \text{ Quotient} \longrightarrow \text{Left Digit} \\
 16 \overline{) 20} \\
 \underline{-16} \\
 \textcircled{4} \text{ Remainder} \longrightarrow \text{Right Digit}
 \end{array}$$

OUTPUT TIMEOUTS: If a timeout of "0 min." is selected, then the output will remain active (ON) until the system is reset or disarmed. For UL Residential Installations, the minimum timeout is 4 minutes. For UL Commercial Installations, the minimum

Auto Disarm Rearm Delay (min.)	ADDRESS 4083	
	LEFT	RIGHT

[Default = blank (•) blank (•)]

KEYPAD SYSTEM CODES (ADDRESS 0490, 0495 & 0500)

Panel Access Code	ADDRESS 0490-0492					
	0490		0491		0492	
	L	R	L	R	L	R

[Default = blank (•) blank (•) from address 0490-0492]

PANEL ACCESS CODE: Enter up to 6 digits to activate a door strike while the area is disarmed.

1. Enter in both left and right digits of address locations.
2. Valid entries are: 0-9.

Note: Also, "Access Control on Aux. Output" (Address 2418) and "Aux. Output Access Control Timeout" (Address 2402) must both be enabled.

Ambush Code	ADDRESS 0495	
	LEFT	RIGHT

[Default = blank (•) blank (•)]

AMBUSH CODE: Enter a 2-digit code used just prior to disarming and will activate an Ambush Condition, causing a SILENT report to be sent to the central station.

1. Enter in both left and right digits of address locations.
2. Valid entries are: 0-9.

Note: Also, "Enable Keypad Ambush" (Address 2440-2446), "Report on Ambush Alarm" (Address 1125, 1127, 1135 & 1137) and "Ambush Code" (Address 0900) must all be enabled.

Dealer Security Code	ADDRESS 0500-0502					
	0500		0501		0502	
	L	R	L	R	L	R

[Default = blank (•) blank (•) from address 0500-0502]

DEALER SECURITY CODE: Enter up to 6 digits to be used by the dealer to enter programming.

1. Enter in both left and right digits of address locations.
2. Valid entries are: 0-9.

Note: If left blank, the Master Security Code must then be used to enter programming.

USER CODE OPTIONS (ADDRESS 0010-0169)

ADDRESS 0010-0014 (USER 1)				
0010	0011	0012	0013	0014
L	R	L	R	L
L	R	L	R	L

ADDRESS 0015-0019 (USER 2)				
0015	0016	0017	0018	0019
L	R	L	R	L
L	R	L	R	L

ADDRESS 0020-0024 (USER 3)				
0020	0021	0022	0023	0024
L	R	L	R	L
L	R	L	R	L

ADDRESS 0025-0029 (USER 4)				
0025	0026	0027	0028	0029
L	R	L	R	L
L	R	L	R	L

ADDRESS 0030-0034 (USER 5)				
0030	0031	0032	0033	0034
L	R	L	R	L
L	R	L	R	L

ADDRESS 0035-0039 (USER 6)				
0035	0036	0037	0038	0039
L	R	L	R	L
L	R	L	R	L

ADDRESS 0040-0044 (USER 7)				
0040	0041	0042	0043	0044
L	R	L	R	L
L	R	L	R	L

ADDRESS 0045-0049 (USER 8)				
0045	0046	0047	0048	0049
L	R	L	R	L
L	R	L	R	L

ADDRESS 0050-0054 (USER 9)				
0050	0051	0052	0053	0054
L	R	L	R	L
L	R	L	R	L

ADDRESS 0055-0059 (USER 10)				
0055	0056	0057	0058	0059
L	R	L	R	L
L	R	L	R	L

ADDRESS 0060-0064 (USER 11)				
0060	0061	0062	0063	0064
L	R	L	R	L
L	R	L	R	L

ADDRESS 0065-0069 (USER 12)				
0065	0066	0067	0068	0069
L	R	L	R	L
L	R	L	R	L

ADDRESS 0070-0074 (USER 13)				
0070	0071	0072	0073	0074
L	R	L	R	L
L	R	L	R	L

ADDRESS 0075-0079 (USER 14)				
0075	0076	0077	0078	0079
L	R	L	R	L
L	R	L	R	L

ADDRESS 0080-0084 (USER 15)				
0080	0081	0082	0083	0084
L	R	L	R	L
L	R	L	R	L

ADDRESS 0085-0089 (USER 16)				
0085	0086	0087	0088	0089
L	R	L	R	L
L	R	L	R	L

ADDRESS 0090-0094 (USER 17)				
0090	0091	0092	0093	0094
L	R	L	R	L
L	R	L	R	L

ADDRESS 0020-0024 (USER 18)				
0095	0096	0097	0098	0099
L	R	L	R	L
L	R	L	R	L

ADDRESS 0100-0104 (USER 19)				
0100	0101	0102	0103	0104
L	R	L	R	L
L	R	L	R	L

ADDRESS 0105-0109 (USER 20)				
0105	0106	0107	0108	0109
L	R	L	R	L
L	R	L	R	L

ADDRESS 0110-0114 (USER 21)				
0110	0111	0112	0113	0114
L	R	L	R	L
L	R	L	R	L

ADDRESS 0115-0119 (USER 22)				
0115	0116	0117	0118	0119
L	R	L	R	L
L	R	L	R	L

ADDRESS 0120-0124 (USER 23)				
0120	0121	0122	0123	0124
L	R	L	R	L
L	R	L	R	L

ADDRESS 0125-0129 (USER 24)				
0125	0126	0127	0128	0129
L	R	L	R	L
L	R	L	R	L

ADDRESS 0130-0134 (USER 25)				
0130	0131	0132	0133	0134
L	R	L	R	L
L	R	L	R	L

ADDRESS 0135-0139 (USER 26)				
0135	0136	0137	0138	0139
L	R	L	R	L
L	R	L	R	L

ADDRESS 0140-0144 (USER 27)				
0140	0141	0142	0143	0144
L	R	L	R	L
L	R	L	R	L

ADDRESS 0145-0149 (USER 28)				
0145	0146	0147	0148	0149
L	R	L	R	L
L	R	L	R	L

ADDRESS 0150-0154 (USER 29)				
0150	0151	0152	0153	0154
L	R	L	R	L
L	R	L	R	L

ADDRESS 0155-0159 (USER 30)				
0155	0156	0157	0158	0159
L	R	L	R	L
L	R	L	R	L

ADDRESS 0160-0164 (USER 31)				
0160	0161	0162	0163	0164
L	R	L	R	L
L	R	L	R	L

ADDRESS 0165-0169 (USER 32)				
0165	0166	0167	0168	0169
L	R	L	R	L
L	R	L	R	L

USER CODES: Enter up to 32 User Codes with User Options, Authority Level and Access Control Options (if necessary) for each code. Refer to the tables on the next page for available data entries for User Options, Authority Level and Access Control Options.

 Use the number buttons through to enter a code of up to 6 digits. Enter up to 6 digits (4 digits is recommended) in the first six boxes from left to right for each user code. Valid entries are: 0-9. *Example:* Enter a code of "123456" as "123456".

Note: Press the button for a zero. No blank spaces in between; leave blank (*) any trailing boxes. If an "Ambush Code" (Address 0495) is entered, *do not* program the first two digits of ANY User Code as the same digits entered for the "Ambush Code".

User Code Options

Example: Enter a code of "123456" as "123456".

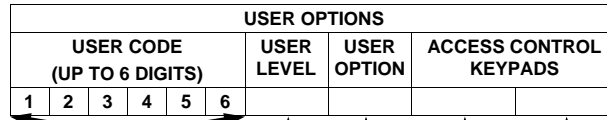

DATA ENTRIES	AUTHORITY LEVEL	CODE TYPE
blank (*)	NONE	ARM/DISARM
1	LEVEL 1	ARM/DISARM
2	LEVEL 2	ARM/DISARM
3	LEVEL 3	ARM/DISARM
4	NONE	ARM ONLY
5	LEVEL 1	ARM ONLY
6	LEVEL 2	ARM ONLY
7	LEVEL 3	ARM ONLY
8	NONE	SERVICE
9	LEVEL 1	SERVICE
0	LEVEL 2	SERVICE
B	LEVEL 3	SERVICE

USER OPTIONS				
DATA ENTRIES	BLOCKED VIEW	USER PROGRAM	BYPASS	OVERVIEW
blank (*)	DISABLE			
1	Y			
2		Y		
3	Y	Y		
4			Y	
5	Y		Y	
6		Y	Y	
7	Y	Y	Y	
8				Y
9	Y			Y
0		Y		Y
B	Y	Y		Y
C			Y	Y
D	Y		Y	Y
E		Y	Y	Y
F	Y	Y	Y	Y

ACCESS CONTROL KEYPADS			
DATA ENTRIES	K.P. 5	K.P. 6	K.P. 7
blank (*)	NONE		
1	Y		
2		Y	
3	Y	Y	
4			Y
5	Y		Y
6		Y	Y
7	Y	Y	Y

ACCESS CONTROL KEYPADS				
DATA ENTRIES	K.P. 1	K.P. 2	K.P. 3	K.P. 4
blank (*)	NONE			
1	Y			
2		Y		
3	Y	Y		
4			Y	
5	Y		Y	
6		Y	Y	
7	Y	Y	Y	
8				Y
9	Y			Y
0		Y		Y
B	Y	Y		Y
C			Y	Y
D	Y		Y	Y
E		Y	Y	Y
F	Y	Y	Y	Y

Note: "Y" indicates option is enabled.

Note: "Y" indicates option is enabled.

NOTES:

- * Minimum Level required to access function
- ** Level-3 Code with appropriate user option
- *** Requires Dealer Code

Note: "Y" indicates option is enabled.

KEYPAD DISPLAY FUNCTION MENU	
FUNCTION	LEVEL*
DISPLAY ZN FAULTS	1
DISPLAY ZN BYPASSED	1
DISPLAY ZN DIRECTORY	1
ACTIVATE BELL TEST	1
DISPLAY PHONE #'S	1
DISPLAY SYS TRBL	1
DISPLAY FIRE ALARM	1
DISPLAY FIRE TRBL	1
DISPLAY OP/CL	3
ACTIVATE OVERVIEW	3**
ACTIVATE CHIME	1
ACTIVATE WATCH	2
RESET SYSTEM TRBL	3
RESET SENSOR MSG	3
START EXIT TIME	1
FAULT FIND	***
ACTIVATE LOCATE	***
EZM ZONE FIND	***
ACTIVATE DIALER TEST	3
DISPLAY ALARM LOG	3
DISPLAY TOTAL LOG	3
DISPLAY FIRE LOG	3
DISPLAY OP/CL LOG	3
DISPLAY SYSTEM LOG	3
AUTOARM IN 1-4HRS	2
DISPLAY AUTARM SCHD	3
ACTIVATE PROGRAM	3**
ACTIVATE DOWNLOAD	3
DISPLY RF XMITTER STAT	1
RELAY CONTROL	1

OPTIONS	EXPLANATION
Disabled	User Code not active in this area.
Blocked View	Allows User Code to block another code from being viewed by another user. An unblocked code cannot view a blocked code, but a blocked code can view all codes. The master user code and the dealer program code can view all codes.
User Program	User Program Option is enabled for Keypad 1 only, wherever it is connected (Area 1 or Area 2). If enabled, Level 3 must also be enabled.
Bypass	Allows User Code to bypass zones.
Overview	This option, along with Level 3 Authorization, enables selection of OVERVIEW mode at a keypad. This Mode provides a system status display of all areas at a glance.
Arm Only	Prevents User Code from disarming this area.
Service	A Service Code has restricted arm/disarm rights; if an area is armed with a Service Code, a "SERVICE ON" appears on the GEM-RP1CAe2 keypad (a "5" on the GEM-RP2ASe2 keypad) and the area can be disarmed with any valid User Code, including a Service Code. If the area is armed with OTHER than a Service Code, it CANNOT be disarmed with a Service Code. This is typically used to allow tradesmen access to premises under control of the owner.
Access	This is normally used to activate a door strike while an area is disarmed. Also program "Access Control on Aux. Output" (Address 2418) and "Aux. Output Access Control Timeout" (Address 2402).

Related User Options: "Ambush Code" (Address 0495), "Panel Access Code" (Address 0490), "Dealer Security Code" (Address 0500) & "Enable User Code by Area" (Address 2500-2531).

Enter the user options data in the left digit and the user level data (with arming options, if any, added) in the right digit.

Note: For entries greater than 9, press the [*] 1 buttons through the [*] 5 buttons for B through F, respectively.

Use the number buttons to enter the data for Keypad 1-4 in the right digit; and the data for Keypad 5-8 data in the left digit. **Note:** Press the [0] buttons for blank.

Note: Users are assigned to areas in "Enable User Code by Area" (Address 2500-2531).

CS RECEIVER FORMAT OPTIONS (ADDRESS 0520, 0521, 0525, 0526, 0550, 0551, 0575 & 0576)

CS Receiver 1 Format	ADDRESS 0525	
	LEFT	RIGHT

CS Receiver 2 Format	ADDRESS 0550	
	LEFT	RIGHT

CS Receiver 3 Format	ADDRESS 0575	
	LEFT	RIGHT

Default for CS Receiver 1 Format depends on Easy Menu Question "RCVR FORMAT". [Default = *(blank) *(blank)] for CS Receivers 2 and 3 Formats.

DATA ENTRIES		CS RECEIVER FORMATS
LEFT	RIGHT	
blank (*)	blank (*)	Ademco Slow, Silent Knight Slow
blank (*)	1	Sescoa, Vertex, DCI, Franklin Fast
blank (*)	2	Radionics Fast
blank (*)	3	Silent Knight Fast
blank (*)	4	Radionics, DCI, Franklin Slow
blank (*)	5	Universal High Speed
blank (*)	8	Radionics BFSK
blank (*)	9	FBI 4/3/1
blank (*)	0	Radionics Modem 2
blank (*)	B	SIA
blank (*)	C	Ademco Point ID
blank (*)	D	Ademco Express
blank (*)	E	Pager
1	blank (*)	Radionics Modem IIe

CS RECEIVER FORMATS: Up to 3 CS Formats may be programmed.

1. Select the desired CS Receiver Format from the table shown.
2. Enter in the corresponding left and right digit address locations for each CS Receiver.

NOTE: Dark shaded data value box shows option not available.

Leading Digits for Pager Format (1st Digit)	ADDRESS 0520	
	LEFT	RIGHT
	blank (*)	

[Default = blank (*) blank (*)]

Leading Digits for Pager Format (2nd Digit)	ADDRESS 0521	
	LEFT	RIGHT
	blank (*)	

[Default = blank (*) blank (*)]

LEADING DIGITS FOR PAGER FORMAT: In Pager Format reporting, the message typically begins with "00". However, for some pager services, this will cause the Pager's Voice Mail feature to activate. This option allows you to program these digits to any number desired. Typical Pager report is "003 022 1234", where 3 is the Event, 22 is the zone, and 1234 is the Subscriber ID number. For example, if the Leading Digits are programmed as "98", the Pager report will now appear as "983 022 1234".

1. Enter in 1st and 2nd Leading Digits in right digit only (left digit is not used) as shown.

2. Valid entries are: 0-9.

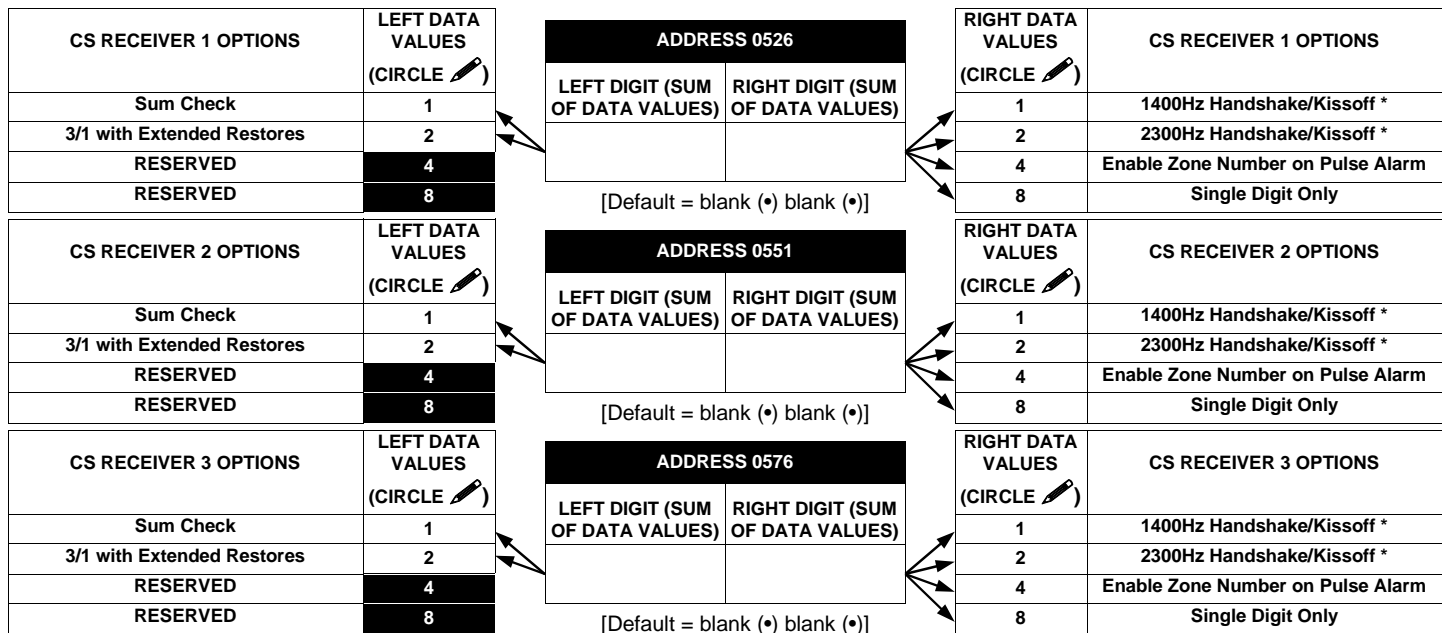

CS RECEIVER OPTIONS: Select options for any of the three CS Receivers.

1. Select the desired option by circling  the data values for each digit (left and right).
2. Add the data values (ex: 15=1+2+4+8) from the selected options.
3. Enter in address location (left and right digits).

NOTE: Dark shaded data value box shows option not available.

NOTE: * If both are selected, 1400Hz has priority over 2300Hz.

CS RECEIVER TELEPHONE NUMBERS (ADDRESS 0527-0546, 0552-0571, 0577-0596)

CS Receiver 1 Telephone Number (Digits 1-20)	ADDRESS 0527-0546 (RIGHT DIGITS 1-20)																				
	0527	0528	0529	0530	0531	0532	0533	0534	0535	0536	0537	0538	0539	0540	0541	0542	0543	0544	0545	0546	
	R	R	R	R	R	R	R	R	R	R	R	R	R	R	R	R	R	R	R	R	R

CS Receiver 2 Telephone Number (Digits 1-20)	ADDRESS 0552-0571 (RIGHT DIGITS 1-20)																				
	0552	0553	0554	0555	0556	0557	0558	0559	0560	0561	0562	0563	0564	0565	0566	0567	0568	0569	0570	0571	
	R	R	R	R	R	R	R	R	R	R	R	R	R	R	R	R	R	R	R	R	R

CS Receiver 3 Telephone Number (Digits 1-20)	ADDRESS 0577-0596 (RIGHT DIGITS 1-20)																				
	0577	0578	0579	0580	0581	0582	0583	0584	0585	0586	0587	0588	0589	0590	0591	0592	0593	0594	0595	0596	
	R	R	R	R	R	R	R	R	R	R	R	R	R	R	R	R	R	R	R	R	R

Default for CS Receiver 1 Telephone Number depends on Easy Menu Question "CENTRAL PHONE #".

[Default = blank (*)] across digits 1-20 for CS Receiver Telephone Numbers 2 and 3.

CS RECEIVER TELEPHONE NUMBERS: Enter telephone numbers for any of the three CS Receivers (Telco 1, 2 & 3).

1. Enter in right digit only (left digit is not used).
2. Enter up to 20 digits from left to right. **NOTE:** Leave trailing boxes blank (*).
3. Valid entries are: 1-9, B = , C = , D = 3 sec. pause, E = Wait for dial tone, F = ignore location

DOWNLOAD/CALLBACK OPTIONS (ADDRESS 4089, 0600-0619, 0625-0647, 1022 & 1023)

No. Rings Before Pickup	ADDRESS 4089	
	LEFT	RIGHT
		blank (*)

NUMBER OF RINGS BEFORE PICKUP: Enter the number of rings before automatic pickup by the control panel when downloading from a computer (see Glossary at the back for more information).

1. Enter in right digit only (left digit is not used).
2. Valid entries are: 1-9, 0 = 10, B = 11, C = 12, D = 13, E = 14, F = 15

NOTE: Default is 15 Rings. Dark shaded data shows option not available.

Callback Telephone Number 1 (Digits 1-20)	ADDRESS 0600-0619 (RIGHT DIGITS 1-20)																				
	0600	0601	0602	0603	0604	0605	0606	0607	0608	0609	0610	0611	0612	0613	0614	0615	0616	0617	0618	0619	
	R	R	R	R	R	R	R	R	R	R	R	R	R	R	R	R	R	R	R	R	R

[Default = blank (*) for all digits 1-20]

Callback Telephone Number 2 (Digits 1-20)	ADDRESS 0625-0644 (RIGHT DIGITS 1-20)																				
	0625	0626	0627	0628	0629	0630	0631	0632	0633	0634	0635	0636	0637	0638	0639	0640	0641	0642	0643	0644	
	R	R	R	R	R	R	R	R	R	R	R	R	R	R	R	R	R	R	R	R	R

[Default = blank (*) for all digits 1-20]

CALLBACK TELEPHONE NUMBERS: Enter telephone numbers to be used when downloading from a computer.

1. Enter in right digit only (left digit is not used).
2. Enter up to 20 digits from left to right. **NOTE:** Leave trailing boxes blank (*).
3. Valid entries are: 0-9, B = , C = , D = 3 sec. pause, E = Wait for dial tone, F = ignore location

Download Security Code	ADDRESS 0645-0647					
	0645		0646		0647	
	L	R	L	R	L	R

[Default = blank (*) blank (*)]

DOWNLOAD SECURITY CODE: Enter up to 6 digits to be used for remote access when downloading from a computer.

1. Enter in both left and right digits of address locations.
2. Valid entries are: 0-9.

Note: Download Security Code must match the code entered in the PCD3000 Software.

Callback Telephone No. Select	ADDRESS 1022	
	LEFT	RIGHT
		blank (*)

[Default = blank (*) blank (*)]

CALLBACK TELEPHONE NO. SELECT: Enter either "1" for Callback Telephone Number 1 or "2" for Callback Telephone Number 2.

1. Enter in right digit only (left digit is not used).
2. Valid entries are: 1 or 2.

Auto Download ID No.	ADDRESS 1023	
	LEFT	RIGHT
		blank (*)

[Default = blank (*) blank (*)]

CS SUBSCRIBER ID NUMBERS (ADDRESS 0650-0857)

CS Telco 1 Subscriber Opening/Closing ID Number (Area 1)	ADDRESS 0650-0653 (RIGHT DIGITS 1-4)			
	0650	0651	0652	0653
	R	R	R	R
CS Telco 1 Subscriber Event ID Number (Area 1)	ADDRESS 0682-0685 (RIGHT DIGITS 1-4)			
	0682	0683	0684	0685
	R	R	R	R

CS Telco 1 Subscriber Opening/Closing ID Number (Area 2)	ADDRESS 0654-0657 (RIGHT DIGITS 1-4)			
	0654	0655	0656	0657
	R	R	R	R
CS Telco 1 Subscriber Event ID Number (Area 2)	ADDRESS 0686-0689 (RIGHT DIGITS 1-4)			
	0686	0687	0688	0689
	R	R	R	R

CS Telco 1 Subscriber Event ID Number(System)	ADDRESS 0714-0717 (RIGHT DIGITS 1-4)			
	0714	0715	0716	0717
	R	R	R	R

CS Telco 2 Subscriber (Backup Reporting) Opening/Closing ID Number (Area 1)	ADDRESS 0720-0723 (RIGHT DIGITS 1-4)			
	0720	0721	0722	0723
	R	R	R	R
CS Telco 2 Subscriber (Backup Reporting) Event ID Number (Area 1)	ADDRESS 0752-0755 (RIGHT DIGITS 1-4)			
	0752	0753	0754	0755
	R	R	R	R

CS Telco 2 Subscriber (Backup Reporting) Opening/Closing ID Number (Area 2)	ADDRESS 0724-0727 (RIGHT DIGITS 1-4)			
	0724	0725	0726	0727
	R	R	R	R
CS Telco 2 Subscriber (Backup Reporting) Event ID Number (Area 2)	ADDRESS 0756-0759 (RIGHT DIGITS 1-4)			
	0756	0757	0758	0759
	R	R	R	R

CS Telco 2 Subscriber (Backup Reporting) Event ID Number (System)	ADDRESS 0784-0787 (RIGHT DIGITS 1-4)			
	0784	0785	0786	0787
	R	R	R	R

CS Telco 3 Subscriber Opening/Closing ID Number (Area 1)	ADDRESS 0790-0793 (RIGHT DIGITS 1-4)			
	0790	0791	0792	0793
	R	R	R	R
CS Telco 3 Subscriber Event ID Number (Area 1)	ADDRESS 0822-0825 (RIGHT DIGITS 1-4)			
	0822	0823	0824	0825
	R	R	R	R

CS Telco 3 Subscriber Opening/Closing ID Number (Area 2)	ADDRESS 0794-0797 (RIGHT DIGITS 1-4)			
	0794	0795	0796	0797
	R	R	R	R
CS Telco 3 Subscriber Event ID Number (Area 2)	ADDRESS 0826-0829 (RIGHT DIGITS 1-4)			
	0826	0827	0828	0829
	R	R	R	R

CS Telco 3 Subscriber Event ID Number (System)	ADDRESS 0854-0857 (RIGHT DIGITS 1-4)			
	0854	0855	0856	0857
	R	R	R	R

Default for CS Telco 1 Subscriber Event ID Number (Area 1) depends on Easy Menu Question "ACCOUNT #". [Default = blank (•) blank (•) blank (•) blank (•)] for all other ID Numbers.

CS TELCO SUBSCRIBER ID NUMBERS: Enter the Subscriber Opening/Closing and Event ID Numbers for any of the 3 CS Receivers.

1. Enter in corresponding right digit address location (left digit is not used).
2. Enter 3 or 4 digits (depending on the CS receiver format) for each subscriber number from left to right.
NOTE: Leave trailing boxes blank (•).
3. Valid entries are: 0-9, 0 and B-F.

CS REPORTING CODES (ADDRESS 0860-0869)

ALARM/TROUBLE REPORTING CODES	ADDRESS 0860-0862		
	LEFT	ADDR	RIGHT
Alarm Restore	blank (•)	0860	
Trouble	blank (•)	0861	
Trouble Restore	blank (•)	0862	

OPENING/CLOSING REPORTING CODES	ADDRESS 0864-0869		
	LEFT	ADDR	RIGHT
Closing	blank (•)	0864	
Conditional Closing	blank (•)	0865	
Opening	blank (•)	0866	
Opening after Alarm	blank (•)	0867	
Fail to Close		0868	
Fail to Open		0869	

CS REPORTING CODES:

1. Enter in corresponding address location (left and right digits).
2. Valid entries are: 1-9, 0 and B-F.
3. To disable a code leave boxes blank (•).

NOTE: Dark shaded data value box shows option not available.

[Default = blank (•) blank (•) from address 0860-0869]

CS REPORTING CODES (ADDRESS 0870-0904)

SYSTEM REPORTING CODES	ADDRESS 0870-0880		
	LEFT	ADDR	RIGHT
Test Timer		0870	
Alarm Supervisory		0871	
Bus Failure		0872	
Memory Failure		0873	
Panel Low Battery		0874	
Panel AC Failure		0875	
EZM Tamper		0876	
Sensor Watch		0877	
RESERVED	blank (*)	0878	blank (*)
RESERVED	blank (*)	0879	blank (*)
Telco Line Failure		0880	

SYSTEM REPORTING CODES	ADDRESS 0890-0897		
	LEFT	ADDR	RIGHT
Digital Dialer Test		0890	
RESERVED	blank (*)	0891	blank (*)
RESERVED	blank (*)	0892	blank (*)
Service Message		0893	
Program Change		0894	
RF Receiver Trouble		0895	
RF Receiver Tamper		0896	
RF Trouble		0897	

KEYPAD REPORTING CODES	ADDRESS 0900-0904		
	LEFT	ADDR	RIGHT
Ambush		0900	
Panic		0901	
Fire		0902	
Auxiliary		0903	
Tamper		0904	

[Default = blank (*) blank (*) from address 0870-0904]

CS REPORTING

CODES:

1. Enter in corresponding address location (left and right digits).
2. Valid entries are: 1-9, 0 and B-F.
3. To disable a code leave boxes blank (*).

NOTE: Dark shaded data value box shows option not available.

CAUTION: For all 2-Digit Reporting Formats (see CS Receiver Format Options), use the following:

Reporting Code	ADDRESS LOC.	
	LEFT	RIGHT
	1	2

2nd Digit of Reporting Code

1st Digit of Reporting Code

Example: The 2-digit reporting code as shown is "21".

CS AREA & SYSTEM REPORTING OPTIONS (ADDRESS 1024-1027)

AREA	LEFT DATA VALUES (CIRCLE)
AREA 1	1
AREA 2	2
RESERVED	4
RESERVED	8

DISABLE OPENING REPORTS	
ADDRESS 1024	
LEFT DIGIT (SUM OF DATA VALUES)	RIGHT DIGIT
	blank (*)

[Default = blank (*) blank (*)]

AREA	LEFT DATA VALUES (CIRCLE)
AREA 1	1
AREA 2	2
RESERVED	4
RESERVED	8

DISABLE CLOSING REPORTS	
ADDRESS 1025	
LEFT DIGIT (SUM OF DATA VALUES)	RIGHT DIGIT
	blank (*)

[Default = blank (*) blank (*)]

CS SYSTEM REPORT OPTIONS	LEFT DATA VALUES (CIRCLE)
Cancel Next Test Timer on any Report	1
Disable Wait for Silence	2
Disable Wait for Handshake	4
Handshake for Local Telemetry	8

ADDRESS 1027	
LEFT DIGIT (SUM OF DATA VALUES)	RIGHT DIGIT (SUM OF DATA VALUES)

[Default = blank (*) blank (*)]

RIGHT DATA VALUES (CIRCLE)	CS SYSTEM REPORT OPTIONS
1	Backup Report on Telco 2
2	Touchtone Dialing Only *
4	Touchtone Dialing w/Rotary Backup *
8	Transmit "402" Opening/Closing Code

CS AREA & SYSTEM REPORTING OPTIONS:

1. Select the desired option by circling the data values for each digit (left and right).
2. Add the data values (ex: 15=1+2+4+8) from the selected options.
3. Enter in address location (left and right digits).

NOTE: Dark shaded data value box shows option not available.

*** NOTE:** If neither Touchtone Dialing nor Touchtone w/Rotary Backup is selected, then system defaults automatically to Rotary Dialing. Leave blank (*) to select Rotary Dialing.

CS ZONE REPORTING CODES (ADDRESS 0910-0941)

ADDRESS 0910-0917							
ZONES REPORT CODE (CONTROL PANEL)							
ZONE 1		ZONE 2		ZONE 3		ZONE 4	
0910	0911	0912	0913	0914	0915	0916	0917
L	R	L	R	L	R	L	R

ADDRESS 0918-0921			
ZONES REPORT CODE (GROUP 1)			
ZONE 9		ZONE 10	
0918	0919	0920	0921
L	R	L	R

ADDRESS 0922-0925			
ZONES REPORT CODE (GROUP 2)			
ZONE 13		ZONE 14	
0922	0923	0924	0925
L	R	L	R

ADDRESS 0926-0929			
ZONES REPORT CODE (GROUP 3)			
ZONE 17		ZONE 18	
0926	0927	0928	0929
L	R	L	R

ADDRESS 0930-0933			
ZONES REPORT CODE (GROUP 4)			
ZONE 21		ZONE 22	
0930	0931	0932	0933
L	R	L	R

ADDRESS 0934-0937			
ZONES REPORT CODE (GROUP 5)			
ZONE 25		ZONE 26	
0934	0935	0936	0937
L	R	L	R

ADDRESS 0938-0941			
ZONES REPORT CODE (GROUP 6)			
ZONE 29		ZONE 30	
0938	0939	0940	0941
L	R	L	R

Default for Group Zone Report Codes depends on Easy Menu Question "RCVR."

ZONE REPORT CODE OPTIONS	
DATA ENTRIES	
LEFT	RIGHT

NOTE: Zones 1-8 are included in the control panel and Zones 9-32 are EZM Zones. See Address 2600-2605 to enable "EZM Zone Groups".

DATA ENTRIES	MODEM CODE
LEFT	
1	Fire *
2	Panic
3	Burglary
4	Hold up
7	Gas Alarm
8	Heat Alarm
0	Auxiliary Alarm
B	24 Hour Auxiliary

PULSE EVENT CODE will be the first digit of the 2 digit reporting code. the second digit will be the second digit of the reporting zone. For example, for zone 9 (address 0918), if the right digit is "3", then the reporting code is "39". For example, for zone 15 (address 0924), if the right digit is "4", then the reporting code is "45".

MODEM CODES determine the zone types reported for the following formats: SIA and ADEMCO Point ID.

1. Select the desired Modem Code for each zone from the table shown.



CS USER REPORTING CODES (ADDRESS 1030-1081)

User Opening Telco 1	LEFT DATA VALUES				ADDRESS 1031		RIGHT DATA VALUES				LEFT DATA VALUES				ADDRESS 1030		RIGHT DATA VALUES			
	User 16	User 15	User 14	User 13	LEFT	RIGHT	User 12	User 11	User 10	User 9	User 8	User 7	User 6	User 5	LEFT	RIGHT	User 4	User 3	User 2	User 1
	8	4	2	1			8	4	2	1	8	4	2	1			8	4	2	1

User Opening Telco 1	LEFT DATA VALUES				ADDRESS 1033		RIGHT DATA VALUES				LEFT DATA VALUES				ADDRESS 1032		RIGHT DATA VALUES			
	User 32	User 31	User 30	User 29	LEFT	RIGHT	User 28	User 27	User 26	User 25	User 24	User 23	User 22	User 21	LEFT	RIGHT	User 20	User 19	User 18	User 17
	8	4	2	1			8	4	2	1	8	4	2	1			8	4	2	1

User Opening Telco 1	ADDRESS 1042		RIGHT DATA VALUES				User 97 = Auto Arming/Disarming User 98 = Quickloader Arming/Disarming User 99 = Easy Arming (Opening not applicable) User 00 = Keyswitch Arming							NOTE: These opening events will report as the user number shown. Also, Keyfobs 1-8 (see Easy Menu Program Driven Mode) will report as Users 25-32, respectively.			
	LEFT	RIGHT	User 00	User 99	User 98	User 97											
	blank (*)		8	4	2	1											

User Closing Telco 1	LEFT DATA VALUES				ADDRESS 1043		RIGHT DATA VALUES				LEFT DATA VALUES				ADDRESS 1044		RIGHT DATA VALUES			
	User 8	User 7	User 6	User 5	LEFT	RIGHT	User 4	User 3	User 2	User 1	User 16	User 15	User 14	User 13	LEFT	RIGHT	User 12	User 11	User 10	User 9
	8	4	2	1			8	4	2	1	8	4	2	1			8	4	2	1

User Closing Telco 1	LEFT DATA VALUES				ADDRESS 1046		RIGHT DATA VALUES				LEFT DATA VALUES				ADDRESS 1045		RIGHT DATA VALUES			
	User 32	User 31	User 30	User 29	LEFT	RIGHT	User 28	User 27	User 26	User 25	User 24	User 23	User 22	User 21	LEFT	RIGHT	User 20	User 19	User 18	User 17
	8	4	2	1			8	4	2	1	8	4	2	1			8	4	2	1

User Closing Telco 1	ADDRESS 1055		RIGHT DATA VALUES				User 97 = Auto Arming/Disarming User 98 = Quickloader Arming/Disarming User 99 = Easy Arming (Opening not applicable) User 00 = Keyswitch Arming							NOTE: These opening events will report as the user number shown. Also, Keyfobs 1-8 (see Easy Menu Program Driven Mode) will report as Users 25-32, respectively.			
	LEFT	RIGHT	User 00	User 99	User 98	User 97											
	blank (*)		8	4	2	1											

User Opening Telco 3	LEFT DATA VALUES				ADDRESS 1056		RIGHT DATA VALUES				LEFT DATA VALUES				ADDRESS 1057		RIGHT DATA VALUES			
	User 16	User 15	User 14	User 13	LEFT	RIGHT	User 12	User 11	User 10	User 9	User 8	User 7	User 6	User 5	LEFT	RIGHT	User 4	User 3	User 2	User 1
	8	4	2	1			8	4	2	1	8	4	2	1			8	4	2	1

User Opening Telco 3	LEFT DATA VALUES				ADDRESS 1059		RIGHT DATA VALUES				LEFT DATA VALUES				ADDRESS 1058		RIGHT DATA VALUES			
	User 32	User 31	User 30	User 29	LEFT	RIGHT	User 28	User 27	User 26	User 25	User 24	User 23	User 22	User 21	LEFT	RIGHT	User 20	User 19	User 18	User 17
	8	4	2	1			8	4	2	1	8	4	2	1			8	4	2	1

User Opening Telco 3	ADDRESS 1068		RIGHT DATA VALUES				User 97 = Auto Arming/Disarming User 98 = Quickloader Arming/Disarming User 99 = Easy Arming (Opening not applicable) User 00 = Keyswitch Arming							NOTE: These opening events will report as the user number shown. Also, Keyfobs 1-8 (see Easy Menu Program Driven Mode) will report as Users 25-32, respectively.			
	LEFT	RIGHT	User 00	User 99	User 98	User 97											
	blank (*)		8	4	2	1											

User Closing Telco 3	LEFT DATA VALUES				ADDRESS 1069		RIGHT DATA VALUES				LEFT DATA VALUES				ADDRESS 1070		RIGHT DATA VALUES			
	User 16	User 15	User 14	User 13	LEFT	RIGHT	User 12	User 11	User 10	User 9	User 8	User 7	User 6	User 5	LEFT	RIGHT	User 4	User 3	User 2	User 1
	8	4	2	1			8	4	2	1	8	4	2	1			8	4	2	1



User Closing Telco 3	LEFT DATA VALUES				ADDRESS 1072		RIGHT DATA VALUES				LEFT DATA VALUES				ADDRESS 1071		RIGHT DATA VALUES			
	User 32	User 31	User 30	User 29	LEFT	RIGHT	User 28	User 27	User 26	User 25	User 24	User 23	User 22	User 21	LEFT	RIGHT	User 20	User 19	User 18	User 17
	8	4	2	1			8	4	2	1	8	4	2	1			8	4	2	1

User Closing Telco 3	ADDRESS 1081		RIGHT DATA VALUES				User 97 = Auto Arming/Disarming User 98 = Quickloader Arming/Disarming User 99 = Easy Arming (Opening not applicable) User 00 = Keyswitch Arming							NOTE: These opening events will report as the user number shown. Also, Keyfobs 1-8 (see Easy Menu Program Driven Mode) will report as Users 25-32, respectively.			
	LEFT	RIGHT	User 00	User 99	User 98	User 97											
	blank (*)		8	4	2	1											



CS USER REPORTING OPTIONS: [Default = blank (*) blank (*) from address 1030-1081]

1. Select the desired option by circling the data values for each digit (left and right).
2. Add the data values (ex: 15=1+2+4+8) from the selected options.
3. Enter in address location (left and right digits). **NOTE:** Dark shaded data value box shows option not available.



GLOBAL SYSTEM TROUBLE REPORTING OPTIONS (ADDRESS 1082-1116)

SYSTEM RESPONSE AC-TIVATED BY GLOBAL EVENT/TROUBLE	GLOBAL SYSTEM EVENT/TROUBLE				ADDRESS			GLOBAL SYSTEM EVENT/TROUBLE			
	LEFT DATA VALUES (CIRCLE )				1082-1092			RIGHT DATA VALUES (CIRCLE )			
	SENSOR WATCH	EZM TAMPER	AC FAIL	LOW BATTERY	LEFT	ADDR	RIGHT	MEMORY FAILURE	COMM. BUS 1	ALARM SUPERV.	TEST TIMER
Burglary Alarm Output	8	4	2	1		1082		8	4	2	1
Pulsed Burg. Reset	8	4	2	1		1083		8	4	2	1
Fire Output	8	4	2	1		1084		8	4	2	1
Reset Relay	8	4	2	1		1085		8	4	2	1
Auxiliary Relay	8	4	2	1		1086		8	4	2	1
Report Event Telco 1	8	4	2	1		1087		8	4	2	1
Report Restore Telco 1	8	4	2	1		1088		8	4	2	1
Report Event Telco 3	8	4	2	1		1091		8	4	2	1
Report Restore Telco 3	8	4	2	1		1092		8	4	2	1





See NOTE  [Default = blank (•) blank (•) from address 1082-1092]

SYSTEM RESPONSE AC-TIVATED BY GLOBAL EVENT/TROUBLE	GLOBAL SYSTEM EVENT/TROUBLE				ADDRESS			GLOBAL SYSTEM EVENT/TROUBLE			
	LEFT DATA VALUES (CIRCLE )				1094-1104			RIGHT DATA VALUES (CIRCLE )			
	RSRVD.	RSRVD.	RSRVD.	RSRVD.	LEFT	ADDR	RIGHT	Telemetry Failure	Telemetry Trouble	RSRVD	TELCO FAIL
Burglary Alarm Output	8	4	2	1	blank (•)	1094		8	4	2	1
Pulsed Burg. Reset	8	4	2	1	blank (•)	1095		8	4	2	1
Fire Output	8	4	2	1	blank (•)	1096		8	4	2	1
Reset Relay	8	4	2	1	blank (•)	1097		8	4	2	1
Auxiliary Relay	8	4	2	1	blank (•)	1098		8	4	2	1
Report Event Telco 1	8	4	2	1	blank (•)	1099		8	4	2	1
Report Restore Telco 1	8	4	2	1	blank (•)	1100		8	4	2	1
Report Event Telco 3	8	4	2	1	blank (•)	1103		8	4	2	1
Report Restore Telco 3	8	4	2	1	blank (•)	1104		8	4	2	1

[Default = blank (•) blank (•) from address 1094-1104]

SYSTEM RESPONSE AC-TIVATED BY GLOBAL EVENT/TROUBLE	GLOBAL SYSTEM EVENT/TROUBLE				ADDRESS			GLOBAL SYSTEM EVENT/TROUBLE			
	LEFT DATA VALUES (CIRCLE )				1106-1116			RIGHT DATA VALUES (CIRCLE )			
	RF TROUBLE	RF TAMPER	RF RCVR. TROUBLE	PROGRAM CHANGE	LEFT	ADDR	RIGHT	SERVICE MESSAGE	RSRVD.	RSRVD.	Digital Dialer Test
Burglary Alarm Output	8	4	2	1		1106	blank (•)	8	4	2	1
Pulsed Burg. Reset	8	4	2	1		1107	blank (•)	8	4	2	1
Fire Output	8	4	2	1		1108	blank (•)	8	4	2	1
Reset Relay	8	4	2	1		1109	blank (•)	8	4	2	1
Auxiliary Relay	8	4	2	1		1110	blank (•)	8	4	2	1
Report Event Telco 1	8	4	2	1		1111		8	4	2	1
Report Restore Telco 1	8	4	2	1	blank (•)	1112	blank (•)	8	4	2	1
Report Event Telco 3	8	4	2	1		1115		8	4	2	1
Report Restore Telco 3	8	4	2	1	blank (•)	1116	blank (•)	8	4	2	1

See NOTE  [Default = blank (•) blank (•) from address 1106-1116]

-  1. Select the desired option by circling  the data values for each digit (left and right).
-  2. Add the data values (ex: 15=1+2+4+8) from the selected options.
-  3. Enter in address location (left and right digits).

NOTE: Dark shaded data value box shows option not available.

Global System Trouble Reporting Options



AREA SYSTEM TROUBLE REPORTING OPTIONS (ADDRESS 1120-1137)

SYSTEM RESPONSE ACTIVATED BY AREA 1 EVENT/TROUBLE	AREA 1 SYSTEM EVENT/TROUBLE				ADDRESS 1120-1127			AREA 1 SYSTEM EVENT/TROUBLE			
	LEFT DATA VALUES (CIRCLE)							RIGHT DATA VALUES (CIRCLE)			
	RSRVD.	FAIL TO CLOSE	FAIL TO OPEN	KEYPAD TAMPER	LEFT	ADDR	RIGHT	KEYPAD AUX.	KEYPAD FIRE	KEYPAD PANIC	AMBUSH
Pulsed Burg. Output	8	4	2	1		1120		8	4	2	1
Burglary Output	8	4	2	1		1121		8	4	2	1
Fire Output	8	4	2	1		1122		8	4	2	1
Reset Relay	8	4	2	1		1123		8	4	2	1
Auxiliary Relay	8	4	2	1		1124		8	4	2	1
Report Alarm Telco 1	8	4	2	1		1125		8	4	2	1
Report Alarm Telco 3	8	4	2	1		1127		8	4	2	1

[Default = blank (•) blank (•) from address 1120-1127]

SYSTEM RESPONSE ACTIVATED BY AREA 2 EVENT/TROUBLE	AREA 2 SYSTEM EVENT/TROUBLE				ADDRESS 1130-1137			AREA 2 SYSTEM EVENT/TROUBLE			
	LEFT DATA VALUES (CIRCLE)							RIGHT DATA VALUES (CIRCLE)			
	RSRVD.	FAIL TO CLOSE	FAIL TO OPEN	KEYPAD TAMPER	LEFT	ADDR	RIGHT	KEYPAD AUX.	KEYPAD FIRE	KEYPAD PANIC	AMBUSH
Pulsed Burg. Output	8	4	2	1		1130		8	4	2	1
Burglary Output	8	4	2	1		1131		8	4	2	1
Fire Output	8	4	2	1		1132		8	4	2	1
Reset Relay	8	4	2	1		1133		8	4	2	1
Auxiliary Relay	8	4	2	1		1134		8	4	2	1
Report Alarm Telco 1	8	4	2	1		1135		8	4	2	1
Report Alarm Telco 3	8	4	2	1		1137		8	4	2	1

[Default = blank (•) blank (•) from address 1130-1137]

1. Select the desired option by circling the data values for each digit (left and right).
2. Add the data values (ex: 15=1+2+4+8) from the selected options.
3. Enter in address location (left and right digits).

NOTE: Dark shaded data value box shows option not available.

ZONE OPTIONS / ZONES 1-16 (ADDRESS 1200-1376)

ZONE OPTIONS	ZONES 13-16 LEFT DATA VALUES (CIRCLE)				ADDRESS 1302-1376			ZONES 9-12 RIGHT DATA VALUES (CIRCLE)				ZONES 5-8 LEFT DATA VALUES (CIRCLE)				ADDRESS 1200-1276			ZONES 1-4 RIGHT DATA VALUES (CIRCLE)			
	ZN16	ZN15	ZN14	ZN13	L	ADDR	R	ZN12	ZN11	ZN10	ZN9	ZN8	ZN7	ZN6	ZN5	L	ADDR	R	ZN4	ZN3	ZN2	ZN1
	50ms Loop Response (A)	8	4	2	1	(*)		(*)	8	4	2	1	8	4	2	1		1200		8	4	2
10ms Loop Response (A)	8	4	2	1	(*)		(*)	8	4	2	1	8	4	2	1		1201		8	4	2	1
✓ Priority	8	4	2	1		1302		8	4	2	1	8	4	2	1		1202		8	4	2	1
✓ Priority with Bypass	8	4	2	1		1303		8	4	2	1	8	4	2	1		1203		8	4	2	1
✓ Auto-Bypass	8	4	2	1		1304		8	4	2	1	8	4	2	1		1204		8	4	2	1
Selective Bypass	8	4	2	1		1305		8	4	2	1	8	4	2	1		1205		8	4	2	1
Keyswitch Arming	8	4	2	1		1306		8	4	2	1	8	4	2	1		1206		8	4	2	1
Auto-Bypass Re-entry	8	4	2	1		1307		8	4	2	1	8	4	2	1		1207		8	4	2	1
Pre-Alarm Warning	8	4	2	1		1308		8	4	2	1	8	4	2	1		1208		8	4	2	1
Never Arm	8	4	2	1		1309		8	4	2	1	8	4	2	1		1209		8	4	2	1
✓ 24-Hour Zone	8	4	2	1		1310		8	4	2	1	8	4	2	1		1210		8	4	2	1
✓ Burg. Alarm Output	8	4	2	1		1311		8	4	2	1	8	4	2	1		1211		8	4	2	1
Pulsed Alarm Output	8	4	2	1		1312		8	4	2	1	8	4	2	1		1212		8	4	2	1
Fire Output (Lug E9)	8	4	2	1		1313		8	4	2	1	8	4	2	1		1213		8	4	2	1
✓ Reset Relay	8	4	2	1		1314		8	4	2	1	8	4	2	1		1214		8	4	2	1
Auxiliary Relay	8	4	2	1		1315		8	4	2	1	8	4	2	1		1215		8	4	2	1
✓ Entry/Exit 1	8	4	2	1		1316		8	4	2	1	8	4	2	1		1216		8	4	2	1
✓ Entry/Exit 2	8	4	2	1		1317		8	4	2	1	8	4	2	1		1217		8	4	2	1
✓ Exit/Entry Follower	8	4	2	1		1318		8	4	2	1	8	4	2	1		1218		8	4	2	1
✓ Auto Reset	8	4	2	1		1319		8	4	2	1	8	4	2	1		1219		8	4	2	1
Swinger Shutdown	8	4	2	1		1320		8	4	2	1	8	4	2	1		1220		8	4	2	1
Chime	8	4	2	1		1321		8	4	2	1	8	4	2	1		1221		8	4	2	1
Abort Delay	8	4	2	1		1322		8	4	2	1	8	4	2	1		1222		8	4	2	1
Power-up Delay	8	4	2	1		1323		8	4	2	1	8	4	2	1		1223		8	4	2	1
Day Zone Open	8	4	2	1		1324		8	4	2	1	8	4	2	1		1224		8	4	2	1
✓ Day Zone Short	8	4	2	1		1325		8	4	2	1	8	4	2	1		1225		8	4	2	1
Alarm on Day Zone	8	4	2	1		1326		8	4	2	1	8	4	2	1		1226		8	4	2	1
Alarm Telco 1	8	4	2	1		1327		8	4	2	1	8	4	2	1		1227		8	4	2	1
Alarm Restore 1	8	4	2	1		1328		8	4	2	1	8	4	2	1		1228		8	4	2	1
Trouble Telco 1	8	4	2	1		1329		8	4	2	1	8	4	2	1		1229		8	4	2	1
Trouble Restore 1	8	4	2	1		1330		8	4	2	1	8	4	2	1		1230		8	4	2	1
Alarm Telco 3	8	4	2	1		1335		8	4	2	1	8	4	2	1		1235		8	4	2	1
Alarm Restore 3	8	4	2	1		1336		8	4	2	1	8	4	2	1		1236		8	4	2	1
Trouble Telco 3	8	4	2	1		1337		8	4	2	1	8	4	2	1		1237		8	4	2	1
Trouble Restore 3	8	4	2	1		1338		8	4	2	1	8	4	2	1		1238		8	4	2	1
No EOL Resistor	8	4	2	1		1339		8	4	2	1	8	4	2	1		1239		8	4	2	1
✓ Sensor Watch	8	4	2	1		1340		8	4	2	1	8	4	2	1		1240		8	4	2	1
✓ Trouble on Open	8	4	2	1		1341		8	4	2	1	8	4	2	1		1241		8	4	2	1
✓ Trouble on Short	8	4	2	1		1342		8	4	2	1	8	4	2	1		1242		8	4	2	1
✓ Trouble on Night Open	8	4	2	1		1343		8	4	2	1	8	4	2	1		1243		8	4	2	1
✓ Zone Area 1	8	4	2	1		1344		8	4	2	1	8	4	2	1		1244		8	4	2	1
✓ Zone Area 2	8	4	2	1		1345		8	4	2	1	8	4	2	1		1245		8	4	2	1
2-Wire Smoke Detectors (B)	8	4	2	1	(*)		(*)	8	4	2	1	8	4	2	1		1252		8	4	2	1
Zone ANDing Group 1	8	4	2	1		1354		8	4	2	1	8	4	2	1		1254		8	4	2	1
Zone ANDing Group 2	8	4	2	1		1355		8	4	2	1	8	4	2	1		1255		8	4	2	1
Interior Bypass	8	4	2	1		1362		8	4	2	1	8	4	2	1		1262		8	4	2	1
Keypad Sounder on Alarm	8	4	2	1		1364		8	4	2	1	8	4	2	1		1264		8	4	2	1
Fire (C)	8	4	2	1		1375		8	4	2	1	8	4	2	1		1275		8	4	2	1
Fire Alarm Verification (C)	8	4	2	1		1376		8	4	2	1	8	4	2	1		1276		8	4	2	1

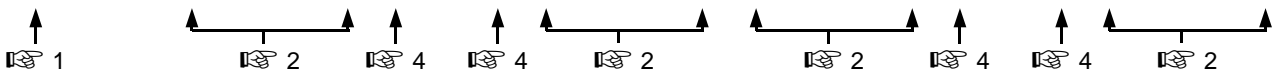

1. **Select** the desired zone option.
2. **Enable** desired options for each zone by drawing a circle around its corresponding binary data value.
3. **Search table** below for data entry.
4. **Enter data** in address locations (left and right digits).

ZONE OPTIONS
50ms Loop Response
10ms Loop Response
Priority
Priority with Bypass
Auto-Bypass

NOTE: No circle = feature disabled.

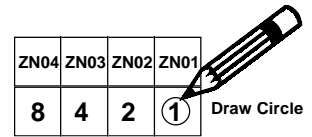

DIGIT VALUE	DATA ENTRY	DIGIT VALUE	DATA ENTRY
8 4 2 1	Blank (*)	8 4 2 1	8
8 4 2 ①	1	8 4 2 ①	9
8 4 ② 1	2	8 4 ② 1	0
8 4 ③ ①	3	8 4 ③ ①	B
8 ④ 2 1	4	8 ④ 2 1	C
8 ④ 2 ①	5	8 ④ 2 ①	D
8 ④ ② 1	6	8 ④ ② 1	E
8 ④ ② ①	7	8 ④ ② ①	F

ADDRESS LOCATION		
L	ADDR	R
blank (*)	1200	1

NOTE: Dark shaded data value box shows option not available.

NOTE: See Direct Address Programming Example on page 20.

Zone Options / Zones 1-16

ZONE OPTIONS / ZONES 17 TO 32 (ADDRESS 1402-1576)

Zone Options / Zones 17-32

ZONE OPTIONS	ZONES 29-32 LEFT DATA VALUES (CIRCLE)				ADDRESS 1502-1576			ZONES 25-28 RIGHT DATA VALUES (CIRCLE)				ZONES 21-24 LEFT DATA VALUES (CIRCLE)				ADDRESS 1402-1476			ZONES 17-20 RIGHT DATA VALUES (CIRCLE)			
	ZN32	ZN31	ZN30	ZN29	L	ADDR	R	ZN28	ZN27	ZN26	ZN25	ZN24	ZN23	ZN22	ZN21	L	ADDR	R	ZN20	ZN19	ZN18	ZN17
	Priority	8	4	2	1		1502		8	4	2	1	8	4	2	1		1402		8	4	2
Priority with Bypass	8	4	2	1		1503		8	4	2	1	8	4	2	1		1403		8	4	2	1
✓ Auto-Bypass	8	4	2	1		1504		8	4	2	1	8	4	2	1		1404		8	4	2	1
✓ Selective Bypass	8	4	2	1		1505		8	4	2	1	8	4	2	1		1405		8	4	2	1
✓ Keyswitch Arming	8	4	2	1		1506		8	4	2	1	8	4	2	1		1406		8	4	2	1
Auto-Bypass Re-entry	8	4	2	1		1507		8	4	2	1	8	4	2	1		1407		8	4	2	1
Pre-Alarm Warning	8	4	2	1		1508		8	4	2	1	8	4	2	1		1408		8	4	2	1
Never Arm	8	4	2	1		1509		8	4	2	1	8	4	2	1		1409		8	4	2	1
24-Hour Zone	8	4	2	1		1510		8	4	2	1	8	4	2	1		1410		8	4	2	1
Burg. Alarm Output	8	4	2	1		1511		8	4	2	1	8	4	2	1		1411		8	4	2	1
✓ Pulsed Alarm Output	8	4	2	1		1512		8	4	2	1	8	4	2	1		1412		8	4	2	1
✓ Fire Output (Lug E9)	8	4	2	1		1513		8	4	2	1	8	4	2	1		1413		8	4	2	1
Reset Relay	8	4	2	1		1514		8	4	2	1	8	4	2	1		1414		8	4	2	1
Auxiliary Relay	8	4	2	1		1515		8	4	2	1	8	4	2	1		1415		8	4	2	1
✓ Entry/Exit 1	8	4	2	1		1516		8	4	2	1	8	4	2	1		1416		8	4	2	1
Entry/Exit 2	8	4	2	1		1517		8	4	2	1	8	4	2	1		1417		8	4	2	1
✓ Exit/Entry Follower	8	4	2	1		1518		8	4	2	1	8	4	2	1		1418		8	4	2	1
✓ Auto Reset	8	4	2	1		1519		8	4	2	1	8	4	2	1		1419		8	4	2	1
✓ Swinger Shutdown	8	4	2	1		1520		8	4	2	1	8	4	2	1		1420		8	4	2	1
✓ Chime	8	4	2	1		1521		8	4	2	1	8	4	2	1		1421		8	4	2	1
Abort Delay	8	4	2	1		1522		8	4	2	1	8	4	2	1		1422		8	4	2	1
Power-up Delay	8	4	2	1		1523		8	4	2	1	8	4	2	1		1423		8	4	2	1
Day Zone Open	8	4	2	1		1524		8	4	2	1	8	4	2	1		1424		8	4	2	1
Day Zone Short	8	4	2	1		1525		8	4	2	1	8	4	2	1		1425		8	4	2	1
Alarm on Day Zone	8	4	2	1		1526		8	4	2	1	8	4	2	1		1426		8	4	2	1
✓ Alarm Telco 1	8	4	2	1		1527		8	4	2	1	8	4	2	1		1427		8	4	2	1
Alarm Restore 1	8	4	2	1		1528		8	4	2	1	8	4	2	1		1428		8	4	2	1
Trouble Telco 1	8	4	2	1		1529		8	4	2	1	8	4	2	1		1429		8	4	2	1
Trouble Restore 1	8	4	2	1		1530		8	4	2	1	8	4	2	1		1430		8	4	2	1
Alarm Telco 3	8	4	2	1		1535		8	4	2	1	8	4	2	1		1435		8	4	2	1
Alarm Restore 3	8	4	2	1		1536		8	4	2	1	8	4	2	1		1436		8	4	2	1
Trouble Telco 3	8	4	2	1		1537		8	4	2	1	8	4	2	1		1437		8	4	2	1
Trouble Restore 3	8	4	2	1		1538		8	4	2	1	8	4	2	1		1438		8	4	2	1
No EOL Resistor	8	4	2	1		1539		8	4	2	1	8	4	2	1		1439		8	4	2	1
Sensor Watch	8	4	2	1		1540		8	4	2	1	8	4	2	1		1440		8	4	2	1
Trouble on Open	8	4	2	1		1541		8	4	2	1	8	4	2	1		1441		8	4	2	1
✓ Trouble on Short	8	4	2	1		1542		8	4	2	1	8	4	2	1		1442		8	4	2	1
Trouble on Night Open	8	4	2	1		1543		8	4	2	1	8	4	2	1		1443		8	4	2	1
✓ Zone Area 1	8	4	2	1		1544		8	4	2	1	8	4	2	1		1444		8	4	2	1
✓ Zone Area 2	8	4	2	1		1545		8	4	2	1	8	4	2	1		1445		8	4	2	1
✓ Zone ANDing Group 1	8	4	2	1		1554		8	4	2	1	8	4	2	1		1454		8	4	2	1
✓ Zone ANDing Group 2	8	4	2	1		1555		8	4	2	1	8	4	2	1		1455		8	4	2	1
Interior Bypass	8	4	2	1		1562		8	4	2	1	8	4	2	1		1462		8	4	2	1
Keypad Sounder on Alarm	8	4	2	1		1564		8	4	2	1	8	4	2	1		1464		8	4	2	1
Fire (C)	8	4	2	1		1575		8	4	2	1	8	4	2	1		1475		8	4	2	1
Fire Alarm Verification (C)	8	4	2	1		1576		8	4	2	1	8	4	2	1		1476		8	4	2	1

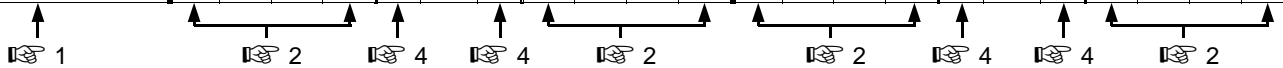

- NOTES:**
- (A) 50ms & 10 ms Loop Response only available for zones 1-8.
 - (B) 2-wire Smoke Detectors only available for zones 1-8.
 - (C) If Fire Alarm Verification is selected, then Fire must also be selected.

DEFAULTS: The zone options indicated are automatically set after exiting the Easy Menu Driven Mode.

- ✓ Priority, Selective Bypass, Alarm Output, Auto Reset, Swinger Shutdown and Zone Area 1 are enabled for the total number of zones entered in "RI ##ZN=08 ##KP=1".
- ✓ Alarm Telco 1 is enabled for the zone number(s) entered in "REPORT ALL ZONES TO CENTRAL ZONESP Y/N".
- ✓ Entry/Exit 1 and Chime are enabled for zone number 1 entered in "RI ##ZN=08 ##KP=1".
- ✓ Exit/Entry Follower and Interior Bypass are enabled for the zone number 2 entered in "RI ##ZN=08 ##KP=1".
- ✓ Pulse Alarm Output is enabled for the zone number 8 entered in "RI ##ZN=08 ##KP=1".
- ✓ Fire is enabled for zone number 8 entered in "RI ##ZN=08 ##KP=1".
- ✓ 2-Wire Smoke Detector is enabled for zone number 8 entered in "RI ##ZN=08 ##KP=1".

Note: See "Number of Zones & Keypads per Area" in Easy Menu Driven program Mode.

SYSTEM OPTIONS (ADDRESS 2415-2419)

Note: Left digit is RESERVED (not used). Enter data in right digit only.

ADDRESS 2415	
LEFT DIGIT (SUM OF DATA VALUES)	RIGHT DIGIT (SUM OF DATA VALUES)
blank (•)	
[Default = blank (•) blank (•)]	

RIGHT DATA VALUES (CIRCLE )	SYSTEM OPTIONS
1	Disable Fire Reset (Area 1)
2	Disable Fire Reset (Area 2)
4	RESERVED
8	RESERVED

ADDRESS 2416	
LEFT DIGIT (SUM OF DATA VALUES)	RIGHT DIGIT (SUM OF DATA VALUES)
blank (•)	
[Default = blank (•) blank (•)]	

RIGHT DATA VALUES (CIRCLE )	SYSTEM OPTIONS
1	Enable Day Zone Watch (Area 1)
2	Enable Day Zone Watch (Area 2)
4	RESERVED
8	RESERVED

SYSTEM OPTIONS	LEFT DATA VALUES (CIRCLE )
Enable Reporting to PC Preset	1
Answering Machine P/U W/O Line Seizure	2
Disable Auto-Unbypass on Disarming	4
Bypass Faulted Zones	8

ADDRESS 2417	
LEFT DIGIT (SUM OF DATA VALUES)	RIGHT DIGIT (SUM OF DATA VALUES)
[Default = blank (•) blank (•)]	

RIGHT DATA VALUES (CIRCLE )	SYSTEM OPTIONS
1	Opening Report only after Alarm Report
2	Closing Report only on Cond. Closing (Auto-Byp.)
4	Include Sel./Grp. Bypass in Cond. Closing Status
8	Status Report (Auto-Byp. Zones on Clos.)

SYSTEM OPTIONS	LEFT DATA VALUES (CIRCLE )
Access Control (Panel) on Aux. Output	1
Enable Burg. Output Warning on Entry	2
Enable Manager's Mode	4
Start Exit Delay after Ringback	8





ADDRESS 2418	
LEFT DIGIT (SUM OF DATA VALUES)	RIGHT DIGIT (SUM OF DATA VALUES)
[Default = blank (•) blank (•)]	

RIGHT DATA VALUES (CIRCLE )	SYSTEM OPTIONS
1	Auto Bell Test on Arming
2	Auto Reset after Burg. Output Timeout
4	Suppress "Bypass" Reminder when Armed
8	RESERVED

SYSTEM OPTIONS	LEFT DATA VALUES (CIRCLE )
Disable Function-Mode Download	1
Disable Callback Download	2
Disable Answering-Machine Download	4
Disable Auto-Reset on Day Zone	8

ADDRESS 2419	
LEFT DIGIT (SUM OF DATA VALUES)	RIGHT DIGIT (SUM OF DATA VALUES)
[Default = blank (•) blank (•)]	

RIGHT DATA VALUES (CIRCLE )	SYSTEM OPTIONS
1	Interior 1 Normally Bypassed
2	Enable Exit-Delay Restart
4	Reset Day Zone with Arm/Disarm Only
8	Enable Local Alarm on First Zone "AND" Trip

-  1. Select the desired option by circling  the data values for each digit (left and right).
 -  2. Add the data values (ex: 15=1+2+4+8) from the selected options.
 -  3. Enter in address location (left and right digits).
- NOTE:** Dark shaded data value box shows option not available.

System Options



SYSTEM OPTIONS (ADDRESS 2420-2422 & 4084)

System Options

SYSTEM OPTIONS	LEFT DATA VALUES (CIRCLE)	ADDRESS 2420		RIGHT DATA VALUES (CIRCLE)	SYSTEM OPTIONS	
Disable Keypad Instant Button	1	←	LEFT DIGIT (SUM OF DATA VALUES)	→	1	Disable System Trouble Audible at Keypad
Enable Line-Fault Test	2		RIGHT DIGIT (SUM OF DATA VALUES)		2	Chime on E4 Lug
Disable AC Fail Detection	4	←	[Default = blank (•) blank (•)]	→	4	Disable Code required for Func. Mode Lvl. 1
Telco Fail only when Armed	8	←		→	8	Disable Code required for Easy Bypass

SYSTEM OPTIONS	LEFT DATA VALUES (CIRCLE)	ADDRESS 2421		RIGHT DATA VALUES (CIRCLE)	SYSTEM OPTIONS	
Don't Clear Aux. Relay with Arm/Disarm	1	←	LEFT DIGIT (SUM OF DATA VALUES)	→	1	Automatic Interior Bypass *
Telco Answering Service Override	2		RIGHT DIGIT (SUM OF DATA VALUES)		2	Veri-phone Zones trip Aux. Relay
Disable Auto Status	4	←	[Default = blank (•) blank (•)]	→	4	Veri-phone Zones Priority over Alarms
Veri-phone Zones trip Fire Output	8	←		→	8	Enable Output Chirp on Keyfob Arm/Disarm

* **Note:** If "Automatic Interior Bypass" in Address 2421 is selected, then "Interior 1 Normally Bypassed" in Address 2419 must also be selected.

SYSTEM OPTIONS	LEFT DATA VALUES (CIRCLE)	ADDRESS 2422		RIGHT DATA VALUES (CIRCLE)	SYSTEM OPTIONS	
Disable Area Entry Relays	1	←	LEFT DIGIT (SUM OF DATA VALUES)	→	1	Fire Output Cadence
Disable Exit/Entry Urgency Tone at Keypad	2		RIGHT DIGIT (SUM OF DATA VALUES)		2	Wireless Smoke Low Battery Resound
Enable Burg. Output for Keyfob Chirp	4	←	[Default = blank (•) blank (•)]	→	4	Supervised Alarm Output
Enable Burg. Output on Telco Fail only when Armed	8	←		→	8	Enable Smoke Detector Dirty Trouble

SYSTEM OPTIONS	LEFT DATA VALUES (CIRCLE)	ADDRESS 4084			
RESERVED	1	←	LEFT DIGIT (SUM OF DATA VALUES)	→	[Default = blank (•) blank (•)]
RESERVED	2		RIGHT DIGIT (SUM OF DATA VALUES)		
RESERVED	4	←		→	
Disable Auto Dial Tone Detection	8	←		→	

Note: Right digit is RESERVED (not used). Enter data in left digit only.

1. Select the desired option by circling the data values for each digit (left and right).
 2. Add the data values (ex: 15=1+2+4+8) from the selected options.
 3. Enter in address location (left and right digits).
- NOTE:** Dark shaded data value box shows option not available.

KEYPAD OPTIONS (ADDRESS 2425-2531)

Keypad 1 Type & Area Assignment	ADDRESS 2425	
	LEFT	RIGHT

[Default = blank (•) 1]

Keypad 2 Type & Area Assignment	ADDRESS 2426	
	LEFT	RIGHT

[Default = blank (•) blank (•)]

Keypad 3 Type & Area Assignment	ADDRESS 2427	
	LEFT	RIGHT

[Default = blank (•) blank (•)]

Keypad 4 Type & Area Assignment	ADDRESS 2428	
	LEFT	RIGHT

[Default = blank (•) blank (•)]

Keypad 5 Type & Area Assignment	ADDRESS 2429	
	LEFT	RIGHT

[Default = blank (•) blank (•)]

Keypad 6 Type & Area Assignment	ADDRESS 2430	
	LEFT	RIGHT

[Default = blank (•) blank (•)]

Keypad 7 Type & Area Assignment	ADDRESS 2431	
	LEFT	RIGHT

[Default = blank (•) blank (•)]



KEYPAD TYPE & AREA ASSIGNMENT: Up to 7 keypads may be programmed, if they are connected.

NOTE: See Keypad Configuration Mode. By default from the factory, each keypad is configured as number 1.

KEYPAD TYPE		KEYPAD AREA ASSIGNMENT	
LEFT	OPTION	RIGHT	OPTION
blank (•)	Burg Keypad	blank (•)	Not Used
2	Wizard Keypad	1	Area 1
		2	Area 2

 1. Select keypad type & area assignment for each keypad from the tables shown.

 2. Enter in corresponding right and left digit address locations above.

KEYPAD NO.	KEYPAD OPTIONS				ADDRESS 2440-2446			KEYPAD OPTIONS			
	LEFT DATA VALUES (CIRCLE )				LEFT	ADDR	RIGHT	RIGHT DATA VALUES (CIRCLE )			
	TOUR STATION	PANEL ACCESS	EASY ARMING	AMBUSH				Rem. Acc. Only *	KEYPAD PANIC	KEYPAD AUXILIARY	KEYPAD FIRE
1	8	4	2	1	2440		8	4	2	1	
2	8	4	2	1	2441		8	4	2	1	
3	8	4	2	1	2442		8	4	2	1	
4	8	4	2	1	2443		8	4	2	1	
5	8	4	2	1	2444		8	4	2	1	
6	8	4	2	1	2445		8	4	2	1	
7	8	4	2	1	2446		8	4	2	1	

[Default = blank (•) blank (•) from address 2440-2446]

KEYPAD OPTIONS: Select options for any of the 7 keypads.

* **Note:** For Remote Access Control only (no Arm/Disarm capability).

 1. Select the desired option by circling  the data values for each digit (left and right).

 2. Add the data values (ex: 15=1+2+4+8) from the selected options.

 3. Enter in address location (left and right digits). **NOTE:** Dark shaded data value box shows option not available.

Enable User Code by Area	ADDRESS 2500-2515		
	LEFT	ADDR	RIGHT
01	blank (•)	2500	
02	blank (•)	2501	
03	blank (•)	2502	
04	blank (•)	2503	
05	blank (•)	2504	
06	blank (•)	2505	
07	blank (•)	2506	
08	blank (•)	2507	
09	blank (•)	2508	
10	blank (•)	2509	
11	blank (•)	2510	
12	blank (•)	2511	
13	blank (•)	2512	
14	blank (•)	2513	
15	blank (•)	2514	
16	blank (•)	2515	

Enable User Code by Area	ADDRESS 2516-2531		
	LEFT	ADDR	RIGHT
17	blank (•)	2516	
18	blank (•)	2517	
19	blank (•)	2518	
20	blank (•)	2519	
21	blank (•)	2520	
22	blank (•)	2521	
23	blank (•)	2522	
24	blank (•)	2523	
25	blank (•)	2524	
26	blank (•)	2525	
27	blank (•)	2526	
28	blank (•)	2527	
29	blank (•)	2528	
30	blank (•)	2529	
31	blank (•)	2530	
32	blank (•)	2531	

ENABLE USER CODE BY AREA: Up to 32 users may be programmed.

NOTE: Users may be assigned to one or both areas.

 1. Select area assignment for each user from the table shown.

 2. Enter in corresponding right digit address locations above (left digit is not used).

NOTE: Dark shaded data value box shows option not available.

ENABLE USER CODE BY AREA		
DATA ENTRIES		OPTION
LEFT	RIGHT	
blank (•)	blank (•)	Not Used
blank (•)	1	Area 1
blank (•)	2	Area 2
blank (•)	3	Area 1 & Area 2 (Both)

[Default = blank (•) 1 for address 2500] [Default = blank (•) blank (•) from address 2501-2531]



EZM GROUP OPTIONS (ADDRESS 2600-2627)

EZM Group 1	
ADDRESS 2600	
LEFT	RIGHT
blank (*)	

EZM Group 2	
ADDRESS 2601	
LEFT	RIGHT
blank (*)	

EZM Group 3	
ADDRESS 2602	
LEFT	RIGHT
blank (*)	

EZM Group 4	
ADDRESS 2603	
LEFT	RIGHT
blank (*)	

EZM Group 5	
ADDRESS 2604	
LEFT	RIGHT
blank (*)	

EZM Group 6	
ADDRESS 2605	
LEFT	RIGHT
blank (*)	

Default depends on Easy Menu Question "Rl ##ZN-08 ##KP-1". For example, If 32 zones are used, then all 6 groups will be automatically enabled. If only 8 zones are used, then groups 1-4 will be automatically disabled.

NOTE: Zones 1-8 are included in the control panel and Zones 9-32 (Groups 1-6) are EZM Zones (either Wireless or Hardwired).

EZM TYPE	
DATA ENTRIES	OPTION
RIGHT	
blank (*)	Not used (No EZM present)
1	4-Zone EZM

EZM TYPE	ZONES COVERED
1	9-12
2	13-16
3	17-20
4	21-24
5	25-28
6	29-32

EZM GROUP OPTIONS: Up to 6 Groups of 4 Zones each may be programmed depending on the number of zones used and which EZM modules are connected. Each group represents 4 zones.

1. Select EZM type from the table shown.
2. Enter in corresponding address locations above (right digit only).

NOTE: Dark shaded data value box shows option not available.

EZM PGM ARMED TERMINAL CONTROL			
GROUP NUMBER	ADDRESS 2622-2627		
	LEFT	ADDR	RIGHT
1	blank (*)	2622	
2	blank (*)	2623	
3	blank (*)	2624	
4	blank (*)	2625	
5	blank (*)	2626	
6	blank (*)	2627	

EZM PGM ARMED TERMINAL CONTROL: For each zone group select the area(s) which, when armed, will activate the PGM Lug on the corresponding EZM modules. Each zone group corresponds to 4 zones. If 8-Zone EZMs are used each one is treated as TWO zone groups.

NOTE: Lug goes ACTIVE (low) when ANY selected area is armed. When activated, the PGM Lug goes negative (to Ground).

1. Select area assignment for each keypad from the table shown.
2. Enter in corresponding right digit address locations above (left digit is not used).

NOTE: Dark shaded data value box shows option not available.

[Default = blank (*) blank (*) from address 2622-2627]

EZM PGM ARMED TERMINAL CONTROL		
DATA ENTRIES		AREA
LEFT	RIGHT	
blank (*)	blank (*)	Not Used
blank (*)	1	Area 1
blank (*)	2	Area 2
blank (*)	3	Area 1 & Area 2 (Both)

AREA ARMING OPTIONS (ADDRESS 2650 & 2651)

Priority Arming/ Area 1	ADDRESS 2650	
	LEFT	RIGHT
	blank (*)	

[Default = blank (*) blank (*)]

Priority Arming/ Area 2	ADDRESS 2651	
	LEFT	RIGHT
	blank (*)	

[Default = blank (*) blank (*)]

PRIORITY AREA ARMING:

1. Select option from the table shown.
2. Enter in corresponding right digit address location (left digit is not used).

NOTE: Dark shaded data value box shows option not available.

PRIORITY ARMING/AREA 1		
DATA ENTRIES		OPTION
LEFT	RIGHT	
blank (*)	blank (*)	Not Used
blank (*)	2	Enabled

PRIORITY ARMING/AREA 2		
DATA ENTRIES		OPTION
LEFT	RIGHT	
blank (*)	blank (*)	Not Used
blank (*)	1	Enabled

AREA OUTPUT CONTROL OPTIONS (ADDRESS 2700-2733)





OUTPUT SILENCED (TURNED OFF)	ADDRESS			DISARMING AREA 1			
	2700, 2708, 2716, 2724 & 2732			RIGHT DATA VALUES (CIRCLE )			
	LEFT	ADDR	RIGHT	RSRVD.	RSRVD.	Area 2 Output Turns Off	Area 1 Output Turns Off
Burglary Output	blank (*)	2700		8	4	2	1
Pulsed Burg. Output	blank (*)	2708		8	4	2	1
Fire Output	blank (*)	2716		8	4	2	1
Reset Relay	blank (*)	2724		8	4	2	1
Auxiliary Relay	blank (*)	2732		8	4	2	1

[Default = blank (*) blank (*) from

OUTPUT SILENCED (TURNED OFF)	ADDRESS			DISARMING AREA 2			
	2701, 2709, 2717, 2725 & 2733			RIGHT DATA VALUES (CIRCLE )			
	LEFT	ADDR	RIGHT	RSRVD.	RSRVD.	Area 2 Output Turns Off	Area 1 Output Turns Off
Burglary Output	blank (*)	2701		8	4	2	1
Pulsed Burg. Output	blank (*)	2709		8	4	2	1
Fire Output	blank (*)	2717		8	4	2	1
Reset Relay	blank (*)	2725		8	4	2	1
Auxiliary Relay	blank (*)	2733		8	4	2	1

[Default = blank (*) blank (*) from address 2701-2733]



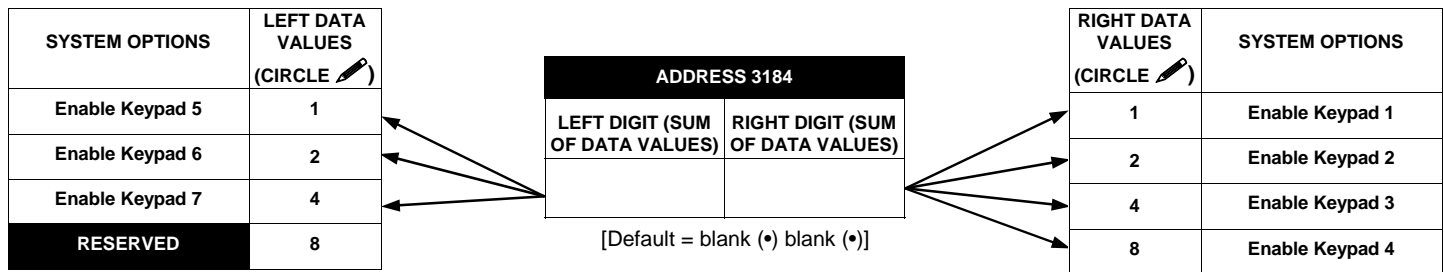

AREA OUTPUT TURNS OFF UPON DISARM: Select options for any of the 5 Outputs per area when disarming a particular area.

-  1. Select the desired option by circling  the data values for right digit only (left is not used).
-  2. Add the data values (ex: 15=1+2+4+8) from the selected options.
-  3. Enter in right digit address location. **NOTE:** Dark shaded data value box shows option not available.

REMOTE ACCESS LOGGING (ADDRESS 3184)



REMOTE ACCESS LOGGING: Enable logging of every keypad access event.

-  1. Select the desired option by circling  the data values for each digit (left and right).
-  2. Add the data values (ex: 15=1+2+4+8) from the selected options.
-  3. Enter in address location (left and right digits).



NOTE: Dark shaded data value box shows option not available.

NUMBER OF RELAY BOARD MODULES (ADDRESS 3777)

Number of Relay Board Modules	ADDRESS 3777		Relay Board Module(s)
	LEFT	RIGHT	
	blank (*)		None
	1		1
	2		2
	3		3

[Default = blank (*) blank (*)]

RELAY BOARD MODULES: Up to 3 External Relay Board Modules (RM3008) may be programmed.

-  1. Select the number of relay modules from the table shown.
-  2. Enter in corresponding right digit address location shown (left digit is not used).

Area Output Control, Remote Access Logging & No. of Relay Board Modules Options



EXTERNAL RELAY CONTROL (ADDRESS 3778-3801 & 2800-2895)

External Relay Control

ADDRESS 3778 & 2800-2803 (RELAY/ENTRY 1)									
3778		2800		2801		2802		2803	
L	R	L	R	L	R	L	R	L	R
			(*)						

ADDRESS 3781 & 2812-2815 (RELAY/ENTRY 4)									
3781		2812		2813		2814		2815	
L	R	L	R	L	R	L	R	L	R
			(*)						

ADDRESS 3784 & 2824-2827 (RELAY/ENTRY 7)									
3784		2824		2825		2826		2827	
L	R	L	R	L	R	L	R	L	R
			(*)						

ADDRESS 3787 & 2836-2839 (RELAY/ENTRY 10)									
3787		2836		2837		2838		2839	
L	R	L	R	L	R	L	R	L	R
			(*)						

ADDRESS 3790 & 2848-2851 (RELAY/ENTRY 13)									
3790		2848		2849		2850		2851	
L	R	L	R	L	R	L	R	L	R
			(*)						

ADDRESS 3793 & 2860-2863 (RELAY/ENTRY 16)									
3793		2860		2861		2862		2863	
L	R	L	R	L	R	L	R	L	R
			(*)						

ADDRESS 3796 & 2872-2875 (RELAY/ENTRY 19)									
3796		2872		2873		2874		2875	
L	R	L	R	L	R	L	R	L	R
			(*)						

ADDRESS 3799 & 2884-2887 (RELAY/ENTRY 22)									
3799		2884		2885		2886		2887	
L	R	L	R	L	R	L	R	L	R
			(*)						

ADDRESS 3779 & 2804-2807 (RELAY/ENTRY 2)									
3779		2804		2805		2806		2807	
L	R	L	R	L	R	L	R	L	R
			(*)						

ADDRESS 3782 & 2816-2819 (RELAY/ENTRY 5)									
3782		2816		2817		2818		2819	
L	R	L	R	L	R	L	R	L	R
			(*)						

ADDRESS 3785 & 2828-2831 (RELAY/ENTRY 8)									
3785		2828		2829		2830		2831	
L	R	L	R	L	R	L	R	L	R
			(*)						

ADDRESS 3788 & 2840-2843 (RELAY EVENT 11)									
3788		2840		2841		2842		2843	
L	R	L	R	L	R	L	R	L	R
			(*)						

ADDRESS 3791 & 2852-2855 (RELAY/ENTRY 14)									
3791		2852		2853		2854		2855	
L	R	L	R	L	R	L	R	L	R
			(*)						

ADDRESS 3794 & 2864-2867 (RELAY/ENTRY 17)									
3794		2864		2865		2866		2867	
L	R	L	R	L	R	L	R	L	R
			(*)						

ADDRESS 3797 & 2876-2879 (RELAY/ENTRY 20)									
3797		2876		2877		2878		2879	
L	R	L	R	L	R	L	R	L	R
			(*)						

ADDRESS 3800 & 2888-2891 (RELAY/ENTRY 23)									
3800		2888		2889		2890		2891	
L	R	L	R	L	R	L	R	L	R
			(*)						

ADDRESS 2808-2811 & 3780 (RELAY/ENTRY 3)									
3780		2808		2809		2810		2811	
L	R	L	R	L	R	L	R	L	R
			(*)						

ADDRESS 3783 & 2820-2823 (RELAY/ENTRY 6)									
3783		2820		2821		2822		2823	
L	R	L	R	L	R	L	R	L	R
			(*)						

ADDRESS 3786 & 2832-2835 (RELAY/ENTRY 9)									
3786		2832		2833		2834		2835	
L	R	L	R	L	R	L	R	L	R
			(*)						

ADDRESS 3789 & 2844-2847 (RELAY/ENTRY 12)									
3789		2844		2845		2846		2847	
L	R	L	R	L	R	L	R	L	R
			(*)						

ADDRESS 3792 & 2856-2859 (RELAY/ENTRY 15)									
3792		2856		2857		2858		2859	
L	R	L	R	L	R	L	R	L	R
			(*)						

ADDRESS 3795 & 2868-2871 (RELAY/ENTRY 18)									
3795		2868		2869		2870		2871	
L	R	L	R	L	R	L	R	L	R
			(*)						

ADDRESS 3798 & 2880-2883 (RELAY/ENTRY 21)									
3798		2880		2881		2882		2883	
L	R	L	R	L	R	L	R	L	R
			(*)						

ADDRESS 3801 & 2892-2895 (RELAY/ENTRY 24)									
3801		2892		2893		2894		2895	
L	R	L	R	L	R	L	R	L	R
			(*)						

RELAY/ENTRY OPTIONS									
MAP		AREA		Timeout		Event ID		COND.	
L	R	L	R	L	R	L	R	L	R
			(*)						

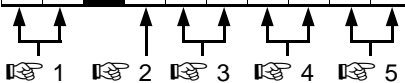

[Default = blank (*) blank (*) from address 3778-3801 & 2800-2895]

RELAY MAPPING OPTIONS: Each relay/entry can be assigned to any of the 24 available external relays from Relay Module RM3008. Multiple entries can drive the same External Relay.

1. Select the relay from the table shown; enter in corresponding left and right digit address locations.

* Note: [blank (*) blank (*)] option affects the relay with the same entry number. All other options affect the relay number specified.
 Ex: Suppose Relay/Entry 1 is mapped to External Relay 1 and Relay/Entry 2 is mapped to External Relay 24. The data entries are as follows: Address 3778 = [blank (*) blank (*)] and Address 3779 = [1C].

DATA ENTRY	OFF/ON AREA DISARM
blank (*)	NONE
1	Area 1
2	Area 2
3	Area 1 & Area 2

RELAY MAPPING		
DATA ENTRIES		RELAY #
LEFT	RIGHT	
blank (*)	blank (*)	None *
blank (*)	1	1
blank (*)	2	2
blank (*)	3	3
blank (*)	4	4
blank (*)	5	5
blank (*)	6	6
blank (*)	7	7
blank (*)	8	8
blank (*)	9	9
blank (*)	0	10
blank (*)	B	11

RELAY MAPPING		
DATA ENTRIES		RELAY #
LEFT	RIGHT	
blank (*)	C	12
blank (*)	D	13
blank (*)	E	14
blank (*)	F	15
1	blank (*)	16
1	1	17
1	6	18
1	7	19
1	8	20
1	9	21
1	0	22
1	B	23
1	C	24

TIMEOUTS: Each relay event can be assigned a timeout depending on Alarm Type option.

 3. If Alarm Type (see next page) is selected for timeout in minutes or seconds, select the timeout from the table shown in minutes or seconds and enter in corresponding address location (left digit and right digits).

TIMEOUTS (Alarm Type is selected for Timeout Type in min. or sec.)			TIMEOUTS (Alarm Type is selected for Timeout Type in min. or sec.)			TIMEOUTS (Alarm Type is selected for Timeout Type in min. or sec.)		
DATA ENTRIES		TIMEOUT	DATA ENTRIES		TIMEOUT	DATA ENTRIES		TIMEOUT
LEFT	RIGHT		LEFT	RIGHT		LEFT	RIGHT	
blank (*)	blank (*)	0 min./sec.	blank (*)	B	11 min./sec.	1	6	11 min./sec.
blank (*)	1	1 min./sec.	blank (*)	C	12 min./sec.	1	7	12 min./sec.
blank (*)	2	2 min./sec.	blank (*)	D	13 min./sec.	1	8	13 min./sec.
blank (*)	3	3 min./sec.	blank (*)	E	14 min./sec.	1	9	14 min./sec.
blank (*)	4	4 min./sec.	blank (*)	F	15 min./sec.	1	0	15 min./sec.
blank (*)	5	5 min./sec.	1	blank (*)	16 min./sec.	1	B	16 min./sec.
blank (*)	6	6 min./sec.	1	1	17 min./sec.	1	C	17 min./sec.
blank (*)	7	7 min./sec.	1	2	18 min./sec.	1	D	18 min./sec.
blank (*)	8	8 min./sec.	1	3	19 min./sec.			
blank (*)	9	9 min./sec.	1	4	20 min./sec.			
blank (*)	0	10 min./sec.	1	5	21 min./sec.	F	F	255 min./sec.

 For a desired delay/timeout not listed do the following:

- A. Choose a desired delay/timeout, ex: 20 min.
- B. Divide it by 16

$$\begin{array}{r}
 \textcircled{1} \text{ Quotient} \longrightarrow \text{Left Digit} \\
 16 \overline{) 20} \\
 \underline{-16} \\
 \textcircled{4} \text{ Remainder} \longrightarrow \text{Right Digit}
 \end{array}$$

EVENT ID CODES: Each relay event can be assigned any of the available event IDs from the table.

 4. Select 2-digit Event ID from the table shown below; enter in corresponding address locations (left and right digit).

EVENT ID CODES			EVENT ID CODES		
DATA ENTRIES		OPTION	DATA ENTRIES		OPTION
LEFT	RIGHT		LEFT	RIGHT	
blank (*)	blank (*)	Area 1 Arm/Disarm	6	B	Area 1 Keypad Medical
blank (*)	1	Area 2 Arm/Disarm	6	C	Keypad Tamper
blank (*)	8	Zone 1	6	D	Area 1 Fail to Open
blank (*)	9	Zone 2	6	E	Area 1 Fail to Close
blank (*)	0	Zone 3	7	blank (*)	Area 2 Keypad Ambush
blank (*)	B	Zone 4	7	1	Area 2 Keypad Panic
blank (*)	C	Zone 5	7	2	Area 2 Keypad Fire
blank (*)	D	Zone 6	7	3	Area 2 Keypad Medical
blank (*)	E	Zone 7	7	5	Area 2 Fail to Open
blank (*)	F	Zone 8	7	6	Area 2 Fail to Close
1	blank (*)	Zone 9	0	8	Test Timer
1	1	Zone 10	0	0	Bus Fail
1	2	Zone 11	0	B	Guarded RAM Fail
1	3	Zone 12	0	C	Low Battery
1	4	Zone 13	0	D	AC Fail
1	5	Zone 14	0	E	EZM Tamper
1	6	Zone 15	0	F	Sensor Watch
1	7	Zone 16	B	blank (*)	Telco Fault
1	8	Zone 17	B	8	Digital Dialer Test
1	9	Zone 18	B	B	Service Message
1	0	Zone 19	B	C	Program Change
1	B	Zone 20	B	D	RF Receiver Trouble
1	C	Zone 21	B	E	Transmitter Tamper
1	D	Zone 22	B	F	Transmitter Trouble
1	E	Zone 23	D	blank (*)	Keypad Fail
1	F	Zone 24	D	1	EZM Fail
2	blank (*)	Zone 25	D	2	Quickloader Device Control
2	1	Zone 26	D	3	System Shutdown
2	2	Zone 27	D	4	Quickloader Keypad Reset
2	3	Zone 28	D	5	General System Alarm
2	4	Zone 29	D	8	Area 1 General System Alarm
2	5	Zone 30	D	9	Area 2 General System Alarm
2	6	Zone 31	F	blank (*)	Relay Group 1
2	7	Zone 32	F	1	Relay Group 2
6	8	Area 1 Keypad Ambush	F	8	Area 1 Entry Delay
6	9	Area 1 Keypad Panic	F	9	Area 2 Entry Delay
6	0	Area 1 Keypad Fire			

RELAY EVENT CONDITION OPTIONS: Each relay event can be assigned an alarm type; and an activation condition; also, select a timeout type for each.

 5A. Select Alarm Type and Timeout Type from the table shown below; enter in corresponding address location (left digit). **NOTE:** Select timeout from previous page.

 5B. Select Activation from the table shown below; enter in corresponding address location (right digit).

RELAY EVENT ALARM TYPE OPTIONS		
LEFT DATA ENTRIES	ALARM TYPE	TIMEOUT TYPE
blank (*)	Burglary	Minutes
1	Fire	Minutes
4	Day Zone	Minutes
8	Burglary	Seconds
9	Fire	Seconds
C	Day Zone	Seconds

RELAY EVENT ACTIVATION CONDITIONS	
RIGHT DATA ENTRIES	OPTIONS
1	Alarm
2	Restore
3	Trouble
4	Trouble Restore
5	Follow Zone

RF RECEIVERS & SUPERVISORY TIMER OPTIONS (ADDRESS 3776 & 3760-3775)

Number of RF Receivers	ADDRESS 3776		DATA ENTRIES	RF Receiver(s)	
	LEFT	RIGHT			
		blank (*)			RIGHT
			blank (*)		blank (*)
			1	1	
			2	2	

Default for Number of Receivers depends on Easy Menu Question for RF Transmitters.

RF RECEIVERS: Up to 2 RF Receivers may be programmed.
NOTE: This adds wireless capability to the system, increasing up to 32 the number of zones.

1. Select the number of receivers from the table shown.
2. Enter in corresponding right digit address location shown (left digit is not used).

RF SUPERVISORY TIMER	RF TRANSMITTER	ADDRESS 3760-3767		
		LEFT	ADDR	RIGHT
Type 0	Window/Door, 2 Pt.		3760	
Type 1	Window/Door, 2 Pt.		3761	
Type 2	Window/Door, 2 Pt.		3762	
Type 3	Window/Door, 2 Pt.		3763	
Type 4	Window/Door, 4 Pt.		3764	
Type 5	PIR		3765	
Type 6	PIR		3766	
Type 7	Smoke Detector		3767	

[Default = blank (*) blank (*) from address 3760-3767]

RF SUPERVISORY TIMER	RF TRANSMITTER	ADDRESS 3768-3775		
		LEFT	ADDR	RIGHT
Type 8	Smoke Detector		3768	
Type 9	Keyfob		3769	
Type A	Dual Tech.		3770	
Type B	Keyfob		3771	
Type C	Window/Door, 4 Pt.		3772	
Type D	PIR		3773	
Type E	Smoke Detector		3774	
Type F	Napco Glass Break		3775	

[Default = blank (*) blank (*) from address 3768-3775]

RF Receivers & Supervisory Timer Options

RF SUPERVISORY TIMERS		
DATA ENTRIES		DELAY
LEFT	RIGHT	
blank (*)	blank (*)	0 min.
blank (*)	1	30 min.
blank (*)	2	60 min.
blank (*)	3	90 min.
blank (*)	4	120 min.
blank (*)	5	150 min.
blank (*)	6	180 min.
blank (*)	7	210 min.
blank (*)	8	240 min.
blank (*)	9	270 min.
blank (*)	0	300 min.
blank (*)	B	330 min.
blank (*)	C	360 min.
blank (*)	D	390 min.
blank (*)	E	420 min.
blank (*)	F	450 min.
1	blank (*)	480 min.
1	1	510 min.
1	2	540 min.
1	3	570 min.
1	4	600 min.
1	5	630 min.
1	6	660 min.
1	7	690 min.
1	8	720 min.
1	9	750 min.
1	0	780 min.
1	B	810 min.
1	C	840 min.
1	D	870 min.
1	E	900 min.
1	F	930 min.
2	blank (*)	960 min.
2	1	990 min.
2	2	1020 min.
2	3	1050 min.
2	4	1080 min.
2	5	1110 min.

RF SUPERVISORY TIMERS		
DATA ENTRIES		DELAY
LEFT	RIGHT	
2	6	1140 min.
2	7	1170 min.
2	8	1200 min.
2	9	1230 min.
2	0	1260 min.
2	B	1290 min.
2	C	1320 min.
2	D	1350 min.
2	E	1380 min.
2	F	1410 min.
3	blank (*)	1440 min.
3	1	1470 min.
3	2	1500 min.
3	3	1530 min.
3	4	1560 min.
3	5	1590 min.
3	6	1620 min.
3	7	1650 min.
3	8	1680 min.
3	9	1710 min.
3	0	1740 min.
3	B	1770 min.
3	C	1800 min.
3	D	1830 min.
3	E	1860 min.
3	F	1890 min.
4	blank (*)	1920 min.
4	1	1950 min.
4	2	1980 min.
4	3	2010 min.
4	4	2040 min.
4	5	2070 min.
4	6	2100 min.
↓	↓	↓
F	F	7650 min. = 127 Hr., 30 min.

RF SUPERVISORY TIMERS: RF Supervisory Timers may be programmed for each type of transmitter used. A transmitter will send a transmission every time it is tripped, when there is NO activity, the transmitter sends a status transmission about once an hour. If the receiver does NOT receive ANY signal (a trip or a status) from a transmitter in the time specified for transmitter type, a system trouble "RF SUPERVISORY FAILURE" will be displayed at the keypad.

1. Select timer delay from the table shown. Timers are programmed in increments of 30 minutes each. Valid entries are 03-FF, 90 minutes-7650min (127hr,30min).
 - WARNING:** Timers have uncertainty of +/-30 minutes. Do not use entries 0-2 (shaded areas).
2. Enter in corresponding address locations above (left and right digits).
3. For a desired *timer not* listed do the following:
 - A. Choose a desired timer (intervals of 30), ex: 3000 min. (50 Hours)
 - B. Divide it by 30, ex: 3000/30 = 100
 - C. Divide it by 16

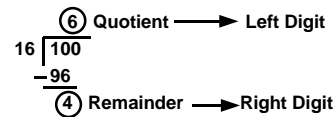

NOTE: These timers apply only to Supervised RF Transmitters (see RF Transmitters in Easy Menu Driven Mode Programming).

SYSTEM RESET OPTIONS (ADDRESS 4090-4093)

4090 XX

GEM-RP1CAe2 Keypad

Easy Setup for RF Only Systems

WARNING

Automatically removes all EZMs programmed in the Easy Menu Program Mode. (This must be the last step in the programming menu.)

4090XX

GEM-RP2ASe2 Keypad

Access address 4090, then press the  button. Data entry is not allowed.

4091 XX

GEM-RP1CAe2 Keypad

Clear Dealer Program (Erases Dealer Program)

WARNING

This *erases the dealer program*. Use this feature to start a customized default program.

4091XX

GEM-RP2ASe2 Keypad

Access address 4091, then press the  button. Data entry is not allowed.

NOTE: Enter Easy Menu Driven Program Mode to program system again.

4093 XX

GEM-RP1CAe2 Keypad

Cold Start (Erases Entire Program)

WARNING

This erases the entire program (codes, schedules, etc), leaving the panel as it came right out of the box.

4093XX

GEM-RP2ASe2 Keypad

Access address 4093, then press the  button. Data entry is not allowed.

NOTE: Some features (schedules) can only be programmed again with the Downloading Software.

USER PROGRAM MODE

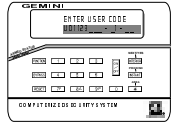

PRELIMINARY INFORMATION

The User Program Mode is covered in detail in the operating instructions for the keypad in use.

- ☞ Only Keypad #1 may be used for programming, however this keypad may be located in any area.
- ☞ The Program Mode cannot be accessed while the communicator is transmitting except during the first three minutes after power-up.
- ☞ After entering codes or data, press the save button. Data will not be stored into memory unless this button is pressed.
- ☞ If the keypad is in the Program Mode and no activity is detected for longer than 4 minutes, a steady tone will sound. Press the button to silence the sounder and exit the User Program Mode.

NOTE: For ease of programming, it is recommended that a GEM-RP1CAe2 be used as Keypad #1. (A new GEM-RP1CAe2 is automatically configured as Keypad #1.)

If a GEM-RP2ASe2 is used, configure address jumpers as Keypad #1 (see the section of this manual Configuring the GEM-RP2ASe2 Keypad). Use the button to manually scroll the display at the end of each programming line.

User Program Mode: Accessing Program Mode

ACCESSING USER PROGRAM MODE

1. Press
 - ← New Panel (Default User Code = 123)
 - Existing Panel (Any Code with User Program Option Enabled)
2. Press Until "ACTIVATE PROGRAM Y/N" (GEM-RP1CAe2) or "TURN ON PROG Y/N" (GEM-RP2ASe2) appears on LCD screen.
3. Press To Enter User Program Mode
4. Press To Exit User Program Mode when finished

USER CODES

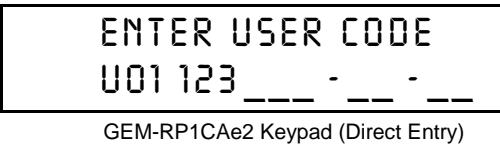

Up to 32 User Codes may be programmed.

NOTE: In this mode, only the code is programmable; the accompanying Area Options must be programmed in the Dealer Program Mode (see page 8).

- ☞ Use the button to place the cursor over the User Number.
- ☞ Enter a User Number (01–32) using the number buttons. The cursor will then advance to the User Code and read the existing code, if any.

User Code NOT USED

GEMINI

U01 123 - -

Enter user code

To Program User Codes

1. Set Cursor Position using the button.
2. Enter 2-digit User Number (01-32) directly using number buttons (0-9).
3. Enter Code (1-6 digits) directly using number buttons (0-9).
4. Press the to save each code.

NOTE: Press button to clear character at cursor.

To continue press or .

Programming User Codes

- ☞ Enter the new User Code using the number buttons (0-9). If an old code is displayed, program over it. To erase the digit at the cursor, press **[*]** **[0]** button.
- ☞ Press the **[ON/OFF]** button to save the code in memory.
- ☞ Repeat this procedure for each user. To proceed to Zone-Description programming, press the NEXT (**[INTERIOR]**) button or the PRIOR (**[INSTANT]**) button.

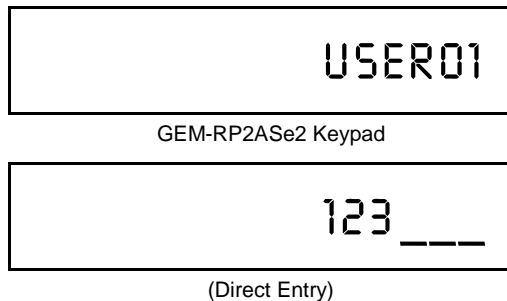

To Program User Codes

1. Enter 2-digit User Number (01-32) directly using number buttons (0-9).
2. Press the **[FUNCTION]** button.
3. Enter Code (1-6 digits) directly using number buttons (0-9).
4. Press the **[ON/OFF]** button to save each code.

The diagram shows the Gemini keypad interface. At the top, the word 'GEMINI' is displayed. Below it, a display shows 'User01'. An 'ARMED STATUS' indicator is visible. The keypad has buttons for 'FUNCTION CURSOR', 'BYPASS', 'RESET EXIT', '1-9', '0', 'ON/OFF', 'NEXT/YES INTERIOR', 'PRIOR/NO INSTANT', 'AREA *', and 'CLEAR READ'. Arrows indicate the sequence of steps: entering the user number, pressing FUNCTION, entering the code, and pressing ON/OFF. A 'COMPUTERIZED SECURITY SYSTEM' logo is at the bottom.

NOTE: Press **[*]** **[0]** button to clear character at cursor.
To continue press **[INTERIOR]** or **[INSTANT]** button.

Programming User Codes

ZONE DESCRIPTIONS (GEM-RP1CAE2 KEYPADS ONLY)

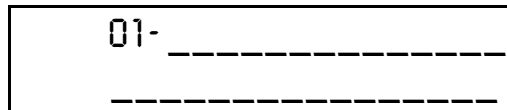

Enter an identifying description for each zone. Buttons **[1]** and **[2]** set the cursor position; buttons **[3]** and **[6]** scroll numbers, letters, punctuation marks, etc.

- ☞ Position the cursor over the displayed Zone Number (i.e., "01") using buttons **[1]** and **[2]**.
- ☞ Change the Zone Number using buttons **[3]** and **[6]**.
- ☞ Position the cursor over the first character of the description field. Advancing the cursor between characters, program a description of up to two lines for the new zone using buttons **[3]** and **[6]**.

To Program Zone Descriptions

1. Set the Cursor Position using buttons **[1]** and **[2]**.
2. Select characters for zone description using buttons **[3]** and **[6]**.
4. Press the **[ON/OFF]** button to save each descriptor.

The diagram shows the Gemini keypad interface. At the top, the word 'GEMINI' is displayed. Below it, a display shows '01-'. An 'ARMED STATUS' indicator is visible. The keypad has buttons for 'FUNCTION CURSOR', 'BYPASS', 'RESET EXIT', '1-9', '0', 'ON/OFF', 'NEXT/YES INTERIOR', 'PRIOR/NO INSTANT', 'AREA *', and 'CLEAR READ'. Arrows indicate the sequence of steps: setting the cursor position, selecting characters, and pressing ON/OFF. A 'COMPUTERIZED SECURITY SYSTEM' logo is at the bottom.

NOTE: Press **[*]** **[0]** button to clear character at cursor.
To continue press **[INTERIOR]** or **[INSTANT]** button.

Programming Zone Descriptions

- ☞ Press the **[ON/OFF]** button to save. Advance to the next zone as in Steps 1 and 2 above and repeat this procedure until all zones have been programmed.

KEYPAD CONFIGURATION MODE

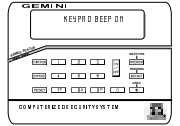

This section will focus on configuring the GEM-RP1CAe2 and GEM-RP2ASe2 Keypads. If there is more than one keypad in the system, *only Keypad No. 1 may be used for programming.*

KEYPAD INSTALLATION

Two types of keypads may be used with the GEM-P1632: the GEM-RP1CAe2 and the GEM-RP2ASe2. Each must be assigned an address number (1–7) and each requires its own configuration procedure (see CONFIGURING THE KEYPADS, which follows, and DIRECT ADDRESS KEYPAD AREA OPTIONS). At least 1 keypad must be used; only 1 is required for a single-area Commercial Burglary installation.

GEM-RP1CAe2 - is a 2-line combination fire/burglary/access keypad capable of supporting 4 EZM zones and a PGM output. A GEM-RP1CAe2 is recommended for use as Keypad #1.

GEM-RP2ASe2 - is a utility LCD keypad combining several preset LCD words with a limited message line. **NOTE:** Due to space constraints, available messages are abbreviated and will scroll automatically.

CONFIGURING THE KEYPADS

A total of up to 7 keypads may be connected to the panel. GEM-RP1CAe2 and GEM-RP2ASe2 keypads may be intermixed but require different configuration procedures, as described in the following paragraphs.

Configuring the GEM-RP1CAe2 Keypad

Each GEM-RP1CAe2 keypad must be configured for (a) keypad tactile beep; (b) entry sounder; (c) keypad address; (d) compatibility number; (e) EZM address; and (f) zone response.

To enter the GEM-RP1CAe2 Configuration Mode:

1. Move jumper JP5 (located at the upper-right corner of the control panel board) from Pins 1-2 (top two) to Pins 2-3 (bottom two). **NOTE:** See Wiring Diagram on page 64.
2. After about 15 seconds, the display will read "XX OUT OF SYSTEM", where XX indicates the keypad address.
3. Press and proceed as follows. (Repeat the following procedure for all keypads.)

**NORMAL
KEYPAD
CONFIGURE**

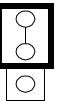

KEYPAD BEEP ON

Keypad Tactile Beep

Upon entering the Keypad Configuration Mode, "KEYPAD BEEP ON" will be displayed, indicating that the tactile beep, which sounds when any button is pressed, is on. To turn off the tactile beep, press the button (the button will toggle the tactile beep on and off).

Press the button to continue or press the button to exit.

ENTRY SOUNDER ON

Entry Sounder

To turn off the keypad sounder during entry time, press the button (the button will toggle the tactile beep on and off). Press the button to continue or press the button to exit.

KEYPAD ADDRESS 01

Keypad Address

If more than one keypad is installed, each must be assigned a unique keypad address (that is, no two keypads may be numbered alike):

- ☞ keypads must be numbered consecutively (missing numbers are not permitted)
- ☞ only Keypad No. 1 may be used for programming.



To assign the keypad number, proceed as follows:

1. Enter the assigned keypad number 01–07, then press the button to save. A valid number will be acknowledged by a short beep; an invalid number will be rejected by a long beep.
2. Press the button to continue or press the button to exit.

NEW COMPAT# 0000

Compatibility Number



The compatibility number is a 4-digit security code that, if programmed into both the control panel and each GEM-RP1CAe2 keypad, dedicates the keypad to only that panel. That is, (a) similar keypads not having the correct compatibility number will not operate in the system and (b) a keypad may

not be removed for use on a system with a different compatibility number. Press the  button to continue or press the  button to exit.

EZM ADDRESS 01

EZM Address

The keypad's internal EZM (Expansion Zone Module) may be utilized to provide four additional wired zones. Whether used alone or in conjunction with optional GEM-EZM series modules or other keypad EZMs, it must be assigned a unique address (or Group number, see Keypad Programming

Workbook) similar to its keypad address. If no other EZMs are to be used, designate the keypad as Group "01" at the "EZM ADDRESS 00" display. In multiple-EZM systems, enter an assigned group number "01" through "06". (Each EZM must have a unique assigned group number, starting with "01" and proceeding consecutively.) Press the  button. Press the  button to continue or press the  button to exit.

ZONE RESPONSE 00

Zone Response

The normal loop response of each keypad expansion zone is 750mS, however the response time of any zone can be reduced to 50mS as follows.

1. Of the following, circle the number(s) in parentheses associated with the zone(s) to be changed:

Zone 1=(1); Zone 2=(2); Zone 3=(4); Zone 4=(8)

2. Add up the circled numbers.



3. At the keypad, enter the sum as a two-digit number "01" through "15" on the display, then press the  button.

Example. Change Zones 2, 3 and 4 to 50mS response.

1. Circle numbers for Zones 2, 3 and 4: (2), (4) and (8).

2. Add up the circled numbers: $2 + 4 + 8 = 14$.

3. Enter "14" at the keypad, then press the  button.

Press the  button to continue or press the  button to exit the Keypad Configuration Mode (display will read "01 OUT OF SYSTEM"). Then replace Jumper JP5 across Pins 1-2 (top two).

Configuring the GEM-RP2ASe2 Keypad

Up to 7 GEM-RP2ASe2 keypads may be connected to the panel (Keypads 1–7). Each must be configured for a keypad address. In addition, the keypad may be configured to disable (a) touchpad backlight; (b) LCD backlight; and (c) entry sounder. Keypads are configured by the proper selection of jumpers. Refer to the label on the circuit board fishpaper (LA1390) for jumper locations and a summary of settings.

KEYPAD NUMBER	KEYPAD NUMBER			PARK
	1	2	3	
1	OFF or ON*	OFF	OFF	STORE SPARE JUMPER AT THIS POSITION
2	OFF	ON	OFF	
3	ON	ON	OFF	
4	OFF	OFF	OFF	
5	ON	OFF	ON	
6	OFF	ON	ON	
7	ON	ON	ON	

KEYPAD ADDRESS

If more than one keypad is installed:

☞ Each must be assigned a unique address (that is, no two keypads may be numbered alike).

☞ Keypads must be addressed consecutively (that is, missing numbers are not permitted).

☞ Only Keypad No. 1 may be used for programming. (However, for ease of programming, it is recommended that a GEM-RP1CAe2 be selected as Keypad #1.)

Assign the keypad address number by selecting Jumpers J1–3 in accordance with the table at left.

***Note:** (1) Keypads are factory supplied with no jumpers installed and as such are automatically configured as Keypad No. 1. (2) Only one keypad in the system may be configured as Keypad No. 1, otherwise none will function.

TOUCHPAD BACK LIGHT

Cut Jumper A to disable touch pad backlighting to conserve 11mA standby current.

LCD BACKLIGHT

Cut Jumper B to disable LCD backlighting.

ENTRY SOUNDER

Cut Jumper C to disable the sounder. (Do not disable in UL applications.)



NAPCO Security Systems, Inc.
 333 Bayview Avenue, Amityville, New York 11701
 For Sales and Repairs, call toll free: (800) 645-9445
 For direct line to Technical Service, call toll free: (800) 645-9440
 Internet: <http://www.napcosecurity.com>

EASY MENU PROGRAMMING WORKSHEET - 1 OF 3

Name:	Address:
Account Number:	Installer:

Area 1: # of Zones (8-24) =

Area 1: # of Keypads (1-4) =

Area 2: # of Zones (0-24) =

Area 2: # of Keypads (0-4) =

NOTE: Easy Menu Programming allows programming of zones 8-24 and keypads 1-4 only. Zones 1-32 and keypads 1-7 are programmed in Direct Address Program Mode. See Zone and Keypad Options.

Report all Zones to Central?: Yes No

Central Station Receiver 1 Telephone Number:

Central Station Receiver 1 Account Number:

Central Station Receiver 1 Format:

- | | |
|---|--|
| <input type="checkbox"/> blank (*) = Ademco Slow, Silent Knight Slow
<input type="checkbox"/> 1 = Sescoa, Vertex, DCI, Franklin Fast
<input type="checkbox"/> 2 = Radionics Fast
<input type="checkbox"/> 3 = Silent Knight Fast
<input type="checkbox"/> 4 = Radionics, DCI, Franklin Slow
<input type="checkbox"/> 5 = Universal High Speed
<input type="checkbox"/> 8 = Radionics BFSK | <input type="checkbox"/> 9 = FBI 4/3/1
<input type="checkbox"/> 0 = Radionics Modem 2
<input type="checkbox"/> B = SIA
<input type="checkbox"/> C = Silent Knight Fast
<input type="checkbox"/> D = Radionics, DCI, Franklin Slow
<input type="checkbox"/> E = Universal High Speed |
|---|--|

User Codes:

AREA 1										
USER #	CODE (up to 6 digits)						USER OPTIONS		ACCESS OPTIONS	
1										
2										
3										
4										
5										
6										
7										
8										

AREA 2										
USER #	CODE (up to 6 digits)						USER OPTIONS		ACCESS OPTIONS	
9										
10										
11										
12										
13										
14										
15										
16										

NOTE: Easy Menu Programming allows programming of users 1-8 for area 1 and users 9-16 for area 2 only. All users (1-32) are programmed in Direct Address Mode. See User Code Options

Easy Menu Programming Worksheets - 1 of 3

EASY MENU PROGRAMMING WORKSHEET - 2 OF 3

Zone Descriptions (GEM-RP1CAe2 Keypads Only):

ZN #	CHARACTERS AVAILABLE																												
	1	2	3	4	5	6	7	8	9	10	11	12	13	14	15	16	17	18	19	20	21	22	23	24	25	26	27	28	29
1																													
2																													
3																													
4																													
5																													
6																													
7																													
8																													
9																													
10																													
11																													
12																													
13																													
14																													
15																													
16																													
17																													
18																													
19																													
20																													
21																													
22																													
23																													
24																													
25																													
26																													
27																													
28																													
29																													
30																													
31																													
32																													

Characters Available for Zone Descriptions
 ! @ # \$ % ^ & * () _ + ! ! ! { } [] ` , . < > ?
 1 2 3 4 5 6 7 8 9 0
 a b c d e f g h i j k l m n o p q r s t u v w x y z
 A B C D E F G H I J K L M N O P Q R S T U V W X Y Z

EASY MENU PROGRAMMING WORKSHEET - 3 OF 3

RF Transmitter Points:

XMTR #	ZONE #	RF ID (printed on xmtr box)						CHECK SUM	POINT #
1									
2									
3									
4									
5									
6									
7									
8									
9									
10									
11									
12									
13									
14									
15									
16									

XMTR #	ZONE #	RF ID (printed on xmtr box)						CHECK SUM	POINT #
17									
18									
19									
20									
21									
22									
23									
24									
25									
26									
27									
28									
29									
30									
31									
32									

Key Fob Transmitters:

KEY FOB #	RF ID (printed on xmtr box)						CHECK SUM	AUX 1	AUX 2
1									
2									
3									
4									
5									
6									
7									
8									



KEYPAD PROGRAMMING MODES

Note:

- ☞ 1. Functions that are not active, not programmed and/or not applicable to user's authority level will be suppressed and will not display.
- ☞ 2. Due to space constraints, GEM-RP2AS/RP2ASe/RP2ASe2 messages are abbreviated and functions identified by ^(D).
- ☞ 3. Many functions will not be displayed (such as: "DISPLAY ZN FAULTS"). It will require a faulted zone to display.

FUNCTION MODE

Keypad Programming Modes: Function Mode

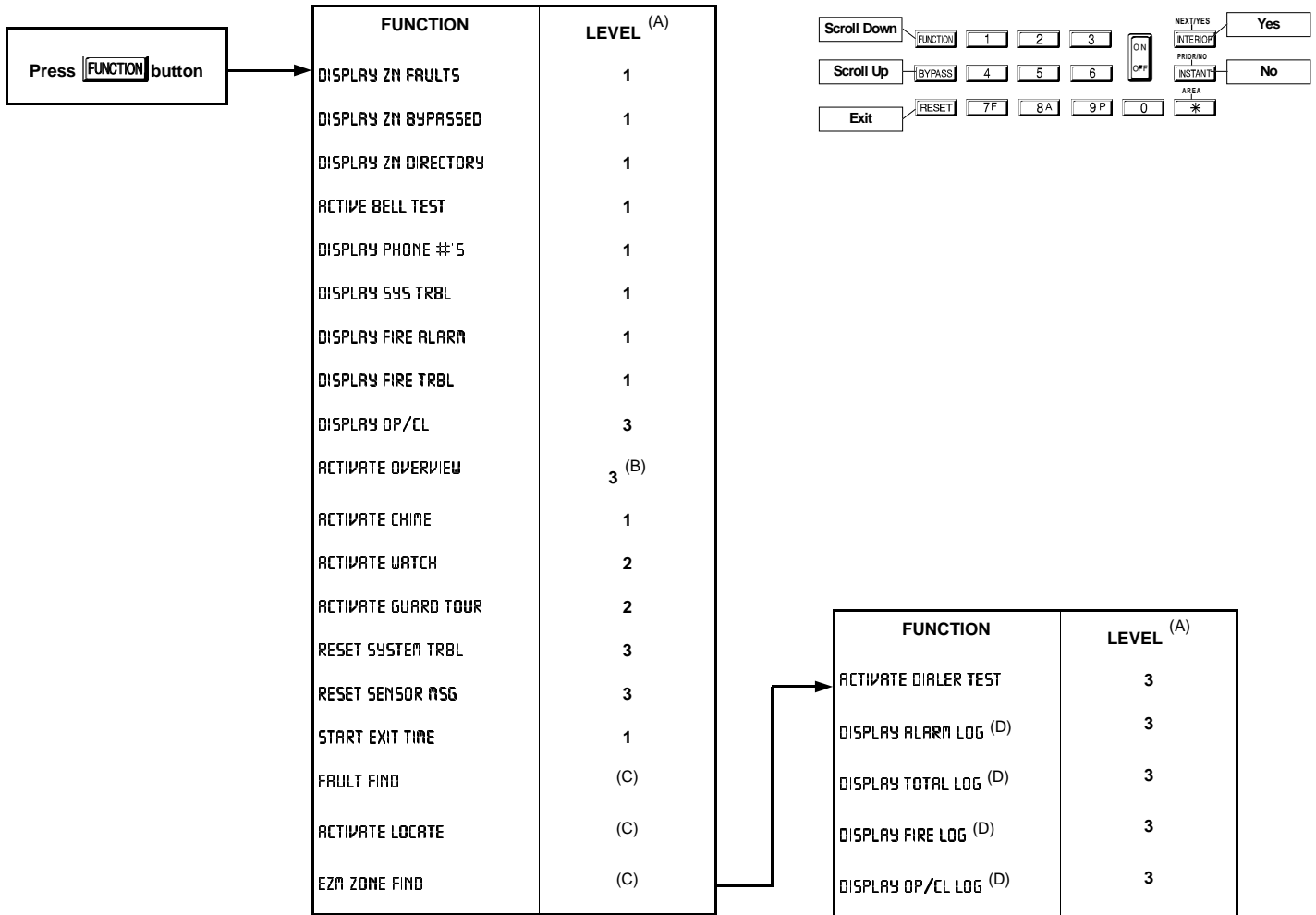

- (A) Minimum level required to access function
- (B) Level 3 code with appropriate option
- (C) Requires dealer code
- (D) Not available in GEM-RP2AS/RP2ASe/RP2ASe2 keypads
- (E) Initial Configuration only; suppressed thereafter

DEALER MODE

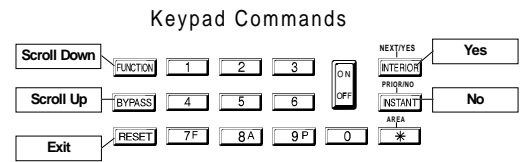
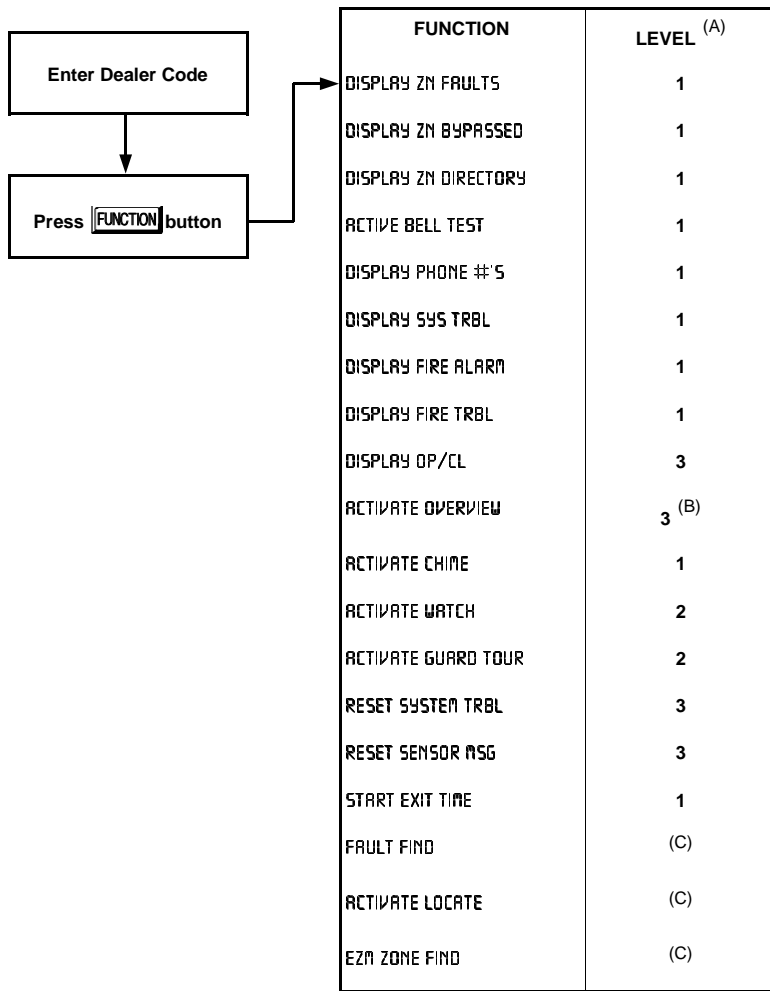

FUNCTION	LEVEL (A)
ACTIVATE DIALER TEST	3
DISPLAY ALARM LOG (D)	3
DISPLAY TOTAL LOG (D)	3
DISPLAY FIRE LOG (D)	3
DISPLAY OP/CL LOG (D)	3
DISPLAY SYSTEM LOG (D)	3
TO ARM IN 1-4HRS	2
DISPLAY AUTO ARM SCHO	3
ACTIVATE PROGRAM	3 (B)
ACTIVATE DOWNLOAD	3
DISPLAY RF XMITTER STAT	3
RELAY CONTROL	1

EASY MENU PROGRAM MODE

- (A) Minimum level required to access function
- (B) Level 3 code with appropriate option
- (C) Requires dealer code
- (D) Not available in GEM-RP2AS/RP2ASe/RP2ASe2 keypads
- (E) Initial Configuration only; suppressed thereafter

EASY MENU MODE

FUNCTION

R1 #ZN+00 #KP=0; R2 #ZN+00 #KP=0 (E)

REPORT ALL ZONES TO CENTRALP Y/N (E)

CENTRAL PHONE NO.

ACCOUNT # (_ _ _ _)

RCVR FORMAT

ENTER USER CODE

ENTER ZONE DESCRIPTIONS

RF XMITTER ID CODE # + POINTS

KEY FOB ID CODE # + OPTIONS

ENTER DATE (MM/DD/YY)

ENTER TIME (HH:MM/P)

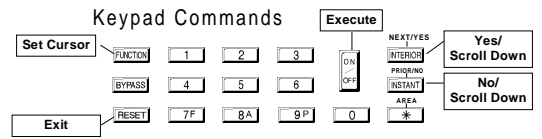
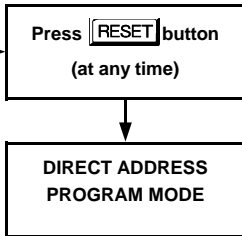

Keypad Programming Modes: Easy Menu Mode

- (A) Minimum level required to access function
- (B) Level 3 code with appropriate option
- (C) Requires dealer code
- (D) Not available in GEM-RP2AS/RP2ASe/RP2ASe2 keypads
- (E) Initial Configuration only; suppressed thereafter

USER MODE

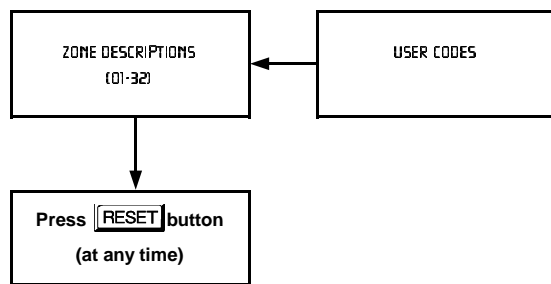
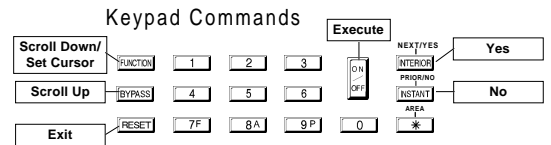
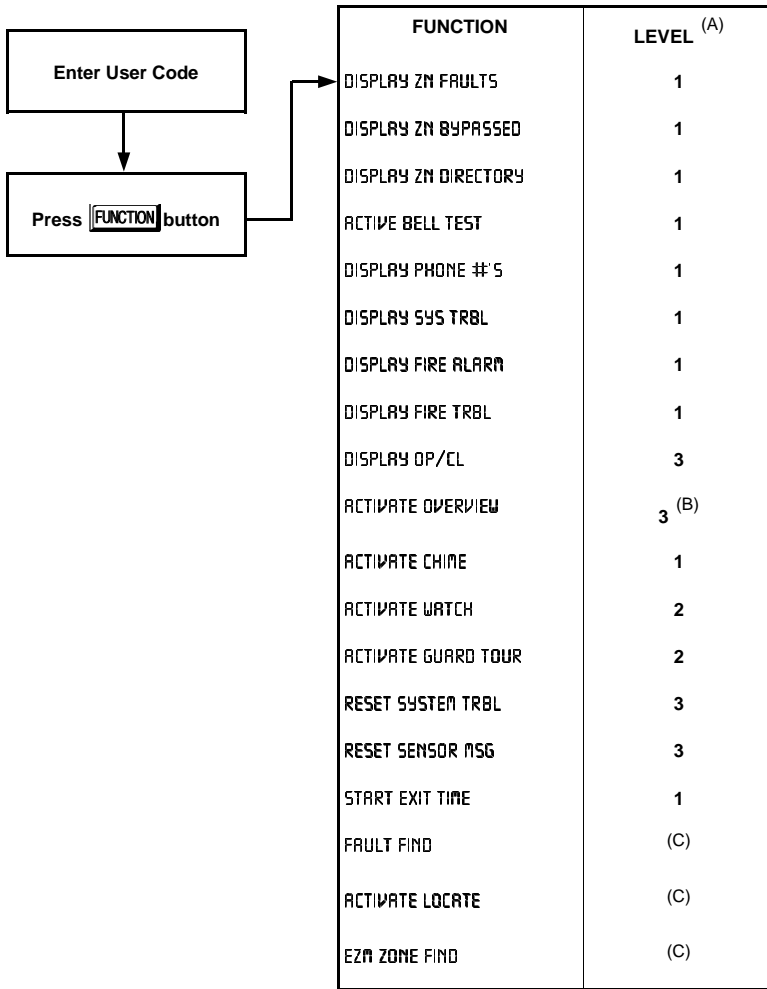

FUNCTION	LEVEL (A)
ACTIVATE DIALER TEST	3
DISPLAY ALARM LOG (D)	3
DISPLAY TOTAL LOG (D)	3
DISPLAY FIRE LOG (D)	3
DISPLAY OP/CL LOG (D)	3
DISPLAY SYSTEM LOG (D)	3
TO ARM IN 1-4HRS	2
DISPLAY AUTO ARM SCHO	3
ACTIVATE PROGRAM	3 (B)
ACTIVATE DOWNLOAD	3
DISPLAY RF XMITTER STAT	3
RELAY CONTROL	1

- (A) Minimum level required to access function
- (B) Level 3 code with appropriate option
- (C) Requires dealer code
- (D) Not available in GEM-RP2AS/RP2ASe/RP2ASe2 keypads
- (E) Initial Configuration only; suppressed thereafter



KEYPAD CONFIGURATION MODE

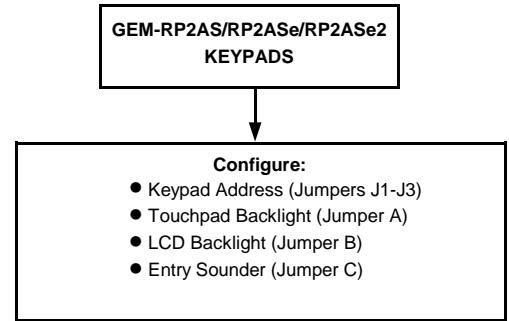
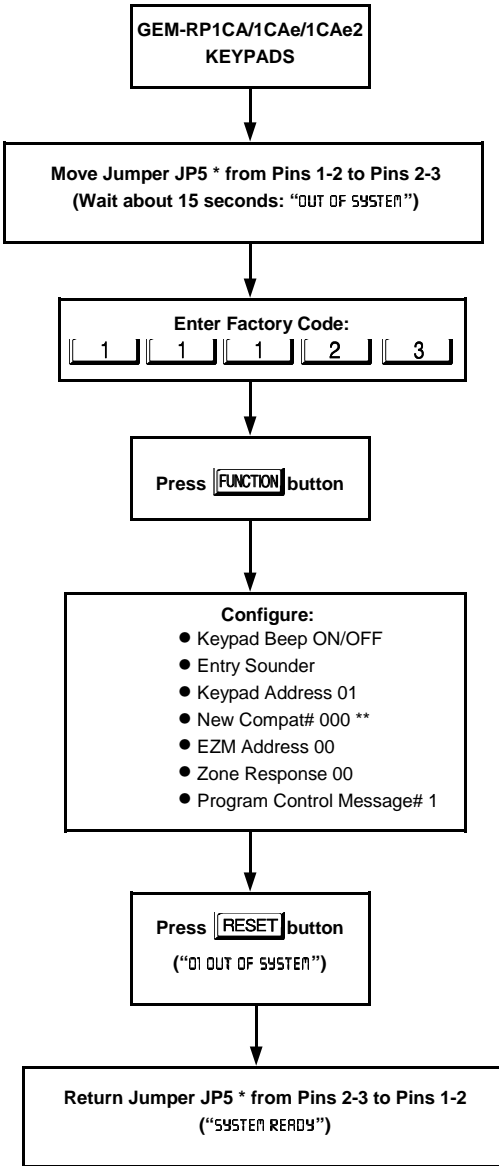

* JP5 is located at the top-right corner of the circuit board.

** If a Compatibility Number other than "0000" is programmed, "OLD COMPAT# XXXX" is displayed.

PROGRAMMING OPTIONS INDEX

PROGRAMMING OPTION	PROGRAM MODE	ADDRESS LOCATION	PAGE NUMBER
10ms Loop Response	Direct Address	1201	31
1400hz Handshake/Kissoff	Direct Address	0526,0551 & 0576	23
2300hz Handshake/Kissoff	Direct Address	0526,0551 & 0576	23
24-Hour Zone	Direct Address	1210, 1310, 1410 & 1510	31 & 32
2-Wire Smoke Detectors	Direct Address	1252	31
3/1 With Extended Restores	Direct Address	0526,0551 & 0576	23
50ms Loop Response	Direct Address	1200	31
Abort Delay per zone	Direct Address	1222, 1322, 1422 & 1522	31 & 32
Abort Delay Timeout	Direct Address	2406	21
AC Fail Report Delay	Direct Address	2408	21
Access Control (Panel) On Aux. Output	Direct Address	2418	33
Alarm On Day Zone	Direct Address	1226, 1326 1426 & 1526	31 & 32
Alarm Restore Report Code	Direct Address	0860	25
Alarm Restore 1 (Zone Option)	Direct Address	1228, 1328, 1428 & 1528	31 & 32
Alarm Restore 3 (Zone Option)	Direct Address	1236, 1336, 1436 & 1536	31 & 32
Alarm Supervisory	Direct Address	0871	26
Alarm Telco 1 (Zone Option)	Direct Address	1227, 1327, 1427 & 1527	31 & 32
Alarm Telco 3 (Zone Option)	Direct Address	1235, 1335, 1435 & 1535	31 & 32
Ambush Report Code	Direct Address	0900	26
Ambush (Keypad Option)	Direct Address	2440-2446	35
Ambush User Code	Direct Address	0495	22
Answering Machine P/U W/O Line Seizure	Direct Address	2417	33
Area Output Turns Off Upon Disarm	Direct Address	2700-2733	37
Area System Trouble Reporting Options	Direct Address	1120-1137	30
Auto Bell Test On Arming	Direct Address	2418	33
Auto Disarm Rearm Delay	Direct Address	4083	22
Auto Download Id No.	Direct Address	1023	24
Auto Reset (Zone Option)	Direct Address	1219, 1319, 1419 & 1519	31 & 32
Auto Reset After Burg. Output Timeout	Direct Address	2418	33
Auto-Bypass (Zone Option)	Direct Address	1204, 1304, 1404 & 1504	31 & 32
Auto-Bypass Re-Entry (Zone Option)	Direct Address	1207, 1307, 1407 & 1507	31 & 32
Automatic Interior Bypass	Direct Address	2421	34
Aux. Output Access Control Timeout	Direct Address	2402	21
Aux. Output Chirp On Keyfob Arming	Direct Address	2421	34
Aux. Output Timeout	Direct Address	2401	22
Auxiliary Report Code	Direct Address	0903	26
Auxiliary Relay (Zone Option)	Direct Address	1215, 1315, 1415 & 1515	31 & 32
Backup Report On Telco 2	Direct Address	1027	26
Burg. Alarm Output (Zone Option)	Direct Address	1211, 1311, 1411 & 1511	31 & 32
Burg. Alarm Output Timeout	Direct Address	2403	22
Bus Failure	Direct Address	0872	26
Bypass Faulted Zones	Direct Address	2417	33
Callback Telephone No. Select	Direct Address	1022	24
Callback Telephone Number 1	Direct Address	0600-0619	24
Callback Telephone Number 2	Direct Address	0625-0644	24
Cancel Next Test Timer On Any Report	Direct Address	1027	26
Central Station Receiver 1 Account Number	Easy Menu Driven	N/A	6
Central Station Receiver 1 Format	Easy Menu Driven	N/A	7
Central Station Receiver 1 Telephone Number	Easy Menu Driven	N/A	6
Chime (Zone Option)	Direct Address	1221, 1321, 1421 & 1521	31 & 32
Chime On E4 Lug	Direct Address	2420	34
Chime Timeout	Direct Address	2407	21
Clear Dealer Program	Direct Address	4091	41
Closing Report Code	Direct Address	0864	25
Closing Report Only On Cond. Closing (Auto-Byp.)	Direct Address	2417	33
Cold Start	Direct Address	4093	41
Conditional Closing	Direct Address	0865	25
CS Receiver 1 Format	Direct Address	0525	23
CS Receiver 1 Options	Direct Address	0526	23
CS Receiver 1 Telephone Number	Direct Address	0527-0546	24
CS Receiver 2 Format	Direct Address	0550	23
CS Receiver 2 Options	Direct Address	0551	23
CS Receiver 2 Telephone Number	Direct Address	0552-0571	24



PROGRAMMING OPTION	PROGRAM MODE	ADDRESS LOCATION	PAGE NUMBER
CS Receiver 3 Format	Direct Address	0575	23
CS Receiver 3 Options	Direct Address	0576	23
CS Receiver 3 Telephone Number	Direct Address	0577-0596	24
CS System Report Options	Direct Address	1027	26
CS Telco 1 Subscriber Event Id Number (Area 1)	Direct Address	0682-0685	25
CS Telco 1 Subscriber Event Id Number (Area 2)	Direct Address	0686-0689	25
CS Telco 1 Subscriber Event Id Number (System)	Direct Address	0714-0717	25
CS Telco 1 Subscriber Opening/Closing Id Number (Area 1)	Direct Address	0650-0653	25
CS Telco 1 Subscriber Opening/Closing Id Number (Area 2)	Direct Address	0654-0657	25
CS Telco 2 Subscriber Event Id Number (Area 1)	Direct Address	0752-0755	25
CS Telco 2 Subscriber Event Id Number (Area 2)	Direct Address	0756-0759	25
CS Telco 2 Subscriber Event Id Number (System)	Direct Address	0784-0787	25
CS Telco 2 Subscriber Opening/Closing Id Number (Area 1)	Direct Address	0720-0723	25
CS Telco 2 Subscriber Opening/Closing Id Number (Area 2)	Direct Address	0724-0727	25
CS Telco 3 Subscriber Event Id Number (Area 1)	Direct Address	0822-0825	25
CS Telco 3 Subscriber Event Id Number (Area 2)	Direct Address	0826-0829	25
CS Telco 3 Subscriber Event Id Number (System)	Direct Address	0854-0857	25
CS Telco 3 Subscriber Opening/Closing Id Number (Area 1)	Direct Address	0790-0793	25
CS Telco 3 Subscriber Opening/Closing Id Number (Area 2)	Direct Address	0794-0797	25
CS User Reporting Codes	Direct Address	1030-1081	28
Day Zone Open (Zone Option)	Direct Address	1224, 1324, 1424 & 1524	31 & 32
Day Zone Short (Zone Option)	Direct Address	1225, 1325, 1425 & 1525	31 & 32
Dealer Security Code	Direct Address	0500-0502	22
Digital Dialer Test	Direct Address	0890	26
Disable Answering-Machine Download	Direct Address	2419	33
Disable Auto Dial Tone Detection	Direct Address	4084	34
Disable Auto Status	Direct Address	2421	34
Disable Auto-Reset On Day Zone	Direct Address	2419	33
Disable Auto-Unbypass On Disarming	Direct Address	2417	33
Disable Callback Download	Direct Address	2419	33
Disable Closing Reports Per Area	Direct Address	1025	26
Disable Code Required For Easy Bypass	Direct Address	2420	34
Disable Code Required For Func. Mode Lvl. 1	Direct Address	2420	34
Disable Exit/Entry Urgency Tone	Direct Address	2422	34
Disable Fire Reset (Area 1)	Direct Address	2415	33
Disable Fire Reset (Area 2)	Direct Address	2415	33
Disable Function-Mode Download	Direct Address	2419	33
Disable Keypad Instant Button	Direct Address	2420	34
Disable System Trouble Audible at Keypads	Direct Address	2420	34
Disable Opening Reports Per Area	Direct Address	1024	26
Disable Wait For Handshake	Direct Address	1027	26
Disable Wait For Silence	Direct Address	1027	26
Don't Clear Aux. Relay With Arm/Disarm	Direct Address	2421	34
Download Security Code	Direct Address	0646-0647	24
Easy Arming	Direct Address	2440-2446	35
Easy Setup For RF Only Systems	Direct Address	4090	41
Enable Output Chirp on Keyfob Arm/Disarm	Direct Address	2421	34
Enable Burg. Output for Keyfob Chirp	Direct Address	2422	34
Enable Burg. Output Warning On Entry	Direct Address	2418	33
Enable Burg. Output on Telco Fail only when Armed	Direct Address	2422	34
Enable Day Zone Watch (Area 1)	Direct Address	2416	33
Enable Day Zone Watch (Area 2)	Direct Address	2416	33
Enable Exit-Delay Restart	Direct Address	2419	33
Enable Line-Fault Test	Direct Address	2420	34
Enable Manager's Mode	Direct Address	2418	33
Enable Reporting To PC Preset	Direct Address	2417	33
Enable Smoke Detector Dirty Trouble	Direct Address	2422	34
Enable User Code By Area	Direct Address	2500-2531	35
Enable Zone Number On Pulse Alarm	Direct Address	0526,0551 & 0576	23
Enter Date	Easy Menu Driven	N/A	10
Enter Time	Easy Menu Driven	N/A	10
Enter User Codes	Easy Menu Driven	N/A	7
Enter Zone Descriptions	Easy Menu Driven	N/A	8
Entry Delay 1	Direct Address	0001	21
Entry Delay 2	Direct Address	0002	21
Entry/Exit 1 (Zone Option)	Direct Address	1216, 1316, 1416 & 1516	31 & 32
Entry/Exit 2 (Zone Option)	Direct Address	1217, 1317, 1417 & 1517	31 & 32

PROGRAMMING OPTION	PROGRAM MODE	ADDRESS LOCATION	PAGE NUMBER
Exit Delay	Direct Address	0000	21
Exit/Entry Follower (Zone Option)	Direct Address	1218, 1318, 1418 & 1518	31 & 32
External Relay Control	Direct Address	3778-3801 & 2800-2895	38
EZM Group Options	Direct Address	2600-2627	36
EZM Pgm Armed Terminal Control	Direct Address	2622-2627	36
EZM Tamper	Direct Address	0876	26
Fail To Close	Direct Address	0868	25
Fail To Open	Direct Address	0869	25
Fire Reporting Code	Direct Address	0902	26
Fire (Zone Option)	Direct Address	1275, 1375, 1475 & 1575	31 & 32
Fire Alarm Verification (Zone Option)	Direct Address	1276, 1376, 1476 & 1576	31 & 32
Fire Output (Lug E9)	Direct Address	1213, 1313, 1413 & 1513	31 & 32
Fire Output Cadence	Direct Address	2422	34
Fire Output Timeout	Direct Address	2405	22
Global System Trouble Reporting Options	Direct Address	1082-1116	29
Handshake For Local Telemetry	Direct Address	1027	26
Include Sel./Grp. Bypass In Cond. Closing Status	Direct Address	2417	33
Interior 1 Normally Bypassed	Direct Address	2419	33
Interior Bypass (Zone Option)	Direct Address	1262, 1362, 1462 & 1562	31 & 32
Key Fob Transmitters	Easy Menu Driven	N/A	10
Keypad Area Assignment	Direct Address	2425-2431	35
Keypad Auxiliary	Direct Address	2440-2446	35
Keypad Fire	Direct Address	2440-2446	35
Keypad Options	Direct Address	2440-2446	35
Keypad Panic	Direct Address	2440-2446	35
Keypad Sounder On Alarm	Direct Address	1264, 1364, 1464 & 1564	31 & 32
Keyswitch Arming	Direct Address	1206, 1306, 1406 & 1506	31 & 32
Leading Digits For Pager Format (1st Digit)	Direct Address	0520	23
Leading Digits For Pager Format (2nd Digit)	Direct Address	0521	23
Local Or Central Station Reporting System	Easy Menu Driven	N/A	6
Memory Failure	Direct Address	0873	26
Never Arm (Zone Option)	Direct Address	1209, 1309, 1409 & 1509	31 & 32
No EOL Resistor (Zone Option)	Direct Address	1239, 1339, 1439 & 1539	31 & 32
No. Rings Before Pickup	Direct Address	4089	24
Number Of Relay Board Modules	Direct Address	3777	37
Number Of RF Receivers	Direct Address	3776	40
Number Of Zones & Keypads Per Area	Easy Menu Driven	N/A	6
Opening Report Code	Direct Address	0866	25
Opening After Alarm Reporting Code	Direct Address	0867	25
Opening Report Only After Alarm Report	Direct Address	2417	33
Panel AC Failure Report Code	Direct Address	0875	26
Panel Access	Direct Address	2440-2446	35
Panel Access Code	Direct Address	0490-0492	22
Panel Low Battery	Direct Address	0874	26
Panic Report Code	Direct Address	0901	26
Power-Up Delay (Zone Option)	Direct Address	1223, 1323, 1423 & 1523	31 & 32
Pre-Alarm Warning (Zone Option)	Direct Address	1208, 1308, 1408 & 1508	31 & 32
Priority (Zone Option)	Direct Address	1202, 1302, 1402 & 1502	31 & 32
Priority Arming/Area 1	Direct Address	2650	36
Priority Arming/Area 2	Direct Address	2651	36
Priority With Bypass (Zone Option)	Direct Address	1203, 1303, 1403 & 1503	31 & 32
Program Change	Direct Address	0894	26
Pulse Alarm Output Timeout	Direct Address	2404	22
Pulsed Alarm Output (Zone Option)	Direct Address	1212, 1312, 1412 % 1512	31 & 32
Rem. Acc. Only	Direct Address	2440-2446	35
Remote Access Logging	Direct Address	3184	37
Reset Day Zone With Arm/Disarm Only	Direct Address	2419	33
Reset Output Timeout	Direct Address	2400	22
Reset Relay (Zone Option)	Direct Address	1214, 1314, 1414 & 1514	31 & 32
Resound On Wireless Smoke Low Battery	Direct Address	2419	33
RF Receiver Tamper	Direct Address	0896	26
RF Receiver Trouble	Direct Address	0895	26
RF Supervisory Timers	Direct Address	3760-3775	40
RF Transmitter Points	Easy Menu Driven	N/A	9
RF Trouble Report Code	Direct Address	0897	26
Selective Bypass (Zone Option)	Direct Address	1205, 1305, 1405 & 1505	31 & 32
Sensor Watch Report Code	Direct Address	0877	26



PROGRAMMING OPTION	PROGRAM MODE	ADDRESS LOCATION	PAGE NUMBER
Sensor Watch (Zone Option)	Direct Address	1240, 1340, 1440 & 1540	31 & 32
Sensor Watch Delay	Direct Address	4088	21
Service Message Report Code	Direct Address	0893	26
Single Digit Only	Direct Address	0526,0551 & 0576	23
Start Exit Delay After Ringback	Direct Address	2418	33
Status Report (Auto-Byp. Zones On Clos.)	Direct Address	2417	33
Sum Check	Direct Address	0526,0551 & 0576	23
Supervised Alarm Output	Direct Address	2422	34
Suppress "Bypass" Reminder When Armed	Direct Address	2418	33
Swinger Shutdown (Zone Option)	Direct Address	1220, 1320, 1420 & 1520	31 & 32
Tamper Report Code	Direct Address	0904	26
Telco Answering Service Override	Direct Address	2421	34
Telco Fail Only When Armed	Direct Address	2420	34
Telco Line Failure	Direct Address	0880	26
Telephone Line Test Delay	Direct Address	2414	21
Test Timer Report Code	Direct Address	0870	26
Touchtone Dialing Only	Direct Address	1027	26
Touchtone Dialing W/Rotary Backup	Direct Address	1027	26
Transmit "402" Opening/Closing Code	Direct Address	1027	26
Trouble Report Code	Direct Address	0861	25
Trouble On Night Open	Direct Address	1243, 1343, 1443 & 1543	31 & 32
Trouble On Open (Zone Option)	Direct Address	1241, 1341, 1441 & 1541	31 & 32
Trouble On Short (Zone Option)	Direct Address	1242, 1342, 1442 & 1542	31 & 32
Trouble Restore	Direct Address	0862	25
Trouble Restore 1 (Zone Option)	Direct Address	1230, 1330, 1430 & 1530	31 & 32
Trouble Restore 3 (Zone Option)	Direct Address	1238, 1338, 1438 & 1538	31 & 32
Trouble Telco 1 (Zone Option)	Direct Address	1229, 1329, 1429 & 1529	31 & 32
Trouble Telco 3 (Zone Option)	Direct Address	1237, 1337, 1437 & 1537	31 & 32
Veri-Phone Zones Priority Over Alarms	Direct Address	2421	34
Veri-Phone Zones Trip Aux. Relay	Direct Address	2421	34
Veri-Phone Zones Trip Fire Output	Direct Address	2421	34
Wireless Smoke Low Battery Resound	Direct Address	2422	34
Zone Anding Group 1 (Zone Option)	Direct Address	1254, 1354, 1454 & 1554	31 & 32
Zone Anding Group 2 (Zone Option)	Direct Address	1255, 1355, 1455 & 1555	31 & 32
Zone Area 1 (Zone Option)	Direct Address	1244, 1344, 1444 & 1544	31 & 32
Zone Area 2 (Zone Option)	Direct Address	1245, 1345, 1445 & 1545	31 & 32
Zone Options - Zones 1 To 16	Direct Address	1200-1376	31
Zone Options - Zones 17 To 32	Direct Address	1402-1576	32
Zones Report Code (Control Panel)	Direct Address	0910-0917	27
Zones Report Code (Group 1)	Direct Address	0918-0922	27
Zones Report Code (Group 2)	Direct Address	0922-0925	27
Zones Report Code (Group 3)	Direct Address	0926-0929	27
Zones Report Code (Group 4)	Direct Address	0930-0933	27
Zones Report Code (Group 5)	Direct Address	0934-0937	27
Zones Report Code (Group 6)	Direct Address	0938—0941	27

NOTES



NOTES

NOTES



GEM-P3200 WIRING DIAGRAM

GEM-P3200 Wiring Diagram

GEMINI GEM-P3200 WIRING DIAGRAM

(REFER TO OPERATION AND INSTALLATION INSTRUCTIONS W1817)

NAPCO SECURITY SYSTEMS, INC
AMITYVILLE, N.Y. 11701

This equipment should be installed in accordance with Chapter 2 of the National Fire Alarm Code, ANSI/NFPA 72-1996 (National Fire Protection Association, Batterymarch Park, Quincy, MA 02269), and local codes. Information describing proper installation, operation, testing, maintenance, evacuation planning, and repair service is to be provided with this equipment. U. Listed Limited Energy Code is required.

JPS
NORMAL
KEYPAD CONFIGURE

THIS UNIT INCLUDES AN ALARM VERIFICATION FEATURE THAT WILL RESULT IN A DELAY OF THE SYSTEM ALARM SIGNAL FROM THE INDICATED CIRCUITS. THE TOTAL DELAY (CONTROL UNIT PLUS SMOKE DETECTORS) SHALL NOT EXCEED 60 SECONDS. NO OTHER SMOKE DETECTORS SHALL BE CONNECTED TO THESE CIRCUITS UNLESS APPROVED BY THE LOCAL AUTHORITY HAVING JURISDICTION. CIRCUIT CONTROL UNIT SMOKE DETECTORS ZONES MODEL DELAY-SEC.

THE DELAY (POWER UP) (STARTUP) TIME MARKED ON THE INSTALLATION WIRING DIAGRAM OF THE SMOKE DETECTOR OR ON THE INSTALLED SMOKE DETECTOR(S) IS TO BE USED.

PENDING UL GRADES FOR THE GEM-P3200

BURGLARY LOCAL = GRADE A
CENTRAL STATION = GRADE B OR C
HOUSEHOLD BURGLARY ALARM CONTROL UNIT = GRADE A
HOUSEHOLD FIRE WARNING SYSTEM CONTROL UNIT REFER TO W1888 FOR INSTALLATION REQUIREMENTS

LUG	DESCRIPTION
E14	FUSED +12V BATT POWER
E18	NOT USED
E7	ES-3002 NO. AC INPUT
E5	GROUND IN
E3	GROUND IN START
E10	BURGL LUG
E4	ARM LUG
E22	RESET RELAY COMMON

- 1.) END-OF-LINE RESISTORS, 2200 OHMS, RED, RED, 5%, 1/2W, (EOL2,2K) ALSO INSTALLED IF ZONE NOT USED IN PANEL OR EXM (INCLUDING FIRE AND PANIC). DO NOT INSTALL EOL RESISTOR ON FIRE ZONE IF USING FT2200 EOL RELAY.
- 2.) COMBINED STANDBY CURRENT= AUX POWER + REMOVE POWER + RESET RELAY + FIRE POWER. BELL CURRENT MAY BE INCREASED BY SUBTRACTING AN EQUAL AMOUNT FROM THE STANDBY CURRENT.
- 3.) SYSTEM MUST BE TESTED AT LEAST ONCE A WEEK IN THE AC/BATTERY MODE AND IN THE BATTERY ONLY MODE (CONTACT CENTRAL STATION PRIOR TO TESTING)
- 4.) AC MUST BE RESTORED AFTER TEST.
- 5.) CONTACTS 2A/24VDC RESISTIVE (CUT JUMPER FOR DRY CONTACT)
- 6.) FOR U.L. RESIDENTIAL FIRE, CUT 'PS' JUMPER AND INSTALL SHUNT ACROSS JP6 HEADER.
- 7.) FOR SUPERVISION PROGRAM 'SUPERVISED BELL OUTPUT'
- 8.) UNIT INTENDED TO BE MOUNTED ON THE WALL VERTICALLY
- 9.) REFER TO W1817 FOR COMPATIBLE TWO WIRE SMOKE DETECTORS. DO NOT MIX DIFFERENT MODELS.
- 10.) RECOMMENDED BATTERIES: YUASA NP4-12 AND NP7-12. BATTERIES MUST BE REPLACED EVERY FIVE YEARS.
- 11.) THIS PANEL SHALL BE CHECKED BY A QUALIFIED TECHNICIAN AT LEAST ONCE EVERY THREE YEARS.
- 12.) AUX. POWER AND FIRE POWER VOLTAGE RATING 12.5VDC TO 11.7VDC.
- 13.) THIS PANEL SUPPORTS ONLY ONE SMOKE DETECTOR IN ALARM FOR EACH ZONE.
- 14.) CUT TO DISABLE BELL SUPERVISION. DO NOT CUT IN U.L. INSTALLATIONS.

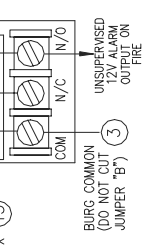
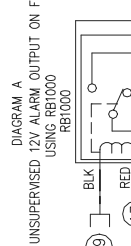
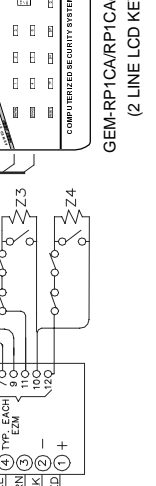
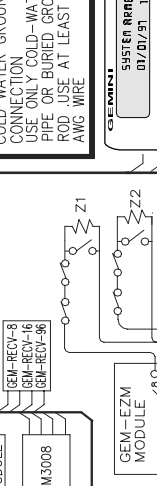
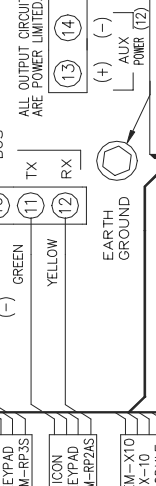
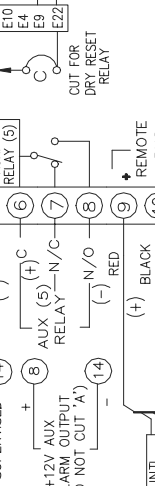
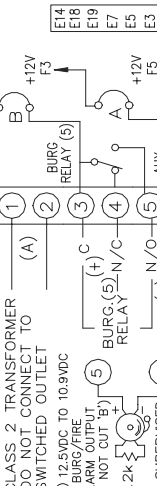
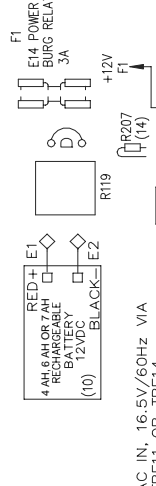
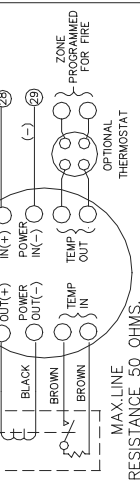
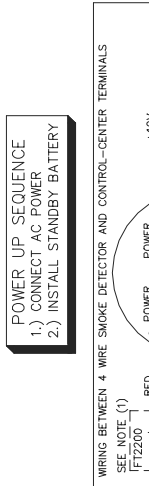

WARNING
TO PREVENT RISK OF ELECTRIC SHOCK DISCONNECT TELEPHONE LINES PRIOR TO SERVICING

RESIDENTIAL AND COMMERCIAL BURGLARY/ALARM CURRENT CHART	
BATTERY STANDBY CURRENT	PANEL STANDBY CURRENT
4AH 650mA	2.0A
7AH 650mA	2.0A
RESIDENTIAL FIRE AND COMBINATION RESIDENTIAL BURGLARY AND FIRE STANDBY/ALARM CURRENT CHART	
BATTERY STANDBY CURRENT	PANEL STANDBY CURRENT
7AH 150mA (3)	650mA (3)
	24 HOURS

LA1499C