

SECUTEST BASE(10) / PRO and SECULIFE ST BASE(25)

Test Instrument for Measuring the Electrical Safety of Devices
per VDE 0701-0702, IEC 62353 und IEC 60974-4

3-349-752-03
17/8.19



Controls

Display of symbols for devices connected to the USB master interface (see below)

- For keyboard *
- For Barcode/RFID scanner *
- For printer
- For USB flash drive

Bluetooth®** (feature M01)
Parameters: see page 86

LCD panel

Fixed Function Keys

- PRINT:** print via USB
 - ESC:** back
 - HELP:** help images
 - MEM:** database functions
 - START:** start/stop
 - Single measurement
 - Test sequence
- Finger Contact**

Display of special symbols:

- Measurement at IT system active
- Offset for RPE active

Mains to test socket

Mains to test socket N interrupted

White identified and fused high current path

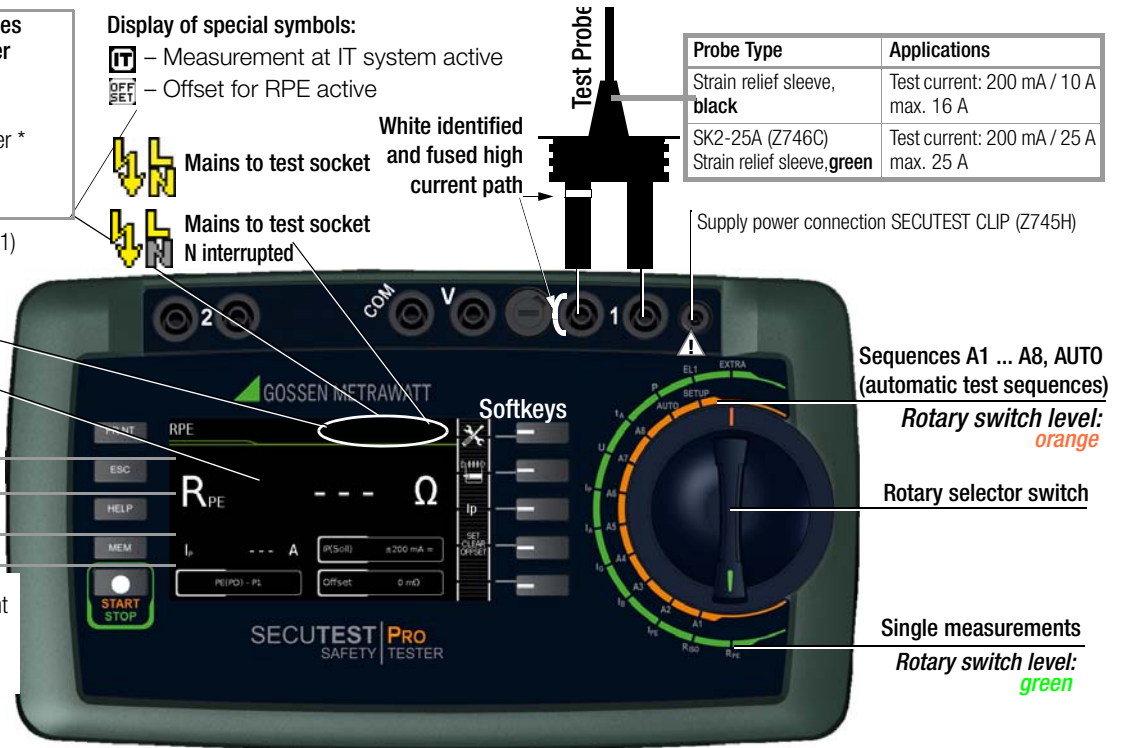

Probe Type	Applications
Strain relief sleeve, black	Test current: 200 mA / 10 A max. 16 A
SK2-25A (Z746C)	Test current: 200 mA / 25 A max. 25 A
Strain relief sleeve, green	

- * The receiver must be plugged in here for wireless entry devices.
- ** Only displayed in case of active connection to another Bluetooth device

Connections



No.	Meaning
1	2 nd test probe P2 for 2-pole measurement (only with SECUTEST PRO or instrument with feature H01)
2	Voltage measuring inputs (only with SECUTEST PRO or instrument with feature I01)
3	Fuse link for probe input P1
4	Test probe connection (P1)
5	Connection (jack socket) for supplying power to the SECUTEST CLIP (Z745H), see also operating instructions for leakage current clamp meter
6	Country-specific standard socket (test socket) for connecting devices under test
7	Carrying handle and tilt stand
8	Country-specific socket for mains power via inlet plug
9	Fuse link 1 for the mains connection
10	Fuse link 2 for the mains connection
11	Additional fuse link for 10 A ¹ protective conductor test
12	USB master for connecting keyboard, barcode/RFID scanner ² , printer ² and USB flash drive ² (must be FAT32 formatted – not NTFS)
13	USB slave for connection to a PC

¹ SECUTEST BASE10/PRO (feature G01)
² A list of suitable devices is included in the appendix (see section 14)

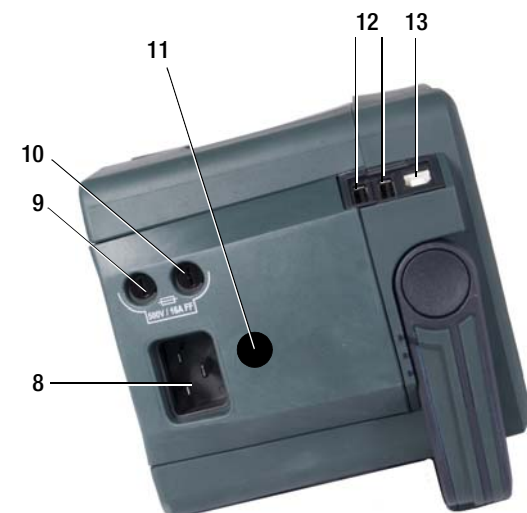

These operating instructions describe an instrument with software version FW3.0.0.

Overview of the Scope of Functions of the SECUTEST BASE(10), PRO and SECULIFE ST BASE(25) Test Instruments

Switch Position	Measuring Functions Test Current/Voltage	Measurement Type, Connection Type
Single measurements, rotary switch level: green		
Section 8.5	R_{PE} Protective conductor resistance	PE(TS) - P1 passive PE(TS) - P1 active PE(mains) - P1 ⁶ PE(mains) - P1 clamp ^{2,6} P1-P2 ³
	I_P Test current (200 mA) SECUTEST BASE10/PRO and SECULIFE ST BASE 10 A¹ (feature G01) and SECULIFE ST BASE25 25 A¹ (feature G02)	
Section 8.6	R_{INS} Insulation resistance (PC I/PC II)	LN(TS) - PE(TS) LN(TS) - P1 P1-P2 ³ PE(mains) - P1 PE(TS) - P1 LN(TS) - P1//PE(TS)
	U_{INS} Test voltage	
Section 8.7.1	I_{PE≈} Protective conductor current, RMS	Direct
	I_{PE-} AC component	Differential
	I_{PE=} DC component	Alternative
	U_{LPE} Test voltage	AT3-Adapter ² Clamp ²
	U_{Gen} A reference voltage (alternative)	
Section 8.7.2	I_{T≈} Touch current, RMS	Direct
	I_{T-} AC component	Differential
	I_{T=} DC component	Alternative (P1)
	U_{LPE} Test voltage	Permanent connection
	U_{Gen} Reference voltage (alternative)	Alternative (P1-P2)
Section 8.7.3	I_{E≈} Device leakage current, RMS	Direct
	I_{E-} AC component	Differential
	I_{E=} DC component	Alternative
	U_{LPE} Test voltage	AT3-Adapter ² Clamp ²
	U_{Gen} Reference voltage (alternative)	
Section 8.7.4	I_{A≈} Leakage current from the applied part, RMS	Direct (P1) Alternative (P1) Perm. con. (P1)
	U_{LPE} Test voltage	
	U_{Gen} Reference voltage (alternative)	
Section 8.7.5	I_{P≈} Patient leakage current, RMS	
	I_{P-} AC component	Direct (P1)
	I_{P=} DC component	Perm. con. (P1)
	U_{LPE} Test voltage	
Section 8.9	U_≈ Probe voltage, RMS	P1-P2
	U₋ Alternating voltage component	P1-P2 (with mains *)
	U₌ Direct voltage component	* Polarity parameter
	U_≈ Measuring voltage, RMS²	
	U₋ Alternating voltage component ²	V - COM
Section 8.10	U₌ Direct voltage component ²	V - COM (with mains)
	ta⁴ PRCd time to trip for 10/30 mA PRCdS	
Section 8.11	U_{LN} Line voltage at the test socket	
	P Function test at the test socket	
	I Current between L and N	Polarity parameter
	U Voltage between L and N	
	f Frequency	
	P Active power	
	S Apparent power	
PF Power factor		
PF Power factor		
Probe measuring functions		
Section 8.12	EL1 Extension cord with adapter: continuity, short-circuit, polarity (wire reversal ⁵)	EL1 adapter AT3-IIIIE adapter VL2E adapter
Section 9	EXTRA Reserved for expansion within the framework of software updates	
	°C Temperature measurement ² with Pt100 / Pt1000	V - COM
	I_Z Current clamp measurement ² with the current clamp sensor	V - COM

¹ 10/25 A-R_{PE} measurements are only possible with line voltages of 115/230 V and line frequencies of 50/60 Hz.
² Voltage measuring inputs with **SECUTEST PRO** or instrument with feature I01) and **SECULIFE ST BASE(25)** only
³ Connection of 2nd test probe for two-pole measurement with **SECUTEST PRO** (or instrument with feature H01) and **SECULIFE ST BASE(25)** only
⁴ Measurement of time to trip is not possible in IT systems.
⁵ No checking for reversed polarity takes place when the EL1 adapter is used.
⁶ Type of connection not available with **SECULIFE ST BASE25** (feature G02)

Key

- Alternative = alternative measurement (equivalent leakage current measurement)
- Differential = differential current measurement
- Direct = direct measurement
- LN(TS) = short-circuited L and N conductors at test socket
- P1 = measurement with test probe P1
- P1-P2 = 2-pole measurement with test probes P1 and P2
- PE-P1 = measurement between PE and test probe P1
- PE(TS) = protective conductor at the test socket
- PE(mains) = protective conductor at the mains connection

Switch Position	Standard	Measurement Type, Connection Type
Automated test sequences, rotary switch level: orange		
Preconfigured (freely adjustable) test sequences – default settings		
A1	VDE 0701-0702	Passive measurement type, test socket
A2	VDE 0701-0702	Active measurement type, test socket
A3	VDE 0701-0702-EDV	Parameters configuration for EDP (active)
A4	IEC 62353 (VDE 0751)	Passive measurement type
A5	IEC 62353 (VDE 0751)	Active measurement type
A6	IEC 60974-4	Connection type: test socket
A7	IEC 60974-4	Connection type: AT16-DI/AT32-DI
A8	VDE 0701-0702	Extension cord measurement type (RPE, RINS), adapter: EL1/VL2E/AT3-IIIIE
AUTO	VDE 0701-0702	Active measurement type, test socket

Differences with Regard to Included Features

SECUTEST...	Features	BASE	PRO	PRO BT comfort	—
SECULIFE...		—	ST BASE	—	ST BASE25
Touchscreen / keyboard	E01		•	•	•
10 A RPE test current	G01		•	•	
25 A RPE test current	G02				•
2 nd test probe	H01		•	•	•
Voltage measuring input *	I01		•	•	•
SECUTEST DB+	KB01		•	•	•
SECUTEST DB COMFORT	KD01			•	•
Bluetooth®	M01			•	
Antimicrobial housing	—		ST BASE		•

* For voltage measurement, or for connecting a current clamp sensor for current measurement or an AT3 adapter, and for temperature measurement via RTD

Scope of Delivery

Standard Version (country-specific)

- 1 **SECUTEST BASE(10)/PRO** or **SECULIFE ST BASE(25)** test instrument
- 1 Mains power cable
- 1 Test probe, 2 m, not coiled
- 1 USB cable, USB A to USB B, 1.0 m long
- 1 Plug-on alligator clip
- 1 KS17-ONE cable set for voltage measuring input (only with **SECUTEST PRO** and **SECULIFE ST BASE(25)** or device with feature I01)
- 1 Calibration certificate
- 1 Condensed operating instructions
- 1 Comprehensive operating instructions available on the Internet
- 1 Card with registration key for software



Contents	Page		Page
1 Applications	5	8 Single Measurements	25
1.1 Table: Types of DUTs – Tests – Standards	5	8.1 General	25
1.2 Table: Single Measurements – Regulations	5	8.2 Meaning of Symbols in the User Interface	26
2 Safety Features and Precautions	5	8.3 Displaying the Last Measured Values	26
3 General Operation	7	8.4 Measurement Series and Storage	26
3.1 Measured Value Display	7	8.5 Measuring Protective Conductor Resistance – RPE	27
3.2 Language, Keyboard Layout (culture parameter)	7	8.6 Insulation Resistance Measurement – RINS	31
3.3 Help Functions (HELP key and QR code)	7	8.7 Measuring Leakage Current	35
3.4 Entering Alphanumeric Characters	7	8.7.1 Protective Conductor Current – IPE	36
3.5 Print-Outs – Reports	7	8.7.2 Touch Current – IB	40
3.5.1 Multi-Print	7	8.7.3 Device Leakage Current – IG	43
3.5.2 Report Template for Reading Out Reports to a Thermal Printer or an HTML File	7	8.7.4 Leakage Current from the Applied Part – IA	46
3.5.3 Report Tapes from Thermal Printers	8	8.7.5 Patient Leakage Current – IP	47
3.5.4 Printing via IZYTRONIQ	8	8.8 Probe Voltage – U	50
3.5.5 Saving Reports to a USB Flash Drive	8	8.9 Measuring Voltage – U (SECUTEST PRO or feature IO1 only)	51
3.6 Print-Out of ID Labels (as of firmware V1.3.0)	8	8.10 Measuring Time to Trip for RCDs of the Type PRCD – tA	52
3.7 Writing RFID Tags (as of firmware V1.5.0)	8	8.11 Function Test – P	53
4 Initial Startup	9	8.12 Testing Extension Cords for Correct Function – EL1	54
4.1 Connecting the Test Instrument to the Mains	9	9 Special Functions – EXTRA	56
4.1.1 Measurements in IT Systems (new parameter as of firmware 1.5.0)	9	10 Test Sequences	58
4.1.2 Automatic Recognition of Mains Connection Errors	10	10.1 General	58
4.2 Connecting Test Probe P1 or P2	10	10.2 User-Defined Test Sequences / Remote Control (only with feature KB01, “Z853R – SECUTEST DB+”)	59
4.3 Device Settings	11	10.2.1 General	59
5 Internal Database	15	10.2.2 Testing of Probe Connection P1 and Probe Fuse P1	59
5.1 Creating Test Structures, General	15	10.3 General Settings (Setup: auto measurements parameter)	59
5.2 Transmitting and Saving Test Structures and Measurement Data	15	10.4 Selecting and Configuring a Test Sequence	61
5.2.1 Export – Transmitting Test Structures and Measurement Data from the Test Instrument to the PC	15	10.5 Connecting the DUT	67
5.2.2 Import – Uploading Test Structures Created in the Report Generating Program to the Test Instrument (only with database extension or feature KB01, “Z853R – SECUTEST DB+”)	15	10.6 Selecting a Test Object	67
5.2.3 Backing Up and Restoring Test Structures and Measurement Data	15	10.7 Checking Connection and Starting the Test Sequence	67
5.2.4 Switching Between 2 Tree Structure Views (for SECUTEST PRO and SECULIFE ST BASE(25) or for devices with feature KB01, “Z853R – SECUTEST DB+”)	17	10.8 Executing and Evaluating Test Steps	67
5.3 Data Entry	18	10.9 Setting Limit Values Manually	68
5.3.1 Keyboard Entries via Softkeys or External Keyboard	18	10.10 Ending the Test Sequence	68
5.3.2 Data Entry via Touchscreen Keyboard (only with SECUTEST PRO or test instrument with feature E01)	18	10.11 Saving Test Results	69
5.4 Creating a Test Structure in the Test Instrument, Navigating within the Structure and Displaying Measured Values	19	11 Warnings, Error Messages and Notes	70
5.4.1 General Procedure for Creating Test Structures	20	11.1 List of error messages	71
5.4.2 Searching for Structure Elements	21	11.2 List of Possible DUT Connections Depending on Measurement Type	79
5.4.3 Display Measured Values from Saved Tests	21	12 Characteristic Values	80
5.4.4 Clearing the Database	21	13 Maintenance	83
6 Connecting the Device Under Test	22	13.1 Housing Maintenance	83
6.1 Residual Current Monitoring	22	13.2 Testing the Color Display and the Buzzer (self-test parameter)	83
6.2 Reference Voltage L-PE and Alternative Test Sequence	22	13.3 Software Update (system info parameter)	83
6.3 Manually Specifying the Connection Type for Single Measurements	22	13.4 Backup Battery for Real-Time Clock	83
6.4 Manually Selecting a Connection Type / Protection Category for Automatic Test Sequences	22	13.5 Fuse Replacement	83
6.5 Special Conditions	23	13.6 Recalibration	83
6.6 2nd Test Probe (only SECUTEST PRO or feature H01)	23	13.7 Technical Safety Inspections	83
6.7 Connection Prompts	23	13.8 Returns and Environmentally Sound Disposal	84
6.8 Connection Tests Conducted by the Test Instrument	23	14 Appendix	84
7 Notes on Saving Single Measurements and Test Sequences	24	14.1 List of Suitable Printers with USB Port	84
7.1 QuickEdit Function – QEDIT (feature KD01, “Z853S – SECUTEST DB COMFORT”)	24	14.2 List of Suitable Barcode Scanners and RFID Scanners with USB Port	85
		14.3 Use of USB Storage Devices	85
		14.4 Bluetooth Interface (SECUTEST PRO BT (comfort) or feature MO1)	86
		14.5 Remote Control Interface	86
		14.6 Entry Via an External USB Keyboard	87
		14.6.1 Additional Key Functions, DB Comfort Option (feature KD01, “Z853S – SECUTEST DB COMFORT”)	87
		14.7 Index	88

15	Repair and Replacement Parts Service Calibration Center and Rental Instrument Service	90
16	Product Support	90

1 Applications

1.1 Table: Types of DUTs – Tests – Standards

Test DUTs in accordance with the following standards	Testing after Repairs / Periodic Testing		
	EN 50678, draft DIN VDE 0701-0702	IEC 62353 DIN EN 62353 (VDE 0751-1)	IEC 60974-4 DIN EN 60974-4 VDE 0544-4
Electric devices	•		
Work devices	•		
Mains operated electronic devices	•		
Hand-held electric tools	•		
Extension cords	•		
Household appliances	•		
Data processing devices	•		
Medical electric devices, applied parts		•	
Welding units			•



Attention!

The test instrument may not be used for measurements within electrical systems! The test instrument must be operated within the same electrical system as the test object!



Note

Test sequences for VDE 0701-0702, ÖVE 8701 and SNR 462638 are identical. In the interest of improved readability, only VDE 0701-0702 is described below. The explanations apply to ÖVE 8701 and SNR 462638 as well. The instrument can be switched to the country-specific standard designation in SETUP (page 1/3) under “Auto Measurements”, “Measuring Sequence Parameters”.

1.2 Table: Single Measurements – Regulations

Single measurements per Regulation	EN 50678, draft DIN VDE 0701-0702	IEC 62353 DIN EN 62353 (VDE 0751-1)	IEC 60974-4 DIN EN 60974-4 VDE 0544-4
Protective conductor resistance	•	•	•
Insulation resistance	•	•	•
Protective conductor current	•		
Primary leakage current			•
Device leakage current		•	
Touch current	•	•	
Current from welding circuits			•
Patient leakage current		•	
Leakage current from the applied part		•	
Test methods			
Alternative measuring method (equivalent (device) leakage current)	•	•	
Differential current measuring method	•	•	•
Direct measuring method	•	•	•

Key

- Specified test

2 Safety Features and Precautions

SECUTEST BASE(10), SECUTEST PRO and SECULIFE ST BASE(25) test instruments fulfill all requirements of applicable EU directives and national regulations. We confirm this with the CE mark. The relevant declaration of conformity can be obtained from GMC-I Messtechnik GmbH.

The test instruments are manufactured and tested in accordance with the following safety regulations: IEC 61010-1 / DIN EN 61010-1 / VDE 0411-1, DIN EN 61557-16/VDE 0413-16

Safety of the operator, as well as that of the test instrument and the device under test, is only assured when it's used for its intended purpose.

Read the operating instructions carefully and completely before placing your test instrument into service. Follow all instructions contained therein. Make sure that the operating instructions are available to all users of the instrument.

Tests may only be performed by a qualified electrician, or under the supervision and direction of a qualified electrician. The user must be instructed by a qualified electrician concerning performance and evaluation of the test.

Suitable personal safety equipment is required.

If you use active or passive body assistance, please consult your physician or the manufacturer of the body assistance device.



Note

Manufacturers and importers of medical electric devices must provide documentation for the performance of maintenance by trained personnel.

Observe the following safety precautions:

- The instrument may only be connected to TN, TT or IT electrical systems with a maximum of 240 V which comply with applicable safety regulations (e.g. IEC 60346, VDE 0100) and are protected with a fuse or circuit breaker with a maximum rating of 16 A.
- Measurements within electrical systems are prohibited.
- Be prepared for the occurrence of unexpected voltages at devices under test (for example, capacitors can be dangerously charged).
- Make certain that the measurement cables are in flawless condition, e.g. no damage to insulation, no cracks in cables or plugs etc.
- When using a test probe with coil cord (SK2W): Grip the tip of the test probe firmly, for example if it has been inserted into a jack socket. Tensioning at the coil cord may otherwise cause the test probe to snap back resulting in possible injury.
- Measurement of insulation resistance and equivalent leakage current (alternative leakage current measuring method)**
Testing is conducted with up to 500 V. Current limiting is utilized ($I < 3.5 \text{ mA}$), but if terminals L or N at the test socket or the test probe are touched, electrical shock may occur which could result in consequential accidents.
- Leakage current measurement while connected to line voltage**
It's absolutely essential to assure that the device under test is operated with line voltage during performance of the leakage current measurement. Exposed conductive parts may conduct dangerous touch voltage during testing, and may not under any circumstances be touched. (Mains power is disconnected if leakage current exceeds approx. 10 mA.)



Attention!

The function test may only be performed after the DUT has successfully passed the safety test!

- **Probe Test**

Test the probe after completing each test (see also section 10.2.2).



Attention!

If the fuse at test probe P1 is defective after testing has been started, all subsequent measurements conducted using this measuring path will be incorrectly evaluated as good!

- **Fuse Replacement**

The fuses may only be replaced when the instrument is voltage-free, i.e. the instrument must be disconnected from mains supply power and may not be connected to a measuring circuit. The fuse type must comply with the specifications in the technical data or the labeling on the instrument.

Opening the Instrument / Repairs

The instrument may only be opened by authorized, trained personnel in order to ensure flawless operation and to assure that the guarantee is not rendered null and void.

Even original replacement parts may only be installed by authorized, trained personnel.

If it can be ascertained that the instrument has been opened by unauthorized personnel, no guarantee claims can be honored by the manufacturer with regard to personal safety, measuring accuracy, compliance with applicable safety measures or any consequential damages.

If the guarantee seal is damaged or removed, all guarantee claims are rendered null and void.



Attention!

Before opening the housing, pull the mains plug out of the outlet and wait for at least 5 minutes.

Switching Power Consumers – Procedure

Be absolutely sure to adhere to the sequence specified below when switching the live device under test. This prevents excessive wear of the mains relays at the test instrument.

Before measurement:

- 1 **Device under test:** Turn the DUT off via its own switch.
- 2 **Test instrument:** Switch line voltage to the test socket.
- 3 **Device under test:** Turn the DUT on via its own switch.

After measurement:

- 4 **Device under test:** Turn the DUT off via its own switch.
- 5 **Test instrument:** Deactivate line voltage to the test socket.

Switching Loads – Maximum Starting Current

Our **SECUTEST BASE(10)**, **PRO** and **SECULIFE ST BASE(25)** test instruments permit **active** testing of devices with a nominal current (load current) of up to 16 A.

The test socket on the respective test instrument is equipped with 16 A fuses to this end and the switching capacity of the internal relays is also 16 A. Starting current of up to 30 A is permissible.



Attention!

Despite extensive protective measures targeted at preventing overloading, the relay contacts may be welded together if **starting current exceeds 30 A**. The following error message appears in this case:
“**L(N) test socket fuse defective**”.

- ⇒ Check both of the mains connection's fuse links. If they're defective replace them with new ones.

If the error message described above still appears, it must be assumed that the relay is defective. If this is the case, the test instrument must be sent to our service department for repair (see section 15 for address).

Safer Testing with Test Adapter

In the case of test objects for which a starting current of greater than 30 A can be expected, we urgently recommend the use of a test adapter for larger starting currents:

for example test adapters from the AT3 series (AT3-IIIE, AT3-IIS, AT3-IIS32, AT16DI or AT32DI).

Alternative: Passive Test

If necessary on the basis of the hazard assessment, testing can be conducted as a passive test (equivalent leakage current method), i.e. without switching line voltage to the test socket.

The test instrument may not be used:

- If external damage is apparent, for example if parts which conduct dangerous touch voltage are freely accessible, if the display is broken or defective (in which case dangerous voltage or mains connection errors might no longer be indicated)
- If the seal or sealing lacquer has been removed as the result of repairs or manipulation carried out by an unauthorized/non-certified service provider
- With damaged connection and/or measurement cables and patient ports, e.g. interrupted insulation or kinked cable
- If the instrument no longer functions flawlessly
- After extraordinary stressing due to transport

In such cases, the instrument must be removed from operation and secured against unintentional use.

Meanings of Symbols on the Instrument

The symbols on the instrument have the following meanings:



Warning regarding dangerous electrical voltage



Warning concerning a point of danger (attention: observe documentation!)

CE conformity marking



This device may not be disposed of with household trash. Further information regarding the WEEE mark can be accessed on the Internet at www.gossenmetrawatt.com by entering the search term “WEEE”.



If the guarantee seal is damaged or removed, all guarantee claims are rendered null and void.

Utilized Trademarks

QR Code QR Code is a registered trademark of DENSO WAVE INCORPORATED



The **Bluetooth®** word mark and logo are registered trademarks of Bluetooth SIG, Inc

3 General Operation

3.1 Measured Value Display

The following items appear at the display panel:

- The selected measuring function or standard
- Measured values with abbreviations and units of measure
- Setting parameters such as type of connection and measurement type
- Symbols for softkey operation
- Wiring diagrams, notes regarding the test sequence and error messages

Green progress bars appear in the header for single measurements, and orange progress bars appear for test sequences.

If the upper range limit is exceeded, the upper limit value is displayed and is preceded by the ">" symbol (greater than), which indicates measurement value overrun. Falling short of the lower range limit is indicated by the "<" symbol (less than), for example with RINS.



Note

The depiction of LEDs in these operating instructions may vary from the LEDs on the actual instrument due to product improvements.

Measured Value Storage

See section 8.4

3.2 Language, Keyboard Layout (culture parameter)

The desired user interface language, a country-specific keyboard layout and a language for the test sequences (measuring sequence parameter) can be selected in the **SETUP** switch setting (see Section 4.3).



Note

If you change the keyboard layout setting, you'll be prompted to scan in certain barcodes. This is necessary in order to assure that the barcode reader still works correctly **after** changing the language. If the barcode reader isn't currently available, you can subsequently set it to the new keyboard layout via Setup (2/3) > External Devices > Barcode Reader > Type Z751A.

3.3 Help Functions (HELP key and QR code)

Depending on the **rotary selector switch** position and the selected measurement type, appropriate wiring diagrams are displayed.

- ⇒ Press the **HELP** key in order to query online help.
- ⇒ Press the **ESC** key in order to exit online help.

3.4 Entering Alphanumeric Characters

Entry via the Keyboard

In addition to the softkey keyboard which can be accessed at the display, USB keyboards (with USB boot keyboard profile) can also be used to enter texts such as offsets, ID numbers, type designations and comments (see also section 5.3).

Reading in Barcodes

- ⇒ Correct recognition of the barcode scanner by the test instrument after connection to the USB port is indicated by the  icon in the header.
- ⇒ Select the following parameter in order to configure the barcode scanner for initial start-up:
Setup (2/3) > External Device > Barcode Scanner > Type **Z751A**.
- ⇒ Scan the barcode which then appears.

When the menu for alphanumeric entry via the softkey keyboard is open at the display, any value read in by means of a barcode scanner is directly accepted.

See the appendix in section 14.2 concerning available accessory devices.



Note

We're unable to offer any guarantees regarding the use of scanning devices other than those listed in the appendix.

Reading In an RFID Code

- ⇒ Correct recognition of the RFID scanner by the test instrument after connection to the USB port is indicated by the  icon in the header.

When held at a distance of about 3 cm directly in front of the middle of the RFID tag, the tag's current content is read (e.g. the ID code) and the SCAN LED on the reader blinks.

If the database view (MEM) is active (before or after a measurement), the cursor automatically jumps to the DUT with the corresponding ID code.

If the object is not found, a prompt appears asking if you would like to create a new object.

3.5 Print-Outs – Reports

If you've connected a suitable printer (see list in appendix in section 14.1) or USB flash drive via the USB master port, you can read out a test report for each completed single measurement or test sequence by pressing the **PRINT** key.

The respective single measurement or test sequence must be previously selected in the memory menu with the help of the scroll keys.



Note

We're unable to offer any guarantees regarding the use of printers other than those listed in the appendix.

3.5.1 Multi-Print

If, in the memory menu, you move the cursor to a test object for which several tests have been conducted (individual measurements or test sequences) and press the **PRINT** key, a combined test report with all test results for the respective test object is read out.

3.5.2 Report Template for Reading Out Reports to a Thermal Printer or an HTML File

A report can be read out concerning the results of individual measurements or test sequences stored to the internal database. A report template is permanently stored to the test instrument for this purpose. The designation of the standard in the report may vary depending on which test sequence has been conducted.

The report template includes the following items:

- ID number
- Designation
- Customer name
- Location
- Date
- Time
- Comment with 64 characters
- Standard designation / sequence name / manual test
- Measured values
- Limit values
- Evaluations
- Test equipment (serial number)



Note

The display which appears is not a print preview and does not reflect the actual appearance of the printout.

3.5.3 Report Tapes from Thermal Printers

Report tapes can be printed out with the Z721S thermal printer (accessory: Z722S thermal paper).

As of firmware V2.1.1: The test report can now be edited and a company logo can be added to it directly in SETUP at the test instrument (see page 14). A company logo can be loaded from a USB flash drive for which the following image file formats are supported: BMP, JPG, PNG or GIF, resolution: max. 800 x 800 pixels. Color depth: max. 24-bit.

 **Note**
Report Designer PC software is no longer supported as a firmware version 2.1.1.

3.5.4 Printing via IZYTRONIQ

Alternatively, stored measurement data can be read into IZYTRONIQ report generating software at a PC and printed out as a report.

3.5.5 Saving Reports to a USB Flash Drive

Select a measurement from the database view (**MEM** key) with the scroll keys, for which a report will be saved to a USB flash drive. Then press the **PRINT** key. "Print job finished" appears. The report is written to an HTML file. The filename consists of the timestamp and the ID of the test object. Alternatively, reports can be save or printed out immediately after conducting a test, or when the test list view is open.

 **Note**
A list of suitable USB flash drives is included in the appendix (see section 14).

3.6 Print-Out of ID Labels (as of firmware V1.3.0)

A barcode printer permits for the following applications:

- Print-out of ID numbers encrypted as barcodes for devices under test – for quick and convenient acquisition during periodic testing
- Print-out of repeatedly occurring designations such as test object types encrypted as barcodes in a list, allowing them to be read in as required for comments

 **Note**
We're unable to offer any guarantees regarding the use of printers other than those listed in the appendix.

If you've connected a suitable barcode printer (see list in appendix in section 14.1) via the USB master port, you can print out a barcode for each test object by pressing the **PRINT** key.

- ⇨ By viewing the printer information, you can first of all determine whether or not the connected barcode printer is correctly recognized by the test instrument:
Setup (2/3) > Printer > Z721D > Printer Information
or
Setup (2/3) > Printer > Z721E > Printer Information
- ⇨ Select encryption in Setup (paper size is set automatically as of FW 2.0):
Setup (2/3) > Printer > Z721D > Printer Settings
or
Setup (2/3) > Printer > Z721E > Printer Settings
- ⇨ Switch to the database view (**MEM** key).
- ⇨ Select the desired test object with the scroll keys.
- ⇨ Press the **PRINT** key.
- ⇨ Depending on your selection, the ID is printed onto the label as a barcode. An error message appears if the ID cannot be read out as a barcode or a 2D code.



Note

Code Recognition

Please make sure that the printed codes are recognized by your scanner. Some code types have to be activated on your scanner prior to being used (this is frequently the case with Aztec/DataMatrix).



Note

Minimum Width of Labels

Tape cartridges with a minimum width of 12 mm are recommended for print-out of 2D code labels (QR code, MicroQR code, DataMatrix, Aztec).

If a blank label is discharged upon printing an ID number as a 2D code with a 9 mm ribbon cartridge, replace it with a 12 mm cartridge (or wider) and restart the printing process.

3.7 Writing RFID Tags (as of firmware V1.5.0)

The following function is made possible by an RFID scanner (programmer):

- Read-out of encrypted ID numbers for devices under test to an RFID tag for quick and convenient read-in during periodic testing

If you've connected a suitable RFID scanner (see list in appendix in section 14.1) via the USB master port, you can write an RFID tag for each test object by pressing the **PRINT** key:

- ⇨ Correct recognition of the RFID scanner by the test instrument after connection to the USB port is indicated by the  icon in the header.
- ⇨ Switch to the database view (**MEM** key).
- ⇨ Select the desired test object with the scroll keys or enter a new test object by means of its ID.
- ⇨ Briefly press the **PRINT** key on the test instrument.
- ⇨ You're prompted to hold the scanner at a distance of about 3 cm directly in front of the middle of the RFID tag.

The "Successful write" message appears to indicate that the procedure has been completed.



Note

An error message appears if the ID cannot be converted to an RFID tag.



Note

We're unable to offer any guarantees regarding the use of readers or writers other than those listed in the appendix.

4 Initial Startup

4.1 Connecting the Test Instrument to the Mains

- See section 12 for nominal mains values (nominal ranges of use).
- Connect the test instrument to the mains cable via its inlet plug and insert the mains plug into an electrical outlet. The function selector switch can be set to any position. If a mains outlet (earthing contact outlet) is not available, or if only a 3-phase outlet is available, the adapter socket can be used to connect the phase conductor, the neutral conductor and the protective conductor. The adapter socket has three permanently attached cables and is included with the KS13 cable set.



Attention!

If connection is not possible via an earthing contact outlet: Shut down mains power first. Then connect the cables from the coupling socket to the mains using pick-off clips in accordance with the diagram. Disconnection from mains power is only possible via the mains plug.

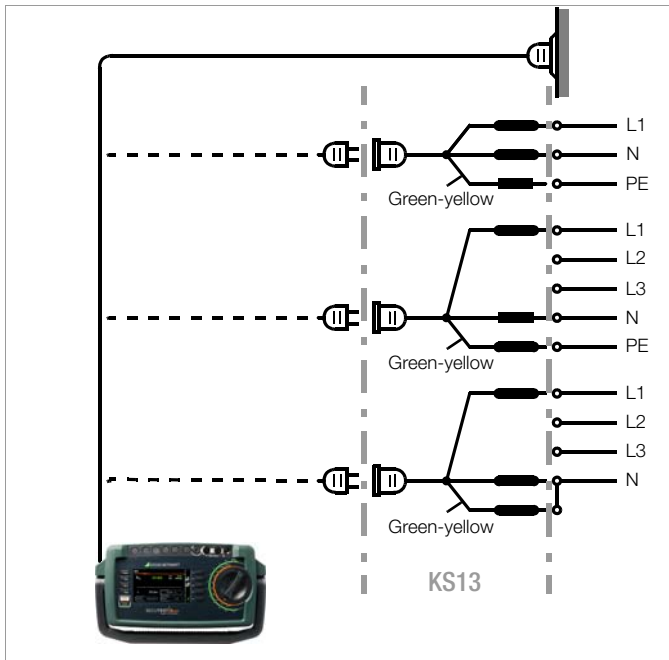
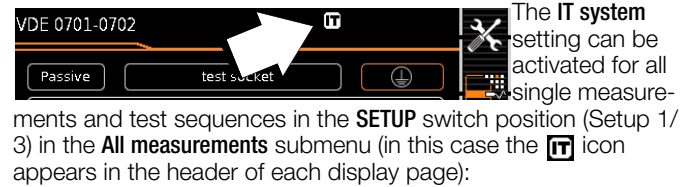

Figure 1 Connecting the Test Instrument to the Mains

4.1.1 Measurements in IT Systems (new parameter as of firmware 1.5.0)



with “Measurement at IT system” set to **Yes**: active leakage current measurements (or all measurements with reference to PE at the mains connection side) are disabled. Test sequences which include measurements of this sort are also disabled.

If, when being connected to line voltage, the SECUTEST detects a change at PE as compared with the previously used mains connection, the inspector is asked directly after initial start-up if the currently used outlet belongs to an IT system. The IT system option in SETUP is activated based on the user’s answer. If “Measurement at IT system” is activated, this is indicated by the **IT** icon in the header.

Regardless of this, it’s always possible to accordingly change the option manually in **SETUP**.

The setting for the “Measurement at IT system” option is retained even after disconnection from the mains.

In IT systems, active leakage current measurements (or any measurements with reference to PE at the mains connection side) do not deliver reliable measured values, for which reason all single measurements of this sort, as well as test sequences which include this type of measurement, are disabled when the “Measurement at IT mains” option has been activated in **SETUP**.

The **Meas. at IT mains** parameter can be set in Setup: Setup 1/3 > All Measurements > **Meas. at IT Mains**

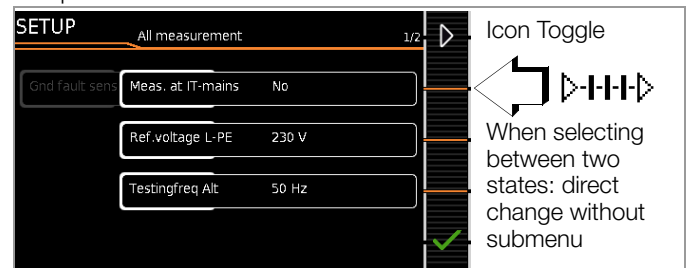

4.1.2 Automatic Recognition of Mains Connection Errors

The device automatically recognizes mains connection errors if the conditions in the following table have been fulfilled. The user is informed of the type of error, and all measuring functions are disabled in the event of danger.

Type of Mains Connection Error	Message	Condition	Measurements
Voltage at protective conductor PE to finger contact (START/STOP key)	Display at the instrument	Press START/STOP button $U > 25 \text{ V}$ Key \rightarrow PE; $< 1 \text{ M}\Omega^2$	All measurements disabled
Protective conductor PE and phase conductor L reversed and/or neutral conductor N interrupted		Voltage at PE $> 100 \text{ V}$	Not possible (no supply power)
Line voltage $< 180 \text{ V} / < 90 \text{ V}$ (depending on mains)		$U_{L-N} < 180 \text{ V}$ $U_{L-N} < 90 \text{ V}$	Possible under certain circumstances ¹
Test for IT/TN system	Display at the instrument	Connection N \rightarrow PE $> 20 \text{ k}\Omega$	Possible under certain circumstances

¹ 10/25 A- R_{PE} measurements are only possible with line voltages of 115/230 V and line frequencies of 50/60 Hz.

² If the user of the test instrument is too well insulated, the following error message may appear: "Interference voltage at mains connection PE"



Note

Finger Contact

During this test for correct mains connection, a voltage measurement is performed between the finger contact and PE at the test instrument's mains connection, and its reference potential is acquired via the user's body resistance to the conductive start key. In order to obtain reliable measurement results, this resistance value must be less than $1 \text{ M}\Omega$. If the user is wearing insulating shoes or gloves, or is standing on an insulating floor covering, erroneous measurements and display of the "Interference voltage at mains connection PE" message may result. Try to reduce resistance in this case, for example by touching ground potential with the other hand (e.g. a radiator, but not an insulating wall etc.).

4.2 Connecting Test Probe P1 or P2

Insert the double plug from test probe P1 or P2 into socket 1 or 2 respectively such that the plug with the white ring makes contact with the socket with the vertical bar.

The white ring identifies the terminal for the high current conductor which is safeguarded by the neighboring fuse link.



Note

Difficulty in contacting exposed conductive parts when using the standard probe with test tip

In order to assure good contact, surface coatings must be removed from devices under test with special tools at a suitable location.

The tip of test probe P1 is not suitable for scratching away paint, because this may impair its coating and/or mechanical strength. Brush probe Z745G may be more suitable than the test probe in certain individual cases.



Attention!

If, while testing protective conductor potential, you determine that **the mains protective conductor is carrying voltage** (in accordance with the first two mentioned cases), **no further measurements may be performed with the test instrument**. If this is the case, potentially dangerous voltage is also present at the accessible earthing contacts of the standard socket (test socket). Immediately disconnect the test instrument from the mains and arrange to have the fault eliminated at the mains connection.



Note

Voltage at the electrical system's protective conductor PE may result in distorted measurement values during testing for the absence of voltage, or during leakage voltage measurements.

4.3 Device Settings

SETUP



For the purpose of **initial start-up**, we recommend setting the following basic parameters in the order shown at the right:

- Setup 2/3 > Culture > **Language** (for user interface)
- Setup 2/3 > Culture > **Keyboard Layout** (for alphanumeric entries)
- Setup 1/3 > System > **Date / Time** (for report generation)
- Setup 1/3 > System > **Brightness** (display brightness as %)
- Setup 1/3 > Auto Measurements
> 2/2 > Initial Window Style: **Tree or Detail View**

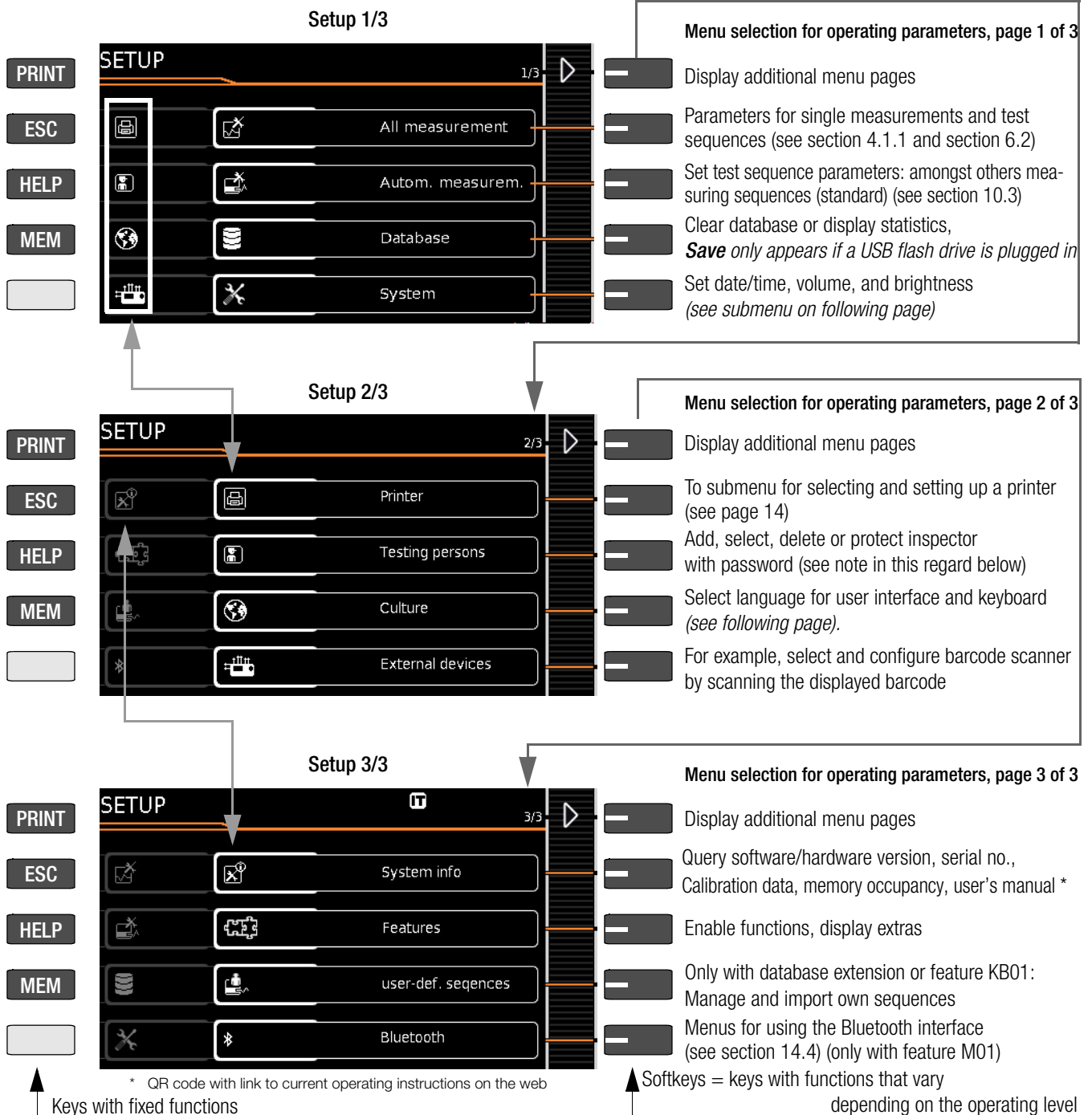

Figure 2 Device Settings, Main Menu Level – SETUP Switch Setting

The following parameters are advisable for **maintenance purposes**:
 SETUP 3/3 > Test > **Display / Buzzer** (for checking info and warning displays/signals)

SETUP 3/3 > System Info > **Software Version** for updates (see section 13.3) and **Calibration Data** for adjustment, last and next calibration (see notes on bottom of page 12).

See section 13.3 regarding downloading the latest software version.

Notes Concerning the Inspector Parameter

- The inspector who has just been “selected” appears in tests to be conducted as “Inspector”. None of the SECUTEST settings are stored specifically for the inspector – all settings in

the SECUTEST are stored for the respective device and are available to **all** inspectors.

- **If an inspector is password-protected**, this only prevents users who don't know the password from “selecting” this inspector. There's **no** password prompt when the test instrument is started up. The inspector remains selected even in the event of a power failure – a (password-protected) inspector can only be unselected by selecting another inspector.

As of firmware 1.6.0: In order to delete an inspector whose password you don't know, it's sufficient to enter an incorrect password five times in a row and to confirm the entry each time – a query then appears as to whether or not the inspector should be deleted. The inspector to be deleted may not be the same as the currently selected inspector.

Setup 2/3 > Culture

Manual selection for language and keyboard layout

- Page 2/2: **Information** on date format, decimal separator
- Select language for user interface
- Country-specific keyboard layout for USB or touchscreen keyboard
- Info: Date format, decimal separator *
- Jump back to next higher menu level

Setup 1/3 > System 1/2

Menu selection for date, volume and brightness

- To parameter for default values
- Date and time setting menu
See settings menu below
- Brightness setting menu for LCD
- Volume setting menu
Messages, user interface, measurements
- Reset to default values
Caution: The setup configurations are deleted! (also deletes list of inspectors, database content and company logo)

Setup 1/3 > System 2/2 > Default Settings

Default settings

- To parameters
- Self-test for display and buzzer
- With SECUTEST PRO only (feature E01):
Calibrate touchscreen keyboard

Setup 1/3 > System 1/2 > Date / Time

Set time and date menu

- Move cursor left
- Move cursor right
- Increase number
- Decrease number
- Accept changes and jump back

Figure 3 Device Settings, Submenu Level – SETUP Switch Setting

Notes on Calibration Data (adjustment, calibration)

SETUP 3/4 > System Info 2/6 > **Calibration Data:**
Whereas data for the last adjustment and calibration were set at the calibration center, date and time of the next calibration (recalibration date) can be changed by the user, if necessary, by select-

ing the **EDIT** button as shown in the example above for setting system time.

* As of firmware version 1.7.0, the "Measuring Sequences" parameter for the selection of country-specific standards (VDE, OVE and NEN) can be found in SETUP 1/3 under "Auto measurements 2/2".

Setup 1/3



Database 1/2

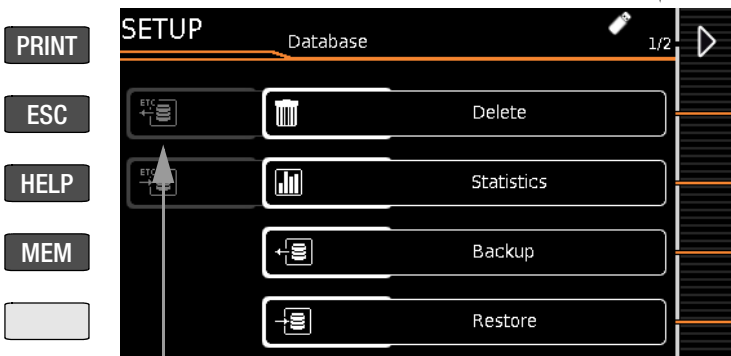

Menu selection for database functions, page 1 of 2

- Display additional menu pages
- Delete database content (but not its structure)
Note: Data are irretrievably deleted!
- Display database statistics
- Only with inserted USB drive:
Backup database to USB flash drive (FAT32 formatted)
- Only with inserted USB drive:
Restore database from USB flash drive

Database 2/2



Menu selection for database functions, page 2 of 2

- Display additional menu pages
- Only with database extension * and inserted USB drive:
Export database ("secu" file **)
- Only with database extension * and inserted USB drive:
Import a database from a ".secu" file which has been created specifically for the SECUTEST/ SECULIFE ST with **IZYTRONIQ**.
-
-

* Z853R or feature KB01
** Compatible with IZYTRONIQ

Keys with fixed functions

Softkeys = keys with functions that vary depending on the operating level



Note

Modification of the file format

Direct import of data in the old file format (".etc" file extension) is no longer possible as of firmware version 02.01.00.

Import the data into **IZYTRONIQ** report generating software first and then convert them to the new ".secu" file format. These data can then be imported to your test instrument with the help of a USB flash drive.

Backup files (.etcbak) from previous firmware versions are still compatible.

Printer Functions – Selection and Settings Using the Thermal Printer as an Example

Setup 2/3 > Printer

Select the connected printer

- Z721S printer: Printer info / printer settings
- Z721D * printer: Printer info / printer settings
* Phase-out model
- Z721E * printer: Barcode label printer
Printer info / printer settings
* For testing instrument firmware as of 1.8.3

Setup 2/3 > Printer > Z721S

Retrieval of information or settings

- Printer info: Name, status, type
- Printer settings: Parameters depend on printer type

Thermal Printer > Settings1/2

Setting parameters

- Switch to page 2/2
- Visual inspection details: show/hide
- Signature field: show/hide
- Location information: show/hide
- Delete a (company) logo previously loaded from a USB flash drive (see Settings 2/2).

Thermal Printer > Settings 2/2

Load and display a logo from a USB flash drive

- Switch to page 1/2
- Load a (company) logo from an inserted USB flash drive: Selection list is displayed
- Display the currently loaded logo.
- Prerequisites for loading a logo:
Format: BMP, JPG, PNG or GIF, resolution: max. 800 x 800 pixels. Color depth: max. 24-bit.

Note
Report Designer PC software is no longer supported as of firmware version 2.1.1. The test report can now be edited and a company logo can be added to it (only with thermal printer Z721S) directly in SETUP at the test instrument (see above).

5 Internal Database

5.1 Creating Test Structures, General

A complete test structure with data regarding customer properties, buildings, floors, rooms and test objects can be created in the test instrument. This structure makes it possible to save the results of single measurements or test sequences to test objects belonging to various customers. Manual single measurements can be grouped together into a so-called “manual sequence”.

Objects can be identified with the following parameters (**boldface** parameters are mandatory entry fields):

- **Device** (ID, designation, location, test interval *, type, manufacturer, comment, serial number, protection category, cost center *, department *)
- **ME device** ** (ID, designation, **customer**, test interval *, type, manufacturer, comment, serial number, protection category, number of type B application parts **, number of type BF application parts **, number of type CF ** application parts, cost center, department, UDI **, mains connection **)
- **Room** * (ID and **designation**)
- **Floor** * (ID and **designation**)
- **Building** * (ID, **designation**, street, ZIP code and city)
- **Property** * (ID and **designation**)
- **Customer** (ID, **designation**, street, ZIP code and city)

* Only with database extension, feature KB01, “Z853R – SECUTEST DB+”

** Only with feature KD01, “Z853S – SECUTEST DB COMFORT”

Key

ID = identification number

5.2 Transmitting and Saving Test Structures and Measurement Data

The following functions are possible (as far as the test instrument is concerned):

- **Export**: Transfer a structure including measured values from the test instrument to the PC (ETC *** or **IZYTRONIQ**) (see section 5.2.1).
- **Import** *: Transfer a test structure from the PC (ETC *** or **IZYTRONIQ**) to the test instrument (see section 5.2.2).
- **Backup** *: Back up a database to a USB flash drive plugged into the test instrument (must be FAT32 formatted – not NTFS) (see section 5.2.3).
- **Restore** *: Restore a database to the test instrument from a USB flash drive plugged into the test instrument (must be FAT32 formatted – not NTFS) (see section 5.2.3).
- **Reports**: Save reports to a USB flash drive (see section 3.5.5).

* Only with database extension, feature KB01, “Z853R – SECUTEST DB+”

*** Communication with ETC is no longer supported as of firmware version 2.0.0.

If no USB flash drive has been plugged in, the above listed functions are grayed out and disabled.

In order to transfer structures and data, the test instrument and the PC must be connected with a USB cable or a USB flash drive must be available.

Please observe the following safety precautions:



Attention!

During data transmission via the USB port (USB connection to the PC or connection of a USB flash drive), neither the interface cable nor the USB drive may be disconnected.



Attention!

The test instrument may not be disconnected from supply power during transmission via the USB port. The memory structure in the test instrument might otherwise be destroyed.



Note

Data transfer to the PC should not be started during single measurements or test sequences.

5.2.1 Export – Transmitting Test Structures and Measurement Data from the Test Instrument to the PC

Structures set up in, and measurement data saved to the test instrument can be exported to **IZYTRONIQ** report generating software via a connected USB flash drive (only with data base extension or feature KB01, “Z853R – SECUTEST DB+”), or via the USB slave port. Select **Export IZY file** under Setup > Database 2/2 to this end. The data are converted to an **IZYTRONIQ**-compatible format with the “.secu” file extension.

The report generating program is started at the PC by double clicking the exported file and the data are read in. Data can then be saved to the PC and reports can be generated.

5.2.2 Import – Uploading Test Structures Created in the Report Generating Program to the Test Instrument (only with database extension or feature KB01, “Z853R – SECUTEST DB+”)

As an alternative, a test structure can be created at the PC with the help of the respective report generating program and then transferred to the test instrument via a connected USB flash drive, or via the USB slave port. Select the **Import IZY file** function to this end under Setup > Database 2/2. The data are converted to a format which is compatible with the test instrument.

A complete description of database creation can be found in the online help included with the respective report generating program.

The same backup files apply here as is also the case in the section covering export.

5.2.3 Backing Up and Restoring Test Structures and Measurement Data

Structures created and measurement data saved at the test instrument can be backed up via an inserted USB flash drive (must be FAT32 formatted – not NTFS). Select the **Backup** function to this end under Setup > Database 2/2.

The test instrument creates a backup file on the USB flash drive directly in the root directory.

The backup files on the USB flash drive are named by means of a time stamp (file extension: .etcbak).

In order to restore structures and data from an inserted USB flash drive, select the **Restore** function under Setup > Database 2/2. When restoring, the files from the root directory are displayed as well as those from the backup folder (which used to be created in previous firmware versions). The files from the backup folder are displayed with the “>” prefix.



Note

Backup/Restore to/from USB Flash Drive

It's also possible to restore backup files created with previous firmware versions (as of firmware version 1.8.2).



Attention!

During data backup via the USB port (USB connection to the PC or inserted USB drive), neither the interface cable nor the USB drive may be disconnected. If the USB drive is removed during the backup it may be rendered defective.



Attention!

The test instrument may not be disconnected from supply power during data backup via the USB port.

Test Structure – Hierarchy of Object Levels in the SECUTEST BASE(10)

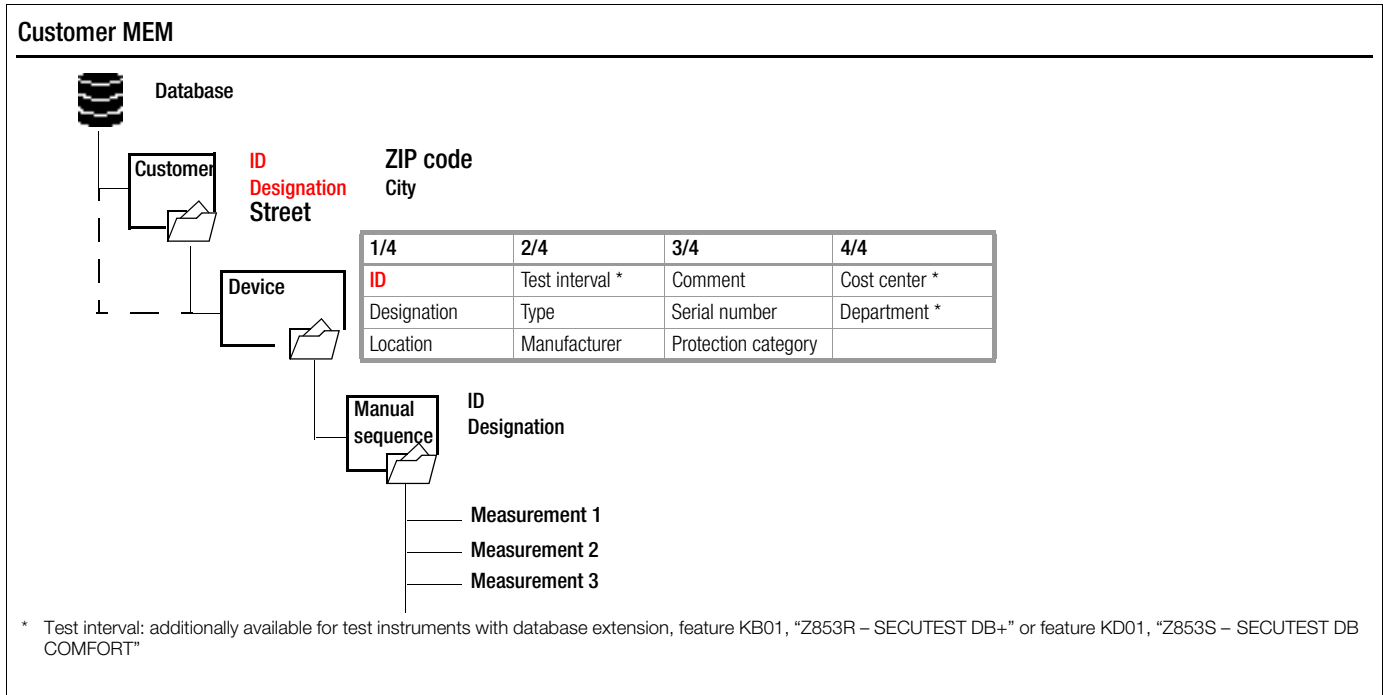

Figure 4 Database Structure

Test Structure – Hierarchy of Object Levels in the SECUTEST PRO and the SECULIFE ST BASE(25) or in Devices with Database Extension, Feature KB01, "Z853R – SECUTEST DB+"

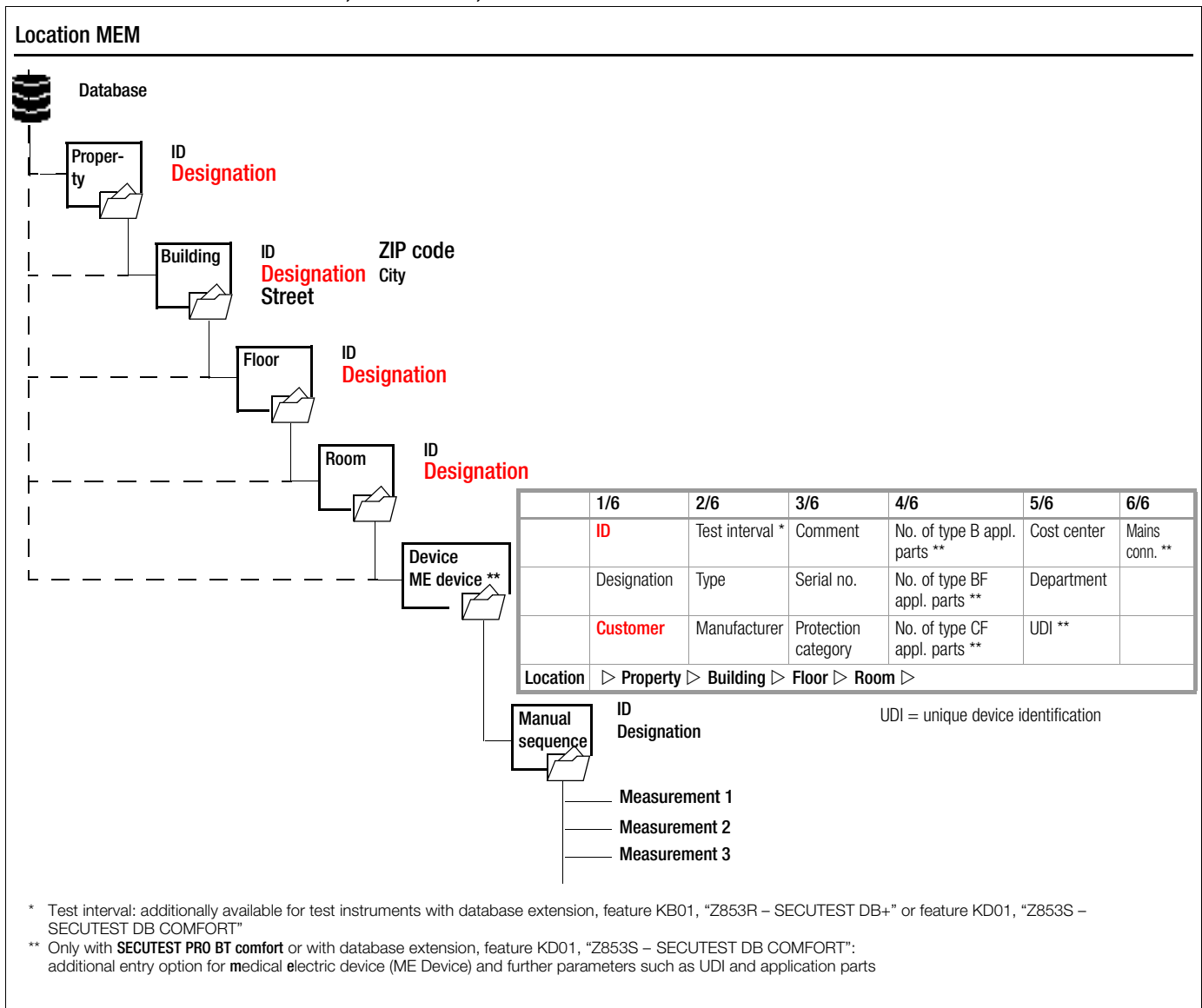

Figure 5 Database Structure as Location View in Test Instruments with Feature KB01, "Z853R – SECUTEST DB+"

Test Structure, Customer View – Hierarchy of Object Levels in the SECUTEST PRO and the SECULIFE ST BASE(25) or in Devices with Database Extension, Feature KB01, “Z853R – SECUTEST DB+”

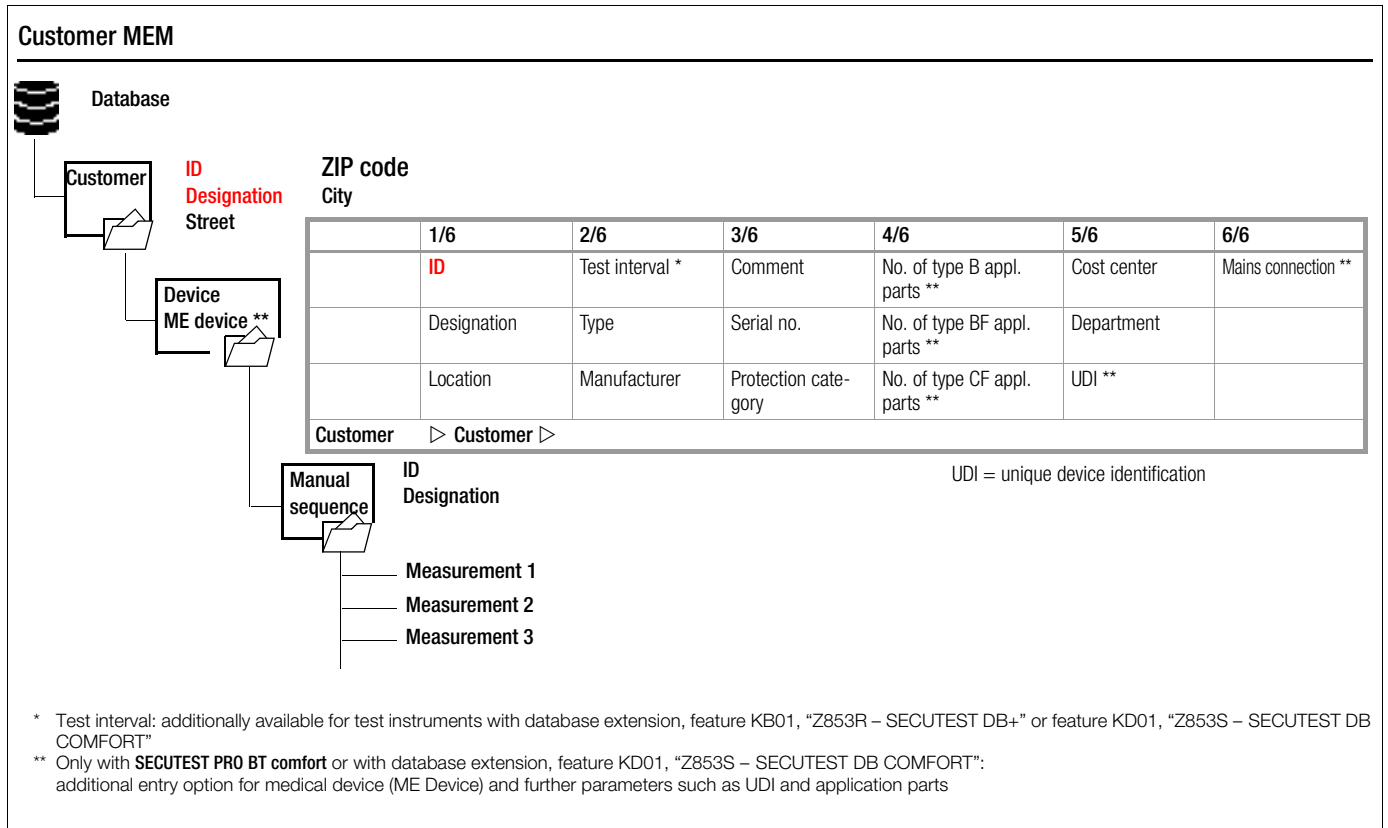

Figure 6 Database Structure as Customer View in Test Instruments with Feature KB01, “Z853R – SECUTEST DB+”



Note

Grayed Out Database Elements

The corresponding elements are grayed out in devices without enabling for the following options: “Extended database structure” Z835R (feature KB01 = property, building, floor, room) and SECUTEST DB comfort Z853S or feature KD01 (medical electric devices).



Note

Mandatory Fields

Mandatory fields are marked in red in the entry fields at the test instrument, as well as in Figure 5 and Figure 6.



Note

Hierarchies

It’s imperative to adhere to the following hierarchies:
Room or Floor must always be subordinate to a **Building**.
Devices or ME Devices (medical electric devices) always be allocated to a **Customer**.

5.2.4 Switching Between 2 Tree Structure Views (for SECUTEST PRO and SECULIFE ST BASE(25) or for devices with feature KB01, “Z853R – SECUTEST DB+”)

- ⇒ The display can be switched back and forth between the location and customer views by repeatedly pressing the **MEM** key.
- ⇒ The database view can be exited by pressing the **ESC** key.

Hierarchies and Data Migration

Database objects “Device” and “ME Device” must always be subordinate to a Customer. If so-called “legacy data” have been imported into the test instrument which do not comply with this rule (e.g. as a result of a firmware update or via the “Restore database” function), Customer objects are generated automatically. The same applies to database objects “Room” and “Floor”, which must always be subordinate to a Building. In this case, Building objects are generated automatically if necessary.

5.3 Data Entry

Overview of Keyboard Entries Via the Softkeys with the SECUTEST BASE(10)

Switch between keys and display panel	PRINT		Device	Description		Delete characters from right
Exit entry function without saving	ESC	Esc	Display panel		abc	Switch between upper/lowercase, and symbols
Scroll up	HELP					Scroll right
Scroll down	MEM					Scroll left
Transfer character at cursor position to display field			Keypad			Accept entry

Overview of Keyboard Entries via the Touchscreen Keyboard with the SECUTEST PRO (feature E01)

<ul style="list-style-type: none"> ➤ Briefly pressing the shift key once causes the next character to appear in uppercase. ➤ Pressing the shift key for a longer period of time causes all following characters to appear in uppercase. ➤ The cursor can be positioned as desired by pressing the display panel at the respective point in the existing text. 		<p>* Also via assigned softkey</p> <p>—Delete characters from right *</p> <p>—Accept entry *</p>
--	--	--

5.3.1 Keyboard Entries via Softkeys or External Keyboard

After selecting ID or any other object parameter, a keyboard is displayed which allows for the entry of alphanumeric characters via the fixed function keys and the softkeys. Alternatively, entries can also be made with the help of a USB keyboard or barcode scanner which is connected to the instrument.

The keyboard layout can be matched to the language in SETUP. SETUP 2/3 > Culture > **Keyboard Layout** (for alphanumeric entries)



Note

In order to use a USB keyboard at the SECUTEST..., the "Keyboard Layout Settings" in Setup must coincide with the connected keyboard.

Procedure (example: entering a designation):

- 1 Switch the keyboard to uppercase, lowercase or special characters with the abc key (Abc, ABC, Symb).
- 2 Select the desired alphanumeric character or a line break with the scroll keys (left, right, up and down). The selection cursor can be accelerated by pressing and holding the respective scroll key.
- 3 After pressing the key, the respective character appears at the display panel.
- 4 Repeat steps 1 through 3 until the complete designation is shown at the display panel.
- 5 The designation at the display panel can be changed subsequently by hiding the bottom keyboard by pressing the key. The cursor position can then be changed in order to delete individual characters.
- 6 The value appears at the display after pressing the green checkmark.

5.3.2 Data Entry via Touchscreen Keyboard (only with SECUTEST PRO or test instrument with feature E01)

The touchscreen keyboard permits convenient entry of data and comments, selection of parameters and direct parameter selection, and menu-driven operation is still possible via the softkeys as an alternative.

Meaning of Symbols in the User Interface – Database Management

Symbol	Meaning
Main Level	Sub-level
	Memory menu, page 1 of 3
	Change display to menu selection
	Cursor UP: scroll up
	Cursor DOWN: scroll down
	Cursor RIGHT: open tree
	Cursor LEFT: close tree
	Memory menu, page 2 of 3
	Change display to menu selection
	Add a structure element
	Delete selected structure element or measurement
	Edit structure elements (ID, designation, comment ...)
	Move structure element (feature KDO1, "Z853S – SECUTEST DB COMFORT")
	When a measurement is selected: Display measured values
	Display details from the measurement results list
	Hide details from the measurement results list
	Memory menu, page 3 of 3
	Change display to menu selection
	Search for ID, text or UDI > enter complete ID number (ID) or text (complete word)
	Search for ID number: > Enter complete ID number of a test object
	Confirm search results
	Display the structure designation
	Hide the structure designation

5.4 Creating a Test Structure in the Test Instrument, Navigating within the Structure and Displaying Measured Values

Overview of the Meanings of the Symbols for Creating Objects – Navigation within Test Structures

MEM 1/3

Object selection menu – page 1/3

- Scroll to next menu (page 2/3)
- Select customers or devices
- Select customers or devices
- Jump back (one hierarchical level higher) or close open branches
- Select customers or devices

MEM 1/3

Measurement selection menu – page 1/3

- Scroll to next menu (page 2/3)
- Selection of measurements
- Selection of measurements
- Jump back (one hierarchical level higher) or close open branches
- Display measured values for a selected test

1: Test sequence per standard (symbol: orange)
2: Single measurement (symbol: green)

MEM 2/3

Object editing menu – page 2/3

- Scroll to next menu (page 3/3)
- Add new (ME) device to the selected customer or clone current element (as of firmware 3.0)
- Either "Delete selected customer, (ME) device or measurement" or "Delete selected object with all subordinate objects/measurements"
- Edit device/customer
- Move object

MEM 3/3

Object search menu – page 3/3

- Scroll to next menu (page 1/3)
- Search by entering text
- Search by entering IDs
- Display designation and ID of the selected device

Note: See page 17 concerning grayed out database elements.

Figure 7 Overview of Navigation, Object Editing and Object Search in the Database

5.4.1 General Procedure for Creating Test Structures

After selection with the **MEM** key, all setting options for the creation of a tree structure are made available on three menu pages (1/3, 2/3 and 3/3). The tree structure consists of structure elements, referred to below as objects.

Results of measurements/tests can only be saved under structure elements types "Device" or "ME device" (medical electric device), which are also referred to as "test objects" in the following.

Select the position at which a new object will be added.

- Use the ▲ or ▼ key in order to select the desired structure elements.
- If a sublevel exists, you can switch to it by pressing the ► key, or you can open a branch.
- The open branch is then closed, or you can switch to the next higher hierarchical level, by pressing the ◀ key.

Creating a New Object

- Scroll to the second menu page (MEM 2/3) with the help of the ►► key.
- After pressing **NEW**, a new object can be created. Depending on the current position within the hierarchy, the respectively available object types are suggested. Depending on the object type, you'll have to enter at least an ID number via the keyboard. If any of the mandatory entries (identified in red) have not been completed, an error message appears.
- Then press the green checkmark in order to accept the entered values. The display jumps back up to the higher hierarchical level. ✓

Move an Object (feature KD01, "Z853S – SECUTEST DB COMFORT")

- Scroll to the first menu page (MEM 1/3) with the help of the ►► key.
- Select the object to be moved (together with sub-objects) with the scroll keys.
- Scroll to the second menu page (MEM 2/3) with the help of the ►► key.
- Press the **MOVE** icon.
- Using the scroll keys, select the position to which the object is to be moved and confirm by pressing the green checkmark.

Quick Command: Move Object (optional feature E01 (touchscreen) and feature KD01, "Z853S – SECUTEST DB COMFORT")

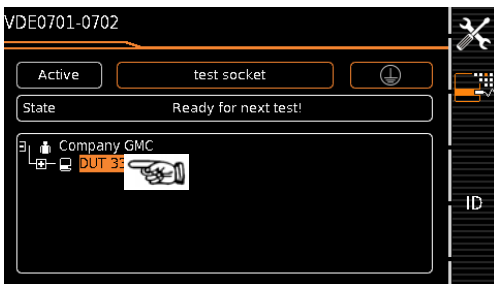

- Press and hold the object to be moved in the tree view in the initial window of a test sequence until the activity bar starts to blink.

Note

Depending on whether or not finger pressure is applied for a longer period of time in the customer or location tree, the device can be "moved" to another customer or "moved" between locations.

- Upon releasing finger pressure, the display is automatically switched to the database view (MEM), from where you can proceed to the "Move" menu.

- Now select the position with the scroll keys to which the object will be moved.
- The display is automatically returned to the initial window after confirming with the green checkmark.

Editing an Object – Changing the Description or ID Number of a Previously Created Object



- Scroll to the first menu page (MEM 1/3) with the help of the ►► key.
- Select the structure element whose designation will be changed.
- Scroll to the second menu page (MEM 2/3) with the help of the ►► key.
- Press the **EDIT** icon.
- Select the parameter whose description will be changed. The keyboard appears automatically.
- Change the displayed designation and acknowledge your entry.

Quick Command: Edit Object (optional feature E01 (touchscreen) and feature KD01, "Z853S – SECUTEST DB COMFORT")



- Press and hold a point in the detail view field in the initial window of a test sequence until the activity bar starts to blink.
- Upon releasing finger pressure, the "Edit" menu for a device/ME device (medical electric device) opens automatically.
- After entering or changing the data, the display is automatically returned to the initial window upon confirming with the green checkmark.

5.4.2 Searching for Structure Elements

- ⇨ Scroll to the first menu page (MEM 1/3) with the help of the  key.
- ⇨ Scroll to the third menu page (MEM 3/3) with the help of the  key.
- ⇨ Press the text symbol in order to search for text.
- ⇨ Press the ID symbol in order to search for an ID number.
There are three ways to enter search terms:
 - Via the softkeys
 - Via a connected USB keyboard
 - Via a barcode or an RFID scanner



Note

Distinction is made between upper and lowercase as of firmware version 2.1.1.

The keyboard entry function is opened automatically in either case.

- ⇨ The search is started after the entered search term has been acknowledged.







Note

When searching for IDs, differentiation is made between uppercase and lowercase (as of firmware 2.1.1).
When searching for text, elements are found regardless of whether they are written in upper or lowercase.

The found object is displayed inversely.

- ⇨ If several objects are found which match the search string, you can toggle with the scroll keys between the different search results.
- ⇨ The designation and ID number can be shown or hidden by pressing the magnifying glass symbol.

5.4.3 Display Measured Values from Saved Tests

- ⇨ Switch to the database view by pressing the **MEM** key.
- ⇨ Scroll to the first menu page (**Navigation**) (MEM 1/3) with the help of the  key.
- ⇨ Either select the desired object (ID number) with the scroll keys or search for it as described in Section 5.4.2.
- ⇨ Then mark the desired test with the cursor, depending on whether single measurements or test sequences are involved:
Single measurements: **date / measuring function(7/17/14 / RINS)**
Test sequence: **date / test standard (7/17/14 / VDE...)**
- ⇨ In order to view the single measurements of a test sequence after testing, press the symbol for executed measurements. The measurements appear in a list. 
- ⇨ Select the desired measurement with the scroll keys. 
- ⇨ The associated measuring parameters can be shown or hidden using the keys shown at the right. 
- ⇨ The measured value view is exited by pressing the green checkmark.

5.4.4 Clearing the Database

The database in the test instrument can be cleared in two different ways:

- **SETUP** switch setting, page 1/3 > Database > **Delete**
- Press the MEM key > scroll up with the scroll key until the database is selected > press the **DEL** softkey.

6 Connecting the Device Under Test

- Connect the DUT in accordance with the schematic diagrams included in the online help function.

Connection of the DUT to the test instrument depends on:

- **The type of DUT:**

For direct connection to the test socket (TS)

Devices with single-phase connection and extension cords via the **EL1** adapter (in which case the EL1 is connected to probe sockets P1)

For permanent connection (to the mains)

by contacting the housing with the probe (for the *measurement of protective conductor resistance* or with the direct measuring method for the touch current measurement)

Measurement of protective conductor current with a current clamp (only possible with feature I01)

For connection via adapter

- With *single-phase extension cords* via the **EL1** adapter (in which case the EL1 is connected to probe sockets P1)
 - With *single and 3-phase extension cords* via the **VL2E** adapter to the test socket
 - Devices with 5-pole, 16 A CEE plug via the **AT16-DI** differential current adapter to the test socket
 - Devices with 5-pole, 32 A CEE plug via the **AT32-DI** differential current adapter to the test socket
- **DUT protection category** (PC I, PC II or PC III) or any combinations of protection categories

 **Note**

The DUT must be switched on for all tests. Switches, relays, temperature regulators etc. must all be taken into consideration.

As a default setting, the program sequence assumes that the plug from the DUT has been connected to the test socket.

6.1 Residual Current Monitoring

For your safety, the test instrument is equipped with continuous residual current monitoring. If residual current exceeds a specified limit value, all measuring processes are stopped, and if line voltage is fed through the test socket it's disconnected. This limit value can be set to one of two levels in the **SETUP** switch position: Setup 1/3 > All Measurements > Residual Current Protection > **10 mA/30 mA**

6.2 Reference Voltage L-PE and Alternative Test Sequence

Specifying Reference Voltage L-PE

Reference (line) voltage is the voltage to which the measured values for leakage current have been standardized.

It's used in the case of leakage current for mathematical adaptation of measured current values to the specified voltage.

Measurements with line voltage at the test socket: The setting value has no influence on the voltage with which the test object is supplied via the test socket of the SECUTEST.

Leakage current measurements with "Alternative" method: The set-point value of the synthetic test voltage is derived from the value specified here.

 **Note**

The displayed measured values for leakage current are standardized to an adjustable reference value (typically 230 V) in order to permit reproducible measurement of leakage current even with fluctuating mains supply voltage

Reference voltage can be adjusted in Setup:
Setup 1/3 > All Measurements > **Ref. Voltage L-PE**

Specifying an Alternative Test Frequency

Selectable frequency setpoint value for synthetic test voltage for all leakage current measurements of measurement type "Alternative", affecting the following measurements and/or rotary selector switch positions:

- Single measurements (rotary switch level: green)
- Measurements included in predefined default test sequences
- Measurements included in user-defined test sequences (only with database extension, feature KB01, "Z853R – SECUTEST DB+")

The **Alternative Test Frequency** parameter can be set in Setup:
Setup 1/3 > All Measurements > **Alternative Test Frequency**

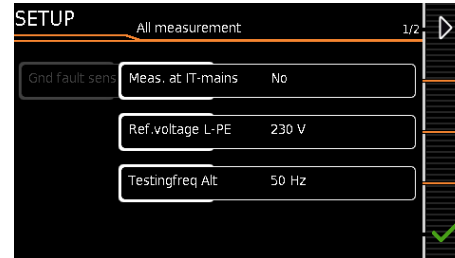

6.3 Manually Specifying the Connection Type for Single Measurements

In the case of single measurements the test instrument is unable to detect the respective **connection type** (e.g. test socket or permanent connection (voltage measuring inputs)). The connection type must be specified manually.

- Select **parameter settings**.



- After selecting the **measurement type** parameter, a list of possible connection types is displayed.
- Select a **connection type**.

Once a connection type has been selected, it remains active for all following tests until it's changed once again.

6.4 Manually Selecting a Connection Type / Protection Category for Automatic Test Sequences

If the test instrument is unable to detect the respective connection type or protection category, the suggested connection type must be examined and the connection type or protection category must be specified manually if necessary.

- Press the **SEL** key shown at the right in order to display the **Classific. parameters**.



- After selecting the **protection category** or **connection type** parameter, a list of possible settings is displayed.

- Select the respective parameter.

- Acknowledge the **Class. Param.** (classification parameters) once again.

The connection type appears at the middle of the header. The symbol for the respective protection category appears to the right of the connection type.

Once a connection type or a protection category has been selected, it remains active for all following tests until it's changed once again.

6.5 Special Conditions



Note

Protection Category II Devices with Protection Category I Mains Plugs

If the device under test is equipped with a protection category I plug although it complies with protection category II, protection category I is recognized by the test instrument. If this is the case, switch the protection category parameter from I to II.

Testing Several Protective Conductor Connections with the Function for “Automatic Detection of Measuring Point Changes”

During protective conductor measurement, the test instrument recognizes whether or not test probe P1 is in contact with the protective conductor, which is indicated by means of two different acoustic signals. This function can be adjusted in the **SETUP** switch position in the “Auto Measurements” submenu via the “Auto Measuring Point” parameter.

Protective Conductor and Insulation Resistance Measurements for Permanently Installed Devices Under Test



Attention!

Deactivate the electrical system which supplies power to the device under test before connecting the test instrument!

- Remove the mains fuses from the device under test and disconnect neutral conductor N inside the device under test.

Touch Current Measurement (absence of voltage)

Make sure that the contacted parts are not grounded.

6.6 2nd Test Probe (only SECUTEST PRO or feature H01)

If the device under test is not equipped with a country-specific mains plug which fits into the test socket at the SECUTEST, or if a permanently installed DUT is involved, the second test probe, in combination with the first test probe, permits 2-pole measurement (dual-lead-measurement) of RPE, RINS and equivalent leakage current.

Measurements with test probe 1 to test probe 2 (P1 – P2) are electrically isolated from the mains. There's no voltage at the test socket.



Attention!

Please note that during insulation measurement the maximum test voltage of 500 V may be applied between the probes.

6.7 Connection Prompts

If a single measurement (green rotary switch positions) or a specific (integrated) automated test sequence (orange rotary switch positions) is started, checking is conducted to determine whether or not all of the probes and measurement cables required to this end are connected (depending on the configuration level of your SECUTEST...). If this is not the case, you're prompted to connect probes, measurement cables or the test adapter to the SECUTEST....

Checking is only conducted to determine whether or not the corresponding sockets are occupied – make sure that suitable accessories have been connected for the selected measurement/connection type. A list of possible DUT connections depending on type of measurement is included in section 11.2.

6.8 Connection Tests Conducted by the Test Instrument

The following measurements are performed automatically when the DUT is connected to the test instrument.

- Detection of Probes / Measurement Cables**
During individual measurements / automated test sequences, checking is conducted to determine whether or not the measuring sockets required for the measurement/sequence are occupied.
- DUT connection detection** (only with country-specific variant *)
With the rotary switch in the AUTO/A1-A8 position, the “Test

Socket” connection type is selected automatically (if correspondingly configured), if a mains plug is detected in the test socket.

- Protection category detection** (only with country specific variant *):
With the rotary switch in the AUTO/A1-A8 position, protection category I or II is selected automatically (if correspondingly configured), depending on the detected type of mains plug.
- Short-circuit test**
Before switching mains voltage to the device under test: test for short-circuiting between L and N or L/N and PE. If applicable additionally as “inspection test step” in automated test sequences.
- On test** (test whether the DUT is switched on or off)

Automatic Recognition of States when Connecting DUTs and Probes

Control Function	Condition	
Short-circuit test L–N	Short-circuit / DUT starting current	$R \leq 2.5 \Omega^2$
	No short-circuit (AC test)	$R > 2.5 \Omega^2$
Open-circuit voltage U_0 4.3 V, short-circuit current $I_k < 250$ mA		
Short-circuit test LN–PE	short-circuit	$R \leq 2$ k Ω
	No short-circuit (AC test)	$R > 2$ k Ω
Open-circuit voltage U_0 230 V AC, short-circuit current $I_k < 1.5$ mA		
On test	On (DUT passive)	$R < 250$ k Ω
	Off (DUT active)	$R > 300$ k Ω
Open-circuit voltage U_0 230 V AC, short-circuit current $I_k < 1.5$ mA		
Probe test	No probe	$R > 2$ M Ω
	Probe detected	$R < 500$ k Ω
Protection class detection (only with country specific variant ¹)		
Protective conductor found: PC I		$R < 1 \Omega$
No protective conductor: PC II		$R > 10 \Omega$
Safety shutdown ¹		
Triggered at following residual current value (selectable)		> 10 mA / > 30 mA
Triggered at following probe current values		
During leakage current measurement		> 10 mA
During protective conductor resistance measurement		> 250 mA
Connection test (only with country specific variant ¹)		
Checks whether the DUT is connected to the test socket.		
DUT power cable found		$R < 1 \Omega$
No DUT power cable		$R > 10 \Omega$
Insulation test		
DUT set up in a well-insulated fashion		$R \geq 500$ k Ω
DUT set up in a poorly insulated fashion		$R < 500$ k Ω
PE mains – PE socket: Open-circuit voltage U_0 500 V DC ³ , $I_k < 2$ mA		
Overcurrent protection		
Shutdown in the event of a continuous flow of current via the test socket at: Our SECUTEST BASE(10)/PRO and SECULIFE ST BASE(25) test instruments permit active testing of devices with nominal current (load current) of up to 16 A.		$I > 16.5$ A
The test socket on the respective test instrument is equipped with 16 A fuses to this end and the switching capacity of the internal relays is also 16 A. Starting current of up to 30 A is permissible.		
In the case of test objects for which a starting current of greater than 30 A can be expected, we urgently recommend the use of a test adapter for larger starting currents, for example test adapters from the AT3 series.		

¹ Applies to M7050 with feature B00 and B09

² Applies as of version 1.7.0, previous condition: $\leq 1.5 \Omega$ respectively $> 1.5 \Omega$

³ 50 V DC as of version 2.1.1



Attention!



* Safety Shutdown

As of 10 mA of differential current (can also be set to 30 mA), automatic shutdown ensues within 500 ms. This automatic shutdown does not take place during leakage current measurement with clamp meter or adapter.

7 Notes on Saving Single Measurements and Test Sequences



At the end of each test, test results can be saved under an ID number which is unequivocally assigned to the respective test object (= device or ME device (medical electric device)). Depending on the initial situation, i.e. whether or not a test structure or database is already available or an ID has already been entered, the following different procedures are used for saving:

Variant 1 – preselection of an existing ID

You've already set up a test structure in the test instrument or uploaded one with the help of report generating software. Open the database view before starting the measurement by pressing the **MEM** key. Then select the test object or its ID within the test structure by pressing the respective scroll key. Exit the database view (MEM navigation) by pressing **ESC** and start the measurement. Press the "Save as" key  at the end of the measurement. The display is switched to the SAVE view. The ID appears with a green or orange background. Press the Save key  once again in order to complete the procedure.

Variant 2 – entry of a previously saved ID at the end of the test









You've already set up a test structure in the test instrument or uploaded one with the help of report generating software. You perform the measurement without first opening the database. No test object was previously selected in the database. Press the "Save as" key  at the end of the measurement. The following message appears: "No DUT selected!" Press the **ID** key. The softkey keyboard appears.

If you enter an ID here which is already in the database, the database view appears (MEM navigation) automatically, and the test object's ID is displayed inversely. Acknowledge the entry by pressing the  key. The display is switched to the SAVE view. The ID appears with a green or orange background. Press the Save  key once again in order to complete the procedure.

Variant 3 – entry of a new ID at the end of the test

You haven't yet set up a test structure in the test instrument, or the ID is not included in the existing structure. Press the "Save as" key  at the end of the measurement. The following message appears: "No test object selected!" Press the **ID** key in order to enter the test object's ID. The softkey keyboard appears.

If you enter an ID here which is **not yet** included in the database, a prompt appears asking you if you want to enter a new test object.



- **Selection** : If you press , the display is switched to the SAVE view. The ID appears with a green or orange background. Press the Save key  once again in order to complete the procedure.
- **Selection** : If you press , the display is switched to the database view (MEM navigation). You can go to the next page (**Edit Objects 2/3**) by pressing , and then enter a new test object. Press  to this end. All possible object types are displayed. Press **Device**. The newly entered ID appears in red to the right of the ID parameter. Acknowledge the entry by pressing the  key. The display is switched to the database view (MEM navigation). The newly entered test object is displayed inversely in the structure. Press **ESC** in order to return to the SAVE view. The ID appears with a green background. Press the Save key  once again in order to complete the procedure.
- **ESC**: If you don't want to save any measured values, press **ESC** twice in order to go to the measuring view. If you press **ESC** again, a prompt appears asking whether or not you want to delete the measuring points in order to continue with the measurement without saving.

7.1 QuickEdit Function – QEDIT (feature KD01, "Z853S – SECUTEST DB COMFORT")

QuickEdit is available whenever you search for a test object ID and the ID doesn't already exist in the database.

The following search options are available:

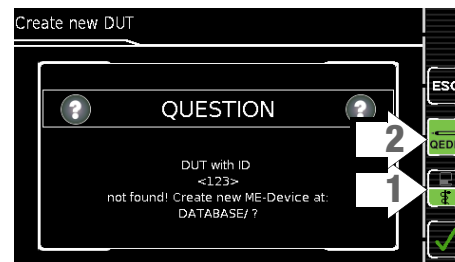

- Via the ID softkey in the test sequence (AutoTest) or in the save menu of the manual test
- ID search via ID softkey on page 3 of 3 of database management MEM
- Read-in of a test object ID via the barcode or RFID scanner

If the searched for ID is not found, the following question appears. When creating a new object you can first of all choose between a (standard) test object ( icon) or a medical test object – "new ME device" in (staff of Aesculapius icon ) by pressing the (1) key.

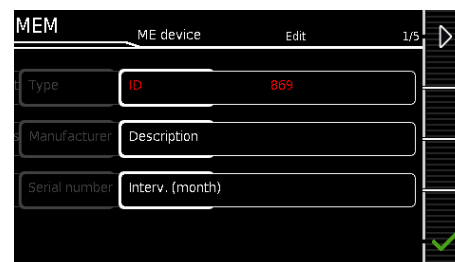

If you select QEDIT (Quick Edit function), key (2) (shown against a green background and not crossed out), you proceed directly to the memory management entry window by confirming with , in order to create a new test object and enter further properties.



After confirming with , the location of the ID in the database is displayed. Measurement results are saved to memory after pressing the Save key  once again.



8 Single Measurements

8.1 General

- The desired measurement is selected with the help of the green pointer on the rotary switch and the green semicircle.
- The respective measurement is configured with the help of the softkeys. The parameter settings can be accessed by pressing the softkey with the symbol shown at the right.
- The **measurement type** parameter displayed in each case in the footer can be changed directly using the key shown at the right without having to exit the measuring view.
- The selection of **polarity** for line voltage at the test socket can be changed directly using the key shown at the right without having to exit the measuring view.
- No limit values can be specified for single measurements, and thus there's no evaluation.

- Checking is performed before each measurement in order to assure a trouble-free sequence, and to prevent any damage to the DUT.
- Single measurements can be saved to memory. The assignment of an ID number is possible to this end.
- Single measurements can be combined into measurement series.
- Mains power can be connected to the device under test with the desired polarity by making a pre-selection in the parameter settings.

Measurement Status – Progress Bar

Measurement standstill (static line)

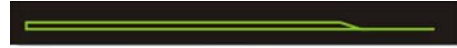

Measurement in progress (space is gradually filled in, pulsating)

Measuring View, Single Measurements

Monentarily measured value

- Select parameters
- Select measurement/connection type
- Adjust test current
- Reset offset to 0 Ω

Measuring Parameters Display, Single Measurements

ESC: Discard changes and jump back to measuring view

Current/maximum number of parameter pages

- Scroll through parameter pages
- Select measuring parameter directly
- Select measuring parameter directly
- Select measuring parameter directly
- Accept changes and jump back to measuring view

Numeric Entry (for parameters UI50(set), Offset ...) via Softkeys with the SECUTEST BASE(10)

- Delete character to the left of the cursor in the display
- Scroll right
- Scroll left
- Accept entry and exit keyboard













Numeric Entry (for parameters UI50(set), Offset ...) via Touchscreen Keyboard with the SECUTEST PRO (feature E01)

- Delete character to the left of the cursor in the display *
- Accept entry and exit keyboard *







* Also via assigned softkey

Figure 8 Configuring Single Measurements (parameters entry and display)

8.2 Meaning of Symbols in the User Interface

Symbol	Softkey Variants, Single Measurements
	Set parameters
	Accept changed parameters, acknowledge memory location
	Acknowledge messages during tests/measurements and resume test sequence
	Abort measurement
	Direct selection key for selecting the measurement type
	Currently selected polarity: "L-N" Press key to change polarity
	Currently selected polarity: "N-L" Press key to change polarity
Ip	Direct selection key for selecting test current for protective conductor measurement
U+ U-	Direct selection key for changing voltage in 10 V steps for insulation measurement
	Start evaluation – record measured value. Each time this softkey is pressed, an additional measured value is saved and the number is increased by one.
ID	The ID number to which the measurement(s) will be stored can be entered here.
	Valid measured values have been obtained for a measurement. This measurement can be saved.
	Save measurement data as (with display of directory path / ID or new entry of an ID other than the preselected one)
	Transmit measurement data to a PC, e.g. in order to save them to IZYTRONIQ report generating software (push-print function) – refer to IZYTRONIQ online help for a description
	Display measured values from performed measurements
	Magnifying glass icon: Magnifying glass icon: show (+) or hide (-) details regarding database objects or selected measurements





8.3 Displaying the Last Measured Values

- Start the measurement by pressing the **START/STOP** button.  The symbol shown at the right appears and indicates how many measurements have already been performed.
- Stop the measurement by pressing the **START/STOP** key, unless a specified measuring time has been stipulated.  The save symbol (floppy disk with a number 1) appears and indicates that one valid measured value has been recorded, which can now be saved.
- Press the **save symbol** (floppy disk).  "No DUT selected!" appears.
- In order to view the last measured values, press the symbol for executed measurements after testing. The last measured values are displayed. 
- The desired measurement can be selected with the scroll keys. 
- The associated measuring parameters can be shown or hidden using the keys shown at the right. 
- The measured value view is exited by pressing the green checkmark in order to subsequently save the measured values (as described in Section 8.4) or to return to the initial view by pressing the ESC key.





8.4 Measurement Series and Storage

Single measurements can be combined into measurement series. The measured values can be saved by pressing the save key, or measurement series can be generated. These can be saved to a test object (ID number) which has already been set up in the database (see Section 5.4.1). The appearance of the save key changes depending on meaning.

Measuring Sequence with Pre-Selection of the Test Object

- Activate the database view (MEM navigation) by pressing the **MEM** key.
- Select the test object or its ID number for the following measurements with the scroll keys. 
- Return to the measuring view by pressing the **ESC** key or the **START/STOP** key.
- Start the test with the **START/STOP** key. The symbol shown at the right appears and the zero indicates that no measurements have yet been recorded or saved to buffer memory. 
- Each time the key at the right is pressed, the respective current measured value is saved to buffer memory and the number shown in the symbol is increased. In this way, you always know how many measurements have already been recorded. 
- Stop the measurement by pressing the **START/STOP** key, unless a specified measuring time has been stipulated. The **Save as** symbol appears (floppy disk icon with the number of measured values saved to buffer memory). 
- If you press the save symbol now (floppy disk), the display is switched to the test object in the database view for checking.
- After pressing the save symbol once again, acknowledgement of successful storage appears. At the same time, the display is switched to the measuring view.

Measuring Sequence with Subsequent Entry of the Test Object

- Start the measurement by pressing the **START/STOP** button. The symbol shown at the right appears and indicates how many measurements have already been performed. 
- Stop the measurement by pressing the **START/STOP** key, unless a specified measuring time has been stipulated. The save symbol (floppy disk with a number 1) appears and indicates that one valid measured value has been recorded, which can now be saved. 
- Press the **save symbol** (floppy disk). 
- You're informed that you haven't selected a test object in the database. 
- There are two ways to subsequently select your test object using an ID number which has already been set up in the database:
 - Select the ID number with a **barcode scanner** or
 - Enter an ID number by pressing the **ID** key. 
- The cursor jumps to the location of the test object with the selected ID number. You only need to acknowledge this position by pressing the green checkmark.
- Press the save symbol (floppy disk). A message appears indicating that the data have been successfully saved and the display is switched to the measuring view.



Note

If the entered number cannot be found in the database (because it hasn't been set up), it can be entered immediately by pressing **Yes** when the prompt appears. However, the storage location cannot be selected in this case. The measurement is saved to the most recently selected hierarchy.



Note

Measurements and measurement series can only be saved after measurement has been completed. Measured values can only be added to intermediate buffer memory during a measurement. Customer, location and other entries cannot be changed in the memory menu. These have to be selected directly in the database and entered or changed.



Note

Please observe the following before storing tests or measurements to the test instrument:

If applicable, the date of recalibration is printed on test reports, or transmitted to a PC during when exporting test data. For this reason we recommend checking the recalibration date saved in the test instrument before starting work with your new test instrument (see page 12).

8.5 Measuring Protective Conductor Resistance – RPE



Single measurements, rotary switch level: green					
Switch Position	Measurement Type, with Mains to Test Socket	Measurement Type, without Mains to Test Socket	Measuring Functions		
			R_{PE}	Protective conductor resistance	Test current
			200 mA	10 A ¹	25 A ¹
R_{PE}		Passive: PE(TS) - P1	•	•	•
		Active: PE(TS) - P1 ⁴	•		
		PE(mains) - P1	•	•	
		PE(mains) - P1 clamp ³		•	
		P1 - P2 ²	•	•	•

¹ 10/25 A-RPE measurements are only possible with line voltages of 115/230 V and line frequencies of 50/60 Hz.

² Connection of 2nd test probe for two-pole measurement with SECUTEST PRO/SECULIFE ST BASE(25) (or instrument with feature H01)

³ Can only be selected if the IP(set) parameter has been set to 10 A~ only with SECUTEST PRO/SECULIFE ST BASE (or instrument with feature G01)

⁴ Can only be selected with SECUTEST BASE or if the IP(set) parameter has been set to 200 mA.

Application, Definition, Measuring Method

Protective conductor resistance is the sum of the following resistances:

- Connector cable or device connector cable resistance
- Contact resistance at plug and terminal connections
- Extension cord resistance if applicable

Protection Category I Devices

- Measurement type PE(TS) - P1 (passive)
- DUT mains plug to test socket
- Test probe P1 to P1 terminals

Schematic Diagram

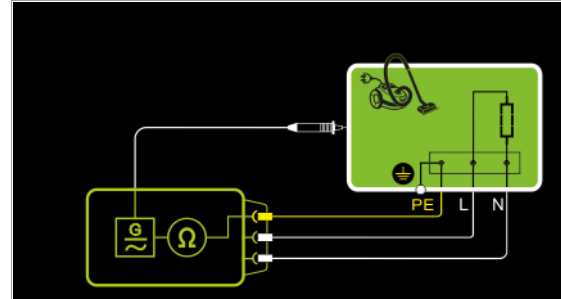

Protective conductor resistance is measured between the earthing contacts at the mains plug and the earthing contact connected to the housing by contacting the housing with test probe P1.

Wiring Diagram

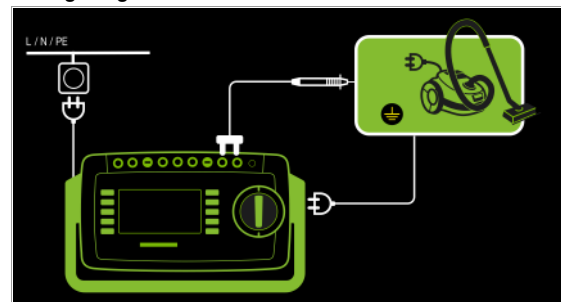

Measurement of RPE at Single-Phase Extension Cords with EL1

- Measurement type PE(TS) - P1 (passive)
- Extension cord plug to test socket
- EL1 to P1 terminals

Schematic Diagram

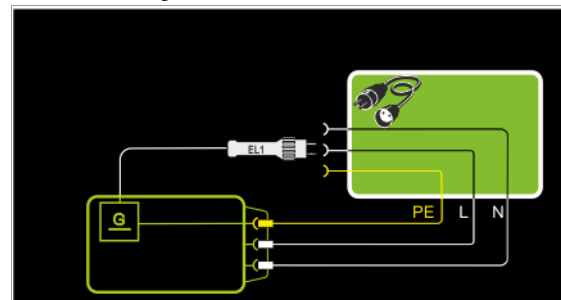

Wiring Diagram

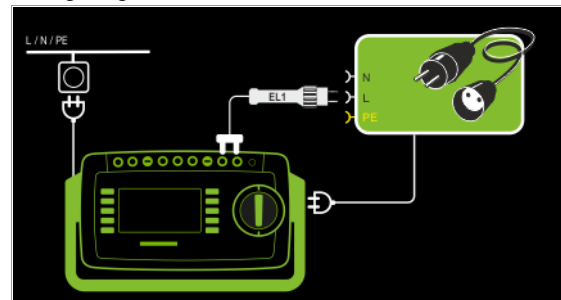

Protection Category I Devices

Special Case: Line Voltage at Test Socket (for testing PRCDs)

- Measurement type PE(TS) - P1 (active)
- DUT mains plug to test socket
- Test probe P1 to P1 terminals

Schematic Diagram

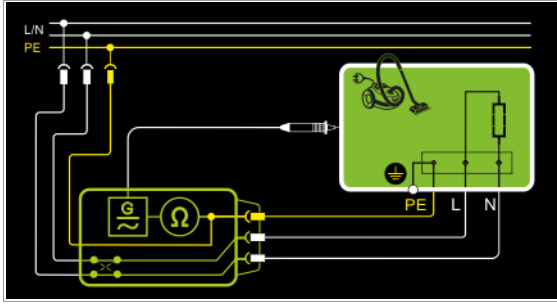

Protective conductor resistance is measured between the earthing contacts at the mains plug and the earthing contact connected to the housing by contacting the housing with test probe P1.

Wiring Diagram

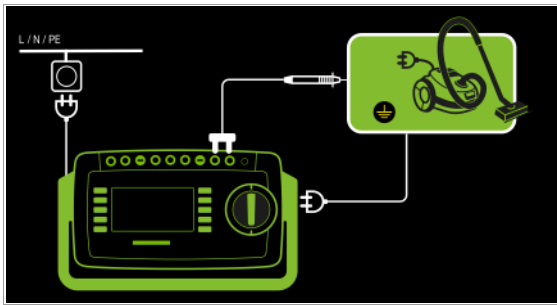

Protection Category I Devices

Special Case: Permanently Installed DUTs

- Measurement type PE(mains) - P1
- Test probe P1 to P1 terminals

Schematic Diagram

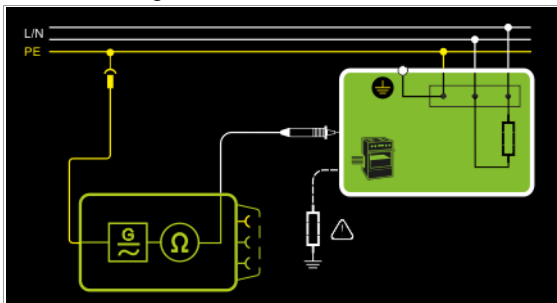

In the case of *permanently installed DUTs*, protective conductor resistance is measured between the mains power earthing contact and the earthing contact connected to the housing by contacting the housing with test probe P1.

Wiring Diagram

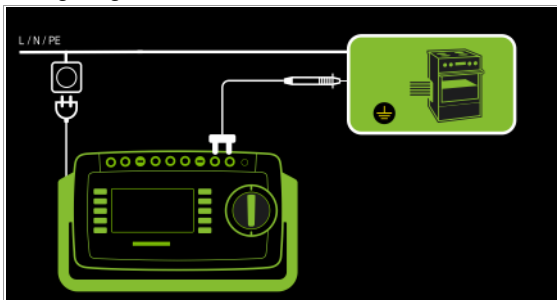

Measurement via current clamp sensor at permanently installed DUT

- Measurement type PE(mains) - P1 clamp
- Test probe P1 to P1 terminals
- Clamp to COM-V (only with SECUTEST PRO or feature I01 with optional current clamp sensor)

Schematic Diagram

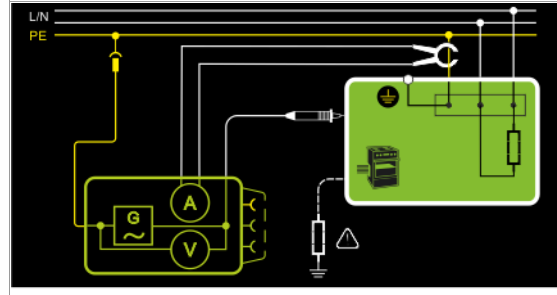

Measurement of test current by closing the current clamp sensor around mains PE and contacting the housing with test probe P1 for permanently installed protection category I devices under test

Wiring Diagram

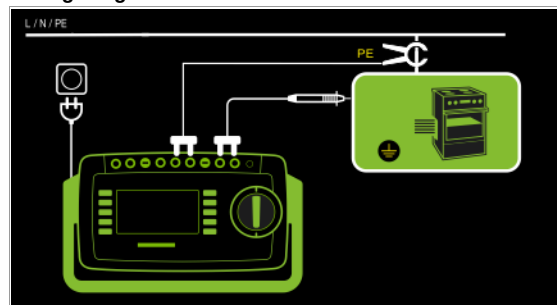

Set Measuring Range at Current Clamp Sensor and Parameter at the SECUTEST PRO or SECULIFE ST BASE

This measurement type can only be selected if test current is set to 10 A AC.

SECUTEST PRO Transformation Ratio Parameter	Clamp		SECUTEST PRO Display Range with Clamp
	Transformation Ratio (switch *)	Measuring Range	
1 mV : 1 mA	WZ12C		0 mA ... 300 A
	1 mV : 1 mA	1 mA ... 15 A	

* Only with WZ12C

2-Pole Measurement at Permanently Installed DUTs (only with SECUTEST PRO or feature H01)

- Measurement type P1 - P2
- Test probe P1 to P1 terminals
- Test probe P2 to P2 terminals

Schematic Diagram

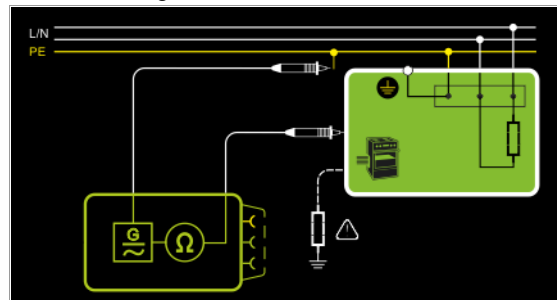

PE at the mains connection is contacted with the second test probe instead of via the test instrument's mains plug.

Wiring Diagram

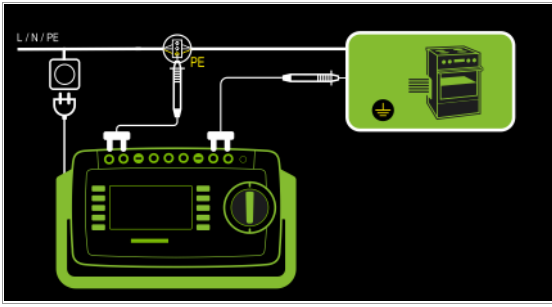

Resistance is measured:

- Between each exposed *conductive part of the housing* and the earthing contacts at the mains and the device plug (if a removable mains connector cable is used), or the protective conductor terminal for permanently installed devices.
- As 4-pole measurement
- Between the earthing contacts at the mains plug and the earthing contacts at the device plug for *device connector cables*
- Between the earthing contacts at the mains plug and the earthing contacts at the coupling socket for *extension cords*

Setting Measuring Parameters for RPE



Measuring Parameter	Meaning	
Measurement Type		Suitable for DUT Connection via
(passive:) PE(TS) – P1	Testing is conducted between the two protective conductor terminals: at the test socket and test probe P1.	Test socket, EL1 with DUT at test socket, VL2E, AT3 adapter (AT3-III E, AT3-IIS, AT3-IIS32), AT16DI/AT32DI
Active: PE(TS) – P1¹	Same as PE(TS) – P1 , but with line voltage to the test socket, 200 mA AC flows immediately. A ramp-like, slowly rising DC test current flows (PRCD triggering is avoided) at +200 mA DC, -200 mA DC and ±200 mA DC.	Test socket (for PRCDs)
PE(mains) – P1 <i>Permanently connected DUTs</i>	Testing is conducted between the ground terminal at the mains and test probe P1.	Permanent connection
P1 – P2	SECUTEST PRO/SECULIFE ST BASE (feature H01): 2-pole measurement between test probes 1 and 2 (see section 6.6)	Permanent connection
Clamp²	SECUTEST PRO/SECULIFE ST BASE (features G01 and IO1): Test current measurement with current clamp sensor	Permanent connection
IP(set)		
+200 mA DC	Test current: positive direct current	
-200 mA DC	Test current: negative direct current	
±200 mA (DC)	Test current: direct current whose polarity is reversed every 2 seconds	
200 mA (AC)	Test current: alternating current, adjustable frequency f, see below	
10 A (AC)	10 A test current: SECUTEST BASE10 or PRO only (feature G01)	
25 A (AC)	25 A test current: SECULIFE ST BASE25 only (feature G02)	
f – only at 200 mA (AC)		
50 ... 200 Hz	Test frequency (adjustable in steps: 50, 60, 110, 150, 200 Hz)	
Offset		
> 0 ... < 5 Ω	Zero balancing for a selected reference point.	
Clamp factor – only for clamp measurement type		
1 mV : 1 mA	Transformation ratio of the WZ12C current clamp sensor. For setting the current clamp factor at the WZ12C clamp and the SECUTEST PRO (see table above).	

¹ Measurement cannot be performed with 10/25 A AC for this measurement type.
² **SECUTEST PRO / SECULIFE ST BASE** (feature G01): This type of measurement can only be selected if a test current of 10 A AC has been chosen.

Entering and Deleting Offset Values

The test instrument determines protective conductor resistance by means of a 4-pole measurement. If measurement cables or extension cords are used whose ohmic resistance should be automatically subtracted from the measurement results, there are two ways to save the respective offset value in the R_{PE} switch position:

- Entry via the numeric keypad
- Acceptance of the momentary measured value by pressing the **SET OFFSET** softkey

Proceed as follows in order to accept the measured value:

- Start the measurement and wait until the measured value settles in.
- Press the **SET OFFSET** key. The value is transferred to the offset field.

The entered or accepted offset value is permanently stored and is subtracted from all protective conductor resistance values measured in the future. This applies to single measurements as well as to measurements conducted in the AUTO switch positions. The  symbol is displayed in the header in all switch positions until the offset value is deleted by pressing the **CLEAR OFFSET** softkey (R_{PE} switch position).

Protective Conductor Current Measurement with 25 A AC

In accordance with IEC 60601, at least 25 A must be achieved with a load of 0.1 Ω and a maximum voltage of 0.6 V.

Continuous protective conductor resistance measurement with a test current of 25 A is not possible due to contact resistance at the jacks.

If the test instrument is operated at room temperature, an uninterrupted **test duration of at least 15 seconds** is possible. Under other conditions, maximum test duration may be shorter and/or the measurement may be prematurely terminated.



Attention!

Suitable measurement cables with a minimum cable cross-section of 2.5 mm must be used when measuring protective conductor resistances with a “25 A AC” test current. Included with the **SECULIFE ST BASE25**: suitable test probe with **green** strain relief sleeve. For subsequent orders, we recommend the SK2-25A test probe (Z746C). Under certain circumstances, the required standard values might not be complied with if unsuitable accessories are used.



Attention!

Measurement duration with a 25 A test current is limited (see technical data). An error message is generated if measurement duration is exceeded which results in a temperature increase at the test instrument.

Test Sequence with Connection to the Test Socket

- ⇨ Set the rotary switch to the R_{PE} position.
- ⇨ Select measurement type or connection type, and test current. After pressing the **lp** key, you have direct access to the test current parameters: each time this key is pressed, the setpoint value shown in the measuring window is switched to the next value.
- ⇨ Connect the DUT to the test socket.
- ⇨ **Start the test:** press the **START/STOP** key.



- ⇨ Contact all conductive parts which are connected to the protective conductor with test probe P1.

During measurement, the **connector cable** must only be moved to the extent to which it's accessible during repair, modification or testing.

If a change in resistance occurs during the manual test step of the continuity test, it must be assumed that the protective conductor is damaged, or that one of the connector contacts is no longer in flawless condition.

- ⇨ The measured values are displayed. The measured value recording symbol shown at the right appears. Each time this key is pressed, the currently displayed measured value is saved to buffer memory.



- ⇨ **End the test:** press the **START/STOP** key. The save symbol appears (floppy disk showing the number of measured values stored to buffer memory) and prompts you to save the measured values to an ID number.



- ⇨ Read the measured values and compare them with the table of permissible limit values.

- ⇨ Press the **ESC** key in order to discard the measured values stored to buffer memory and acknowledge by pressing the key shown at the right.



Special Case: Testing Extension Cords

- ⇨ Set the measurement type parameter to "PE(TS) – P1".
- ⇨ Connect the EL1 adapter to the P1 sockets at the test instrument.
- ⇨ Connect the plug at the end of the extension cord to the test socket.
- ⇨ Connect the coupling socket at the end of the extension cord to the plug at the EL1 adapter.
- ⇨ Same test sequence as described above.

Further options for testing extension cords are included in the descriptions of single measurements in the **EL1** switch position and under automatic test sequences in switch position A8.

Special case: Permanently Installed Test Object

- ⇨ Contact all conductive housing parts with test probe with test probe P1.

Special Case: Testing Protective Conductor Resistance at PRCDs (as of firmware V1.4.0)

For PRCDs whose protective conductor resistance cannot be measured when switched off, the **SECUTEST BASE(10)** offers the "active: PE(TS) - P1" measurement type, with which the PRCD can be switched on in order to ascertain protective conductor resistance.

- ⇨ Set the measurement type parameter to "active". PE(TS) – P1".
- ⇨ Connect the EL1 adapter (or a standard test probe as an alternative) to the P1 sockets at the test instrument.
- ⇨ Connect the PRCD to be tested to the test socket via its plug.
- ⇨ Connect the EL1 adapter to the outlet on the PRCD (alternative: connect the test probe to the protective conductor of the PRCD's outlet, e.g. by means of an alligator clip).
- ⇨ Start the measurement.
- ⇨ Switch line voltage to the test socket. Then switch the PRCD on.
- ⇨ Otherwise, the test sequence is the same as described above.



Note

With the +200 mA=, -200 mA= and ±200 mA= measurement types, test current rises very slowly in order to prevent triggering of residual current monitoring at the PRCD. And thus with this measurement type, it may take longer than usual until a valid measured value is displayed. For this reason, the protective conductor should not be contacted manually with the test probe, in order to prevent a sudden rise in test current resulting in inadvertent tripping of the PRCD.

Maximum Permissible Limit Values for Protective Conductor Resistance for Connector Cables with Cross-Sections of up to 1.5 sq. mm and Lengths of up to 5 m

Test Standard	Test Current	Open-Circuit Voltage	R_{SL} Housing – Device Plug	R_{SL} Housing – Mains Plug	Mains Cable
VDE 0701-0702:2008 DIN EN 60974-4 VDE 0544-4:2017-05	> 200 mA=	$4 V < U_L < 24 V$		0.3 Ω + 0.1 Ω ¹ for each additional 7.5 m	
IEC 62353 (VDE 0751-1)	> 200 mA=		0.2 Ω	0.3 Ω	0.1 Ω

¹ Total protective conductor resistance: max. 1 Ω

8.6 Insulation Resistance Measurement – RINS

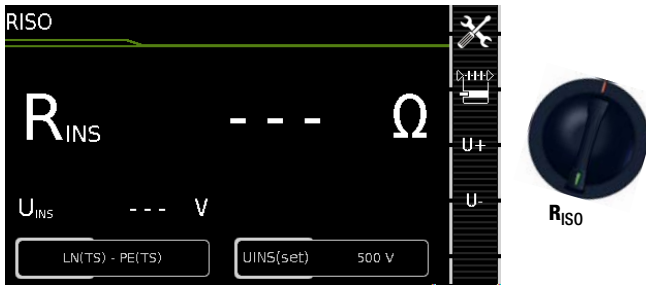

Single measurements, rotary switch level: green

Switch Position	Measuring Functions	Measurement Type, Without Mains to Test Socket
R _{ISO}	R _{INS} Insulation resistance (PC I/PC II)	LN(TS) - PE(TS)
	U _{INS} Test voltage	LN(TS) - P1 P1 - P2 ¹ PE(mains) - P1 PE(TS) - P1 LN(TS) - P1//PE(TS)

¹ Connection of 2nd test probe for 2-pole measurement with SECUTEST PRO (or instrument with feature H01)

Application, Definition, Measuring Method

Protection Category I Devices

- Measurement type LN(TS) - PE(TS)
- DUT mains plug to test socket

Schematic Diagram

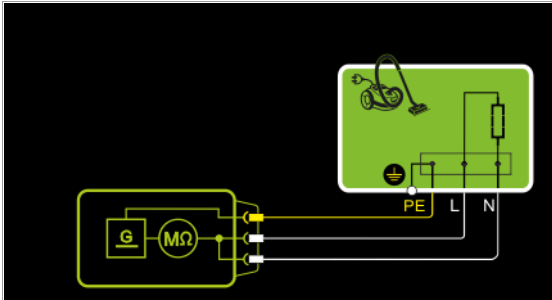

Insulation resistance is measured between short-circuited mains terminals (L-N) and protective conductor PE.

Wiring Diagram

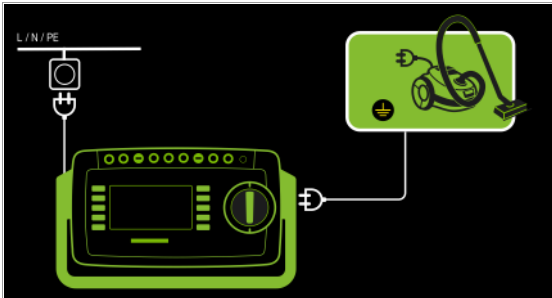

Protection Category II Devices

with Exposed Conductive Parts

- Measurement type LN(TS) - P1
- DUT mains plug to test socket
- Test probe P1 to P1 terminals

Schematic Diagram

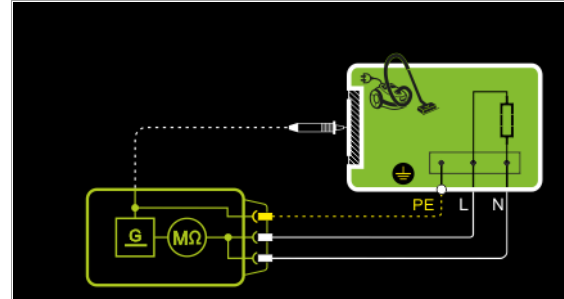

Insulation resistance is measured between short-circuited mains terminals (L-N) and external conductive parts which can be contacted with test probe P1 and are **not** connected to the housing.

Wiring Diagram

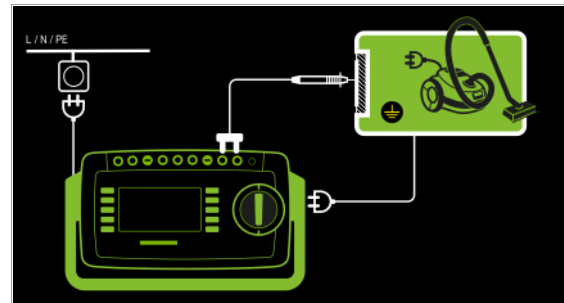

Protection Category II Devices with Outputs for Safety Extra-Low Voltage

– Measurement type LN(TS) - P1

- DUT mains plug to test socket
- Test probe P1 to P1 terminals

Schematic Diagram

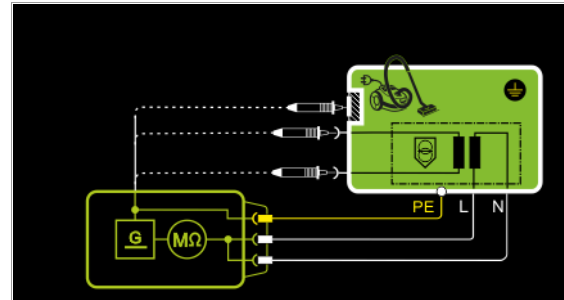

Insulation resistance is measured between short-circuited mains terminals (L-N) and the short-circuited safety extra-low voltage outputs which are contacted with probe P1.

Wiring Diagram

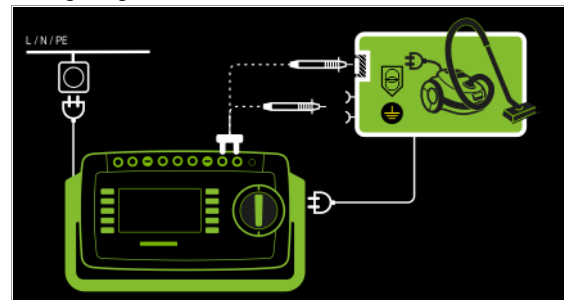

Protection Category I Devices with Outputs for Safety Extra-Low Voltage and Exposed Conductive Parts

- Measurement type LN(TS) - P1
- DUT mains plug to test socket
- Test probe P1 to P1 terminals

Schematic Diagram

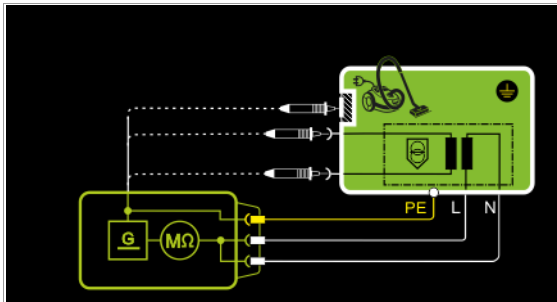

Insulation resistance is measured successively between short-circuited mains terminals (L-N) and the safety extra-low voltage outputs which can be contacted with test probe P1, as well as external conductive parts which are **not** connected to the housing.

If measuring points should be contacted one after the other, this is indicated by a dashed line. However, there are two parallel measuring circuits for the RISO measurement with the LN(TS) – P1//PE(TS) measuring parameter, which are established simultaneously to the short-circuited L and N conductors: one insulation resistance is measured via PE at the test socket and, at the same time, a second insulation resistance is measured via test probe P1.

Wiring Diagram

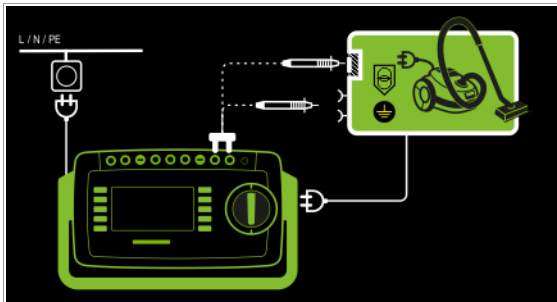

2-Pole Measurement at Protection Category I Housing Parts (only with SECUTEST PRO or feature H01)

- Measurement type P1 - P2

Schematic Diagram

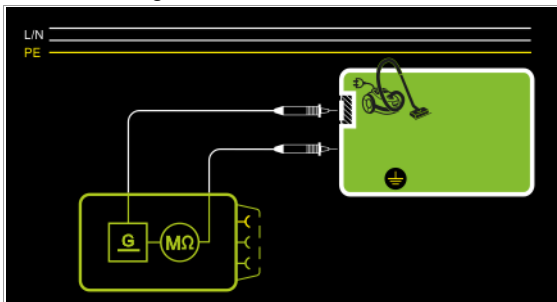

Insulation resistance is measured between external conductive parts which can be contacted from the outside with test probe P2 and are **not** connected to the housing, and the housing with test probe P1.

Wiring Diagram

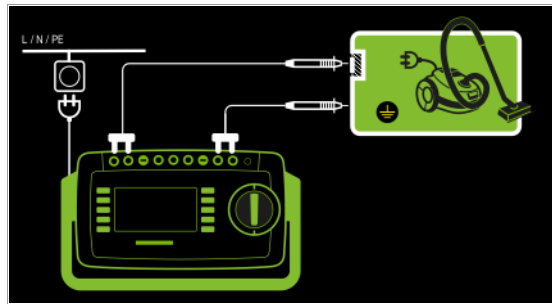

Special Case: Permanently Installed Protection Category I Devices

- Measurement type PE(mains) - P1
- Test probe P1 to P1 terminals

Schematic Diagram

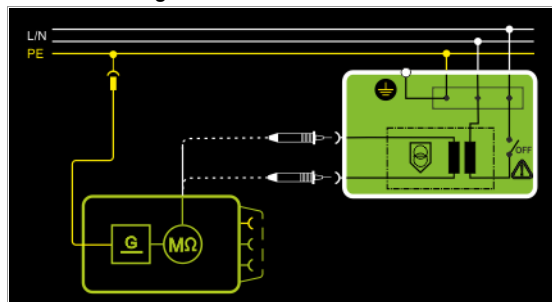

Insulation resistance is measured successively between PE at the mains connection and the extra-low voltage inputs by contacting each of them with test probe P1.

Wiring Diagram

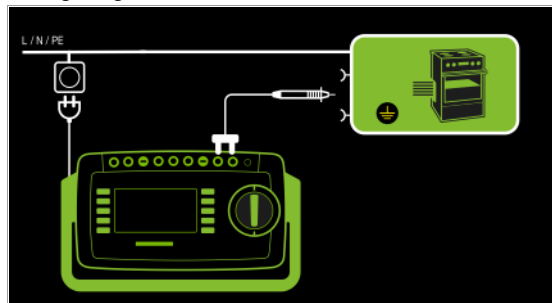

Attention!

Deactivate the electrical system which supplies power to the device under test before connecting the test instrument!

- Remove the mains fuses from the device under test and disconnect neutral conductor N inside the device under test.
- Connect test probe P1 to phase conductor L at the device under test in order to measure insulation resistance.

- Protection Category I Devices with Terminals for Applied Parts**
 – Measurement type PE(TS) - P1
 – DUT mains plug to test socket
 – Test probe P1 to P1 terminals

Schematic Diagram

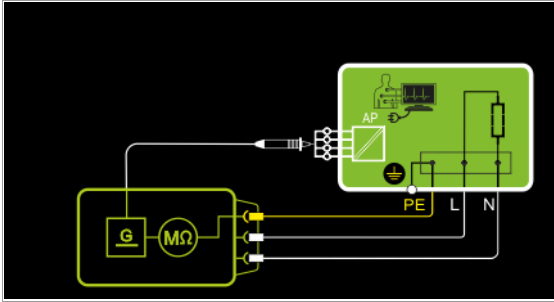

Insulation resistance is measured between protective conductor terminal PE and external, short-circuited applied parts which can be contacted with test probe P1.

Wiring Diagram

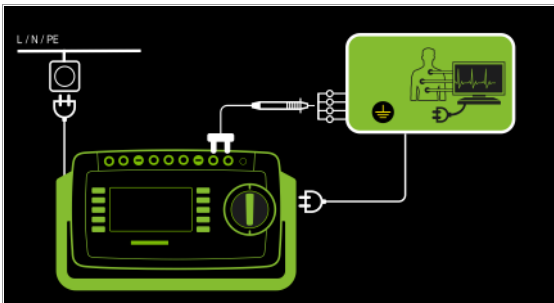

Protection Category I Devices with Outputs for Safety Extra-Low Voltage

- Measurement type PE(TS) - P1
 – DUT mains plug to test socket
 – Test probe P1 to P1 terminals

Schematic Diagram

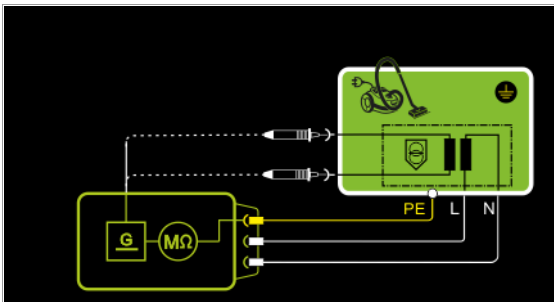

Insulation resistance is measured between the PE terminal and the safety extra-low voltage outputs, which must be contacted one after the other with probe P1.

Wiring Diagram

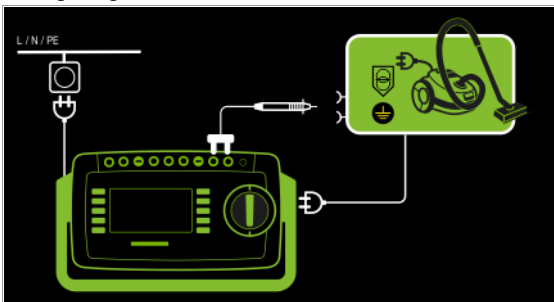

- Protection Category I Devices with Exposed Conductive Parts**
 – Measurement type LN(TS) - P1//PE(TS)
 – DUT mains plug to test socket
 – Test probe P1 to P1 terminals

Schematic Diagram

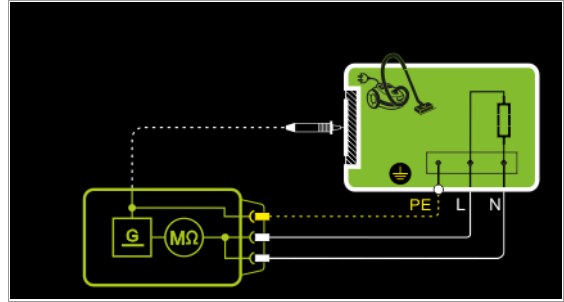

Insulation resistance is measured between short-circuited mains terminals (L-N) and external conductive parts which can be contacted with test probe P1 and are **not** connected to the housing, as well as protective conductor terminal PE at the housing.

Wiring Diagram

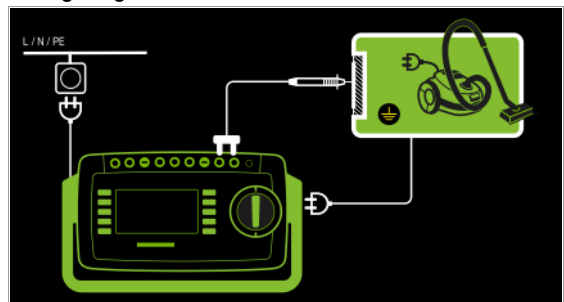

Setting Measuring Parameters for RINS



Measuring Parameter	Meaning	
Measurement Type		Suitable for DUT Connection via
LN(TS)-PE(TS)	PC I: Testing is conducted between short-circuited LN mains terminals at the test socket and the DUT's PE terminal	Test socket, VL2E, AT3 adapter (AT3-IIIE, AT3-IIS, AT3-IIS32), AT16DI/AT32DI, CEE Adapter
LN(TS)-P1	Testing is conducted between short-circuited LN mains terminals at the test socket and test probe P1.	Test socket, VL2E, AT3 adapter (AT3-IIIE, AT3-IIS, AT3-IIS32), AT16DI/AT32DI,
P1 – P2	SECUTEST PRO or feature H01: 2-pole measurement between test probes 1 and 2 (see section 6.6)	No connection (PC3)
PE(mains)-P1	Cable test: Testing is conducted between the ground terminal at the mains and test probe P1.	Permanent connection
PE(TS)-P1	Testing is conducted between the PE terminal at the test socket and test probe P1.	Test socket
LN(TS)-P1 // PE(TS)	Testing is conducted between short-circuited LN mains terminals at the test socket and test probe P1, including PE at the test socket.	Test socket, VL2E, AT3 adapter (AT3-IIIE, AT3-IIS, AT3-IIS32), AT16DI/AT32DI,
UISO(set)		
> 50 ... < 500 V	Variable test voltage can be entered with the numeric keypad	

Test Sequence



Attention!

Prerequisite for Testing

The measurement of insulation resistance may not be conducted on protection category I devices which have not passed the protective conductor resistance test.



Note

The insulation test cannot be performed for all DUTs, for example electronic devices, EDP equipment, medical devices etc. Leakage current measurements must be performed for these DUTs (see Section 8.7). Observe the notes in the service instructions.



Attention!

In order to prevent damage to the instrument, measurement of insulation resistance may only be performed between application parts, measurement inputs or interfaces and the protective conductor or the housing if the instrument is laid out for measurements of this type.



Attention!

Touching the DUT During Measurement

Testing is conducted with up to 500 V, and although current is limited ($I < 3.5 \text{ mA}$), if the DUT is touched electrical shock may occur which could result in consequential accidents.



Attention!

Switch Settings at the DUT

All switches at the DUT must be set to the on position during measurement of insulation resistance, including temperature controlled switches and temperature regulators as well.

Measurement must be performed in all program steps for devices equipped with program controllers.

⇨ Set the rotary switch to the **R_{ISO}** position.

⇨ Select the measurement type:

– By setting the parameters

or

– Directly via the **Measurement Type** key 

⇨ Select the test voltage.

The **Up-** and **Up+** keys provide you with direct access to the test voltage parameters: each time this key is pressed, the setpoint value shown in the measuring window, Up(set), is reduced or increased by 10 V.

⇨ Connect the DUT to the test socket.

⇨ **Start the test:** press the **START/STOP** key.



⇨ Switch the device under test on.



Note

The measurement is disabled if a voltage of greater than 25 V is measured between the terminals.

⇨ The measured values are displayed. The measured value recording symbol shown at the right appears. Each time this key is pressed, the currently displayed measured value is saved to buffer memory.



⇨ Turn off the device under test.



Attention!

Removing the Connector Cable

Do not remove the DUT's connector cable until the test has been stopped, in order to assure that the capacitors have been discharged.

⇨ **End the test:** press the **START/STOP** key.

The save symbol appears (floppy disk showing the number of measured values stored to buffer memory) and prompts you to save the measured values to an ID number.



⇨ Read the measured values and compare them with the table of permissible limit values.

⇨ Press the **ESC** key in order to discard the measured values stored to buffer memory and acknowledge by pressing the key shown at the right.



Minimum Permissible Limit Values for Insulation Resistance

Test Standard	Test voltage	R _{INS}				
		LN → PE	LN → Probe	Probe → PE	PC III	Heating
VDE 0701-0702:2008	500 V	1 MΩ	2 MΩ	5 MΩ	0.25 MΩ	0.3 MΩ *
DIN EN 60974-4 VDE 0544-4:2017-05		2 MΩ	5 MΩ	5 MΩ		

* With activated heating elements (where heating power > 3.5 kW and R_{INS} < 0.3 MΩ: leakage current measurement is required)

Test Standard	Test voltage	R _{INS}	
		PC I	PC II
IEC 62353 (VDE 0751-1)	500 V	2 MΩ	7 MΩ
		BF or CF	BF or CF
		70 MΩ	70 MΩ

Notes

Insulation resistance and/or leakage current must be measured by contacting all exposed, conductive parts with test probe P1 for protection category II and III devices, as well as for battery powered devices.

Batteries must be disconnected during testing of battery powered devices.

8.7 Measuring Leakage Current



Attention!

Measurement with DUT Connected to Line Voltage

It's absolutely essential to assure that the device under test is operated with line voltage during performance of **leakage current measurements with the direct or differential current method**. Exposed conductive parts may conduct dangerous touch voltage during testing, and may not under any circumstances be touched. (Mains power is disconnected if leakage current exceeds approx. 10 mA.)

Frequency response in accordance with the figure to the right is taken into consideration for all leakage current measurements (**IPE, IT, IE, IP**) (direct, differential, alternative).

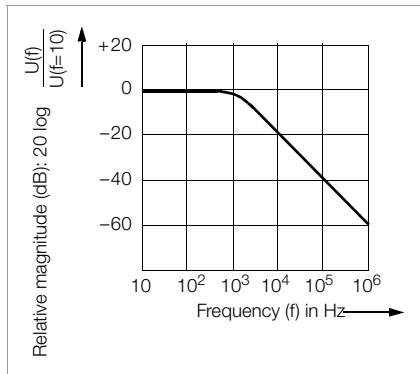

8.7.1 Protective Conductor Current – IPE

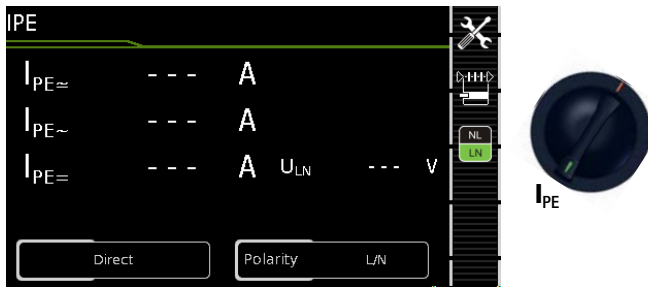

Single measurements, rotary switch level: green

Switch Position	Measurement Type, with Mains to Test Socket	Measurement Type, without Mains to Test Socket	Measuring Functions
I _{PE}	Direct		I _{PE~} Protective conductor current, RMS I _{PE~} AC component I _{PE=} DC component U _{LN} Test voltage
	Differential		I _{PE~} Protective conductor current, RMS U _{LN} Test voltage
		Alternative	I _{PE~} Protective conductor current, RMS U _{LN} Test voltage
	AT3 adapter ¹		I _{PE~} Protective conductor current, RMS U _{LN} Test voltage
		Clamp ²	I _{PE~} Protective conductor current, RMS U _{LN} Test voltage

¹ Adapter AT3-III, AT3-IIS or AT3-II S32:

Voltage measuring inputs for leakage current measurement with differential method with **SECUTEST PRO** only (or instrument with feature I01)

² Voltage measuring inputs for leakage current measurement with differential method and use of a current cleanup sensor with **SECUTEST PRO** only (or an instrument with feature I01)

Applications

Protective conductor current must be measured for protection category I devices.

Definition of Protective Conductor Current (direct measurement)

Current which flows through the protective conductor in the case of housings which are isolated from ground.

Definition of Differential Current

Sum of instantaneous current values which flow via the L and N conductors at the device's mains connection. Differential current is practically identical to fault current in the event of an error. Fault current: current which is caused by an insulation defect, and which flows via the defective point.

Definition of Alternative Measuring Method (equivalent leakage current)

Equivalent leakage current is current which flows through the active conductors of the device which are connected to each other (L/N) to the protective conductor (SC1), or to the exposed, conductive parts (SC2).

Differential Current Measuring Method

The device under test is operated with mains power. The sum of the momentary values of all currents which flow through all active conductors (L/N) at the mains side of the device connection is measured. The measurements must be performed with mains polarity in both directions.

Alternative Measuring Method (equivalent leakage current)

A high-impedance power supply is connected between the short-circuited mains terminals and all exposed metal parts of the housing (which are connected to one another). Current which flows over the insulation at the device under test is measured.

Protective Conductor Current Measuring Method (Direct Measurement)

The device under test is operated with mains power. Current which flows through the PE conductor to earth at the mains side of the device connection is measured.



Note

Regardless of the currently selected connection type, all help images and schematic diagrams can be queried for the selected measuring function.

Direct Measuring Method

– *Direct measurement type*

– DUT mains plug to test socket

Schematic Diagram

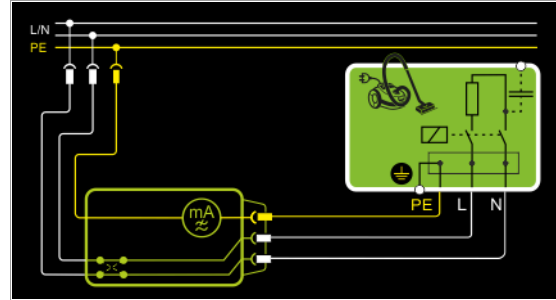

The device under test is operated with mains power. Protective conductor current is measured between the protective conductor at the mains and the protective conductor terminal at the DUT via the DUT's mains cable.

Wiring Diagram

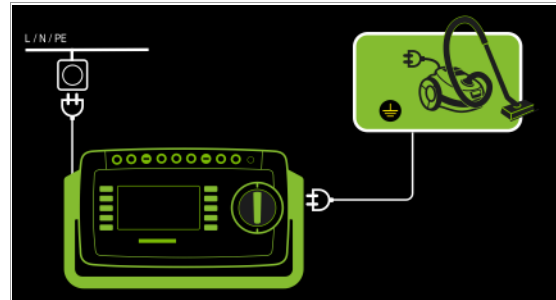

Differential current measurement

– *Differential measurement type*

– DUT mains plug to test socket

Schematic Diagram

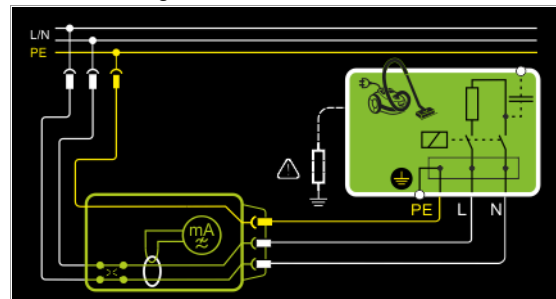

The device under test is operated with mains power. Differential current is measured between mains conductors L and N (current clip concept).

Wiring Diagram

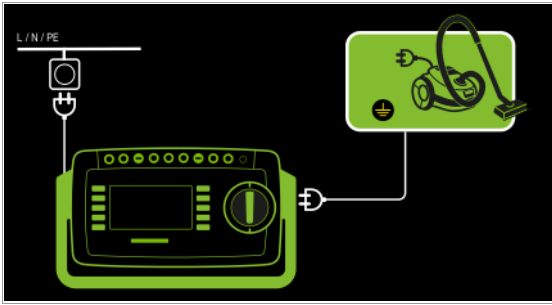

Alternative Measuring Method (equivalent leakage current)

- *Alternative measurement type*
- DUT mains plug (protection category I) to test socket

Schematic Diagram

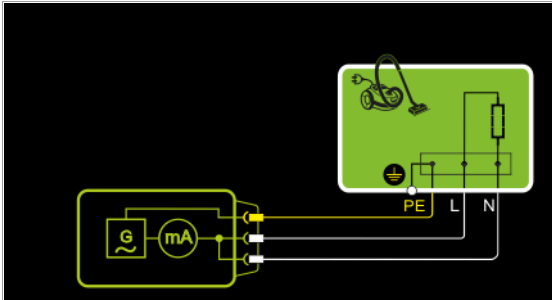

After activating test voltage, leakage current is measured via the DUT's mains cable between short-circuited mains conductors L and N and the protective conductor terminal at the DUT.

Wiring Diagram

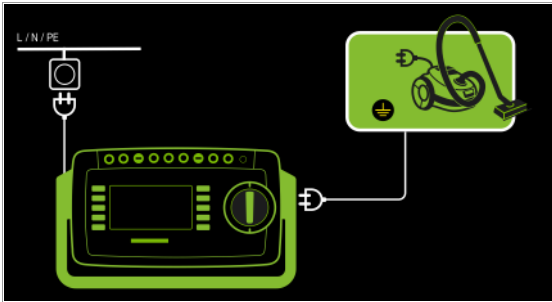

Connection of 3-phase DUTs (only with SECUTEST PRO or feature I01 with optional test adapter AT3-IIIE)

- *AT3-Adapter Measurement type*
- DUT mains plug to AT3-IIIE test adapter
- AT3-IIIE probe to COM-V terminals
- AT3-IIIE test plug to test socket

Schematic Diagram

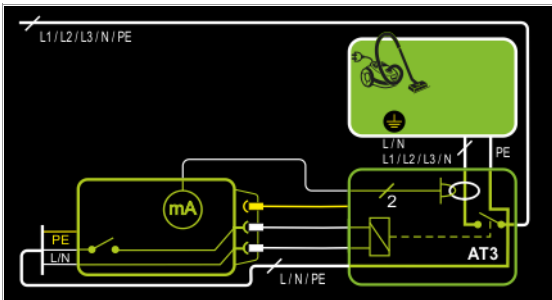

Measurement of the DUT with 3-phase mains connection via AT3-IIIE adapter

Wiring Diagram (AT3-IIIE probe to COM-V)

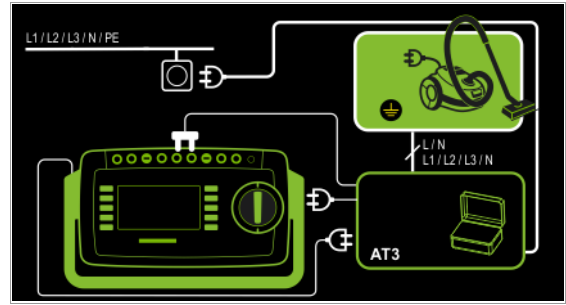

Measurement of protective conductor current via current clamp sensor with voltage output for permanently installed DUTs (only with SECUTEST PRO or feature I01 with optional current clamp sensor)

- *Clamp measurement type*

Schematic Diagram

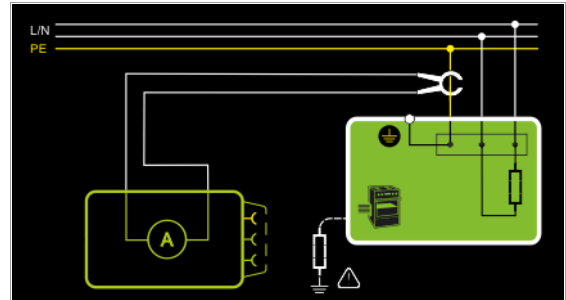

Measurement of protective conductor current by closing the current clamp sensor around mains cable PE for permanently installed protection category I devices under test

Wiring Diagram (current clamp sensor to COM-V)

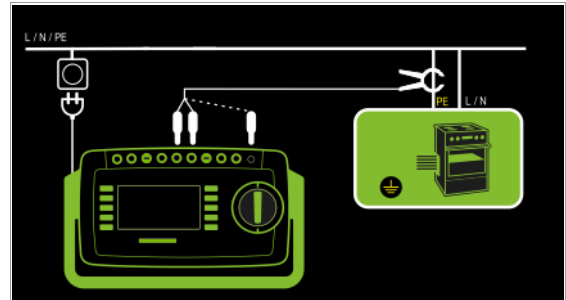

Set Measuring Range at Current Clamp Sensor and Parameter at the SECUTEST PRO

SECUTEST PRO Transformation Ratio Parameter	Clamp		SECUTEST PRO Display Range with Clamp
	Transformation Ratio (switch *)	Measuring Range	
1 mV : 1 mA	WZ12C		0 mA ... 300 A
	1 mV : 1 mA	1 mA ... 15 A	
100 mV : 1 mA	SECUTEST CLIP		0.00 mA ... 3.00 A
	100 mV : 1 mA	0.1 ... 25 mA	

* Only with WZ12C







** Default value

Setting Measuring Parameters for IPE



Measuring Parameter	Meaning	
Measurement Type		Suitable for DUT Connection via
Direct	Direct measuring method	Test socket, AT16DI/AT32DI (direct or diff.)
Differential	Differential current measurement	Test socket
Alternative	Equivalent leakage current method	Test socket, VL2E, AT3 adapter (AT3-IIIE, AT3-IIS, AT3-IIS32), AT16DI/AT32DI
AT3 adapter	SECUTEST PRO or feature I01: measurement with AT3 adapter	AT3-IIIE, AT3-IIS, AT3-IIS32
Clamp	SECUTEST PRO or feature I01: Measurement of protective conductor current via current clamp sensor with voltage output, and conversion to and display as current values.	Permanent connection
Polarity – for direct and differential measurement type only		
L/N or N/L	Selection of polarity for mains voltage to the test socket	
<p>The U (setpoint) and frequency (setpoint) measuring parameters for the “Alternative” measurement type are no longer included as of firmware version 1.7.0. These parameters apply to individual measurements as well as test sequences and have to be entered in SETUP (see section section 6.2).</p>		
U(set) – for alternative measurement type only		
110 V, 115 V, 220 V, 230 V, 240 V	Selection of a line voltage for synthetic test voltage	
Frequency(set) – for alternative measurement type only		
48 Hz ... 400 Hz	Selection of a line frequency for synthetic test voltage	
Clamp factor – only for clamp measurement type		
1 mV : 1 mA	Transformation ratio of the WZ12C current clamp sensor. For setting the current clamp factor at the WZ12C clamp and the SECUTEST PRO (see table above).	
10 mV : 1 mA		
100 mV:1 mA	Transformation ratio of the SECUTEST CLIP current clamp sensor. For setting the current clamp factor at the SECUTEST PRO .	
1 V : 1 A		

Test Sequence for Direct Measuring Method

- ⊘ Before conducting any leakage current measurements, make sure that the “Ref. voltage L-PE” and “Testingfreq. Alt” measurement parameters have been correctly set in SETUP (see section 6.2).
- ⊘ Set the rotary switch to the **I_{PE}** position.
- ⊘ Select the **Direct** measurement type:
 - By setting the parameters or
 - Directly via the **Measurement Type** key 
- ⊘ Connect the DUT's mains plug (protection category I) to the test instrument's test socket.
- ⊘ Make sure that the device under test is switched off.
- ⊘ **Start the test:** press the **START/STOP** key. 
- ⊘ Switch the device under test on.
- ⊘ The measurement must be performed with mains plug polarity in both directions by pressing the **NL/LN** key. 
- ⊘ Acknowledge the warning which indicates that line voltage will be connected to the test socket.
- ⊘ Switch the device under test on.
- ⊘ Contact all accessible conductive parts, one after the other, with test probe P1, which are not connected to the housing, as well as any output sockets for safety extra-low voltage if included.
- ⊘ The measured values are displayed. The measured value recording symbol shown at the right appears. Each time this key is pressed, the currently displayed measured value is saved to buffer memory. 
- ⊘ Turn off the device under test.
- ⊘ **End the test:** press the **START/STOP** key. The save symbol appears (floppy disk showing the number of measured values stored to buffer memory) and prompts you to save the measured values to an ID number. 

- ⊘ Read the measured values and compare them with the table of permissible limit values.
- ⊘ Press the **ESC** key in order to discard the measured values stored to buffer memory and acknowledge by pressing the key shown at the right. 









Test Sequence with AT3-IIIE Adapter



Attention!

Please observe the operating instructions for the AT3-IIIE regarding correct connection of the test adapter and the device under test, as well as peculiarities involved in the test sequence.

Test Sequence with Differential Current Method

- ⇨ Before conducting any leakage current measurements, make sure that the “Ref. voltage L-PE” and “Testingfreq. Alt” measurement parameters have been correctly set in SETUP (see section 6.2).
- ⇨ Set the rotary switch to the I_{PE} position.
- ⇨ Select the **Differential** measurement type:
 - By setting the parameters
 - or
 - Directly via the **Measurement Type** key 
- ⇨ Connect the test object’s mains plug (protection category I) to the test instrument’s test socket.
- ⇨ **Start the test:** press the **START/STOP** key. 
- ⇨ The measurement must be performed with mains plug polarity in both directions by pressing the **NL/LN** key. 
- ⇨ Acknowledge the warning which indicates that line voltage will be connected to the test socket. 
- ⇨ Switch the device under test on.
- ⇨ The measured values are displayed. The measured value recording symbol shown at the right appears. Each time this key is pressed, the currently displayed measured value is saved to buffer memory. 
- ⇨ Turn off the device under test.
- ⇨ **End the test:** press the **START/STOP** key. The save symbol appears (floppy disk showing the number of measured values stored to buffer memory) and prompts you to save the measured values to an ID number. 

- ⇨ Read the measured values and compare them with the table of permissible limit values.
- ⇨ Press the **ESC** key in order to discard the measured values stored to buffer memory and acknowledge by pressing the key shown at the right. 

Maximum Permissible Limit Values for Leakage Current in mA

Test Standard	I_{PE}
VDE 0701-0702:2008	PC I: 3.5 1 mA/kW *
DIN EN 60974-4 VDE 0544-4:2017-05	5 mA

* For devices with heating power of greater than 3.5 kW

Note 1: Devices which are not equipped with accessible parts that are connected to the protective conductor, and which comply with requirements for touch current and, if applicable, patient leakage current, e.g. computer equipment with shielded power pack







Note 2: Permanently connected devices with protective conductor

Note 3: Portable X-ray devices with mineral insulation

Key

I_{PE} Current in the protective conductor (primary leakage current)

Test Sequence for Alternative Measuring Method

- ⇨ Before conducting any leakage current measurements, make sure that the “Ref. voltage L-PE” and “Testingfreq. Alt” measurement parameters have been correctly set in SETUP (see section 6.2).
- ⇨ Set the rotary switch to the I_{PE} position.
- ⇨ Select the **Alternative** measurement type:
 - By setting the parameters
 - or
 - Via the **Measurement Type** key 
- ⇨ Connect the DUT’s mains plug (protection category I) to the test instrument’s test socket.
- ⇨ **Start the test:** press the **START/STOP** key. 
- ⇨ Switch the device under test on.
- ⇨ The measured values are displayed. The measured value recording symbol shown at the right appears. Each time this key is pressed, the currently displayed measured value is saved to buffer memory. 
- ⇨ **End the test:** press the **START/STOP** key. The save symbol appears (floppy disk showing the number of measured values stored to buffer memory) and prompts you to save the measured values to an ID number. 

- ⇨ Read the measured values and compare them with the table of permissible limit values.
- ⇨ Press the **ESC** key in order to discard the measured values stored to buffer memory and acknowledge by pressing the key shown at the right. 

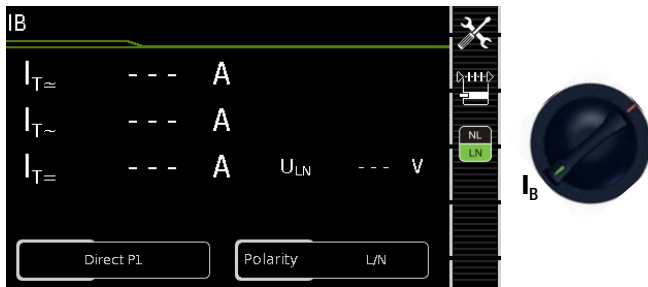
8.7.2 Touch Current – IB



Single measurements, rotary switch level: green

Switch Position	Measurement Type, with Mains to Test Socket	Measurement Type, without Mains to Test Socket	Measuring Functions
IB	Direct P1		$I_{T \approx}$ Touch current, TRMS $I_{T \sim}$ AC component $I_{T =}$ DC component U_{LN} Test voltage
	Differential P1		$I_{T \approx}$ Touch current, TRMS U_{LN} Test voltage
	Alternative P1		$I_{T \approx}$ Touch current, TRMS U_{LN} Test voltage
	Permanently connected P1		$I_{T \approx}$ Touch current, TRMS $I_{T \sim}$ AC component $I_{T =}$ DC component
	Alternative P1–P2		$I_{T \approx}$ Touch current, TRMS U_{LN} Test voltage

Applications

Make sure that the contacted parts are not grounded.

Definition

Current which flows from housing parts which are not connected to the protective conductor via an external conductive connection to earth or another part of the housing. Flow of current via the protective conductor is excluded in this case.

The following designations are also common:
housing leakage current, probe current.

Direct measuring method

- Measurement type *direct P1*
- DUT mains plug to test socket
- Test probe P1 to P1 terminals

Schematic Diagram

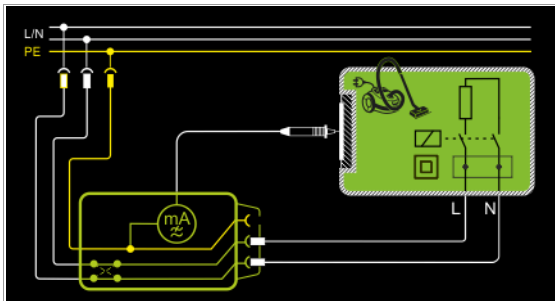

The device under test is operated with mains power. Current which flows to the protective conductor via exposed conductive parts is measured by means of the probe. The measurements must be performed with mains plug polarity in both directions. Polarity is reversed with the **NL/LN** key. The TRMS, the AC or the DC component of the current is measured.

Wiring Diagram

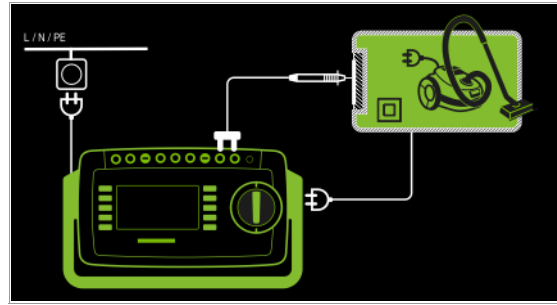

Note

regarding protection category I DUTs:

Parts may or may not be grounded.

Coincidental grounding only occurs in the event of an error.

Differential Current Method

- Measurement type *differential P1*
- DUT mains plug to test socket
- Test probe P1 to P1 terminals

Schematic Diagram

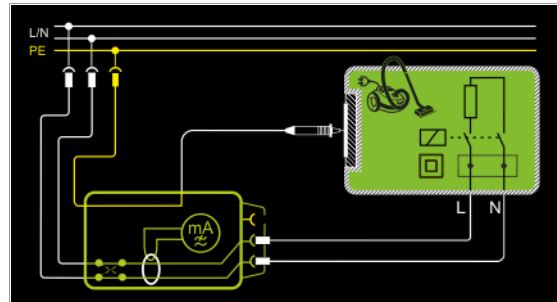

The device under test (PC2) is operated with mains power. Differential current which flows via the two mains conductors is measured (current clamp measurement concept). The measurements must be performed with mains plug polarity in both directions. Polarity is reversed with the **NL/LN** key. The current's AC component is measured. Accessible conductive parts must be contacted with test probe P1.

Wiring Diagram

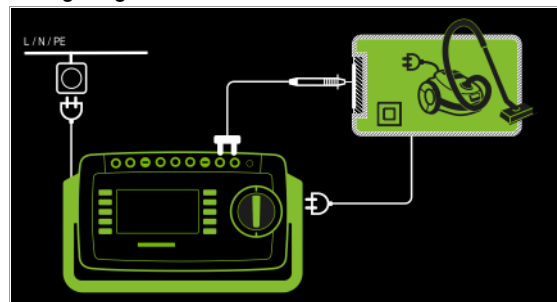

Alternative Measuring Method (equivalent leakage current)

- *Measurement type alternative P1*
- DUT mains plug to test socket
- Test probe P1 to P1 terminals

Schematic Diagram

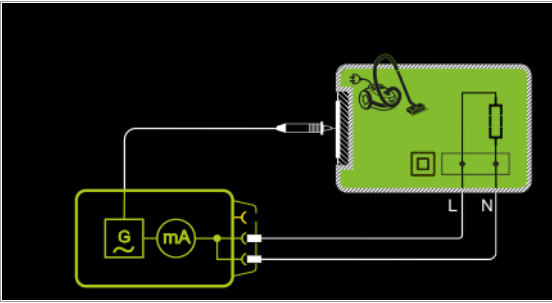

After activating test voltage, leakage current is measured between short-circuited mains conductors L and N (DUT mains plug) and accessible conductive parts (probe contact). The TRMS, the AC or the DC component of the current is measured.

Wiring Diagram

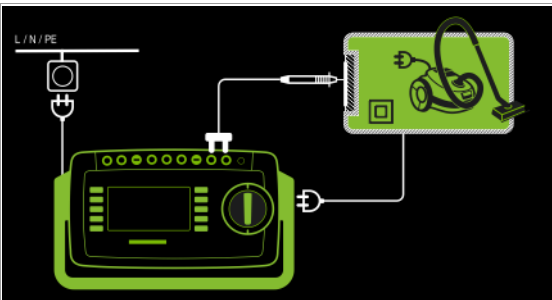

Direct Measuring Method for Permanently Installed DUTs

- *Measurement type permanent connection P1*
- Test probe P1 to P1 terminals

Schematic Diagram

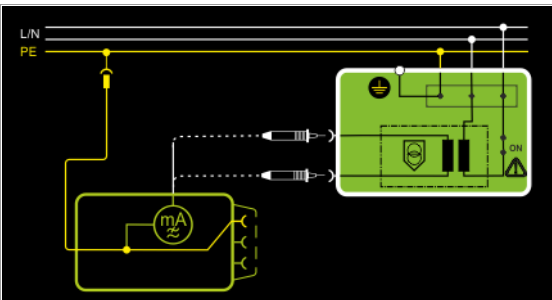

The DUT is operated with line voltage from a permanent installation. Leakage current is measured between the protective conductor at the mains and the output sockets for safety extra-low voltage at the DUT, one after the other, with the help of the test probe. Furthermore, accessible, conductive parts which are **not** connected to the housing must also be contacted.

Wiring Diagram

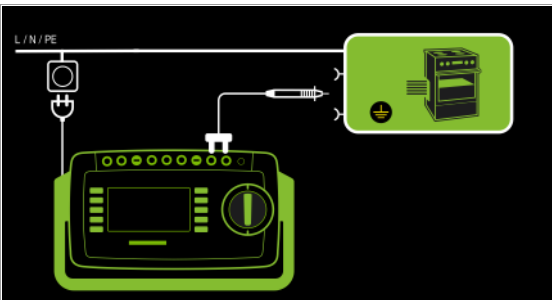

Alternative measuring method with 2-pole measurement (P1–P2)

- *Alternative measurement type (P1 - P2)*
- Test probe P1 to P1 terminals
- Test probe P2 to P2 terminals

Schematic Diagram

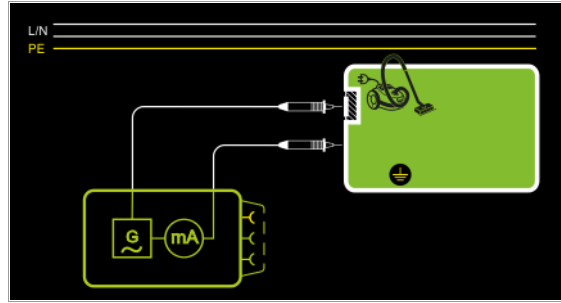

Touch current is measured between external conductive parts which can be contacted with test probe P2 and are **not** connected to the housing, and the housing with test probe P1.

Wiring Diagram

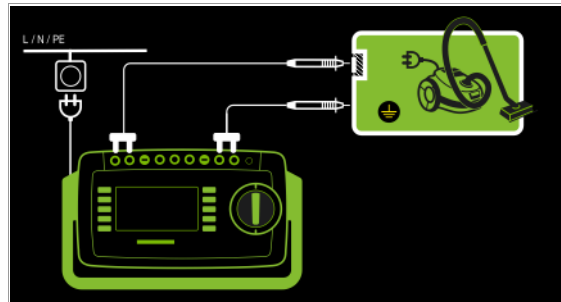

Setting Measuring Parameters for IT



Measuring Parameter	Meaning	
Measurement Type		Suitable for DUT Connection via
Direct P1	Direct measuring method	Test socket, AT3 adapter (AT3-IIE, AT3-IIS, AT3-IIS32), AT16DI/AT32DI
Differential P1	Differential current measurement	Test socket
Alternative P1	Equivalent leakage current method	Test socket, AT3 adapter (AT3-IIE, AT3-IIS, AT3-IIS32), AT16DI/AT32DI, VL2E
Permanently connected P1	Permanently installed DUT	Permanent connection
Alternative P1–P2	Equivalent leakage current method with SECUTEST PRO or feature H01	No connection, PC3: 2-pole measurement between test probes 1 and 2 (see section 6.6)
Polarity – for direct and differential measurement type only		
L/N or N/L	Selection of polarity for mains voltage to the test socket	
<p>The U (setpoint) and frequency (setpoint) measuring parameters for the “Alternative” measurement type are no longer included as of firmware version 1.7.0. These parameters apply to individual measurements as well as test sequences and have to be entered in SETUP (see section section 6.2).</p> <p>U(set) – for measurement type alternative P1 only</p> <p>110 V, 115 V, 220 V, 230 V, 240 V Selection of a line voltage for synthetic test voltage</p> <p>Frequency(set) – for measurement type alternative P1 only</p> <p>48 Hz ... 400 Hz Selection of a line frequency for synthetic test voltage</p>		

Direct Selection – Setting Polarity – for Direct and Differential Only



Measuring Parameter	Meaning
Measurement Type	
L/N or N/L	Selection of polarity for mains voltage to the test socket

Prerequisites for Touch Current Measurement

- Visual inspection has been passed.
- For protection category I devices
Protective conductor resistance testing has been passed.
- Insulation resistance testing has been passed.

Test Sequence for Direct and Differential Current Methods

- ⇨ Before conducting any leakage current measurements, make sure that the “Ref. voltage L-PE” and “Testingfreq. Alt” measurement parameters have been correctly set in SETUP (see section 6.2).
- ⇨ Set the rotary switch to the I_B position.
- ⇨ Select measurement type **Direct P1** or **Differential P1**:
 - By setting the parameters
 - or
 - Via the **Measurement Type** key
- ⇨ In the case of **direct and differential current measurement**, measurement must be performed with mains plug polarity in both directions. Select the respective polarity to this end by pressing the **NL/LN** key.
- ⇨ Connect the DUT’s mains plug (protection category II) to the test instrument’s test socket.



Attention!

Testing is conducted in the presence of line voltage.

- ⇨ **Start the test:** press the **START/STOP** key.
- ⇨ Acknowledge the warning which indicates that line voltage will be connected to the test socket.
- ⇨ Switch the device under test on.
- ⇨ Contact all accessible conductive parts, one after the other, which are not connected to the housing with test probe P1.
- ⇨ The measured values are displayed. The measured value recording symbol shown at the right appears. Each time this key is pressed, the currently displayed measured value is saved to buffer memory.
- ⇨ Turn off the device under test.
- ⇨ **End the test:** press the **START/STOP** key. The save symbol appears (floppy disk showing the number of measured values stored to buffer memory) and prompts you to save the measured values to an ID number.
- ⇨ Read the measured values and compare them with the table of permissible limit values.
- ⇨ Press the **ESC** key in order to discard the measured values stored to buffer memory and acknowledge by pressing the key shown at the right.

Test Sequence for Alternative Measuring Method

- ⇨ Before conducting any leakage current measurements, make sure that the “Ref. voltage L-PE” and “Testingfreq. Alt” measurement parameters have been correctly set in SETUP (see section 6.2).
- ⇨ Set the rotary switch to the I_B position.
- ⇨ Select measurement type **Alternative P1** or **Alternative P1–P2** (feature H01):
 - By setting the parameters
 - or
 - Directly via the **Measurement Type** key
- ⇨ Connect the DUT’s mains plug (protection category II) to the test instrument’s test socket.
- ⇨ **Start the test:** press the **START/STOP** key.
- ⇨ Contact all accessible conductive parts, one after the other, which are not connected to the housing with test probe P1.
- ⇨ The measured values are displayed. The measured value recording symbol shown at the right appears. Each time this key is pressed, the currently displayed measured value is saved to buffer memory.
- ⇨ **End the test:** press the **START/STOP** key. The save symbol appears (floppy disk showing the number of measured values stored to buffer memory) and prompts you to save the measured values to an ID number.
- ⇨ Read the measured values and compare them with the table of permissible limit values.
- ⇨ Press the **ESC** key in order to discard the measured values stored to buffer memory and acknowledge by pressing the key shown at the right.

Maximum Permissible Limit Values for Leakage Current in mA

Test Standard	I_T
VDE 0701-0702:2008	0.5
DIN EN 60974-4 VDE 0544-4:2017-05	10 mA

Key

I_T Touch current (leakage current from welding current)

8.7.3 Device Leakage Current – IG

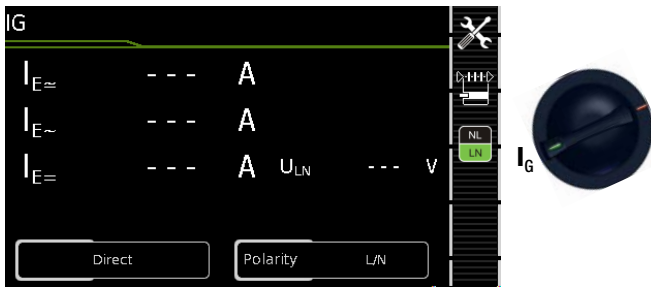

Single measurements, rotary switch level: green

Switch Position	Measurement Type, with Mains to Test Socket	Measurement Type, without Mains to Test Socket	Measuring Functions
I _G	Direct		I _{E~} Device leakage current, TRMS I _{E~} AC component I _{E~} DC component U _{LN} Test voltage
		Differential	I _{E~} Device leakage current, TRMS U _{LN} Test voltage
	Alternative		I _{E~} Device leakage current, TRMS U _{LN} Test voltage
		AT3 adapter ¹	I _{E~} Device leakage current, TRMS U _{LN} Test voltage
	Clamp ²	I _{E~} Device leakage current, TRMS U _{LN} Test voltage	

¹ Adapter AT3-III, AT3-IIS or AT3-II S32:

Voltage measuring inputs for leakage current measurement with differential method with SECUTEST PRO only (or instrument with feature I01)

² Voltage measuring inputs for leakage current measurement with differential method and use of a current cleanup sensor with SECUTEST PRO only (or an instrument with feature I01)

Applications

Measurement of device leakage current is required for medical electric devices in accordance with IEC 62353 (VDE 0751-1).

In the case of device leakage current as the sum of all leakage current, all probe contact points must be contacted simultaneously.

Definition

Device leakage current is the sum of all leakage currents from the housing, accessible conductive parts and applied parts to PE.

Direct Measuring Method

- Direct measurement type
- DUT mains plug to test socket
- Test probe P1 to P1 terminals

Schematic Diagram

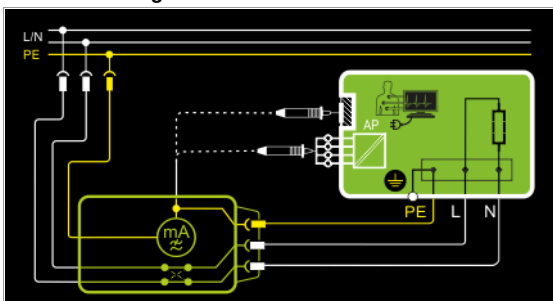

The device under test (PC1) is operated with mains power. Protective conductor current is measured between the protective conductor at the mains (test instrument supply power) and the protective conductor terminal at the DUT via the DUT's mains cable. The measurements must be performed with mains plug polarity in both directions. Polarity is reversed with the **NL/LN** key. Accessible conductive parts which are connected to the housing, as well as those which are not connected to the housing, must be contacted with test probe P1.

If the DUT includes terminals for applied parts, they must be short-circuited and contacted with test probe P1 as well.

Wiring Diagram

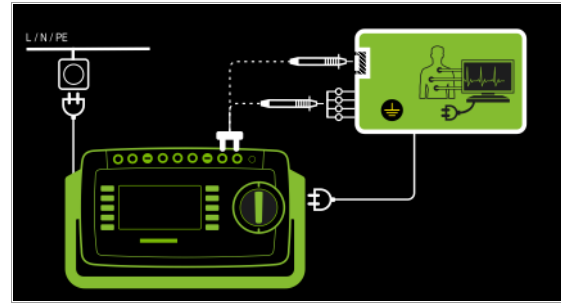

Differential current measurement

- Differential measurement type
- DUT mains plug to test socket
- Test probe P1 to P1 terminals

Schematic Diagram, Protection Category I

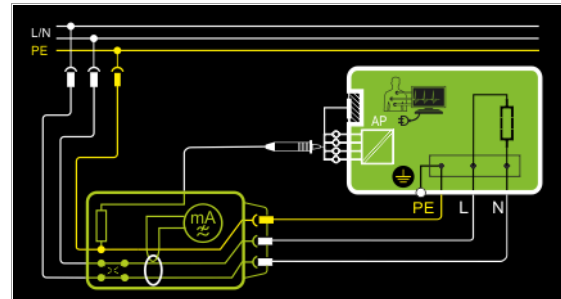

The device under test (PC1) is operated with mains power. Differential current which flows via the two mains conductors is measured (current clamp measurement concept). The measurements must be performed with mains plug polarity in both directions. Polarity is reversed with the **NL/LN** key.

Short-circuited terminals for applied parts or accessible conductive parts which are not connected to the housing must be contacted with test probe P1.

Wiring Diagram, Protection Category I

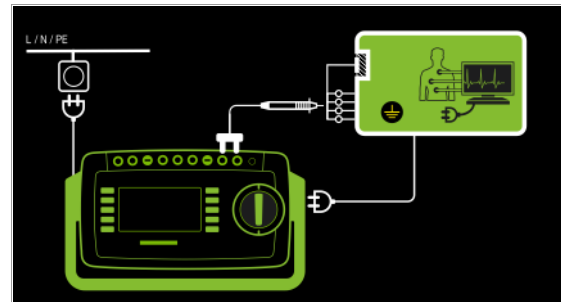

Wiring Diagram, Protection Category II

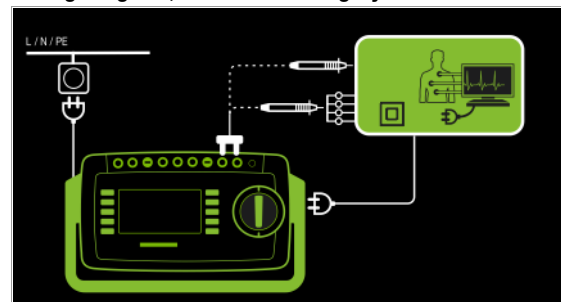

Alternative Measuring Method (equivalent leakage current)

- *Alternative Measurement Type (P1)*
- DUT mains plug connected to the test socket
- Test probe P1 to P1 terminals

Schematic Diagram, Protection Category I

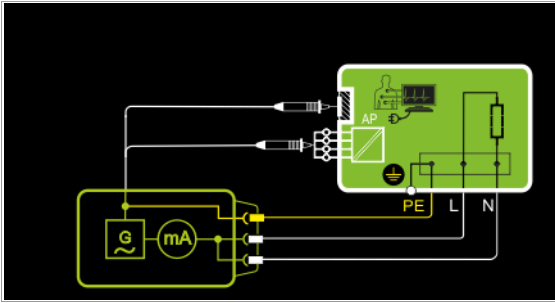

After activating test voltage, leakage current is measured between short-circuited mains conductors L and N (DUT mains plug) and accessible conductive parts (probe contact) which **are not connected to the housing**.

If the DUT includes terminals for applied parts, they must be short-circuited and contacted with test probe P1 as well.

Wiring Diagram, Protection Category I

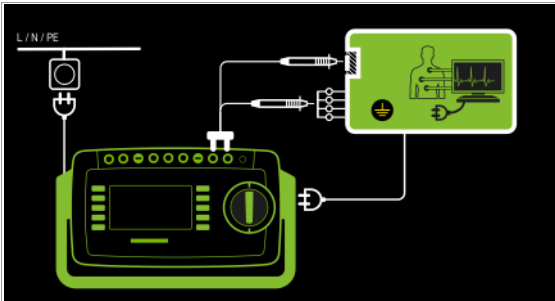

Differential current measurement

- *AT3-Adapter Measurement type*
- DUT mains plug to AT3-IIIIE test adapter
- Test probe P1 to P1 terminals
- AT3-IIIIE probe to COM-V terminals
- AT3-IIIIE test plug to test socket

Schematic Diagram

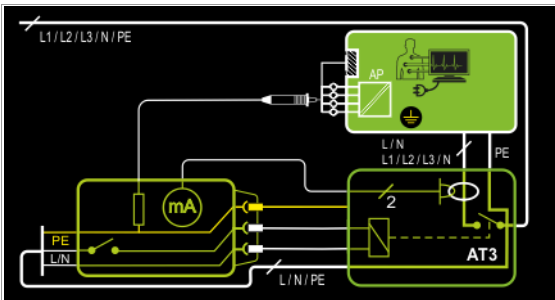

Measurement at the DUT with 3-phase mains connection via AT3-IIIIE adapter

Wiring Diagram

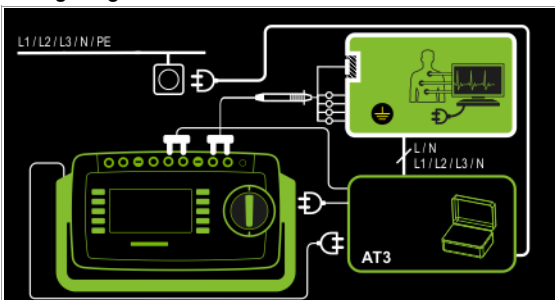

Measurement Method with Current Clamp Sensor for Permanently Installed DUTs

- *Clamp measurement type*
- Clamp to COM-V (only with SECUTEST PRO or feature IO1 with optional current clamp sensor)

Schematic Diagram

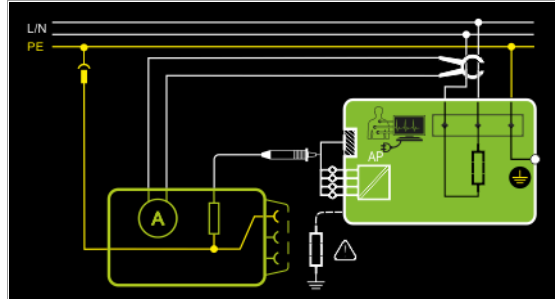

Measurement of device leakage current by closing the current clamp sensor around the L and N conductors of the mains cable for permanently installed protection category I devices under test

Wiring Diagram

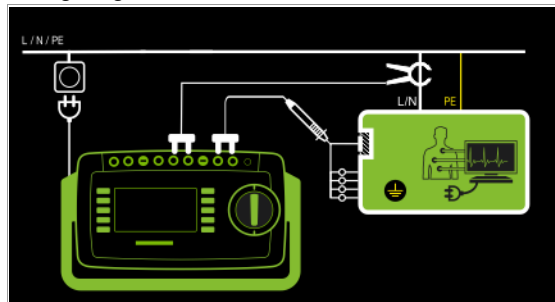

Set Measuring Range at Current Clamp Sensor and Parameter at the SECUTEST PRO

SECUTEST PRO Transformation Ratio Parameter	Clamp		SECUTEST PRO Display Range with Clamp
	Transformation Ratio (switch *)	Measuring Range	
1 mV : 1 mA	WZ12C		0 mA ... 300 A
	1 mV : 1 mA	1 mA ... 15 A	
100 mV : 1 mA	SECUTEST CLIP		0.00 mA ... 3.00 A
	100 mV : 1 mA	0.1 ... 25 mA	

* Only with WZ12C

** Default value

Setting Measuring Parameters for IE



Measuring Parameter	Meaning	
Measurement Type		Suitable for DUT Connection via
Direct	Direct measuring method, optional probe contact	Test socket, AT16DI/AT32DI (only diff. is sensible)
Differential	Differential current measurement	Test socket
Alternative	Equivalent leakage current measuring method with probe contact	Test socket, AT16DI/AT32DI
AT3 adapter	SECUTEST PRO or feature I01: measurement with AT3 adapter	AT3-IIIE, AT3-IIS, AT3-IIS32
Clamp	SECUTEST PRO or feature I01: Measurement of device leakage current via current clamp sensor with voltage output, and conversion to and display as current values.	Permanent connection
Polarity ¹ – for direct, differential and AT3 adapter measurement types only		
L/N or N/L	Selection of polarity for mains voltage to the test socket	
The U (setpoint) and frequency (setpoint) measuring parameters for the “Alternative” measurement type are no longer included as of firmware version 1.7.0. These parameters apply to individual measurements as well as test sequences and have to be entered in SETUP (see section section 6.2).		
U(set) – for alternative measurement type only		
110 V, 115 V, 220 V, 230 V, 240 V	Selection of a line voltage for synthetic test voltage	
Frequency(set) – for alternative measurement type only		
48 Hz ... 400 Hz	Selection of a line frequency for synthetic test voltage	
Clamp factor – only for clamp measurement type		
1 mV : 1 mA	Transformation ratio of the WZ12C current clamp sensor. For setting the current clamp factor at the WZ12C clamp and the SECUTEST PRO (see table above).	
10 mV : 1 mA		
100 mV:1 mA	Transformation ratio of the SECUTEST CLIP current clamp sensor. For setting the current clamp factor at the SECUTEST PRO .	
1 V : 1 A		

¹ Measurement must be performed with mains polarity in both directions. The largest value is documented

Test Sequence

- Before conducting any leakage current measurements, make sure that the “Ref. voltage L-PE” and “Testingfreq. Alt” measurement parameters have been correctly set in SETUP (see section 6.2).
- Set the rotary switch to the **I_G** position.
- Connect the DUT in accordance with the selected measuring method.
- Select the measurement type:
 - By setting the parameters
 - or
 - Directly via the **Measurement Type** key
- As an alternative, you can select the measurement type directly using the key shown at the right.
- In the case of **direct and differential current measurement**, measurement must be performed with mains plug polarity in both directions. Select the respective polarity to this end by pressing the **NL/LN** key.
- Start the test: press the **START/STOP** key.
- After each reconnection to the mains, and as soon as the first test is started, a mains connection test is executed.
- **In the case of the direct or differential measurement type:** Acknowledge the warning which indicates that line voltage will be connected to the test socket.
- Switch the device under test on.
- The measured values are displayed. The measured value recording symbol shown at the right appears. Each time this key is pressed, the currently displayed measured value is saved to buffer memory.
- Turn off the device under test.
- **End the test:** press the **START/STOP** key. The save symbol appears (floppy disk showing the number of measured values stored to buffer memory) and prompts you to save the measured values to an ID number.
- Read the measured values and compare them with the table of permissible limit values.
- Press the **ESC** key in order to discard the measured values stored to buffer memory and acknowledge by pressing the key shown at the right.

Test Sequence with AT3-IIIE Adapter



Attention!

Please observe the operating instructions for the AT3-IIIE regarding correct connection of the test adapter and the device under test, as well as peculiarities involved in the test sequence.

Maximum Permissible Limit Values for Equivalent Leakage Current in mA

Test Standard	I _{GA}	I _{EDL}
VDE 0701-0702	PC I: 3.5 / 1 mA/kW ¹ PC II: 0.5	
IEC 62353 (VDE 0751-1)		PC II 0.2 ²
		PC I (PE or parts connected to PE) 1
		Permanently connected devices with PE 10
		Portable x-ray devices with additional PE 5
		Portable x-ray devices without additional PE 2
		Devices with mineral insulation 5

I_{GA} Device leakage current
I_{EA} Equivalent leakage current
PE Protective conductor

¹ For devices with heating power ≥ 3.5 kW

² This limit value is not taken into consideration in the DIN EN 62353 (VDE 0751-1) standard.

8.7.4 Leakage Current from the Applied Part – IA

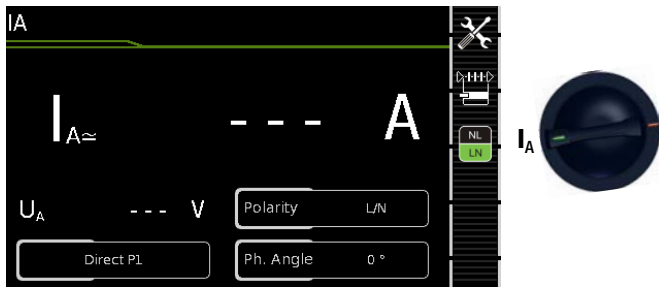

Single measurements, rotary switch level: green

Switch Position	Measurement Type, with Mains to Test Socket	Measurement Type, without Mains to Test Socket	Measuring Functions
IA	Direct P1		IA ≈ UA Current from the applied part Test voltage
		Alternative P1 Permanently connected P1	

Direct measuring method

- Measurement type direct P1
- DUT Mains Plug (PC1) Connected to Test Socket
- Probe to P1 Terminal

Schematic Diagram

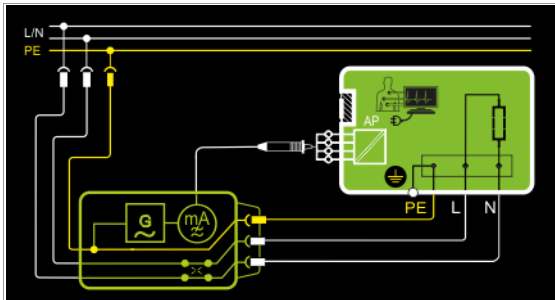

The device under test (PC1) is operated with mains power. The measurements must be performed with mains plug polarity in both directions. Polarity is reversed with the **NL/LN** key. After activating **test voltage** and **line voltage**, leakage current from the application part is measured between the short-circuited terminals of the applied parts and PE (DUT mains plug).

Wiring Diagram

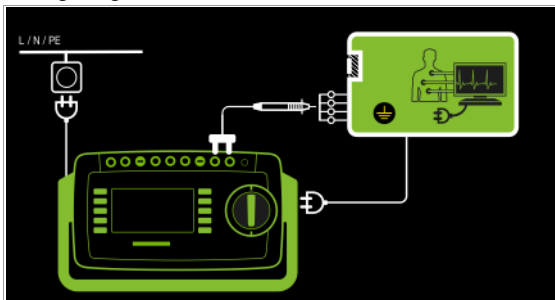

Alternative Measuring Method (equivalent patient leakage current)

- Measurement type alternative P1
- DUT Mains Plug (PC1) Connected to Test Socket
- Probe to P1 Terminal

Schematic Diagram

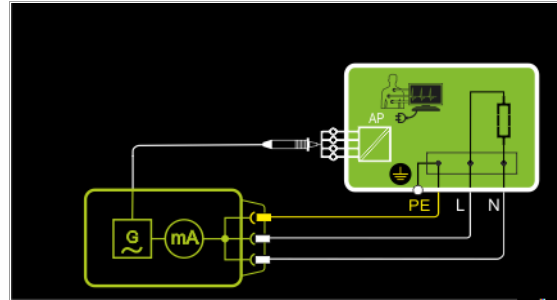

After activating test voltage, leakage current from the application part is measured between short-circuited conductors L-N-PE (DUT mains plug) and the short-circuited terminals of the applied parts.

Wiring Diagram

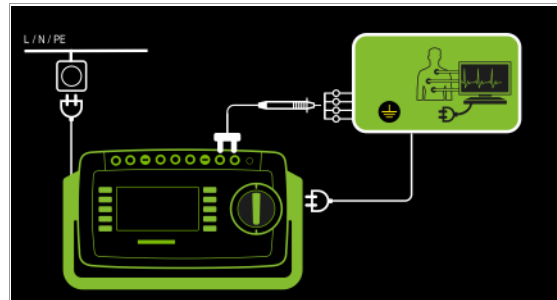

Direct measuring method

- Measurement type permanent connection P1
- Permanent Connection
- Probe to P1 Terminal

Schematic Diagram

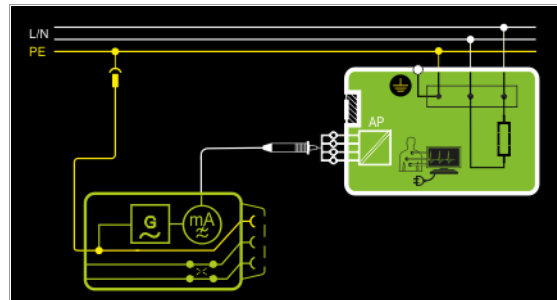

Leakage current from the application part is measured between the short-circuited terminals of the application parts and PE at the mains connection.

Wiring Diagram

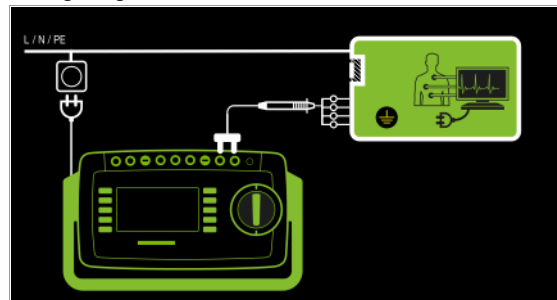



Measuring Parameter	Meaning
Measurement Type	
Direct P1	Direct measuring method (via test socket) with test probe P1
Alternative P1	Equivalent leakage current measuring method (via test socket) with test probe P1
Permanently connected P1	Direct measuring method
Suitable for DUT Connection via	
	Test socket, AT3 adapter (AT3-III E, AT3-III S, AT3-III S2), AT16DI/AT32DI
	Test socket
	Permanent connection
Phase angle – for direct P1 and permanent connection P1 only	
0° or 180°	Selectable phasing for the internal generator relative to mains phasing
Polarity – for direct P1 only	
L/N or N/L	Selection of polarity for mains voltage to the test socket
<p>The U (setpoint) and frequency (setpoint) measuring parameters for the “Alternative” measurement type are no longer included as of firmware version 1.7.0. These parameters apply to individual measurements as well as test sequences and have to be entered in SETUP (see section section 6.2).</p>	
U(set) – for alternative (P1) and permanent connection (P1) only	
110 V, 115 V, 220 V, 230 V, 240 V	Selection of a line voltage for synthetic test voltage
Frequency(set) – for alternative P1 only	
48 Hz ... 400 Hz	Selection of a line frequency for synthetic test voltage

Test Sequence

- ⊘ Before conducting any leakage current measurements, make sure that the “Ref. voltage L-PE” and “Testingfreq. Alt” measurement parameters have been correctly set in SETUP (see section 6.2).
- ⊘ Set the rotary switch to the **I_A** position.
- ⊘ Connect the DUT in accordance with the selected measuring method.
- ⊘ Select the measurement type:
 - By setting the parameters
 - or
 - Directly via the **Measurement Type** key
- ⊘ In the case of **direct measurement**, measurement must be performed with mains plug polarity in both directions. Select the respective polarity to this end by pressing the **NL/LN** key.
- ⊘ **Start the test:** press the **START/STOP** key.
- ⊘ After each reconnection to the mains, and as soon as the first test is started, a mains connection test is executed.
- ⊘ – **Measurement type direct P1** Acknowledge the warning which indicates that line voltage will be connected to the test socket.
- ⊘ Switch the device under test on.
- ⊘ Contact the short-circuited applied parts with the test probe.
- ⊘ The measured values are displayed. The measured value recording symbol shown at the right appears. Each time this key is pressed, the currently displayed measured value is saved to buffer memory.
- ⊘ Turn off the device under test.
- ⊘ **End the test:** press the **START/STOP** key. The save symbol appears (floppy disk showing the number of measured values stored to buffer memory) and prompts you to save the measured values to an ID number.
- ⊘ Read the measured values and compare them with the table of permissible limit values.
- ⊘ Press the **ESC** key in order to discard the measured values stored to buffer memory and acknowledge by pressing the key shown at the right.

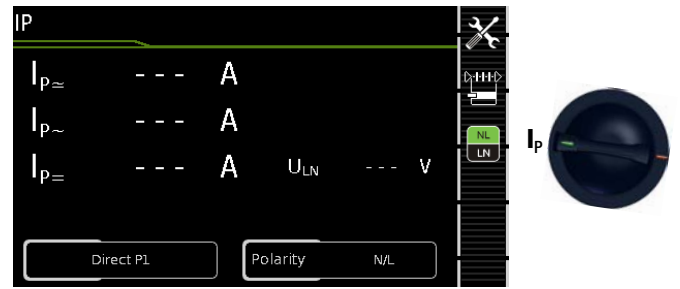

Single measurements, rotary switch level: green

Switch Position	Measurement Type, with Mains to Test Socket	Measurement Type, without Mains to Test Socket	Measuring Functions
I _p	Direct P1		I _p ~ Patient leakage current, TRMS
		Permanently connected P1	I _p - AC component
			I _p = DC component
			U _{LN} Test voltage

Definition

Patient leakage current is the current which flows to ground or PE from the patient ports at the running device via the patient. The AC and the DC component of the current is measured.

Direct Measuring Method

- **Measurement type direct P1**
- **DUT Mains Plug (PC1) Connected to Test Socket**
- **Probe to P1 Terminal**

Schematic Diagram

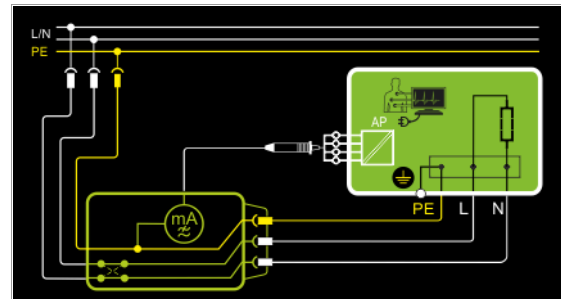

After activating test voltage, patient leakage current is measured at the DUT between PE (DUT mains plug) and the short-circuited application parts.

Wiring Diagram

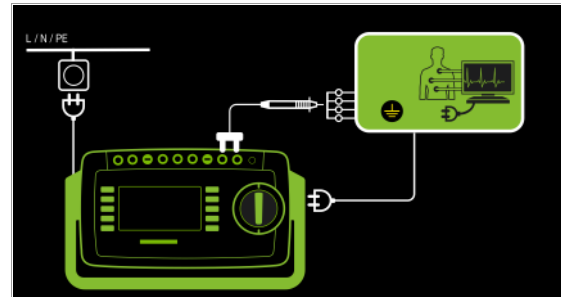

Direct measuring method

- Measurement type permanent connection P1
- Permanent Connection
- Probe to P1 Terminal

Schematic Diagram

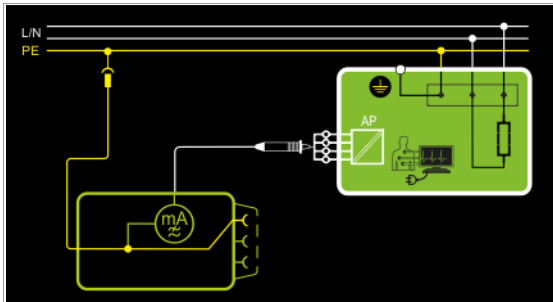

Patient leakage current is measured between the patient terminals and PE at the mains connection.

Wiring Diagram

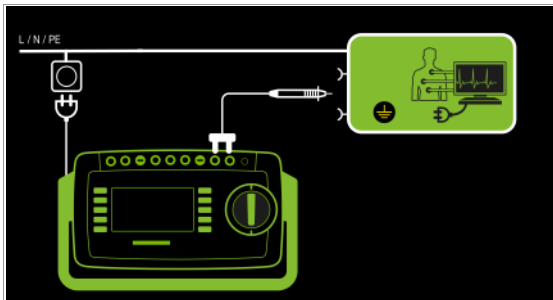







Setting Measuring Parameters for IP



Measuring Parameter	Meaning	
Measurement Type	Suitable for DUT Connection via	
Direct P1	Direct measuring method (via test socket) with test probe P1	Test socket
Permanently connected P1	Permanently installed DUT	Permanent connection
Polarity – for direct P1 only		
L/N or N/L	Selection of polarity for mains voltage to the test socket	

Test Sequence

- ⚡ Before conducting any leakage current measurements, make sure that the "Ref. voltage L-PE" and "Testingfreq. Alt" measurement parameters have been correctly set in SETUP (see section 6.2).
- ⚡ Set the rotary switch to the I_p position.
- ⚡ Connect the DUT to the test socket.
- ⚡ Select the measurement type:
 - By setting the parameters
 - or
 - Directly via the **Measurement Type** key 
- ⚡ In the case of **direct measurement P1**, measurement must be performed with mains plug polarity in both directions. Select the respective polarity to this end by pressing the **NL/LN** key. 
- ⚡ **Start the test:** press the **START/STOP** key. 
- ⚡ After each reconnection to the mains, and as soon as the first test is started, a mains connection test is executed.
- ⚡ In the case of measurement type direct P1: Acknowledge the warning which indicates that line voltage will be connected to the test socket. 
- ⚡ Switch the device under test on.
- ⚡ Contact the short-circuited inputs for the applied parts with test probe P1.
- ⚡ The measured values are displayed. The measured value recording symbol shown at the right appears. Each time this key is pressed, the currently displayed measured value is saved to buffer memory. 
- ⚡ Turn off the device under test.
- ⚡ **End the test:** press the **START/STOP** key. The save symbol appears (floppy disk showing the number of measured values stored to buffer memory) and prompts you to save the measured values to an ID number. 
- ⚡ Read the measured values and compare them with the table of permissible limit values.
- ⚡ Press the **ESC** key in order to discard the measured values stored to buffer memory and acknowledge by pressing the key shown at the right. 

Maximum Permissible Limit Values for Leakage Current in mA

Test Standard		I_p		
		Type B	Type BF	Type CF
IEC 62353 (VDE 0751-1)	Direct current	0.01	0.01	0.01
	Alternating current	0.1	0.1	0.01
EN 60601	Direct current	0.01	0.01	0.01
	Alternating current	0.1	0.1	0.01

This page has been left blank intentionally.

8.8 Probe Voltage – U



Single measurements, rotary switch level: green

Switch Position	Measurement Type, with Mains to Test Socket	Measurement Type, without Mains to Test Socket	Measuring Functions
U		PE - P1	U_{\sim} Probe voltage, RMS Alternating voltage component U_{-} Direct voltage component
	PE - P1 (with mains)		U_{\sim} Probe voltage, RMS Alternating voltage component U_{-} Direct voltage component

Mains to test socket

Schematic Diagram

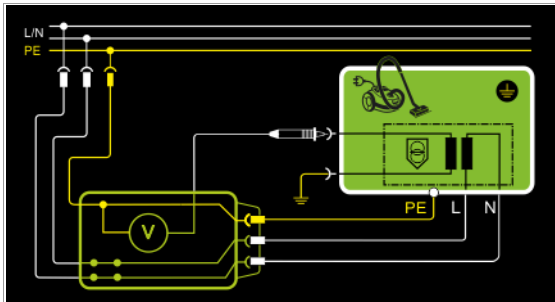

Wiring Diagram

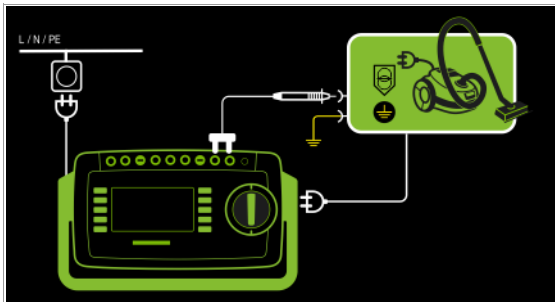

Permanently connected DUT

Schematic Diagram

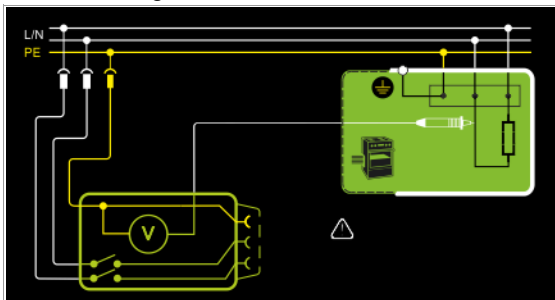

Wiring Diagram

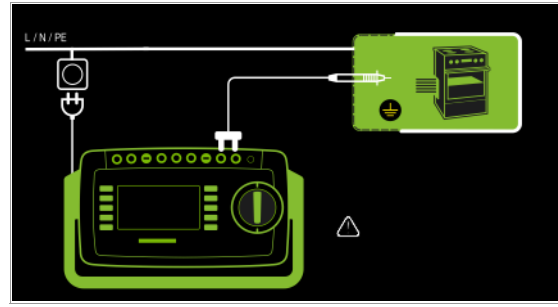

Direct, alternating and pulsating voltages of up to 253 V can be measured. Two connection types are available, one of which has to be selected in the parameters menu.

Setting Measuring Parameters for U_{Probe}



Measuring Parameter	Meaning	
Measurement Type		Suitable for DUT Connection via
PE-P1	Measurement of voltages with reference to PE, test socket remains voltage-free	Permanent connection
PE-P1 (with mains)	Measurement of voltages with reference to PE, line voltage is applied to the test socket	Test socket
Polarity – only for PE-P1 (with mains)		
L/N or N/L	Selection of polarity for mains voltage to the test socket	

Test Sequence

- Set the rotary switch to the **U** position.
- Connect the DUT's mains plug to the test instrument's test socket.
- Start the test:** press the **START/STOP** key.



- PE-P1 (with mains):** Acknowledge the warning which indicates that line voltage will be connected to the test socket.



- Switch the device under test on.
- Contact the ungrounded output for safety extra-low voltage with test probe P1.

- Polarity can be set via direct selection immediately before measurement is started, without having to switch to the parameters menu.



- The measured values are displayed. The measured value recording symbol shown at the right appears. Each time this key is pressed, the currently displayed measured value is saved to buffer memory.



- Turn off the device under test.

- End the test:** press the **START/STOP** key. The save symbol appears (floppy disk showing the number of measured values stored to buffer memory) and prompts you to save the measured values to an ID number.



- Press the **ESC** key in order to discard the measured values stored to buffer memory and acknowledge by pressing the key shown at the right.



8.9 Measuring Voltage – U (SECUTEST PRO or feature IO1 only)

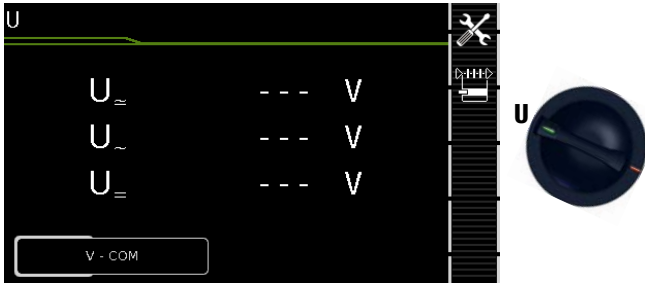

Single measurements, rotary switch level: green

Switch Position	Measurement Type, with Mains to Test Socket	Measurement Type, without Mains to Test Socket	Measuring Functions
U		V – COM	U_{\sim} Measuring voltage, RMS U_{\sim} Alternating voltage component U_{-} Direct voltage component
	V - COM (with mains)		U_{\sim} Measuring voltage, RMS U_{\sim} Alternating voltage component U_{-} Direct voltage component

Wiring Diagram

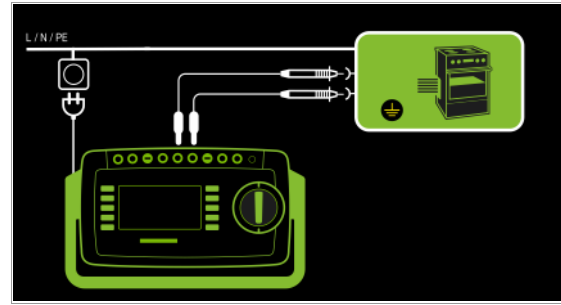

Direct, alternating and pulsating voltages of up to 253 V can be measured between the **V** and **COM** socket terminals.

- Measurements with the voltage measuring input of the volt-meter function (V–COM), electrically isolated from the mains

Setting Measuring Parameters



Measuring Parameter	Meaning	
Measurement Type		Suitable for DUT Connection via
V – COM	Display: RMS value + AC + DC	Permanent connection
V – COM (with mains)	Display: RMS value + AC + DC; with mains to test socket, e.g. for measuring protective extra-low voltage at power packs	Test socket

Mains to test socket

Schematic Diagram

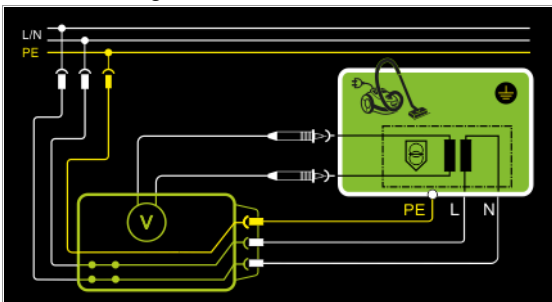

Wiring Diagram

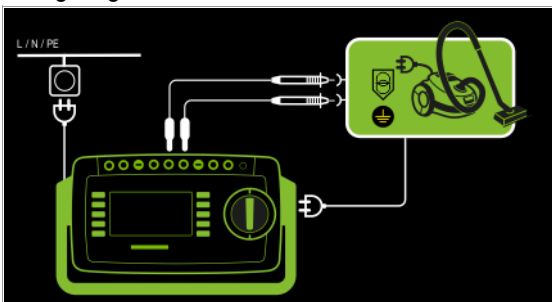

Permanently connected DUT

Schematic Diagram

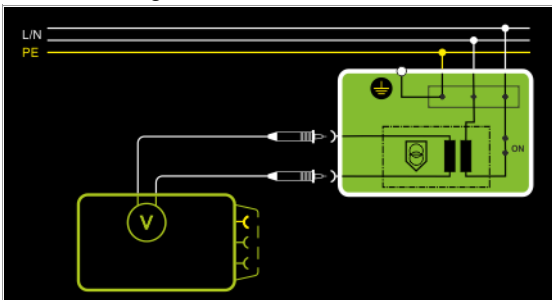







Test Sequence, DUT at Test Socket (e.g. for measuring safety extra-low voltage at power packs or chargers)

- Set the rotary switch to the **U** position.
- Set the parameter to **V – COM (with mains)**.
- Connect the DUT's mains plug to the test instrument's test socket.



Attention!

Use only the included, contact-protected KS17-ONE measurement cables when measuring dangerous voltage.

- Connect the DUT's output sockets to the **V** and **COM** sockets, e.g. in order to be able to measure a **safety extra-low voltage** at the DUT's output.
- **Start the test:** press the **START/STOP** key. 
- **V-COM (with mains)** Acknowledge the warning which indicates that line voltage will be connected to the test socket. 
- Switch the device under test on.
- The measured values are displayed. The measured value recording symbol shown at the right appears. Each time this key is pressed, the currently displayed measured value is saved to buffer memory. 
- Turn off the device under test.
- **End the test:** press the **START/STOP** key. The save symbol appears (floppy disk showing the number of measured values stored to buffer memory) and prompts you to save the measured values to an ID number. 

- Press the **ESC** key in order to discard the measured values stored to buffer memory and acknowledge by pressing the key shown at the right. 

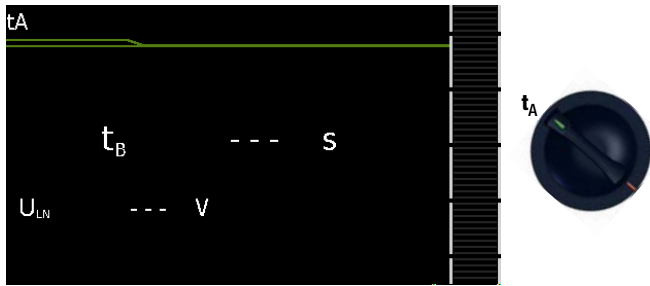
8.10 Measuring Time to Trip for RCDs of the Type PRCD – t_A



Single measurements, rotary switch level: green

Switch Position	Measuring Functions	Measurement Type, with Mains to Test Socket
t_A	t_a PRCD time to trip for 30 mA PRCD	
	U_{LN} Line voltage at the test socket	

Schematic Diagram

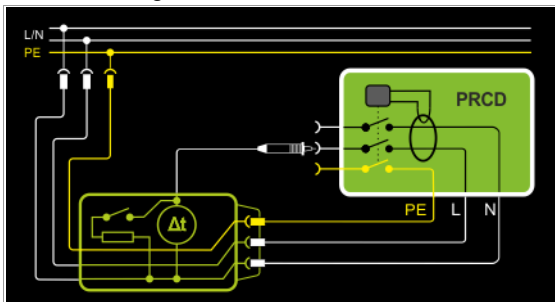

Wiring Diagram

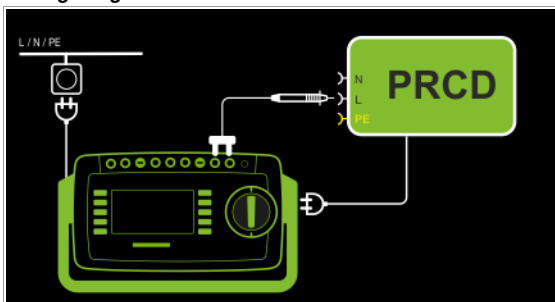

Definition

According to DIN VDE 0100-600:2008, substantiation must be provided that RCCBs are tripped within the time period specified in DIN VDE 0100-410.

PRCD Portable residual current device

Applications

The PRCD under test is plugged into the test socket at the test instrument. The PRCD's phase conductor must be contacted with test probe P1 in order to trip the PRCD.



Note

Testing of PRCDs (test sequences and time to trip) is only possible for DUTs with a nominal voltage of 230 V.



Note

Measurement of time to trip is not possible in IT systems.

Test Sequence

- Set the rotary switch to the t_A position.
- Plug the PRCD into the test socket at the test instrument and connect the test probe to P1.

- Start the test:** press the **START/STOP** key.



- Acknowledge the warning which indicates that line voltage will be connected to the test socket.



Execute the following steps when prompted to do so:



Note

Please note that test probe P1 is in continuous contact with the phase conductor from the point in time at which the PRCD is plugged in until it trips. Premature disconnection of the test probe may result in erroneous measured values.

- After each reconnection to the mains, and as soon as the first test is started, a mains connection test is executed.
- If the probe test has revealed that probe P1 was not connected: connect probe P1 as described above.
- Switch the PRCD on after connection to line voltage (e.g. reset button on PRCD).
- Contact neutral conductor L at the PRCD with test probe P1 (ascertain by trial and error if necessary).
- The test is automatically ended and time to trip is displayed after the PRCD is tripped.
- The save symbol appears and prompts you to save the measured values to an ID number.
- Press the **ESC** key in order to discard the measured values stored to buffer memory and acknowledge by pressing the key shown at the right.



8.11 Function Test – P

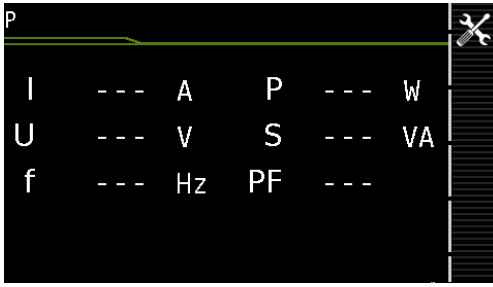

The device under test can be subjected to a function test with mains voltage via the integrated test socket.

The test socket is tested for short-circuiting before switching to line voltage (a statement resulting from the short-circuit test can only be made regarding the DUT itself when a single-phase DUT is being tested).

In addition to testing with the selector switch in the function test position, a function test can also be performed immediately after safety testing has been passed in accordance with the selected standard (not possible for protection category III devices).

Single measurements, rotary switch level: green

Switch Position	Measuring Functions	Measurement Type, with Mains to Test Socket
P	Function test at the test socket	Selection of polarity for mains voltage
I	Current between L and N	
U	Voltage between L and N	
f	Frequency	
P	Active power	
S	Apparent power	
PF	Power factor	

Schematic Diagram

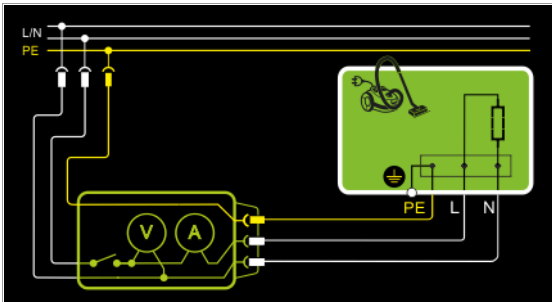

Wiring Diagram

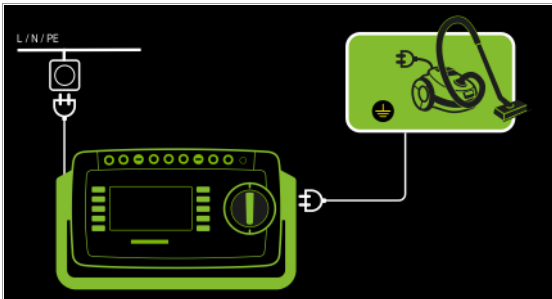

Setting Measuring Parameters for P

Measuring Parameter	Meaning
Polarity	
LN	Phase L – neutral conductor N
NL	Neutral conductor N – phase L

The following connection types are possible:

- Test socket
- CEE adapter (only for connection via single-phase CEE or “caravan socket”)
- AT3 adapter (AT3-IIIE, AT3-IIS, AT3-IIS32)
- AT16DI/AT32DI



Note

These or similar adapters can be used for the function test (initial start-up of the DUT), but measurement of apparent and active power, power factor and current consumption is only possible when the DUT is directly connected to the test socket or via the CEE adapter (single-phase CEE socket only).

Test Sequence



Attention!

The function test may only be performed after the DUT has successfully passed the safety test.



Attention!

Refer to the safety precautions on page 5 with regard to switching power consumers.



Attention!

Starting the Function Test

For reasons of safety, the device under test must be switched off before the function test is started. This precaution prevents inadvertent start-up of a DUT which may represent a hazard during operation, e.g. a circular saw or a disc grinder.

Ending the Function Test

After completion of the function test, DUTs must be turned off with their own switch – especially devices with relatively high inductivity.

- Set the rotary switch to the **P** position.
- Connect the DUT's mains plug to the test instrument's test socket.
- **Start the test:** press the **START/STOP** key.



- Acknowledge the warning which indicates that line voltage will be connected to the test socket.
- Switch the device under test on.
- The measured values are displayed. The measured value recording symbol shown at the right appears. Each time this key is pressed, the currently displayed measured value is saved to buffer memory.
- Turn off the device under test.



- **End the test:** press the **START/STOP** key. The save symbol appears (floppy disk showing the number of measured values stored to buffer memory) and prompts you to save the measured values to an ID number.
- Press the **ESC** key in order to discard the measured values stored to buffer memory and acknowledge by pressing the key shown at the right.



8.12 Testing Extension Cords for Correct Function – EL1

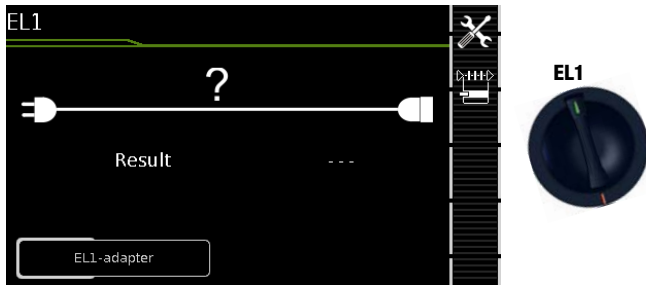

Single measurements, rotary switch level: green

Switch Position	Measuring Functions	Measurement Type, without Mains to Test Socket
EL1	Extension cord test with adapter for single or 3-phase extension cords for testing: – Continuity – Short-circuit – Incorrect polarity (reversed wires *)	EL1 adapter AT3-III-E adapter VL2E adapter

* No checking for reversed polarity takes place when the EL1 adapter is used.

Testing for	Continuity L(1/2/3), N	Short-circuiting between: L(1/2/3), N	Polarity reversal / clockwise phase sequence
EL1 adapter	X	X	—
VL2E adapter	X	X	X
AT3-III-E adapter	X	X	X



Attention!

This function permits an evaluation of the continuity of the active conductors L(1, 2, 3) and N of an extension cord. The PE conductor is not tested in this case.

Measurement at Single-Phase Extension Cords with EL1

Schematic Diagram

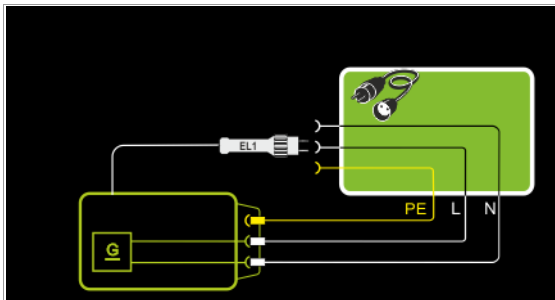

Wiring Diagram

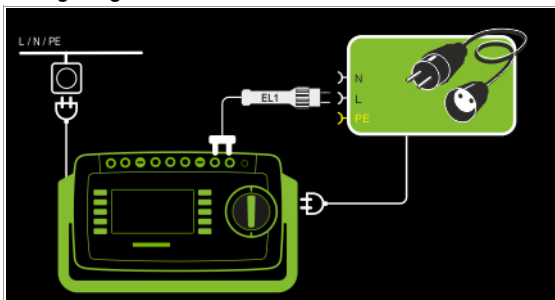

Measurement at Single and 3-Phase Extension Cords with VL2E

Schematic Diagram

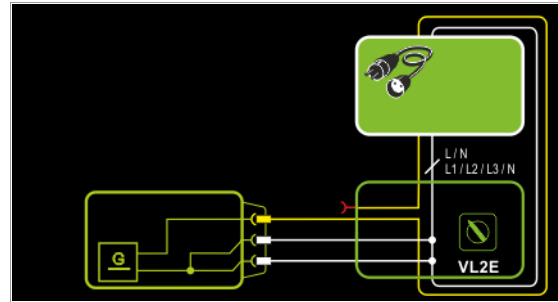

Wiring Diagram

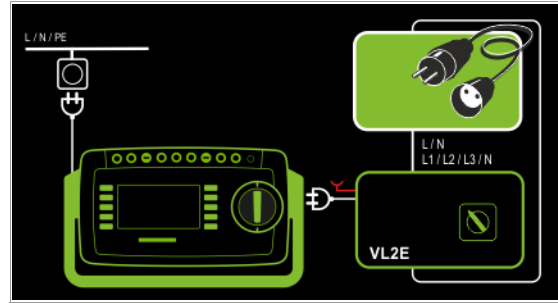

Measurement at Single and 3-Phase Extension Cords with AT3-III-E

Schematic Diagram

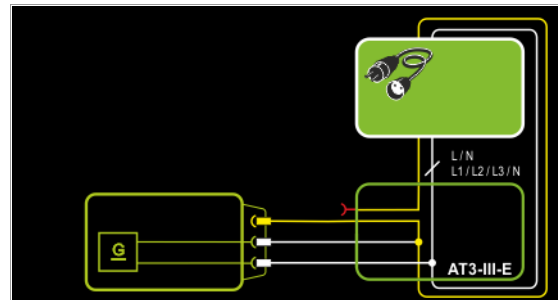

Wiring Diagram

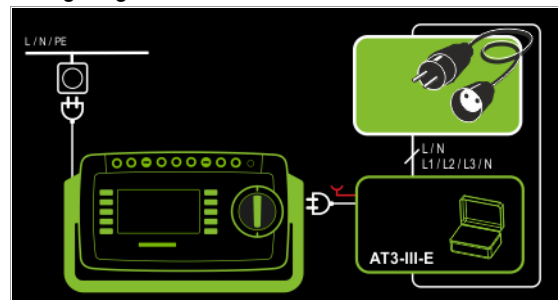

Setting Measuring Parameters



Testing for	Continuity L(1/2/3), N	Short-circuiting between: L(1/2/3), N	Polarity reversal / clockwise phase sequence
EL1 adapter	X	X	—
VL2E adapter	X	X	X
AT3-IIIE adapter	X	X	X

See corresponding single measurements for the testing of RPE and RINS.



Note

See section 10, "Test Sequences in Accordance with Standards" (switch setting A8) with regard to testing extension cords per DIN VDE 0701-0702, for which RPE and RINS are measured.



Attention!

If the EL1 continuity test is conducted for an extension cord in combination with a "travel adapter", results provided by the test instrument indicating the correctness of the extension cord's polarity cannot be relied upon!



Note







In the case of cables with indicator lamp (usually a glow lamp in the switch), the results of the continuity test for L and N may be distorted due to additional resistance caused by the glow lamp.

In case of doubt, perform a continuity test for L and N by means of resistance measurement (R-PE or R-INS):



SECUTEST PRO: R-PE between probe 1 and probe 2.

SECUTEST BASE(10): R-PE between probe 1 and measurement cable at the protective conductor bar in the test socket (test type PE(TS)-P1).

Test Sequence with EL1 Adapter

- ⇨ Set the rotary switch to the **EL1** position.
- ⇨ Select the **EL1 adapter** connection type directly via the key shown at the right. 
- ⇨ Connect the EL1 adapter to the P1 sockets at the test instrument.
- ⇨ Connect the plug at the end of the extension cord to the test socket.
- ⇨ Connect the coupling socket at the end of the extension cord to the plug at the EL1 adapter.
- ⇨ **Start the test:** press the **START/STOP** key. 
- ⇨ The measured values are displayed. The measured value recording symbol shown at the right appears. Each time this key is pressed, the currently displayed measured value is saved to buffer memory. 
- ⇨ **End the test:** press the **START/STOP** key. The save symbol appears (floppy disk showing the number of measured values stored to buffer memory) and prompts you to save the measured values to an ID number. 

- ⇨ Press the **ESC** key in order to discard the measured values stored to buffer memory and acknowledge by pressing the key shown at the right. 



Test Sequence with VL2E Adapter

- ⇨ Set the rotary switch to the **EL1** position.
- ⇨ Select the **VL2E adapter** connection type directly via the key shown at the right. 
- ⇨ Connect the cable from the VL2E adapter to the test socket at the SECUTEST....
- ⇨ Connect the extension cord's plug and socket to the VL2E adapter.
- ⇨ **Start the test:** press the **START/STOP** key. 
- ⇨ Set the rotary selector switch on the VL2E adapter to position 2 and retain this position. The measured values are displayed.



Note

The test instrument only indicates whether or not the cable is **OK** or **not OK**. In the case of "not OK", the inspector has to determine whether or not an interruption or a short-circuit is involved on his own by means of further measurements.

- ⇨ **End the test:** press the **START/STOP** key. The save symbol appears (floppy disk showing the number of measured values stored to buffer memory) and prompts you to save the measured values to an ID number. 

- ⇨ Press the **ESC** key in order to discard the measured values stored to buffer memory and acknowledge by pressing the key shown at the right. 

Test Sequence with AT3-IIIE Adapter



Attention!

Please observe the operating instructions for the AT3-IIIE regarding correct connection of the test adapter and the device under test, as well as peculiarities involved in the test sequence.

9 Special Functions – EXTRA

Depending on the device configuration, either the QR code for the Internet link to the operating instructions or the measuring view for the temperature measurement is displayed.

SECUTEST BASE(10)

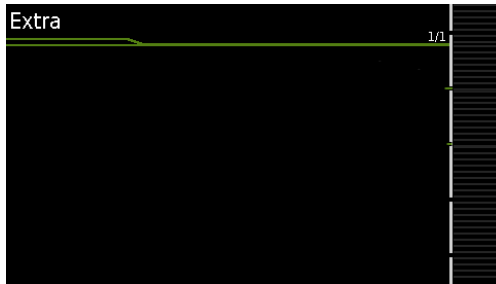

Measurement with Temperature Sensor

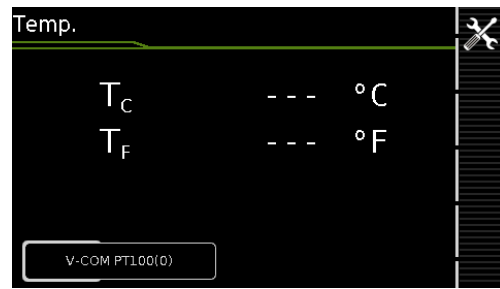

Temperature measurement functions with either a Pt100 or a Pt1000 temperature sensor – the sensor type is automatically detected internally.

Schematic Diagram

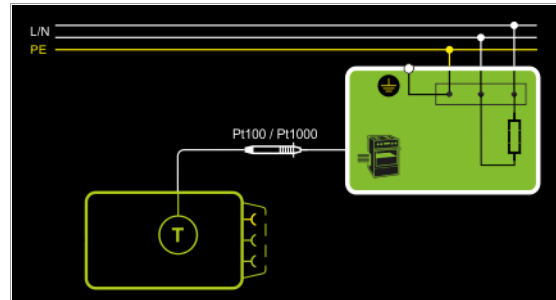

Single measurements, rotary switch level: green

Switch Position	Measuring Functions	Measurement Type
EXTRA	None	None

QR code: Scanning the QR code allows you to download and read the current operating instructions from www.gossenmetrawatt.com, for example at a tablet PC.

SECUTEST PRO (feature I01) and SECULIFE ST BASE(25)

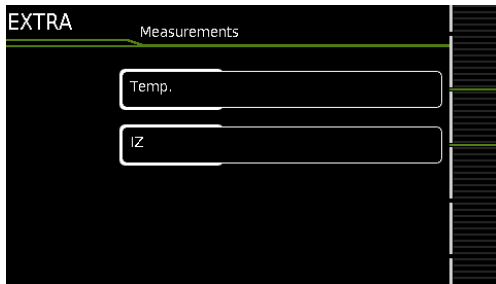

Wiring Diagram

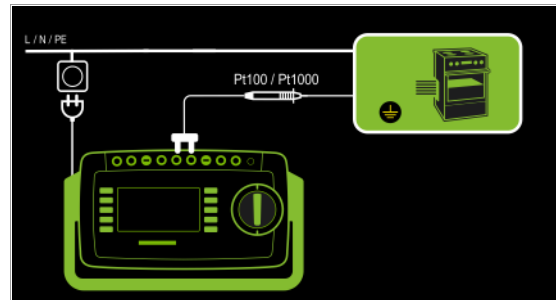





Single measurements, rotary switch level: green

Switch Position	Measuring Functions	Measurement Type
EXTRA	Temperature	V-COM
	Current clamp	V-COM

In this case, the additional functions are assigned to the rotary switch's **EXTRA** position.

- Select the desired measuring function.

Test Sequence with Temperature Sensor

- Set the rotary switch to the **EXTRA** position.
- Select the **Temperature** measurement type:
- Connect the temperature sensor's plug to the V-COM sockets at the test instrument.
- Contact the device under test.
- **Start the test:** press the **START/STOP** key. 
- The measured values are displayed. The measured value recording symbol shown at the right appears. Each time this key is pressed, the currently displayed measured value is saved to buffer memory. 
- **End the test:** press the **START/STOP** key. The save symbol appears (floppy disk showing the number of measured values stored to buffer memory) and prompts you to save the measured values to an ID number. 
- Press the **ESC** key in order to discard the measured values stored to buffer memory and acknowledge by pressing the key shown at the right. 

Measurement with Current Clamp Sensor



Current clamp measurement is possible in this case independent of measuring functions R_{PE} , I_{PE} or I_G , e.g. for measuring current at permanently installed devices.

Schematic Diagram

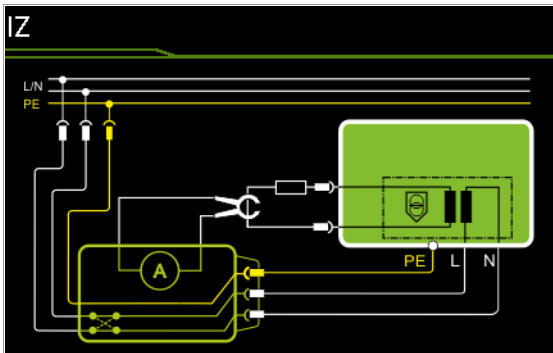

Wiring Diagram

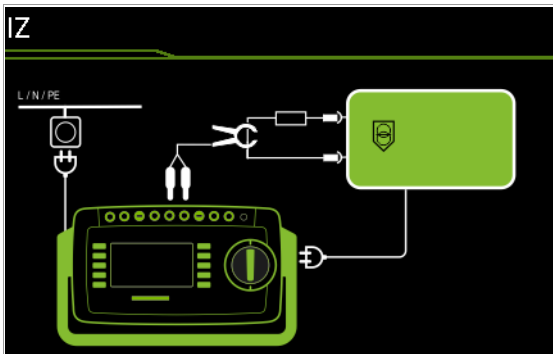

Setting Measuring Parameters for a Current Clamp Sensor

Measuring Parameter	Meaning	
Measurement Type		Suitable for DUT Connection via
V – COM	Display: A AC	Permanent connection
V – COM (with mains)	Display: A AC: with mains to test socket, e.g. for measuring protective extra-low voltage at power packs	Test socket
Polarity – only for PE-P1 (with mains)		
L/N or N/L	Selection of polarity for mains voltage to the test socket	
Clamp factor		
At tester	Clamp transformation ratio	Suitable clamp
1 V : 1000 A (1 : 1000)	1 mV / 1 A	WZ12C, Z3512A, METRAFLEX 3000
1 V : 100 A (1 : 100)	10 mV / 1 A	WZ11B, Z3512A, METRAFLEX 3000/300M
1 V : 10 A (1 : 10)	100 mV / 1 A	WZ12B, WZ11B, Z3512A, METRAFLEX 3000/300M
1 mV : 1 mA (1 : 1)	1000 mV / 1 A	WZ12C, Z3512A, METRAFLEX 300M
10 mV : 1 mA (10 : 1)		
100 mV : 1 mA (100 : 1)	100 mV : 1 mA	SECUTEST CLIP
1 V : 1 mA (1000 : 1)		

Test Sequence with Current Clamp Sensor

- Set the rotary switch to the **EXTRA** position.
 - Select the **Current (via clamp)** measuring function.
 - Set the clamp factor at the current clamp sensor.
 - **Clamp factor:** Set clamp factor at the test instrument to the same value as at the current clamp sensor.
 - Connect the current clamp to the V-COM sockets at the test instrument.
 - Enclose the consuming device's cable with the current clamp sensor as shown in the schematic diagrams.
 - **Start the test:** press the **START/STOP** key.
- The measured values are displayed. The measured value recording symbol shown at the right appears. Each time this key is pressed, the currently displayed measured value is saved to buffer memory.
- **End the test:** press the **START/STOP** key. The save symbol appears (floppy disk showing the number of measured values stored to buffer memory) and prompts you to save the measured values to an ID number.
 - Press the **ESC** key in order to discard the measured values stored to buffer memory and acknowledge by pressing the key shown at the right.

Setting Measuring Range at the Clamp and Parameters at the Test Instrument

Test Instrument	Current Clamp Sensor		Test Instrument
Clamp Factor	Transformation Ratio (switch *)	Measuring Range	Display Range with Clamp
WZ12C			
1000 mV : 1 A	1000 mV : 1 A	1 mA ... 15 A	0 A ... 300 A
1 mV : 1 A	1 mV : 1 A	1 A ... 150 A	1.0 A ... 300 A
WZ12B			
100 mV : 1 A	100 mV : 1 A	10 mA ... 100 A	0 A ... 300 A
WZ11B			
100 mV : 1 A	100 mV : 1 A	0.5 A ... 20 A	0 A ... 300 A
10 mV : 1 A	10 mV : 1 A	5 A ... 200 A	0 A ... 300 A
Z3512A			
1000 mV : 1 A	1000 mV : 1 A	0.001 A ... 1 A	0 A ... 300 A
100 mV : 1 A	100 mV : 1 A	0.01 A ... 10 A	0 A ... 300 A
10 mV : 1 A	10 mV : 1 A	0.1 A ... 100 A	0 A ... 300 A
1 mV : 1 A	1 mV : 1 A	1 A ... 1000 A	0 A ... 300 A
METRAFLEX 3000			
100 mV : 1 A	100 mV : 1 A	0.01 A ... 30 A	0 A ... 300 A
10 mV : 1 A	10 mV : 1 A	0.1 A ... 300 A	0 A ... 300 A
1 mV : 1 A	1 mV : 1 A	1 A ... 3000 A	0 A ... 300 A
METRAFLEX 300M			
1000 mV : 1 A	1000 mV : 1 A	0.001 A ... 3 A	0 A ... 300 A
100 mV : 1 A	100 mV : 1 A	0.01 A ... 30 A	0 A ... 300 A
10 mV : 1 A	10 mV : 1 A	0.1 A ... 300 A	0 A ... 300 A
100 mV : 1 mA	SECUTEST CLIP		
	100 mV : 1 mA	0.1 ... 25 mA	0.01 mA ... 3.00 A

10 Test Sequences

Status upon shipment (default setting)

Automated test sequences, rotary switch level: orange						
Switch Setting	Standard / Test Sequence	Measurement Type	Connection	Type	Protection Category	Freely configurable depending on the selected configuration (protection category, type of application part)
Preconfigured (freely adjustable) test sequences						
A1	VDE 0701-0702	Passive	Test socket		PC I + PC II **	Short-circuit test * – visual inspection * – RPE * – RINS PC I * – RINS PC II ** – IPE Alt. – IT Alt. ** – function test *
A2	VDE 0701-0702	Active	Auto		PC I + PC II **	Short-circuit test * – visual inspection * – RPE * – RINS PC I * – RINS PC II ** – IPE NL – IT NL ** – IPE LN – IT LN ** – function test *
A3	VDE 0701-0702-EDV	Active	Auto		PC I + PC II **	Short-circuit test * – visual inspection * – RPE * – IPE NL – IT NL ** – IPE LN – IT LN ** – function test *
A4	IEC 62353 (VDE 0751)	Passive	Test socket	BF	PC I + PC II **	Short-circuit test * – visual inspection * – RPE * – RINS PC I * – RINS PC II+AP * – RINS LN < > F * – RINS PE < > F * – IE SK I – IT Alt. ** – IA BF – function test *
A5	IEC 62353 (VDE 0751)	Active	Auto	BF	PC I + PC II **	Short-circuit test * – visual inspection * – RPE * – RINS PC I * – RINS PC II+AP * – RINS LN < > F * – RINS PE < > F * – IE NL PC I – IT NL ** – IA NL BF – IE LN PC I – IT LN ** – IA LN BF – function test *
A6	IEC 60974-4	Active	Auto		PC I + PC II **	Short-circuit test * – visual inspection * – RPE * – RINS PC I – RINS welding circuit – RINS welding circuit -PE – RINS PC II * – IPE NL – IT S1 NL – IT S2 NL – IT NL ** – IPE LN – IT S1 LN ** – IT S2 LN ** – IT LN ** – U(O)/U(R) – function test * – visual inspection 2 *
A7	IEC 60974-4	Active	AT16/32-DI adap.		PC I + PC II **	Visual inspection 1 * – RPE * – RINS PC I – RINS welding circuit – RINS welding circuit-PE – RINS PC II * – IPE NL – IT S1 NL ** – IT S2 NL – IT NL ** – IPE LN – IT S1 LN ** – IT S2 LN ** – IT LN ** – U(O) – Visual inspection 2 *
A8	VDE 0701-0702-VLTG	VLTG	EL1		PCI	Short-circuit test * – visual inspection * – RPE * – RINS * – continuity (EL1)
AUTO	VDE 0701-0702	Auto	Auto		PC I + PC II **	Short-circuit test * – visual inspection * – RPE * – RINS PC I * – RINS PC II ** – IPE Alt. – IT Alt. ** – function test *

* Assuming the respective sequence parameter is preset to "on"

** Additional testing of conductive/metallic parts which are not connected to the protective conductor

Auto = automatic detection, see page 61

10.1 General

If the same sequence of single tests will be run frequently (one after the other with subsequent report generation), for example as specified in the standards, it's advisable to make use of test sequences (also called measuring sequences).

Limit values have been entered for test sequences in accordance with the standards. And thus a go/no-go evaluation takes place during measurement based on worst-case assessment. If the momentary measured value is displayed in green, it lies within the limit values specified in the standard. If the measured value is red, it does not fulfill the requirements set forth in the standard.



Note

The go/no-go evaluation of the measured values is performed with greater accuracy than the value which appears at the display, which may lead to the fact that, due to the missing decimal places, a measured value which appears at the display may seem to correspond exactly to the limit value although it's highlighted in red (as a limit value violation) due to the places to the right of the decimal point.

If the measured value is orange, further entries are required after the test step (e.g. cable length), which are decisive as to whether or not the test has been passed. Even if the DUT fails just one single measurement, the test sequence is aborted and testing in accordance with the selected standard is failed.

Automatic test sequences are run in rotary switch positions AUTO, as well as A1 through A8.

Test sequences A1 through A8 and AUTO are preconfigured at the factory.

We recommend assigning frequently used test sequences to A1 through A8, and conducting special sequences for which parameters often need to be adjusted in the AUTO switch position.

The measurements are evaluated automatically by the test instrument. Evaluation is based on the worst-case and, depending on settings, in consideration of measuring uncertainty.

Specifications for the test sequences can be entered to the test instrument in two different ways:

- **SETUP switch position:** general settings can be entered which apply to all test sequences (regardless of the respectively selected standard).

- **Switch positions AUTO and A1 to A8:** classification and sequence parameters can be entered which only apply to the selected switch position.

Test Sequences in the AUTO Switch Position

The following test sequences are included as a standard feature with the **SECUTEST BASE(10)** and the **SECULIFE ST BASE(25)** in rotary switch positions **AUTO and A1 to A8**:

- **DIN VDE 0701-0702**
Periodic testing and testing after repair and modification of electrical equipment
- **IEC 62353**
Medical electrical equipment – Recurrent test and test after repair of medical electrical equipment (applied parts with test probe P1)
- **IEC 60974-4**
Arc welding equipment – Part 4: Periodic inspection and testing (voltage measurement with test probe P1 without electrical isolation) One pole of the voltage to be measured must be connected to PE at the mains.

The individual sequences are selected with the softkeys.

User-Defined Test Sequences

Up to 24 * customer-specific (user-defined) test sequences can be saved to the test instrument and assigned to rotary switch positions AUTO and A1 to A8. The sequences are created at the PC with the help of **IZYTRONIQ** software (up to firmware 1.7.2: **Sequence Designer** software).

The measurements and parameters available in your SECUTEST version are loaded from the test instrument and made available in the PC software for this purpose. Finally, the created test sequence can be loaded directly to the SECUTEST... (prerequisite: database extension, feature KB01, "Z853R – SECUTEST DB+") and saved to the computer as an XML file. As a rule, customer-specific (user-defined) test sequences are identified with a preceding asterisk (*) in the SECUTEST user interface.

* As of firmware version 2.0, a total of 24 user-defined test sequences can be loaded to the test instrument with feature KB01, "Z853R – SECUTEST DB+".

10.2 User-Defined Test Sequences / Remote Control (only with feature KB01, "Z853R – SECUTEST DB+")

10.2.1 General

When creating user-defined test sequences, the author of the test sequence can define and configure individual test steps himself, and specify the order in which they're run.

With the help of **IZYTRONIQ** PC software (as of firmware 2.1.1), test sequences can be created at the PC and transferred to the test instrument via a USB port.



Note

Up to 1200 test steps can be distributed to as many as 24 test sequences and saved to memory at the test instrument.

Similar options are available to the user when the test instrument is remote controlled (e.g. via **IZYTRONIQ** IZY remote test sequences).

Some of the test steps necessitate advance testing in the form of inspections or test instructions, for example so that the inspector has enough time to contact the respective location with the probe at the point in time of test execution, or to set the DUT to the appropriate state.

If user-created test sequences are created and/or used, or in the case of remote control of the test instrument, the creator of the test sequences or the user/inspector assumes responsibility for standards-compliant test steps and execution of advance tests in the correct order.



Attention!

If you change or shorten the default test sequences for the respective standards, the danger exists that they will no longer be compliant and will thus become invalid as substantiation of operating safety in accordance with DGUV regulation 3 or BetrSichV, or will no longer fulfil these standards.

10.2.2 Testing of Probe Connection P1 and Probe Fuse P1

If probe P1 is used in a test sequence, a "Probe Test" step with "Probe: Probe Connection P1" must be included in the respective test sequence. Background: In addition to assuring that a probe is connected to probe connection P1, the probe test at connection P1 also determines whether or not the probe's fuse link is intact.



Attention!

If the fuse at test probe P1 is defective, all subsequent measurements using this measuring path are incorrectly evaluated as good!

10.3 General Settings (Setup: auto measurements parameter)

The following settings can be entered for all test sequences in the **SETUP** switch position on menu page 1/3 under the **auto measurements** parameter (see section 4.3):

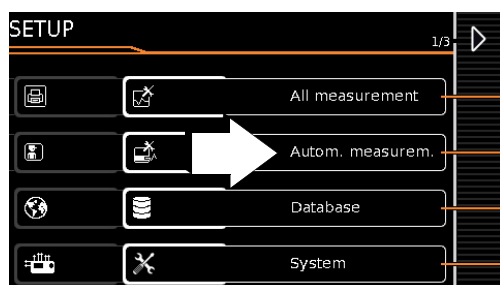

Automatic Measurements (1/3)

At the End of the Sequence

At the end of a sequence, either the save symbol appears in order to prompt storage ("memory screen" parameter), or the results list ("results list" parameter) is displayed.

Considering Measuring Uncertainty

If **Yes** is selected, measuring uncertainty is taken into consideration when the measurement results are displayed. The final result which appears at the display is downgraded by an amount equal to measuring uncertainty.

Auto Measuring Point

If **Yes** is selected, the test instrument detects whether or not the protective conductor is contacted with the probe during the protective conductor resistance measurement of an automatic test sequence and automatically starts recording a new measuring point. Statuses are indicated by various, continuous acoustic signals. The protective conductor test can thus be conducted without using the keys on the instrument.



Note

The "Auto Measuring Point" function is only activated during test steps of the "multiple measurement" type. If you want to use this function ...

- In the case of integrated test sequences: Make sure that the "multiple measurement" test parameter (see page 54) is selected for the RPE test step.
- In the case of user-defined test sequences (only with database extension, feature KB01, "Z853R – SECUTEST DB+"): make sure that the RPE test step has been entered to the sequence as a "multiple measurement".

Automatic Measurements (2/3)

Initial Window Style

Selection can be made here between a tree view and a detail view for the first page of the test sequence (see section 10.4).

Limit Value Mode

If you want to use only the limit values specified in the standards to evaluate the measurements, set the parameter to **Normal**.

When set to **Expert**, the **LIMIT** softkey appears next to the "measurement failed" popup if the measurement has not been passed. This key makes it possible to enter a user-defined limit value (as a rule a limit value specified by the manufacturer which deviates from the standard), in order to allow the test to be passed under these new conditions.



Note

Entry of a user defined limit value is not possible if "Continue" is selected for the "Limit Violation" option.

Limit Value Violation (only with feature KD01, "Z853S – SECUTEST DB COMFORT")

With its **"Try Again"** operating mode, the test instrument makes it possible to immediately restart the failed test step and repeat the measurement in the event that a limit value is violated.

In the **"Continue"** mode, the test instrument doesn't terminate the test sequence in the event of a limit value of violation, and instead continues testing despite any individual steps which have failed.



Note

If a limit value violation occurs during the test sequence, the respective test step designation appears in red in the header for all following test steps, so that it's already

made apparent during the test sequence that a limit value violation has occurred during one of the previous test steps, and that the device under test will not pass testing.

Automatic Measurements (3/3)

❑ **Measuring sequences** (no longer in the “Culture” menu as of firmware V1.6.0)

The following standards can be selected here:
VDE, OVE (Dutch version: NEN)

The instrument is restarted if the setting for “Measuring Sequences” has been changed and the “Auto Measurements” menu is exited.

Note

The test instrument must be restarted after changing the measuring sequences.
Database structure and content remain unchanged.

❑ **Autostore (feature KD01, “Z853S – SECUTEST DB COMFORT”)**

If this function is activated (“on”), the test results for the automatic test sequence are immediately saved under the test object (= device or ME device (medical electric device)) which is currently selected in the database.

If you haven’t yet selected a test object in memory management (MEM key), a message appears informing you that automatic storage of the current test is not possible.















You’re prompted to enter an object ID via the scanner or the softkeys, or to select one from the database (MEM key). In this case you have to save the test manually to the database via the “Save” softkey.



















❑ **Skip steps**

Here you can configure whether or not the user is allowed to skip test steps **during** a test sequence (“on”).

This does **not** apply to inspection test steps that can be omitted (which have no relevance with regard to the standard)!

Meaning of Symbols in the User Interface – Test Sequence

Sym- bol	Softkey Variants, Test Sequence
	Test for Protection Category I Devices Exposed, conductive parts are connected to the protective conductor so that they are not charged with voltage if the basic insulation should fail.
	Test for Protection Category II Devices These devices are equipped with double insulation or reinforced insulation.
	Test for Protection Category III Devices These devices are supplied with safety extra-low voltage (SELV). Beyond this, no voltages are generated which exceed SELV.
	Type B applied parts (body)
	Type BF applied parts (body float)
	Type CF applied parts (cardiac float)
	Configure sequence parameters (see page 64)
	Set classification parameters
	Assess visual inspection or function test with OK  or not OK  (toggle key)
	Enter a comment, e.g. for the visual inspection or function test
	Continue test, next test step in the test sequence
	Stop continuous measurement , next test in test sequence
	Accept changed parameter, return to memory view

Sym- bol	Softkey Variants, Test Sequence
	Stop test sequence
	– Repeat inspection (if it has been failed). – Repeat test step
	– Skip inspection test step – Skip individual tests within the test sequence This option can be enabled for the user in SETUP under “Auto Measurements”.
	Start evaluation – record measured value. Each time this softkey is pressed, an additional measured value is saved and the number is increased by one.
	Start evaluation sequence during a continuous measurement . The number blinks.
	Record measured value during the evaluation sequence of a continuous measurement .
	Repeat measured value recording
	Delete measured value
	Display measured values
	Display details from the results list
	Hide details from the results list
	The ID number to which the measurement(s) will be stored can be entered here.
	Valid measured values have been obtained for a test sequence. This measurement can be saved.
	Save measurement data as (with display of directory path / ID or new entry of an ID other than the preselected one)
	Transmit measurement data to a PC, e.g. in order to save them to IZYTRONIQ report generating software (push-print function) – refer to IZYTRONIQ online help for a description
	Read-out of a complete test report at the end of a test sequence
	Read-out of a summarized test report at the end of a test sequence
	Read-out of all failed test steps instead of a test report at the end of the test sequence

10.4 Selecting and Configuring a Test Sequence

Sample: Initial Page of a Test Sequence – Tree View Standard / Test Sequence

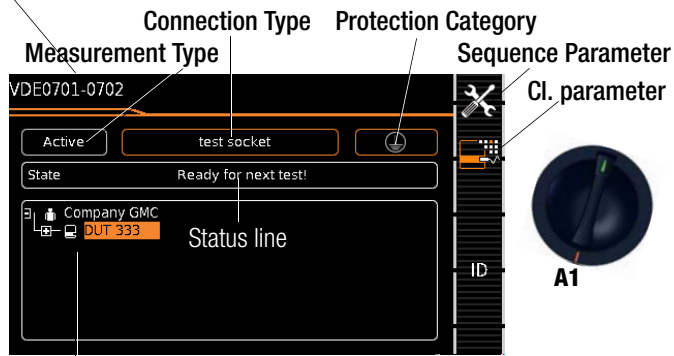

Tree view *

Sample: Initial Page of a Test Sequence – Detail View and Applied Standard / Test Sequence

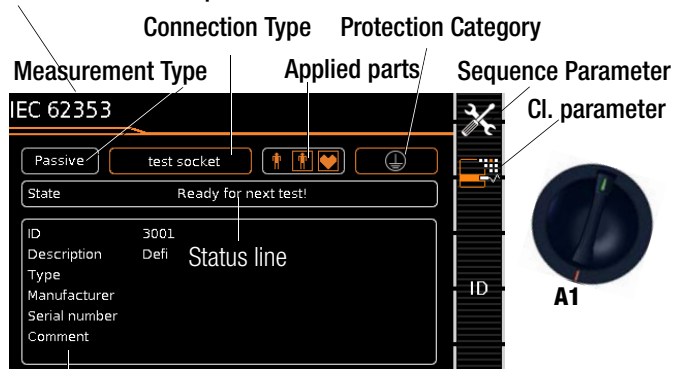

Detail view *

* SETUP switch position:
Setup Menu 1/3 > Auto Measurements > 2/2 > Initial Window Style:
Tree or **Detail View**

Test instruments with feature E01 (touchscreen)

The display can be switched back and forth between the “tree view” and the “detail view” (see above) via “Touch Click”, i.e. by briefly tapping within the bottom frame.

Classification Parameter – Automatic Detection

If the settings for certain classification parameters are automatically detected by the test instrument, this is indicated in each case by an orange frame (as of firmware V1.3.0; here: test socket connection type and protection category I). Descriptions of these parameters are listed in the following tables relative to the respective switch positions.



Automatic detection active for protection class

When connecting or disconnecting a DUT, the protection class can be changed without prior authorization.



Automatic detection inactive for protection class

The test instrument retains the selected safety class setting when a DUT is connected or disconnected.

Conveniently Changing Classification Parameters (optional feature E01, touchscreen)

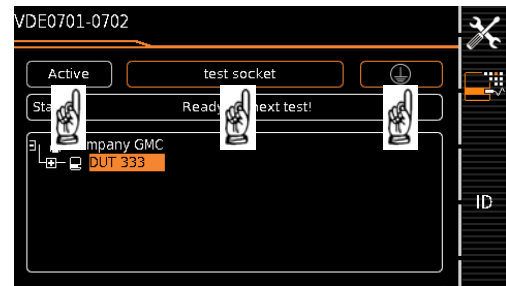

- The corresponding selection menu appears after touch clicking (briefly tapping) the respective classification parameters window.
- The display is automatically returned to the start menu after selecting the desired parameter.

Classification Parameter – VDE 0701-0702



Parameter	Setting Options / Meaning
1/2	
Standard	VDE 0701-0702 VDE 0701-0702-EDV, see following table VDE 0701-0702-VLTG, see table below VDE 0701-0702-PRCD, see table below IEC 62353, see table below IEC 60974-4, see table below
Protection class ^{1, 2}	PCI, PCII, PCI+II, PCI+III, PCII+III, PCI+II+III
Connection type ^{1, 2}	Test socket Permanent connection Adapter: AT16/32-DI adapter Adapter: VL2E Adapter: AT3-Adapter (feature I01) Permanent connection: P1+P2 (only with feature H01)
2/2	
Measurement type (MA) ¹	Passive Active
Auto-detection	Connection & PC & MT Connection & PC Connection & MT Connection only PC & measurement type Protection class only (PC) Measurement type only (MT) Disabled: No auto-detection: all classification parameters such as connection, protection category and measurement type must be entered manually.

¹ These parameters must be entered manually if they're not automatically detected, or if they're detected incorrectly.

² The limit value for protective conductor resistance is determined on the basis of length and cross-section. Data remain in memory until a new entry is made.

Classification Parameter – VDE 0701-0702-EDV



Parameter	Setting Options / Meaning
1/2	
Standard	VDE 0701-0702, see table below VDE 0701-0702-EDV VDE 0701-0702-VLTG, see table below VDE 0701-0702-PRCD, see table below IEC 62353, see table below IEC 60974-4, see table below
Protection class ^{1, 2}	PCI, PCII, PCI+II, PCI+III, PCII+III, PCI+II+III
Connection type ^{1, 2}	Test socket Permanent connection Adapter: AT16/32 Adapter: AT3-Adapter (feature IO1)
2/2	
Measurement type (MA) ¹	Active
Auto-detection	Connection & PC & MT Connection & PC Connection & MT Connection only PC & measurement type Protection class only (PC) Measurement type only (MT) Disabled: No auto-detection: all classification parameters such as connection, protection category and measurement type must be entered manually.

¹ These parameters must be entered manually if they're not automatically detected, or if they're detected incorrectly.

² The limit value for protective conductor resistance is determined on the basis of length and cross-section. Data remain in memory until a new entry is made.

Classification Parameter – VDE 0701-0702-PRCD



Parameter	Setting Options / Meaning
1/2	
Standard	VDE 0701-0702, see table below VDE 0701-0702-EDV, see table above VDE 0701-0702-VLTG, see previous table VDE 0701-0702-PRCD ² IEC 62353, see following table IEC 60974-4, see table below
Protection class ^{1, 2}	PCI, PCI+II
Connection type ^{1, 2}	Test socket
2/2	
Measurement type (MA) ¹	PRCD ³
PRCD type ³	PRCD (standard) PRCD (SPE) PRCD-S (SPE) PRCD-K (SPE)
Auto-detection	Connection & PC & MT Connection & PC Connection & MT Connection only PC & measurement type Protection class only (PC) Measurement type only (MT) Disabled: No auto-detection: all classification parameters such as connection, protection category and measurement type must be entered manually.

¹ These parameters must be entered manually if they're not automatically detected, or if they're detected incorrectly.

² The limit value for protective conductor resistance is determined on the basis of length and cross-section. Data remain in memory until a new entry is made.

Classification Parameter – VDE 0701-0702-VLTG



Parameter	Setting Options / Meaning
1/2	
Standard	VDE 0701-0702, see table below VDE 0701-0702-EDV, see previous table VDE 0701-0702-VLTG VDE 0701-0702-PRCD, see following table IEC 62353, see table below IEC 60974-4, see table below
Protection class ^{1, 2}	PCI
Connection type ^{1, 2}	Test socket Adapter: AT3-IIIE Adapter: EL1 adapter Adapter: VL2E adapter
2/2	
Measurement type (MA) ¹	VLTG ²
Auto-detection	Connection & PC & MT Connection & PC Connection & MT Connection only PC & measurement type Protection class only (PC) Measurement type only (MT) Disabled: No auto-detection: all classification parameters such as connection, protection category and measurement type must be entered manually.

¹ These parameters must be entered manually if they're not automatically detected, or if they're detected incorrectly.

² The limit value for protective conductor resistance is determined on the basis of length and cross-section (length only in the case of EL1). Data remain in memory until a new entry is made.

³ New classification parameter "PRCD type" (as of firmware V1.7.0)

(only displayed if "Standard VDE 0701-0702-PRCD" parameter is selected):

- **PRCD (standard):**
For the testing of simple circuit breaker safety adapters in which the protective conductor is permanently connected.
- **PRCD (SPE):**
(SPE = switched protective earth) for testing PRCDs in which the protective conductor is only connected in switched-on condition.
- **PRCD-S (SPE):**
For testing type PRCD-S circuit breaker safety adapters.
- **PRCD-K (SPE):**
For testing type PRCD-K circuit breaker safety adapters.



Note

The standard or standard variant associated with the respective selector switch position corresponds to the default setting.
Ax means that standard variant VDE 0701-0702-PRCD can be selected in each of the preset switch positions.



Note

For more information on the testing of single-phase and 3-phase type S and K PRCDs by simulating faults see **PROFITEST PRCD** test adapter on our website.



Note

Testing of PRCDs (test sequences and time to trip) is only possible for the DUTs with a nominal voltage of 230 V.



Parameter	Setting Options / Meaning
1/2	
Standard	VDE 0701-0702, see table below VDE 0701-0702-EDV, see table above VDE 0701-0702-VLTG, see table above VDE 0701-0702-PRCD, see previous table IEC 62353 IEC 60974-4, see following table
Protection class ¹	PCI, PCII or PCI+II
Connection type ¹	Test socket Permanent connection Adapter: AT16/32-DI adap. Adapter: AT3-Adapter Permanent connection: P1+P2 (only with feature H01)
2/2	
Measurement type (MA) ¹	Passive Active
Applied parts	Applied parts: none, B, BF, CF or combinations Type B (body): Devices of this type are suitable for both internal and external patient applications, except for use in direct proximity to the heart. The following protection categories are permissible: I, II, III or devices with internal electrical power supply. Type BF (body float): Same as type B, but with type F insulated applied parts. Type CF (cardiac float) Devices of this type are suitable for use directly at the heart. The applied part may not be grounded. The following protection categories are permissible: I, II or devices with internal electrical power supply.
Auto-detection	Connection & PC & MT Connection & PC Connection & MT Connection only PC & measurement type Protection class only (PC) Measurement type only (MT) Disabled: No auto-detection: all classification parameters such as connection, protection category and measurement type must be entered manually.

¹ These parameters must be entered manually if they're not automatically detected, or if they're detected incorrectly.



Parameter	Setting Options / Meaning
1/2	
Standard	VDE 0701-0702, see table below VDE 0701-0702-EDV, see table above VDE 0701-0702-VLTG, see table above VDE 0701-0702-PRCD, see table above IEC 62353, see previous table IEC 60974-4
Protection class ¹	PCI, PCII or PCI+II
Connection type ¹	Test socket Permanent connection Adapter: AT16/32-DI adap. Adapter: AT3-Adapter
2/2	
Measurement type (MA) ¹	Active
Voltage, rating plate	Voltage from rating plate, U(R) RMS (RMS limit value, variably adjustable) or open-circuit voltage U0 DC (limit value = 113 V DC)
Auto-detection	Connection & PC & MT Connection & PC Connection & MT Connection only PC & measurement type Protection class only (PC) Measurement type only (MT) Disabled: No auto-detection: all classification parameters such as connection, protection category and measurement type must be entered manually.

¹ These parameters must be entered manually if they're not automatically detected, or if they're detected incorrectly.



Note

The limit values in the test instrument are set in accordance with IEC 60974-4:2016 status as of firmware version 2.1.0.

Sequence Parameter (as of firmware V1.3.0)

The default test sequences can be adapted to your application or test standard via the sequence parameter. The entered sequence parameter settings are only valid for the currently selected switch position (A1 to A8 or AUTO) and are retained until they are changed. Not all of the parameters are relevant, depending on the selected DUT classification (protection category etc.).

Sequence Parameter	Meaning
Visual inspection (1)	Visual inspection (standard): on: activate off: deactivate
Visual inspection 2 (IEC 60974-4)	Visual inspection, function test, welding units on: activate off: deactivate
Function test	Function test: on: activate off: deactivate
Protective conductor resistance test	
RPE	Protective conductor resistance test: on: activate off: deactivate
RPE IP	Protective conductor resistance at test socket: Select test current IP: $\pm 200 \text{ mA} = / 200 \text{ mA} \sim /$ Feature G01: 10 A $\sim /$ feature G02: 25 A \sim
RPE IP permanent connection	Protective conductor resistance with permanent connection: Select test current IP: $\pm 200 \text{ mA} = / 200 \text{ mA} \sim /$ Feature G01: 10 A $\sim /$ feature G02: 25 A \sim
RPE as	Protective conductor resistance test: Execute as individual or multiple measurement. Multiple measurement: Repeat testing of various conductive parts as often as desired, in the event that it's not clear as to whether or not all accessible, conductive parts are connected to each other or to the protective conductor.
RPE measurement duration	Protective conductor resistance test: A measurement duration within a range of 0 to 60 seconds can be entered here.
Insulation resistance test	
RINS PC I	Insulation resistance tests for PCI: on: activate off: deactivate
RINS PC II	Insulation resistance tests for PCII: on: activate off: deactivate
RINS PC I and II (VDE 0701-0702) (IEC 60974-4)	Insulation resistance tests for PCI and II: on: activate off: deactivate
RINS at AP	Insulation resistance tests at application parts: on: activate off: deactivate
Measurement duration RINS probe	Insulation resistance test via probe: A measurement duration within a range of 0 to 60 seconds can be entered here. Default setting: 3 s
Measurement duration RINS AP	Insulation resistance tests at application parts: A measurement duration within a range of 0 to 60 seconds can be entered here. Default setting: 3 s
RINS pri./sec. (VDE 0701-0702) (IEC 60974-4)	Insulation resistance test between the primary and secondary sides of PCIII DUTs on: activate off: deactivate
RINS PC II as (VDE 0701-0702) (IEC 60974-4)	Insulation resistance test: Execute as individual or multiple measurement. Multiple measurement: Insulation resistance is measured between short-circuited mains terminals (L-N) and accessible, conductive parts which can be contacted with test probe P1 and are not connected to the housing, repeat as often as desired.
Measurement duration RINS PC II	Insulation resistance test: A measurement duration within a range of 0 to 60 seconds can be entered here. Default setting: 3 s
RINS sec./PE (VDE 0701-0702) (IEC 60974-4)	Insulation resistance test between the secondary side and PE of PCIII DUTs: on: activate off: deactivate
Leakage current tests	

Sequence Parameter	Meaning
Reverse polarity	Leakage current tests: On: Measurements are conducted with both polarities. Off: Measurement is only conducted with one/momentary polarity.
IPE (VDE 0701-0702) (IEC 60974-4)	Protective conductor current: on: activate off: deactivate
IPE measurement type (active) (VDE 0701-0702)	Protective conductor current test (mains to test socket): Measuring method: Direct or differential
IPE measurement duration (VDE 0701-0702) (IEC 60974-4)	Protective conductor current test: A measurement duration within a range of 0 to 60 seconds can be entered here. Default setting: 3 s
IE (IEC 62353)	Device leakage current test: on: activate off: deactivate
IE measurement type (active) (IEC 62353)	Device leakage current test (mains to test socket): Measuring method: Direct or differential
IE measurement duration (IEC 62353)	Device leakage current test: A measurement duration within a range of 0 to 60 seconds can be entered here. Default setting: 3 s
IT measurement type (active) (VDE 0701-0702)	Touch current test (mains to test socket): Measuring method: Direct P1 or differential P1 The "Differential P1" method is only advisable in this case if the device under test has ground connections which cannot be disconnected for testing.
IT (IEC 62353) (IEC 60601)	Touch current test on: activate off: deactivate
IT as (IEC 62353)	Touch current test: Execute as individual or multiple measurement. Multiple measurement: Various accessible, conductive parts are contacted with test probe P1 in order to measure current flowing to the protective conductor via the probe – repeat as often as desired.
IT measurement duration (IEC 62353)	Touch current test: A measurement duration within a range of 0 to 60 seconds can be entered here. Default setting: 3 s
IT welding circuit (IEC 60974-4)	Touch current test at welding circuit: on: activate off: deactivate
IT PC II as (IEC 60974-4)	Touch current test at welding circuit: Execute as individual or multiple measurement.
IT PC II measurement duration (IEC 60974-4)	Touch current test at welding circuit: A measurement duration within a range of 0 to 60 seconds can be entered here. Default setting: 3 s
IP AC (IEC 60601)	Patient leakage current AC: on: activate off: deactivate
IP DC (IEC 60601)	Patient leakage current DC: on: activate off: deactivate
IP measurement duration (IEC 60601)	Patient leakage current: A measurement duration within a range of 0 to 60 seconds can be entered here. Default setting: 3 s
Test conditions / fault conditions	
IA (IEC 62353)	Leakage current test at application part: on: activate off: deactivate
Measurement duration IA AP (IEC 62353)	Leakage current test at application part: A measurement duration within a range of 0 to 60 seconds can be entered here. Default setting: 3 s
Connection and fuse tests	
Short-circuit test L-N	Short-circuit test between L and N ¹ on: activate off: deactivate
Short-circuit test LN-PE	Short-circuit test between LN and PE1 ¹ on: activate off: deactivate
Display test instructions	Test instructions which are not necessarily required for experienced inspectors on: activate off: deactivate
Fuse test	Testing the fuses: Mains fuses, test probe fuse P1, application part fuses

Sequence Parameter	Meaning
Other parameters	
Open-circuit voltage (IEC 60974-4)	Open-circuit voltage at welding unit on: activate off: deactivate
Supply voltage PC III (VDE 0701-0702)	Supply voltage measurement (with PCIII DUTs, for measurement type "Active" only) on: activate off: deactivate
Testing of extension cords – additional parameters (VDE 0701-0702-VLTG)	
Continuity test	Testing of conductors (L, N, PE) for continuity with the help of the EL1/VL2E/AT3-III E adapter on: activate off: deactivate
Testing of PRCDs – additional parameters (VDE 0701-0702-PRCD)	
RPE IP (standard PRCD)	Protective conductor resistance test with standard PRCDs: Select test current IP: ± 200 mA= / 200 mA~ / Feature G01: 10 A~ / feature G02: 25 A~
Varistor test PRCD-K	Varistor test at type K PRCDs: on: activate off: deactivate
Sensor surface test	Testing of the sensor surface of the PRCD: on: activate off: deactivate
Man. tripping test	Manual tripping of the PRCD: on: activate off: deactivate
Time to trip	Tripping of the PRCD after xx seconds: on: activate off: deactivate

❑ Suppressing Test Steps

Depending on the selected test standard, some of the following test steps can be suppressed:

Parameter	Suppressible test steps
Visual inspection (1)	Visual inspection, standard
Visual inspection 2	Visual inspection, function test, welding units
Function test	Function test
RPE	Protective conductor resistance test
RINS PCI+II	Insulation resistance tests for PCI and PCII
RINS pri./sec.	Insulation resistance test between the primary and secondary sides of PCIII DUTs
RINS sec./PE	Insulation resistance test between the secondary side and PE of PCIII DUTs
RINS BF/CF (IEC 62353)	Insulation resistance tests at BF/CF application parts
RINS welding circuit (IEC 60974-4)	RINS tests between the primary side and the welding output, as well as between PE and the welding output
Reverse polarity	All leakage current measurements with reversed polarity
IPE measurement type (active)	Protective conductor current test
IT	Touch current test
IT welding circuit	Touch current test at welding circuit
Display test instructions	Test instructions which are not necessarily required for experienced inspectors
Short-circuit test L-N	Short-circuit test between L and N ¹
Short-circuit test LN-PE	Short-circuit test between LN and PE ¹
Open-circuit voltage (IEC 60974-4)	Open-circuit voltage at welding unit
Continuity Test (VLTG test only)	Continuity test with EL1/VL2E/AT3-III E adapter
PCIII supply voltage	Supply voltage measurement (with PCIII DUTs, for measurement type "Active" only)

¹ Before switching line voltage to the device under test, a short-circuit test is conducted regardless of this setting.

❑ Setting Measuring Parameters for Individual Test Steps

Depending on the selected test standard, some of the following test steps can be selected:

Parameter	Meaning
RPE IP	Select test circuit for protective conductor resistance test: 200 mA AC, ± 200 mA DC, 10 A AC ¹ or 25 A AC ²
IPE measurement type (active)	Set measurement type of the protective conductor current measurement for the active device test (differential/direct)
IE measurement type (active) (IEC 62353)	Set measurement type of the device leakage current measurement for the active device test (differential/direct)

¹ SECUTEST BASE10/PRO (feature G01)

² SECULIFE ST BASE25 (feature G02)

❑ Select between single and multiple measurement for individual test steps

Parameter (as of FW1.5.0)	Meaning
RPE as	Switch the "protective conductor resistance" test step back and forth between multiple and single measurement

Parameter (as of FW1.8.0)	Meaning
RINS PC II as	Switch back and forth between multiple and individual measurement for the insulation resistance measurement at PC II parts (measurements at application parts and welding outputs are not affected)
IT as	switch back and forth between multiple and individual measurement for the touch current measurement
IT PC II as	(IEC 60974 only) switch back and forth between multiple and individual measurement for touch current measurement at PC II parts

□ Setting Measurement Duration for Individual Test Steps

Testing time for the respective measurement can be influenced with these parameters. If a test step for a single measurement is involved, the entire test step has a duration of the time entered in seconds. If a test step for a multiple measurement is involved, the measurement duration for each measuring point is influenced.

If 0 seconds is selected, continuous measurement is conducted which can only be ended by the inspector by pressing a key.

Parameter (as of FW1.5.0)	Meaning
RPE measurement duration ¹	Set testing time for the protective conductor resistance measurement (0 to 60 seconds)
IPE measurement duration	Set testing time for the protective conductor current measurement (0 to 60 seconds)
IE measurement duration	Set testing time for the device leakage current measurement (0 to 60 seconds)

¹ In the case of test sequence VDE 0701-0702-PRCD with a setting of "PRCD type: PRCD (SPE)", measurement duration **cannot** be influenced. The measurement duration which has been set here only affects the RPE measurement with PRCD types "PRCD (standard)" and "PRCD-S (SPE)".

Parameter (as of FW1.8.0)	Meaning
IT measurement duration	Set testing time for touch current measurement (0 to 60 seconds)
IT PC II measurement duration	(for IEC 60974 only) Set testing time for touch current measurement at PC II parts (with the exception of welding outputs) (0 to 60 seconds)
RINS PC II measurement duration	Set testing time for RINS measurements and PC II parts (0 to 60 seconds)

10.5 Connecting the DUT

- ⇨ Connect the DUT to the test instrument in accordance with the selected test sequence.
 - Test socket
 - Permanent Connection
 - Adapter

Note concerning use of the AT3-IIIE test adapter

Please note that polarity reversal with the help of the utilized test instrument is not active when the AT3-IIIE adapter is used for testing single-phase DUTs (socket 3 / earthing contact). In this case, all leakage current measurements must be performed manually with the plug in **both** directions.

Switch settings A1 ... A7, AUTO



Connection depends on the type of DUT (see the respective connection type in the classification parameters tables).

Switch position A8

For testing extension cords in accordance with standards: connection to the test socket via the following adapter:

- **EL1:** For single-phase extension cords
- **VL2E:** For single and 3-phase extension cords

10.6 Selecting a Test Object

- ⇨ If no DUT has been selected in the initial display, enter its ID number (for example using a barcode scanner) after selecting ID.
- ⇨ Alternatively, activate the database view with the **MEM** key. 
- ⇨ Select the DUT for the test sequence with the scroll keys. 
- ⇨ Return to the measuring view by pressing the **ESC** key. 

10.7 Checking Connection and Starting the Test Sequence

- ⇨ Trigger the connection test and the test sequence by pressing the START key. 

The following checks are run automatically before the test sequence is started:

- Probe Test (as to whether or not to test probe P1 is connected and use link P1 is intact)



Attention!

If the fuse at test probe P1 is defective, all subsequent measurements using this measuring path are incorrectly evaluated as good!

- Insulation test (whether or not the DUT is set up in a well-insulated fashion)
- On test and short-circuit test (prerequisite: "short-circuit test L-N" sequence parameter is preset to "on". In order to be able to detect a short-circuit at the DUT, testing is conducted between L and N, as well as LN and PE.



Note

If you deselect important test steps under sequence parameter (set to off), the test sequence might not fulfill the requirements stipulated by the standard any more.

If you have set the "**Detected classification**" parameter for the respective test sequence to "Always accept" and the "**Auto-detection of**" parameter to "Connection and PC" (before triggering **Start**), the following additional checks will be run before the test sequence is started:

- Protection category detection for DUTs with protective conductor ^{*}

- Connection test ^{*}: Checks whether the DUT is connected to the test socket. In the case of protection category I: whether or not the two protective conductor terminals are short-circuited.



^{*} Applies to M7050 with feature B00 and B09

10.8 Executing and Evaluating Test Steps

Manual evaluation of visual inspection

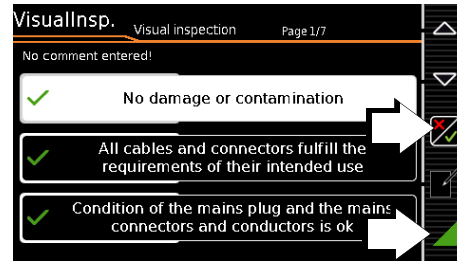
(prerequisite: "visual inspection" sequence parameter is preset to "on".)



- ⇨ Evaluate the visual inspection. 
- ⇨ If you mark even one visual inspection as not passed with the key shown at the right, the sequence is aborted and the test is evaluated as not passed.
- ⇨ Resume the test sequence. 

Connecting Line Voltage

Connecting line voltage to the test socket at the test instrument and performance of a function test are only permissible if the DUT has already passed the **safety test** (protective conductor resistance and insulation resistance measurements)!



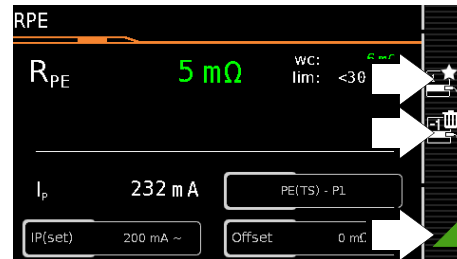

Do not start measurements at your test instrument unless it's in plain view. Do not connect line voltage to the test socket of your test instrument before the surrounding area has been secured.

Test Steps with Manual Evaluation (e.g. R_{PE})



- ⇨ Observe instructions which appear at the display, e.g. prompting to contact parts with test probe P1.

If the measured value appears green at the display, it lies within the limits specified by the standard.

- ⇨ The measured value recording symbol appears in the softkey bar. The 0 indicates that no measured values have thus far been saved to buffer memory. 
- ⇨ Each time this key is pressed, the measuring or evaluation procedure is restarted. 
- ⇨ Initially, the digit blinks (here a 1 without symbol) until the measured value settles in. The evaluation cycle is visualized as follows: the progress bar starts at the left-hand edge of the display and moves to the right. When it reaches the rightmost position, evaluation has been completed and the symbol shown at the right appears with the current number. 
- ⇨ Depending on whether you want to delete the last value saved to the clipboard or all values, press the symbol with the wastebasket shown at the right an appropriate number of times. 
- ⇨ Proceed to the next measurement by pressing the key shown at the right. 



Attention!

Limit value violation

If the measured value appears red at the display, a limit value has been violated. If you nevertheless start the evaluation procedure, an error message appears. You have the option of repeating the evaluation procedure.

If **Continue** is selected for the "Limit Violation" option in SETUP (Auto Measurements 2/3), the test instrument continues testing despite any limit value violations. In this case, the device under test is operated with line voltage despite any insulation faults or the like. Make sure that the device under test is secured, in particular against contact during the testing process.



10.9 Setting Limit Values Manually

If "Expert" is selected instead of "Normal" in setup under "Auto Measurements" in the "Limit Value Mode" submenu, the LIMIT softkey appears next to the "measurement failed" popup. This key makes it possible to enter a user-defined limit value (as a rule a limit value specified by the manufacturer which deviates from the standard):



Note

Selecting "Continue" or "Try Again" rules out the possibility of entering a limit value.

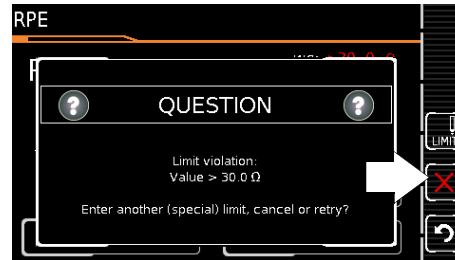

10.10 Ending the Test Sequence

"Sequence finished" appears at the display.

Initial Display (memory screen)

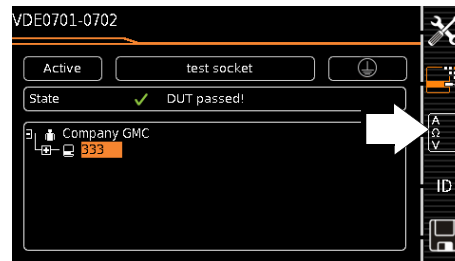

Display of the memory screen depends on the setting in the setup menu in the **SETUP** switch position:

Setup 1/3 > Auto Measurements > At End of Sequence > "Memory Screen".

If set to **Results list**, the above display is skipped and the results list shown below is displayed.

You can also access the results list by pressing the key shown at the right.



Results List Display



Select the desired test step with the scroll keys.

If you want to view details for the selected test step, press the **magnifying glass+** key.

You can still select from amongst 3 report views (see below).



Note

Regarding the test sequence in switch position A6/A7:

Section 5.2 of DIN EN 60974-4 expressly stipulates that the cables have to be bent and twisted over their entire length during the measurement, in particular in proximity to the cable glands, in order to be able to detect any interruptions of the protective conductor.

Test Steps with Automatic Evaluation (R_{INS}, I_{PE})

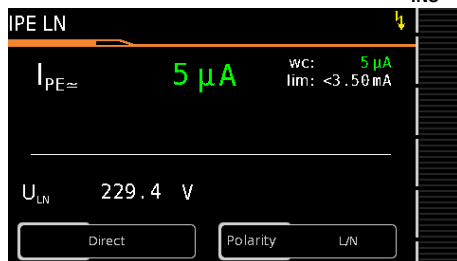

The measured value is ascertained automatically within a specified period of time. The evaluation cycle is visualized as follows: the progress bar starts at the left-hand edge of the display and moves to the right. When it reaches the rightmost position, evaluation has been completed. The test sequence is then automatically resumed.

Manual Evaluation of the Function Test

(prerequisite: "function test" sequence parameter is preset to "on".)

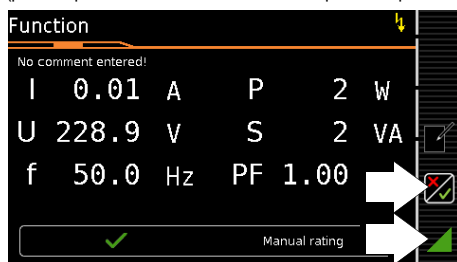

Evaluate the function test:

If you mark the function test as not passed with the softkey shown at the right, the sequence is aborted and the test is evaluated as not passed.

If you evaluate the function test as passed, you can simply continue with the test sequence.

In either case you can enter a comment, which can be subsequently edited as well.



Filter Icon	Meaning of the Selectable Report View
	During report display: show complete test report
	During report display: show summarized (abridged) test report *
	During report display: show failed test steps only

* Skipped test steps are not shown in the abridged view – only the worst measured value for each measurement type is shown.

Taking measuring error into consideration depends on the setting in the setup menu in the **SETUP** switch position: Setup 1/3 > Auto Measurements> BMU Considered. > **Yes**)

Display of Details for Individual Test Steps

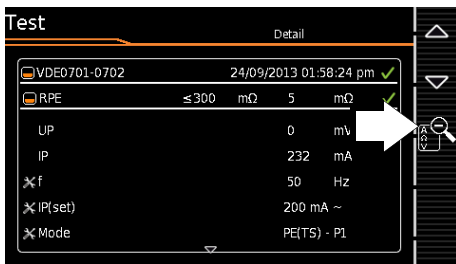

- ⇒ The display is returned to the list of test steps by pressing the **magnifying glass** key.
- ⇒ The memory screen is displayed again after acknowledging the list.

10.11 Saving Test Results

- ⇒ Save the results of a successful test sequence by pressing the **Save** key.

or

- 1 Send measurement data to PC (feature KD01, “Z853S – SECUTEST DB COMFORT”) via USB or *Bluetooth*[®] (feature M01), e.g. for saving to **IZYTRONIQ** report generating software (push-print function) (see **IZYTRONIQ** online help for description)

Observe notes regarding storage in section 7.

11 Warnings, Error Messages and Notes

Error messages or notes regarding the individual tests or test sequences are displayed as popups.

Differentiation is made amongst 5 types of messages:

- Fatal error
- Error
- Warning
- Note – INFO
- Question

Fatal error

This message indicates an extraordinary error. Fatal errors have to be acknowledged or cleared by pressing the **OK** key, and the cause of error must be eliminated before the test or the test sequence can be resumed.



Error

This message indicates, for example, operator errors. These errors have to be acknowledged or cleared by pressing the **OK** key, and the cause of error must be eliminated before the test or the test sequence can be resumed.

Examples:

- Object cannot be created. General database error!

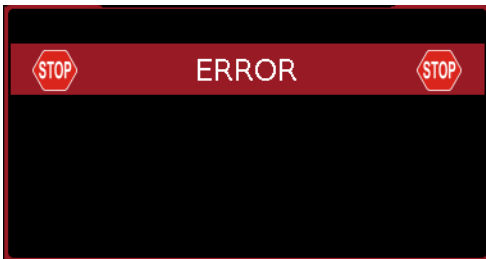

Warning

Warnings indicate hazards which, if not avoided, may result in severe injury. **Single test:** The warning has to be acknowledged or cleared by pressing the **OK** key before the test or the test sequence can be resumed.

Test sequence: The test sequence can be aborted or resumed without acknowledging.

Examples:

- Caution: Line voltage will be switched to the test socket!
- Caution: Line voltage polarity will be reversed at the test socket!



Note – INFO

A note is either information regarding the functions executed by the test instrument or instructions which may have to be acknowledged or skipped by pressing the **OK** key.

Examples:

- Probe Test
- Set up in a well-insulated fashion?
- On test
- Short-circuit test (L-N)
- Short-circuit test (LN-PE)
- Prompt: Contact with test probe P1 ...
- Prompt: Switch the DUT on/off with its own mains switch ...
- Prompt: Start up / shut down the DUT ...

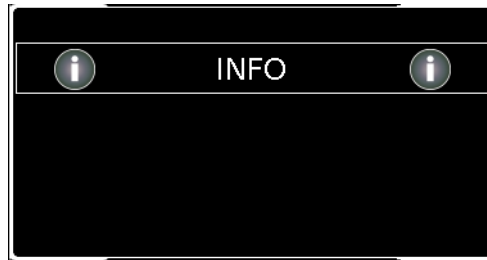



Question

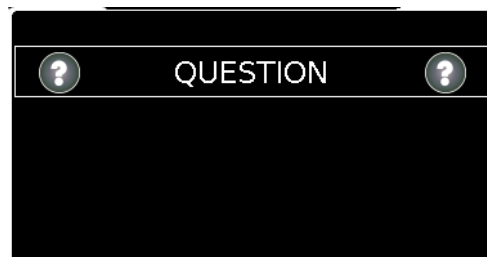

Questions must be answered by pressing **Yes** or **No** before the single test or test sequence is resumed.

Example:

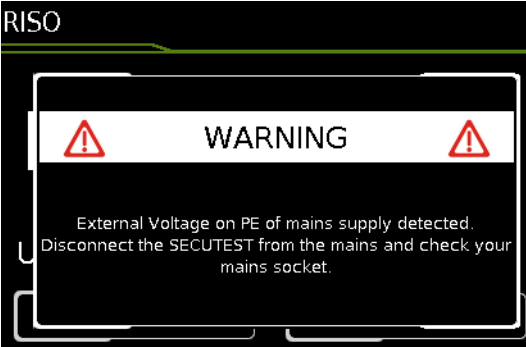
- Device not found!
Create new object/database?

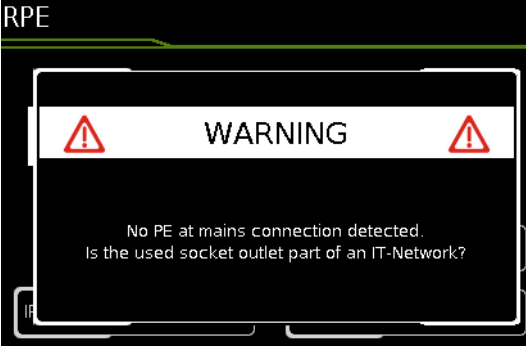
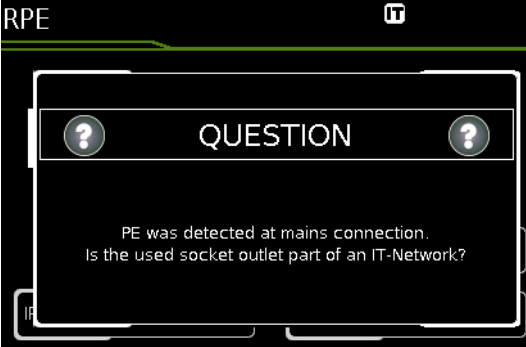
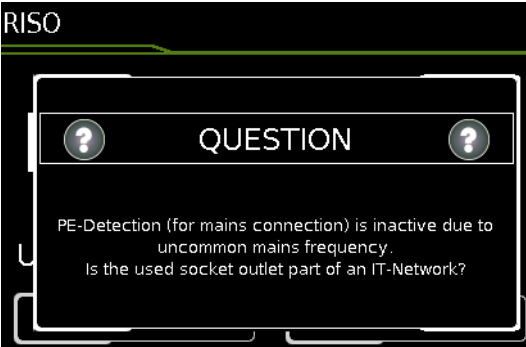

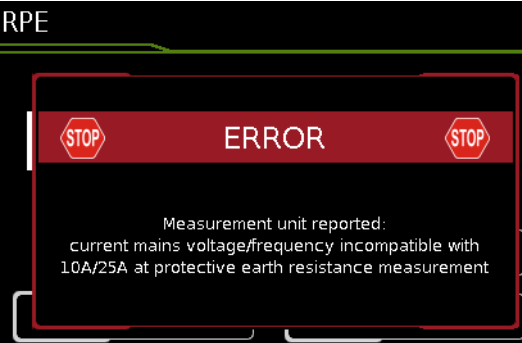
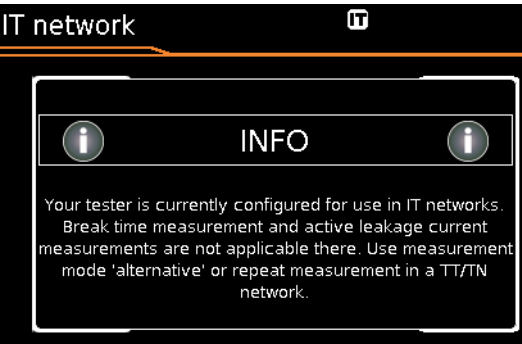

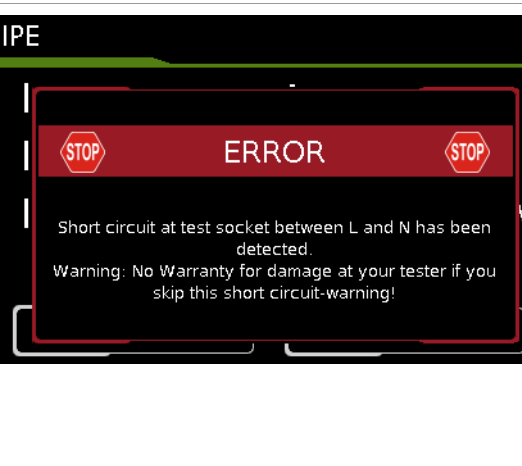

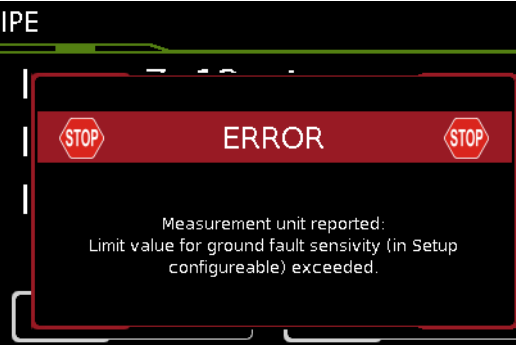
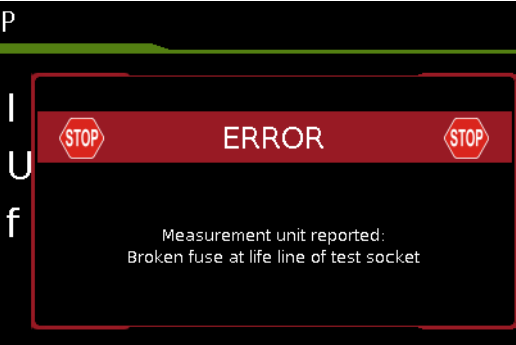
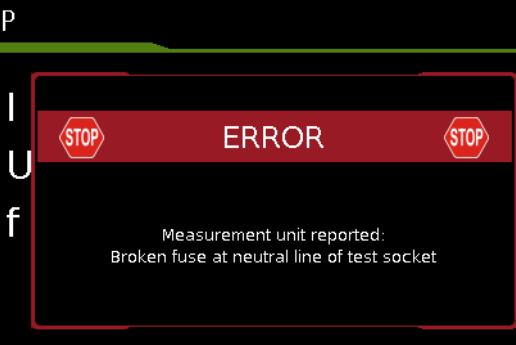
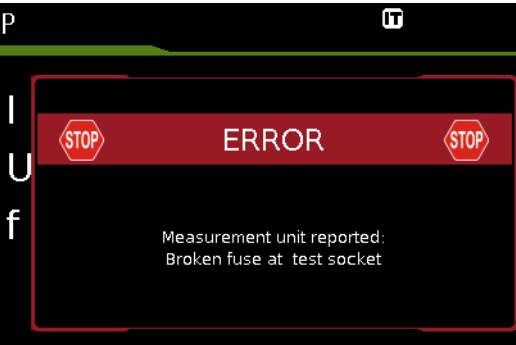
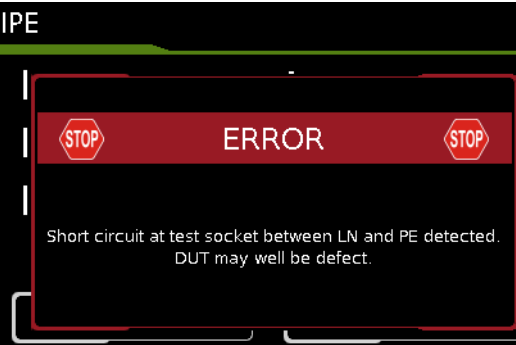
Error Messages	Possible Causes	Corrective Measures
Mains Connection Errors		
<p>RISO</p> 	<ul style="list-style-type: none"> – Protective conductor PE at the mains outlet at which the SECUTEST is being operated is conducting voltage! This detection function makes use of the metallized START/STOP key on the test instrument. In order for detection to function correctly, it must be possible to establish reference to earth potential via the user's finger. <p>Note  If the user's finger is insulated from the key when it's pressed, this error message may occur although the installation is OK (see "Automatic Recognition of Mains Connection Errors" on page 10).</p>	<ul style="list-style-type: none"> ⇨ Please remove the SECUTEST's mains plug from this outlet and arrange to have the outlet/installation inspected by a qualified electrician without delay. Do not operate any other devices at this electrical outlet before this inspection has been completed. ⇨ In order to ensure that detection functions reliably, repeat the interference voltage test and observe the following tips: <ul style="list-style-type: none"> – Unplug all USB devices from the SECUTEST's USB ports. – Remain in contact with a grounded object while pressing the START/STOP key (e.g. a heating pipe). – Do not contact the START/STOP key with an object or while wearing gloves.
<p>RPE</p> 	<p>PE connection not detected (at the outlet at which the test instrument is being operated):</p> <ul style="list-style-type: none"> – If the installation is defective! – In the case of special types of TT systems; detection may fail in this case. – If the test instrument is being operated in an IT system 	<ul style="list-style-type: none"> ⇨ If the test instrument is being operated in an IT system: Acknowledge the question by pressing ✓ – the IT system option is activated in this case. ⇨ If it's not an IT system: remove the mains plug from the outlet and inspect the installation without delay! ⇨ If it's a TT system without neutral conductor, press ✗; direct leakage current measurements are possible. (Please make absolutely sure that direct leakage current measurements are possible in your current mains type!)
<p>RPE</p> 	<p>As opposed to the previously used mains connection, PE was detected while the IT system option was activated in setup.</p>	<ul style="list-style-type: none"> ⇨ Operation in an IT system: Respond to the question by pressing ✓. The IT system option remains active as a result. ⇨ Operation in a TN or TT system: Respond to the question by pressing ✗. As a consequence, the IT system option is deactivated.
<p>RISO</p> 	<p>Line frequency is less than 48 or greater than 62 Hz.</p>	<ul style="list-style-type: none"> ⇨ PE detection does not work in this case: select ✓ or ✗, depending on whether or not the utilized system is an IT system.



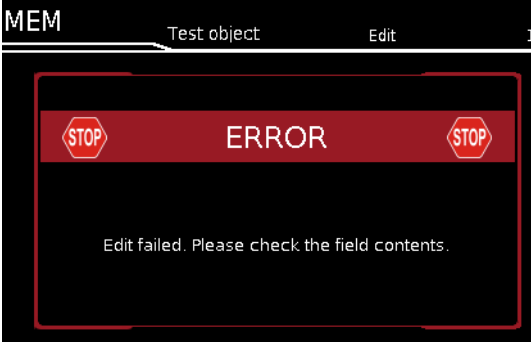

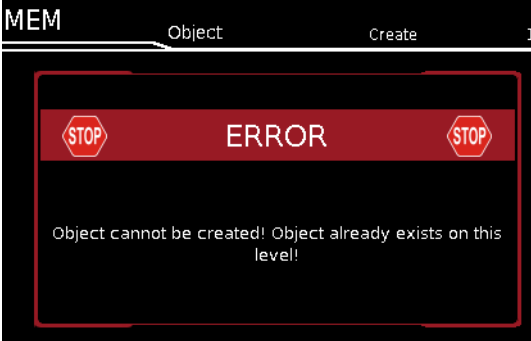
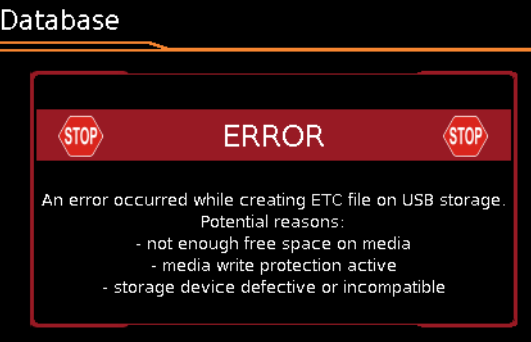
Error Messages	Possible Causes	Corrective Measures
<p>RPE</p> 	<ul style="list-style-type: none"> – Momentary line voltage at the SECUTEST test instrument is outside of the range permitted for a 10 A/25 A-R_{PE} measurement (110 to 120 V or 220 to 240 V). 	<ul style="list-style-type: none"> ⇨ The 10 A/25 A-R_{PE} measurement is only available when line voltage is between 220 V and 240 V or 110 V and 120 V at 50 Hz or 60 Hz. ⇨ If you're working with the SECUTEST in a system which does not lie within this voltage range, use one of the 200 mA test currents in order to determine protective conductor resistance.
<p>IT network</p> 	<ul style="list-style-type: none"> – IT system option (see section 4.1.1, "Measurements in IT Systems") is activated. An attempt has been made to start an active leakage current measurement or a measurement with reference to PE at the mains connection end (or a test sequence which includes such measurements). 	<ul style="list-style-type: none"> ⇨ Select measurement type "passive". or ⇨ Conduct the desired tests in a TT/TN system instead of an IT system and configure the SECUTEST accordingly. or ⇨ Deactivate leakage current measurements in the sequence parameters if possible.
Connection Error at the Test Socket		
<p>RPE</p> 	<ul style="list-style-type: none"> – Test probe P1 is not connected. or – The test instrument's 10 A/25 A transformer is overheated. or – One of the fuses has blown (fuse holder in close proximity to the mains input). 	<ul style="list-style-type: none"> ⇨ Repeat measurement with probe P1 connected. ⇨ Check the fuses and replace if necessary. ⇨ Select a different test current (e.g. 200 mA) or wait until the transformer has cooled down and then repeat the measurement. <div style="border: 1px solid black; padding: 5px; margin-top: 10px;">  <p>Attention! The 10 A/25 A measurement is not suitable for continuous operation!</p> </div>
<p>IPE</p> 	<ul style="list-style-type: none"> – A short-circuit has been detected at the test socket between L and N. 	<ul style="list-style-type: none"> ⇨ Determine whether or not the device under test is defective. ⇨ In the case of DUTs which are intended for operation at an outlet that's protected with a 16 A fuse, a short-circuit may be detected under certain circumstances if, for example, they include a PTC resistor (e.g. large floodlights). Be sure to use a 3-phase test adapter in order to test devices of this sort (e.g. the AT3-III E). ⇨ You can skip this short-circuit message at your own risk and place the device under test into service. Any damage resulting from skipping this warning is excluded from the guarantee!

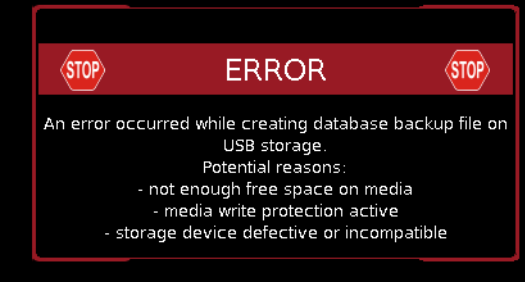
Error Messages	Possible Causes	Corrective Measures
<p>IPE</p> 	<ul style="list-style-type: none"> - A device under test is connected to the SECUTEST and has been started up, whose leakage current (measured by means of the differential current method) exceeds the limit value specified in setup. 	<ul style="list-style-type: none"> ⇒ If the device under test normally generates a leakage current of greater than 10 mA (e.g. large heaters), temporarily increase the "residual current protection" value selected in setup to 30 mA and try again. ⇒ If values of this magnitude are not to be expected for the respective device under test, or if the "residual current protection" value has already been set to 30 mA in Setup, there may be a ground fault at the DUT.
<p>P</p> 	<ul style="list-style-type: none"> - The fuse for the test socket's L conductor has blown (fuse link 2). 	<ul style="list-style-type: none"> ⇒ Disconnect the test instrument from the mains and inspect the fuses next to the SECUTEST's mains connection.
<p>P</p> 	<ul style="list-style-type: none"> - The fuse for the test socket's N conductor has blown (fuse link 1). 	<ul style="list-style-type: none"> ⇒ Disconnect the test instrument from the mains and inspect the fuses next to the SECUTEST's mains connection.
<p>P</p> 	<ul style="list-style-type: none"> - One of the two fuses for the test socket has blown (fuse link 1 or 2). 	<ul style="list-style-type: none"> ⇒ Disconnect the test instrument from the mains and inspect the fuses next to the SECUTEST's mains connection.
<p>IPE</p> 	<ul style="list-style-type: none"> - A short-circuit has been detected at the test socket between L/N and PE. 	<ul style="list-style-type: none"> ⇒ Determine whether or not the device under test is defective. Repeat the visual inspection.

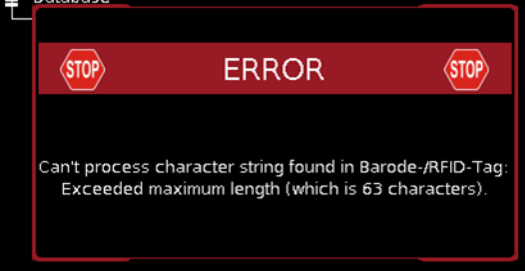
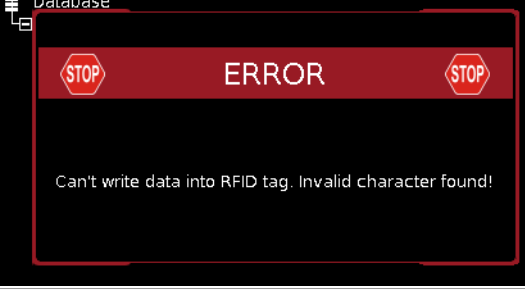
Error Messages	Possible Causes	Corrective Measures
<p>VDE 0701-0702</p> <p>The screenshot shows a black background with a white border. At the top, it says 'VDE 0701-0702'. Below that, a white bar contains the word 'WARNING' in black, flanked by two red warning triangles. Underneath, the text reads 'Short Circuit at TestSocket between L and N!'.</p>	<ul style="list-style-type: none"> - A short-circuit has been detected at the test socket between L and N. 	<ul style="list-style-type: none"> ⇨ Determine whether or not the device under test is defective. ⇨ In the case of DUTs which are intended for operation at an outlet that's protected with a 16 A fuse, a short-circuit may be detected under certain circumstances if, for example, they include a PTC resistor (e.g. large floodlights). Be sure to use a 3-phase test adapter in order to test devices of this sort (e.g. the AT3-IIIIE). ⇨ You can deactivate this short-circuit test in the sequence parameters at your own risk.
<p>VDE 0701-0702</p> <p>The screenshot shows a black background with a white border. At the top, it says 'VDE 0701-0702'. Below that, a white bar contains the word 'WARNING' in black, flanked by two red warning triangles. Underneath, the text reads 'Short Circuit at TestSocket between L/N and PE!'.</p>	<ul style="list-style-type: none"> - A short-circuit has been detected at the test socket between L/N and PE. 	<ul style="list-style-type: none"> ⇨ Determine whether or not the device under test is defective. Repeat the visual inspection.
General Application Errors		
<p>Testing persons management</p> <p>The screenshot shows a black background with a white border. At the top, it says 'Testing persons management'. Below that, a red bar contains the word 'ERROR' in white, flanked by two red octagonal 'STOP' signs. Underneath, the text reads 'Attention: Cannot delete the currently logged in testing person! Please select another testing person before deletion.'</p>	<ul style="list-style-type: none"> - The inspector to be deleted is currently selected and thus cannot be deleted! 	<ul style="list-style-type: none"> ⇨ Activate a different inspector before deleting.
<p>Measurement unit reported error!</p> <p>The screenshot shows a black background with a white border. At the top, it says 'Measurement unit reported error!'. Below that, a red bar contains the word 'ERROR' in white, flanked by two red octagonal 'STOP' signs. Underneath, the text reads 'Measurement unit reported: The 25A transformer timed out. 25A power source will be available again when it has cooled down. Other test currents are available anyway.'</p>	<ul style="list-style-type: none"> - The 25 A measurements takes too long. or - The 25 A measurement has been executed too often (without pauses). 	<ul style="list-style-type: none"> ⇨ Wait until the test instrument has cooled down and then restart the measurement.

Error Messages	Possible Causes	Corrective Measures
Database Processing Error		
 <p>MEM Test object Edit 1</p> <p>ERROR</p> <p>Edit failed. Please check the field contents.</p>	<ul style="list-style-type: none"> – One of the fields was filled in with invalid content while processing an existing database object. 	<ul style="list-style-type: none"> ⇨ Please be certain to complete all mandatory fields (identified in red). ⇨ If necessary, check your entries to the fields for invalid special characters.
 <p>MEM Test object Create 1</p> <p>ERROR</p> <p>Object cannot be created! Mandatory field is empty!</p>	<ul style="list-style-type: none"> – The ID field was not filled in while creating a new device. 	<ul style="list-style-type: none"> ⇨ Fill in the ID field.
 <p>MEM Object Create 1</p> <p>ERROR</p> <p>Object cannot be created! Object already exists on this level!</p>	<ul style="list-style-type: none"> – There's already an object with the same ID under the "Customer" database object. 	<p>An incorrect barcode has been selected.</p> <ul style="list-style-type: none"> ⇨ Assign another ID.
 <p>Database</p> <p>ERROR</p> <p>An error occurred while creating ETC file on USB storage. Potential reasons: - not enough free space on media - media write protection active - storage device defective or incompatible</p>	<p>Error while writing the "secu" file to the USB flash drive</p> <p>There's not (no longer) enough available memory space on the storage medium.</p> <ul style="list-style-type: none"> – In particular in the case of FAT16 formatted USB flash drives: Too many files on the USB flash drive – Power consumption of the utilized USB flash drive exceeds 500 mA. – The USB flash drive has been disconnected during data import. – The USB flash drive is defective or incompatible with the SECUTEST. 	<p>Make sure that at least 100 MB is available on the USB flash drive or delete any data files which are no longer required.</p> <ul style="list-style-type: none"> ⇨ If the problem persists, save the data from the USB flash drive on another storage device and reformat the USB flash drive (FAT32). ⇨ Only use USB flash drives with power consumption of less than 500 mA in combination with the SECUTEST. ⇨ Make sure that the USB flash drive is not disconnected or moved until the entire data export process has been completed. ⇨ If none of these measures results in improvement, replace the USB flash drive. A list of tested USB flash drives is included in section 14.3.

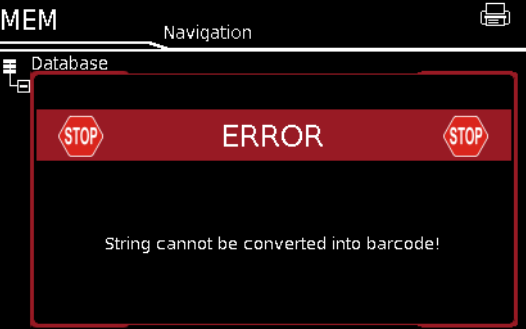
Error Messages	Possible Causes	Corrective Measures
<p>Database</p> 	<p>Error while writing the data backup file to the USB flash drive</p> <p>There's not (no longer) enough available memory space on the storage medium.</p> <ul style="list-style-type: none"> - In particular in the case of FAT16 formatted USB flash drives: Too many files on the USB flash drive - Power consumption of the utilized USB flash drive exceeds 500 mA. - The USB flash drive was disconnected during data import. - The USB flash drive is defective or incompatible with the SECUTEST. 	<ul style="list-style-type: none"> ⇨ Make sure that a at least 100 MB is available on the USB flash drive or delete any data files which are no longer required. ⇨ If the problem persists, save the data from the USB flash drive on another storage device and reformat the USB flash drive (FAT32). ⇨ Only use USB flash drives with power consumption of less than 500 mA in combination with the SECUTEST. ⇨ Make sure that the USB flash drive is not disconnected or moved until the entire data backup process has been completed. ⇨ If none of these measures results in improvement, replace the USB flash drive. A list of tested USB flash drives is included in section 14.3.
<p>Move object</p> 	<p>Moving of an object has failed</p> <p>Moving a test object would lead to an ID conflict. The ID already exists for this customer.</p>	<ul style="list-style-type: none"> ⇨ Delete the object with duplicate ID. ⇨ Select another customer as a relocation target.
Errors during Operation with Barcode Scanner or RFID Scanner		
<p>Barcode/RFID Processing-Error</p> <p>Database</p> 	<ul style="list-style-type: none"> - The scanned barcode is too long. 	
<p>MEM Navigation</p> <p>Database</p> 	<ul style="list-style-type: none"> - While writing an RFID tag an attempt was made to write an ID to the tag with vowel mutations such as ä, ü or ö, or with special characters. 	<ul style="list-style-type: none"> ⇨ Change vowel mutations such as ä to ae. ⇨ Avoid the use of special characters in the ID.

Error Messages	Possible Causes	Corrective Measures
Printer Connection Error		
 <p>MEM Navigation Database</p> <p>ERROR</p> <p>Please connect printer.</p>	<ul style="list-style-type: none"> - The printer is not connected. - An incompatible printer has been connected. 	<ul style="list-style-type: none"> ⇒ Connect the printer to the USB port before pressing the PRINT key. ⇒ Make sure that the utilized printer is listed in section 14.1, "List of Suitable Printers with USB Port".
 <p>MEM Navigation Database</p> <p>ERROR</p> <p>Printer error - code: 1!</p>	<ul style="list-style-type: none"> - No recording chart in the thermal printer. - The printer is defective. 	<ul style="list-style-type: none"> ⇒ Insert a new recording chart.
 <p>MEM Navigation Database</p> <p>ERROR</p> <p>String cannot be converted into barcode!</p>	<ul style="list-style-type: none"> - The device ID to be printed as a barcode contains an inadmissible character, for example vowel mutation or special character, or it fails to conform to the conventions which apply to the selected barcode encryption type (e.g. EAN 13: only numeric characters, overall length 13 characters, last character as check digit only). 	<ul style="list-style-type: none"> ⇒ Select other barcode encryption (SETUP => Printer => Z721E => Printer Settings => Encryption) ⇒ Change vowel mutations such as ä to ae. ⇒ Avoid the use of special characters in the ID. ⇒ Adjust the ID to the specified length for the selected type of barcode encryption.
 <p>Printer</p> <p>ERROR</p> <p>Detected 6mm or 3.5mm tape in Printer - too small for 2D-Code Printing. Replace by a wider tape cartridge (12mm or above is recommended for 2D-Code-Printing) or choose a (1D-)barcode-type via SETUP.</p>	<ul style="list-style-type: none"> - A 3.5 or 6 mm tape cartridge has been inserted into the printer – these tape sizes are inappropriate for 2D code printing. 	<ul style="list-style-type: none"> ⇒ Insert cartridges with a tape width of 9 mm (or preferably 12 mm or more) and repeat printing. or ⇒ Change to CODE128, CODE39 or EAN13 in SETUP.
 <p>Printer</p> <p>ERROR</p> <p>Detected 9mm tape in Printer - too small for QR-Code Printing. Replace by a wider tape cartridge (12mm or above is recommended for 2D-Code-Printing) or choose a (1D-)barcode-type via SETUP.</p>	<ul style="list-style-type: none"> - A 9 mm tape cartridge has been inserted into the printer – this tape size is inappropriate for QR code label printing. 	<ul style="list-style-type: none"> ⇒ Insert a cartridge with a tape width of 12 mm and repeat printing. or ⇒ Change to another output format in SETUP (MicroQR code, DataMatrix, Aztec, Code128, Code39 or EAN13).

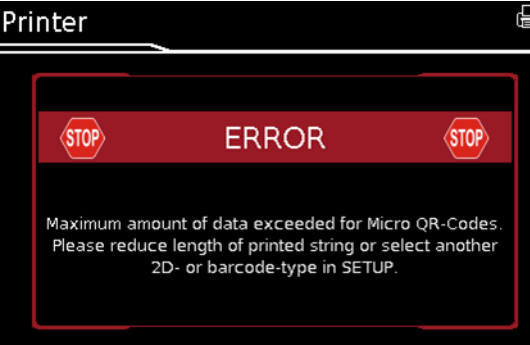
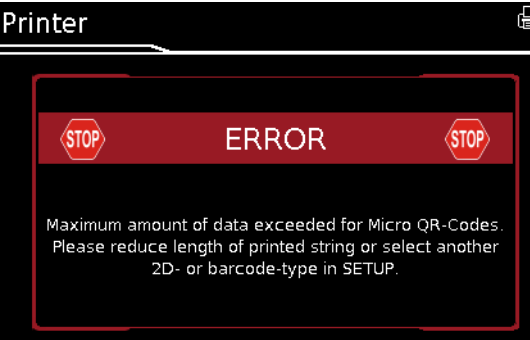
Error Messages	Possible Causes	Corrective Measures
 <p>The screenshot shows a printer's error display. At the top, the word 'Printer' is visible. Below it, a red banner with the word 'ERROR' in white capital letters is flanked by two red octagonal 'STOP' signs. Underneath the banner, the following text is displayed: 'Maximum amount of data exceeded for Micro QR-Codes. Please reduce length of printed string or select another 2D- or barcode-type in SETUP.'</p>	<ul style="list-style-type: none"> - Too many data in the ID to be printed as a Micro QR code. 	<ul style="list-style-type: none"> ⇒ Shorten the ID or change to another output format in SETUP (QR Code, DataMatrix, Aztec, Code128, Code39, EAN13).
 <p>This screenshot is identical to the one above, showing the same printer error message: 'Maximum amount of data exceeded for Micro QR-Codes. Please reduce length of printed string or select another 2D- or barcode-type in SETUP.'</p>	<ul style="list-style-type: none"> - The ID is too long to be printed as a Micro QR code. 	

11.2 List of Possible DUT Connections Depending on Measurement Type

Measurement Type	Suitable for DUT Connection via
RPE	
PE(TS) - P1 passive	Test socket, EL1 test socket, VL2E, AT3-III E, AT3-IIS, AT3-IIS32, AT16DI/AT32DI
PE(TS) - P1 active	Test socket (for PRCDs)
PE(mains) - P1	Permanent connection
PE(mains) - P1 clamp	Permanent connection
P1 - P2	Permanent connection
RINS	
LN(TS) - PE(TS)	Test socket, EL1, VL2E, AT3-III E, AT3-IIS, AT3-IIS32, AT16DI/AT32DI, CEE adapter
LN(TS) - P1	Test socket, VL2E, AT3-III E, AT3-IIS, AT3-IIS32, AT16DI/AT32DI
P1 - P2	No connection (PC3)
PE(mains) - P1	Permanent connection
PE(TS) - P1	Test socket
LN(TS) - P1//PE(TS)	Test socket, VL2E, AT3-III E, AT3-IIS, AT3-IIS32, AT16DI/AT32DI
IPE	
Direct	Test socket, AT16DI/AT32DI (direct or diff.)
Differential	Test socket
Alternative	Test socket, VL2E, AT3-III E, AT3-IIS, AT3-IIS32, AT16DI/AT32DI
AT3 adapter	AT3-III E, AT3-IIS, AT3-IIS32
Clamp	Permanent connection
IT	
Direct	Test socket, AT3-III E, AT3-IIS, AT3-IIS32, AT16DI/AT32DI
Differential	Test socket
Alternative (P1)	Test socket, AT3-III E, AT3-IIS, AT3-IIS32, AT16DI/AT32DI, VL2E
Permanent connection	Permanent connection
Alternative (P1–P2)	No connection (PC3)
IE	
Direct	Test socket, AT16DI/AT32DI (only diff. is sensible)
Differential	Test socket
Alternative	Test socket, AT16DI/AT32DI
AT3 adapter	AT3-III E, AT3-IIS, AT3-IIS32
Clamp	Permanent connection
IA	
Direct (P1)	Test socket
Alternative (P1)	Test socket
Perm. con. (P1)	Permanent connection
IP	
Direct (P1)	Test socket
Perm. con. (P1)	Permanent connection
U probe	
PE - P1	Permanent connection
PE - P1 (with mains)	Test socket
U meas.	
V - COM	Permanent connection
V - COM (with mains)	Test socket
tA	
mains to test socket	Test socket
P	
Function test	Test socket, AT3-III E, AT3-IIS, AT3-IIS32, AT16DI/AT32DI, CEE adapter
EL1	
EL1 adapter	EL1 and test socket
AT3-III E adapter	AT3-III E
VL2E adapter	VL2E
Temperature	
V-COM PT100(0)	Permanent connection
Current (via clamp)	
V-COM	Permanent connection
V-COM (with mains)	Test socket

Measurement Type	Suitable for DUT Connection via
PRCD time to trip	
—	Test socket

12 Characteristic Values

Function	Measured Quantity	Display Range/ Nominal Range of Use	Resolution	Nominal Voltage U_N	Open-Circuit Voltage U_0	Nominal Current I_N	Short-Circuit Current I_K	Internal Resistance R_I	Reference Resistance R_{REF}	Measuring Uncertainty	Intrinsic Uncertainty	Overload Capacity	
												Value	Time
Tests, 62638 (DIN VDE 071-0702) / IEC 62353 (VDE 0751)	Protective conductor resistance RPE	1 ... 999 m Ω	1 m Ω	—	< 24 V AC or DC	—	> 200 mA AC / DC > 10 A AC ₅	—	—	$\pm(15\% \text{ rdg.} + 10 \text{ d})$ > 10 d > 10.0 Ω : $\pm(10\% \text{ rdg.} + 10 \text{ d})$	$\pm(10\% \text{ rdg.} + 10 \text{ d})$ > 10 d	264 V 250 mA	Continu- ous
		1.00 ... 9.99 Ω	10 m Ω									16 A AC ₅	
		10.0 ... 27.0 Ω	100 m Ω									> 42 A AC ₁₁	
	Insulation resistance ⁹ RINS	10 ... 999 k Ω	1 k Ω	50 ... 500 V DC	1.0 • U_N ... 1.5 • U_N	> 1 mA	< 2 mA	—	—	$\pm(5\% \text{ rdg.} + 4 \text{ d})$ > 10 d $\geq 20 \text{ M}\Omega$: $\pm(10\% \text{ rdg.} + 8 \text{ d})$	$\pm(2.5\% \text{ rdg.} + 2 \text{ d})$ > 10 d $\geq 20 \text{ M}\Omega$: $\pm(5\% \text{ rdg.} + 4 \text{ d})$	264 V	Continu- ous
		1.00 ... 9.99 M Ω	10 k Ω										
		10.0 ... 99.9 M Ω	100 k Ω										
	Leakage current Alternative Measurement ² IPE, IT, IE, IA	0 ... 99 μ A	1 μ A	—	50 ... 250 V~ –20/+10%	—	< 1.5 mA	> 150 k Ω	1 k Ω $\pm 10 \Omega$	$\pm(5\% \text{ rdg.} + 4 \text{ d})$ > 10 d > 15 mA: $\pm(10\% \text{ rdg.} + 8 \text{ d})$	$\pm(2\% \text{ rdg.} + 2 \text{ d})$ > 10 d > 15 mA: $\pm(5\% \text{ rdg.} + 4 \text{ d})$	264 V	Continu- ous
		100 ... 999 μ A	1 μ A										
		1.00 ... 9.99 mA	10 μ A										
	Leakage current Direct measurement ³ IPE, IT, IE, IA, IP	Ip only: 0.0 ... 99.9 μ A	100 nA	—	—	—	—	—	1 k Ω $\pm 10 \Omega$	$\pm(5\% \text{ rdg.} + 4 \text{ d})$ > 10 d	$\pm(2.5\% \text{ rdg.} + 2 \text{ d})$ > 10 d	264 V	Continu- ous
		0 ... 99 μ A	1 μ A										
		100 ... 999 μ A	1 μ A										
		1.00 ... 9.99 mA	10 μ A										
	Leakage current Differential current measurement ⁴ IPE, IT, IE	0 ... 99 μ A	1 μ A	—	—	—	—	—	—	$\pm(5\% \text{ rdg.} + 4 \text{ d})$ > 10 d	$\pm(2.5\% \text{ rdg.} + 2 \text{ d})$ > 10 d	264 V	Continu- ous
		100 ... 999 μ A	1 μ A										
		1.00 ... 9.99 mA	10 μ A										
10.0 ... 30.0 mA		100 μ A											
Function test at the test socket	Line voltage U_{L-N} ¹⁰	100.0 ... 240.0 V~	0.1 V	—	—	—	—	—	—	—	$\pm(2\% \text{ rdg.} + 2 \text{ d})$	264 V	Continu- ous
	Load current I_L	0 ... 16.00 A _{RMS}	10 mA	—	—	—	—	—	—	—	$\pm(2\% \text{ rdg.} + 2 \text{ d})$	16 A	Continu- ous
	Active power P	0 ... 3700 W	1 W	—	—	—	—	—	—	—	$\pm(5\% \text{ rdg.} + 10 \text{ d})$ > 20 d	264 V	Continu- ous
	Apparent power S	0 ... 4000 VA	1 VA	Calculated value, $U_{L-N} \cdot I_V$							$\pm(5\% \text{ rdg.} + 10 \text{ d})$ > 20 d	264 V	Continu- ous
	Power factor PF with sinusoidal waveform: $\cos\phi$	0.00 ... 1.00	0.01	Calculated value, P / S, display > 10 W							$\pm(10\% \text{ rdg.} + 5 \text{ d})$	264 V	Continu- ous
	Line frequency f	0 ... 420.0 Hz	0.1 Hz	—	—	—	—	—	—	—	$\pm(2\% \text{ rdg.} + 2 \text{ d})$	264 V	Continu- ous
$t_{A,PRCD}$	Time to Trip	0.1 ... 999 ms	0.1 ms	—	—	30 mA	—	—	—	$\pm 5 \text{ ms}$	—	264 V	Continu- ous
Voltage measurement	Probe voltage (probe P1 to PE) $\overline{\sim}$, \sim and $\overline{\sim}$	0.0 ... 99.9 V 100 ... 264 V	100 mV 1 V	—	—	—	—	3 M Ω 1 M Ω	—	—	$\pm(2\% \text{ rdg.} + 2 \text{ d})$ $\pm(2\% \text{ rdg.} + 5 \text{ d})$ $\pm(5\% \text{ rdg.} + 5 \text{ d})$ > 10 kHz ... 20 kHz	264 V	Continu- ous
	Measuring voltage (V-COM sockets ⁶) $\overline{\sim}$, \sim and $\overline{\sim}$	0.0 ... 99.9 V 100 ... 300 V										300 V $\overline{\sim}$, \sim and $\overline{\sim}$	
$I_{Leakage}$	Leakage current via AT3-IIIIE adapter Z745S ^{6,8}	0.00 ... 0.99 mA~	0.01 mA	—	—	—	—	—	—	—	$\pm(2\% \text{ rdg.} + 2 \text{ d})$ > 10 d without adapter	253 V	Continu- ous
		1.0 ... 9.9 mA~	0.1 mA										
		10 ... 20 mA~	1 mA										
Temp	Temperature with Pt100 sensor	–200.0 ... +850.0 °C	0.1 °C	—	< 20 V –	—	1.1 mA	—	—	—	$\pm(2\% \text{ rdg.} + 1 \text{ }^\circ\text{C})$	10 V	Continu- ous
	Temperature with Pt1000 sensor	–150.0 ... +850.0 °C											

Function	Measured Quantity	Display Range/ Nominal Range of Use	Resolution	Nominal Voltage U_N	Open-Circuit Voltage U_0	Nominal Current I_N	Short-Circuit Current I_K	Internal Resistance R_I	Reference Resistance R_{REF}	Measuring Uncertainty	Intrinsic Uncertainty	Overload Capacity	
												Value	Time
I_{Clamp}	Current via current clamp sensor [1 mV : 1 mA] (V-COM sockets ^{6,7})	1 ... 99 mA ~	1 mA (1 mV)	—	—	—	—	—	—	—	$\pm(2\% \text{ rdg.} + 2 \text{ d})$ > 10 d 20 Hz ... 20 kHz without clamp	253 V	Continu- ous
		0.1 ... 0.99 A ~	0.01 A (10 mV)										
		1.0 ... 9.9 A ~	0.1 A (100 mV)										
		10 ... 300 A ~	1 A (1 V)										
	Current via current clamp sensor [10 mV : 1 mA] (V-COM sockets ^{6,7})	0.1 ... 9.9 mA ~	0.1 mA (1 mV)	—	—	—	—	—	—	—			
		10 ... 99 mA ~	1 mA (10 mV)										
		0.10 ... 0.99 A ~	0.01 A (100 mV)										
		1.0 ... 30.0 A ~	0.1 A (1 V)										
	Current via current clamp sensor [100 mV : 1 mA] (V-COM sockets ^{6,7})	0.01 ... 0.99 mA ~	0.01 mA (1 mV)	—	—	—	—	—	—	—			
		1.0 ... 9.9 mA ~	0.1 mA (10 mV)										
		10 ... 99 mA ~	1 mA (100 mV)										
		0.10 ... 3.00 A ~	0.01 A (1 V)										
	Current via current clamp sensor [1000 mV : 1 mA] (V-COM sockets ^{6,7})	1 ... 99 μ A ~	1 μ A (1 mV)	—	—	—	—	—	—	—			
		0.10 ... 0.99 mA ~	0.01 mA (10 mV)										
		1.0 ... 9.9 mA ~	0.1 mA (100 mV)										
		10 ... 300 mA ~	1 mA (1 V)										

- ² Known as equivalent leakage current or equivalent patient leakage current from previous standards
- ³ Protective conductor current, touch current, device leakage current, patient leakage current
- ⁴ Protective conductor current, touch current, device leakage current
- ⁵ Only with feature G01, e.g. SECUTEST BASE10/SECUTEST PRO and SECULIFE ST BASE
- ⁶ Only with feature I01, e.g. SECUTEST PRO and SECULIFE ST BASE
- ⁷ Measurement types IPE_clamp and IG_clamp
- ⁸ Measurement type IPE_AT3 adapter and IG_AT3 adapter
- ⁹ The upper range limit depends on the selected test voltage.
- ¹⁰ Voltage at the test socket may be lower than measured line voltage due to components which limit inrush current.
- ¹¹ Only with feature G02, e.g. SECULIFE ST BASE25

Key: rdg. = reading (measured value), d = digit(s)

Testing Times, Automated Sequence

Testing times ("measurement duration" parameter) can be set separately for each rotary switch position during configuration of the sequence parameters. Testing times are neither tested nor calibrated.

Emergency Shutdown During Leakage Current Measurement

As of 10 mA of differential current (can also be set to 30 mA), automatic shutdown ensues within 500 ms. This shutdown does not take place during leakage current measurement with clamp meter or adapter.

Influencing Quantities and Influence Error

Influencing Quantity / Sphere of Influence	Designation per IEC 61557-16	Influence Error $\pm \dots\%$ rdg.
Change of position	E1	—
Change to test equipment supply voltage	E2	2.5
Temperature fluctuation	E3	Specified influence error valid starting with temperature changes as of 10 K:
0 ... 40 °C		2.5
Amount of current at DUT	E4	2.5
Low frequency magnetic fields	E5	2.5
DUT impedance	E6	2.5
Capacitance during insulation measurement	E7	2.5
Waveform of measured current	E8	2 with capacitive load (for equivalent leakage current)
49 ... 51 Hz		1 (for touch current)
45 ... 100 Hz		2.5 for all other measuring ranges

Reference Ranges

Line voltage	230 V AC $\pm 0.2\%$
Line frequency	50 Hz ± 2 Hz
Waveform	
Sine (deviation between effective and rectified value < 0.5%)	
Ambient	
Temperature	+23 °C ± 2 K
Relative humidity	40 ... 60%
Load resistance	Linear

Nominal Ranges of Use

Nominal line voltage	100 V ... 240 V AC
Nominal line frequency	50 Hz ... 400 Hz
Waveform of the line voltage	Sinusoidal
Temperature	0 °C ... + 40 °C

Ambient Conditions

Storage temperature	- 20 °C ... + 60 °C
Relative humidity	max. 75%, no condensation allowed
Elevation	max. 2000 m
Place of use	Indoors, except within specified ambient conditions

In order to avoid deviation due to excessive temperature fluctuation, e.g. after transport in low outdoor temperatures and subsequent operation in a warm indoor environment, it's advisable to wait until the test instrument has acclimatized before starting any measurements.

If the test instrument is colder than the ambient air, condensation may occur at high humidity, i.e. condensate may accumulate on components. This could result in the occurrence of parasitic capacitances and resistances which, in turn, affect the measuring circuit and measuring accuracy.

Power Supply

Supply network	TN, TT or IT
Line voltage	100 V ... 240 V AC
Line frequency	50 Hz ... 400 Hz
Power consumption	200 mA DUT: Approx. 32 VA 10 A DUT: Approx. 105 VA 25 A DUT: Approx. 280 VA

mains to test socket (e.g. during function test) Continuous max. 3600 VA, power is conducted through the instrument only, switching capacity ≤ 16 A, ohmic load, the AT3-IIS32 (Z745X) adapter (for example) can be used for current > 16 A AC

Electrical Safety

Protection category	I per IEC 61010-1/DIN EN 61010-1/VDE 0411-1
Nominal voltage	230 V
Test voltage	2.3 kV AC 50 Hz or 3.3 kV DC (mains circuit / test socket to mains PE terminal, USB, finger contact, probe(s) test socket)
Measuring category	250 V CAT II
Pollution degree	2
Safety shutdown	At DUT differential current of > 10 mA, shutdown time: < 500 ms, can also be set to > 30 mA with following probe current during: – Leakage current measurement: > 10 mA~/< 500 ms – Protective conductor resistance measurement: > 250 mA~/< 1 ms in case of continuous current I > 16.5 A
Fuse links	Mains fuses: 2 ea. FF 500V/16A Special fuse: M 250V/250mA Feature G01: Additional 10 A RPE test current: 1 ea. FF 500V/16A

Electromagnetic Compatibility

Product standard	DIN EN 61326-1:2013 DIN EN 61326 -2-2: 2013
------------------	--

Interference emission		Class
EN 55011		B
IEC 61000-3-2		B
IEC 61000-3-3		B
Interference immunity	Test Value *	Evaluation Criterion
EN 61000-4-2	Contact/atmos. – 4 kV/8 kV	B
EN 61000-4-3	10 V/m (80 MHz ... 1 GHz)	A
EN 61000-4-4	Mains connection – 2 kV	B
EN 61000-4-5	Mains connection – 1 kV (LN), 2 kV (LPE)	B
EN 61000-4-6	Mains connection – 3 V	A
EN 61000-4-8	30 A/m	A
EN 61000-4-11	0%: 1 period	B
	0%: 250/300 periods	C
	40%: 10/12 periods	C
	70%: 25/30 periods	C

USB data port

Type	USB slave for PC connection
Type	2 ea. USB master, for data entry devices * with HID boot interface, for USB flash drive for data backup, for USB flash drive for saving reports as HTML files for printers *

* See section 14 for compatible devices

As of firmware 1.6.0: In the remote operating mode, the test instrument can be controlled via the USB slave data interface. Pertinent interface commands are available upon request.

Bluetooth data interface[®] 2.1 + EDR (SECUTEST PRO BT (comfort) or feature M01 only)

Mechanical Design

Display	4.3" multi-display (9.7 x 5.5 cm), backlit, 480 x 272 pixels at 24-bit color depth (true color)
Dimensions	W x H x D: 295 x 145 x 150 mm Height with handle: 170 mm
Weight	SECUTEST BASE(10)/PRO: approx. 2.5 kg SECULIFE ST BASE25: approx. 4.0 kg
Protection	Housing: IP 40, Test socket: IP 20 per DIN VDE 0470, part 1/EN 60529

Table Excerpt Regarding Significance of IP Codes

IP XY (1 nd digit X)	Protection Against Foreign Object Ingress	IP XY (2 nd digit Y)	Protection Against Water Ingress
2	≥ 12.5 mm \varnothing	0	Not protected
4	≥ 1.0 mm \varnothing	0	Not protected

SECULIFE ST BASE(25):

Housing with antimicrobial properties per JIS standard Z 2801:2000

13 Maintenance

13.1 Housing Maintenance

No special maintenance is required for the housing. Keep outside surfaces clean. Use a slightly dampened cloth for cleaning. Avoid the use of cleansers, abrasives and solvents.

13.2 Testing the Color Display and the Buzzer (self-test parameter)

The color display can be tested for failure of individual segments and loss of color components on page 3/3 of the setup menu in the SETUP switch position under the self-test parameter.

Beyond this, the buzzer can be tested for 3 different frequencies.

13.3 Software Update (system info parameter)

The current firmware or software version can be queried via the system info parameter (Setup 3/3).

The test instrument's firmware can be updated via the USB port with the help of a PC. Updating is only possible via the proprietary **Firmware Update Tool** application.

- Before updating your test instrument's firmware, make sure that your PC software is compatible with the current firmware version (see table below).

Test Instrument Firmware Version	PC Report Generating Software	Data Export/Import File Formants	Report Designer	Sequence Designer
1.8.1	ETC	.etc	✓	✓
1.8.2	ETC	.etc	✓	1.5
1.8.3	ETC	.etc	✓	1.5
2.0.0	IZYTRONIQ	.etc	✓	IZYTRONIQ
2.1.1	IZYTRONIQ	.secu	(see Section 3.5.3)	IZYTRONIQ



Attention!

Before updating the firmware, be sure to save the structures you have created and your measuring data, because they might be deleted during the update process (see section 5.2.3, "Backing Up and Restoring Test Structures and Measurement Data").



Note

Adjustment data are not overwritten during updating, and thus recalibration is unnecessary.

As a registered user (if you've registered your test instrument), you're entitled to download the **Firmware Update Tool** and the current firmware version free of charge from the **myGMC** page at www.gossenmetrawatt.com.

You'll also find operating instructions for the **firmware update tool** here.



Attention!

The interface cable may not be disconnected while updating the firmware via the USB port.



Attention!

The test instrument may not be disconnected from supply power while updating the firmware via the USB port.

13.4 Backup Battery for Real-Time Clock

The backup battery (lithium cell) should be replaced no later than after 8 years. Replacement can only be executed by the service department.

If backup battery voltage is too low, the date and time assigned to the test data no longer correspond to the actual time of recording. This may also influence sorting in the report generating software.

The instrument's database itself is not affected by a depleted backup battery.

13.5 Fuse Replacement

The fuses may only be replaced when the instrument is voltage-free, i.e. the instrument must be disconnected from mains supply power and may not be connected to a measuring circuit.

The fuse type must comply with the specifications in the technical data or the labeling on the instrument.

13.6 Recalibration

The measuring tasks performed with your instrument, and the stressing it's subjected to, influence aging of its components and may result in deviation from the specified levels of accuracy.

In the case of strict measuring accuracy requirements, as well as in the event of use at construction sites with frequent stress due to transport and considerable temperature fluctuation, we recommend a relatively short calibration interval of once per year. If your instrument is used primarily in the laboratory and indoors without considerable climatic or mechanical stressing, a calibration interval of once every 2 to 3 years is sufficient as a rule.

During recalibration * at an accredited calibration laboratory (DIN EN ISO/IEC 17025), deviations from traceable standards demonstrated by your measuring instrument are documented. Ascertained deviations are used to correct display values during later use of the instrument.

We would be happy to perform DAkkS or factory calibration for you at our calibration laboratory. Further information is available on our website:

www.gossenmetrawatt.com

(→ COMPANY → Quality and Certificates → DAkkS-calibration center).

According to DIN VDE 0701-0702, only test instruments which are tested and calibrated at regular intervals may be used for testing.

Recalibration of your instrument at regular intervals is essential for the fulfillment of requirements according to quality management systems per DIN EN ISO 9001.

* Examination of the specification, as well as adjustment, are not included in calibration. However, in the case of our own products, any required adjustment is performed and adherence to the specification is confirmed.

13.7 Technical Safety Inspections

Subject your test instrument to technical safety inspections at regular intervals. We recommend the same interval for inspections as is also used for recalibration.

The SECUTEST... is designed as a totally insulated device in accordance with IEC 61010 and IEC 61557-16/VDE 0413-16. The protective conductor is used for measuring purposes only, and is thus not always accessible. The protective conductor at the test socket can be tested as follows:

- Connect the SECUTEST... to a multiple distributor.
- Conduct a touch current measurement for permanently connected DUTs (nothing may be connected to the test socket).
- Measure protective conductor resistance between the neighboring socket at the multiple distributor and the test socket.
- The measured value may not exceed 0.3 Ω.

For technical reasons, insulation resistance between LN and PE inside the SECUTEST... is roughly 3 MΩ.

This must be taken into consideration during technical safety inspections or, instead of the insulation resistance measurement, the protective conductor current measurement must result in a value of less than 3.5 mA (or less than 7 mA if the equivalent leakage current method is used).

There are also 4 accessible conductive parts on the SECUT-EST..., at which the touch current measurement must result in a value of less than 0.5 mA:

- Connector for service plug (jack socket)
- USB ports
- Metallized start key
- Protective conductor bar in the test socket



Note

Text Encryption

Read-out to the CP1252 character set is limited in the "Text" print-out mode – characters which cannot be displayed are replaced by an underline (_).



Note

In order to prevent damage to the SECUTEST... test instrument, we recommend avoiding the performance of measurements at the USB ports.

13.8 Returns and Environmentally Sound Disposal

The instrument is a category 9 product (monitoring and control instrument) in accordance with ElektroG (German electrical and electronic device law). This device is subject to the RoHS directive. We also make reference to the fact that in this regard, the current status can be accessed on the Internet at www.gossen-metrawatt.com by entering the search term WEEE.

We identify our electrical and electronic devices in accordance with WEEE 2012/19/EU and ElektroG using the symbol shown at the right per DIN EN 50419.



These devices may not be disposed of with the trash.

Please contact our service department regarding the return of old devices (see address in Section 15).

14 Appendix

14.1 List of Suitable Printers with USB Port

The following devices have been tested for use with the test instrument. We are unable to offer any guarantees regarding use with other devices.

- **Z721S thermal printer**
- **Z721D barcode printer**
(as of firmware V1.3.0, to be replaced by Z721E as of 2018)
Setup options in the SETUP switch position
(Setup (2/3) > Printer > Z721D > Printer settings):
Encryption: Code39, Code128, EAN13, Text, QR Code, Micro QR Code, DataMatrix
The respective paper size is selected automatically as of FW 2.0 (6, 9, 12, 18, 24 or 36 mm).
- **Z721E barcode printer** (as of firmware V1.8.3)
Setup options in the SETUP switch position
(Setup (2/3) > Printer > Z721E > Printer settings)
Encryption: Code39, Code128, EAN13, Text, QR Code, Micro QR Code, DataMatrix, Aztec
The respective paper size is selected automatically (6, 9, 12, 18, 24 or 36 mm).



Note

Label Tapes

When using the label printer together with the SECUT-EST..., only TZ(e) tapes are supported with widths of 6, 9, 12, 18, 24 and 36 mm.



Note

2D Code Labels

When printing 2D code labels (QR Code, MicroQR Code, DataMatrix, Aztec), we recommend label cartridges with tape widths of 12 mm or more, and in any case at least 9 mm.

14.2 List of Suitable Barcode Scanners and RFID Scanners with USB Port

The following devices have been tested for use with the test instrument. We are unable to offer any guarantees regarding use with other devices.

- **Z751A barcode scanner**
- **Z751E RFID scanner (programmer)**

14.3 Use of USB Storage Devices

USB flash drives must be directly connected to the test instrument for various device functions (see sections 3.8 and 5.2).

The connected USB storage medium must fulfill at least the following requirements in order to be used with your test instrument:

- The file system on the USB flash drive must be FAT formatted (FAT32). NTFS and exFAT file systems, for example, are not compatible.
- Maximum current consumption of the USB storage medium via the USB port may not exceed 500 mA.
- Do not use USB storage devices with encrypting functions.

Furthermore, make sure that the USB drive includes an LED display which indicates whether or not write operations have been completed.

List of tested and approved USB flash drives:

- Philips USB flash drive Snow Edition USB 3.0 (tested size: 64 GB)
- Toshiba TransMemory-MX U361 USB 3.0 (tested size: 64 GB)
- Corsair Flash Voyager Vega USB 3.0 (tested size: 16 GB)
- SanDisk Cruzer Glide USB 2.0/3.0 (tested size: 64 GB)

14.4 Bluetooth Interface (SECUTEST PRO BT (comfort) or feature M01)

The **Bluetooth®** interface permits use of the push-print function (see section 10.10).

Setup 3/3

Menu selection for operating parameters, page 3 of 3

Bluetooth: menus for using the **Bluetooth®** interface

Menu selection for Bluetooth operating parameters

- Status:** Switch Bluetooth interface on/off
- Device pairings *:** Search/pair BT devices, view/edit existing pairings
- Device name *:** The name of the test instrument displayed above the interface can be changed.
- Visibility *:** Specifies whether the test instrument can be found by other Bluetooth devices.

* These submenus only appear if status is set to on.

List of already paired devices

- Paired device found (white frame) > rename or delete
- Paired device found (blue frame) > rename or delete
- Not yet paired device found (blue frame) > entry of pairing PIN
- Search for **Bluetooth®** devices in close proximity

Important Notes

- **Status/visibility:** For reasons of safety, we recommend deactivating the **Bluetooth®** interface if it's not needed. The "not visible" setting cannot be used as a substitute for shutting down the **Bluetooth®** interface, because invisible Bluetooth devices can also be found using the appropriate means.
- **Device pairings** which will no longer be required for a lengthy period of time should be deleted.
- The DUT's **device name** is set to SECUTEST as a standard feature. If you access one PC with several test instruments, the name should be at least supplemented, for example SECUTEST1, SECUTEST2 etc.

14.5 Remote Control Interface

(Feature KB01 or enabling of the "database extension", "Z853R – SECUTEST DB+" – available for a fee – is required as of firmware version 1.6.0.)

The test instrument's measuring functions can be remote controlled via the USB interface with the help of **IZYTRONIQ**. In this case, measured values do not appear at the test instrument's display and are instead transmitted via the respective data interface.

14.6 Entry Via an External USB Keyboard

Instead of using the touchscreen keyboard, characters can be entered directly with a USB keyboard which is connected to the test instrument. The touchscreen keyboard which appears at the display must be exited to this end.

Switching from On-screen to USB Keyboard Entry

- ⇨ Press the **Return** key or the ✓ softkey within a popup.
- ⇨ Alternatively, the **ESC** key can be pressed in order to exit a popup generated by database management MEM or the touchscreen keyboard.

Switching Back and Forth Between USB Keyboard and On-Screen Entry

(applies to versions with and without touch control)

Press the **TAB** key in order to switch back and forth between the external USB keyboard and on-screen entry.

14.6.1 Additional Key Functions, DB Comfort Option (feature KDO1, "Z853S – SECUTEST DB COMFORT")

If feature KDO1 has been enabled, which is available for a fee, the following additional entry options are available:

Print Screen → PRINT

ESC → ESC

F1 → HELP

F2 → MEM

F5 → Softkey 1

F6 → Softkey 2

F7 → Softkey 3

F8 → Softkey 4

F9 → Softkey 5

F3 → Search for ID in the database (only in database management MEM, at the primary level of auto measurement screens and in green measurement screens)

F4 → Search for "Text" in the database (only in database management MEM, at the primary level of auto measurement screens and in green measurement screens)

Additional key functions within database management MEM

Cursor → Navigation within the tree

Home → Jump to database root node

End → Jump to end of tree

Tab → Change location/customer tree

Insert → Create a new object

Delete → Delete object

↵ (enter) → For objects: edit object,
for measurements: test list view

⇧+Insert → Move object within tree
(simultaneously press the shift and insert keys)

In the event that several objects have been found as a result of the search:

⇒ ⇐ → Scroll through found objects
(right and left scroll keys)

Additional Key Functions in the Test List View (when the test report is shown at the display):

⇧⇩ → scroll (up and down scroll keys)

⇒ ⇐ → Switch to detail view or back to list of tests steps (right and left scroll keys)

Tab → Select filter type for test steps
(abridged / failed test steps only / all)

↵ (enter) → Exits test list view

14.7 Index

Numerics

2nd Test Probe	2, 23
2-Pole Measurement (P1-P2)	23

A

Alternative Test Frequency	22
Auto Measuring Point	59

B

Backup Battery	83
Barcode Scanner	
Configuration	7
Connection	7
List	85
Barcodes	
Read-In	7

C

Calibration Data	12
Classification Parameter	61
Connection	
Prompts	23
Test Probe P1 or P2	10
Tests	23

Connections

Overview	2
----------------	---

Continuous Measurement

Icon	60
------------	----

Controls	2
----------------	---

D

Detail View	61
Detection of Probes / Measurement Cables	23
Dual-Lead Measurement (P1-P2)	23
DUT Connection Detection	23

E

End of Sequence	59
Enter, Select, Delete or Protect Inspector Protect with Password	11
Equivalent Leakage Current	
Limit Values	45

Error Displays	70
----------------------	----

Error Messages	71
----------------------	----

F

Firmware Update Tool	83
----------------------------	----

Fuse

Probe P1	59
----------------	----

Fuses

Characteristic Values	82
Location	2
Replacement	6, 83

I

Initial Window	
Style	59

Insulation Resistance	5
-----------------------------	---

Limit Values	34
--------------------	----

IT Systems	9
------------------	---

K

Keyboard Layout	7, 18
-----------------------	-------

L

Language	7
----------------	---

Language Selection	7, 12
--------------------------	-------

Limit Value Mode	59
------------------------	----

Limit Value Violation	68
-----------------------------	----

M

Mains Connection

Errors	10
Plug	9

Maintenance	83
-------------------	----

Measuring Sequence

With Pre-Selection of the DUT	26
with Subsequent Entry of the DUT	26

Measuring Sequences

Standard Selection	60
--------------------------	----

Measuring Uncertainty	59
-----------------------------	----

Multi-Print	7
-------------------	---

O

Offset Values	29
---------------------	----

On Test	23
---------------	----

Overview

Controls	2
Included Features	3

P

Patient Leakage Current

Limit Values	48
--------------------	----

PRCD	28, 52
------------	--------

PRCD Type	62
-----------------	----

Protection Category Detection	23
-------------------------------------	----

Protective Conductor Resistance	5
---------------------------------------	---

R

Real-Time Clock	83
-----------------------	----

Recalibration	83
---------------------	----

Recalibration Date	12, 27
--------------------------	--------

Reference Voltage L-PE	22
------------------------------	----

Report Designer	8, 14
-----------------------	-------

Reports	7
---------------	---

Residual Current Monitoring	22
-----------------------------------	----

Retrieve (last) Measured Values

Single Measurements	26
---------------------------	----

Retrieving (last) Measured Values

Database Function	21
-------------------------	----

Returns	84
---------------	----

RFID Scanner

List	85
------------	----

RFID Tags

Read	7
------------	---

Write	8
-------------	---

RoHS Directive	84
----------------------	----

S

Safety Precautions	5
--------------------------	---

Scope of Delivery	3
-------------------------	---

Scope of Functions	3
--------------------------	---

SECUTEST CLIP	38, 45
---------------------	--------

Self-Test	83
-----------------	----

Sequence Parameter	64
--------------------------	----

Services	90
----------------	----

Short-Circuit Test	23
--------------------------	----

Software

Update	83
--------------	----

Version	2, 11
---------------	-------

Switching Loads – Maximum Starting Current	6
--	---

Switching Power Consumers – Procedure	6
---	---

Symbols

Object Creation	19
-----------------------	----

on the Instrument	6
-------------------------	---

User Interface

Database Management	18
---------------------------	----

Single Measurements	26
---------------------------	----

Test Sequence	60
---------------------	----

T

Table of Single Measurements	5
------------------------------------	---

Technical Safety Inspections	83
------------------------------------	----

Touch Click	61
-------------------	----

Touch Current	23
---------------------	----

Touchscreen	18
-------------------	----

Tree View	61
-----------------	----

U

USB Flash Drive

Database Backup	15
-----------------------	----

ETC File Export	15
-----------------------	----

ETC File Import	15
Restoring a Database	15
Saving Reports	8
USB Keyboard	18
V	
Voltage Measuring Inputs	2
W	
WZ12C	29, 38, 45

15 Repair and Replacement Parts Service Calibration Center * and Rental Instrument Service

If required please contact:

GMC-I Service GmbH
Service Center
Beuthener Str. 41
90471 Nürnberg, Germany
Phone: +49-911-817718-0
Fax: +49-911-817718-253
e-mail service@gossenmetrawatt.com
www.gmci-service.com

This address is only valid in Germany.
Please contact our representatives or subsidiaries for service in
other countries.

* DAkkS calibration laboratory for electrical quantities, registration no. D-K-15080-01-01,
accredited per DIN EN ISO/IEC 17025
Accredited quantities: direct voltage, direct current value, direct current resistance,
alternating voltage, alternating current value, AC active power, AC apparent power,
DC power, capacitance, frequency and temperature

Competent Partner

GMC-I Messtechnik GmbH is certified per DIN EN ISO 9001.

Our DAkkS calibration laboratory is accredited by the Deutsche
Akkreditierungsstelle GmbH (national accreditation body of the
Federal Republic of Germany) under registration number D-K-
15080-01-01 in accordance with DIN EN ISO/IEC 17025.

We offer a complete range of expertise in the field of metrology:
from test reports and factory calibration certificates right on up to
DAkkS calibration certificates. Our spectrum of offerings is
rounded out with free test equipment management.

An on-site DAkkS calibration station is an integral part of our ser-
vice department. If errors are discovered during calibration, our
specialized personnel are capable of completing repairs using
original replacement parts.

As a full service calibration laboratory, we can calibrate instru-
ments from other manufacturers as well.

16 Product Support

If required please contact:

GMC-I Messtechnik GmbH
Product Support Hotline
Phone +49-911-8602-0
Fax: +49 911 8602-709
e-mail support@gossenmetrawatt.com