



**Mr. SLIM**<sup>®</sup>  
Split-ductless A/C and Heat Pumps



[www.mrslim.com](http://www.mrslim.com)

# Mr. Slim<sup>®</sup> Split-ductless Systems Redefining Comfort

R410A  
**INVERTER**



M-Series Indoor Unit



Wireless  
M-Series Remote



M-Series Outdoor Unit

Comfort is a concept many of us notice only when we're either uncomfortable or extremely comfy. At Mitsubishi Electric HVAC Advanced Products Division comfort is all we think about, and our industry-leading Mr. Slim split-ductless cooling and heating systems reflect that thinking. At home or at work our Mr. Slim systems are designed to make any space inviting. Maybe your home has a room that's always too hot or too cold. Or perhaps you're looking for a way to control the climate effectively in multiple rooms in your office building such as the conference room. No matter what your cooling and heating needs may be, Mr. Slim systems are the perfect way to make rooms in your home or workplace as comfortable as possible.





## What is Mr. Slim® Split-ductless Technology?

For decades split-ductless air-conditioning systems have been the quiet solution for cooling and heating problems around the world. Our quiet and powerful Mr. Slim systems have three main components: an indoor unit, outdoor unit, and remote controller. These units are easily connected by refrigerant lines running through a small three-inch opening in the wall or ceiling. The outdoor unit cycles the refrigerant through the lines to and from the indoor unit, where the air is conditioned and distributed into the indoor space. Installation is as simple as mounting the indoor and outdoor units, connecting the refrigerant lines, and making a few electrical connections. An easy installation for your authorized contractor means you will be quickly enjoying the comfort Mr. Slim systems provide.

## Why Mr. Slim Systems?

Mitsubishi Electric is the industry leader in split-ductless air-conditioning technology, period. Our innovations have defined cutting-edge technology for over 25 years. Compare and you'll see no one surpasses the Mr. Slim brand's performance for quiet, easy-to-use, and energy-efficient operation. And since our split-ductless technology carries the Mitsubishi Electric name, you know every product is built to last. The bottom line is that the Mr. Slim product delivers ultimate comfort control for your home or office. It's true today and will be comfortably evident for years to come.

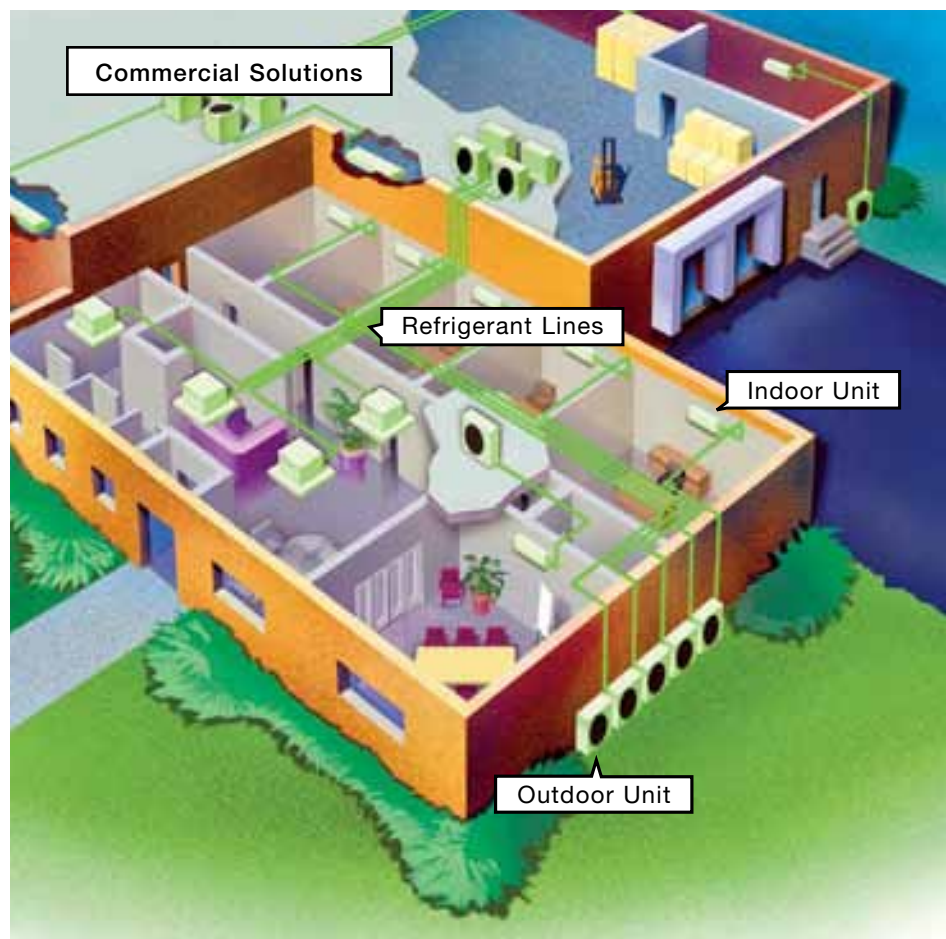
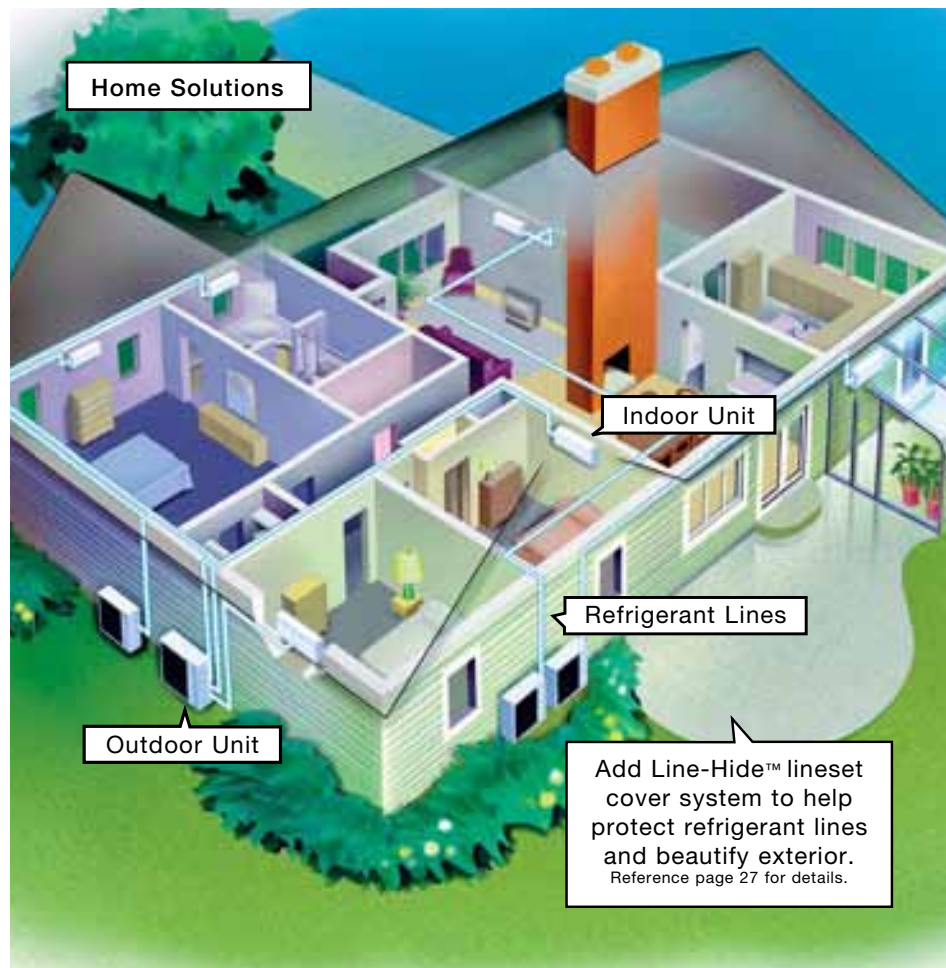

CAN'T WE  
JUST STICK A  
WINDOW UNIT  
IN THERE?

*Sure you can use  
a window unit,*

but it will block your view to  
the outside from any angle.  
It's also an open invitation for  
burglars to pay you a visit.

Oh, and don't forget that old  
window units are also ugly,

drippy, noisy and add no significant value to your  
home. On the other hand, Mr. Slim® products from  
Mitsubishi Electric are easy for your authorized  
contractor to install. They work quietly and don't  
leave a large, easily-accessed opening in your  
otherwise secure home. And split-ductless systems  
like Mr. Slim products also add value to your home.  
All-in-all, window units may be the easy solution,  
but Mr. Slim systems from Mitsubishi Electric are  
the smart solution. You get what you pay for when  
it comes to innovative and reliable air conditioning,  
and with Mr. Slim products you invest in the  
comfort for your home or business.



## Where Can Mr. Slim Products Be Used?

Mitsubishi Electric Mr. Slim systems are the perfect  
solution for almost any spot cooling or heating  
situation. Our split-ductless systems can make an

uncomfortably hot or cold room in an existing  
building comfortable again. Perhaps you are  
remodeling or renovating an **older home** or  
business built before ducted air conditioning  
was available. Because there is no ductwork  
to run, Mr. Slim split-ductless systems are  
both **plaster wall** and **brick facade friendly** so  
there's no need to compromise the integrity of  
your home or office just to make each room  
comfortable. These systems are cooling and  
heating solutions that can fit into almost any  
space because smart engineering optimized  
the capabilities of the new R410A refrigerant  
and INVERTER technology to develop  
more efficient systems with smaller indoor  
and outdoor units. R410A refrigerant is also  
environmentally friendly with zero **Ozone  
Depletion Potential (ODP)**. In addition,  
Mr. Slim systems are perfect for **schools,  
universities, nursing homes, hospitals,  
restaurants, hotels, equipment rooms, office  
buildings, and churches**. The versatility and  
variety of applications for Mr. Slim systems  
are virtually unlimited. If a room is too hot  
or too cold, a Mr. Slim system can handle it!  
**To find more information about our Mr. Slim  
split-ductless product line or to find a highly  
trained Diamond Dealer to service your  
home, please visit our website at [mrslim.com](http://mrslim.com).**

### Features

### Benefits

EFFICIENT,  
QUIET OPERATION

Mr. Slim products are designed to be quieter and  
more efficient than old window units, so you'll  
sleep easier with less worry about operating costs.

NO DUCTWORK AND  
EASY TO INSTALL

Mr. Slim systems install without ductwork,  
requiring only a three-inch opening in the wall  
or ceiling. This design allows you to retain the  
original aesthetics of a room. Because no ductwork  
is involved, the installation is quick and simple,  
which means little or no disruption to your home  
or business.

VERSATILE

From living rooms to boardrooms, from  
classrooms to kitchens to cafeterias, there's a  
Mr. Slim system to fit any cooling or heating need.

WIRELESS REMOTE  
CONTROLLER

Mr. Slim M-Series systems come with a convenient  
wireless remote controller that puts you in control  
of your own comfort. (Optional wired remote  
controller available)

ENVIRONMENTALLY  
FRIENDLY

Mr. Slim systems use an environmentally-friendly  
refrigerant.

INVERTER  
TECHNOLOGY

You will enjoy high-speed cooling and heating,  
and consistent delivery of comfort year-round.



## INDEX

### INVERTER TECHNOLOGY

Pages 06-07

### M-SERIES: 9,000-30,000 Btu/h

Residential and Select Commercial Air Conditioners and Heat Pumps

Pages 08-09

Wireless Remote and Benefits

Page 09

### MS/MSY/MSZ SINGLE-ZONE, WALL-MOUNTED SERIES:

9,000-22,000 Btu/h

Air Conditioners and Heat Pumps

Pages 10-13

### MXZ MULTI-ZONE WALL-MOUNTED SERIES:

20,000-28,600 Btu/h

INVERTER-driven Multi-zone Heat Pump System

Pages 14-15

### P-SERIES: 12,000-42,000 Btu/h

Select Residential or Varied Commercial

Pages 16-17

Wired Remote, Benefits, and Outdoor Unit Comparison

Page 17

### PKA WALL-MOUNTED SERIES:

12,000-34,200 Btu/h

Air Conditioners and Heat Pumps with Wired

and Wireless Hand-held Remote Controllers

Pages 18-20

### PCA CEILING-SUSPENDED SERIES:

24,000-42,000 Btu/h

Air Conditioners and Heat Pumps

Pages 21-23

### PLA CEILING-RECESSED CASSETTE SERIES:

12,000-42,000 Btu/h

Air Conditioners and Heat Pumps

Pages 24-26

GENERAL SPECIFICATIONS: Page 27

REFRIGERANT TUBING AND ACCESSORIES: Page 27

## MR. SLIM PRODUCT FAMILY

INVERTER



MS/MSY/MSZ

### M-SERIES

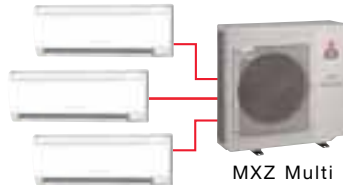

MSZ-A09NA (3)

MXZ Multi



PLA

### P-SERIES



PKA



PCA

## GLOSSARY

**AIR CONDITIONER:** A mechanical device used to control temperature, humidity, cleanliness, and movement of air in a confined space.

**Btu/h (British Thermal Units per Hour):** A term that is used to measure cooling or heating capacity.

**CAPACITY or LOAD:** A refrigeration rating system usually measured in Btu/h.

**COMPRESSOR:** A pump found in a refrigeration or air-conditioning system, which pumps refrigerant through pipes between an outdoor and an indoor unit using pressure.

**HEAT PUMP:** An air-conditioning system that is capable of reversing the direction of refrigerant flow to provide either cooling or heating to the indoor space.

**HSPF (Heating Season Performance Factor):** A rating of the seasonal efficiency of a heat pump unit when operating in the heating mode.

**HVAC:** A term which stands for Heating, Ventilation, and Air Conditioning.

**INDOOR UNIT:** The air-handler of an air-conditioning system, which contains a heat exchange coil, filters, and fan and provides conditioned air into the space.

**INVERTER TECHNOLOGY:** Mitsubishi Electric's MSY, MSZ and MXZ and all P-Series outdoor units use INVERTER-driven compressor technology (Variable Frequency Drive) to provide

exceptional indoor, high-speed cooling and heating. By responding to indoor and outdoor temperature changes, these systems reduce power consumption by varying the compressor speed for extra energy savings. The system operates only at the levels needed to maintain a constant and comfortable indoor environment. Our CITY MULTI product line also incorporates INVERTER technology. (Visit [www.mehvac.com](http://www.mehvac.com) for details)

**MICROPROCESSOR:** An electrical component consisting of integrated circuits, which may accept, store, control, and output information.

**OUTDOOR UNIT:** A component of an air-conditioning system which contains compressor, propeller fan, circuit board, and heat exchange coil. It pumps refrigerant to/from indoor unit.

**REFRIGERANT:** A gas/liquid substance used to provide cooling by direct absorption of heat.

**REFRIGERANT LINES:** Copper tubing through which refrigerant flows to and from indoor and outdoor units.

**SEER (Seasonal Energy Efficiency Ratio):** A rating of the seasonal efficiency of air-conditioning or heating units in cooling mode.

**SPLIT-DUCTLESS SYSTEM:** A system comprised of a remote outdoor condensing unit connected by refrigerant pipes to a matching, non-ducted indoor air-handler, and a remote controller. Special cases for introducing fresh air may call for limited ducting to air-handler from outside.

# INVERTER

INVERTER-DRIVEN COMPRESSOR TECHNOLOGY

## INVERTER Technology for Superior Year-round Comfort and Performance

Select straight-cool and all heat pump outdoor units employ Mitsubishi Electric's INVERTER-driven compressor technology (Variable Frequency Drive) to provide exceptional, high-speed cooling and heating performance. Thanks to high rotation speeds, desired temperatures are reached more quickly than with conventional systems. So you can enjoy your ideal level of comfort without delay.

Like a car's cruise control, the system varies the compressor speed, thereby reducing power consumption which results in extra energy savings. This also means the system can engage without affecting other household appliances. The system adjusts itself precisely to the level needed to maintain a consistently comfortable indoor environment. Precise rotation speed control provides comfortable, consistent room temperature.

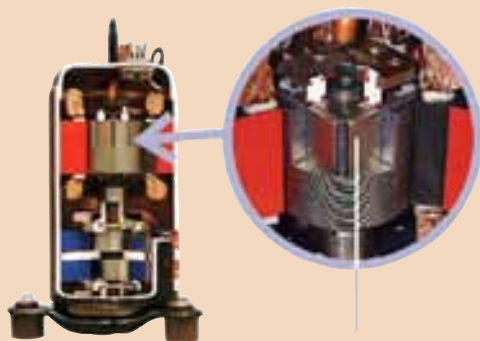

Neodymium magnets

INVERTER-driven Compressor

### INVERTER Technology

### Conventional Technology

**High rotation speed provides fast cooling and heating.**

Requires a long time to reach desired temperature.

**Low rotation speed efficiently maintains desired temperature.**

Has uncomfortable temperature fluctuation.

**Low rotation speed keeps starting current low, leaving other appliances unaffected.**

Needs heavy energy usage every time compressor turns on.

**Precise rotation speed control provides comfortable, consistent room temperature.**

Requires high starting current that affects other appliances throughout household.

## High-speed Cooling and Heating

High rotation compressor speeds cool and heat a room quickly, saving both energy and cash. The compressor speed is controlled to maximize efficiency, changing speeds according to the cooling and heating load of a room.

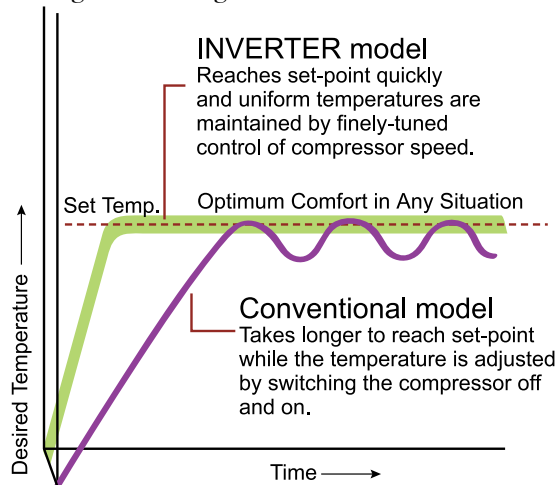

## Optimum Comfort Year-round

Conventional units start and stop repetitively unlike INVERTER units that detect subtle changes in temperature and adjust compressor speed automatically. Low rotation speed efficiently maintains desired temperature to reduce temperature swings and provide a more comfortable climate.



## Extra Energy Savings

For optimum performance INVERTER technology delivers only the energy needed to satisfy the cooling and heating load of a room, thereby reducing energy consumption.

Our CITY MULTI® product line also employs INVERTER technology. Ask about how the Mr. Slim® and the CITY MULTI INVERTER systems give you even greater performance capabilities and design flexibility, making Mitsubishi Electric products the best choice for any of your cooling and heating applications. Visit [www.mehvac.com](http://www.mehvac.com) for more information about CITY MULTI.

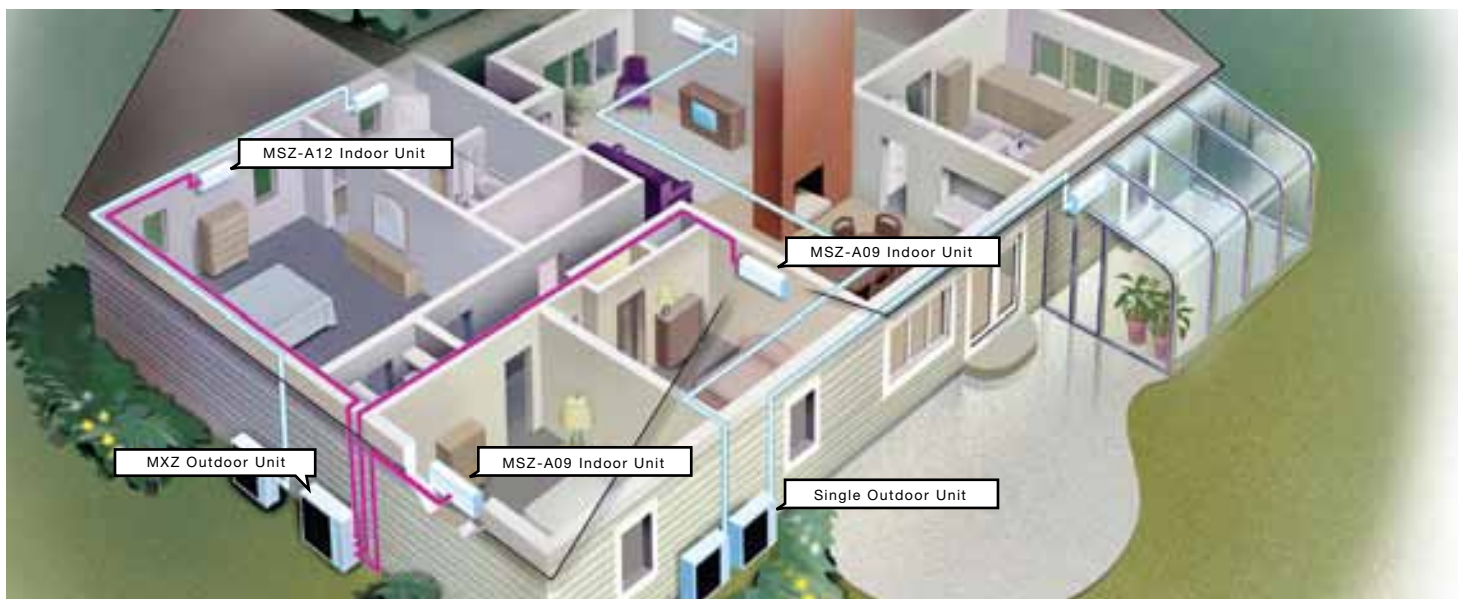



# M-SERIES

## RESIDENTIAL AND SELECT COMMERCIAL

### Small Size, Big Performance

While all of our Mr. Slim units are compact and lightweight, the M-Series is designed specifically for tight spaces. But don't be fooled. The powerful M-Series delivers plenty of cool or warm air to almost any size room. And unlike window units, the Mr. Slim indoor unit's small size, neutral color, and mounting position mean it blends in well.

### No Ductwork Required

Mr. Slim systems need no ductwork. There's only a small, three-inch opening connecting the indoor and outdoor units. This means quicker installation, less mess, and a better looking and more comfortable home.

### Efficient. Quiet. Secure. Pick All Three.

That's right. Mr. Slim units deliver all of these. First, its small design, smart functionality, and lack of ductwork plus INVERTER technology make it energy efficient. Second, the unit's fan is designed to deliver air quietly and continuously with only a gentle whoosh for constant circulation and filtration. (That's why Mr. Slim systems were the first choice for thousands of churches, schools, and libraries across the U.S. *Shhh!*) Third, because each system installs with only



Lifestyle photo courtesy of Mitsubishi Digital Electronics America, Inc. Plasma TV Model PD-5065 shown. Visit [mitsubishitv.com](http://mitsubishitv.com) for details.

a three-inch opening for connecting the indoor and outdoor units, you don't have to worry about thieves gaining access through an easy-to-remove window unit.

With Mr. Slim systems you can sleep in quiet comfort with a sense of security.

### New Technology

With the new A-control system, the indoor unit is powered through the outdoor unit.

Three polarity sensitive wires, plus a ground conductor, run from the outdoor to the indoor unit providing both power and communication. Advanced wireless remote control is standard on all M-Series models. On the INVERTER-driven units, an option for a wired wall controller is available.

### Choose the Mr. Slim® Product Size That's Right for You

Room Size	Performance
100 - 350 Sq. Ft.	<9,500 BTU/H
350 - 440 Sq. Ft.	9,500 - 12,000 BTU/H
440 - 550 Sq. Ft.	12,000 - 15,000 BTU/H
550 - 600 Sq. Ft.	15,000 - 16,200 BTU/H
600 - 800 Sq. Ft.	16,200 - 22,000 BTU/H
800 - 1,100 Sq. Ft.	22,000 - 30,000 BTU/H

*This table is for general guidance only. Additional conditions may factor into your actual cooling or heating needs. Please contact your contractor or Mitsubishi Electric for a more accurate determination of your specific cooling or heating needs.*

#### M-SERIES LINEUP



MS/MSY/MSZ/MXZ  
Wall-mounted  
Air Conditioners and  
Heat Pumps  
*[pgs. 10-15]*

**INVERTER**  
(MSY & MSZ  
Models only)



## Wireless Remote Controller

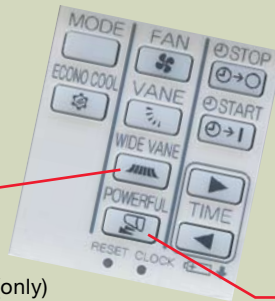
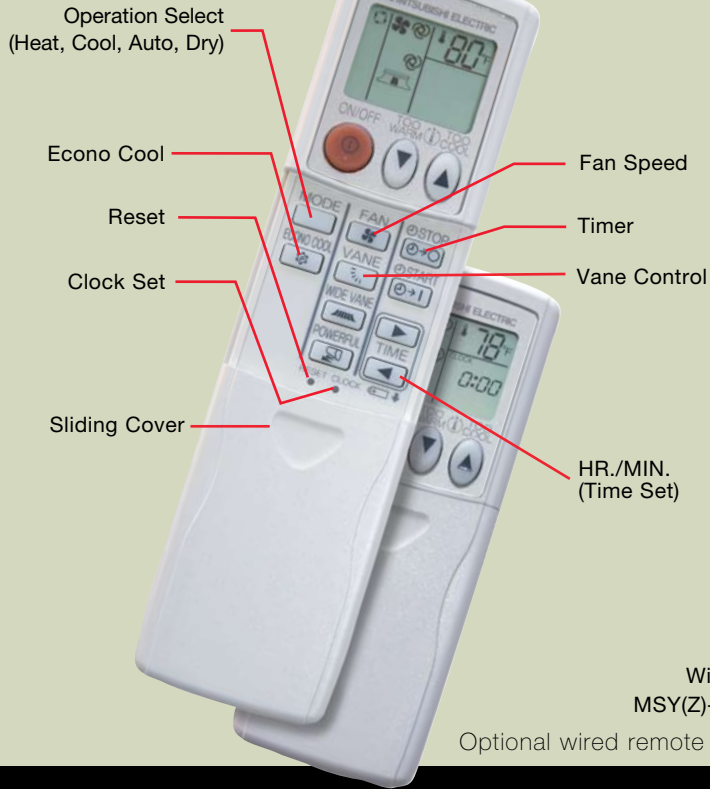

## Wireless Remote Controller Detail

Wide Vane  
MSY(Z)-A24NA (only)

Powerful: Faster Cooling or Heating

Optional wired remote controller available

## Features

## Benefits

<b>INVERTER TECHNOLOGY</b>	Maximizes energy savings by making sure only the energy needed to cool or heat an area is used.
<b>NO DUCTWORK</b>	No need for major construction and remodeling hassle because the Mr. Slim system installs quickly and easily.
<b>ZONE CONTROL</b>	Maximum control and energy efficiency are realized by cooling and heating only those spaces you want.
<b>ADVANCED MICROPROCESSOR CONTROLS</b>	Advanced self-monitoring controls keep you comfortable no matter what conditions are outside.
<b>CONVENIENT WIRELESS REMOTE CONTROLLER</b>	The remote controller offers comfort control in the palm of your hand. Press a button, and superior air conditioning is yours.
<b>WASHABLE LONG-LIFE ANTI-ALLERGEN FILTERS</b>	Filters help improve air quality and save you money by cleaning them instead of replacing them.
<b>ENVIRONMENTALLY FRIENDLY</b>	Mr. Slim systems use an environmentally-friendly refrigerant.



Wireless Remote Controller  
(optional wired remote controller available)

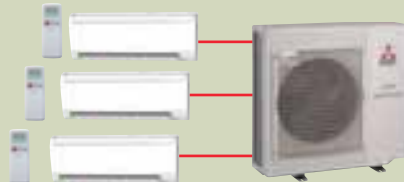

INVERTER

MXZ  
Wall-mounted Heat Pumps  
[pgs. 14-15]

# MS/MSY

COOLING ONLY  
WALL-MOUNTED SERIES

## Air Conditioners



INVERTER

(MSY Models Only)

MS and MSY Models

9,500 to 22,000  
Btu/h Capacity

M-Series  
Wireless Remote  
Controller



What is comfort? Comfort is a home that's cool and dry in the summer and cozy and warm in the winter. This is what you get with the Mr. Slim system: perfect year-round comfort. The M-Series models install easily. Mounted high on the wall, the indoor unit blends into most room environments without taking up any window space. These models also feature *automatic cooling/heating changeover*, which switches the unit from heating or cooling to compensate for fluctuating temperatures. Our M-Series models are the perfect way to cool or heat any room in your home. M-Series INVERTER systems provide high-speed and efficient cooling and heating performance to keep your home consistently cozy year-round.

## No Ductwork Required

Mr. Slim systems need no ductwork so if you are adding on a room, you don't have to tie into an existing system to steal



cold or warm air from other areas in the home. This advanced technology means better room control and increased comfort for your home or office, plus greater efficiency. Our systems are also very flexible and easy to install in almost any space.

## Superior INVERTER Technology

Benefit from technology that outperforms conventional systems. INVERTER control has many advantages. High rotation speed translates directly into faster cooling and heating. At low rotation speeds the temperature is efficiently maintained and starting currents are kept at low levels so they don't affect other appliances. Precise rotation speed control helps you keep temperatures consistently where you want them. Pulse Amplitude Modulation (PAM) keeps efficiency high by ensuring the system effectively uses 98 percent of input power supply.

# MSZ

HEAT PUMPS  
INVERTER-DRIVEN  
WALL-MOUNTED SERIES

## Heat Pumps



INVERTER

MSZ Model

9,000 to 22,000  
Btu/h Capacity

M-Series  
Wireless Remote  
Controller



## System Control in the Palm of Your Hand

Mr. Slim's M-Series offers a comprehensive remote controller that controls more than temperature and fan speed. It provides four modes: COOL, HEAT, AUTO, and DRY and has a 12-hour ON/OFF timer, giving you one-button control over your personal comfort. Our new MSY(Z)-A24NA models adds the WIDE VANE button to evenly distribute airflow to a wider angle (150 deg.) from right to left to ensure a more comfortable temperature is maintained across a wider area. The M-Series INVERTER models can tie into the P-Series wired controller and CITY MULTI® M-Net with adapter.



## Total, Healthy Comfort

The POWERFUL mode is available to cool or heat any desired space quickly by lowering the set temperature in cooling mode or raising the set temperature in heating mode by seven degrees. It increases the fan speed for 15 minutes. *Auto changeover* maintains consistent temperature in a room by automatically sensing whether the space needs cooling or heating. For challenging cooling environments, *low-ambient* temperature control means our models perform effectively in cooling mode even when the external temperatures dip to as low as 14 degrees Fahrenheit. Even more important, you can benefit from our *anti-allergy enzyme filter*. Using *artificial blue enzymes*, this filter minimizes germs, bacteria, and viruses.

## Warm Air Without Drafts

Our *hot-start technology* provides warmth from the beginning. The fan increases in speed as the coil is warmed, which reduces drafts, so when you want warm air, you'll get it.



Features	Benefits
<b>PROVEN INVERTER-DRIVEN COMPRESSOR TECHNOLOGY</b>	Your building will be pleasant year-round because our INVERTER technology provides powerful, quiet, and energy efficient cooling and heating.
<b>EFFICIENT</b>	Our systems use less energy under milder conditions, so you'll spend less money for operation and enjoy greater comfort.
<b>MAINTAINS CONSTANT TEMPERATURE LEVELS</b>	INVERTER technology eliminates annoying swings in temperature, which can cause drafts in any room. You'll stay comfortable year-round.
<b>SUPERIOR HEATING PERFORMANCE</b>	Compressor rotation speed is greatly accelerated to help improve the heat exchange between indoor and outdoor fan coils. Even at 15°F Mr. Slim can provide 50 percent of the rated heating capacity.



# SPECIFICATIONS FOR MS/MSY COOLING-ONLY M-SERIES (R410A)



INVERTER



Model Name	Indoor Unit		MS-A09WA	MS-A12WA	MSY-A15NA	MSY-A17NA	MSY-A24NA	
	Outdoor Unit		MU-A09WA	MU-A12WA	MUY-A15NA	MUY-A17NA	MUY-A24NA	
Cooling *1	Rated Capacity	Btu/h	9,500	12,000	15,000	16,200	22,000	
	Capacity Range	Btu/h	-	-	3,100-15,000	3,100-16,200	4,400-22,000	
	Total Input	W	870	1,070	1,690 (210-1,690)	2,070 (210-2,070)	2,850 (290-2,850)	
	Energy Efficiency	SEER	13		16			
	Moisture Removal	Pints/h	2.7	3.2	4.7	5.1	7.3	
	Sensible Heat Factor		0.68	0.70	0.65	0.65	0.63	
Power supply	Phase, Cycle, Voltage		1 Phase, 60Hz, 115V		1 Phase, 60Hz, 208/230V			
Voltage	Indoor - Outdoor S1-S2		AC 115V		AC 208/230V			
	Indoor - Outdoor S2-S3		DC12-24V					
	Indoor - Remote Controller		Wireless Type		Wireless Type (Optional Wired Controller: DC12V)			
Indoor Unit	MCA	A	1.2		1.0			
	Max. Fuse Size	(Time Delay) A	15					
	Fan Motor	F.L.A.	0.95		0.76			
	Airflow (Lo-Med-Hi)	DRY (CFM)	183-261-335	222-286-406	268-328-381		296-431-568	
		WET (CFM)	162-233-300	198-254-363	240-293-342		265-385-508	
	Sound Level (Lo-Med-Hi)	dB(A)	26-32-42	33-38-46	34-40-45	34-40-46	34-40-49	
	External Finish Color		Munsell 1.0Y 9.2/0.2					
	Dimension Unit	W: inch	30-11/16				43-5/16	
		D: inch	8-1/4				10-1/4	
		H: inch	11-3/4				12-13/16	
	Weight Unit	lbs.	23				37	
	Field Drain Pipe Size O.D.	inch	5/8				5/8	
Outdoor Unit	MCA	A	14	16	14	17		
	Max. Fuse Size	(Time Delay) A	15	20	15	20		
	Fan Motor	F.L.A.	0.63	0.93	0.52	0.93		
	Compressor	Model (Type)	RN092WHDHT	RN110WHDHT	SNB130FPDH			
		R.L.A.	9.3	10.82	10.1			
		L.R.A.	47	56	12	16		
	Airflow	CFM	1,083	1,327	1,249	1,729		
	Refrigerant Control		Capillary Tube		Linear Expansion Valve			
	Sound Level at Cooling *1	dB(A)	47	52	50	52	55	
	External Finish Color		Munsell 3Y 7.8/1.1					
	Dimensions	W: inch	31-1/2	33-7/16	31-1/2	33-1/16		
		D: inch	11-1/4	11-7/16	11-1/4		13	
H: inch		21-5/8	23-13/16	21-5/8	33-7/16			
Weight	lbs.	78	96	88	128			
Remote Controller	Type	Wireless Remote		Wireless Remote (Optional Wired Controller)				
Refrigerant	Type	R410A						
	Charge	lbs., oz.	2, 5	3, 1	2, 7	4		
	Oil	Type (fl. oz.)	NE022 (10.8)		NE022 (15.2)			
Refrigerant Pipe	Gas Side O.D.	inch	3/8	1/2	1/2		5/8	
	Liquid Side O.D.		1/4		1/4		1/4	
	Height (Max.)	feet	35		40		50	
	Length (Max.)		65		65		100	
Connection Method	Indoor/Outdoor		Flared/Flared					

NOTES: Test conditions are based on ARI 210/240

\*1 Rating conditions (cooling) - Indoor 80° FDB, 67° FWB, Outdoor: 95° FDB, (75° FWB)

Specifications are subject to change without notice.

LIMITED WARRANTY | Six-year warranty on compressor. One-year warranty on parts.



# SPECIFICATIONS FOR MSZ HEAT PUMP M-SERIES (R410A)



Model Name	Indoor Unit		MSZ-A09NA	MSZ-A12NA	MSZ-A15NA	MSZ-A17NA	MSZ-A24NA	
	Outdoor Unit		MUZ-A09NA	MUZ-A12NA	MUZ-A15NA	MUZ-A17NA	MUZ-A24NA	
Cooling *1	Rated Capacity	Btu/h	9,000	12,000	15,000	16,200	22,000	
	Capacity Range	Btu/h	5,500-9,000	5,700-12,000	3,100-15,000	3,100-16,200	4,400-22,000	
	Total Input	W	690 (390-690)	1,170 (395-1,170)	1,690 (210-1,690)	2,070 (210-2,070)	2,880 (290-2,880)	
	Energy Efficiency	SEER	17			16		
	Moisture Removal	Pints/h	2.3	3.2	4.7	5.1	7.3	
	Sensible Heat Factor		0.71	0.70	0.65		0.63	
Heating at 47° *2	Rated Capacity	Btu/h	10,900	13,600	18,000	20,100	23,200	
	Capacity Range	Btu/h	5,200-12,600	5,200-13,600	3,400-20,900		3,600-24,400	
	Total Input	W	860 (350-1,100)	1,160 (350-1,160)	1,790 (250-2,330)	2,150 (250-2,330)	2,350 (260-2,570)	
	HSPF (IV)	Btu/h/W	8.2					
Heating at 17° *3	Capacity	Btu/h	7,700	8,300	13,000	13,000	15,200	
	Total Input	W	880	930	1,740	1,740	1,960	
Power supply	Phase, Cycle, Voltage		1 Phase, 60Hz, 208/230V					
Voltage	Indoor - Outdoor S1-S2		AC 208/230V					
	Indoor - Outdoor S2-S3		DC12-24V					
	Indoor - Remote Controller		Wireless Type (Optional Wired Controller: DC12V)					
Indoor Unit	MCA	A	1.2		1.0			
	Max. Fuse Size	(Time Delay) A	15					
	Fan Motor	F.L.A.	0.76					
	Airflow (Cool)	DRY (CFM)	152-229-307	152-240-353	268-328-381		296-431-568	
	(Lo-Med-Hi) *1	WET (CFM)	134-205-275	134-215-318	240-293-342		265-385-508	
	Airflow (Heat) (Lo-Med-Hi) *2	DRY (CFM)	159-222-307	159-240-353	254-314-381		296-486-568	
	Sound Level (Cooling)	dB(A)	22-33-38	22-34-48	34-40-45	34-40-46	34-40-49	
	(Lo-Med-Hi) *1							
	Sound Level (Heating)	dB(A)	22-33-38	22-34-42	34-38-44	34-38-44	34-40-49	
	(Lo-Med-Hi) *2							
	External Finish Color	Munsell 1.0Y 9.2/0.2						
	Dimension Unit	W: inch	30-11/16				43-5/16	
		D: inch	8-1/4				10-1/4	
		H: inch	11-3/4				12-13/16	
Weight Unit	lbs.	23				37		
Field Drain Pipe Size O.D.	inch	5/8						
Outdoor Unit	MCA	A	12		14		17	
	Max. Fuse Size	(Time Delay) A	15				20	
	Fan Motor	F.L.A.	0.52				0.93	
	Compressor	Model (Type)	KNB092FPAH			SNB130FPDH		
		R.L.A.	7.8		10.1			
		L.R.A.	9.2		12			
	Airflow	CFM	1,249	1,094	1,249	1,249	1,729	
	Refrigerant Control	Linear Expansion Valve						
	Defrost Method	Reverse Cycle						
	Sound Level	dB(A) *1	48		51	53	55	
	External Finish Color	Munsell 3Y 7.8/1.1						
	Dimensions	W: inch	31-1/2				33-1/16	
		D: inch	11-1/4				13	
		H: inch	21-5/8				33-7/16	
Weight	lbs.	82		88		128		
Remote Controller	Type		Wireless Remote (Optional Wired Controller)					
Refrigerant	Type		R410A					
	Charge	lbs., oz.	2, 5	2, 5	2, 7	2, 7	4	
Refrigerant Pipe	Oil	Type (fl. oz.)	NE022 (10.8)			NE022 (15.2)		
	Gas Side O.D.	inch	3/8		1/2		5/8	
	Liquid Side O.D.		1/4					
	Height (Max.)	feet	40				50	
Length (Max.)		65				100		
Connection Method	Indoor/Outdoor		Flared/Flared					

NOTES: Test conditions are based on ARI 210/240

\*1 Rating conditions (cooling) - Indoor 80° FDB, 67° FWB, Outdoor: 95° FDB, (75° FWB).

\*2 Rating conditions (heating) - Indoor 70° FDB, 60° FWB, Outdoor: 47° FDB, (43° FWB).

\*3 Rating conditions (heating) - Indoor 70° FDB, 60° FWB, Outdoor: 17° FDB, (15° FWB).

Specifications are subject to change without notice.

LIMITED WARRANTY | Six-year warranty on compressor. One-year warranty on parts.

# MXZ

## INVERTER-DRIVEN MULTI-ZONE HEAT PUMP SYSTEMS

If you're looking for a complete comfort solution for several different rooms, the MXZ multi-zone system is the right choice for you. You can use up to 15 different combinations of indoor and outdoor units so the system is flexible enough to conform to your particular cooling and heating needs.

### Powerful, Efficient, and Versatile

Reap the benefits of our latest INVERTER-driven technology. High rotation speeds will deliver faster cooling and heating while low rotation speeds efficiently maintain comfort when a desired temperature is reached. The system ramps up slowly keeping initial starting currents low so they won't affect your other household appliances. The MXZ series is the perfect solution to cool spaces during the winter because it has the ability to maintain cooling when outside ambient temperatures reach as low as 14 degrees Fahrenheit.



### Multi-zone Heat Pump System Attributes

Multi-zone technology means that everybody can enjoy their ideal level of comfort no matter where they are in the home. Each zone operates independently so people in the kitchen, master bedroom, or living room will all enjoy the temperature that makes them feel the most comfortable.

#### MXZ-3A30NA (3:1, 2:1) Outdoor Unit

This 3:1 multi-zone system combination provides 28,400 Btu/h of cooling or 28,600 Btu/h of heating.

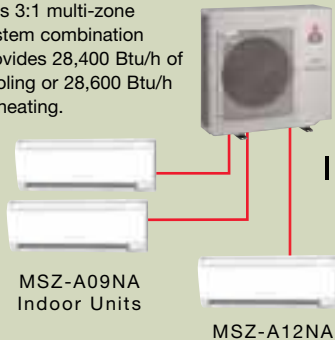

(At least two indoor units must be installed)

This 2:1 multi-zone system provides 20,000 Btu/h of cooling or 22,000 Btu/h of heating.

#### MXZ-2A20NA (2:1) Outdoor Unit

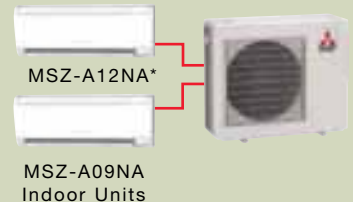

\* Requires port adapter accessory (See page 27 for more details)



# SPECIFICATIONS FOR MXZ HEAT PUMP

## MXZ SERIES (R410A)

INVERTER



Model Name	Outdoor Unit		MXZ-2A20NA *5	MXZ-3A30NA *6	
Indoor Unit	Cooling *1	Rated Capacity	Btu/h	20,000	28,400
		Capacity Range	Btu/h	7,800-20,000	12,600-28,400
		Total Input	W	2,150 (630-2,150)	3,250 (1,000-3,250)
	Heating 47° *2	Rated Capacity	Btu/h	22,000	28,600
		Capacity Range	Btu/h	8,500-22,000	11,400-36,000
		Total Input	W	1,780 (520-1,780)	2,180 (740-2,880)
Heating at 17° *3	Capacity	Btu/h	14,500	18,800	
	Total Input	W	1,500	2,120	
Power supply	Phase, Cycle, Voltage		1 Phase, 60Hz, 208/230V		
Voltage	Indoor - Outdoor S1-S2		AC 208/230V		
	Indoor - Outdoor S2-S3		DC12-24V		
Outdoor Unit *4	MCA	A	15	15	
	Max. Fuse Size	(Time Delay) A	20	20	
	Fan Motor	F.L.A.	0.96	0.93	
	Compressor	Model (Type)		SNB130FPDH1	TNB220FMCH
		R.L.A.		10.1	11
		L.R.A.		15	15
	Airflow (Cooling/Heating) *1/*2	CFM	1,485/1,640	1,365/1,605	
	Refrigerant Control	Linear Expansion Valve			
	Defrost Method	Reverse Cycle			
	Sound Level (Cooling/Heating) *1/*2	dB(A) *1	49/51	49/49	
	External Finish Color	Munsell 5Y 8/1			
	Dimensions	W: inch		33-1/16	35-7/16
		D: inch		13 (+1-3/16)	12-19/32 (+1-3/16)
		H: inch		27-15/16	35-7/16
Weight	lbs.		130	158	
Remote Controller	Type	Wireless Remote			
Refrigerant	Type	R410A			
	Charge	lbs., oz.	5, 15	7, 11	
Refrigerant Pipe	Oil	Type (fl. oz.)	NE022 (20.3)	NE022 (29.4)	
	Gas Side O.D.	inch	A, B: 3/8	A: 1/2; B, C: 3/8	
	Liquid Side O.D.		1/4	1/4	
	Height Difference (Max.)	feet	33	33	
	Length (Max.) (a + b or a + b + c)	feet	164	230	
	Length (Each Outdoor Unit)	feet	82	82	
Connection Method	Indoor/Outdoor	Flared/Flared			

Note: Test conditions are based on ARI 210/240

\*1 Rating conditions (cooling) - Indoor: 80° FDB, 67° FWB, Outdoor: 95° FDB, 75° FWB.

\*2 Rating conditions (heating) - Indoor: 70° FDB, 60° FWB, Outdoor: 47° FDB, 43° FWB.

\*3 Rating conditions (heating) - Indoor: 70° FDB, 60° FWB, Outdoor: 17° FDB, 15° FWB.

\*4 Refer to pages 12 and 13 for Indoor Unit specifications.

\*5 Data from combination of Indoor Units MSZ-A09NA and MSZ-A12NA.

\*6 Data from combination of Indoor Units MSZ-A09NA, MSZ-A09NA, and MSZ-A12NA.

Power factor equals 97%.

Specifications are subject to change without notice.

LIMITED WARRANTY | Six-year warranty on compressor. One-year warranty on parts.

### MXZ-2A20NA Combinations

Indoor Unit (Unit A + Unit B) Combinations	Cooling Capacity (Btu/h)			Power Usage (W)	Energy Efficiency		Current (A)	
	Heating Capacity (Btu/h)				SEER	HSPF	208V	230V
	Unit A	Unit B	Total					
MSZ-A09NA + MSZ-A09NA	9,000	9,000	18,000	1,740	13.0	7.7	8.62	7.8
	10,900	10,900	21,800	1,820			9.02	8.16
MSZ-A09NA + MSZ-A12NA	8,500	11,500	20,000	2,150	16.0	9.0	10.66	9.64
	9,500	12,500	22,000	1,780			8.82	7.98
MSZ-A09NA + MSZ-A15NA*	7,500	12,500	20,000	2,150	13.0	7.7	10.66	9.64
	8,250	13,750	22,000	1,780			8.82	7.98
MSZ-A12NA + MSZ-A12NA	10,000	10,000	20,000	2,150	13.0	7.7	10.66	9.64
	11,000	11,000	22,000	1,780			8.82	7.98

\*Port Adapter size = 3/8" x 1/2", Qty = 1, Part No. = MAC-A454JP-E

### MXZ-3A30NA Combinations

Indoor Unit Combinations (Unit A + Unit B + Unit C)	Cooling Capacity (Btu/h)				Power Usage (W)	Energy Efficiency		Current (A)		Port Adapter Requirements	
	Heating Capacity (Btu/h)					SEER	HSPF	208V	230V	Size	Qty. and Joint Pipe Part No.
	Unit A	Unit B	Unit C	Total							
MSZ-A09NA + MSZ-A09NA	9,000	9,000	-	18,000	1,800	13.0	7.7	8.92	8.07		N.A.
	10,900	10,900	-	21,800	1,700			8.43	7.62		
MSZ-A09NA + MSZ-A12NA	9,000	12,000	-	21,000	2,000	13.0	7.7	9.91	8.96		N.A.
	10,900	13,600	-	24,500	1,980			9.81	8.87		
MSZ-A09NA + MSZ-A15NA	9,000	15,000	-	24,000	2,500	13.0	7.7	12.39	11.21		N.A.
	10,100	16,900	-	27,000	2,200			10.90	9.86		
MSZ-A09NA + MSZ-A17NA	9,000	16,200	-	25,200	2,700	13.0	7.7	13.38	12.10		N.A.
	9,300	17,700	-	27,000	2,200			10.90	9.86		
MSZ-A09NA + MSZ-A24NA	7,600	20,400	-	28,000	3,200	13.0	7.7	15.86	14.34	3/8 X 5/8" or 1/2 X 5/8"	(1) PAC-SG76RJ-E or (1) MAC-A456JP-E
	7,300	19,700	-	27,000	1,980			9.81	8.87		
MSZ-A12NA + MSZ-A12NA	12,000	12,000	-	24,000	2,500	13.0	7.7	12.39	11.21		N.A.
	13,500	13,500	-	27,000	2,200			10.90	9.86		
MSZ-A12NA + MSZ-A15NA	11,500	14,500	-	26,000	2,800	13.0	7.7	13.88	12.55		N.A.
	12,000	15,000	-	27,000	2,160			10.71	9.68		
MSZ-A12NA + MSZ-A17NA	10,800	15,200	-	26,000	2,800	13.0	7.7	13.88	12.55		N.A.
	11,200	15,800	-	27,000	2,140			10.61	9.59		
MSZ-A15NA + MSZ-A15NA	13,000	13,000	-	26,000	2,800	13.0	7.7	13.88	12.55	3/8 X 1/2"	(1) MAC-A454JP-E
	13,500	13,500	-	27,000	2,120			10.51	9.50		
MSZ-A15NA + MSZ-A17NA	12,200	13,800	-	26,000	2,800	13.0	7.7	13.88	12.55	3/8 X 1/2"	(1) MAC-A454JP-E
	12,700	14,300	-	27,000	2,110			10.46	9.46		
MSZ-A17NA + MSZ-A17NA	13,000	13,000	-	26,000	2,800	13.0	7.7	13.88	12.55	3/8 X 1/2"	(1) MAC-A454JP-E
	13,500	13,500	-	27,000	2,100			10.41	9.41		
MSZ-A09NA + MSZ-A09NA + MSZ-A09NA	9,000	9,000	9,000	27,000	2,860	13.0	7.7	14.18	12.82	1/2 X 3/8"	(1) MAC-A455JP-E
	9,500	9,500	9,500	28,500	2,180			10.80	9.77		
MSZ-A09NA + MSZ-A09NA + MSZ-A12NA	8,500	8,500	11,400	28,400	3,250	16.0	10.0	16.11	14.57	1/2 X 3/8"	(1) MAC-A455JP-E
	8,600	8,600	11,400	28,600	2,180			10.80	9.77		
MSZ-A09NA + MSZ-A09NA + MSZ-A15NA	7,750	7,750	12,900	28,400	3,250	13.0	7.7	16.11	14.57		N.A.
	7,800	7,800	13,000	28,600	2,180			10.80	9.77		
MSZ-A09NA + MSZ-A09NA + MSZ-A17NA	7,300	7,300	13,800	28,400	3,250	13.0	7.7	16.11	14.57		N.A.
	7,350	7,350	13,900	28,600	2,180			10.80	9.77		

# P-SERIES

LARGE RESIDENTIAL, VARIED  
COMMERCIAL, AND INSTITUTIONAL

The Mr. Slim P-Series delivers flexible and convenient cooling and heating solutions to almost any commercial, institutional, or large residential application. Choose from small, quiet indoor and outdoor units that operate with the increased efficiency you need. Whether in a church, office building, school, nursing home, restaurant, retail store, or equipment room, the compact design of the P-Series indoor units makes cooling and heating difficult spaces a breeze. With wall-mounted, ceiling-recessed, and ceiling-suspended options, the P-Series is the perfect solution for almost any building. The P-Series provides up to 42,000 Btu/h of cooling or heating performance.

## INVERTER Technology

INVERTER-driven compressor technology gives Mr. Slim systems a higher degree of cooling and heating abilities that outperform and are more energy efficient than conventional systems. Desired room temperature is reached more quickly and maintained more consistently. This eliminates the peaks and valleys of temperature

swings that we're used to with older, conventional units.

## Flexible Control Options

Convenient and efficient zone control means you can cool or heat only the spaces in use. You can even have single or dual controllers connected to one system. The controller does not even have to be in the space shared with the indoor unit, which measures the room temperature. Features include a larger mode display, weekly timer, temperature range setting, setting lock, auto-off, expanded fault codes, and service call number display.

## Low Ambient Operation

This feature, along with the addition of a low-ambient wind baffle, allows for a space to be air-conditioned even when it is as low as 0° F outside. This cooling ability

is important when dealing with electronic equipment rooms, telecom substations, surveillance mechanical rooms, restaurant kitchens, fitness centers, and more.

## Redi-charged Systems

P-Series outdoor units come with enough refrigerant to be installed up to 100 feet away from the indoor units. Linesets can be run up to a maximum distance of 100 feet for PUY(Z)12-18 outdoor units and 165 feet for PUY(Z)24-42 outdoor units when additional charge is added. These systems are easier to fit into any space thanks to unique design profiles and R410A refrigerant. R410A is environmentally friendly with zero Ozone Depletion Potential (ODP).



P-Series Wired  
Remote Controller



PKA Wall-mounted  
Air Conditioners and  
Heat Pumps  
*[pgs.18-20]*



PCA Ceiling-suspended  
Air Conditioners and  
Heat Pumps  
*[pgs.21-23]*

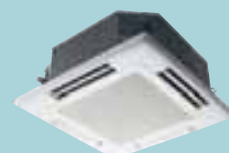

PLA Ceiling-recessed  
Air Conditioners and  
Heat Pumps  
*[pgs.24-26]*





## Hot-start System

Mr. Slim heat pumps use our *hot-start technology* to provide warmth from the beginning by ramping up fan speed as the coil warms. So when you want warm air without annoying drafts, that's what you'll get.

## Installation Service and Maintenance Ease

P-Series outdoor units are designed with easy service and maintenance in mind. Maintenance points are located behind easy-access panels, to make installation and service a breeze for a trained technician. Four-way piping access allows connection in four directions: front, rear, right, and bottom (all PUY/PUZ models). Using the new A-Control system, just three polarity sensitive wires, plus a ground conductor, run from the outdoor to the indoor unit providing both power and communication connections. Two non-polar wires connect the indoor unit and wall-mounted controller. This wiring design helps avoid installation errors. An optional wireless remote controller kit is available for the P-Series ceiling-mounted indoor units.

Features	Benefits
<b>INVERTER TECHNOLOGY</b>	You can enjoy high-speed cooling and heating and consistent delivery of comfort year-round.
<b>QUIET OPERATION</b>	You can hold a board meeting or teach a class in quiet comfort.
<b>NO DUCTWORK</b>	There's no need to shut down for major construction because installation is quick and easy.
<b>ZONE CONTROL</b>	You can cool and heat only those spaces desired for maximum control and energy efficiency.
<b>DEHUMIDIFICATION</b>	Drier air means healthier air and less damage to books or furniture.
<b>ADVANCED MICROPROCESSOR CONTROLS</b>	Built-in electronics ensure efficient operation and maximum performance for optimum comfort.
<b>LOW AMBIENT COOLING DOWN TO 0° F OUTDOORS</b>	This feature is perfect for computer network centers and telecom equipment rooms that need help to stay cool even during winter months.
<b>ENVIRONMENTALLY FRIENDLY</b>	Mr. Slim systems use an environmentally-friendly refrigerant.

## More Compact INVERTER-driven Outdoor Units

### PUY/PUZ



12,000-18,000  
Btu/h



24,000-36,000  
Btu/h



42,000  
Btu/h

These Mr. Slim units employ advanced Pulse Amplitude Modulation (PAM). PAM adjusts the form of the current wave to emulate the form of the supply voltage wave, meaning 98 percent of input power is effectively utilized.

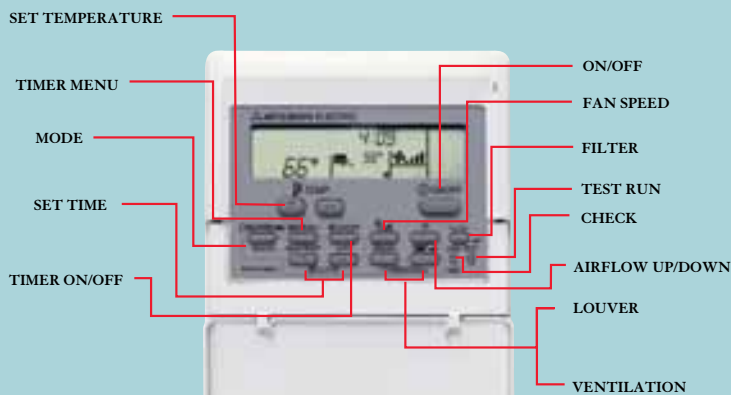

MULTILINGUAL

# PKA (GA/GAL, FA/FAL)

## WALL-MOUNTED SERIES



PKA Indoor Unit  
(Same indoor unit is used for both cooling and heat pump systems.)

12,000 to 34,200 Btu/h  
Capacity

The PKA-Series fills larger spaces with substantial cooling and heating from a compact, wall-mounted package. Walk into any room where a PKA system is installed and all you'll notice is the perfectly comfortable climate. What you may not notice is the unit itself because it mounts high on the wall and blends into most spaces. The PKA-Series features *Auto Changeover* mode that automatically switches back and forth from cooling to heating operation to compensate for indoor and outdoor temperature fluctuations.

### Auto Flap Shutter

With a simple flip of the *Off* switch, the vane closes to cover the air outlet for a clean presentation when not in use. During operation the vane can be adjusted to the perfect position to direct the airflow horizontally in cooling mode or towards the floor in heating mode keeping the room temperature even and comfortable.



### PAR-21MAA Controller

These Mr. Slim systems come with either a wired (GA/FA) or wireless (GAL/FAL) remote controller that puts you in command of your personal comfort.

### Easy-clean Filters

Convenient tabs enable the washable filters to be quickly and easily removed for fast cleaning. You won't need to replace the filters as with other systems, thereby saving money and time.

### Easy to Install the Slim and Lightweight Indoor Unit

The smallest PKA unit measures about 39-inches wide, 13-inches tall, and 9-inches deep and weighs 35 pounds and is easily installed high on most walls above windows or doorways. In many cases, just two licensed installers can do the installation in about a half day. And Mr. Slim PKA-Series models don't require ductwork. They don't need a huge hole cut in a wall as with motel-type or window-type units. Because PK



### PKA-L Series Controller

systems require only a small three-inch opening in the wall or ceiling, they may be installed into some of the toughest spaces, even on brick and masonry type walls.

### Ultimate Comfort Meets Ultimate Convenience

Select from either a wall-mounted, hard-wired controller (GA/FA) or a wireless remote controller (GAL/FAL) for ultimate comfort control. The hand-held Mr. Slim LCD wireless remote controller is easier to use than most TV remotes. The set-temperature display is large and easy to read. Using the 24-hour timer, you can get the unit operation to start and stop at specified times and to repeat daily. And the convenient remote provides easy control of the *Fan Speed* as well as the COOL, HEAT, AUTO, and DRY modes from anywhere in the room.





# SPECIFICATIONS FOR PKA COOLING-ONLY P-SERIES (R410A)



**INVERTER**



GA/FA = Wired controller  
GAL/FAL = Wireless controller  
BS = Seacoast Protection

Model Name	Indoor Unit		PKA-A12GA PKA-A12GAL	PKA-A18GA PKA-A18GAL	PKA-A24FA PKA-A24FAL	PKA-A30FA PKA-A30FAL	PKA-A36FA PKA-A36FAL	
	Outdoor Unit		PUY-A12NHA PUY-A12NHA-BS	PUY-A18NHA PUY-A18NHA-BS	PUY-A24NHA PUY-A24NHA-BS	PUY-A30NHA PUY-A30NHA-BS	PUY-A36NHA PUY-A36NHA-BS	
Cooling *1	Rated Capacity	Btu/h	12,000	18,000	24,000	30,000	34,200	
	Capacity Range	Btu/h	6,000-12,000	8,000-18,000	12,000-24,000	12,000-30,000	12,000-34,200	
	Total Input	W	1,210	2,240	2,650	4,400	5,030	
	Energy Efficiency	SEER	13.8	14.1	13.5	13	13.1	
	Moisture Removal	Pints/h	1.5	4.8	4.7	8.1	7.1	
	Sensible Heat Factor		0.86	0.7	0.78	0.7	0.77	
Power supply	Phase, Cycle, Voltage		1 Phase, 60Hz, 208/230V					
	Breaker Size	A	15	25	30			
Voltage	Indoor - Outdoor S1-S2		AC 208/230V					
	Indoor - Outdoor S2-S3		DC24V					
	Indoor - Remote Controller		DC12V : Wired Type (GA/FA)					
	Indoor - Remote Controller		Wireless Type (GAL/FAL)					
Indoor Unit	MCA	A	1					
	MOCP	A	15					
	Fan Motor	F.L.A.	0.33	0.43	0.52			
	Fan Motor Output	W	30	45	70			
	Airflow (Lo-M1-M2-Hi)	DRY (CFM)		320-350-390-425	530-705 (Lo-Hi)	780-990 (Lo-Hi)		
		WET (CFM)		290-315-350-380	480-635 (Lo-Hi)	700-890 (Lo-Hi)		
	Sound Level (Lo-M1-M2-Hi)	dB(A)	36-38-41-43	39-45 (Lo-Hi)	46-49 (Lo-Hi)			
	External Finish Color		Munsell 0.70Y 8.59/0.97					
	Dimension Unit	W: inch	39					
		D: inch	9-1/4					
		H: inch	13-3/8					
	Weight Unit	lbs.	35	53	62			
	Field Drain Pipe Size I.D.	inch	13/16					
Outdoor Unit	MCA	A	13	18	25			
	MOCP	A	15	20	30	40		
	Fan Motor	F.L.A.	0.35	0.75				
	Fan Motor Output	W	40	75				
	Compressor			SNB130FPBM1	TNB220FLDM			
		R.L.A.		12				
		L.R.A.		14	17.5			
	Airflow	CFM	1,200	1,940				
	Refrigerant Control		Linear Expansion Valve					
	Sound Level at Cooling *1	dB(A)	46	48				
	External Finish Color		Munsell 3Y 7.8/1.1					
	Dimensions	W: inch	31-1/2					
		D: inch	13 + 7/8					
		H: inch	23-5/8					
Weight	lbs.	90	97	163				
Remote Controller		Located with Indoor Unit (GA/FA = Wired; GAL/FAL = Wireless)						
Refrigerant	Type	R410A						
	Charge	lbs., oz.	2 lbs. 14 oz.	3 lbs. 12 oz.	6 lbs.			
	Oil	Type (fl. oz.)	MEL56 (20)			MEL56 (28)		
Refrigerant Pipe	Gas Side O.D.	inch	1/2	5/8				
	Liquid Side O.D.	inch	1/4	3/8				
Refrigerant Pipe Length	Height Difference	Max.100 ft.						
	Length	Max.100 ft.			Max.165 ft.			
Connection Method		Flared						

**NOTES:**

\*1 Rating conditions (cooling)-Indoor: D.B. 26.7° C (80° F), W.B. 19.4° C (67° F) Outdoor: D.B. 35° C (95° F), W.B. 23.9° C (75° F).  
Specifications are subject to change without notice.

LIMITED WARRANTY | Six-year warranty on compressor. One-year warranty on parts.



# SPECIFICATIONS FOR PKA HEAT PUMP

## P-SERIES (R410A)



INVERTER



GA/FA = Wired controller  
 GAL/FAL = Wireless controller  
 BS = Seacoast Protection

Model Name	Indoor Unit		PKA-A18GA PKA-A18GAL	PKA-A24FA PKA-A24FAL	PKA-A30FA PKA-A30FAL	PKA-A36FA PKA-A36FAL	
	Outdoor Unit		PUZ-A18NHA PUZ-A18NHA-BS	PUZ-A24NHA PUZ-A24NHA-BS	PUZ-A30NHA PUZ-A30NHA-BS	PUZ-A36NHA PUZ-A36NHA-BS	
Cooling *1	Rated Capacity	Btu/h	18,000	24,000	30,000	34,200	
	Capacity Range	Btu/h	8,000-18,000	12,000-24,000	12,000-30,000	12,000-34,200	
	Total Input	W	2,240	2,650	4,400	5,030	
	Energy Efficiency	SEER	14.1	13.5	13	13.1	
	Moisture Removal	Pints/h	4.8	4.7	8.1	7.1	
	Sensible Heat Factor		0.7	0.78	0.7	0.77	
Heating at 47° *2	Rated Capacity	Btu/h	19,000	26,000	32,000	37,000	
	Capacity Range	Btu/h	8,000-20,000	12,000-28,000	12,000-34,000	12,000-38,000	
	Total Input	W	2,130	2,570	3,660	3,610	
	HSPF (IV)	Btu/h/W	8.3	8.5	8.5	8.3	
Heating at 17° *3	Capacity	Btu/h	13,000	16,000	23,000	25,000	
	Total Input	W	1,670	2,200	3,050	3,070	
Power supply	Phase, Cycle, Voltage		1 Phase, 60Hz, 208/230V				
	Breaker Size	A	15	25	30		
Voltage	Indoor - Outdoor S1-S2		AC 208/230V				
	Indoor - Outdoor S2-S3		DC24V				
	Indoor - Remote Controller		DC12V : Wired Type (GA/FA)				
	Indoor - Remote Controller		Wireless Type (GAL/FAL)				
Indoor Unit	MCA	A	1				
	MOCP	A	15				
	Fan Motor	F.L.A.	0.33	0.43	0.52		
	Fan Motor Output	W	30	45	70		
	Airflow (Lo-M1-M2-Hi)	DRY (CFM)	320-350-390-425		530-705 (Lo-Hi)		780-990 (Lo-Hi)
		WET (CFM)	290-315-350-380		480-635 (Lo-Hi)		700-890 (Lo-Hi)
	Sound Level (Lo-M1-M2-Hi)	dB(A)	36-38-41-43		39-45		46-49
	External Finish Color		Munsell 0.70Y 8.59/0.97		Munsell 3.4Y 7.7/0.8		
	Dimension Unit	W: inch	39		55-1/8		66-1/8
		D: inch	9-1/4				
		H: inch	13-3/8				
	Weight Unit	lbs.	35	53	62		
	Field Drain Pipe Size I.D.	inch	13/16				
Outdoor Unit	MCA	A	13	18	25		
	MOCP	A	20	30	40		
	Fan Motor	F.L.A.	0.35	0.75			
	Fan Motor Output	W	40	75			
	Compressor		SNB130FPBM1		TNB220FLDM		
		R.L.A.	12				
	L.R.A.	14		17.5			
	Airflow	CFM	1,200	1,940			
	Refrigerant Control		Linear Expansion Valve				
	Defrost Method		Reverse Cycle				
	Sound Level at Cooling *1	dB(A)	46	48			
	Sound Level at Heating *2	dB(A)	47	50			
	External Finish Color		Munsell 3Y 7.8/1.1				
Dimensions	W: inch	31-1/2		37-3/8			
	D: inch	11-13/16 + 7/8		13 + 1-3/16			
	H: inch	23-5/8		37-1/8			
Weight	lbs.	99	165				
Remote Controller		Located with Indoor Unit					
Refrigerant	Type	R410A					
	Charge	lbs., oz.	3 lbs. 12 oz.	6 lbs.			
	Oil	Type (fl. oz.)	MEL56 (20)		MEL56 (28)		
Refrigerant Pipe	Gas Side O.D.	inch	1/2	5/8			
	Liquid Side O.D.	inch	1/4	3/8			
Refrigerant Pipe Length	Height Difference		Max.100 ft.				
	Length		Max.100 ft.	Max.165 ft.			
Connection Method		Flared					

**NOTES:**

- \*1 Rating conditions (cooling)-Indoor: D.B. 26.7° C (80° F), W.B. 19.4° C (67° F) Outdoor: D.B. 35° C (95° F), W.B. 23.9° C (75° F).
  - \*2 Rating conditions (heating)-Indoor: D.B. 21.1° C (70° F), W.B. 15.6° C (60° F) Outdoor: D.B. 8.3° C (47° F), W.B.6.1° C (43° F).
  - \*3 Rating conditions (heating)-Indoor: D.B. 21.1° C (70° F), W.B. 15.6° C (60° F) Outdoor: D.B. -8.3° C (17° F), W.B. -9.4° C (15° F).
- Specifications are subject to change without notice.

LIMITED WARRANTY | Six-year warranty on compressor. One-year warranty on parts.

# PCA

## CEILING-SUSPENDED SERIES



PCA Indoor Unit  
(Same indoor unit is used for both cooling and heat pump systems)

**24,000 to 42,000  
Btu/h Capacity**

Powerful cooling and heating performance is what the PCA-Series is all about. This ceiling-suspended unit delivers enough cold or hot air to make any space more comfortable. Manually-adjusted oversized swing louvers direct the airflow left or right, quietly covering the entire space. Accessory filters are available to increase efficiency and increase the time span between service calls. The PCA-Series is perfect for restaurants, kitchens, and other larger commercial spaces where ovens and other equipment add to an already taxed cooling or heating load.

### Control Airflow Angle for Better Coverage

With the wired remote controller, four different airflow positions can be set. When using the *Autovane* during cooling, the angle self-adjusts into a horizontal position to circulate cold air more effectively. During heating the vane forces the hot air downward toward the floor, where it will rise and circulate, keeping your room comfortable from top to bottom.

### Warm Air with No Drafts

Mr. Slim P-Series heat pumps use our *hot-start technology* to provide warmth from the beginning. So when you want warm air, you'll get it without drafts.



*All Mr. Slim PCA-Series models come with a wired remote controller that puts you in command of your personal comfort. The wireless controller is available in an accessory kit.*

### Bring Outside Air In

Ducting can be installed with minimal on-site work to bring in outside air, creating a healthier indoor environment.

### Automatic Cooling/heating Changeover (Heat Pumps)

When set to *Auto*, heat pump systems will automatically switch back and forth from cooling to heating operation to compensate for the indoor and outdoor temperature fluctuations. This feature means total hands-free comfort and efficient air conditioning of your space.







# SPECIFICATIONS FOR PC COOLING-ONLY P-SERIES (R410A)

INVERTER



BS = Seacoast Protection

Model Name	Indoor Unit		PCA-A24GA	PCA-A30GA	PCA-A36GA	PCA-A42GA	
	Outdoor Unit		PUY-A24NHA PUY-A24NHA-BS	PUY-A30NHA PUY-A30NHA-BS	PUY-A36NHA PUY-A36NHA-BS	PUY-A42NHA PUY-A42NHA-BS	
Cooling *1	Rated Capacity	Btu/h	24,000	30,000	35,000	42,000	
	Capacity Range	Btu/h	12,000-24,000	12,000-30,000	12,000-35,000	18,000-42,000	
	Total Input	W	2,500	4,100	4,630	5,070	
	Energy Efficiency	SEER	13.4	13	13.1	13.8	
	Moisture Removal	Pints/h	5.4	8.3	8.2	11.7	
	Sensible Heat Factor		0.75	0.69	0.74	0.69	
Power supply	Phase, Cycle, Voltage		1 Phase, 60Hz, 208/230V				
	Breaker Size	A	25	30			
Voltage	Indoor - Outdoor S1-S2		AC 208/230V				
	Indoor - Outdoor S2-S3		DC24V				
	Indoor - Remote Controller		DC12V : Wired Type				
Indoor Unit	MCA	A	1				
	MOCP	A	15				
	Fan Motor	F.L.A.	0.53		0.69		
	Fan Motor Output	W	70		90		
	Airflow (Lo-M1-M2-Hi)	DRY (CFM)	495-530-565-635		705-740-810-880		
		WET (CFM)	445-480-510-570		635-670-730-790		
	Sound Level (Lo-M1-M2-Hi)	dB(A)	37-39-41-43		40-41-43-45		
	External Finish Color		Munsell 0.70Y 8.59/0.97				
	Dimension Unit	W: inch	51-9/16				
		D: inch	26-3/4				
H: inch		8-3/10		10-5/8			
Weight Unit	lbs.	75		82			
Field Drain Pipe Size O.D.	inch	1					
Outdoor Unit	MCA	A	18	25	26		
	MOCP	A	30	40			
	Fan Motor	F.L.A.	0.75		0.4 + 0.4		
	Fan Motor Output	W	75		86 + 86		
	Compressor			TNB220FLDM			ANV33FDDMT
		R.L.A.		12		20	
		L.R.A.	14	17.5		27.5	
	Airflow	CFM	1,940		3,530		
	Refrigerant Control		Linear Expansion Valve				
	Sound Level at Cooling *1	dB(A)	48		51		
	External Finish Color		Munsell 3Y 7.8/1.1				
	Dimensions	W: inch	37-3/8				
		D: inch	13 + 1-3/16				
H: inch		37-1/8		53-1/8			
Weight	lbs.	163		265			
Remote Controller	Wired Remote Controller Located with Indoor Unit						
Refrigerant	Type		R410A				
	Charge	lbs.	6		10		
	Oil	Type (fl. oz.)	MEL56 (28)		MEL56 (45)		
Refrigerant Pipe	Gas Side O.D.	inch	5/8				
	Liquid Side O.D.	inch	3/8				
Refrigerant Pipe Length	Height Difference		Max.100 ft.				
	Length		Max.165 ft.				
Connection Method	Flared						

**NOTES:**

\*1 Rating conditions (cooling)-Indoor: D.B. 26.7° C (80° F), W.B. 19.4° C (67° F) Outdoor: D.B. 35° C (95° F), W.B. 23.9° C (75° F). Specifications are subject to change without notice.

**Available Options**

- Wireless Remote Controller Kit
- Wind Baffle

LIMITED WARRANTY | Six-year warranty on compressor. One-year warranty on parts.



# SPECIFICATIONS FOR PC HEAT PUMP P-SERIES (R410A)

INVERTER



BS = Seacoast Protection

Model Name	Indoor Unit		PCA-A24GA	PCA-A30GA	PCA-A36GA	PCA-A42GA	
	Outdoor Unit		PUZ-A24NHA PUZ-A24NHA-BS	PUZ-A30NHA PUZ-A30NHA-BS	PUZ-A36NHA PUZ-A36NHA-BS	PUZ-A42NHA PUZ-A42NHA-BS	
Cooling *1	Rated Capacity	Btu/h	24,000	30,000	35,000	42,000	
	Capacity Range	Btu/h	12,000-24,000	12,000-30,000	12,000-35,000	18,000-42,000	
	Total Input	W	2,500	4,100	4,630	5,070	
	Energy Efficiency	SEER	13.4	13	13.1	13.8	
	Moisture Removal	Pints/h	5.4	8.3	8.2	11.7	
	Sensible Heat Factor		0.75	0.69	0.74	0.69	
Heating at 47° *2	Rated Capacity	Btu/h	26,000	32,000	37,000	45,000	
	Capacity Range	Btu/h	12,000-28,000	12,000-34,000	12,000-38,000	18,000-48,000	
	Total Input	W	2,570	3,390	3,490	4,850	
	HSPF (Iv)	Btu/h/W	8.5	8.5	8.3	8.5	
Heating at 17° *3	Capacity	Btu/h	16,000	23,000	25,000	30,000	
	Total Input	W	2,200	3,050	3,070	4,300	
Power supply	Phase, Cycle, Voltage	1 Phase, 60Hz, 208/230V					
	Breaker Size	A	25		30		
Voltage	Indoor - Outdoor S1-S2	AC 208/230V					
	Indoor - Outdoor S2-S3	DC24V					
	Indoor - Remote Controller	DC12V: Wired Type					
Indoor Unit	MCA	A				1	
	MOCP	A				15	
	Fan Motor	F.L.A.	0.53			0.69	
	Fan Motor Output	W	70			90	
	Airflow (Lo-M1-M2-Hi)	DRY (CFM)	495-530-565-635			705-740-810-880	
		WET (CFM)	445-480-510-570			635-670-730-790	
	Sound Level (Lo-M1-M2-Hi)	dB(A)	37-39-41-43			40-41-43-45	
	External Finish Color	Munsell 0.70Y 8.59/0.97					
	Dimension Unit	W: inch	51-9/16				
		D: inch	26-3/4				
		H: inch	8-3/10			10-5/8	
Weight Unit	lbs.	75			82		
Field Drain Pipe Size O.D.	inch	1					
Outdoor Unit	MCA	A	18	25	40	26	
	MOCP	A	30				
	Fan Motor	F.L.A.	0.75			0.4 + 0.4	
	Fan Motor Output	W	75			86 + 86	
	Compressor		TNB220FLDM				
		R.L.A.	12			20	
		L.R.A.	14	17.5			27.5
	Airflow	CFM	1,940			3,530	
	Refrigerant Control	Linear Expansion Valve					
	Defrost Method	Reverse Cycle					
	Sound Level at Cooling *1	dB(A)	48			51	
	Sound Level at Heating *2	dB(A)	50			55	
	External Finish Color	Munsell 3Y 7.8/1.1					
	Dimensions	W: inch	37-3/8				
D: inch		13 + 1-3/16					
H: inch		37-1/8			53-1/8		
Weight	lbs.	165			267		
Remote Controller	Wired Remote Controller Located with Indoor Unit						
Refrigerant	Type	R410A					
	Charge	lbs.	6			10	
Refrigerant Pipe	Oil	Type (fl. oz.)	MEL56 (28)			MEL56 (45)	
	Gas Side O.D.	inch	5/8				
Refrigerant Pipe Length	Liquid Side O.D.	inch	3/8				
	Height Difference	Max.100 ft.					
Connection Method	Length	Max.165 ft.					
		Flared					

**NOTES:**

- \*1 Rating conditions (cooling)-Indoor: D.B. 26.7° C (80° F), W.B. 19.4° C (67° F) Outdoor: D.B. 35° C (95° F), W.B. 23.9° C (75° F).
  - \*2 Rating conditions (heating)-Indoor: D.B. 21.1° C (70° F), W.B. 15.6° C (60° F) Outdoor: D.B. 8.3° C (47° F), W.B. 6.1° C (43° F).
  - \*3 Rating conditions (heating)-Indoor: D.B. 21.1° C (70° F), W.B. 15.6° C (60° F) Outdoor: D.B. -8.3° C (17° F), W.B. -9.4° C (15° F).
- Specifications are subject to change without notice.

**Available Options**

- Wireless Remote Controller Kit
- Wind Baffle

LIMITED WARRANTY | Six-year warranty on compressor. One-year warranty on parts.

# PLA

## CEILING-RECESSED SERIES

PLA Indoor Unit  
(Same indoor unit is used for both  
cooling and heat pump systems)

12,000 to 42,000  
Btu/h Capacity

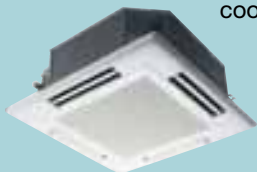

If there's at least a foot of space above your ceiling, the PLA-Series is for you. These models combine powerful cooling and heating in an elegant cassette design that recesses into the ceiling. When installed, the attractive, flush-mounted grille is all you see. With its fresh air intake capability and four-way discharge airflow, the PLA-Series gives you plenty of fresh, comfortable airflow options. There are even branch duct knockouts for either a round or a rectangular duct, allowing for the air conditioning of a smaller adjacent space. All these features are found in a versatile, attractive design made to disappear discreetly into the ceiling.

### Easy-to-maintain, Long-life Filter

The washable filter provides about 2,500 hours of use in a normal office environment before cleaning is needed.

### Auto Cooling/heating Changeover

Heat pump systems will automatically switch back and forth from cooling to heating to compensate for temperature fluctuations in a room.

### Customize the Airflow Pattern to Meet Your Needs

The PLA-Series offers two-, three-, or four-way airflow selection, enabling effective air conditioning in places such as halls, showrooms, and shopping malls.\*

\* Optional air outlet shutter plate is necessary for two- or three-way airflow setting.

### Easy to Install

PLA-Series units are about 40 percent lighter than previous models, making suspension work easier. The unit level can be adjusted through the corner pockets without removing the grille.

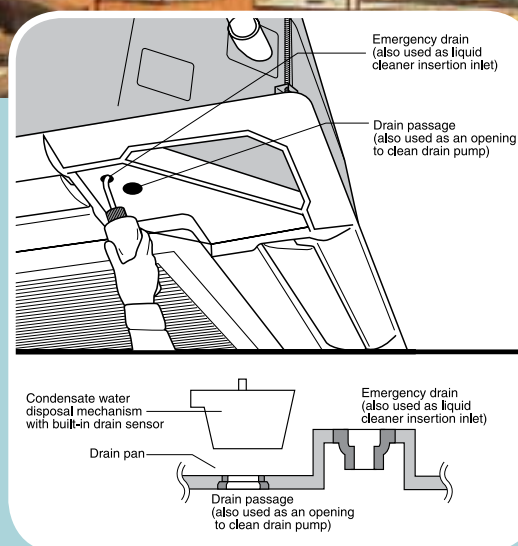

### Drain Lift for Condensate Water Removal

A built-in, high-performance drain pump means improved condensate water removal. The pump lifts the water up to 33 inches above the unit to help simplify drain piping. A built-in drain sensor shuts off the indoor unit if a drain is clogged or in the unlikely event the pump malfunctions. This fail-proof system is the perfect solution for computer rooms or high-end conference rooms.





# SPECIFICATIONS FOR PL COOLING-ONLY P-SERIES (R410A)

INVERTER



BS = Seacoast Protection

Model Name	Indoor Unit		PLA-A12AA	PLA-A18AA	PLA-A24AA	PLA-A30AA	PLA-A36AA	PLA-A42AA	
	Outdoor Unit		PUY-A12NHA-BS PUY-A12NHA	PUY-A18NHA-BS PUY-A18NHA	PUY-A24NHA-BS PUY-A24NHA	PUY-A30NHA-BS PUY-A30NHA	PUY-A36NHA-BS PUY-A36NHA	PUY-A42NHA-BS PUY-A42NHA	
Cooling *1	Rated Capacity	Btu/h	12,000	18,000	24,000	30,000	35,000	42,000	
	Capacity Range	Btu/h	6,000-12,000	8,000-18,000	12,000-24,000	12,000-30,000	12,000-35,000	18,000-42,000	
	Total Input	W	1,260	1,870	2,500	4,100	4,510	4,820	
	Energy Efficiency	SEER	13	13.2	13.4	13	13.1	13.1	
	Moisture Removal	Pints/h	1.8	1.5	5	8.1	7.2	10.9	
	Sensible Heat Factor		0.83	0.91	0.77	0.7	0.77	0.71	
Power supply	Phase, Cycle, Voltage		1 Phase, 60Hz, 208/230V						
	Breaker Size	A	15		25	30			
Voltage	Indoor - Outdoor S1-S2		AC 208/230V						
	Indoor - Outdoor S2-S3		DC24V						
	Indoor - Remote Controller		DC12V: Wired Type						
Indoor Unit	MCA	A	1				2		
	MOCP	A	15						
	Fan Motor	F.L.A.	0.79				1.25		
	Fan Motor Output	W	70				110		
	Airflow (Lo-M1-M2-Hi)	DRY (CFM)	390-420-460-490	530-570-640-710			710-810-920-990		
		WET (CFM)	350-380-420-450	490-530-600-670			670-770-880-950		
	Sound Level (Lo-M1-M2-Hi)	dB(A)	27-28-29-31	28-30-32-34			33-36-39-41		
	External Finish Color (Panel)		Munsell 0.70Y 8.59/0.97						
	Dimension Unit (Panel)	W: inch	33-1/16 (37-3/8)						
		D: inch	33-1/16 (37-3/8)						
		H: inch	10-3/16 (1-3/16)				11-3/4(1-3/16)		
	Weight Unit (Panel)	lbs.	49 (11)	53 (11)			66 (11)	66 (11)	
	Field Drain Pipe Size O.D.	inch	1-1/4						
Outdoor Unit	MCA	A	13		18	25		26	
	MOCP	A	15	20	30	40			
	Fan Motor	F.L.A.	0.35		0.75		0.4 + 0.4		
	Fan Motor Output	W	40		75		86 + 86		
	Compressor		SNB130FPBM1			TNB220FLDM		ANV33FDDMT	
		R.L.A.	12						20
		L.R.A.	14			17.5		27.5	
	Airflow	CF	1,200			1,940		3,530	
	Refrigerant Control		Linear Expansion Valve						
	Sound Level at Cooling *1	dB(A)	46			48		51	
	External Finish Color		Munsell 3Y 7.8/1.1						
	Dimensions	W: inch	31-1/2			37-3/8			
		D: inch	11-13/16			13 + 1-3/16			
H: inch		23-5/8			37-1/8		53-1/8		
Weight	lbs.	90	97	163		265			
Remote Controller		Wired Remote Controller Packaged with Grille							
Refrigerant	Type	R410A							
	Charge	lbs., oz.	2 lbs. 14 oz.	3 lbs. 12 oz.	6 lbs.		10 lbs.		
	Oil	Type (fl. oz.)	MEL56 (20)			MEL56 (28)		MEL56 (45)	
Refrigerant Pipe	Gas Side O.D.	inch	1/2			5/8			
	Liquid Side O.D.	inch	1/4			3/8			
Refrigerant Pipe Height Difference		Max.100 ft.							
Refrigerant Pipe Length	Length	Max.100 ft.			Max.165 ft.				
Connection Method		Flared							

**NOTES:**

\*1 Rating conditions (cooling)-Indoor: D.B. 26.7° C (80° F), W.B. 19.4° C (67° F) Outdoor: D.B. 35° C (95° F), W.B. 23.9° C (75° F). Specifications are subject to change without notice.

**Available Options**

- Wireless Remote Controller Kit
- Wind Baffle

LIMITED WARRANTY | Six-year warranty on compressor. One-year warranty on parts.

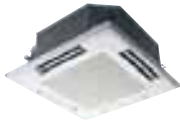

# SPECIFICATIONS FOR PL HEAT PUMP

## P-SERIES (R410A)



INVERTER



BS = Seacoast Protection

Model Name	Indoor Unit		PLA-A18AA	PLA-A24AA	PLA-A30AA	PLA-A36AA	PLA-A42AA	
	Outdoor Unit		PUZ-A18NHA-BS PUZ-A18NHA	PUZ-A24NHA-BS PUZ-A24NHA	PUZ-A30NHA-BS PUZ-A30NHA	PUZ-A36NHA-BS PUZ-A36NHA	PUZ-A42NHA-BS PUZ-A42NHA	
Cooling *1	Rated Capacity	Btu/h	18,000	24,000	30,000	35,000	42,000	
	Capacity Range	Btu/h	8,000-18,000	12,000-24,000	12,000-30,000	12,000-35,000	18,000-42,000	
	Total Input	W	1,870	2,500	4,100	4,510	4,820	
	Energy Efficiency	SEER	13.2	13.4	13	13.1	13.1	
	Moisture Removal	Pints/h	1.5	5	8.1	7.2	10.9	
	SHF		0.91	0.77	0.7	0.77	0.71	
Heating at 47° *2	Rated Capacity	Btu/h	19,000	26,000	32,000	37,000	45,000	
	Capacity Range	Btu/h	8,000-20,000	12,000-28,000	12,000-34,000	12,000-38,000	18,000-48,000	
	Total Input	W	1,620	2,570	3,370	3,490	5,070	
	HSPF(IV)	Btu/h/W	8.3	8.5	8.5	8.3	8.5	
Heating at 17° *3	Capacity	Btu/h	13,000	16,000	23,000	25,000	30,000	
	Total Input	W	1,400	2,200	3,050	3,070	4,300	
Power supply	Phase, Cycle, Voltage		1 Phase, 60Hz, 208/230V					
	Breaker Size	A	15	25	30			
Voltage	Indoor - Outdoor S1-S2		AC 208/230V					
	Indoor - Outdoor S2-S3		DC24V					
	Indoor - Remote Controller		DC12V: Wired Type					
Indoor Unit	MCA	A	1			2		
	MOCP	A	15					
	Fan Motor	F.L.A.	0.79				1.25	
	Fan Motor Output	W	70				110	
	Airflow (Lo-M1-M2-Hi)	DRY (CFM)	530-570-640-710				710-810-920-990	
		WET (CFM)	490-530-600-670				670-770-880-950	
	External Pressure	Pa	0					
	Sound Level (Lo-M1-M2-Hi)	dB(A)	28-30-32-34				33-36-39-41	
	External Finish Color (Panel)		Munsell 0.70Y 8.59/0.97					
	Dimension Unit (Panel)	W: inch	33-1/16 (37-3/8)					
		D: inch	33-1/16 (37-3/8)					
		H: inch	10-3/16 (1-3/16)			11-3/4(1-3/16)		
	Weight Unit (Panel)	lbs.	11			11	11	
Field Drain Pipe Size O.D.	inch	1-1/4						
Outdoor Unit	MCA	A	13	18	25		26	
	MOCP	A	20	30	40			
	Fan Motor	F.L.A.	0.35	0.75			0.4 + 0.4	
	Fan Motor Output	W	40	75			86 + 86	
	Compressor			SNB130FPBM1		TNB220FLDM		ANV33FDDMT
		R.L.A.		12				20
		L.R.A.		14	17.5			27.5
	Airflow	CFM	1,200	1,940			3,530	
	Refrigerant Control		Linear Expansion Valve					
	Defrost Method		Reverse Cycle					
	Sound Level at Cooling *1	dB(A)	46	48			51	
	Sound Level at Heating *2	dB(A)	47	50			55	
	External Finish Color		Munsell 3Y 7.8/1.1					
Dimensions	W: inch	31-1/2	37-3/8					
	D: inch	11-13/16	13 + 1-3/16					
	H: inch	23-5/8	37-1/8			53-1/8		
Weight	lbs.	99	165			267		
Remote Controller		Wired Remote Controller Packaged with Grille						
Refrigerant	Type	R410A						
	Charge	lbs., oz.	3 lbs. 12 oz.	6 lbs.		10 lbs.		
	Oil	Type (fl. oz.)	MEL56 (20)	MEL56 (28)		MEL56 (45)		
Refrigerant Pipe	Gas Side O.D.	inch	1/2	5/8				
	Liquid Side O.D.	inch	1/4	3/8				
Refrigerant Pipe Length	Height Difference	Max.100 ft.						
	Length	Max.100 ft.	Max.165 ft.					
Connection Method		Flared						

**NOTES:**

\*1 Rating conditions (cooling)-Indoor: D.B. 26.7° C (80° F), W.B. 19.4° C (67° F) Outdoor: D.B. 35° C (95° F), W.B. 23.9° C (75° F).  
 \*2 Rating conditions (heating)-Indoor: D.B. 21.1° C (70° F), W.B. 15.6° C (60° F) Outdoor: D.B. 8.3° C (47° F), W.B. 6.1° C (43° F).  
 \*3 Rating conditions (heating)-Indoor: D.B. 21.1° C (70° F), W.B. 15.6° C (60° F) Outdoor: D.B. -8.3° C (17° F), W.B. -9.4° C (15° F).  
 Specifications are subject to change without notice.

**Available Options**

- Wireless Remote Controller Kit
- Wind Baffle

LIMITED WARRANTY | Six-year warranty on compressor. One-year warranty on parts.

GENERAL SPECIFICATIONS

MS/MSY/MSZ/MXZ RATING CONDITIONS

		INDOOR INTAKE AIR TEMPERATURE	OUTDOOR INTAKE AIR TEMPERATURE
COOLING	MAXIMUM	95° F DB, 71° F WB	115° F DB
	MINIMUM	67° F DB, 57° F WB	67° F (MS)* / 14° F (MSY/MSZ/MXZ)
HEATING	MAXIMUM	80° F DB, 67° F WB	75° F DB, 65° F WB
	MINIMUM	70° F DB, 60° F WB	12° F DB, 15° F WB

\* MS units operate at intake air temperature down to 10° F with the addition of and ICM326HM1 low temperature control.

GENERAL SPECIFICATIONS

PKA/PCA/PLA RATING CONDITIONS

		INDOOR INTAKE AIR TEMPERATURE	OUTDOOR INTAKE AIR TEMPERATURE
COOLING	MAXIMUM	95° F DB, 71° F WB	115° F DB
	MINIMUM	67° F DB, 57° F WB	0° F DB*
HEATING	MAXIMUM	80° F DB, 67° F WB	70° F DB, 59° F WB
	MINIMUM	70° F DB, 60° F WB	12° F DB, 10° F WB

\* With wind baffle installed. Without wind baffle installed, the minimum temperature will be 23° F DB.

OPTIONAL ACCESSORIES

PART NUMBER	USE WITH	DESCRIPTION
<b>Control Options</b>		
MAC-397IF-E	MSZ Series Inverter	MA and contact terminal interface
MAC-399IF-E	M-Series Inverter Units	M-NET control adapter for Mr. Slim MSY and MSZ models
MAC-821SC-E	M-Series Inverter Units	Centralized on/off remote controller for up to 8 units (Requires MAC-397IF-E: 1 per unit)
PAC-725AD	P-Series	Connector for CN51/ multiple remote controller adapter and duct fan controller
PAC-715AD	P-Series	Connector for CN32 (For remote on/off)
PAC-SE41TS-E	P-Series A-Control Systems	Remote temperature sensor for indoor units
PAC-SF40RM-E	P-Series A-Control Systems	Remote operation adapter: display and on/off
PAC-SF80MA-E	P-Series	M-NET control adapter for Mr. Slim PUY and PUZ Models
PAC-SK52ST	P-Series	Control / service tool
PAR-21MAA-G	Use for wired M-Series Controller	Deluxe MA remote controller (Requires MAC-397IF-E)
PAR-SL99B-E	P-Series	Wireless remote controller kit for PCA suspended units
PAR-SW96U-E	P-Series	Wireless remote controller kit for PLA cassette units
PZ-41SLB-E	P-Series Remote Controller	Lossnay ERV remote controller For LGH ERV control
<b>Low Ambient</b>		
WB-PA1	P-Series	Wind baffle (1 piece) PUY/Z A12/A18
WB-PA2	P-Series	Wind baffle (1 piece) PUY/Z A24/A30/A36/A42 (42 installation requires 2 pieces)
ICM-326HM-1	M-Series Non-Inverter units	Low ambient head pressure controller
<b>Filters</b>		
MAC-2300FT	M-Series Indoor Unit - A24	Anti-allergy enzyme filter
MAC-415FT-E	M-Series Indoor Unit - A09/A12/A15/A17	Anti-allergy enzyme filter
PAC-SE81KF-E	PCA Indoor Units	High-efficiency filter element
PAC-SG01KF-E	All PLA Models	High-efficiency filter element (Requires PAC-SG03TM-E multi-function casement)
<b>Pumps</b>		
SI1730-230	P-Series	Mini-condensation pump: 230V
SI3100-115	MS-Series	Mini-condensation pump: 115V
SI3100-230	MSY/Z-Series	Mini-condensation pump: 230V
<b>Miscellaneous</b>		
CWMB1	MU and PU outdoor units	Condensing unit wall mounting brackets: painted steel
CWMBSS	MU and PU outdoor units	Condensing unit wall mounting brackets: 304 stainless steel
PAC-SG03TM-E	All PLA Models	Multi-function casement (High-efficiency filter element not included)
PAC-SG06SP-E	All PLA Models	Air outlet shutter plates (1 set = 2 pieces)
PAC-SG58SG-E	P-Series	Air outlet guide (1 piece) PUY/Z A12/A18
PAC-SG59SG-E	P-Series	Air outlet guide (1 piece) PUY/Z A24/A30/A36/A42 (42 installation requires 2 pieces)
PAC-SG61DS-E	P-Series	Drain socket
PAC-SG63DP-E	PUZ(Y)-A12/18	Drain pan
PAC-SG64DP-E	PUZ(Y)-A24/30/36/42	Drain pan
RCMKP1CB	M and P Series Wireless	Lockdown bracket for remote controller
ULTRILITE1	All M-Series and PUZ(Y)-A12/18	Condensing unit mounting pad (in.): 16" x 36" x 3"
ULTRILITE2	PUZ(Y)-A24/30/36/42	Condensing unit mounting pad (in.): 24" x 42" x 3"
<b>Port Adapters</b>		
MAC-A454JP-E	MXZ-Series	Adapter: 3/8" x 1/2"
MAC-A455JP-E	MXZ-Series	Adapter: 1/2" x 3/8"
MAC-A456JP-E	MXZ-Series	Adapter: 1/2" x 5/8"
MSDD-50SR-E	P-Series	Distribution pipe
PAC-493PI	MXZ-Series	Adapter: 1/4" x 5/8"
PAC-SC84PI-E	PKA-Series (A24/30/36/42)	L connector pipe (for left side piping)
PAC-SG76RJ-E	MXZ-Series	Adapter: 3/8" x 5/8"

Pricing and specifications are subject to change without notice. Please consult your area sales manager or Mitsubishi Electric at 678-376-2900 for pricing and availability.

GENERAL SPECIFICATIONS

REFRIGERANT LINE LENGTH FLARE/FLARE

Indoor Unit	Outdoor Unit	Length in feet	Height in feet
MSA09WA	MUA09WA	65	35
MSA12WA	MUA12WA	65	35
MSYA15NA	MUYA15NA	65	40
MSYA17NA	MUYA17NA	65	40
MSYA24NA	MUYA24NA	100	50
MSZA09NA	MUZA09NA	65	40
MSZA12NA	MUZA12NA	65	40
MSZA15NA	MUZA15NA	65	40
MSZA17NA	MUZA17NA	65	40
MSZA24NA	MUZA24NA	100	50
MSZA09NA, MSZA12NA, MSZA15NA	MXZ2A20NA	164	49*/33
MSZA09NA, MSZA12NA, MSZA15NA, MSZA17NA, MSZA24NA	MXZ3A30NA	230	33
PKAA12GA (L)	PUYA12NHA	100	100
PKAA18GA (L)	PUYA18NHA, PUZA18NHA	100	100
PKAA24FA (L)	PUYA24NHA, PUZA24NHA	165	100
PKAA30FA (L)	PUYA30NHA, PUZA30NHA	165	100
PKAA36FA (L)	PUYA36NHA, PUZA36NHA	165	100
PLAA12AA	PUYA12NHA	100	100
PLAA18AA	PUYA18NHA, PUZA18NHA	100	100
PLAA24AA	PUYA24NHA, PUZA24NHA	165	100
PLAA30AA	PUYA30NHA, PUZA30NHA	165	100
PLAA36AA	PUYA36NHA, PUZA36NHA	165	100
PLAA42AA	PUYA42NHA, PUZA42NHA	165	100
PCAA24GA	PUYA24NHA, PUZA24NHA	165	100
PCAA30GA	PUYA30NHA, PUZA30NHA	165	100
PCAA36GA	PUYA36NHA, PUZA36NHA	165	100
PCAA42GA	PUYA42NHA, PUZA42NHA	165	100

\*49' applies to installations with outdoor unit installed above indoor unit.

REFRIGERANT TUBING SETS

Lineset Model Number	Tube Size (in)	Length Ft.	Insul.	Use With Mitsubishi Electric Models
MLS143838-5	1/4 x 3/8	5	3/8"	Mr. Slim MS-A09WA, MSZ-A09NA, MSZ-A12NA
MLS143838-6	1/4 x 3/8	6	3/8"	
MLS143838-10	1/4 x 3/8	10	3/8"	
MLS143838-15	1/4 x 3/8	15	3/8"	
MLS143838-30	1/4 x 3/8	30	3/8"	
MLS143838-50	1/4 x 3/8	50	3/8"	Mr. Slim MS-A12WA, MSY-A15NA, MSY-A17NA, MSZ-A15NA, MSZ-A17NA, PKA-A12GA(L), PKA-A18GA(L), PLA-A12AA, PLA-A18AA
MLS143838-65	1/4 x 3/8	65	3/8"	
MLS141238-15	1/4 x 1/2	15	3/8"	
MLS141238-30	1/4 x 1/2	30	3/8"	
MLS141238-50	1/4 x 1/2	50	3/8"	
MLS141238-65	1/4 x 1/2	65	3/8"	Mr. Slim MSY-A24NA, MSZ-A24NA
MLS141238-100	1/4 x 1/2	100	3/8"	
MLS145838-15	1/4 x 5/8	15	3/8"	
MLS145838-30	1/4 x 5/8	30	3/8"	
MLS145838-50	1/4 x 5/8	50	3/8"	
MLS145838-65	1/4 x 5/8	65	3/8"	Mr. Slim PKA-A24GA(L), PKA-A30GA(L), PKA-A36GA(L), PLA-A24AA, PLA-A30AA, PLA-A36AA, PLA-A42AA, PCA-A24GA, PCA-A30GA, PCA-A36GA, PCA-A42GA
MPLS385838-10	3/8 x 5/8	10	3/8"	
MPLS385838-15	3/8 x 5/8	15	3/8"	
MPLS385838-30	3/8 x 5/8	30	3/8"	
MPLS385838-50	3/8 x 5/8	50	3/8"	
MPLS385838-65	3/8 x 5/8	65	3/8"	
MPLS385838-100	3/8 x 5/8	100	3/8"	

Specifications are subject to change without notice.

LIMITED WARRANTY | Six-year warranty on compressor. One-year warranty on parts.

LINE-HIDE™ LINESET COVER SYSTEM

- Available in four sizes - 2-1/4-inch, 3-inch, 4-inch and 6-inch tubes
- Snap-on covers and a full selection of couplings, elbows, T-joints, caps, and more for any application, complex or simple
- High-quality PVC with UV inhibitors for outdoor service in all weather conditions





**Mr. SLIM®**

**Split-ductless A/C and Heat Pumps**

*Provides personalized comfort control for every room.*



Mitsubishi Electric Shizuoka Works acquired ISO 9001 certification under Series 9000 of the International Standard Organization (ISO), based on a review of quality warranties for the production of air-conditioning equipment. The plant also acquired environmental management system standard ISO 14001 certification.



Printed on recycled paper.



Mitsubishi Electric Advanced Products Division  
3400 Lawrenceville Suwanee Road  
Suwanee, GA 30024

Phone: 888-467-7546 Fax: 800-658-1458

©2007 Mitsubishi Electric & Electronics USA, Inc. Mr SLIM® is a registered trademark of Mitsubishi Electric. The three-diamond logo is a registered logo of Mitsubishi Electric Corporation.

See complete warranty for terms, conditions, and limitations. A copy is available from Mitsubishi Electric.

Form No. MBROGEN-03-07-20M

For more information visit [www.mrslim.com](http://www.mrslim.com)