

# Always there to help you

Register your product and get support at  
[www.philips.com/support](http://www.philips.com/support)



CSS5330B  
CSS5330G



# User manual

# PHILIPS



# Contents

---

<b>1</b>	<b>Important</b>	2
	Help and support	2
	Safety	2
	Care for your product	3
	Care of the environment	3
	Compliance	4

---

<b>2</b>	<b>Your product</b>	4
	Main unit	4
	Remote control	5
	Connectors	6
	Wireless subwoofer	6

---

<b>3</b>	<b>Connect and set up</b>	7
	Place speakers	7
	Pair up with the subwoofer	7
	Connect to TV	8
	Connect digital devices through HDMI	8
	Connect audio from TV and other devices	8
	Set up speakers	9

---

<b>4</b>	<b>Use your product</b>	10
	Adjust the volume	10
	Choose your sound	10
	MP3 player	11
	Play music via Bluetooth	11
	Play music via NFC	12
	Auto standby	12
	Apply factory settings	12

---

<b>5</b>	<b>Update software</b>	13
	Check software version	13
	Update software via USB	13

---

<b>6</b>	<b>Wall mount</b>	14
----------	-------------------	----

---

<b>7</b>	<b>Product specifications</b>	14
----------	-------------------------------	----

---

<b>8</b>	<b>Troubleshooting</b>	15
----------	------------------------	----

# 1 Important

Read and understand all instructions before you use your product. If damage is caused by failure to follow instructions, the warranty does not apply.

---

## Help and support

For extensive online support, visit [www.philips.com/support](http://www.philips.com/support) to:

- download the user manual and the quick start guide
- watch video tutorials (available only for selected models)
- find answers to frequently answered questions (FAQs)
- email us a question
- chat with our support representative.

Follow the instructions on the website to select your language, and then enter your product model number.

Alternatively, you can contact Consumer Care in your country. Before you contact, note down the model number and serial number of your product. You can find this information on the back or bottom of your product.

---

## Safety

### Risk of electric shock or fire!

- Before you make or change any connections, make sure that all devices are disconnected from the power outlet.
- Never expose the product and accessories to rain or water. Never place liquid containers, such as vases, near the product. If liquids are spilt on or into the product, disconnect it from the power outlet immediately. Contact Consumer Care to have the product checked before use.

- Never place the product and accessories near naked flames or other heat sources, including direct sunlight.
- Never insert objects into the ventilation slots or other openings on the product.
- Where the mains plug or an appliance coupler is used as the disconnect device, the disconnect device shall remain readily operable.
- Batteries (battery pack or batteries installed) shall not be exposed to excessive heat such as sunshine, fire or the like.
- Disconnect the product from the power outlet before lightning storms.
- When you disconnect the power cord, always pull the plug, never the cable.

### Risk of short circuit or fire!

- For identification and supply ratings, see the type plate at the back or bottom of the product.
- Before you connect the product to the power outlet, ensure that the power voltage matches the value printed on the back or bottom of the product. Never connect the product to the power outlet if the voltage is different.

### Risk of injury or damage to this product!

- For wall-mountable products, use only the supplied wall mount bracket. Secure the wall mount to a wall that can support the combined weight of the product and the wall mount. Gibson Innovations bears no responsibility for improper wall mounting that results in accident, injury or damage.
- Never place the product or any objects on power cords or on other electrical equipment.
- If the product is transported in temperatures below 5°C, unpack the product and wait until its temperature matches room temperature before connecting it to the power outlet.
- Parts of this product can be made of glass. Handle with care to avoid injury and damage.

### Risk of overheating!

- Never install this product in a confined space. Always leave a space of at least four inches around the product for ventilation. Ensure curtains or other objects never cover the ventilation slots on the product.

### Risk of contamination!

- Do not mix batteries (old and new or carbon and alkaline, etc.).
- Danger of explosion if batteries are incorrectly replaced. Replace only with the same or equivalent type.
- Remove batteries if they are exhausted or if the remote control is not to be used for a long time.
- Batteries contain chemical substances, they should be disposed of properly.

### Risk of swallowing batteries!

- The product/remote control may contain a coin/button type battery, which can be swallowed. Keep the battery out of reach of children at all times! If swallowed, the battery can cause serious injury or death. Severe internal burns can occur within two hours of ingestion.
- If you suspect that a battery has been swallowed or placed inside any part of the body, seek immediate medical attention.
- When you change the batteries, always keep all new and used batteries out of reach of children. Ensure that the battery compartment is completely secure after you replace the battery.
- If the battery compartment cannot be completely secured, discontinue use of the product. Keep out of reach of children and contact the manufacturer.



This is CLASS II apparatus with double insulation, and no protective earth provided.

---

## Care for your product

Use only microfiber cloth to clean the product.

---

## Care of the environment

### Disposal of your old product and battery



Your product is designed and manufactured with high quality materials and components, which can be recycled and reused.



This symbol on a product means that the product is covered by European Directive 2012/19/EU.



This symbol means that the product contains batteries covered by European Directive 2013/56/EU which cannot be disposed of with normal household waste.

Inform yourself about the local separate collection system for electrical and electronic products and batteries. Follow local rules and never dispose of the product and batteries with normal household waste. Correct disposal of old products and batteries helps prevent negative consequences for the environment and human health.

### Removing the disposable batteries

To remove the disposable batteries, see battery installation section.

# CE 0560

This product complies with the radio interference requirements of the European Community.

Hereby, Gibson Innovations declares that this product is in compliance with the essential requirements and other relevant provisions of Directive 1999/5/EC. You can find the Declaration of Conformity on [www.p4c.philips.com](http://www.p4c.philips.com).

## 2 Your product

Congratulations on your purchase, and welcome to Philips! To fully benefit from the support that Philips offers, register your product at [www.philips.com/welcome](http://www.philips.com/welcome).

---

### Main unit

This section includes an overview of the main unit.

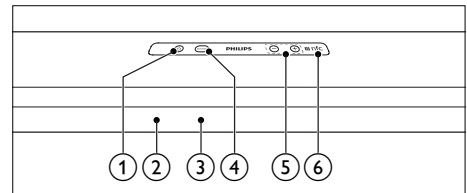

- ① **⏻**  
Switch this product on or to standby.
- ② **Display panel**
- ③ **Standby indicator**  
When this product is in standby, the standby indicator turns red.
- ④ **SOURCE**  
Select an input source for this product.
- ⑤ **Volume +/-**  
Increase or decrease volume.
- ⑥ **NFC tag**  
Tap the NFC-enabled device on the tag for Bluetooth connection.

# Remote control

This section includes an overview of the remote control.

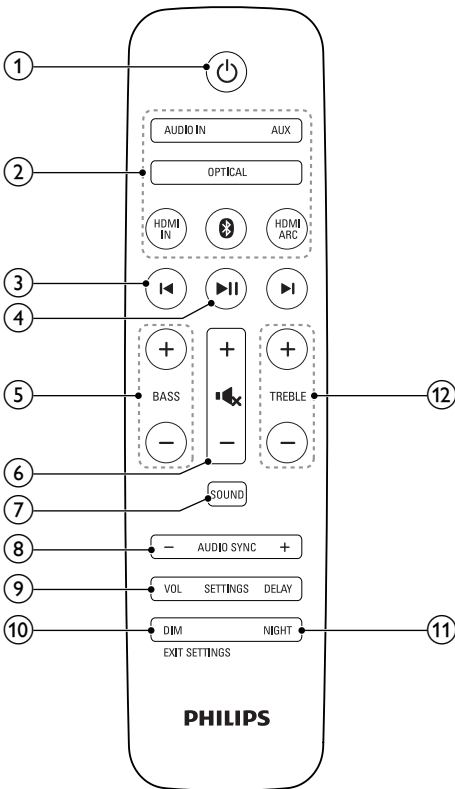

## 1 (Standby-On)

- Switch the main unit on or to standby.

## 2 Source buttons

**AUDIO IN:** Switch your audio source to the connection of an external device with 3.5mm jack (such as MP3).

**AUX:** Switch your audio source to the connection of an external device with red/white audio jacks.

**OPTICAL:** Switch your audio source to the optical connection.

**HDMI IN:** Switch your source to the HDMI IN connection.

**:** Switch to Bluetooth mode; Press and hold three seconds to break the current Bluetooth connection.

**HDMI ARC:** Switch your source to HDMI ARC connection.

## 3 /

Skip to the previous or next track in Bluetooth mode (only for AVRCP-supported Bluetooth devices).

## 4

Start, pause or resume play in Bluetooth mode (only for AVRCP-supported Bluetooth devices).

## 5 BASS +/-

Increase or decrease bass.

## 6 Volume control

- +/-: Increase or decrease volume.
- : Mute or restore volume.

## 7 SOUND

Select a sound mode.

## 8 AUDIO SYNC +/-

Increase or decrease audio delay.

## 9 Speaker setup buttons

**VOL:** Enter volume setup mode for the speakers.

**DELAY:** Enter distance setup mode for the speakers.

## 10 DIM / EXIT SETTINGS

- Set the brightness of the display panel for this product.
- Exit speaker setup mode.

## 11 NIGHT

Turn night mode on or off.

## 12 TREBLE +/-

Increase or decrease treble.

---

## Connectors

This section includes an overview of the connectors available on this product.

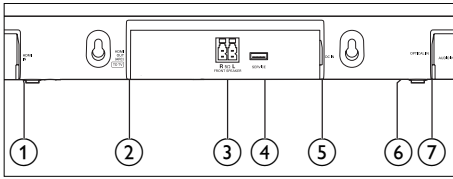

- ① **HDMI IN**  
Connect to the HDMI output on a digital device.
- ② **TO TV - HDMI OUT (ARC)**  
Connect to the HDMI (ARC) input on the TV.
- ③ **FRONT SPEAKER L/R**  
Connect to the front speakers.
- ④ **SERVICE**  
Connect a USB flash drive to upgrade software of this product (not for media play).
- ⑤ **DC IN**  
Connect to the power supply.
- ⑥ **OPTICAL IN**  
Connect to an optical audio output on the TV or a digital device.
- ⑦ **AUDIO IN**  
Audio input from an external device with 3.5 mm jack (such as MP3 player), or with red/white audio jacks.

---

## Wireless subwoofer

This product comes with a wireless subwoofer.

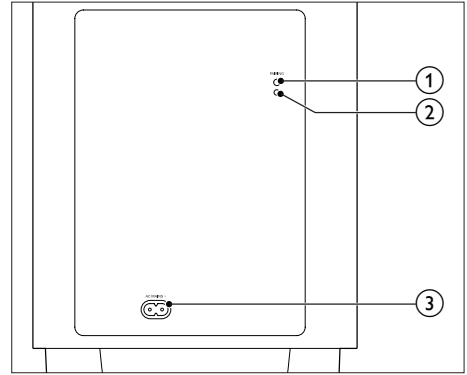

- ① **PAIRING (pairing)**  
Press to enter the pairing mode for the subwoofer.
- ② **Subwoofer indicator**
  - When the power is turned on, the indicator lights up.
  - During wireless pairing between the subwoofer and the main unit, the indicator blinks white quickly.
  - When the pairing succeeds, the indicator lights up white.
  - When the pairing fails, the indicator blinks white slowly.
  - When wireless connection is disconnected for 1 minute, the indicator turns off.
- ③ **AC MAINS~**  
Connect to the power supply.



# 3 Connect and set up

This section helps you connect this product to a TV and other devices, and then set it up. For information about the basic connections of this product and accessories, see the quick start guide.

**Note**

- For identification and supply ratings, see the type plate at the back or bottom of the product.
- Before you make or change any connections, make sure that all devices are disconnected from the power outlet.

## Place speakers

Speaker position plays a critical role in setting up a surround sound effect. For best effect, position all the speakers towards the seating position and place them close to your ear level (seated).

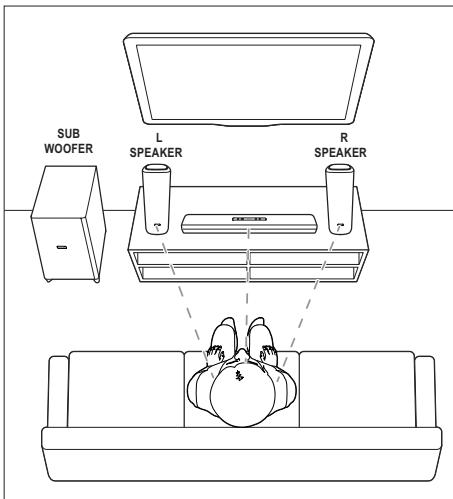

**Note**

- Surround sound depends on factors such as room shape and size, type of wall and ceiling, windows and reflective surfaces, and speaker acoustics. Experiment with the speaker positions to find the optimum setting for you.

Follow these general guidelines for speakers placement.

- 1 Seating position:**  
This is the center of your listening area.
- 2 Main unit (function as center speaker):**  
Place the main unit directly in front of the seating position, either above or below your TV.
- 3 FRONT SPEAKER L (front left) and FRONT SPEAKER R (front right) speakers:**  
Place the left and right speakers in the front, and at equal distance from the main unit. Make sure that the left, right, and the main unit are at equal distance from your seating position.
- 4 SUBWOOFER (subwoofer):**  
Place the subwoofer at least one meter to the left or right of the TV. Leave about 10-centimeter clearance from the wall.

## Pair up with the subwoofer

The wireless subwoofer automatically pair up with the main unit for wireless connection when you turn on the main unit, and the subwoofer:  
If no audio from the wireless subwoofer can be heard, do the following for pairing.

- 1 Turn on the main unit, and the subwoofer.**  
↳ If the connection to the main unit is lost, the white LED on the subwoofer blinks slowly.
- 2 Press the PAIRING (PAIRING) button on the subwoofer to enter the pairing mode.**  
↳ The white LED on the subwoofer blinks quickly.

- 3 In **OPTICAL** mode (press **OPTICAL**) , within six seconds, on the remote control, press **⏮** twice then **Volume +** once, and then hold down **BASS +**.

- ↳ If the pairing succeeds, the white LED on the subwoofer lights up.
- ↳ If the pairing fails, the white LED on the subwoofer blinks slowly.

- 4 If the pairing fails, repeat the steps above.

---

## Connect to TV

Connect this product to a TV. You can listen to audio from TV programs through the speakers of this product.

---

### Connect to TV through HDMI (ARC)

#### Best quality audio

This product supports HDMI with Audio Return Channel (ARC). If your TV is HDMI ARC compliant, you can hear the TV audio through the speakers of this product by using a single HDMI cable.

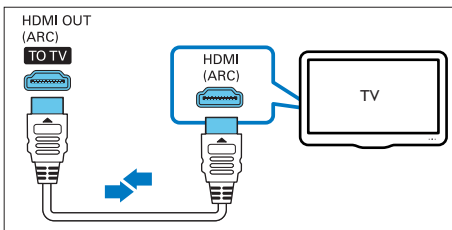

- 1 Using a High Speed HDMI cable, connect the **HDMI OUT (ARC)** connector on this product to the **HDMI ARC** connector on the TV.
  - The **HDMI ARC** connector on the TV might be labeled differently. For details, see the TV user manual.
- 2 On your TV, turn on HDMI-CEC operations. For details, see the TV user manual.

---

### Note

- If your TV is not HDMI ARC compliant, connect an audio cable to hear the TV audio through this product.
- If your TV has a DVI connector, you can use an HDMI/DVI adapter to connect to TV. However, some of the features may not be available.

---

## Connect digital devices through HDMI

Connect a digital device such as a set-top box, DVD/Blu-ray player, or games console to this product through a single HDMI connection. When you connect the devices in this way and play a file or game, the

- video is automatically displayed on your TV, and
- audio is automatically played on this product.

- 1 Using a High Speed HDMI cable, connect the **HDMI OUT** connector on your digital device to the **HDMI IN** on this product.
- 2 Connect this product to TV through **HDMI OUT (ARC)**.
  - If the TV is not HDMI CEC compliant, select the correct video input on your TV.
- 3 On the connected device, turn on HDMI-CEC operations. For details, see the user manual of the device.

---

## Connect audio from TV and other devices

Play audio from TV or other devices through the speakers of this product.

Use the best quality connection available on this product, TV, and other devices.

## Note

- When this product and TV are connected through **HDMI ARC**, an audio connection is not required.

## Option 1: Connect audio through a digital optical cable

Best quality audio

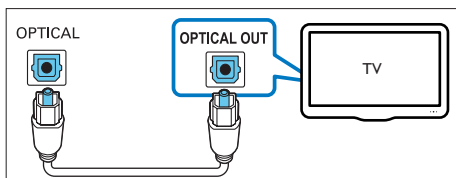

- Using an optical cable, connect the **OPTICAL IN** connector on this product to the **OPTICAL OUT** connector on the TV or other device.
  - The digital optical connector might be labeled **SPDIF** or **SPDIF OUT**.

## Option 2: Connect audio through analog audio cables

Basic quality audio

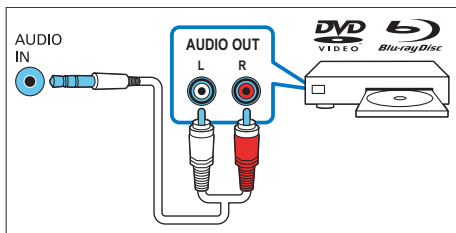

- Using an analog cable, connect the **AUDIO IN** (3.5mm jack) on this product to the **AUDIO OUT** connectors (red and white) on the TV or other device.
- Press **AUX** on the remote control to switch to AUX mode.

## Set up speakers

Set up the speakers manually to experience customized surround sound.

### Before you start

Make the necessary connections described in the quick start guide.

## Set up speaker distance

Wireless connection causes audio delay latency. Set up the speaker distance to synchronize audio output among the front speakers and subwoofer.

- Press **DELAY** to enter setup mode.
  - The display panel scrolls **DELAY ADJ** (delay adjustment).
    - To exit setup mode, press **EXIT SETTINGS**, or 3 seconds of button inactivity occurs.
- Press **DELAY** again to select a speaker for distance adjustment.
- Press **Volume +/-** to adjust distance for the selected speaker.
  - To exit setup mode without save, press **EXIT SETTINGS**, or 3 seconds of button inactivity occurs.
- Repeat step 2 and 3 to set up the distance for other speakers.
- After the setup is complete, press **EXIT SETTINGS** to exit.
  - The value is saved and applied.

## Set up speaker volume

Set up the speaker volume for optimal surround sound.

- Press **VOL** to enter setup mode.
  - The display panel scrolls **SPKR VOL** (speaker volume).
    - To exit setup mode, press **EXIT SETTINGS**, or 3 seconds of button inactivity occurs.

- 2 Press **VOL** again to play test tone from the speakers.
- 3 Then press **VOL** to select a speaker for volume adjustment.
- 4 Press **Volume +/-** to adjust volume for the selected speaker:
  - To exit setup mode without save, press **EXIT SETTINGS**, or 3 seconds of button inactivity occurs.
- 5 Repeat step 3 and 4 to set up the volume for other speakers.
- 6 After the setup is complete, press **EXIT SETTINGS** to exit.  
↳ The value is saved and applied.

## 4 Use your product

This section helps you use this product to play audio from connected devices.

### Before you start

- Make the necessary connections described in the quick start guide and the user manual.
- Switch this product to the correct source for other devices.

---

## Adjust the volume

- 1 Press **Volume +/-** to increase or decrease a volume level.
  - To mute sound, press **MUTE**.
  - To restore the sound, press **MUTE** again or press **Volume +/-**.

---

## Choose your sound

This section helps you choose the ideal sound for your video or music.

---

### Sound mode

Select predefined sound modes to suit your video or music.

- 1 Press **SOUND** to select a sound option from the display panel.
  - **AUTO**: Automatically select a sound setting based on the sound stream.
  - **STEREO**: Create stereo sound.
  - **VSURR**: Create virtual surround effect.
  - **3CH**: Create 3.1 channel surround.

---

## Equalizer

Change the high frequency (treble) and low frequency (bass) settings of this product.

- 1 Press **TREBLE +/-** or **BASS +/-** to change the frequency.

---

## Synchronize video and sound

If the audio and video are not synchronized, delay the audio to match the video.

- 1 Press **AUDIO SYNC +/-** to synchronize the audio with the video.

---

## Night mode

For quiet listening, night mode decreases the volume of loud sounds when audio is played. Night mode is only available for Dolby Digital soundtracks.

- 1 Press **NIGHT** to turn night mode on or off.
  - When night mode is turned on, **ON NIGHT** (night on) scrolls once on the display panel.
  - When night mode is turned off, **OFF NIGHT** (night off) scrolls once on the display panel.

---

## MP3 player

Connect your MP3 player to play your audio files or music.

### What you need

- An MP3 player.
- A 3.5mm stereo audio cable.

- 1 Using the 3.5mm stereo audio cable, connect the MP3 player to the **AUDIO IN** connector on this product.
- 2 Press **AUDIO IN**.

- 3 Press the buttons on the MP3 player to select and play audio files or music.
  - On the MP3 player, it is recommended to set the volume in the range of 80% maximum volume.

---

## Play music via Bluetooth

Through Bluetooth, connect your product with a Bluetooth device (such as an iPad, iPhone, iPod touch, Android phone, or laptop), and then you can listen to the audio files stored on the device through the speakers of this product.

### What you need

- A Bluetooth device which supports Bluetooth profile A2DP, and with Bluetooth version as 4.1.
- The operational range between the main unit and a Bluetooth device is approximately 10 meters (30 feet).

- 1 Press **0** on the remote control to switch this product to Bluetooth mode.
  - ↳ **BT** is displayed on the display panel, blinking.
- 2 On the Bluetooth device, switch on Bluetooth, search for and select **Philips CSS5330** to start connection (see the user manual of the Bluetooth device on how to enable Bluetooth).
  - For first time connection, on some mobile devices prompt for pair-up appears, select "YES" for connection.
  - ↳ During connection, **BT** on the display panel blinks.
- 3 Wait until this product beeps.
  - ↳ When the Bluetooth connection succeeds, **BT** is displayed on the display panel.
  - ↳ If the connection fails, **BT** on the display panel blinks continuously.

- 4 Select and play audio files or music on your Bluetooth device.
  - During play, if a call is coming, music play is paused.
  - If your Bluetooth device supports AVRCP profile, on the remote control you can press **◀/▶** to skip to a track, or press **⏸** to pause/resume play.
- 5 To exit Bluetooth, select other source.
  - When your switch back to Bluetooth mode, Bluetooth connection remains active.

#### Note

- The music streaming may be interrupted by obstacles between the device and this product, such as wall, metallic casing that covers the device, or other devices nearby that operate in the same frequency.
- If you want to connect this product with another Bluetooth device, press and hold **Ⓜ** on the remote control to break the current Bluetooth connection.

---

## Play music via NFC

NFC (Near Field Communication) is a technology that enables short-range wireless communication between NFC-enabled devices, such as mobile phones.

### What you need

- A Bluetooth device with NFC function.
- For pairing, tap the NFC device on the **NFC** tag of this product.

- 1 Enable NFC on the Bluetooth device (see the device' s user manual for details).
- 2 Tap the NFC device onto the **NFC** tag of this product until this product beeps.
  - For first time connection, on some mobile devices prompt for pair-up appears, select "YES" for connection.

↳ When the Bluetooth connection succeeds, **BT** is displayed on the display panel.

↳ If the connection fails, **BT** on the display panel blinks continuously.

- 3 Select and play audio files or music on your NFC device.
  - To break the connection, tap again the NFC device onto the **NFC** tag on this product.

---

## Auto standby

When playing media from a connected device, this product automatically switches to standby after 15 minutes of button inactivity and no audio/video play from a connected device.

---

## Apply factory settings

You can reset this product to the default settings programmed at the factory.

- 1 In AUX mode, on the remote control press **Volume -**, **BASS -**, and **TREBLE -** in sequence within three seconds.

↳ When the factory settings restore is complete, the product automatically switches off and restarts.

# 5 Update software

To get the best features and support, update your product with the latest software.

---

## Check software version

In HDMI ARC source, on the remote control press **TREBLE -**, **BASS -**, and **Volume -** in sequence within three seconds.

↳ The software version number is displayed on the display panel.

---

## Update software via USB



### Caution

- Do not turn off the power or remove the USB flash drive when the software update is in progress because you might damage this product.

- 1 Check the latest software version on [www.philips.com/support](http://www.philips.com/support).
  - Search for your model and click on "Software and drivers".
- 2 Download the software into a USB flash drive.
  - ① **Unzip the download if zipped, and make sure that the unzipped file contains two files: "CSS5330.bin" and "RPT5330.bin".**
  - ② **Put the two files ("CSS5330.bin" and "RPT5330.bin") in the root directory of the USB flash drive.**
- 3 Connect the USB flash drive to the **SERVICE** connector on this product.
- 4 Switch this product to HDMI ARC source (press **HDMI ARC**).

- 5 On the remote control, within 6 seconds press **MUTE** twice then **Volume +** once, and then hold down **SOUND** until upgrade information appears on the TV screen.
  - ↳ Then "UPG" (upgrade) is displayed on the display panel.
  - ↳ If a USB flash drive is not connected or invalid upgrade file is found, "ERROR" (error) is displayed on the display panel.
- 6 Wait until the upgrade is completed.
  - ↳ If the upgrade is complete, this product automatically turns off and on again.



### Note

- The upgrade time may take around 3 minutes.

## 6 Wall mount

Before you mount this product on the wall, read all safety precautions.

### Note

- Improper wall mounting may result in accident, injury or damage. If you have any query, contact Consumer Care in your country.
- Secure the wall mount to a wall that can support the combined weight of the product and the wall mount.

### Screw length/diameter

Depending on the type of wall supporting this product, make sure that you use screws of a suitable length and diameter:

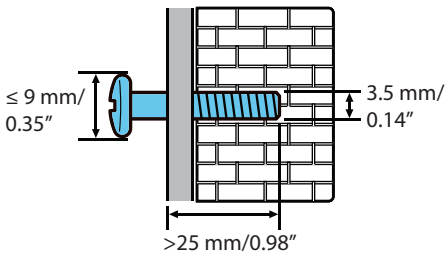

See the illustration in the quick start guide on how to wall mount this product.

### Mount the front speakers (optional)

- 1) Mark two holes on the wall using a supplied wall bracket, then secure two suitable screws on the wall as indicated by two holes.
- 2) Fix a supplied wall bracket onto a speaker.
- 3) Hang the speaker on the screws which are secured on the wall.

## 7 Product specifications

### Note

- Specifications and design are subject to change without notice.

### Amplifier

- Total output power: 340W RMS (+/- 0.5 dB, 10% THD)
- Frequency response: 20 Hz-20 kHz /  $\pm 3$  dB
- Signal-to-noise ratio:  $> 65$  dB (CCIR) / (A-weighted)
- Input sensitivity:
  - AUX: 500 mV
  - AUDIO IN: 200 mV

### Audio

- S/PDIF Digital audio input:
  - Optical: TOSLINK

### Bluetooth

- Bluetooth profiles: A2DP
- Bluetooth version: 4.1

### Main unit

- Power supply:
  - Model (Philips branded AC power adapter): DYS602-210309W; AS650-210-AA309
  - Input: 100-240V~, 50/60 Hz 1.5 A
  - Output: 21V  $\overline{\text{---}}$ , 3.09A
- Standby power consumption:  $\leq 0.5$  W
- Dimensions (W x H x D): 580 x 51.5 x 98 mm
- Weight: 1.2 kg



- **Built-in speakers**
  - 2 x midrange (90mm/3.5" x 34mm/1.3", 8 ohm)
  - 1 x tweeter (25.4mm/1", 8 ohm)

---

## Front speakers

- Speaker drivers:
  - 2 x midrange (63.5 mm/2.5", 10 ohm)
  - 1 x tweeter (25.4 mm/1", 8 ohm)
- Dimensions (W x H x D): 110 x 301 x 110 mm
- Weight: 1.2 kg/each
- Cable length: 3 m/each

---

## Subwoofer

- Power supply: 220-240 V~, 50-60 Hz
- Power consumption: 60 W
- Standby power consumption: ≤ 0.5 W
- Impedance: 3 ohm
- Speaker drivers: 1 x 165 mm (6.5") woofer
- Dimensions (W x H x D): 228 x 406 x 265 mm
- Weight: 5.7 kg

---

## Remote control batteries

- 1 x AAA-R03-1.5 V

---

## Standby power management

- When the product remains inactive for 15 minutes, it automatically switches to standby or networked standby.
- The power consumption in standby or networked standby is less than 0.5W.
- To deactivate Bluetooth connection, press and hold the Bluetooth button on the remote control.
- To activate Bluetooth connection, enable Bluetooth connection on your Bluetooth device, or enable Bluetooth connection via the NFC tag (if available).

# 8 Troubleshooting



## Warning

- Risk of electric shock. Never remove the casing of the product.

To keep the warranty valid, never try to repair the product yourself.

If you have problems using this product, check the following points before you request service. If you still have a problem, get support at [www.philips.com/support](http://www.philips.com/support).

---

## Main unit

**The buttons on this product do not work.**

- Disconnect this product from the power supply for a few minutes, then reconnect.

---

## Sound

**No sound from the speakers of this product.**

- Connect the audio cable from this product to your TV or other devices. However, you do not need a separate audio connection when:
  - the product and TV are connected through **HDMI ARC** connection, or
  - a device is connected to the **HDMI IN** connector on this product.
- Reset this product to its factory settings.
- On the remote control, select the correct audio input.
- Make sure that this product is not muted.

**No sound from the wireless subwoofer.**

- Wirelessly connect the subwoofer to the main unit.

**Distorted sound or echo.**

- If you play audio from the TV through this product, make sure that the TV is muted.

**Audio and video are not synchronized.**

- Press **AUDIO SYNC +/-** to synchronize the audio with the video.

---

## Bluetooth

### **A device cannot connect with this product.**

- The device does not support the compatible profiles required for this product.
- You have not enabled the Bluetooth function of the device. See the user manual of the device on how to enable the function.
- The device is not correctly connected. Connect the device correctly (see 'Play music via Bluetooth' on page 11).
- This product is already connected with another Bluetooth device. Disconnect the connected device, then try again.

### **Quality of audio play from a connected Bluetooth device is poor.**

- The Bluetooth reception is poor. Move the device closer to this product, or remove any obstacle between the device and this product.

### **The connected Bluetooth device connects and disconnects constantly.**

- The Bluetooth reception is poor. Move the device closer to this product, or remove any obstacle between the device and this product.
- Turn off Wi-Fi function on the Bluetooth device to avoid interference.
- For some Bluetooth, the Bluetooth connection can be deactivated automatically to save power. This does not indicate any malfunction of this product.

---

## NFC

### **A device cannot connect with this product via NFC.**

- Make sure that the device is supported by NFC.
- Make sure that NFC is enabled on the device (see the device's user manual for details).
- For pairing, tap the NFC device on the **NFC** tag of this product.



Manufactured under license from Dolby Laboratories. Dolby, Pro Logic, and the double-D symbol are trademarks of Dolby Laboratories.



The terms HDMI and HDMI High-Definition Multimedia Interface, and the HDMI Logo are trademarks or registered trademarks of HDMI Licensing LLC in the United States and other countries.



The Bluetooth® word mark and logos are registered trademarks owned by Bluetooth SIG, Inc. and any use of such marks by Gibson is under license. Other trademarks and trade names are those of their respective owners.



The N Mark is a trademark or registered trademark of NFC Forum, Inc. in the United States and in other countries.



Specifications are subject to change without notice

2015 © Gibson Innovations Limited. All rights reserved.

This product has been manufactured by, and is sold under the responsibility of Gibson Innovations Ltd., and Gibson Innovations Ltd. is the warrantor in relation to this product.

Philips and the Philips Shield Emblem are registered trademarks of Koninklijke Philips N.V. and are used under license from Koninklijke Philips N.V.

CSS5330B/CSS5330G\_12\_UM\_V1.0

