

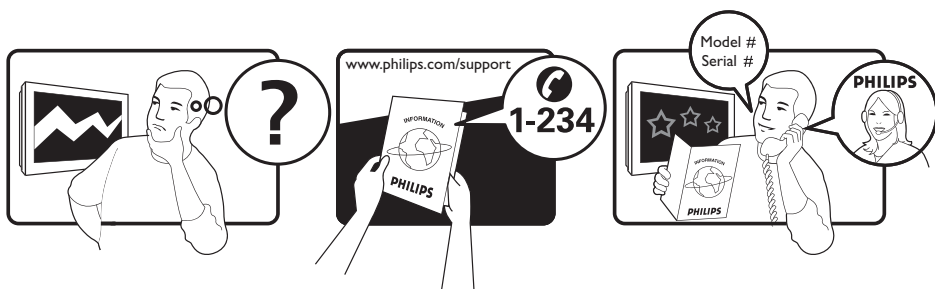

www.philips.com/support

EN USER MANUAL

PHILIPS



Country	Number	Tariff
Austria	0820 901114	€0.20/min
Belgium	070 222 303	€0.17/min
Czech Rep	800142840	free
Denmark	3525 8759	local
Finland	09 2311 3415	local
France	08 9165 0005	€0.23/min
Germany	0180 5 356 767	€0.12/min
Greece	0 0800 3122 1280	free
Hungary	0680018189	free
Ireland	01 601 1777	local
Italy	199 404 041	€0.25/min
Luxemburg	40 6661 5644	local
Netherlands	0900 8407	€0.20/min
Norway	2270 8111	local
Poland	0223491504	local
Portugal	2 1359 1442	local
Slovakia	0800004537	free
Spain	902 888 784	€0.15/min
Sweden	08 5792 9100	local
Switzerland	0844 800 544	local
UK	0906 1010 016	£0.15/min



Recycling

The packaging of this product is intended to be recycled. Apply to the local authorities for correct disposal.



Disposal of your old product

Your product is designed and manufactured with highly quality material and components, which can be recycled and reused. When this crossed-out wheeled bin symbol is attached to a product, it means the product is covered by the European Directive 2002/96/EC.

Please inform yourself about the local separate collection system for electrical and electronic products. Please act according to your local rules and do not dispose your old products with your normal household waste. The correct disposal of your old product will help prevent potential negative consequences for the environment and human health.

Disposal of batteries

The batteries supplied do not contain the heavy metals mercury and cadmium. Please check on how to dispose exhausted batteries according to local regulations.

Product information

- The Model and Serial number can be found at the rear and the left hand underside of your television set and on the packaging.

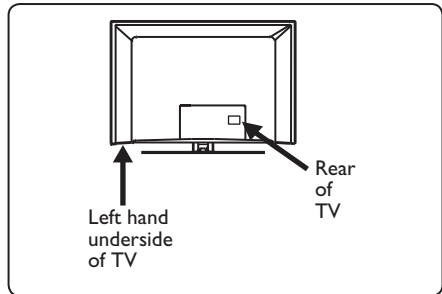

- Standby Power Consumption for this set is less than 1 W.
- Power Consumption of the set can found on the type plate at the rear of the TV.
- For more specifications of the product see the product leaflet on www.philips.com/support.

Note

Specifications and information are subject to change without notice.

- If you need further assistance, please call the customer support service in your country. The corresponding telephone numbers and addresses are given in the supplied Worldwide guarantee booklet.

Important

- AC3 (an audio format) is not supported for this set. Use the  key on the remote control to select an alternative audio.
- Some TV antennas require power from the TV set. This set does not support such a feature.

Table of contents

1	Introduction.....	3	9	Services lists	
1.1	Important Information.....	3	9.1	Rearrange services.....	15
1.1.1	Stationary images on the TV screen	3	9.2	View new TV channels or Listen to new Radio stations.....	15
1.1.2	Electric, Magnetic and electromagnetic Fields (“EMF”).....	3	10	Service setup.....	16
1.2	What is digital TV?.....	4	10.1	Add new services.....	16
1.3	Digital or Analogue channels?.....	4	10.2	Reinstall all services.....	16
2	Safety.....	5	10.3	Manual install services.....	17
2.1	General.....	5	11	Test reception.....	18
2.2	Care of the screen.....	5	12	Preferences.....	19
3	Overview of the television keys and connectors.....	6	13	Access restrictions.....	20
3.1	Side controls.	6	14	Setting up your favourite list...21	
3.2	Rear connectors.....	6	15	Information.....	22
3.3	Side connectors.....	6	16	Using the Options menu.....	23
4	Getting started.....	7	17	TV Guide (Electronic24	
4.1	Before you start.....	7	18	Recording function.....	25
4.2	Connect the antenna.....	7	19	Digital teletext (MHEG).....	27
4.3	Connect the mains.....	7	20	Using the Conditional Access Module (CAM28	
4.4	Switching on the TV.....	7	21	Automatic tuning of analogue programmes.....	29
4.5	Using the remote control.	7	22	Manual tuning of analogue programmes.....	30
5	Remote control functions.....	8	23	Programme sort.....	31
6	Overview of Digital main menu and sub-menus.....	10	24	Naming of channel.....	32
7	Switching on the TV for the first time.....	13	25	Selecting your favourite programme33	
8	Understanding the information on the banner.....	14			
8.1	Banner description.....	14			
8.2	Symbols description.....	14			

26	Features	
26.1	Timer.....	34
26.2	Parental control.....	35
26.3	Child lock.....	36
26.4	Active control.....	36
27	Picture and Sound settings.....	37
28	Smart Picture and Sound.....	38
29	Screen formats.....	39
30	Teletext.....	40
31	Using the TV as PC monitor	
31.1	Connecting the PC.....	42
31.2	Control TV settings while a PC is connected	42
32	Using the TV in HD (High Definition) mode	
32.1	Connecting the HD equipment.....	43
32.2	Control TV settings while in HD mode.....	43
33	Connecting other equipment	
33.1	Overview of connections.....	45
33.2	Connect VCR and DVD recorder...46	
33.3	Connect Decoder and VCR.....	46
33.4	Connect 2 VCRs or VCR and DVD.... recorder.....	47
33.5	Connect a satellite receiver.....	47
33.6	Connect a DVD player, Cable box or Game console.....	48
33.7	Connect a DVD player, a Satellite receiver or Cable box	48
33.8	Connect a PC.....	49
33.9	Connect a Camera, Camcorder or Game console.....	50
33.9.1	Connect a Headphone.....	50
34	Troubleshooting.....	51
35	Glossary.....	53

1 Introduction

Thank you for purchasing this television set. This manual contains all information you will need to initially install and operate your new TV.



If this instruction manual does not give an answer to your problem or if Troubleshooting page does not solve your TV problem, you can call your Local Philips Customer or Service Centre. See the supplied Worldwide guarantee booklet for details. Please have the Model and Product number (which you can find at the back or the bottom of your television set or on the packaging) ready, before calling the Philips customer support service.

1.1 Important information

1.1.1 Stationary images on the TV screen

A characteristic of LCD and Plasma Panels is that displaying the same image for a long time can cause a permanent after-image to remain on the screen. This is called phosphor burn in. Normal use of the TV should involve the showing of pictures that contain constantly moving and changing images that fill the screen.

Examples of stationary images (this is not an all inclusive list, you may encounter others in your viewing).

- TV and DVD menus: listings of DVD disk content.
- Black bars: when black bars appear at the left and right side of the screen, it is recommended to change to a picture format so that the picture fills the entire screen;
- TV channel logo: present a problem if they are bright and stationary. Moving or low-contrast graphics are less likely to cause uneven aging of the screen;
- Stock market stickers: presented at the bottom of the TV screen;
- Shopping channel logos and pricing displays: bright and shown constantly or repeatedly in the same location on the TV screen.
- Examples of still pictures also include logos, computer images, time display, teletext and images displayed in 4:3 mode, static images or characters, etc.



Tip:

Reduce contrast and brightness when viewing.

1.1.2 Electric, Magnetic and Electromagnetic Fields (“EMF”)

- Philips Royal manufactures and sells many products targeted at consumers, which, like any electronic apparatus, in general have the ability to emit and receive electro magnetic signals.
- One of Philips’ leading Business Principles is to take all necessary health and safety measures for our products, to comply with all applicable legal requirements and to stay well within the EMF standards applicable at the time of producing the products.
- Philips is committed to develop, produce and market products that cause no adverse health effects.
- Philips confirms that if its products are handled properly for their intended use, they are safe to use according to scientific evidence available today.
- Philips plays an active role in the development of international EMF and safety standards, enabling Philips to anticipate further developments in standardisation for early integration in its products.

1.2 What is digital TV?

Digital Television offers a far wider choice of TV viewing, free from the interference that you may experience on analogue TV. It promises to transform television viewing into a whole new experience. There is a greater selection of widescreen programming. Many of your favourite programmes are in widescreen on the digital channels - something the analogue TV cannot do properly.



There is new whole experience of interactivity on digital TV. By using your remote control, you can access all kinds of information like the digital text which is much clearer than the old teletext system. It gives you the added enjoyment of related information running alongside the programme you are watching. You can also access an Electronic Programme Guide that provides you with a quick and easy way to view a complete list of digital programmes as you would in a newspaper or TV magazine.

⊖ Note

- Chapters 6 to 20 contain all the information you need to operate your TV in the Digital mode. Chapters 21 to 30 contain all the information and instructions you need to operate your TV in the Analogue mode.

1.3 Digital or Analogue channels?

When the television is powered on for the first time, it will always be in **Digital** mode.

Use the  key of the remote control to switch the TV between analogue and digital mode. Use the **P + / -** or  to  keys to select channels.

2 Safety

⚠ Warning: The connections do not have to be made before hanging but the cables must be inserted into connectors of the TV.

2.1 General

- 1 Place or hang the TV wherever you want but make sure that air can circulate freely through the ventilation slots.
- 2 Do not install the TV in a confined space such as a book case or a similar unit.
- 3 To prevent any unsafe situations, no naked flame sources such as lighted candles should be placed in the vicinity of the TV set.
- 4 Avoid heat, direct sunlight and exposure to rain or water.

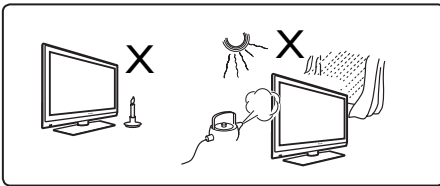

- 5 As a safety precaution, do not touch any part of the TV, power lead or aerial lead during lightning storms.
- 6 Pull the power lead by the plug. Do not pull on the power lead. Do not use a poor fitting mains socket. Insert the plug fully into the mains. If it is loose, it may cause arcing and result in fire.

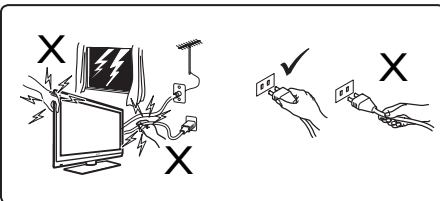

- 7 Take care not to connect too many equipment to the same mains socket as it may cause overloading resulting in fire or electric shock.
- 8 Avoid placing a vase or vases filled with water on top or near the TV. Water spilled into the set could result in electric shock. Do not operate set if water is spilled into the set. Unplug the power cord from the mains immediately and have the set checked by a qualified serviceman.
- 9 Installation of the TV set on the wall should be carried out by a qualified serviceman. Improper and incorrect installation may render the set unsafe.

2.2 Care of the screen

- 1 Do not remove the protective sheet until you have completed the stand/ wallmounting and connections. Please handle with care.

⊖ Note
Use only the soft cloth provided to clean the glossy front of the TV.

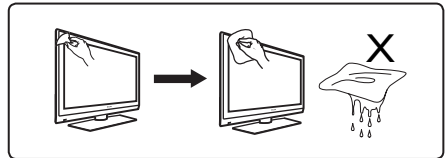

- 2 Do not use too wet a cloth which is dripping with water. Do not use acetone, toluene or alcohol to clean the TV. As a safety precaution, unplug the power cord from the mains when cleaning the set.
- 3 Do not touch, push or rub or strike the screen with anything hard as this may scratch, mar or damage the screen permanently.

3 Overview of television keys and connectors

3.1 Side controls

The Side controls are located on the left hand side of the TV.

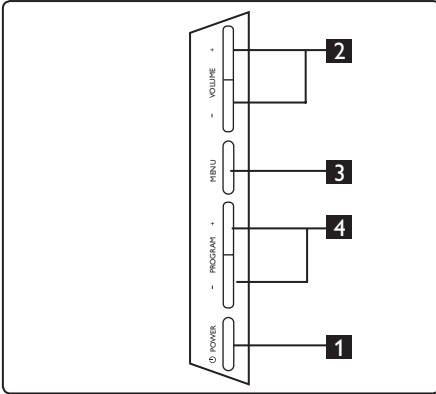

- 1 POWER** : to switch the TV on and off. **Note:** For zero power consumption, you need to remove the mains cord from the mains socket.
- 2 VOLUME** - / +: to change sound to be louder or quieter.
- 3 MENU**: to display or close menus. The PROGRAM - / + keys can be used to select a menu item and the VOLUME - / + keys to enter into the selected menu item and make adjustments.
- 4 PROGRAM** - / +: to select programmes.

3.2 Rear connectors

These connectors are located on the rear of the TV and are downward facing.

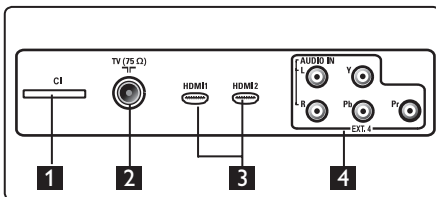

These connectors are located on the rear of the TV and are backward facing..

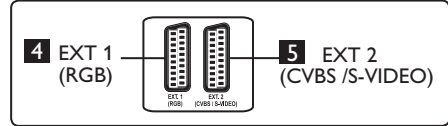

- 1 CI (Common Interface) slot:** to connect a CAM (Conditional Access Module) and a smartcard.
- 2 TV Aerial socket :** Insert the aerial plug into the 75 Ω socket.
- 3 HDMI 1 / HDMI 2:** to connect to set-top box, DVD player/recorder, High Definition equipment or Personal Computer.
- 4 EXT4:** to connect to equipment like DVD, Decoder which have the same sockets.
- 5 EXT 1 (RGB) and 6 EXT 2 (CVBS/ S-VIDEO):** connect to equipment like DVD player/recorder, VCR, Decoder which have similar connections (so called 'scart connetctions').

3.3 Side connectors

These connectors are located on the side of the TV.

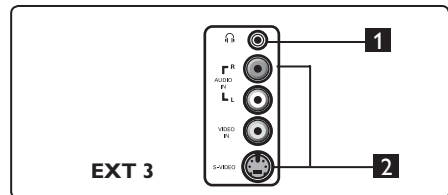

- 1 Headphone** : for your personal listening pleasure, connect the phono jack to the headphone connector of the TV.
- 2 Audio Video:** for connecting to devices like camera or camcorder.

4 Getting started

4.1 Before you start

Warning

The connections do not have to be made before hanging but the cables must be inserted into connectors of the TV.

4.2 Connect the antenna

Insert the aerial plug firmly into the 75 Ω  aerial socket at the bottom of the TV and in the wall antenna socket.

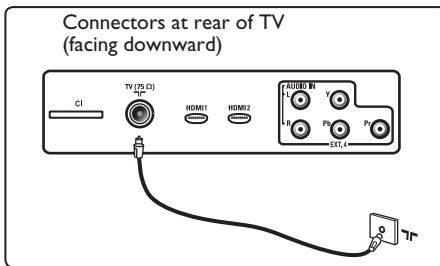

4.3 Connect the mains

Insert the mains cord (supplied) into the mains socket at the backside (downward facing) of the TV and in the wall socket.

Warning

Verify that the mains supply voltage in your home corresponds to the voltage printed on the sticker at the rear of the TV.

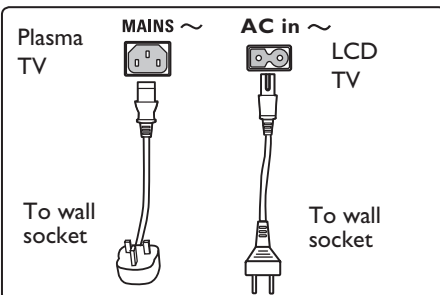

4.4 Switching on the TV

- To switch on the TV, press the **POWER** key on the side of the set. A blue indicator comes on and after a few seconds, the screen lights up at the left hand bottom of the front of the set.
- If the TV set remains in standby mode (red indicator), press the **PROGRAM - / +** key on the side controls or the **P - / +** key on the remote control.

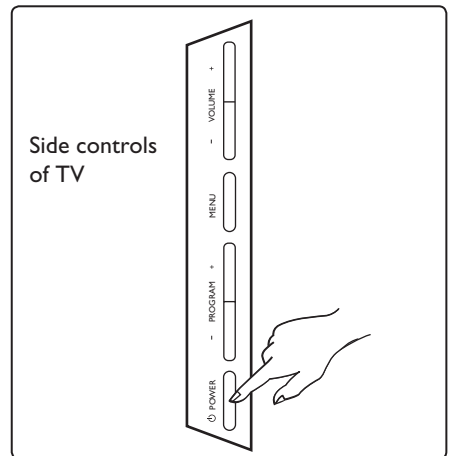

4.5 Using the Remote Control



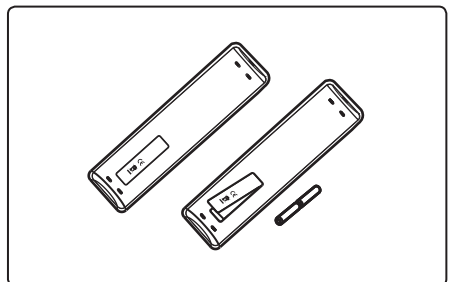

Insert the 2 batteries supplied. Be sure the (+) and (-) ends of the batteries line up correctly (inside of case is marked.)

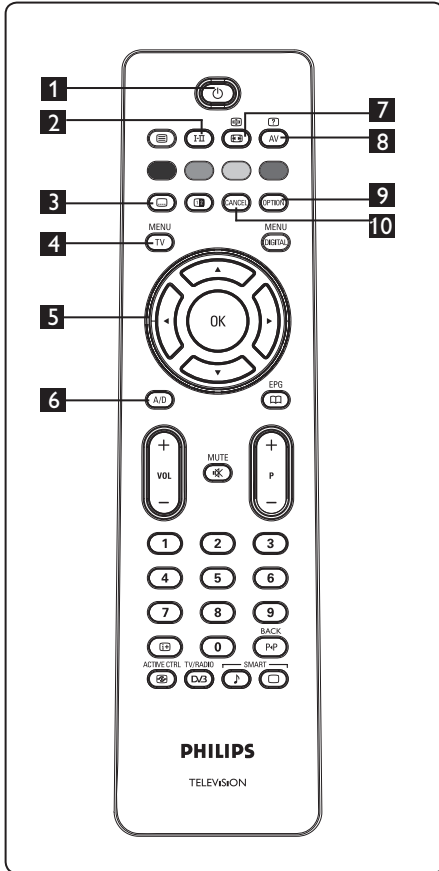

5 Remote control functions



1 Standby

To set the TV to standby mode. To switch the TV on again, press the  key once more or press the  to , **P**  **+** **-** or  key.

 Note: when the TV is switched on, the last viewed mode is displayed.

2 Sound mode

Used to force programmes in **Stereo** and **Nicam Stereo** to **Mono**. For bilingual programmes, select **Dual I** or **Dual II** (as indicated on the screen during such broadcasts). The **Mono** indication shows up in red when in forced position.

In digital mode, **I-II** displays the list of audio languages.

3 Subtitles mode

In digital mode, this key activates or deactivates the subtitle mode.

4 MENU

To call up or exit the TV analogue menus.

5 Cursors Up/Down/Left/Right

These 4 keys are used for selection and adjustment of menu items.



6 Analogue or Digital mode

To switch between the television analogue and digital mode.

7 Screen Format

(See page 39).

8 AV

To display Source List to select TV (Analogue), Digital TV or connected peripheral equipment (EXT 1, EXT 2, EXT 3, EXT 4, HDMI 1 or HDMI 2). Use the   keys to select source and the  key to confirm selection.

9 Options

(See page 23)

10 Cancel

In digital mode, this key functions as an exit key for MHEG teletext if no colour keys links are available to exit teletext mode.

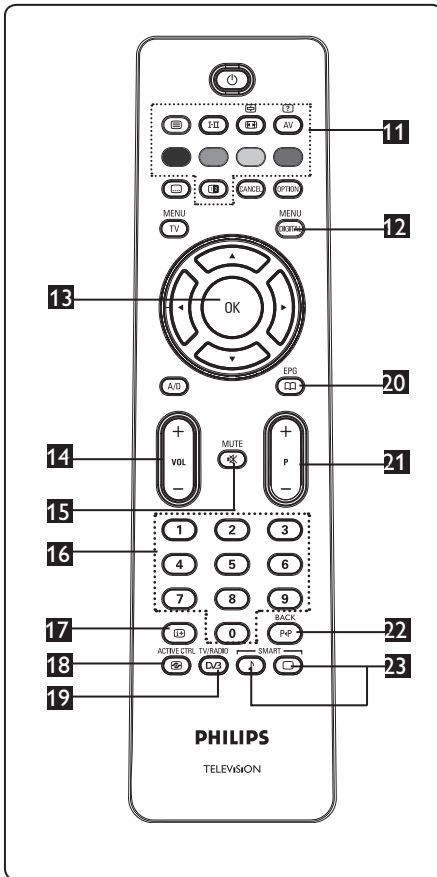

11 Teletext

(See page 40-41).

12 Digital menu 

To display / exit from the digital menu (when TV is in digital mode).

13 OK 

Confirms selection. Also access program list in Digital mode.

14 Volume (+ VOL -)

To turn on sound louder or quieter.

15 Mute 

Turn off or on sound.

16 0 / 9 Numerical keys  

For direct access to programmes.

For a two digit programme number, the 2nd digit must be entered shortly after the first digit before the dash disappears.

17 Screen information 



In **digital** mode, display/exit the information banner (see page 14).

In **analogue** mode, display/remove the programme number, the sound mode, the clock and the remaining time of the sleep timer.

18 Active Control 

Automatically adjusts the picture setting for optimal picture quality continuously under any signal conditions. (See page 36).

19 Digital TV / Radio 

In digital mode, this key is used to access digital radio stations. Press the  key to access radio list. **Note** : To return to digital video mode, press the  key again.

20 TV Guide 

(see page 24)

21 Programme (+ P -)

Selects next or previous available channel/source (or page in digital menu).







22 Alternate channel / Edit or back space 

In Analogue/Digital mode, it allows you to alternate the previously viewed programme and the current programme. It is also used as an edit or back space key when you are naming your favourite channel.

23 Smart Picture /Sound  

Accesses a series of predefined picture and sound settings (see page 38).

6 Overview of Digital main menu and sub-menus

- 1 Use the  key of the remote control to select Digital mode.
- 2 From the digital mode, press the   key to display the setup menu.
- 3 Use the     keys to navigate, select and adjust menu items.

Setup

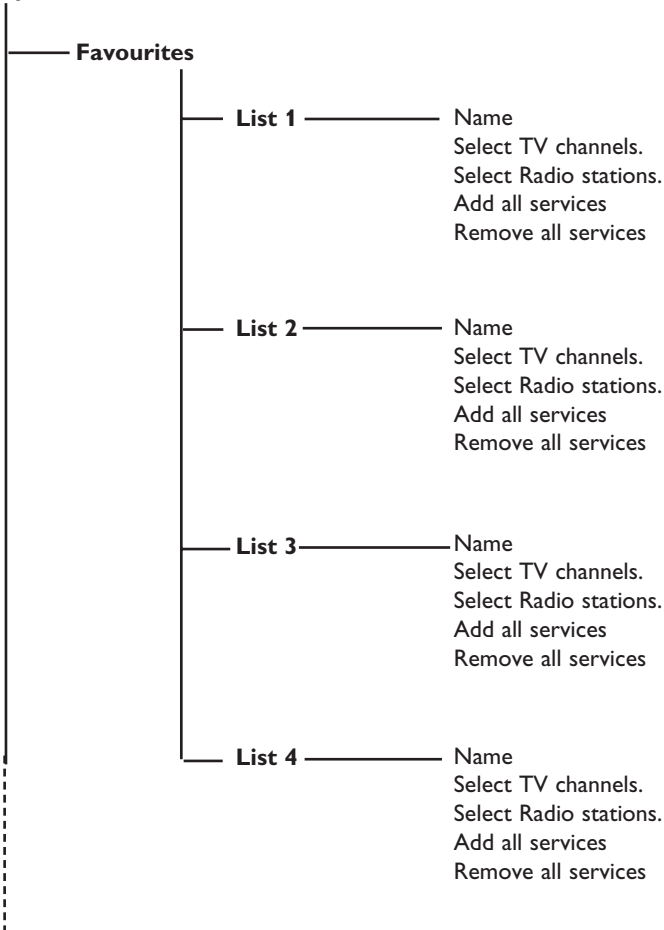

Setup

Preferences

Language

- Audio — Basque, Catalan, Croatian, Czech, Danish, Dutch, English, Finnish, French, Gaelic, Gallegan, German, Greek, Hungarian, Italian, Norwegian, Polish, Portuguese, Russian, Serb, Slovak, Spanish, Swedish, Turkish, Welsh
- Subtitle/Teletext
- Subtitling Mode — On, Off, Auto
- Subtitles for hearing impaired — Yes, No
- System — Cesky, Dansk, Deutsch, English, Español, Français, Italiano, Magyar, Nederlands, Norsk, Polski, Português, Suomi, Svenska

Location

- Country — Australia, Austria, Belgium, Czech, Denmark, Finland, France, Germany, Greece, Hungary, Italy, Netherlands, Norway, Poland, Portugal, Spain, Sweden, Switzerland, United Kingdom
- Time zone

Information

System software

- Current software version
- Always accept new software — Yes, No

Access restrictions

- Set pin code protection — On, Off
- Maturity rating
- TV channels
- Radio stations
- Change pin code

Setup

Installation

Service lists

Rearrange services
View new TV channels.
Listen to new Radio Stations.

Service setup

Add new services

- Search
- TV channels found.
- Radio station found.
- Other services found.
- Store
- Discard

Reinstall all services

- Search
- TV channels found.
- Radio station found.
- Other services found.
- Store
- Discard

Manual install service

- Frequency
- Network name
- Signal quality
- Services found
- Store
- Discard

Test reception

Frequency
Network name
Signal quality
Signal strength

7 Switching on the TV for the first time

When you switch on the TV set for the first time, a menu will appear on screen.

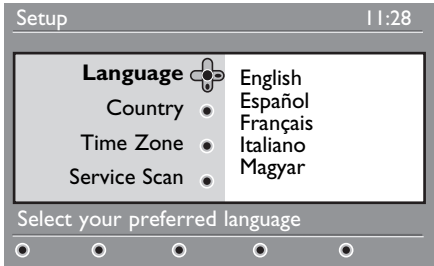

- 1 Press the ► key to enter into **Language** mode and press the ▲ ▼ keys to select your preferred language.
- 2 Press the (OK) key to confirm selection.
- 3 Press the ▲ ▼ keys to select **Country** or **Time Zone** and press the ► key to enter into **Country** or **Time Zone** mode.

⚠ Caution

If you select a wrong country, the channel numbering will not be according to the standard for your country and you may not receive all services or nothing at all.

ⓘ Note

The Language can be selected independently from the Country.

- 4 Press the ▲ ▼ keys to select your preferred **Country** or **Time Zone** and the (OK) key to confirm your selection.

- 5 Press the ▼ key to select **Service Scan** to scan the available analogue and digital channels.

- 6 Press the (OK) key to start the installation.

ⓘ Note

If no digital channels are detected, press

(A/D) key to switch to analogue mode.

ⓘ Note

If at some point of time you decide to reset to the factory default settings, press and hold down the **MENU** key on the side of the TV set for 5 seconds. A menu will appear on the screen. Repeat steps 1 - 5 as if this was the first time you have turned on the TV. This activity will reset both the Digital and Analogue mode to factory default settings.

8 Understanding the information on the banner



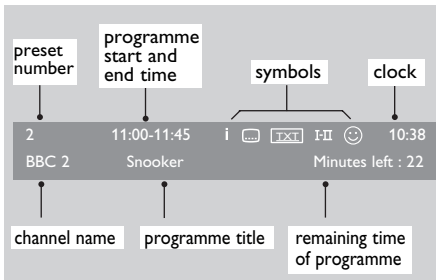

When you select a digital programme, an information banner is displayed for a few seconds at the top of the screen.

8.1 Banner description





The banner contains information on the preset number, channel name, programme duration, transmission clock, programme title and the time remaining of the current programme.

8.2 Symbols description

- i More information about this programme is available : press the  key once to display and a second time to remove it.
-  Subtitling is available : if you want to display them, press the  key or the  key to access the options menu and select subtitles.

 Indicates Analogue Teletext is available in Digital mode.

 Other languages are available and can be selected in the options menu. You can also select other languages by pressing the  key.

 The colour of the symbol (red, green, yellow or blue) indicates the selected Favourite list.



Note

A white symbol  will appear if the programme is stored in one or more of the favourite lists which are currently not activated.



9 Service lists

9.1 Rearrange services



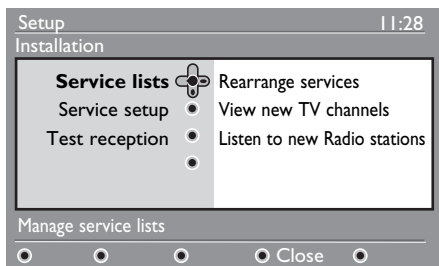

This menu allows you to change the order of the stored digital channels and radio stations.

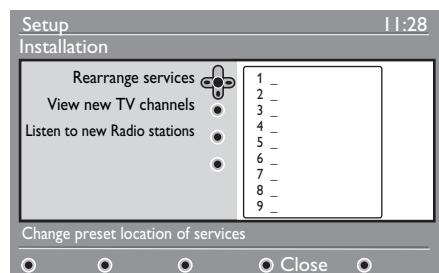

- 1 From the digital mode, press the  key to display the setup menu.
- 2 Use the  key to select **Installation** and press  twice to select the **Service lists** menu.



- 3 Use the   keys to select **Rearrange services** and press  key.













- 4 Use the   keys to select the channel you want to exchange.
- 5 Press  key to activate.
If you want to uninstall the selected channel, press the **red** key.
- 6 Select ( ) the new channel number

- 7 Press  key to confirm. The exchange is done.
- 8 Repeat the operations **4** to **7** until all the channels are in the required order.
- 9 To return to previous menu, press the  key.
- 10 Press the  key to exit the menu.

9.2 View new TV channels or Listen to new Radio stations





This menu allows you to check the availability of new TV channels or new radio stations that have been launched by the broadcaster after the initial installation.

- 1 From the digital mode, press the  key to display the setup menu.
- 2 Use the  key to select **Installation** and press  twice to select the **Service lists** menu.
- 3 Use the   keys to select **View new TV channels** or **Listen to new Radio station**.
- 4 If new services are available, press  to enter into the list and use the   keys to move through the list.
- 5 To return to previous menu, press the  key.
- 6 Press the  key to exit the menu.



10 Service setup

10.1 Add new services

This menu allows you to search for new TV channels or radio stations that have been launched by the broadcaster after the initial installation.

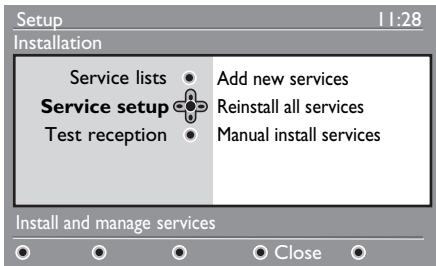
- 1 From the digital mode, press the  key to display the setup menu.
- 2 Use the  key to select installation and press  key.
- 3 Select **Service setup** () and press  key.



- 4 Press  to add new services and press  key to activate the installation.

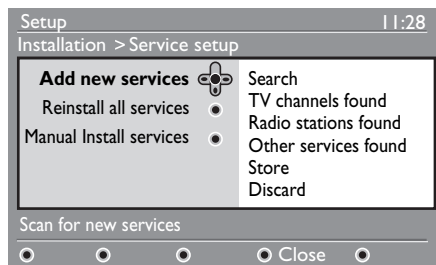







The search begins and only new channels will be stored and added to the channel list menu. The percentage of the installation that has been completed and the number of channels found is displayed. When the search is completed, press the  key to accept the new services.

- 5 To return to previous menu, press the  key.
- 6 Press the  key to exit the menu.

10.2 Reinstall all services

This menu allows you to reinstall all the digital TV channels and radio stations.

- 1 From the digital mode, press the  key to display the setup menu.
- 2 Use the  key to select installation and press  key.
- 3 Select **Service setup** () and press  key.
- 4 Select **Reinstall all services** () and press  key.

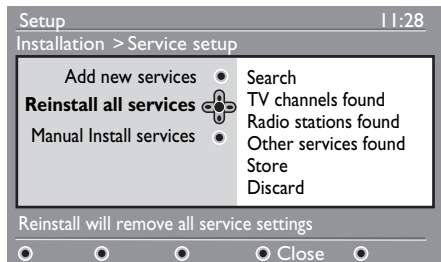

-
- 5 Press the **OK** key to start the installation.
A search is then made for all digital services which are then stored automatically. When the search is completed, the menu will indicate the number of digital services found.
 - 6 Press **OK** key to store the services.
 - 7 To return to previous menu, press the **◀** key.
 - 8 Press the **MENU DIGITAL** key to exit the menu.

- 5 Use the **0** to **9** key to input frequency of your target channel and press **OK** key to start the searching of channels. When the search is completed, the menu will indicate the number of digital services found.
- 6 Press the **OK** key to store the services.
- 7 To return to previous menu, press the **◀** key.
- 8 Press the **MENU DIGITAL** key to exit the menu.

10.3 Manual install services

This menu allows you to scan manually services by keying in the frequency of your target channel.

- 1 From the digital mode, press the **MENU DIGITAL** key to display the setup menu.
- 2 Use the **▼** key to select installation and press **▶** key.
- 3 Select **Service setup (▼)** and press **▶** key.
- 4 Select **Manual install services (▼)** and press **▶** key.

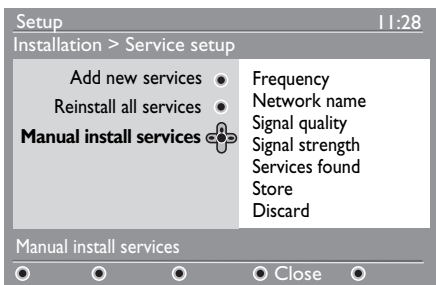



11 Test reception

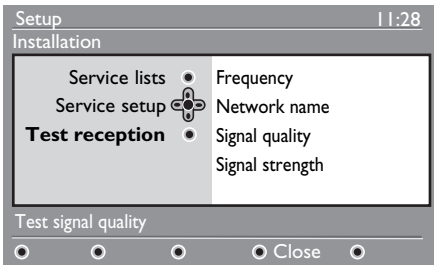

This menu allows you to check the strength of the signal you are receiving through your aerial.

- 1 From the digital mode, press the  key to display the setup menu.
- 2 Use the ▼ key to select **Installation** and press the ► key.



- 3 Use the ▼ key to select **Test reception** and press the ► key. You obtain an indication of the actual programme frequency, the network name, the signal quality and strength.
- 4 Use the ► key to enter the Frequency slot and use the  to  keys to enter the frequency of the digital channel you want to test. Use the ► key to move to the next character space.

If the test reception indicates that the signal strength is indeed poor, you can try improving, renewing, adjusting or updating the aerial. It is however advisable to contact a specialised aerial installer in order to achieve best results.



- 5 After entering the frequency, use the  key to exit Frequency slot.
- 6 To return to previous menu, press the ◀ key.
- 7 Press the  key to exit the menu.

12 Preferences

This menu allows you to select your preferred language or to make changes to the location (country and time zone).

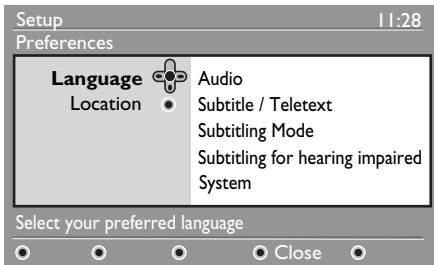
- 1 From the digital mode, press the  key to display the setup menu.
- 2 Use the **▼** key to select **Preferences** and press **▶** key.



- 3 Select **Language** or **Location** (**▼**) and press **▶** key.
- 4 Use the **▲ ▼** keys to select a setting and press **▶** key to enter into the sub-menu. Make your adjustment and press  key or **◀** key to exit.
- 5 To return to previous menu, press the **◀** key.
- 6 Press the  key to exit the menu.

Language default settings





- **Audio** : to select the audio sound language.
- **Subtitle/Teletext** : to select the subtitle/teletext language.
- **Subtitling mode** : off, on or auto (subtitle only displayed in case of original audio transmission).

- **Subtitles for hearing impaired** : to activate or deactivate the specific subtitling for hearing impaired (if made available by the broadcaster).

- **System** : to select the menu language.

Note

If you have selected the wrong language for one reason or another and do not understand the selected language to operate the set, do the following to bring you back to your preferred language.

- Press the  key to exit menu from screen.
- Press the  key again to display menu.
- Press the **▼** key to select the **second** item on the menu and the **▶** key to enter into the next menu level.
- Press the **▶** key to again and use the **▼** key to select the fifth menu item.
- Press the **▶** key to enter into the next menu level.
- Press the **▲ ▼** keys to select correct language.
- Press the  key to confirm selection.
- Press the  key to exit menu from screen.

Location settings

- **Country** : to select the country where you are located.

Caution

If you select a wrong country, the channel numbering will not be according to the standard for your country and you may not receive all services or nothing at all. Note that the Language can be selected independently from the Country.

- **Time zone** : to select the time zone where you are located.

13 Access restrictions

This menu allows you to set up the access restrictions for the digital channels.

- 1 From the digital mode, press the  key to display the setup menu.
- 2 Use the **▼** key to select **Access restriction** and press the **▶** key.
- 3 Press the **▶** key to enter into the **Set pin code protection** menu.

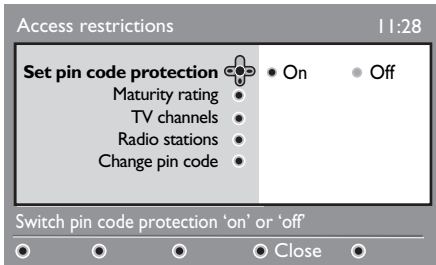



- 4 Use the **◀ ▶** keys to set to **On** option and press  key to exit. You can then access the other adjustments.

! Warning

The moment you use any kind of access restriction, you need to fill in the pin code when you schedule a programme for recording.

- 5 To return to previous menu, press the **◀** key.
- 6 Press the  key to exit the menu.

- **Maturity rating** : select your preferred rating to lock the channel. Maturity rating will only block certain programmes if the broadcaster provides data with the programme.

- **TV channels**: select the TV channel you want to lock and press  key.
- **Radio station**: select the radio station you want to lock and press  key.
- **Change pin code**: press **▶** key to enter in the menu. Follow the on-screen instruction to change your access code. The default pin code is 1234. If you have forgotten your personal code, you can reset to the default pin code (1234) by entering the universal code 0711.

⊖ Note

The TV is equipped with a Common Interface (CI) slot (see page 27). This CI module can be obtained when you subscribe to service providers like Pay TV or other service providers. The CI module does not come with the TV set.

The Access Restrictions menu will show the CI Access Restrictions when a CI module is installed. The CI module is responsible for the messages and texts on screen. In case of failure or strange behaviour, you must call your CI service provider.



14 Setting up your favourite list



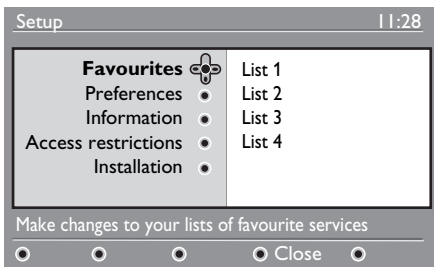

This menu enables you to create a favourite list with your preferred TV channels and radio stations. For example, each member of your family can create his/her own favourite list.

- 1** From the digital mode, press the  key to display the setup menu.



- 2** Press **▶** to enter into the favourites list menu. You have the choice to create 4 different favourite lists.
- 3** Use the **▲ ▼** keys to select your **Favourite list** : **List 1, List 2, List 3** or **List 4** and press **▶** key.
- 4** Use the **▲ ▼** keys to select a setting and press **▶** key to enter into the sub-menu.

- **Name** : use the **◀ ▶** keys to move around the name display area (16 characters) and the **P + / -** keys to select the characters. To edit any character, use the  key. When the name has been entered, press  key to exit.

- **Select TV channels** : use the **▲ ▼** keys to select your favourite TV channels and confirm with  key. Press **◀** key to exit.
- **Select radio stations** : use the **▲ ▼** keys to select your favourite radio station and confirm with  key. Press **◀** key to exit.
- **Add all services** : press  key if you want to add all the service into your favourite list.
- **Remove all services** : press  key if you want to remove all the service from your favourite list.

- 5** To return to previous menu, press the **◀** key.

- 6** Press the  key to exit the menu. Your favourite list can be selected via the options menu (see next page).

15 Information

This menu provides information about the software version and the installation of new software.

1 From the digital mode, press the  key to display the setup menu.

2 Use the **▼** key to select information and press **▶** key twice.

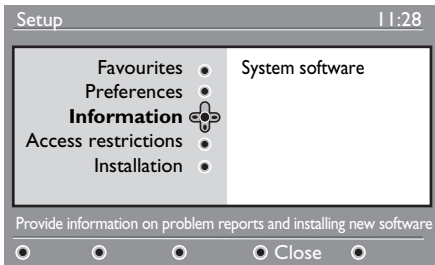

The software version is displayed.

3 Use the **▶** key to enter the selection mode.

4 Use the **◀ ▶** keys to select **Yes** or **No** mode. You can activate the menu to automatically accept any software update of your digital TV through off-air downloading. Normally the product will detect if an update is available while it is in standby mode. Next time the television is turned on a message will appear on the screen indicating new software is available. Selecting the  key activates the software download.

The software download menu will give a description of the software together with the date and time of the download. This may update certain menus, functions or add new features, but the general way in which the TV operate will not change.



Once accepted the download will take place at the designated time and date.

Note

The TV must be put into standby when the download is due in order for it to take place.

Off Air Downloading of new software

Whenever a new software is available, it is advisable to always accept and download the software.

- In case new software is available, you will see a message when you switch on the TV. A message indicating the date and the duration of download is indicated in the menu. Press the  key to proceed.
Important : Leave your TV in standby to allow upgrade to take place. Do not power off your main switch.
- If a problem occurred during the download of the new software, you will be informed of the next scheduled software download. Press the  key to proceed to use your TV normally.
- If download is successful, a congratulatory message will appear. Press the  key to accept. New software and upgrade instructions may also be obtained from the website : www.philips.com/

5 To return to previous menu, press the **◀** key.

6 Press the  key to exit the menu.

16 Using the Options menu

This menu gives you direct access to the favourite list, the language selection and some other selections.

- 1 From the digital mode, press the white  key to display the options menu.

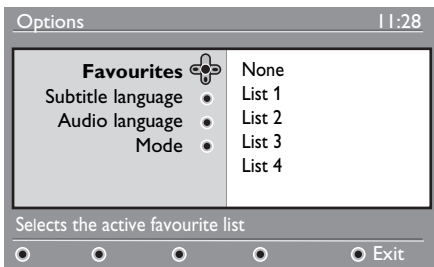



- 2 Use the **▲ ▼** keys to select a setting and press **▶** key to enter the sub-menu.

- **Favourites** : use the **▲ ▼** keys to select your favourite list and confirm with  key.

Note

The “none” option deactivates any favourite list. To create your own favourite list, see page 21.

- **Subtitle language** : use the **▲ ▼** keys to temporarily change the language and confirm with  key.

- **Audio language** : to temporarily change the audio sound language. To permanently change the audio and subtitle languages, use the Preferences menu (see page 18).
- **Mode** : you can choose to only have radio stations, TV channels or services without audio or video.
-  **Note** (for the UK only)
The TV list will contain both radio stations and TV channels
- **Banner duration** : to select the duration for which the banner is visible.

- 3 Press the white  key to exit the menu.

17 TV Guide

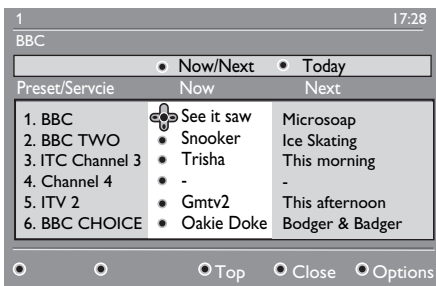

The TV guide is an Electronic Programme Guide that provides you with a quick and easy way to view a complete list of digital programmes as you would in a newspaper or TV magazine. You can navigate through the list of digital programmes and obtain detailed information on the programmes. You can also program the TV to provide a digital channel to be recorded.

- 1** From the digital mode, press the  key to display the TV guide :



A list of all the digital programmes in the currently selected favourite list is displayed.

- 2** Use the **▼** key to enter into the **Preset/service** list or press **▶** key to access **Today** list.
- 3** Use the **◀ ▶** keys to select a programme.
- 4** The TV guide features are displayed at the bottom of the screen. Use the coloured keys red, green, yellow, blue or white to activate them.

- **Top** (yellow key) : to go directly to the top of the list.
 - **Close** (blue key) : to exit from the TV guide.
 - **Options** (white **▶▶** key) : with this menu, you can select your favourite list, mode or themes. Themes are areas of interest, you can for example, decide to display only : drama, news, movie, ...
- 5** Press the  key if you want to display more information about the selected programme (if available).
- 6** Press the  key to exit the menu.

18 Recording function (Not applicable for this model)

This feature enables you to record a digital channel while the TV is in standby mode. You will still have to programme your video recorder. If you wish to continue watching another digital channel after setting a timer, you can do so by changing channels in the normal way.

Important : Do not switch off the TV and the mains when a recording has been programmed. The TV must be in standby for recording to take place.

- 1 From the digital mode, press the  key to display the TV guide.
- 2 Use the **▼** key to enter into the **Preset/Service** list or press **▶** key to access **Today** list.
- 3 Press the **RED** key to call up the **Record** menu.

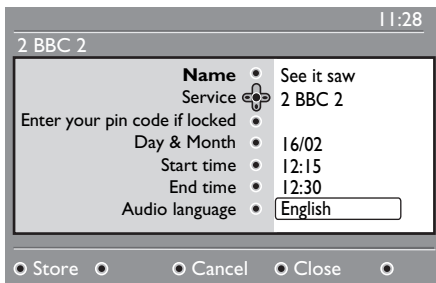

- 4 Use the **▲ ▼** keys to select a setting and press **▶** to enter into the sub-menu. Make your adjustment and press **OK** key or **◀** key to exit.
- **Name** : the selected programme will be displayed here.
 - **Service** : you can change the number of the programme you want to record. Press **OK** key to confirm.
- Note**
- It is only possible to change to a number that is in the currently selected favourite list.
- **Enter your pin code if locked** : enter your secret code only if you have activated the access restriction feature (see page 19). Press **OK** key to confirm.
 - **Day & Month** : enter the date by using the **P - / +** keys. Press **OK** key to exit
 - **Start time** : enter the start time.
 - **End time** : enter the end time.
 - **Audio language** : select your language and confirm with **OK** key.
 - **Subtitle language** : make your selection and confirm with **OK** key.
 - **Subtitles for hearing impaired** : select **Yes** or **No** and confirm with **OK** key.
 - **Occurrence** : select **Once**, **Daily** or **Weekly** and confirm with **OK** key.

(Not applicable for this model)

5 Press the **RED** key to store your recording. The TV guide reappears. You can press the **GREEN** key to display the list of recordings you have set.



6 If you have finished watching television, you must leave it in standby in order for the recording programme to be activated.

Important

Do not switch off the TV and the mains when a recording has been programmed. The TV must be in standby for recording to take place.

7 If you are watching another digital channel when the timer is due to start, the timer alarm will sound and present you with the option of switching channels or continuing to watch the current channel. If you choose to switch channels, recording will not take place.

Note

Your future recording might be interrupted or affected if you press either the  or  key immediately when the set is wakeup from standby. Future recording might also be interrupted or affected when either EXT 1/ EXT 2 source is connected when the set is wakeup from standby.











To avoid the interruption of your future recording, it is recommended that you stay in digital mode for about a minute if a recording has been programmed.

19 Digital teletext (MHEG)

Available in U.K. only

Digital teletext services differ greatly from analogue teletext. When you switch to a Digital teletext service, the images you see contain graphics and text which are laid out and controlled in a manner decided by the broadcaster. Some digital channels, which you select like any other channel, offer dedicated teletext services. Some digital channels also offer information on the programme being broadcast (a message or an instruction may appear on the screen).



Under certain circumstances, Digital text or interactive services may have priority over subtitles. This can result in the subtitles not automatically reappearing when leaving Digital text or interactive services on a channel which is broadcasting subtitles. In these cases, subtitles can be initialised either by toggling the  key on the remote control or by changing channel.

- 1 To use the digital teletext, follow the instructions on screen.
- 2 Depending on the service, you can be asked to use the     (cursor keys),     (colour keys),  (Teletext On/Off key) and sometimes the  /  numerical keys.

Note

If no colour key links are available in the Digital Teletext to allow you to exit teletext mode, use the  key instead.

- 3 When you have finished watching teletext, select a different channel with P - / + keys or follow the on screen instructions to return to picture.



When you switch to a digital channel with links to a teletext service, software is downloaded in the background to enable the teletext function. You will have to wait for a while before you press the  key to allow the software download to complete. If you press the  key before the download is complete, there will be a short delay before the teletext screen is displayed.

While navigating the digital teletext, there is a short delay while the page downloads. A prompt or message is often broadcast on the page to let you know the progress.

Analogue teletext in Digital mode

Note

Available in all countries

- If you see an icon  on a digital channel without digital teletext services, it indicates Analogue Teletext is available in Digital mode.
- Press the  key to access Analogue teletext.

Note

If **UK** country is selected during installation, press and hold  key for at least 3 seconds.

- To use Analogue Teletext functions, see page 40 and 41.

20 Using the Conditional Access Module (CAM)

The **Conditional Access Module (CAM)** menu provides access to functions contained on the CAM. The module can be inserted into the Common Interface (CI) slot located at the backside (facing downwards) of the TV.

Note

This Common Interface (CI) module does not come with the TV set. It can only be obtained when you subscribe to service providers like Pay TV or other service providers.





IMPORTANT

Always switch the TV off before inserting or removing the module.

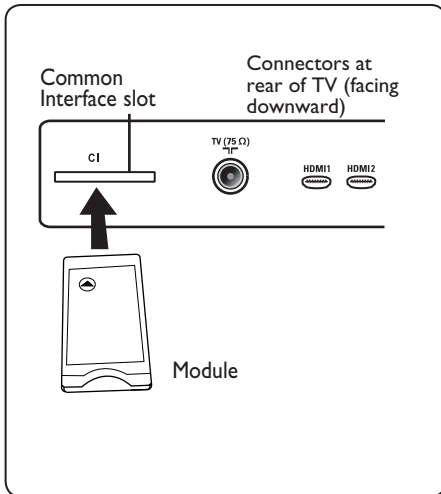
Inserting the CAM

- 1 Switch off the TV.



- 2 Some modules come with a viewing card. When using this type of module, first insert the viewing card into the module. Ensure that the arrow on the viewing card faces the arrow of the module before inserting into the module slot.
- 3 Insert the module into the Common Interface (CI) slot on the TV.
- 4 Switch on the TV.
- 5 Press the  key to display the setup menu.
- 6 Use the  key to select **Access restriction** and press the  key.
- 7 Press the  key to enter into the **Conditional Access Module** menu.
- 8 Press  button as indicated on the screen to access the CAM's functions (see page 20).

IMPORTANT

If no module is inserted, or the module is not inserted properly, the Conditional Access Module menu will not be displayed. (If you have inserted a module, check that it is fully inserted in the correct manner as mentioned in step 3 above).

The functions that now appear on screen are dependent on the contents of the selected Conditional Access Module in your country. Refer to the instruction supplied with the module or contact the vendor.

21 Automatic tuning of analogue programmes

This menu allows you to automatically search for all the analogue programmes available in your region.

Before you automatically search for all the analogue programmes, ensure the TV is in analogue mode. If it is in digital mode, press the **A/D** (Analogue / Digital) key to enter the analogue mode.

- 1 Press the **MENU TV** key.

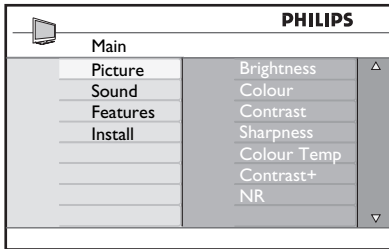

- 2 Press the **▲ / ▼** key repeatedly to select **Install** and the **▶ / OK** key to enter the **Install** menu.

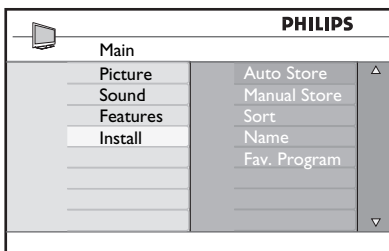

- 3 Press the **▼** key to select **Auto Store** and the **▶ / OK** key to start automatic searching of the channels. All the available TV programmes will be stored. This operation takes a few minutes. The display shows the progress of the search and the number of programmes found.

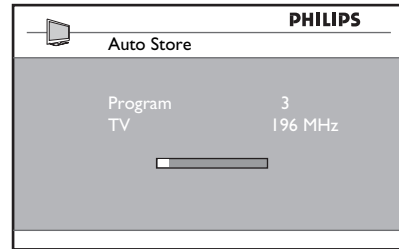

IMPORTANT

To exit or interrupt the search before it is completed, press the **MENU TV** key. If you interrupt search during auto store, not all channels will be stored. For all channels to be stored, you need to do a complete auto store search again.

Note

ATS (Automatic Tuning System) feature

If the transmitter or cable network sends the automatic sort signal, the programmes will be numbered correctly. In this case, the installation is complete. If this is not the case, you can use the **Sort** menu to number the programmes to your preference.

ACI (Automatic Channel Installation) feature

If a cable system or a TV channel which broadcasts ACI is detected, a programme list appears. Without ACI broadcast, the channels are numbered according to your language and country selection. You can use the **Sort** menu to renumber them.

Note

You cannot change the **Language** or **Country** in Analogue mode. If you want to change the **Language** or **Country**, you have to exit Analogue mode and enter into Digital mode to do so (refer to "**Preferences**" on page 18).

22 Manual tuning of analogue programmes

This menu is used to store the programmes one at a time.

- 1 Press the  key.
- 2 Press the \blacktriangle \blacktriangledown keys repeatedly to select **Install** and the \blacktriangleright /  key to enter the **Install** menu.

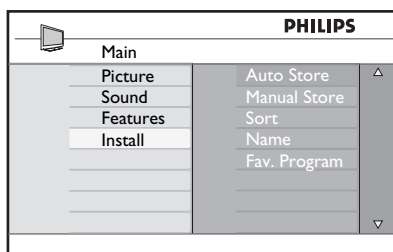

- 3 Press the \blacktriangledown key to select **Manual Store** and the \blacktriangleright /  key to enter **Manual Store** menu.

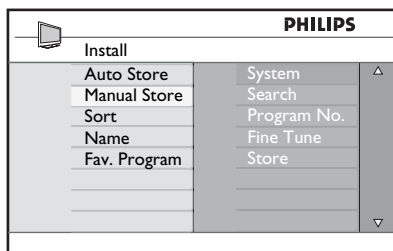

- 4 Press the \blacktriangle \blacktriangledown keys to select the items in the **Manual Store** menu to adjust or activate.

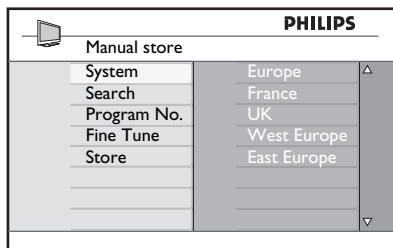



5 System:



Press the \blacktriangle \blacktriangledown keys to select **Europe** (automatic detection), **France** (LL' standard), **UK** (I standard), **West Europe** (BG standard) or **East Europe** (DK standard).

Press the \blacktriangleright /  key to confirm selected system.

6 Search:

Press the \blacktriangleright key. The search starts. Once a programme is found, the scanning stops and its name is displayed (if available). Go to the next step. If you know the frequency of the required programme, this can be entered directly using the  to .

7 Program No.:

Enter the required number with the  to  or \blacktriangle \blacktriangledown keys.

8 Fine Tune:

If the reception is not satisfactory, adjust using the \blacktriangle \blacktriangledown keys.

9 Store:

To store the changes, press \blacktriangleright /  key. The programme is now stored.



- 10 Repeat steps **6** to **9** for each programme to be stored.

- 11 To return to previous menu, press the \blacktriangleleft key.

- 12 To exit the menu, press the  key.

23 Programme Sort

Sort feature allows you to change the programme number for a particular station.

- 1 Press the  key.
- 2 Press the \blacktriangle / \blacktriangledown key repeatedly to select **Install** and the \blacktriangleright /  key to enter the **Install** menu.

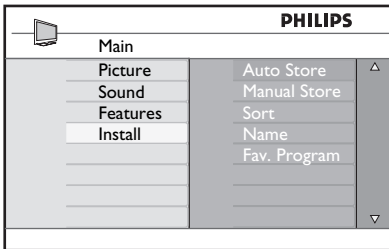

- 3 Press the \blacktriangledown key to select **Sort** and the \blacktriangleright /  key to enter sort mode.

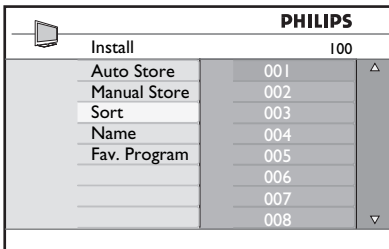

- 4 Select the programme number you want to move using the \blacktriangle / \blacktriangledown keys and the \blacktriangleright key to enter sorting mode (The arrow cursor now points to the left).

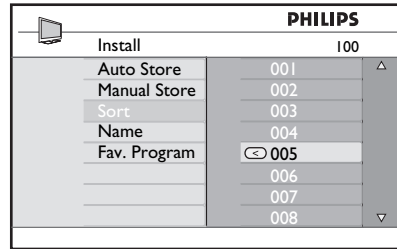

- 5 Press the \blacktriangle / \blacktriangledown keys to select the new programme number and confirm with the \blacktriangleleft key. (The arrow points to the right and sorting is completed).

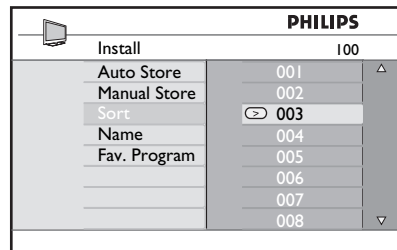



- 6 Repeat steps 4 and 5 for each programme number you wish to re-number.
- 7 To return to previous menu, press the \blacktriangleleft key.

- 8 To exit the menu, press the  key.

24 Naming of Channel

If preferred, you can assign a name to the TV channel.

- 1 Press the  key.
- 2 Press the \blacktriangle / \blacktriangledown key repeatedly to select **Install** and the \blacktriangleright /  key to enter the **Install** menu.

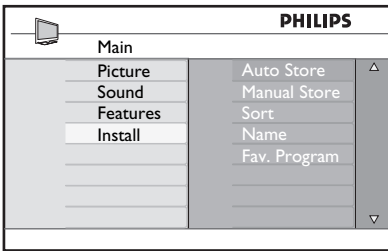

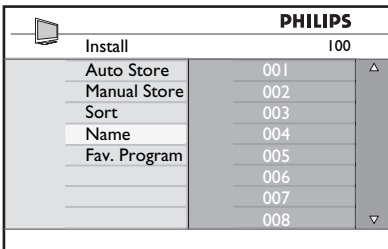

- 3 Press the \blacktriangledown key repeatedly to select **Name** and the \blacktriangleright /  key to enter **Name** mode.

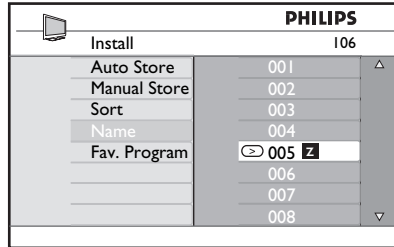

- 4 Press the \blacktriangle \blacktriangledown keys to select the channel you want to name.
- 5 Press the \blacktriangleright key to move to the first name display area.
- 6 Press the \blacktriangle \blacktriangledown keys to select the characters (maximum of 5 characters) and press the \blacktriangleleft \blacktriangleright keys to move around the name display area.





- 7 Press \blacktriangleright /  key until the name appears at the top left hand corner of the TV screen. The name is now stored.
- 8 To return to previous menu, press the \blacktriangleleft key.
- 9 To exit the menu, press the  key.





25 Selecting your Favourite Programmes

This feature allows you to skip programmes that you do not watch often and only keep your favourite programmes.

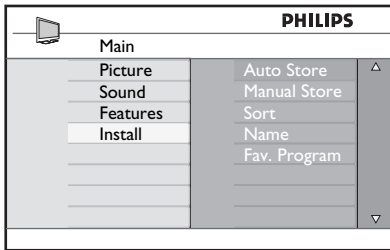
Note: Once a programme is skipped, you cannot access it by the P - / + key. You can only access the programme by the Digit 0 -9 keys.

- 1 Press the  key.
- 2 Press the  /  key repeatedly to select **Install** and the  key to enter the **Install** menu.



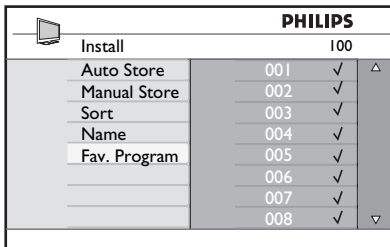

- 3 Press the  key to select **Fav. Program** and the  key to enter **Fav. Program** list.
- 4 Press the  /  key repeatedly to select programme you want to skip.



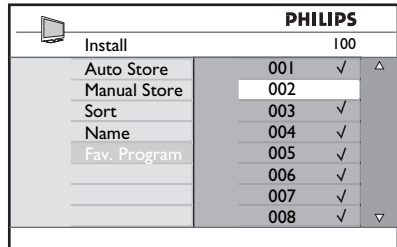

- 5 Press the  key to skip the programme. The ✓ on the right of the menu will disappear indicating the programme is skipped.







- 6 To return to previous menu, press the  key.
- 7 To exit the menu, press the  key.

* Tip



- To add back the skipped programmes to your favourite list, repeat steps 1 to 3.
- Press the  /  key repeatedly to select the skipped programme you want to add back to your favourite programme list.
- Press the  key to unskip a programme. The ✓ will appear indicating the programme is now restored.

26.1 Timer



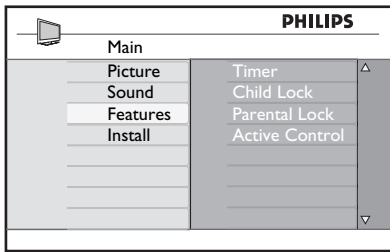

The Timer feature allows you to set the TV to switch to another channel at a specified time while you are watching another channel. You can also use it as an alarm to switch on the TV at a specified time from standby mode. For the timer to function, the set must not be switched off. Once the set is switched off, the timer is disabled.

- 1 Press  key.
- 2 Press   keys repeatedly to select **Features** and the  key to enter **Features** menu.

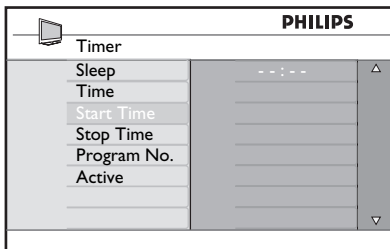

- 3 Press  key to access **Timer** menu.
- 4 Press   keys to select a **Timer** item.



- 5 To make adjustments to the timer setting, use the , , ,  or **Digit 0-9** keys.

Sleep: to select a time period in which the set will switch to standby mode upon reaching the selected time period. Select **Off** option to deactivate the feature.

Note

During the last minute of a Sleep time setting, an on-screen countdown will be displayed. Press any button on the remote control to cancel the Sleep shut down.

Time: enter the current time.

Start Time: enter the start time.

Stop Time: enter the standby time.

Program No.: enter the number of the channel for the wake-up alarm.





Activate: the settings include:

- **Once** for a single alarm,
- **Daily** for each day,
- **Off** to cancel.





- 6 Press  key on the remote control to put the TV set in standby mode. The TV will automatically come on at the programmed time. If you leave the TV set on, it will just change channel at the **Start Time** and will go to standby mode at the **Stop Time**.

26.2 Parental Lock

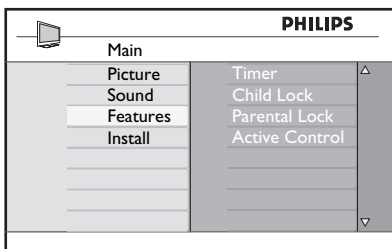
The **Parental Lock** feature allows you to lock channels to prevent your children from watching certain programmes.

- 1 Press  key.
- 2 Press   keys repeatedly to select **Features** and press the  /  key to enter **Features** menu.



- 3 Press   keys repeatedly to select **Parental Lock** and press  /  key to enter **Parental Lock** mode.

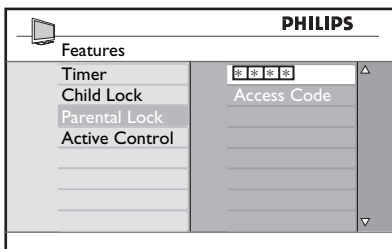



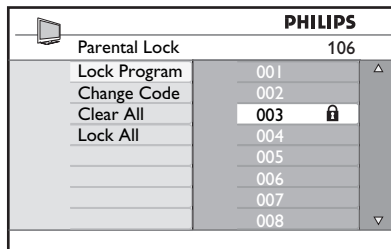



- 4 Key in the access code **0711** by the **Digit 0-9** keys. A message **Incorrect** will appear. Key in the access code **0711** again.
- 5 The TV will then prompt you to change code. Key in your own 4-digit code by the **Digit 0-9** keys and confirm the new code. Once the new code is confirmed, the **Parental Lock** menu will appear.



In the **Parental Lock** menu, use the , , , , **Digit 0-9** and  keys to access and activate the Parental Lock functions.

Description of the settings:

Lock Program

Lock individual program. Press  key to enter **Lock Program** mode and the   keys to select the program to lock or unlock. Press the   keys to lock or unlock selected program. A keylock symbol  appears besides the locked channel number. To exit from **Lock Program** mode and return to **Parental Lock** menu, press  key.

Change Code

Key in your new four-digit code using the **Digit 0-9** keys and confirm by keying in the new four-digit again.



Clear All

Press  key to unlock all locked channels.

Lock All

Press  key to lock all locked channels.

Note

If you switch on the TV set and select a program that has been locked, you need to key in the Access Code to enter the selected locked channel. To unlock the channel, go the **Lock Program** in the **Parent Lock** menu and press the   keys (keylock symbol  disappears).

26.3 Child Lock

The side controls of the TV will be locked when you select the **On** option in the **Child Lock** menu. You need to hide the remote control from your children to prevent them from watching TV.

- 1 Press  key.
- 2 Press **▲ ▼** keys repeatedly until **Features** is selected and press **▶ / (OK)** key to access **Features** menu.
- 3 Press **▼** key to select **Child Lock** and press the **▶ / (OK)** key to access **Child Lock** mode.

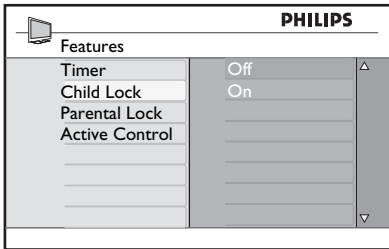



- 4 Press **▲ ▼** keys to select **On** or **Off** option.
- 5 Press **▶ / (OK)** key to activate/deactivate **On** or **Off** option.
- 6 To return to previous menu, press the **◀** key.
- 7 To exit the menu, press the  key.

26.4 Active Control

Automatically adjusts the picture setting for optimal picture quality continuously under any signal conditions.

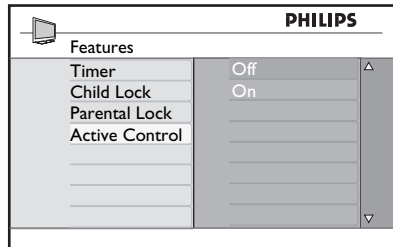
- 1 Press  key.
- 2 Press **▲ ▼** keys repeatedly to select **Features** and press the **▶ / (OK)** key to enter **Features** menu
- 3 Press **▲ ▼** keys repeatedly to select **Active Control** and press the **▶ / (OK)** key to enter **Active Control** mode.





- 4 Press **▲ ▼** keys to select **On** or **Off** option.
- 5 Press **▶ / (OK)** key to activate/deactivate **On** or **Off** option.
- 6 To return to previous menu, press the **◀** key.
- 7 To exit the menu, press the  key.

27 Picture and Sound settings

You can adjust the picture and sound settings in the **Picture** and **Sound** menu.

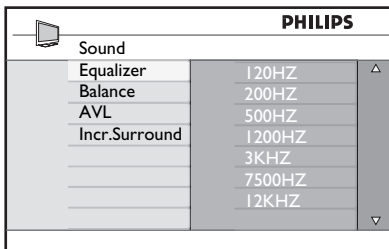
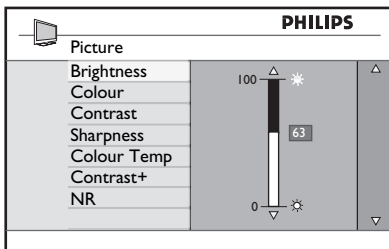
- 1 Press the  key.
- 2 Press the **▲ ▼** keys to select **Picture** or **Sound**.
- 3 Press **▶ / (OK)** key to enter **Picture** or **Sound** menu.



- 4 Press **▲ ▼** keys to select a **Picture** or **Sound** setting.
- 5 Press **▶ / (OK)** key to enter the **Picture** or **Sound** setting.
- 6 Press **▲ ▼** keys to adjust the **Picture** or **Sound** setting.
- 7 To return to previous menu, press the **◀** key.
- 8 To exit the menu, press the  key.

Description of the Picture settings

Brightness : this changes picture brilliance.

Colour : this changes the intensity of the colour.

Contrast: this changes the difference between the light and dark tones within the contrast range of the TV.

Sharpness: this increases or decreases the sharpness level to improve details in the picture.

Colour Temp.: this changes the colour setting: Cool (more blue), Normal (balanced) or Warm (more red).

Contrast+: Increases the contrast range of the TV. Select **On** option to activate feature.

NR: improves “noisy” picture (little dots on picture) due to weak signal transmission. Select **On** option to activate feature.

Description of the Sound settings

Equalizer: to adjust the sound tone.

Balance: this balances the sound on the left and right speakers.

AVL: (Automatic Volume Leveller): this is used to limit sudden increases in sound, especially on programme change or advertising slots.

Incr. Surround: select between Incredible Surround and Stereo when in stereo transmission and between Mono and Spatial when in Mono transmission.

28 Smart Picture and Sound

Smart Picture feature offers you a choice of 5 picture settings namely : **Rich, Natural, Soft, Multimedia** and **Personal**.

Press the  button repeatedly to cycle through the settings to select your desired mode.

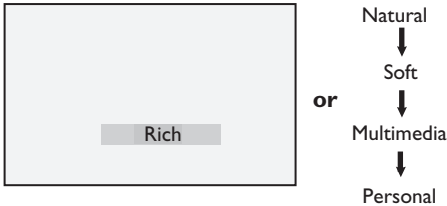

 **Note** : The **Personal** setting is the setting that you set up using the Picture menu in the main menu. This is the only setting in the Smart Picture setting that can be changed. All other settings are pre-set at the factory for your convenience.

Smart Sound feature offers you a choice of 4 sound settings namely : **Movies, Music, Voice**, and **Personal**.

Press the  button repeatedly to cycle through the settings to select your desired mode.

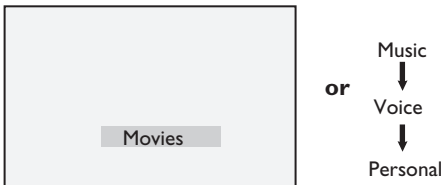

 **Note** : The **Personal** setting is the setting that you set up using the Sound menu in the main menu. This is the only setting in the Smart Sound setting that can be changed. All other settings are pre-set at the factory for your convenience.

Definition of Picture Settings

Rich : Brilliant and sharp picture settings suitable for bright environment and for use in demonstrations to show off the quality of the TV on good sources.

Natural : Reference mode for living room conditions and average signals.

Soft : Intended for bad-quality signals. Suitable for living room viewing.

Multimedia : Best for graphical applications.

Personal : Pictures settings are set to your preference.

Definition of Sound Settings

Movies : Emphasize sensation to action.

Music : Emphasize low tone.

Voice : Emphasize high tone.

Personal : Sound settings are set to your preference.

29 Screen Formats

The pictures you receive may be transmitted in 16:9 format (wide screen) or 4:3 format (conventional screen). 4:3 pictures will have a black band at the left and right of the screen. The screen formatting function allows you to optimise the picture display on screen.

Press the  key repeatedly to cycle through the different screen formats and select your preferred format.

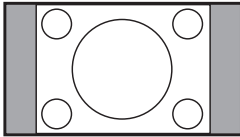

4:3 ⇅

The picture is reproduced in 4:3 format and a black band is displayed on either side of the picture.

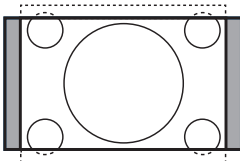

Movie Expand
14:9 ⇅

The picture is enlarged to 14:9 format, a thin black band remains on both sides of the picture. Some of the top and bottom of the picture is clipped off.

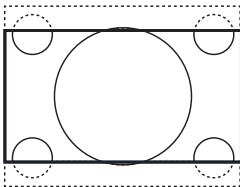

Movie Expand
16:9 ⇅

The picture is enlarged to 16:9 format. This mode is recommended when displaying pictures which have black bands at the top and bottom (letterbox format). In this mode, large parts of the top and the bottom of the picture are clipped off.

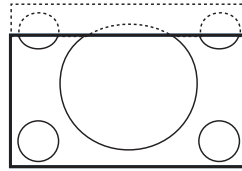

Subtitle Zoom ⇅

This mode is used to display 4:3 pictures using the full surface of the screen leaving the sub-titles visible. Part of the top of the picture is clipped off.

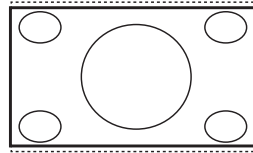

Super Wide ⇅

This mode is used to display 4:3 pictures using the full surface of the screen by enlarging the sides of the picture.

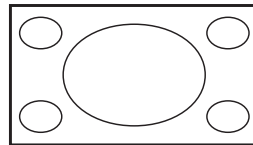

Widescreen

The picture is displayed in the original proportions of images transmitted in 16:9 format.

Note

If you display a 4:3 picture in this mode, it will be stretched horizontally.

Teletext is an information system broadcast by certain channels which can be consulted like a newspaper. It also offers access to subtitles for viewers with hearing problems or who are not familiar with the transmission audio language (cable networks, satellite channels, etc.).

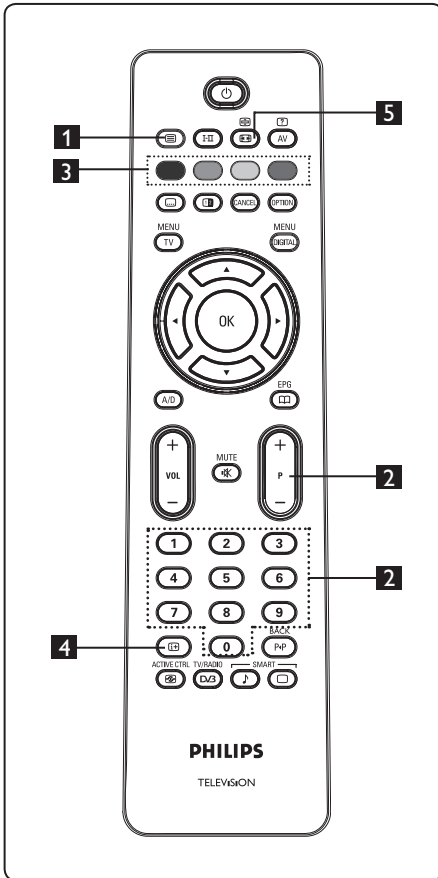

1 Teletext On/Off 

Press this key to switch on teletext display. A contents page appears with a list of items that can be accessed. Each item has a corresponding 3 digit page number. If the selected channel does not broadcast teletext, the indication 100 will be displayed and the screen will remain blank. Proceed to exit teletext by pressing the  key again.

2 Selecting a page

Enter the number of the page required using the 0 to 9 keys or P +/- keys. Example: page 120, enter 120. The number is displayed at the top left corner of the screen. When the page is located, the counter stops searching and the page is displayed. Repeat this operation to view another page. If the counter continues to search, this means that the page is not transmitted. In that case, select another number.

3 Direct access to the items



Colour areas are displayed at the bottom of the screen. The 4 colour keys are used to access the items or corresponding pages. The colour areas flash when the item or the page is not yet available.

4 Contents 

This returns you to the contents page (usually page 100 or hitlist menu).

5 Page hold 

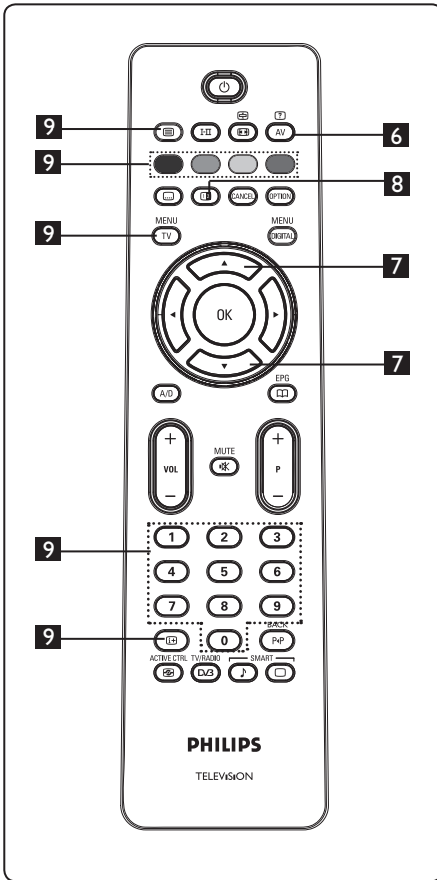
Certain pages contain sub-pages which are automatically displayed successively. This key is used to stop or resume sub-page progression. The indication  appears top left. Use the ◀ ▶ keys to select previous or next sub-page.







6 Hidden information

To display or hide the concealed information such as solutions to games or riddles.

7 Enlarge a page

This allows you to display the top or bottom part of the page. Pressing it again will return the page to normal size.

8 Picture/Teletext





- Press the  key.
- Press the  key to show Teletext on the right and the picture on the left of the screen.
- Press the  key to return to a full teletext mode.
- Press the  key to return to a full screen picture.

9 Favourite pages

 **Note:** only available in RF Analogue.

Instead of the standard colour areas displayed at the bottom of the screen, you can store 4 favourite pages on the first 40 channels which can then be accessed using the coloured keys (red, green, yellow, blue). Once set, these favourite pages will become the default every time teletext is selected.

To store the favourite pages, proceed as follows:

- Press the  key to change to favourite page mode.
- Use the / keys to enter the teletext page that you want to store as a favourite page.
- Press and hold the colour key of your choice for about 5 seconds. The page is now stored.
- Repeat steps 2 to 3 with the other colour keys.
- To exit favourite page mode, press the  key. To exit teletext mode, press  key.

 **Note**

To clear favourite pages, press and hold  key for about 5 seconds.



31 Using the TV as a PC Monitor

Your TV can be used as a computer monitor.  **Note** : PC connection is only available via **HDMI** connector. **VGA** connection is not supported.

31.1 Connecting the PC equipment

Important





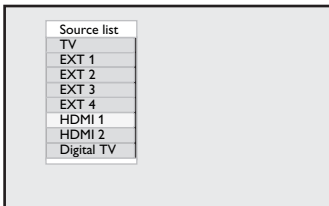

For the TV to function as a PC monitor, the following steps must be taken.







- 1 Connect the DVI output of your computer to the **HDMI 1** or **HDMI 2** connector of the TV. Use a HDMI to DVI cable if the DVI output is to be connected.
- 2 Connect the audio cable to the PC's Audio jack and to the L / R Audio jacks (**EXT3**) of the TV.
- 3 Press the  key to display Source List and use the   key to select **HDMI 1** or **HDMI 2**.



- 4 Press the  /  key to switch to the selected source.

31.2 Control TV settings while a PC is connected

- 1 Press the   key to display the main menu.
- 2 Press the   keys to select **Picture**, **Sound** or **Features** and the  /  key to enter the selected item menu.

- 3 Press the   key to select the settings and the   key to select or adjust setting.
- 4 To return to previous menu, press the  key.
- 5 To exit the menu, press the   key.

Picture menu

- The Picture menu comprises **Brightness**, **Contrast**, **Sharpness**, **Colour Temp.**, **Contrast+ Horizontal Shift** and **Vertical Shift** features.
- Except for the **Horizontal Shift** and the **Vertical Shift** features, all the other features work exactly in the same way as the features in the TV Picture menu (see page 37).
- **Horizontal Shift** feature allows you to adjust horizontal position of the image.
- **Vertical Shift** feature allows you to adjust vertical position of the image.

Features menu

- The Features menu comprises **Mode Selection** and **Format** features.
- When you connect PC supporting resolutions of **480p** or **720p**, the **Mode Selection** item will be available in the **Features** menu. This will allow you to select between the **PC** and **HD** mode.
- **Format** feature works exactly in the same way as the screen formats of the TV. (see page 39).

 **Note** : When using HDMI to connect your TV to the PC, it is possible that they may not operate perfectly first time. Often this is resolved by changing the resolution or settings of the device connected to the TV. In some situations you may see a dialogue box on screen and need to press "OK" to continue watching the TV. Please refer to the user manual of the connected device on how to make necessary changes.

32 Using the TV in HD (High Definition) mode

The HD (High Definition) mode allows you to enjoy clearer and sharper pictures if you are using HD equipment that can produce high definition video signals.

32.1 Connecting the HD equipment

Important: For the TV to function in the HD mode, the following steps must be taken.

- 1 Connect the HDMI or DVI output of your HD equipment to the **HDMI 1** or **HDMI 2** connector of the TV. Use a DVI to HDMI cable if DVI output is connected. You can also connect the Component Video Outputs (Y, Pb, Pr) of the HD equipment (if any) to the Component Video Inputs (Ext 4) of the TV.
- 2 Connect the audio cable to the Audio jack of the HD equipment and to the L / R Audio jacks (**EXT3**) of the TV .
- 3 Press the **AV** key to display Source List and use the **▲ ▼** key to select **HDMI 1** or **HDMI 2** (or EXT 4 if you using YPbPr connection).

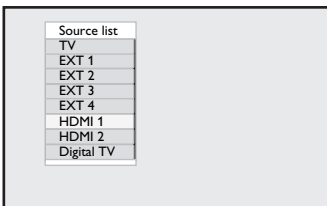

- 4 Press the **▶ / OK** key to switch to the selected source.

32.2 Control TV settings while in HD mode

- 1 Press the **MENU TV** key to display the main menu.
- 2 Press the **▲ ▼** keys to select **Picture**, **Sound** or **Features** and the **▶ / OK** key to enter the selected item menu.
- 3 Press the **▲ ▼** key to select the settings and the **◀ ▶** key to select or adjust setting.
- 4 To return to previous menu, press the **◀** key.
- 5 To exit the menu, press the **MENU TV** key.

Picture menu

- The Picture menu comprises **Brightness**, **Colour**, **Contrast**, **Sharpness**, **Colour Temp.**, **Contrast+**, **Horizontal Shift**, and **Vertical Shift**.
- Except for the **Horizontal Shift** and the **Vertical Shift** features, all the other functions work exactly in the same way as the features in the TV Picture menu (see page 37).
- **Horizontal Shift** feature allows you to adjust horizontal position of the image.
- **Vertical Shift** feature allows you to adjust vertical position of the image.

Sound menu

- The Sound menu comprises **Equalizer**, **Balance**, **AVL** and **Incredible Surround** features and work exactly in the same way as the TV Sound menu (see page 37).

Features menu

- The Features menu comprises **Timer**, **Child Lock**, **Parental Lock**, **Mode Selection** and **Active Control** features. Except for **Mode Selection** feature, all the other features work exactly in the same way as the TV Sound menu (see pages 34-36).
- When you connect HD (High Definition) equipment supporting resolutions of **480p** or **720p**, the **Mode Selection** feature will be available in the Features menu. This will allow you to select between the **PC** and **HD** mode.

32.3 Supported formats

HD format

480p, 480i, 576p, 576i, 720p, 1080i
1080p (applicable to 47" LCD TV only).

SD format

480i, 576i

Note

Your Philips TV is HDMI compliant. If you do not get a good picture, please change the video format on your device (DVD player, cable set-top box, etc.) to a standard format. For example, for DVD player, select 480p, 576p, 720p or 1080i.

Please note that this is not a defect of the TV set.

33 Connecting other equipment

33.1 Overview of connections

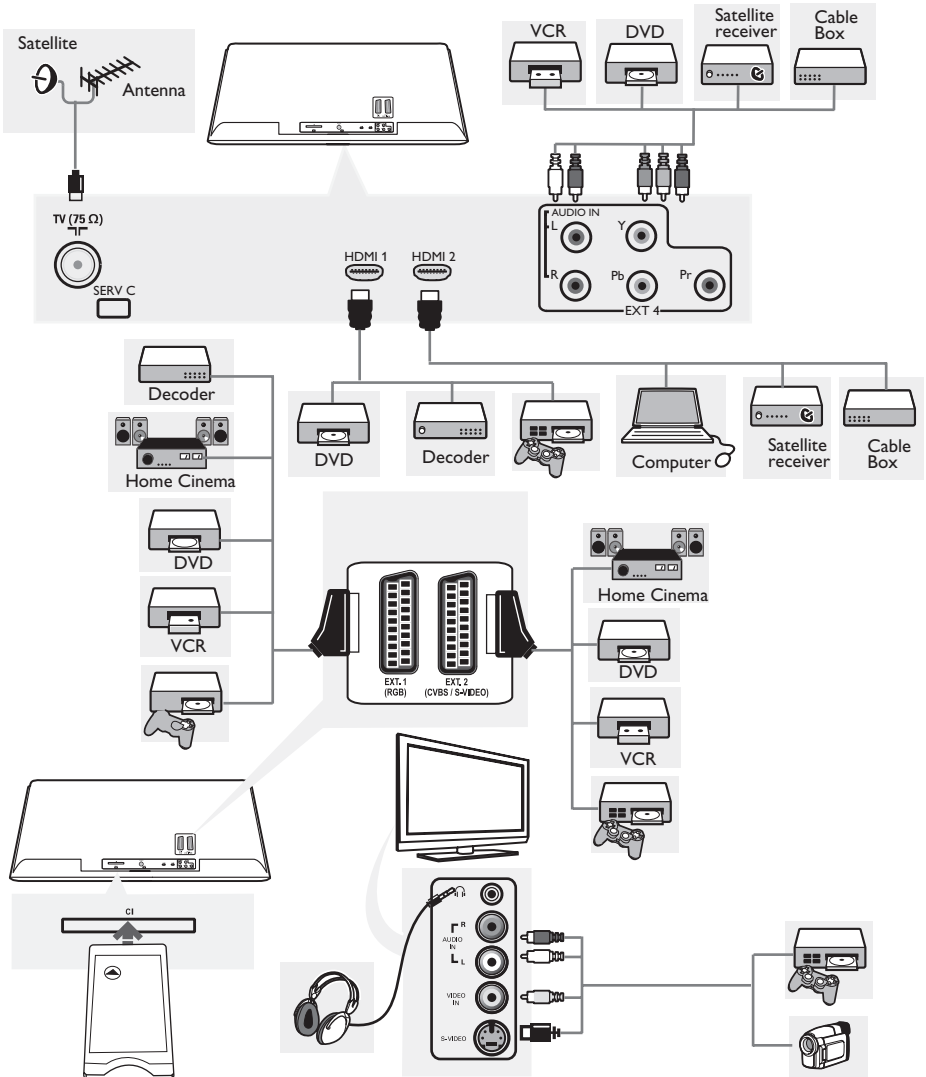

33.2 Connect VCR or DVD recorder

With a eurocable

- 1 Connect the aerial cables ① and ② as shown.
- 2 Connect the eurocable ③ as shown.
- 3 Press the **AV** key on the remote control display Source list.
- 4 Press the **▼** key repeatedly to select **EXT2** and press the **▶ / OK** key to confirm selection.

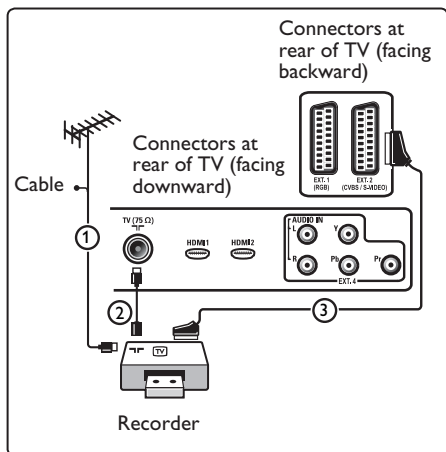

With the aerial cable only

- 1 Connect the aerial cables ① and ② as shown.
- 2 Tune in your recorder's test signal and store the test signal under programme number 0.
(See "Manual tuning of analogue programmes", page 29. See also the user manual of your recorder).

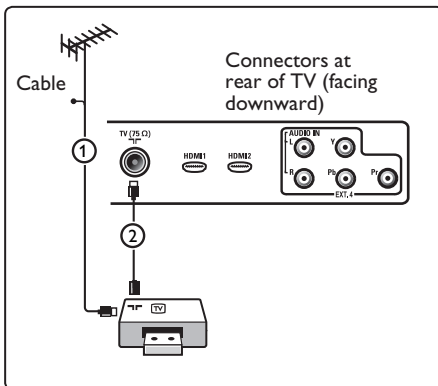

33.3 Connect Decoder and VCR

Connect a eurocable ④ to your decoder and to the special euroconnector of your recorder. See also the user manual of your recorder.

⚠ Warning

Do not place your recorder too close to the screen as some recorders may be susceptible for signals from the display. Keep a minimum distance of 0,5 m from the screen.

✳ Tip

You can also connect your decoder directly to **EXT1** or **EXT2** with a eurocable.

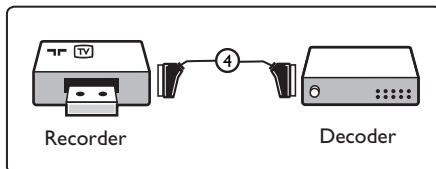

33.4 Connect 2 VCRs or VCR and DVD recorder

With eurocables

- 1 Connect the aerial cables ①, ② and ③ as shown.
- 2 Connect your VCRs or DVD-recorder to **EXT1** and **EXT2** with the euro cables ④ and ⑤.
- 3 Press the **AV** key on the remote control to display Source list.
- 4 Press the **▼** key to select **EXT1** or **EXT2** and press the **▶/OK** key to confirm selection.

With the aerial cables only

- 1 Connect the aerial cables ①, ② and ③ as shown.
- 2 Tune in your recorder's test signal and store the test signal under programme number 0.
(See "Manual tuning of analogue programmes", page 29. See also the user manual of your recorder).

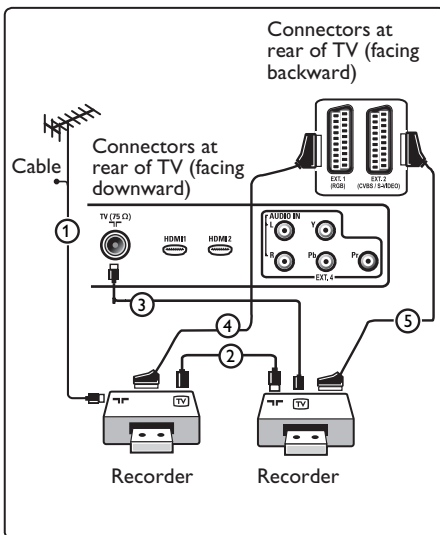

33.5 Connect a satellite receiver

With a eurocable

- 1 Connect the aerial cables ① and ② as shown.
- 2 Connect your satellite receiver to **EXT1** or **EXT2** with a eurocable ③.
- 3 Press the **AV** key on the remote control to display Source list.
- 4 Press the **▼** key to select **EXT1** or **EXT2** and press the **▶/OK** key to confirm selection.

With Component Video connectors

See "Connect a DVD player, a satellite receiver or a cable box", see page 48.

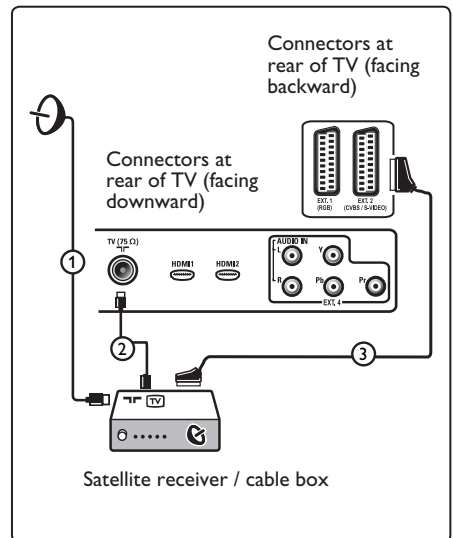

33.6 Connect a DVD player, Cable box or game console

With a HDMI connector

HDMI is the leading new standard for Digital video and audio inter-connection.

- 1 Connect your equipment with the HDMI connector.
- 2 Press the **AV** key on the remote control to display Source list.
- 3 Press the **▼** key to select **HDMI 1** or **HDMI 2** and press the **▶/OK** key to confirm selection.

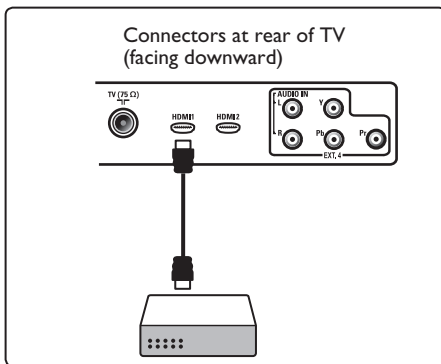

3 Press the **AV** key on the remote control to display Source list.

4 Press the **▼** key to select **EXT 4** and press the **▶/OK** key to confirm selection..

5 In case of a cable box and/or a satellite receiver also connect the cable TV cable and/or the satellite antenna cable ③ and the aerial cable ④ .

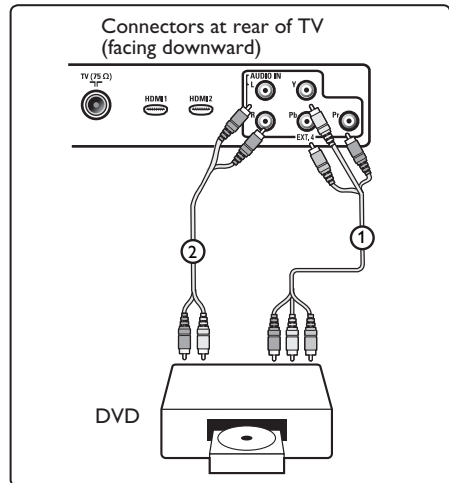

33.7 Connect a DVD player, a Satellite receiver or Cable box

With Component Video Connectors

- 1 Connect the three separate component video cables ① to the YPbPr jacks on the DVD player and to the Y (yellow), Pb (blue) and Pr (red) jacks of **EXT4** on the TV.
- 2 Connect the audio cable to the DVD's audio L and R jacks and to the L/R AUDIO jack of **EXT4** ② .

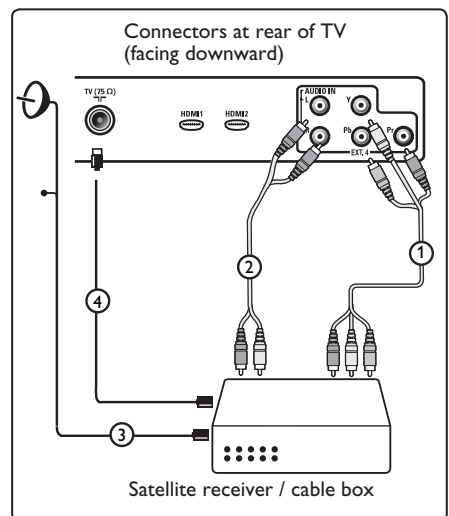

Note

- Cables are often colour coded. Connect red to red, white to white, etc.;
- The labels for the component video sockets may differ depending on the DVD player connected. Although the abbreviations may vary, the letters B and R stand for the blue and red component signals, respectively, and Y indicates the luminance signal. Refer to the DVD player's instructions for use for definitions and connection details;
- To get an optimal viewing, it is advised to switch your equipment to the highest possible supported display modes.

Warning

in case you notice scrolling images, wrong colours or no colour, no picture, or even combinations of these on your screen, verify if the connections are done in the correct way and if the resolution and the signal standard of the connected equipment are set in the right way. See the user manual for your equipment.

33.8 Connect a PC

Note

- Only digital output of the PC can be connected via DVI to HDMI cable.
VGA connection is not supported.
- Before connecting your PC to the TV, select your PC monitor settings to a refresh frequency of 60 Hz.

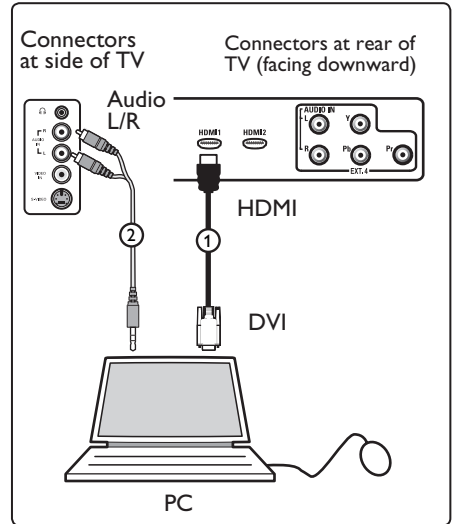

PC equipped with a DVI connector

- 1 Use a DVI to HDMI cable to connect to one of the HDMI connector of your TV ①.
- 2 Connect the audio cable to the PC's AUDIO jack and to the L/R AUDIO jacks of TV **EXT3** ②.
- 3 Press the **AV** key on the remote control to display Source list.
- 4 Press the **▼** key to select **HDMI 1** or **HDMI 2** and press the **▶/OK** key to confirm selection.

Supported PC resolutions

640 x 480, 60 Hz	800 x 600, 75 Hz
640 x 480, 72 Hz	800 x 600, 85 Hz
640 x 480, 75 Hz	1024 x 768, 60 Hz
640 x 480, 85 Hz	1024 x 768, 70 Hz
800 x 600, 60 Hz	1024 x 768, 75 Hz
800 x 600, 72 Hz	1024 x 768, 85 Hz

(Applicable to LCD TV only)

1280 x 768, 60 Hz
1280 x 1024, 60 Hz
1360 x 768, 60 Hz

33.9 Connect a Camera, Camcorder, Game console

- 1 Connect your camera, camcorder or game console.
 - 2 For mono equipment, connect to **VIDEO** (2) and **AUDIO L** (3) (only). For stereo equipment, connect both **AUDIO L** and **AUDIO R** (3). S-VHS quality with an S-VHS camcorder is obtained by connecting the S-VHS cables with the S-VIDEO input (1) and **AUDIO L / R** inputs (3).
- ⚠ Warning:** do not connect cables (1) and (2) at the same time. This may cause picture distortion.
- 3 Press the **AV** key on the remote control to display Source list.
 - 4 Press the **▼** key to select **EXT 3** and press the **▶/OK** key to confirm selection..

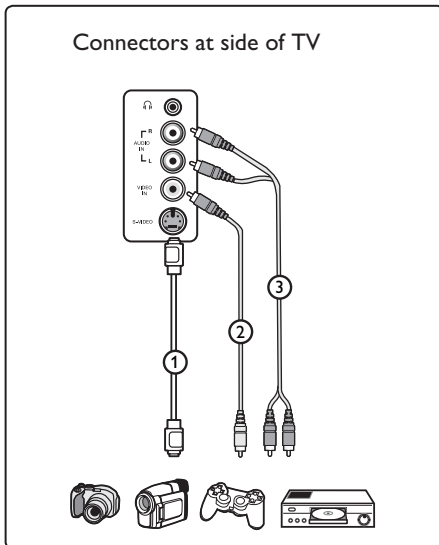





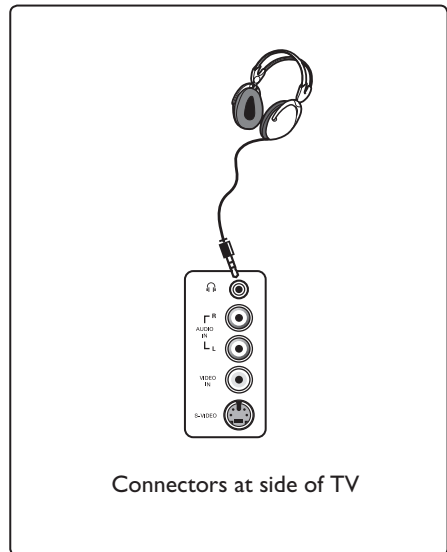









33.9.1 Connect a Headphone





- 1 Insert the plug into the headphone socket as shown.
 - 2 The headphone impedance must be between 8 and 4000 Ohm. The headphone socket has a 3.5 mm jack.
- * Tip**
Press the **⊗** key on the remote control to switch off the sound from internal loudspeakers of the TV. To switch on sound, press the **⊗** key again.



34 Troubleshooting

Below is a list of symptoms you may encounter with your TV. Before you call for service, make these simple checks.

Symptom	Possible solutions
No display on screen	<ul style="list-style-type: none"> • Check whether power cord is properly connected into the mains socket and to your TV. If there is still no power, disconnect plug. Wait for 60 seconds and re-insert plug. Switch on TV again. • Press the  key on the remote control.
Poor reception (snowy noise)	<ul style="list-style-type: none"> • Check antenna connection to the TV and to the wall antenna socket. • Try manually adjusting your picture (see page 30). • Have you chosen the right TV system? (see to page 30). • Press the  key to check the signal strength.
No picture	<ul style="list-style-type: none"> • Verify if the supplied cables are connected properly (The aerial cable to the TV, the other aerial to your recorder, the power cables,...). • Verify if you have selected the correct source. • Verify if the child lock has been switched off.
No sound on certain channels	<ul style="list-style-type: none"> • Check whether the correct TV system is selected (see page 30).
No sound	<ul style="list-style-type: none"> • Verify if the volume is not at the minimum. • Check that the mute () mode is not on. If mute mode is on, press the  key to deactivate mute mode. • Verify the connections between the optional equipment and the TV.
Sound interference	<ul style="list-style-type: none"> • Try switching off any electrical appliances to prevent interference, for example, hairdryer, vacuum cleaner.
Unable to understand the selected language on screen to operate set in digital mode	<ul style="list-style-type: none"> • Press the  key to exit menu from screen. • Press the  key again to display menu. • Press the  key to select the second item on the menu and the  key to enter into the next menu level. • Press the  key again and use the  key to select the fifth menu item. • Press the  key to enter into the next menu level. • Press the   keys to select correct language. • Press the  key to confirm selection. • Press the  key to exit menu.
TV not responding to remote control	<ul style="list-style-type: none"> • Move closer to the receiver at the front of the TV. • Check the placement of the batteries. • Try changing the batteries.

Symptom	Possible solutions
No digital channels	<ul style="list-style-type: none"> Contact your dealer about the Digital Video Broadcasting Terrestrial signal availability in your country.
One or a few tiny spots on the screen that do not change colour along with the video picture	<ul style="list-style-type: none"> This symptom is not a problem. The liquid crystal panel is built with very high precision technology giving you the fine picture details. Occasionally, a few non-active pixels may appear on the screen as a fixed point of red, blue, green or black. ⊖ Note : this does not affect the performance of the set.
Intermittent or flickering picture in HD mode	<ul style="list-style-type: none"> Noise is displayed if the connected digital equipment such as DVD player or Set-Top box failed. Check user manual of the digital equipment you are connecting. Use a standard-compliant (high-quality) HDMI to DVI cable.
No sound or picture but front panel red light is on	<ul style="list-style-type: none"> Press the  key on the remote control.
PC modes do not work	<ul style="list-style-type: none"> Check whether connections are correct. (see page 49). Check whether the source is correctly selected. Press  button to enter Source list and select the correct source. Check whether you have configured the computer to a compatible display resolution (see page 49). Check graphic card setting of PC.
S-Video colour becomes faint	<ul style="list-style-type: none"> Check whether SVHS cable is properly connected. Press the P + key on the remote control to do a channel up and then press the P – key to do a channel down.
Black bar on top and bottom of screen in PC mode	<ul style="list-style-type: none"> Change PC refresh rate to 60 Hz.
AC3 not available	<ul style="list-style-type: none"> AC3 is not supported for this set. Use the  key on the remote control to select an alternative audio.
TV antenna cannot be powered by set	<ul style="list-style-type: none"> Some TV antennas need to be powered by the set. This set does not support such a feature.
Changing from one channel to another channel takes a long time	<ul style="list-style-type: none"> Pay TV channels are encoded by the cable provider and take a longer time to decode. This is normal behaviour and no action is required.
Cannot access digital menu	<ul style="list-style-type: none"> Check whether TV is in analogue mode. If it is, press  key to switch to digital mode.

DVI (Digital Visual Interface) : A digital interface standard created by the Digital Display Working Group (DDWG) to convert analog signals into digital signals to accommodate both analog and digital monitors.

RGB signals : These are the three video signals, Red Green Blue, which make up the picture. Using these signals improves picture quality.

S-VHS signals : These are 2 separate Y/C video signals from the S-VHS and Hi-8 recording standards. The luminance signals Y (black and white) and chrominance signals C (colour) are recorded separately on the tape. This provides better picture quality than with standard video (VHS and 8 mm) where the Y/C signals are combined to provide only one video signal.

16:9 : Refers to the ratio between the length and height of the screen. Wide screen televisions have a ratio of 16/9, conventional screen TV sets have a ratio of 4/3.

MHEG (Multimedia and Hypermedia information coding Expert Group) : provides standards for the coded representation of multimedia and hypermedia information objects that are interchanged among applications and services using a variety of media. The objects define the structure of a multimedia hypermedia presentation.

HDMI (High-Definition Multimedia Interface) : Provides an uncompressed, all digital audio/video interface between the TV and any HDMI-equipped audio/video component, such as set-top box, DVD player and A/V receiver. HDMI supports enhanced or high-definition video plus two-channel digital audio.

System : Television pictures are not broadcast in the same way in all countries. There are different standards: BG, DK, I, and LL'. The System setting (page 24) is used to select these different standards. This is not to be confused with PAL or SECAM colour coding. PAL is used in most countries in Europe, SECAM in France, Russia and most African countries. The United States and Japan use a different system called NTSC.

MPEG (Moving Picture Experts Group) is the nickname given to a family of International Standards used for coding audio-visual information in a digital compressed format.

Information for users in the UK (not applicable outside the UK)

Positioning the TV

For the best results, choose a position where light does not fall directly on the screen, and at some distance away from radiators or other sources of heat. Leave a space of at least 5 cm all around the TV for ventilation, making sure that curtains, cupboards etc. cannot obstruct the air flow through the ventilation apertures. The TV is intended for use in a domestic environment only and should never be operated or stored in excessively hot or humid atmospheres.

General Points

Please take note of the section entitled 'Tips' at the end of this booklet.

Interference

The Department of Trade and Industry operates a Radio Interference Investigation Service to help TV licence holders improve reception of BBC and IBA programmes where they are being spoilt by interference. If your dealer cannot help, ask at a main Post Office for the booklet "How to Improve Television and Radio Reception".

Mains connection

Before connecting the TV to the mains, check that the mains supply voltage corresponds to the voltage printed on the type plate on the rear panel of the TV. If the mains voltage is different, consult your dealer.

Important

This apparatus is fitted with an approved moulded 13 AMP plug. Should it become necessary to replace the mains fuse, this must be replaced with a fuse of the same value as indicated on the plug.

- 1** Remove fuse cover and fuse.
- 2** The replacement fuse must comply with BS 1362 and have the ASTA approval mark. If the fuse is lost, make contact with your retailer in order to verify the correct type.
- 3** Refit the fuse cover.
If for any reason the fitted plug is not suitable for your socket outlet, please consult your retailer or a qualified electrician before proceeding with the installation.

Connecting the aerial

The aerial should be connected to the socket marked : at the back of the set. An inferior aerial is likely to result in a poor, perhaps unstable picture with ghost images and lack of contrast. Make-shift loft or set-top aerials are often inadequate. Your dealer will know from experience the most suitable type for your locality. Should you wish to use the set in conjunction with other equipment, which connects to the aerial socket such as TV games, or a video camera it is recommended that these be connected via a combiner unit to avoid repeated connection and disconnection of the aerial plug.

Fitting the stand (if provided)

Use only the stand provided with the set, making sure that the fixings are properly tightened. A diagram showing how to assemble the stand is packed with the stand. Never use a make-shift stand, or legs fixed with woodscrews.



© 2006 Koninklijke Philips N.V.

All rights reserved

Document order number: 3139 125 38321