



www.unifap.com.br

Porta-escovas
Brush Holders

Polias
Pulleys

Polias Roda-Livre
Free Wheel Pulleys

Garfos
Engaging Levers

Planetárias
Planetary Gears

**Articulação de Acionamento para
Limpador de Parabrisas**
Window Wiper Linkage Transmission

Buchas Sinterizadas
Sintered Bushes

2013/14 Peças Automotivas
Automotive Parts





- ● ● Fundada em 27 de março de 1992, pelos irmãos Ivo e Nelson Bittencourt, a UNIFAP INDÚSTRIA METALÚRGICA LTDA deu início às suas atividades com o objetivo de atuar no ramo de peças automotivas, tendo como princípio fabricar produtos de alta qualidade, a preços justos.

Fiel a este princípio, a empresa cresce ano a ano, e conta hoje com instalações de 5.600 m² de área construída, numa área total disponível de 335.000 m². Localizada ao sul do país, na cidade de Gaspar, estado de Santa Catarina, a empresa tem uma das maiores linhas do segmento, o que a coloca entre as principais do setor no país, sendo os principais produtos:

- Porta escovas para motores de partida;
- Porta escovas para alternadores;
- Porta escovas para limpadores de pára-brisa;
- Planetárias para motores de partida;
- Garfos para motores de partida;
- Polias para alternador e dínamo;
- Articulação de acionamento para limpador de parabrisas;
- Buchas Sinterizadas;
- Abraçadeiras para sistema de escapamento;

Comprovando a preocupação da marca UNIFAP em oferecer produtos de excelente qualidade, a mesma já é encontrada em todos os países da América do Sul, e continua expandindo fronteiras, como África, Egito, Europa e América do Norte. Em busca de novos mercados, a empresa mantém-se atualizada com as inovações e exigências, tanto do mercado interno quanto externo, através da participação em exposições e feiras no ramo de autopeças.

Segura de seus objetivos, a UNIFAP investe constantemente em projetos, ferramentaria, implantação da certificação de qualidade ISO, automação e máquina, visando atender cada vez melhor seus clientes.

Por tudo isso, a UNIFAP é hoje uma empresa sólida, baseada em anos de experiência em sua área, que transmite segurança a todos os seus clientes, fornecedores e colaboradores.

- ● ● UNIFAP INDÚSTRIA METALÚRGICA LTCA. was founded on March 27, 1992 by the brothers Ivo and Nelson Bittencourt, with the purpose of manufacturing automotive electrical parts.

Aiming at producing high quality products with fair prices the company has been growing on a yearly basis, settled in 5.600 sq. meter-plant, in a total area of 335.000 sq. meters.

The company is located in Gaspar, province of Santa Catarina, in the south of Brazil. Today it has one of the largest lines, placing UNIFAP among the top manufactures of the sector, being the main products:

- Brush holder for starter, alternators and othe;
- Planetary gears;
- Engaging levers for starter motors;
- Pulleys for alternator and dynamo;
- Window wiper linkage transmission;
- Sintered Bushes;
- Clamps for exhaust system;

UNIFAP parts can now be found in all the contries of South America, and it continues to expand borders in África, Egypt, Europe and North America.

The company keeps updated with the market demands, taking part in the most, important international fairs, and constantly investing in projects, tooling, quality certification and technology, always diligent in assisting customers effectively.

All these has made UNIFAP a solid company, based on years of experience, providing guaranted satisfaction to both customers and suppliers.



www.unifap.com.br

Bosch



UF - 1.101
UF - 1.101/2 2 escovas / brushes
UF - 1.101/4 4 escovas / brushes

Especificações / Features: 12V, Tipo / Type: EF - Escova / Brush: 7 x 10 x 18

Original: 9 001 082 518, 9 001 082 239

Partida / Starter: 9 000 082 028/ 033/ 042/ 046/ 049/ 051/ 053/ 054/ 059/ 061/ 064/ 066/ 069/ 070/ 073/ 074/ 078/ 079/ 082/ 083, 0 001 211 219, (9 000 082 045), 9 000 ALO 301, F 000 ALO 306 / 329

Aplicação / Application: **AGRALE-DEUTZ:** 4100, M70 / 80 / 85 / 90 / 93ID, TX1100, **CHEVROLET-GM:** CHEVETTE, HATCH, CHEVY 500, MARAJÓ, FIAT: PREMIO / RALLY / SPAZIO, DUNA 60 / 70 / WEEKEND, UNO 1.1 / MILLE / ELX / EP, 147 FIORINO 1.5, ELBA 1.5, PRÊMIO 1.5, UNO 1.5 / 1.6, 147 / 147 CITY / EUROPA / FIORINO / GLS / OGGI / PANORAMA / PICK-UP / ELBA 1.5, TEMPRA 2.0 MPI / SPI 16V / 8V, TEMPRA 2.0 TURBO, TIPO 1.6 i.e., UNO 1.6 MPI, **FORD:** BELLINA 1.8, DEL REY 1.8, PAMPA 1.8, ROYALE 1.8 / 2.0, VERSAILLES 1.8 / 2.0, **GURGEL:** BR 800, TOCANTINS L, TR, **VOLKSWAGEN:** SEDAN, SUPERMINI, KARMANN GHIA 1600, SP, 600 / 1700, VARIANT II 1600, BRÁSLIA 1.3/1.6, FUSCA 1300 / 1500 / 1600, 302, 307, 309, GOL 1.8, KOMBI 1.6, GOL 1.0, GOL II 1.0i, II / III / 1.6, SAVEIRO 1.6, VOYAGE 1.6, 1.6, SAVEIRO 1.6, VOYAGE 1.5 / 1.6, QUANTUM 2.0i, SANTANA 2.0i, **YANMAR:** BT22 / 23MICROTRATORES CT 11 / TC 11 SUPER, **LADA:** NIVA 1.5 / 1.6, **MOTORES TIETE:** 950 / 950 L

Bosch



UF - 1.102
UF - 1.102/2 2 escovas / brushes
UF - 1.102/4 4 escovas / brushes

Especificações / Features: 12V, Tipo / Type: MPB - Escova / Brush: 8,8 x 19 x 22

Original: 9 001 453 023 (246007-WAPSA)

Partida / Starter: 9 000 453 020, 9 000 453 033, 9 000 453 034, 9 000 453 041, 9 000 453 044, 9 000 453 046, 9 000 453 047, 9 000 453 050, 9 000 453 053, 9 000 453 054, 9 000 453 060, 9 000 453 061

Aplicação / Application: **CHEVROLET-GM:** A60/A70/A80/A90; CAMINHÕES c/ PERKINS 4 Cil./6 Cil, **FORD:** CARGO WORLD TRUCK 1113; F 1000/2000/4000/7000/11000/12000/13000/19000/21000/22000, TRATORES 4600 / 5600 / 6600, F 4000; F 11000 / 12000 / 13000, **VOLKSWAGEN:** SÉRIE 7T-7.90S/7.110S; SÉRIE 12T - 12.140H; SÉRIE 7T-7.140 / 11T-11.160 / 12T-22.160, **FIAT-ALLIS:** FB 80.2, **NEW HOLLAND:** 4630/5030/5630/6630/7630/7830/8030, **CASE:** TRATOR ESCAVO CARREGADOR W7 c/ PERKINS 6 Cil., TRATOR RETRO-ESCAVADOR 580E / 580CK, **CBT:** TRATORES 1090 / 1100 c/ PERKINS 6 Cil., **CHRYSLER:** CAMINHÕES P-700 c/ PERKINS 6 Cil., **CLARK:** EMPILHADEIRA/ FORKLIFT C300 HY 40/50/60, TRATORES MICHIGAN 75A II / III, **EATON:** EMPILHADEIRA/ FORKLIFT D83P / D83C / D87P, PÁ-CARREGADEIRA 250A / 1900; **HYSTER:** EMPILHADEIRA/ FORKLIFT c/ PERKINS 4203 / 4236 4 Cil., **MASSEY-FERGUSON:** TRATORES 95 X / 95 L; MOTOR INDUSTRIAL - PERKINS, MF 295/4 / 296 / 296/4; MF 3000 / 3366 / MF-400; MF-200 / MF-296

Bosch



UF - 1.103
UF - 1.103/2 2 escovas / brushes
UF - 1.103/4 4 escovas / brushes

Especificações / Features: 12V, Tipo / Type: MPB - Escova / Brush: 8,8 x 19 x 18, Pólos invertidos / Inverted poles

Original: 9 001 453 024 (246005 WAPSA)

Partida / Starter: 9 000 453 048, 9 000 453 013, WAPSA 224030 (MPB 25)

Aplicação / Application: **AGRALE-DEUTZ:** 400 - 440 c/ motor AGRALE M790; 4000 - 4200 c/ motor AGRALE M790, **FORD:** MAVERICK V8 302

Bosch



UF - 1.104
UF - 1.104/2 2 escovas / brushes
UF - 1.104/4 4 escovas / brushes

Especificações / Features: 12V, Tipo / Type: JF - Escova / Brush: 10 x 22 x 23,5

Original: 9 001 083 392, 9 001 083 362

Partida / Starter: 9 000 083 053, 9 000 083 061, 9 000 083 055, 9 000 083 056, 9 000 083 058, 9 000 083 059

Aplicação / Application: **AGRALE-DEUTZ:** BX 4.60 / BX 60, 5000D / 6150 / 7000D / 7500TD / BX 100 / BX130, BX 4.90 / BX 4.100 / BX 4.110 / BX 4.130 / BX 4.150 / BX 90, **CASE:** W18 / W20 / W20B, **CBT:** 1065 / 1105 / 2080 / 2105 / 8060 4X4, **MERCEDES-BENZ:** L608D / 610 / L1013 / L1111/1113 / L1313/1313A/ L1316/1316A / L1516 / L2013/2016 / L2213/2215/2216; O 362, **SLC:** 6200 / 6200 TURBO; 7200 TURBO / 7700 TURBO / W18 / W20 / W20B, OM 366 A / C / LA, SÉRIE 9T-917 / OF1113 / OH1112, SÉRIE 7000 - 7700 TURBO, **KOMATSU:** D90E / D50A, **CBT:** 2105, 8000/8240, **CHEVROLET-GM:** D20/D20 PLUS / D6000, **MASSEY-FERGUSON:** MF-275 / 275-4 / 283 / 290 / 290-4 / 292, MF 295 / 295/4; 296 / 296/4 Turbo, MF1630/ 3640/ 5650/ 6845/ 6855/ 6865, **CASE:** 80 CR / 80 P, **CBT:** 8260 4X4 , 8000 - 8440, **FIAT-ALLIS:** FB 80, **MWM-DIESEL:** SÉRIE D / TD, **VALMET:** 65ID / 68 / 68 CAFFEEIRO / 68 ESPECIAL / 78S / 78 VE / 88 / 110ID / 118 / 118-4 / 128 / 128 4X4 / 138 TURBO / 138-4 TURBO / 148 4X4 / 148 TURBO / 880 / 880 4X4 / 980 4X4 TURBO, **JOHN DEERE:** JD 50 D, **MAXION:** IDEAL 9070/9075/9090; 9110 / 9130 / 9150 / 9170, **YANMAR:** BT / BTD / 1050.D / 1050.D 4X4

Bosch

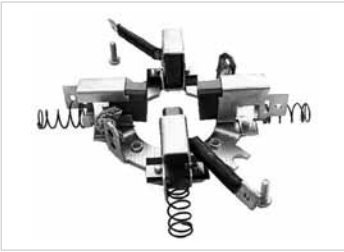

UF - 1.105
UF - 1.105/2 2 escovas / brushes
UF - 1.105/4 4 escovas / brushes

Especificações / Features: **12V, Tipo / Type: JF - Escova / Brush: 10 x 22 x 19**

Original: 9 001 083 569

Partida / Starter: 9 000 083 053, 9 000 083 054, 9 000 083 055, 9 000 083 056, 9 000 083 059, 9 000 083 061, 9 000 083 062, 9 000 083 069, 9 000 083 071, 9 000 083 072, 9 000 083 074, 9 000 083 075, 9 000 083 077, 9 000 453 072, 9 000 453 074, 9 000 453 076, 9 000 453 080, 9 000 453 082, 9 000 453 083, 9 000 453 089, 9 000 453 090, 9 000 453 091, F 006 AL0 602

Aplicação / Application: **AGRALE-DEUTZ:** BX 4.60 / BX 60, AX 4100/4190/100S/120S/80S, SÉRIES 5000 / 6000 / 7000 / BX, 1800 D / TX 1600, 7000 DX/TDX / 8500 TDX / MA 7.5 T, 6.150, **CASE:** W 18 / W20 / W20B, 80 CR / 80 P, W 20 E, 580H / SH 4X2, / 4X4, 580L, **CBT:** 1065 / 1105; 2080 / 2105; 8060 4X4, 8240, 8440, 8260 4X4, 2105, **PERKINS:** TRATORES, **MERCEDES-BENZ:** SÉRIES 6tL / 7t / 7tL / 8tL / 9t / 10t / 11tL / 12t / 12tL

/ 13tL / 14tL / 15tL / 16tL / 17t / 20tL / 22tL / 23tL / 24t / O / OF / OH / OM, OM 366 A / C / LA, 917 / OF1113 / OH1113, MOTOR ESPECIAL DRESSER (à prova de óleo), **NEW HOLLAND:** 8040 / 8055, TC 55 / TC 57 / TC 59 / TM 120, TRATOR GAMALTA, **TOYOTA:** BANDEIRANTE OM 364 (01.91->12.01), **CHEVROLET-GM:** D20 / D 6000, **MASSEY-FERGUSON:** MF1630 / MF3640 / MF5650 / MF6845/55/65, MF295 / 295/4 / 296 / 296/4, MF235 / 265 / 296/5, **MAXION:** IDEAL 9075 / 9090, IDEAL 9070 / 9075 / 9110 / 9130 / 9150 / 9170, **FIAT-ALLIS:** FB 80, **MWM-DIESEL:** D 229-4 / D 229-5 / TD 229-6, D 229-3/229-4/229-6 / TBD / TD **SLC:** 7700 TURBO, **VALMET:** SÉRIES 62/ 65/ 68/ 78/ 88/ 110/ 118/ 128/ 138/ 148/ 880/ 980, 885S / 985S / 1180S / 1380S / 1680S / 1880S, 62 / 65 / 85 / 110 / 685, 1180, 785 / 885 / 985 / 1280 / 1580 / 1780, **MÜLLER:** VIBRO RT 62 / 82, TM 12/14, **JOHN DEERE:** JD 50 D, **KOMATSU:** D30E / D50A, RETRO ESCAVADEIRA DE ESTEIRAS, **YANMAR:** TRATOR 1050, BT / BTD / 1050.D / 1050.D 4X4, **FORD:** F 4000, CARGO WORLD TRUCK C, **PUMA:** 7900 / 7900 T, 914, **VOLKSWAGEN:** SÉRIES 7 t / 8 t / 9 t / 12 t / 13 t / 14 t / 15 t / 16 t / 17 t, 16.200 / 16.170 BT

Bosch



UF - 1.106
UF - 1.106/2 2 escovas / brushes
UF - 1.106/4 4 escovas / brushes

Especificações / Features: **12V, Tipo / Type: JE - Escova / Brush: 9 x 36 x 18**

Original: 9 001 453 640

Partida / Starter: 9 000 453 029, 9 000 453 067

Aplicação / Application: **CASE:** W 36 B TURBO, **CUMMINS:** CT - 6 CT-8.3, **KENWORTH:** 13.210 / 22.210, **PETERBILT:** 13.210 / 22.210 / 23.210, **VOLKSWAGEN:** 16 t - 16.210, **MERCEDES-BENZ:** 16 t L - L.1625; 18 t L - LG1825; 23 t L - L/LB/LK2325

Bosch



UF - 1.107
UF - 1.107/2 2 escovas / brushes
UF - 1.107/4 4 escovas / brushes

Especificações / Features: **12V, Tipo / Type: MWB - Escova / Brush: 7 x 10 x 17**

Original: 9 001 451 052 (246012 WAPSA)

Partida / Starter: 9 000 451 017

Aplicação / Application: **FORD:** ESCORT - ÁLCOOL E TRANSMISSÃO AUTOMÁTICA / AUTOMATIC TRANSMISSION

Bosch



UF - 1.110/2 2 escovas / brushes
UF - 1.110/4 4 escovas / brushes

Especificações / Features: **12V, Tipo / Type: MPB - ESCOVA CURTA / SHORT BRUSH - Escova / Brush: 8,8 x 19 x 13**

Original: 9 001 453 025 (WAPSA)

Partida / Starter: 9 000 453 016, 9 000 453 038, 9 000 453 045, 9 000 453 049, 9 000 453 051, 9 000 453 052

Aplicação / Application: **CASE:** 580 - 580 H; **CBT:** TRATOR - 1000; **HYSTER:** EMPILHADEIRA/ FORKLIFT COM MOTOR GM 2500 4 Cil. / GM 4100 6 Cil., **MASSEY-FERGUSON:** MF 200 - 283, MF 200 - 290; MF 5000 - 5300, COLHEITADEIRA / COMBINE 220, MF 200 - 275 / 285 / 290, TRATOR 85 X, TRATOR 65R

Bosch



UF - 1.111/2 2 escovas / brushes
UF - 1.111/4 4 escovas / brushes

Especificações / Features: **12V, Tipo / Type: MPB - Escova / Brush: 8,8 x 19 x 18**

Original: 9 001 453 023 (246007 WAPSA)

Partida / Starter: 9 000 453 020 /033 /034 /041 /044 /046 /047 /050 /053 /054 /060 /061
Aplicação / Application: **CHEVROLET-GM:** A60 / A70 / A80 / A90, CAMINHÃO C/ PERKINS 6/4 CIL, **FORD:** CARGO WORLD TRUCK 1113; F 2000 / 4000 / 7000 / 11000 / 12000 / 13000 / 19000 / 21000 / 22000; TRATOR 4600/5600/6600, **VOLKSWAGEN:** 7T - 7.90 S / 7.110 S ; 12T - 12.140 H, 7.140 / 11.160 / 22.160, **CASE:** TRATOR ESCAVO CARREGADOR W7, TRATOR RETRO-ESCAVADOR 580E / 580 CK, **CBT:** TRATOR 1090 / 1100, **CHRYSLER:** CAMINHÃO P-700, **CLARK:** EMPILHADEIRA/ FORKLIFT - C300 HY 40 / 50 / 60, TRATOR MICHIGAN 75A / II / III, **EATON:** EMPILHADEIRA/ FORKLIFT D83P / D83C / D78P, PÁ-CARREGADEIRA 250A / 1900, **FIAT-ALLIS:** FB 80.2, **FORD:** F 11000 / F 12000 / F 13000, F 4000, TRATOR 4600 / 5600 / 6600, **HYSTER:** EMPILHADEIRA/ FORKLIFT com motor Perkins 4203 / 4236 4 Cil., **MASSEY-FERGUSON:** MF 200 - MF 296, MF 295/4 / MF 296 / MF 296/4, MF 3000 - MF-3366 / MF-400, MOTOR INDUSTRIAL PERKINS, TRATOR 95X / 95L, **NEW HOLLAND:** 4630 / 5030 / 5630 / 6630 / 7630 / 7830 / 8030

Bosch



UF - 1.112/2 2 escovas / brushes
UF - 1.112/4 4 escovas / brushes

Especificações / Features: **24V, Tipo / Type: JF - Escova / Brush: 10 x 22 x 23,5**

Original: 9 001 083 392

Partida / Starter: 9 000 083 043, 9 000 083 065
Aplicação / Application: **FIAT:** - 80 / 80S / 120 / 130 / 140 / 8340 / 8360, CAMINHÕES: 80 / 120 / 140, **MERCEDES-BENZ:** - 13 t L - L 1317 , - 15 t L - L 1517, **FIAT-ALLIS:** AD - AD 7 B - 06/1985..., AD - AD 7 B - 12/1984...
DEMAIS ÔNIBUS E CAMINHÕES C/ PARTIDA JF 24V

Bosch

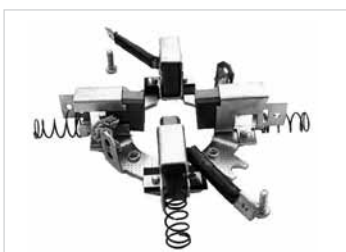

UF - 1.113/2 2 escovas / brushes
UF - 1.113/4 4 escovas / brushes

Especificações / Features: **24V, Tipo / Type: JF - Escova / Brush: 10 x 22 x 19**

Original: 9 001 083 596

Partida / Starter: 9 000 083 043, 9 000 083 054, 9 000 083 063, 9 000 083 064, 9 000 083 065, 9 000 083 066, 9 000 083 068, 9 000 083 073, 9 000 083 076, 9 000 453 075, 9 000 453 079, 9 000 453 086, 9 000 453 088, F 000 ALO 700
Aplicação / Application: **FIAT:** 80 / 80S / 120 / 130 / 140 / 8340 / 8360, **YANMAR:** MOTOR ESTACIONÁRIO E MARÍTIMO, **CASE:** W18 D / W 18 E / W 20 D / W20 E, EL DETALLE: OA 101 - 09/1997..., **MERCEDES-BENZ:** 12 T L - L 1214/1217/1218; 14 T L - L 1414 / 1418, 16 T L - L 1614 / 1618 / 1621, OF 1318/1620, 13 T L - L 1317 / 15 T L - L 1517 ; O 371 U/UL ; OF 1115 /1315 /1721 ; OH 1315 G / OH 1318 / OH 1621 LG / OH 1623 LG, **FIAT-ALLIS:** FG 140 - MOTOR 6 CT 8.3 - 02/1999..., AD 7 B; FA 120; FH 200, FD 9; FR 10 B; FR 12 B, FR 120.2, **VOLVO:** VME L 30, **CASE:** 888 BCKE, 888 CKE, **KOMATSU:** A 835; GD 523 A; GD 523 R, PC 150 SE, RETRO-ESCAVADEIRA PC 150 MODELO 3, **FORD:** CARGO WORLD TRUCK 1618; B 1618; B 1621, **IVECO:** 120 E15; 150; 149 E 18; 150 E 20; 150 E 20 T; 150 T; 160 E 21; 160 E 23; 160 E 23 T, **VOLKSWAGEN:** 16 T - 16.180 CO/16.210 CO; 17T - 17.210 OD/17.240OT, B 16.180; L 80

Bosch



UF - 1.114/2 2 escovas / brushes
UF - 1.114/4 4 escovas / brushes

Especificações / Features: **24V, Tipo / Type: JE - Escova / Brush: 9 x 36 x 18**

Original: 9 001 453 625

Partida / Starter: 9 000 453 068, F 000 ALO 801
Aplicação / Application: **DECAROLI, MERCEDES-BENZ, DEMAIS ÔNIBUS E CAMINHÕES COM PARTIDA JE 24V**

Bosch



UF - 1.115/4 4 escovas / brushes

Especificações / Features: **12V, Tipo / Type: DM/DA - Escova / Brush: 5 x 12 x 11,6, Terminal saída lado esquerdo/Left side terminal.**

Original: F 000 AL1 013, 9 001 081 092

Partida / Starter: 9 000 081 010, F 000 ALO 401 / 306 / 313, F 000 ALO 414, F 000 AL1 919
Aplicação / Application: **CHEVROLET-GM:** CORSA 1.6EFI, **VOLKSWAGEN:** GOL II / III 1.0MI / 16V / TURBO, PARATI II / III / 1.0MI / 16V / TURBO; FUSCA 1300 / 1500 / 1600; GOL 1.3, **GURGEL:** BR 800, TOCANTINS L/TR, **TRANSPORTER:** 1600 / VARIANT / II

Bosch

UF - 1.116/4 4 escovas / brushes

Especificações / Features: **12V, Tipo / Type: DM/DA** - Escova / Brush: 5 x 12 x 11,6 Terminal saída lado direito / Right side terminal.

Original: 1 004 336 809, F 000 AL1 054 / 055 / 283

Partida / Starter: 0 001 107 027 / 028 / 044 / 059 / 063 / 076 / 082, 0 001 113 009, 9 000 081 003, F 000 AL0 003 / 301 / 302 / 304 / 309 / 310 / 314 / 400

Aplicação / Application: **FORD:** ESCORT / ORION 1.6i 16V / KA 1.3i / ESCORT 1.3 / TURNIER / 1.4 / CABRIO / EXPRESS 55/75, **OPEL:** CALIBRA 2.0i TURBO, **CITROEN:** BERLINGO 1.8i / EVASION 2.0i TURBO / XANTIA 1.6 / 1.8 / 2.0i / XM 2.0i / 16V TURBO / XSARA 1.8i / 16V / BREACK / COUPE / 2.0 / 16V / ZX / 1.8i, **FIAT:** DUCATO 10/13/14/18/ULYSSE / PALIO 1.0 8V / UNO MILLE 1.0 SPI / WEEKEND 1.0 8V / STRADA 1.0 8V / DOBLO EX FIRE 1.3i / PALIO 1.0/1.3 MPI 16V / WEEKEND / SIENA / STRADA, **PEUGEOT:** 205/ 306/ 405/ 605/ PARTNER, **VOLVO:** S40/ V40, **CHEVROLET-GM:** CORSA/CELTA, **VOLKSWAGEN:** GOL/ PARATI/ SAVEIRO/ VOYAGE, **MERCEDES-BENZ:** CLASSE A 160

Bosch

UF - 1.117/4 4 escovas / brushes

Especificações / Features: **12V, Tipo / Type: DW/DB** - Escova / Brush: 5 x 12 x 11,6, Terminal saída lado esquerdo / Left side terminal

Original: 1 004 336 801 / 821 / 827 / 951, F 000 AL1 051, F 000 AL1 391

Partida / Starter: 0 001 106 015, 0 001 107 003 / 0 001 107 007 (0 001 108 094) / 0 001 107 016 / 019 / 020 / 021 / 022 / 039 / 054 / 063 / 066 / 068 / 091, 0 001 121 008 / 009, 9 001 081 001

Aplicação / Application: **FORD:** ESCORT/ MONDEO, **CITROEN:** BERLINGO /EVASION /XANTIA /XM /XSARA, **FIAT:** DUCATO 10/ 13/ 14/ 18/ ULYSSE/ BRAVA/ MAREA/ WEEKEND/ BRAVO/ DOBLO/ PALIO/ WEEKEND/ SIENA/ STRADA, **PEUGEOT:** 205/ 306/ 405/ 605/ 806/ PARTNER, **VOLKSWAGEN:** PASSAT IMPORTADO/ GOLF/ BEETLE/ GOL/ LOGUS/ PARATI/ POINTER, **SEAT:** ALHAMBRA/ CITY GOLF/ CORDOBA/ IBIZA, **AUDI:** AUDI A3/ TT/COUPE, **OPEL:** CORSA, **NISSAN:** SENTRA

Bosch

UF - 1.118/4 4 escovas / brushes

Especificações / Features: **12V, Tipo / Type: DW/DB** - Escova / Brush: 5 x 12 x 11,6, Terminal saída lado direito / right side terminal.

Original: F 000 AL0 106, F 000 AL1 053

Partida / Starter: 0 001 107 015 (9 000 081 004), 9 000 081 005 / 006 / 007 / 008, F 000 AL0 104 / 502 / 102

Aplicação / Application: **CHEVROLET-GM:** ASTRA / ASTRA SEDAN / BLAZER / IPANEMA / KADETT / OMEGA / SUPREMA / VECTRA / ZAFIRA, **OPEL:** ASTRA / CALIBRA / OMEGA / VECTRA, **FIAT:** TEMPRA / TURBO, **VOLKSWAGEN:** GOL / PARATI / QUANTUN / SANTANA / SAVEIRO / VOYAGE, **CITROEN:** XSARA / PICASSO

Bosch

UF - 1.119/4 4 escovas / brushes

Especificações / Features: **12V, Tipo / Type: DW** - Escova / Brush: 5 x 12 x 11,6, Terminal saída lado direito / right side terminal

Original: 1 004 336 957, F 000 AL1 052

Partida / Starter: 0 001 107 015, F 000 AL0 100, 0 001 107 045

Aplicação / Application: **CHEVROLET-GM:** ASTRA 1.8/2.0i / SEDAN/ 1.8/2.0i / MPFI / 16V, BLAZER 2.2 EFI / IPANEMA 2.0 MPFI / KADETT 2.0 MPFI / OMEGA 2.0/2.2i; SUPREMA 2.0/2.2/3.0i / S10 EFI/MPFI / VECTRA 2.0/Gsi 16V / ZAFIRA 2.0 / i / 16V, **OPEL:** ASTRA 2.0i / CALIBRA 2.0i Turbo / 16V / OMEGA 1.8 / 2.0 / i / VECTRA 2.0i / 16V / 2000 / 4X4, **FIAT:** FIORINO 1.0 / 1.5 ->95, PALIO 1.6 16V / PALIO WEEKEND 1.0 / 1.5 8V ->96 / 1.6 16V, SIENA, STRADA 1.0 / 1.5 8V ->99, UNO 1.5 / MILLE.

Bosch

UF - 1.124/4 4 escovas / brushes

Especificações / Features: **24V, Tipo / Type: EMT** - Escova / Brush: 8,8 x 19 x 22 - 213/13, Quatro pólos isolados / Four isolated poles

Original:
Partida / Starter: 9 135 081 000

Aplicação / Application: EMPILHADEIRA/ FORKLIFT

Bosch



UF - 1.125/4 4 escovas / brushes

Especificações / Features: **12V, Tipo / Type: DW** - Escova / Brush: 5 x 16 x 13, GIRO SENTIDO HORÁRIO / Clock Wise Rotation, Terminal saída lado direito / Right side terminal.

Original: 1 004 336 806, 1 004 336 960, 1 004 336 968, 1 004 336 998

Partida / Starter: 0 001 108 128/ 026/ 064/ 070/ 080/ 101/ 102/ 121/ 130/ 135/ 136/ 138/ 139/ 140/ 143/ 146/ 155/ 157/ 159/ 166/ 167/ 173/ 176/ 183, F 101 ALO 103

Aplicação / Application: **ALFA ROMEO:** ALFA 155 2.0 T.S./156, BERLINA /SPORT WAGON /164 /166 /SPIDER, **AUDI:** 80 2.2 RS2 /QUATTRO S2 /S6 2.2 T, 100 2.2, 200 2.2 Turbo; **BMW:** 316/ 318/ 320/ 323/ 325/ i/ 328/ 525/ i/ 528/ Z3, **CHEVROLET-GM:** OMEGA 3.0/4.1/i, SUPREMA 3.0/4.1/i, C20, SILVERADO 4.1, **CHRYSLER:** GRAND CARAVAN 3.0 i LE, **CITROEN:** EVASION 2.0i /Turbo, BERLINGO 1.8i; XANTIA 1.6/ 1.8/ 2.0, XM 2.0, XSARA 1.8/ 2.0/ TURBO, ZX 2.0i, PICASSO 2.0 TURBO, **FIAT:** ULYSSE 1.8 /1.9 /2.0 /2.1 i.e. /TD /Turbo, CROMA 2.0 i.e. /16V /Turbo, BRAVA, FIORINO, MAREA, PALIO, SIENA, STILO, STRADA, **FORD:** ESCORT 2.0i 16V RS 2000 /4X4 /ESCORT 1.8 i 16V XR3 Cabriolet/ Turnier, EUROLINE /NUGGET /SCORPIO /TOURNEO /TRANSIT, MONDEO 1.8/2.0 i, **OPEL:** OMEGA 2.4/ 2.6/ 3.0/ 3.6 i, **PEUGEOT:** 306 1.8/2.0/ i / 16V, 405 1.8/ 2.0, 605 2.0i 16V /3.0i 24V, 806 2.0i, PARTNER 1.8i, **RENAULT:** BERLINGO 1.9 i, PARTNER 1.9 i, CLIO 2.0i Williams, LAGUNA 2.0i, **VOLKSWAGEN:** GOL, KOMBI, PARATI, SAVEIRO-1.6/ 1.9, TRANSPORTER, **VOLVO:** C70 /S70 /V70 /850 - 2.5 GLT / Turbo /R /T-5 /T-5R /S40 - 1.8 /2.0 16V /V40 - 1.8 16V

Bosch



UF - 1.126/4 4 escovas / brushes

Especificações / Features: **12V, Tipo / Type: DW** - Escova / Brush: 5 x 16 x 13, GIRO SENTIDO ANTI-HORÁRIO / Counter Clockwise Rotation, Terminal saída lado esquerdo / Left side terminal.

Original: 1 004 336 811

Partida / Starter: 0 001 107 003 (0 001 108 076), 0 001 108 099/ 050 / 059/ 060/ 077/ 096/ 127/ 168, 0 001 111 001 / 005

Aplicação / Application: **LADA (SHIGULI):** SAMARA 1.3 / 1.5 / FUN
FIAT: TEMPRA 2.0 i.e. S.W. ; TIPO 1.8 / 2.0 / i.e. / 16V
VOLKSWAGEN: GOLF 1.8 / II 1.8, PASSAT (IMPORTADO) 2.0

Bosch



UF - 1.127/4 4 escovas / brushes

Especificações / Features: **12V, Tipo / Type: DW/DB** - Escova / Brush: 6 x 18 x 14,5, GIRO SENTIDO ANTI-HORÁRIO / Counter Clockwise Rotation, Terminal saída lado esquerdo / Left side terminal.

Original: 1 004 336 800 / 847 / 884 / 906 / 926 / 933 / 958 / 983 / 990 / 991

Partida / Starter: 0 001 110 047, 0 001 110 059, 0 001 110 076, 0 001 110 086, 0 001 125 005, 0 001 125 011, 0 001 125 048 (0 001 125 018), 0 001 125 042 (0 001 125 012), 0 001 109 011 / 012, 0 001 110 001 / 002 / 009 / 010 / 014 / 015 / 018 / 031 / 033 / 057 / 062 / 069 / 070 / 077 / 081 / 084 / 087 / 099 / 118 / 119, 0 001 124 001 / 005 / 006 / 007 / 011 / 014, 0 001 125 001 / 002 / 006 / 013 / 016 / 019 / 031

Aplicação / Application: **AUDI:** A3 1.8 T, S3 QUATTRO, TT COUPE / TT ROADSTER 1.8T QUATTRO, **PORSCHE:** 911 3.6 CARRERA / TARGA / TURBO, **SEAT:** CORDOBA 1.9 DIESEL / TURBO / SDI / TDI, IBIZA 1.9 DIESEL / TURBO, ALHAMBRA 2.8, **VOLKSWAGEN:** PASSAT (IMPORTADO) 2.8 VR6, GOLF IV 1.9 / 2.3 / TDI / V5 / 4 MOTION / VARIANT, TRANSPORTER CALIFORNIA /CARAVELLE/ MULTIVAN 1.9/2.4, **HYUNDAI:** AEROVAN

Bosch



UF - 1.128/4 4 escovas / brushes

Especificações / Features: **12V, Tipo / Type: DW** - Escova / Brush: 6 x 18 x 14,5, GIRO SENTIDO HORÁRIO / Clockwise Rotation, Terminal saída lado direito / Right side terminal.

Original: 1 004 336 835 / 908 / 949

Partida / Starter: 0 001 108 182, 0 001 110 003, 0 001 110 026, 0 001 110 095

Aplicação / Application: **RENAULT:** CLIO 1.0 i 8V / 1.6 i, EXPRESS, EXTRA, RAPID 1.6 / 1.7, NOVO SCÉNIC

Bosch



UF - 1.129/4 4 escovas / brushes

Especificações / Features: **12V, Tipo / Type: DW/DB** - Escova / Brush: 6 x 18 x 14,5, Terminal saída lado direito / Right side terminal.

Original: 1 004 336 807 / 826 / 942 / 959 / 981 / 996

Partida / Starter: 0 001 110 120, 0 001 109 021, 0 001 110 011, 0 001 110 017, 0 001 110 025, 0 001 110 041, 0 001 110 079, 0 001 110 104, 0 001 109 036, 0 001 109 040, 0 001 110 029, 0 001 110 063, 0 001 124 015, F 000 ALO 111

Aplicação / Application: **AUDI:** A6 / A8 QUATTRO 4.2, CABRIOLET 1.9, S6 / S8 4.2, **BMW:** M5 3.8 / TOURING, **FIAT:** DUNA 1.7 D / WEEKEND, **FORD:** COURIER 1.8 DIESEL, ESCORT 1.8 - EXPRESS 55/75 / CABRIO / TURNIER / DIESEL / TURBO, MONDEO 1.8 Turbo, **JAGUAR:** XJ6 4.0, **MERCEDES-BENZ:** SPRINTER 312 D / 410 D, **PEUGEOT:** 306 1.9 D, 405 1.9 D, **PORSCHE:** BOXTER 2.5i, **RENAULT:** SAFRANE 2.2 i, **LAND ROVER:** DEFENDER / DISCOVERY / RANGE ROVER I / II, **VOLKSWAGEN:** PASSAT (IMPORTADO) 2.5 TDI, **VOLVO:** 850 2.5 GLT, 960 3.0

Bosch

UF - 1.131/4 4 escovas / brushes

Especificações / Features: **12V, Tipo / Type: EV - GIRO SENTIDO HORÁRIO / Clockwise Rotation -**

Escova / Brush: 7,5 x 18 x 17

Original: 9 003 334 314 / 1 004 112 906 / 1 004 112 907

Partida / Starter: 9 000 331 411, 9 000 331 419, 9 000 331 432, 9 000 331 433, 0 001 218 128, 0 001 218 135, 0 001 218 004 / 006 / 009 / 012 / 013 / 015 / 016 / 018 / 019 / 021 / 023 / 025 / 029 / 101 / 103 / 107 / 115 / 118 / 126 / 142 / 152 / 153 / 158 / 160 / 161 / 163 / 176, 0 001 218 122 (0 001 218 011), 0 001 218 125/137/138/140/159/165 (0 001 218 108), 0 001 218 168 / 174 / 177 / 136, 0 001 218 157/ 171, 6 003 AB1 J00

Aplicação / Application: **OPEL:** FRONTERA 2.3 TD, OMEGA 2.3 D/DT, **ALFA ROMEO:** ALFA 33 1.8/SW/TD, 155 2.5 TD, 164 2.5 TD, **CHRYSLER:** VOYAGER 2.5 TD, **ROVER:** 825 2.5 TD, **MERCEDES-BENZ:** CLASSE SL 600 COUPE / SEC / V12 / SEL, MB 100 D / 180 D, SPRINTER 310 D / 312 D / 412 D, **FIAT:** DUCATO - 10/14/18 - 2.5 D/DT/EGR/ECO/4X4, **BMW:** 750 i/II, 850 i/Ci/Csi, **CHEVROLET-GM:** BLAZER 2.5 DIESEL, **DODGE:** DAKOTA 2.5 D, **FORD:** COURIER 1.8 DIESEL, ESCORT 1.8 - EXPRESS 55/75 / CABRIO / TURNIER / DIESEL / TURBO, MONDEO 1.8 Turbo Diesel, F-1000 / F-1000 HSD, **IVECO:** DAILY 10, **MARCOPOLO:** VOLARE, **PEUGEOT:** BOXER 2.5 Tdi, **RENAULT:** EXPRESS, EXTRA, RAPID 1.6, **LAND ROVER:** DEFENDER/ DISCOVERY - 2.5 Tdi /Turbo/Diesel / RANGE ROVER I - 2.5 Tdi Classic, RANGE ROVER II 2.5, **SSANGYONG:** MUSSO 2.9 DIESEL

Bosch

UF - 1.132/4 4 escovas / brushes

Especificações / Features: **12V, Tipo / Type: EV - GIRO SENTIDO ANTI-HORÁRIO / Counter Clockwise Rotation -**

Escova / Brush: 7,5 x 18 x 17

Original: 9 003 334 341, 9 003 334 158

Partida / Starter: 0 001 218 116, 0 001 218 117, 0 001 218 148, 0 001 218 149, 0 001 218 149

Aplicação / Application: **IVECO:** CAMINHÕES

Bosch

UF - 1.136
Especificações / Features: **24V, Tipo / Type: JE - Escova / Brush: 9 x 36 x 18**
UF - 1.136/2 2 escovas / brushes

UF - 1.136/4 4 escovas / brushes

Original: 2 004 336 077 / 078

Partida / Starter: 0 001 371 005 / 009 / 004 / 006 / 008

Aplicação / Application: **SCANIA:** DSI /114 /P /R /T /DS /1468 /1469 /1473 /1474 /1475 /1478 /M /1194 /1198 /1199 /1174 /1175 /1176 /1177 /1178 /1179 /RT 144-460 / 530, R-164-480/ 580/ DSC, 124-K /T /R-124 /T-124-360 /400 /420, P-114 /R114 /340 /T-114 /340

Bosch

UF - 1.150
Especificações / Features: **24V, Tipo / Type: JF/DD - Escova / Brush: 7,5 x 25 x 17**
UF - 1.150/2 2 escovas / brushes

UF - 1.150/4 4 escovas / brushes

Original: 2 004 336 031

Partida / Starter: 0 001 368 306, 0 001 368 001, 0 001 368 069, 0 001 368 301, 0 001 368 309, 0 001 368 002 /005 /007 /009 /010 /012 /013 /016 /018 /019 /020 /021 /024 /027 /028 /030 /034 /035 /036 /038 /040 /055 /059 /063 /071 /085 /086 /300 /307

Aplicação / Application: **RENAULT:** SÉRIES: MIDLUM / SZM / 135 / 150 / 180 / 210 / 220 / 250 / 270 / 300 / CE / D / G / JE / M / ME / R / S / SE, **IVECO:** SÉRIES: 60 / 75 / 80 / 90 / 110 / 120 / 130, **CASE:** 900 - 988 - C/ MOTOR 6T, **SCANIA:** SÉRIES: 93 / 94 / 124 / 164, **MERCEDES-BENZ:** O - O 371 U ; OF 1115 / 1315 ; OH 1315 / 1318, **DAF, DEUTZ, FIAT, FORD, HANOMAG, IHC, KHD, MAGIRUS, VOLVO, WHITE, GMC - TRUCK**
Bosch

UF - 1.151
Especificações / Features: **12V, Tipo / Type: JF/DD - Escova / Brush: 9 x 16 x 17**
UF - 1.151/2 2 escovas / brushes

UF - 1.151/4 4 escovas / brushes

Original: 2 004 336 027 / 041

Partida / Starter: 0 001 362 046, 0 001 362 081, 0 001 354 092, 0 001 362 020 /034 /036 /037 /039 /042 /045 /051 /058 /062 /069 /073 /077 /085 /093 /300 /303 /314 /321 /600 /700, 0 001 366 001 /003 /006 /009 /014 /021 /024/ 026/ 029

Aplicação / Application: **KAEBLE:** 3 WT, WTV c/ motor, **PEUGEOT:** 504 - 2.3 PICK-UP DIESEL, **AUDI, CASE, DEUTZ, IHC, JOHN DEERE, KHD, MASSEY-FERGUSON, MERCEDES, VOLVO (Diesel)**

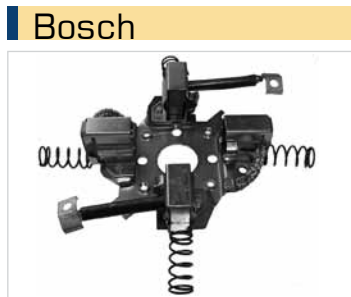

UF - 1.152
UF - 1.152/2 2 escovas / brushes
UF - 1.152/4 4 escovas / brushes

Especificações / Features: **12V, Tipo / Type: JF/DD** - Escova / Brush: 10 x 25 x 17
Original: 2 004 336 044 / 028

Partida / Starter: 0 001 367 029, 0 001 367 001 /002 /003 /004 /005 /006 /007 /008 /009 /010 /011 /012 /013 /014 /015 /016 /018 /021 /022 /023 /024 /025 /027 /028 /030 /032 /034 /036 /039 /042 /044 /045 /046 /048 /050 /052 /055 /058 /063 /070 /076 /300

Aplicação / Application: **NEW HOLLAND:** 8000 - 8430/ 8630 /8830 /8430 /DT, **DEUTZ, FORD, IHC, IVECO, JOHN DEERE, KHD, MACK TRUCK, MAGIRUS, MASSEY FERGUSON, MERCEDES, RENAULT, VOLVO, SCANIA:** TRUCK 93L

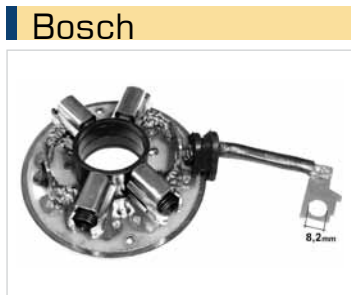

UF - 1.162/4 4 escovas / brushes

Especificações / Features: **12V, Tipo / Type: EV** - Escova / Brush: 6,1 x 22 x 15,5, Cabo curto / Short cable
Original: 6 033 AD0 368, 6 033 AD1 244

Partida / Starter: 0 001 223 003, 0 001 223 010, 0 001 218 774 (0 001 218 174)

Aplicação / Application: **IVECO:** CITY CLASS C/ MOTOR 2.8 8140.43S (10.2005 ->), SCUDATO C/ MOTOR 2.8 8140.43S (10.2005 ->), DAILY C/ MOTOR 8140 (11.1997 ->), **IVECO:** DAILY 35 / 50 / C 9 / C 11 / C 13 / S 9 / S 11 / S 13, **FORD:** F 250 COM MOTOR MWM 6.07 TCA - 03/1999 >

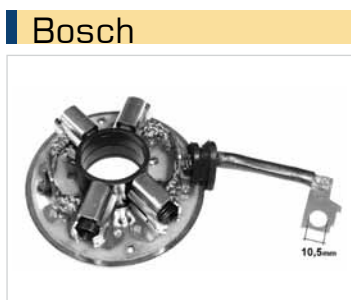

UF - 1.164/4 4 escovas / brushes

Especificações / Features: **12V, Tipo / Type: EV** - Escova / Brush: 6,1 x 22 x 15,5, Cabo longo / Long cable
Original: 6 033 AD0 216 / 409 / 370, 6 033 AD1 255

Partida / Starter: 0 001 223 505, 0 001 230 007, F 000 AL0 130

Aplicação / Application: **CATERPILLAR, FORD:** F 250, F-350 e F-4000 com motor CUMMINS 4BTAA - 11/1998 > **NEW HOLLAND:** TL 70/ 75/ 80/ 90/ 100 (09.97 >), **ISUZU**

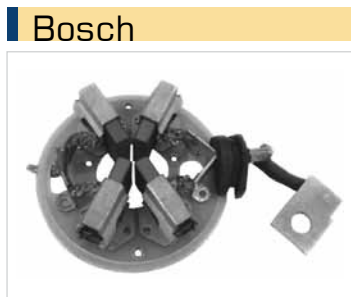

UF - 1.165/4 4 escovas / brushes

Especificações / Features: **24V, Tipo / Type: EV** - Escova / Brush: 6,5 x 25 x 16,5
Original: 6 033 AD0 189, 6 033 AD4 054

Partida / Starter: 0 001 231 002, 0 001 231 033

Aplicação / Application: **MERCEDES-BENZ:** SÉRIE-AX, CASE: SÉRIES:800/ 2000/ 4000/ W. , **CATERPILLAR:** SÉRIES: 631E/ D8L/, D/ 100/ 900/ 3300 / O500U, **VOLKSWAGEN**



UF - 1.166
UF - 1.166/4 4 escovas / brushes

Especificações / Features: **24V, Tipo / Type: KB** - Escova / Brush: 12 x 36 x 27, (BSX 60)
Original: 2 005 855 110, 9 001 084 104

Partida / Starter: 9 000 084 007/ 008/ 009/ 011/ 012/ 013/ 014 /015/ 016/ 018/ 020/ 022 /023/ 024/ 026, 0 001 416 009/ 036/ 061/ 071, 0 001 417 005/ 023/ 036/ 042/ 047/ 055/ 064

Aplicação / Application: **ATLAS COPCO:** SÉRIE-AX, CASE: SÉRIES:800/ 2000/ 4000/ W. , **CATERPILLAR:** SÉRIES: 631E/ D8L/, D/ 100/ 900/ 3300
CUMMINS: SÉRIES: C/ CT/ CTA/ N, **DECAROLI:** SL, EL DETALLE: SÉRIE-AO, **FIAT:** SÉRIE-190, **FIAT-ALLIS:** SÉRIES:AD/ FD/ FG/ FR, **IVECO:** SÉRIE-180 / 190 / 240 / 260/ 440/ 450 / 619, **KOMATSU:** SÉRIES: A / D/ GD/ R/ WA, **LIEBHERR, MAFERSA:** SÉRIE-M, **MASSEY-FERGUSON:** SÉRIE-MF 4000, **MERCEDES-BENZ:** SÉRIES:13T L/ 14T L/ 15T L / 19T L/ 20T L/ 22T L/ 26T L/ O/ OH, **MWM-DIESEL, SCANIA:** SÉRIES:112/ 113/ 142/ BR/ DN/ DS/ DSC/ DSI, **VOLKSWAGEN:** SÉRIES:14T/ 16T, **VOLVO:** SÉRIES:B7R/ B10/ C10/ F80/ FM10/ G/ N10/ N12/ N80/ NL10/ NL12/ , **VOLVO PENTA**

Bosch



UF - 1.174/4 4 escovas / brushes

Especificações / Features: **12V, Tipo / Type: DD - Escova / Brush: 7 x 10 x 15**

Original: 1 004 336 901

Partida / Starter: 0 001 208 702 / 705 / 706 / 707 / 708 / 709-715 / 717-719, 9 000 333 106 / 114 / 117

Aplicação / Application: **MATRA, TALBOT, ALFA-ROMEU, AUDI, BMW, CITROEN, FIAT, FORD, LANCIA, MERCEDEZ-BENZ, OPEL, PEUGEOT, RENAULT, SAAB, SEAT, VOLVO, VOLKSWAGEN**

Bosch



UF - 1.175/4 4 escovas / brushes

Especificações / Features: **12V, Tipo / Type: DD - Escova / Brush: 7 x 16 x 15**

Original: 1 004 336 900

Partida / Starter: 0 001 312 108 / 109, 0 001 317 007-013 / 016-019 / 022-025

Aplicação / Application: **AUDI, OPEL, VAUXHALL, TRANSPORTER, VOLKSWAGEN: GOLF DIESEL TURBO, CHEVROLET-GM: KADETT, FORD: ESCORT**

Bosch



UF - 1.194/4 4 escovas / brushes

Especificações / Features: **12V, Tipo / Type: DW - Escova / Brush: 6 x 18 x 14,5, Terminal saída lado esquerdo / Left side terminal terminal**

Original: 1 004 336 445 / 836

Partida / Starter: F 000 AL0 105 / 107 / 112, 0 001 109 018 / 048 / 306

Aplicação / Application: **CHEVROLET-GM: S10 / BLAZER 2.5 DIESEL 4.07 TCA / 2.8 DIESEL SPRINT MWM, FIAT, IVECO, LANCIA, MERCEDES-BENZ, NISSAN: FRONTIER / X-TERRA C/ MOTOR MWM 2.8 SPRINT (05.2004>), TROLLER: T4 PANTANAL 2.8 MWM SPRINT, AGRITECH/ YANMAR: BTD (05.2004>)**

Bosch



UF - 1.197

UF - 1.197/2 2 escovas / brushes

UF - 1.197/4 4 escovas / brushes

Especificações / Features: **12V, Tipo / Type: EF - Escova / Brush: 7 x 16 x 18**

Original: 1 004 336 046

Partida / Starter: 0 001 312 103, 0 001 314 005 / 018 / 025

Aplicação / Application: **VOLKSWAGEN 12 VOLTS (MÉXICO)**

Bosch



UF - 1.198/2 2 escovas / brushes

UF - 1.198/4 4 escovas / brushes

Especificações / Features: **6V, Tipo / Type: EF - Escova / Brush: 7 x 16 x 18**

Original: 1 004 336 027, 9 001 042 176

Partida / Starter: 0 001 207 003 / 005 / 009 / 015 / 018

Aplicação / Application: **VOLKSWAGEN 6 VOLTS (MÉXICO)**

Bosch

UF - 1.201/4 4 escovas / brushes

Especificações / Features: **12V** - Escova / Brush: 8,8 x 19 x 22, Quatro pólos isolados / Four isolated poles.

Original:

Partida / Starter: WAPSA 12 volts

Aplicação / Application: EMPILHADEIRA / FORKLIFT E PLATAFORMAS



Bosch

UF - 1.206
UF - 1.206/4 4 escovas / brushes

Especificações / Features: **24V, Tipo / Type: KB** - Escova / Brush: BSX 12 x 36 x 27, (BSX 60), Isolado / Isolated.

Original: 9 001 084 126

Partida / Starter: 9 000 084 011

Aplicação / Application: MOTORES ESTACIONÁRIOS E MARÍTIMOS



Bosch

UF - 1.210/4 4 escovas / brushes

Especificações / Features: **12V, Tipo / Type: K1** - Escova / Brush: 4,5 x 8,7 x 10,5

Original: F 000 CD1 203, F 000 CD1 285

Partida / Starter: F 000 CD0 800 / 900 / A0, 51888975, 0 001 121 439 / 440, 51865316

Aplicação / Application: CHEVROLET: MONTANA, FIAT: FIORINO 1.3 FIRE, DOBLO, PALIO, STRADA, IDEA, UNO, STRADA 1.4/1.6, PUNTO, BRAVO. Todos Motores/ All Engines: E.TORQ. VOLKSWAGEN: GOL, VOYAGE 1.0 / 1.6



Bosch

UF - 1.217/4 4 escovas / brushes

Especificações / Features: **12V, Tipo / Type: DW** - Escova / Brush: 5 x 12 x 11,6, Terminal saída lado direito / Right side terminal

Original: F 000 AL1 171, F 000 AL0 106

Partida / Starter: 0 001 107 075

Aplicação / Application: TOYOTA: COROLLA / FIELDER 1.8i 16V 08.1998 → 06.2002



Bosch

UF - 1.218/4 4 escovas / brushes

Especificações / Features: **12V, Tipo / Type: DW** - Escova / Brush: 5 x 12 x 11,6, Terminal saída lado direito / Right side terminal.

Original: 1 004 336 985

Partida / Starter: 0 001 107 037 /048 /056 /072

Aplicação / Application: ALFA ROMEO, AUDI, CITROEN, LANCIA, OPEL, PEUGEOT, RENAULT, SEAT, VAUXHALL, VOLKSWAGEN



Bosch



UF - 1.219/4 4 escovas / brushes

Especificações / Features: **12V, Tipo / Type: DM** - Escova / Brush: 5 x 12 x 11,6, Base maior que UF-1.217/4 e UF-1.218/4 / Bigger than UF-1.217/4 and UF-1.218/4.

Original: 9 001 081 094, 9 001 081 068

Partida / Starter: 9 001 081 009, F 000 ALO 300 / 305, F 000 AL1 094

Aplicação / Application: FIAT: UNO MILLE 1.0 5P 95-01, PALIO 1.0 MPI 8V, 96 - 01, SIENA, PALIO WEEKEND, STRADA

Bosch



UF - 1.222/4 4 escovas / brushes

Especificações / Features: **12V, Tipo / Type: LT** - 1,1 Kw - Escova / Brush: 4,5 x 10 x 13, CCW - Counter Clock Wise / Sentido Anti-horário

Original: 1 004 336 526 / 842 / 879 / 957

Partida / Starter: 0 001 107 025, 0 001 121 422, 0 001 120 402 / 406 / 407 / 408 / 409 / 412 / 440, 0 001 121 423

Aplicação / Application: AUDI, FIAT: LINEA 1.8 (E-TORQ), UNO FIRE, FORD: MONDEO, LAND-ROVER: FREE LANDER II 3.2 V6 (2007-2009), SEAT: IBIZA, SKODA, VOLKSWAGEN

Bosch



UF - 1.223/4 4 escovas / brushes

Especificações / Features: **12V, Tipo / Type: LT e PDM (JF / JD Moderno / New)** - 3,0 Kw - Escova / Brush: 6 x 18 x 14,5

Original: 1 004 336 518 / 586, 6 004 AE0 016

Partida / Starter: 0 001 109 300 / 301 / 306 / 307 309 / 310 / 330, F 000 ALO 111/ 128/ 130, F 004 A94 008/ 011, 900008328, 9000083054

Aplicação / Application: FIAT: DUCATO MULTIJET, FORD: CARGO 1317, F-250 CUMMINS 4CC 3.9 ELETRONICO / ELECTRONIC (2006-2011), F-4000 CUMMINS 2010->, IVECO, TOYOTA: HILUX/ SW4 2.5 /2.8/ 3.0 DIESEL 2002 ->, MB: ONIBUS/ BUS O364 - MOTOR/ ENGINE OM352/ 352*, CAMINHÔES/ TRUCKS 1316, 1513, MERCEDES-BENZ: CAMINHÃO L608D /709 /710 /712 /LO 809 /LO812 /LO 814 /912 /914 /L 1013 /L 1111 /L 1113 /L 1114 /L 1116 /L 1117 /L 1214 /L 1218 /L 1313 /L 1314 /L 1316 /L 1317 /L 1318 /L 1418 /L 1513 /L 1516 /L 1517 /L 1518 /L 1620 /1714 /1718 /1720 /1721 /1722 /1723 /L 2013 /L 2014 /L 2016 /L 2213 /L 2214 /L 2216 /L 2217 /L 2218 /2418 /O362 /365 /OM 366 C/ MOTORES OM 314 /OM 364 /OM 352, NEW HOLLAND: COLHEITADEIRA/ COMBINE FNH 8040, 8255, TOYOTA: BANDEIRANTES - MOTOR/ ENGINE OM 352 /364

Bosch



UF - 1.224/4 4 escovas / brushes

Especificações / Features: **12V, Tipo / Type: LT** - 1,4 Kw - Escova / Brush: 5 x 16 x 13,5

Original: 1 004 336 530

Partida / Starter: 0 001 108 401/ 411

Aplicação / Application: BMW, FIAT: DUCATO. CITROEN, PEUGEOT, VOLVO: S80 3.0L 2008, S80 3.2L T6 AWD 2007-08, V70 III 3.2L, AWD 2008, XC60 T6 AWD 3.2, XC70 3.2L 2008, XC90 3.2L 2007-08

Bosch



UF - 1.225/4 4 escovas / brushes

Especificações / Features: **12V, Tipo / Type: LT** - 1,8 Kw - Escova / Brush: 5 x 16 x 13,5

Original: 1 004 336 228 / 533/ 511/ 536/ 566/ 577/ 579/ 638/ 712/ 727/ 770/ 888

Partida / Starter: 0 001 108 202/ 217/ 218/ 222/ 223/ 224/ 230, 0 001 107 107, 0 001 151 4214

Aplicação / Application: ALFA ROMEO, FIAT, LANCIA: JTD, MERCEDES-BENZ

Bosch

UF - 1.226/4 4 escovas / brushes

Especificações / Features: **12V, Tipo / Type:** LT - 1,4 Kw - Escova / Brush: 5 x 16 x 13,5. (Base maior que / bigger than UF-1.225/4)

Original: 1 004 336 533

Partida / Starter: 0 001 108 400 / 406/ 409

Aplicação / Application: **AUDI:** A4/QUATTRO 3.2L (05-08), A6/QUATTRO 3.2L (05-08), **CITROEN:** BERLINGO 1.9/2.0, C4 HATCHBACK 2.0 16V, C4 GRAND PICASSO 1.8/2.0 16V, C4 PICASSO 1.8/2.0 16V, C5 HATCHBACK/SALOON 1.8 16V, C5 BREAK ESTATE 1.8 16V, JUMPY 1.9D/ 2.0 HDI, XSARA HATCHBACK/ COUPE/ BRAKE STATE/ PICASSO 2.0 HDI, **FIAT:** ULYSSES 2.0, **PEUGEOT:** 206 1.9D/ 2.0 HDI, 306 1.9D/ 2.0 HDI, 307 2.0 16V/ HDI, 407 1.8/ 2.0/ 2.2 16V, EXPERT 1.9D, 2.0 HDI, PARTNER 1.9D/ 1.9D 4X4/ 2.0 HDI, **MB:** CLASSES CL, CLK, CLS, E, G, M, S, SL 5.5L, GL 4.6L



Bosch

UF - 1.227/4 4 escovas / brushes

Especificações / Features: **12V, Tipo / Type:** CDS - Escova / Brush: 4,5 x 8,5 x 11

Original:

Partida / Starter: F 000 CD0 001/ 002/ 003 /9A0, F 000 CD1 020

Aplicação / Application: **RENAULT:** DUSTER, LOGAN 1.6 / MCV, SCENIC 1.6, MEGANE 1.6 , SANDERO, TODOS 1.0 2006 →, **FIAT:** DOBLO, IDEA, FIORINO, PALIO, PUNTO, SIENA, STRADA 1.4/ 1.6, UNO (NOVO), **DACIA:** DUSTER, LOGAN, LOGAN MCV, SANDERO



Bosch

UF - 1.233/4 4 escovas / brushes

Especificações / Features: **24V, Tipo / Type:** HEF95-L24V - 5,5 Kw - Escova / Brush: 5,5 x 28 x 18

Original: 6 033 AD5 016 / 194, 6 033 AD5 316 / 128 / 179

Partida / Starter: 0 001 241 001/ 003/005/ 014/ 015/ 019/ 020, 0 001 161 002, 0 002 242 002

Aplicação / Application: **SCANIA:** 2000 -> , T 340 DC 11.08 Euro 3 / T 380 DC 11.09 Euro 3, T 420 DC 12.14 Euro 3 / T 420 DT 12.11 Euro 4 , T 470 DT 12.06 Euro 3, P 230 DC 9.13 Euro 3 / P 270 DC 9.12 Euro 3 / P 310 DC 9.11 Euro 3 / P 340 DC 11.08 Euro 3 / P 380 DC 11.09 Euro 3 / P 420 DC 12.14 Euro 3, P 230 DC 9.16 Euro 4 / P 270 DC 9.17 Euro 4 / P 310 DC 9.18 Euro 4 / P 340 DC 12.10 Euro 4 / P 380 DC 12.13 Euro 4, P 380 DC 12.18 Euro 5 / P 480 DT 12.17 Euro 4, P 420 DC 12.15 Euro 5, P 420 DT 12.12 Euro 4, P 470 DT 12.06 Euro 3, T 340 DC 11.08 Euro 3 / T 380 DC 11.09 Euro 3 T 420 DC 12.14 Euro 3 / T 420 DT 12.11 Euro 4, T 470 DT 12.06 Euro 3, **KAMAZ:** 18t 5460 740.50-360 Euro 2, 27t 6520 740.51-320 Euro 2

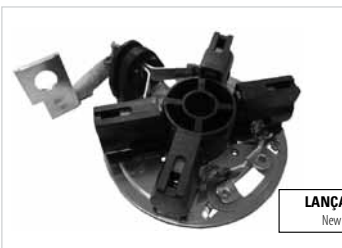

LANÇAMENTO
New product

Bosch

UF - 1.235/4 4 escovas / brushes

Especificações / Features: **24V, 5,5 Kw** - Escova / Brush: 6,5 x 28 x 18

Original:

Partida / Starter: 0 001 261 001, 0 001 261 002, 0 986 021 480

Aplicação / Application: **SCANIA:** SERIES P, G, R, T (MOTORES ELETRÔNICOS / ELECTRONIC ENGINES): G 230, G 230 E P 230 (2006 – 2007), G 270, P 270, G 270, P 270 E R 270 2004/1/9, G 310, P 310, G 310 E P 310 2004/09/01, G 340, P 340, G 340 E P 340 2004/08/01, G 340, P 340, R 340, G 340 E R 340 2006/8/1, G 380, P 380, G 380 E P 380 2004/08/01, G 380, P 380 E R 380 (2005 – 2008), G 420, G 420 E R 420 2008/1/1, G 420, P 420 E R 420 (2004 – 2005), G 420 E R 420 2008/1/1, G 480 E R 480 (2008), P 230 (2006 – 2008), P 230 E R 230 (2004 – 2006), P 270 E R 270 (2004 – 2006), P 280, P 310 (2006 – 2008), P 310 E R 310 (2004 – 2006), P 340 (2004 – 2006), P 340 E R 340 (2004 – 2006), P 380 (2004 – 2006), P 380 E R 380 (2004 – 2006), P 420 2004/09/01, P 420 E R 420 (2004 – 2006), P 470 E R 470 (2004 – 2005), P 480 E R 480 E R 340 2004/3/1, R 380 2004/3/1, R 380 2004/9/1, R 400 2008/3/1, R 420, 440 R 2008/03/01, R 470 2004/1/4, R 480 2006/1/8, T 470 (2004 – 2005)



LANÇAMENTO
New product

Delco

UF - 1.120
UF - 1.120/4 4 escovas / brushes

Especificações / Features: **12V, Tipo / Type:** 37/41 MT - Escova / Brush: 9,6 x 28,6 x 26,6

Original: 10468705

Partida / Starter: 1993874, 1993931, 1993963, 1993964

Aplicação / Application: **CHEVROLET-GM:** CAMINHÕES C/ MOTOR CATERPILLAR 3116/3126, **CUMMINS:** VEÍCULOS C/ MOTOR CUMMINS SÉRIE C, **FORD:** VEÍCULOS C/ MOTOR CUMMINS SÉRIE C, **VOLKSWAGEN:** VEÍCULOS C/ MOTOR CUMMINS SÉRIE C



Delco

UF - 1.121/4 4 escovas / brushes

Especificações / Features: 24V, Tipo / Type: 37/41 MT - Escova / Brush: 9,6 x 28,6 x 26,6

Original: 10469238

Partida / Starter: 10479196, 1993910, 10478961, 10479292, 10479310

Aplicação / Application: CUMMINS: VEÍCULOS C/ MOTOR CUMMINS SÉRIE C, FORD: VEÍCULOS C/ MOTOR CUMMINS SÉRIE C, MERCEDES-BENZ: 1631L, 1632L, 1632LS, 1634LS, 1938LS, 1939S, 1944L, 2638, 2638LK, 2638LS, OF1722, OH1628, BR 400, BR 450, ÔNIBUS O-400, CAMINHÕES 1938 / 2638, VEÍCULOS C/ MOTOR CUMMINS SÉRIE C, VOLKSWAGEN: VEÍCULOS C/ MOTOR SÉRIE C



Delco

UF - 1.122
UF - 1.122/4 4 escovas / brushes

Especificações / Features: 12V, Tipo / Type: 42 MT - Escova / Brush: 10,6 x 36,6 x 25

Original: 1988121

Partida / Starter: 10479117, 1990420, 1993961

Aplicação / Application: CUMMINS: MOTORES CUMMINS, INTERNATIONAL / NAVISTAR: NAVISTAR 9000 - CAMINHÕES 9200, CAMINHÕES 9200 - 4X2, 9200 - 6X4



Delco

UF - 1.123/4 4 escovas / brushes

Especificações / Features: 24V, Tipo / Type: 42 MT - Escova / Brush: 10,6 x 36,6 x 25

Original: 1988439

Partida / Starter: 10479114, 10479118, 1990378, 10478941

Aplicação / Application: CUMMINS: MOTORES CUMMINS



Delco

UF - 1.133
UF - 1.133/4 4 escovas / brushes

Especificações / Features: 12V, Tipo / Type: 28 MT - Escova / Brush: 8 x 25 x 19,5

Original: 10456456

Partida / Starter: 10479621

Aplicação / Application: ASIA MOTORS: BESTA, CUMMINS: MOTORES CUMMINS, MERCEDES-BENZ: SPRINTER 180, 7t - 709, 9t - 912



Delco

UF - 1.134/4 4 escovas / brushes

Especificações / Features: 24V, Tipo / Type: 28 MT - Escova / Brush: 8 x 25 x 19,5

Original: 10483823

Partida / Starter: 1113277, 10479626

Aplicação / Application: ASIA MOTORS: BESTA, CUMMINS: MOTORES CUMMINS, MERCEDES-BENZ: CAMINHÕES E ÔNIBUS 712 / 912 / 914 / 1215 / 1417 / 1625 / 1628 / 1632 / 1721 / 1725 / 2423 c/ motor BR900





Delco

UF - 1.148/4 4 escovas / brushes

Especificações / Features: **12V, Tipo / Type: PG260MQ / PMGR** - Escova / Brush: 6 x 19 x 16

Original: 10475602

Partida / Starter: 9000 786/ 798/ 804/ 805/ 806/ 812/ 819/ 820/ 821/ 822/ 827/ 834/ 835/ 844/ 850/ 851/ 853/ 860/ 861/ 862/ 863/ 864/ 866/ 867/ 899/ 900

Aplicação / Application: **CHEVROLET-GM:** BLAZER / S10 - C/ MOTOR VORTEC V6 4.3L



Delco

UF - 1.149/4 4 escovas / brushes

Especificações / Features: **12V, Tipo / Type: PG260B / C / D** - Escova / Brush: 5 x 15 x 13

Original: 10452368 / 10504488

Partida / Starter: 9000846, 9000890, 9000891, 8000 090/ 158/ 159/ 188, 9000 890/ 891/ 893/ 844/ 948/ 978/ 981

Aplicação / Application: **CHEVROLET-GM:** MONZA, ASTRA, BLAZER, CELTA, CORSA, CORSA CLASSIC, MERIVA, MONTANA, PICK-UP CORSA, S-10, VECTRA - TODOS C/ DOHC / SOHC II, C/ MOTORES 1.8, 2.0, 2.2 L 16V / L 8V, ZAFIRA - COM MOTOR 1.8, 2.0, 2.2 E 2.4 8V E 16V SOCH (GASOLINA, ÁLCOOL E FLEX), **FIAT:** PALIO, PALIO WEEKEND, SIENA, DOBLÔ, STILO, STRADA, UNO, PUNTO E IDEA (TODOS COM MOTORES FIRE 1.0, 1.3, 1.4, 1.8, 8V E 16V, **DAEWOO** - ESPERO 2.0 L., OPTRA 1.8 L (GASOLINA, ÁLCOOL E FLEX), OPTRA 1.4L, **CADILLAC, ISUZU, OLDSMOBILE**



Delco

UF - 1.167
UF - 1.167/12 12 escovas / brushes

Especificações / Features: **24V, Tipo / Type: 50MT** - Escova / Brush: 8 x 19 x 19 (12 ESCOVAS RX 92)

Original: 1945849, 1967354

Partida / Starter: 10478827, 10478829

Aplicação / Application: 50 MT (12 ESCOVAS RX 124 OU RX 92 DUPLA POR CAVALETE) LOCOMOTIVA COM MOTORES DIESEL V16 e V20, **CATERPILLAR:** 245, 346, 621B, 621E, 623E, 631D, 631E, 633D, 637E, 639D, 641B, 651B, 651E, 657B, 657E, 660B, 666B, 768B, 768C, 769B, 769C, 772, 772B, 773, 773B, 824, 824C, 825C, 826C, 834B, 983B, 988, 988B, 992, 992B, 992C, 3406, 3408, 3412, 3508, 3512, 3516, D343, D08, **CLARK:** 275K, 310, 310III, 310IIIH, 330IIIH, 380, 380III, 380IIIA, 380-2III, 380C-480, 410, 475III, 475B, 675, 675B, **CUMMINS:** série K, **INGERSOLL RAND:** DL 1200.



Delco

UF - 1.168
UF - 1.168/8 8 escovas / brushes

Especificações / Features: **24V, Tipo / Type: 40MT** - Escova / Brush: 9.5 x 19 x 19 (8 ESCOVAS RX70)

Original: 1948515

Partida / Starter:

Aplicação / Application: **CATERPILLAR, FIAT-ALLIS, JOHN DEERE**



Delco

UF - 1.181/4 4 escovas / brushes

Especificações / Features: **12V, Tipo / Type: 39MT** - Giro Sentido Horário / Clockwise Rotation -

Escova / Brush: 8 x 30 x 20

Original:

Partida / Starter: 8200288/ 289/ 290/ 291/ 308/ 417/ 468/ 469/ 470, 19011513/ 519

Aplicação / Application: **FREIGHTLINER:** C/ MOTOR CAT C10/C12/C15, C11/C13/C15, ACERT, **VOLVO:** MOTOR D11/ 12/ 13/16, **CUMMINS:** 3103915, ISX, ISM, N14 OU DDC 60 SERIES, **MACK:** C/ MOTOR E-7. MP7/ 8, **INTERNACIONAL:** MAXXFORCE 11, 13.

Delco



UF - 1.182/4 4 escovas / brushes

Especificações / Features: **24V, Tipo / Type: 39MT** - Giro Sentido Horário / Clockwise Rotation -

Escova / Brush: 8 x 30 x 20

Original:

Partida / Starter: 19011507, 19011509, 19011511, 19011522, 19011523, 19011524, 19011527, 8200034, 8200039, 8200101, 8200040, 8200465, 8200519

Aplicação / Application: **CNH:** COLHEITADEIRA DE CANA A7000 E A7700 COM MOTOR CUMMINS / SUGAR CANE LOADER A700 AND A7700 WITH CUMMINS ENGINE, **FIAT:** ALLIS MAT TRACTOR FC170, ALLIS GRADER FG170/170.2/200 E 200.2, **TEREX:** EMPILHadeira / FORKLIFT GEP 23, **CUMMINS:** 3102920 E 3103914.

Delco



UF - 1.184
UF - 1.184/4 4 escovas / brushes

Especificações / Features: **12V, Tipo / Type: 41MT** - Escova / Brush: 9,6 x 28,6 x 26,6, (Quatro pólos isolados / Four isolated poles)

Original: 10468705

Partida / Starter: 10479109

Aplicação / Application: **AGCO MASSEY-FERGUSON:** TRACTOR 2360 COM MOTOR CUMMINS / WITH CUMMINS ENGINE. **CATERPILAR:** COLHEITADEIRA / COMBINE MT875

Delco



UF - 1.185/4 4 escovas / brushes

Especificações / Features: **24V, Tipo / Type: 41MT** - Escova / Brush: 9,6 x 28,6 x 26,6, (Quatro pólos isolados / Four isolated poles)

Original: 10470208, 10453807, 10500113

Partida / Starter: 10478898

Aplicação / Application: **PLATAFORMA/ PLATAFORMS 0400 RSD E SRE (OUTUBRO 2004) - JUNHO 2009/ BUILDED FROM OCTOBER 2004 TO JUNE 2009**

Delco



UF - 1.188
UF - 1.188/6 6 escovas / brushes

Especificações / Features: **24V, Tipo / Type: 50MT** - Escova / Brush: 8 x 38 x 21,5 (6 escovas RX 124H).

Original: 1984974

Partida / Starter: 9000794 / 871

Aplicação / Application: **CATERPILAR:** 245, 346, 621B, 621E, 623E 631D, /E, 633D, 637E, 639D, 641B, 651B, /E, 657B, /E, 660B, 666B, 768B, /C, 769B, /C 769C, 772, /B, 773, /B, 824, /C, 825C, 826C, 834B, 983B, 988, /B, 992, /B, /C, 3406, /08, /12, 3508, /12, 3516, 4D343, D08, **CLARK:** 275K, 380, 475B, 675B, 310, 310III, 310IIII, 330IIII, 380, 380III, 380IIIA, 380-2III, 380C-480, 410, 475III, 475B, 675, 675B, **CUMMINS:** série K, **INGERSOLL RAND:** DL 1200.

Delco



UF - 1.189/6 6 escovas / brushes

Especificações / Features: **12V, Tipo / Type: 50MT** - Escova / Brush: 8 x 38 x 21,5

Original:

Partida / Starter: 10461056, 10461129, 10461191, 10461731, 10461738, 10461741, 10478813, 10478877, 10478881, 10478906, 10478910, 10478917, 10479201, 10479297, 10479309, 10479328, 10479336, 10479338, 10479341, 10479352, 10479382, 1109554, 1990261, 1990277, 1993859

Aplicação / Application: **CUMMINS, CHEVROLET / GMC HEAVY DUTY, FORD HEAVY DUTY, FREIGHTLINER, KENWORTH, PETERBILT, VOLVO, WESTERN STAR**

Delco



UF - 1.190/4 4 escovas / brushes

Especificações / Features: **24V, Tipo / Type: 38MT, 6,0 Kw - Escova / Brush: 9,5 x 28 x 22**

Original: _____

Partida / Starter: 8200053/ 072/ 078

Aplicação / Application: **VOLKSWAGEN:** 31.370, 25.370, 19.370 COM MOTOR 9,3 LITROS INTERNATIONAL / VWB – 18.310, 19.320, 31.320 – TITAN TACTOR E CONSTELLATION COM MOTOR CUMMINS ISC 8,3 LITROS, ÔNIBUS 19320EOT – QUÉOPS EVOLUTION COM MOTOR CUMMINS ISC 8,3 LITROS, 17-320 E, 18-320 EVO, 19-360 E, 24-320E, 25-320E, 25-370E, 25-400E – TODOS COM MOTOR CUMMINS, **FORD:** CARGO ELETRÔNICO -2632, 2932, 4532 E 5032.

Delco



UF - 1.191

UF - 1.191/2 2 escovas / brushes

UF - 1.191/4 4 escovas / brushes

Especificações / Features: **12V, Tipo / Type: 29MT, 3,3 Kw - Escova / Brush: 8 x 25 x 18**

Original: 10527547

Partida / Starter: 820003/ 0295/ 0196/ 0331/ 0478

Aplicação / Application: **MBB:** CAMINHÕES 710, 712E, 1418R, 1720, 1720K, L1620 - CHASSI DE ÔNIBUS LO 712, LO 812, LO 814 (TODOS COM MOTORES MECÂNICOS 12V OM 364 E OM 366). VWB, CAMINHÕES WORKER. 8-120 EURO II E III, 13-180 EURO II E III, 15-180 EURO III, 17-180 EURO III. (MOTOR MWM 4 E 6 CILINDROS) ÔNIBUS 8.120 OD EURO II E III (MOTOR MWM 4 CILINDROS), **VOLKSWAGEN:** 8-120, 9-150, 13-180, 17-180, 8-150, COM MOTOR MWM, 4 E 6 CILINDROS MECÂNICO, CAMINHÕES 8-150, 15-190, 17-250, 24-250 COM MOTOR CUMMINS ISB 4 E 6 CILINDROS COM CREMALHEIRA 10/12 ATÉ JUNHO 2009, **FORD:** CAMINHÕES C815E (4X2), C1317E (4X2), C1517E (4X2), C1717E (4X2), C1722E (4X2), C2422E (6X2), C2622E (6X4), C2428E (6X2), C2628E (6X4), COM MOTOR CUMMINS EIETRÔNICO ISB (4 E 6 CILINDROS)

Delco



UF - 1.192/2 2 escovas / brushes

UF - 1.192/4 4 escovas / brushes

Especificações / Features: **24V, Tipo / Type: 29MT, 4,0 Kw - Escova / Brush: 8 x 25 x 18**

Original: 10527548

Partida / Starter: 8200004/ 0064/ 0138/ 0296/ 0297/ 0054/ 0231/ 0292/ 0357/ 0386

Aplicação / Application: **MBB:** CAMINHÕES 1720A - CHASSI DE ÔNIBUS OF 1721, OH 1420, OH 1621L, OH 1623 (MOTORES MECÂNICOS 24V OM 364 E OM 366), GRADER 845, 845,2, FG 140.2, PÁ CARREGADEIRA W20, 521D, 621D, W130, MOTONIVELADORAS RG140.B, RG170.B (MOTORES CUMMINS B 4 E 6 CC), 712C, 715, 714C, 915C, 1215, 1218EL, 1218L, 1418 EL, 1418L, 1718, 1725, 2423, 2428, FAMÍLIA ATEGO (1315, 1418, 1518, 1718, 1725, 2425), L1318, 2423B, 2423K, L1620 CHASSI DE ÔNIBUS LO 914, 0500M/ U/ R, OF 1417/ 1418/ 1518/ 1721/ 1722 (MOTORES ELETRÔNICOS 24V OM 904/ 906/ 924/ 926). AXOR 1933 CAMINHÕES 8-150 ELETR DELIVERY PULS, 9-150E, 10-150E, 13-180E, 15-190E (ATÉ JUNHO 2009), 17-250E, 24-250E (ATÉ SET 2009) – MOTOR CUMMINS ISB 4 E 6 CIL. ÔNIBUS 8-150 ODC / FEB, 9-150 ODC - MOTOR CUMMINS ISB 4 E 6 CIL. **VOLKSWAGEN:** CONSTELLATION 13-180, 15-180, 17-260, 26-260E, 31-260E (MOTOR MWM ELETRÔNICO 4 E 6CC) ÔNIBUS 8-150ODM / ODM ELTR. / ODM DELIVERY, 9-150EOD, 15-190EOD, 17-210EOD, 17-230EOD/UTRONIC E 17-260EOD/UTRONIC (MOTOR MWM ELETRÔNICO 4 E 6 CC), 8-150 ELETR DELIVERY PULS, 9-150E, 10-150E, 13-180E, 15-190E (A PARTIR DE JUNHO 2009), 17-250E, 24-250E (A PARTIR DE OUTUBRO 2009) – TODOS COM MOTOR CUMMINS ISB 4 E 6 CIL. ÔNIBUS 8-150 ODC / FEB, 9-150 ODC - TODOS COM MOTOR CUMMINS ISB 4 E 6 CIL. CAMINHÕES 9-150 ELETR DELIVERY MOTOR CUMMINS A PARTIR DE JANEIRO 2010. **VOLVO:** CAMINHÕES VM 210, 260, 310 COM MOTORES MWM 4.12TCE E 6.12TCE (SUBSTITUI MELCO), **CASE:** MOTONIVELADORA RG140B E 845 COM TRANSMISSÃO ZF

Delco



UF - 1.193/4 4 escovas / brushes

Especificações / Features: **12V, Tipo / Type: PG260G - Escova / Brush: 5 x 16 x 12,5**

Original: 10453748

Partida / Starter: 9000871 / 846 / 794

Aplicação / Application: **CHEVROLET-GM:** S-10 4CC 2.2, ASTRA, VECTRA CD 2000 (OPEL), ZAFIRA (OPEL), **DAEWOO:** CIELO, ESPERO CD 2000, RACER, LANOS, LEGANZA, NEXIA, NUBIRA

Delco



UF - 1.220

UF - 1.220/4 4 escovas / brushes

Especificações / Features: 12V, Tipo / Type: 40MT - Escova / Brush: 9,5 x 38 x 19,5

Original:

Partida / Starter: 1945960, 1948518, 1949611, 1967552, 1967553, 1979185, 1979387, 1979494, 1979502 (DD Séries)

Aplicação / Application: CATERPILLAR

Delco



UF - 1.221

Especificações / Features: 12V, Tipo / Type: 8/ 10/ 15/ 20/ 25/ 27, 30/ 35 MT, SD 300, Conjunto reparo pólo positivo / Positive Repair Set

Original:

Partida / Starter: 7322 463 48

Aplicação / Application: CHEVROLET-GM: OPALA, CARAVAN 2500 4CC/ 4100 6CC (1969-1984), C-10, C-14, C-60 (GAS), ALLIS CHARMES, CADILLAC: 1957-1963, HYSTER, FORD: 1963-1964, AMC: 1959-1963, BUICK: 1957-1963, CHECKER CAB: 1964-1980, CHEVY/GMC: Trucks 1955- 1978, INTERNACIONAL TRUCKS: 1957-1979, JEEP: 1961-1971, OLDSMOBILE: 1957-1974, PONTIAC: 1956- 1974, STUDEBAKER: 1965-1966, APLICAÇÕES MARÍTIMAS/ MARINE APPLICATION: CHRIS CRAFT: 1967-1978, CRUSADER: 1961-1975, GRAY MARINE:1957-1967,JOHNSON-EVINRUDE: 1967-1978, MERCURY: 1971-1978, PALMER:1955-1963,UNIVERSAL: 1961-1964

Delco



UF - 1.228/4 4 escovas / brushes

Especificações / Features: 12V, Tipo / Type: PG260F2 - 1,5 Kw - Escova / Brush: 5 x 18 x 15

Original:

Partida / Starter: 9000836/ 837/ 841/ 842/ 854/ 857/ 858/ 888

Aplicação / Application: BUICK: LESABRE 3.8L (97-03), PARK AVENEU 3.8L (98-01), REGAL 3.8L (98-01), CHEVROLET-GM: BLAZER/ S-10 4.3L V6 VORTEC, CAMARO 3.8L (98-00), IMPALA (00), LUMINA 3.8L (98-99), MONTE CARLO 3.8L (98-00), SILVERADO 4.8L, 5.3L, SUBURBAN SIERRA/ YUKON XL 4.8/ 5.3L, TAHOE YUKON 4.8/5.3L, G1500, G2500 4.3L V6, S. TSERIES 4.3L V6, GMC: JIMMY, SAFARI, SIERRA 4.3L V6, SONOMA ISUZU: HOMBRE 4.3L V6, OLDSMOBILE: BRAVADA 4.3L V6, 88 3.8L (98-99),INTRIGUE 3.8L (98-99), PONTIAC: FIREBIRD 3.8L (98-01), GRAND PRIX 3.8L (97-00), CADILLAC, MERCURY MARINE

Delco



UF - 1.230/4 4 escovas / brushes

Especificações / Features: 12V, Tipo / Type: SD80 - Escova / Brush: 5 x 13 x 16

Original: 10475107 / 93740997

Partida / Starter: 10455503 /506 /515, 96275471, 96467385

Aplicação / Application: CHEVROLET-GM: AVEO 1.6L, MATIZ, NUBIRA 97 -> 03, DAEWOO: CIELO, MATIZ, TICO, REZZO, NISSAN: SENTRA 1.6, 1.8, 2.0, SUZUKI: WAGON R+ 1.2 4WDM, SWIFT 1.6L, PONTIAC: WAVE 1.6L

Ford / Motorcraft



UF - 1.108/4 4 escovas / brushes

Especificações / Features: 12V - Escova / Brush: 4,6 x 16 x 14

Original: F3RZ-11002C, F3RZ11061A/C

Partida / Starter: F772-11002AA, 93BB-11000

Aplicação / Application: FORD: BRONCO, ECOSPORT, EXPEDITION, EXPEDITION 6CL, EXPLORER 4.0 L V6, MONDEO, MUSTANG V6, RANGER, WINDSTAR V6

Ford / Motorcraft

UF - 1.109/4 4 escovas / brushes

Especificações / Features: 12V - Escova / Brush: 4,6 x 16 x 14

Original: E90Z-11061A/B /C

Partida / Starter: SB-331 / 335 / 337 / 348 / 353 / 356, E90F11000AA/BA, E95F11000AA/BA, F02F11000AA, F07U11000AA/BA, F0CF11000AA/BA, F0OU11000AA, F13U11000AA

Aplicação / Application: FORD: CONTOUR-4/6CL, COURIER, ESCORT 4CL, FIESTA, KA, MERCURE SABLE 6CL 3.0L, MONDEO, VAN WINDSTAR 6CL



Ford / Motorcraft

UF - 1.137/4 4 escovas / brushes

Especificações / Features: 12V, Tipo / Type: PMGR - Escova / Brush: 6 x 12,7 x 13,35

Original:

Partida / Starter: 96BB-11000-AA7, 19 BI, 96FB11000MG

Aplicação / Application: DAEWOO: RACER, CIELO, FORD: MONDEO, KA, ESCORT, FIESTA, CONTOUR LX /SE/ SPORT, FOCUS LE /LX/ S2/ SE/ STREET/ SVT/ ZTS/ ZTW/ ZX5, MERCURY: COUGAR, MYSTIQUE GL/ LS



Ford / Motorcraft

UF - 1.176/4 4 escovas / brushes

Especificações / Features: 12V, Tipo / Type: PMGR - Escova / Brush: 4,5 x 16 x 16,2

Original: F81U11434AA

Partida / Starter: F81Z11002AA, XL1Z11002AA, XW4U11000CG, XW4Z11002CG

Aplicação / Application: FORD: COURIER, RANGER, F-150, 4.6L/5.4L V8 (99-01), 6.8L V10, F-100, EXPLORER, TRANSIT, 4.6L V8 (99-01), 5.4L V8 (00-01), 6.8L V10 (00-01), EXCURSION, EXPEDITION, THUNDER BIRD, LINCOLN: BLACKWOOD, NAVIGATOR



Ford / Motorcraft

UF - 1.177/4 4 escovas / brushes

Especificações / Features: 12V, Tipo / Type: PMGR - Escova / Brush: 4,8 x 13 x 12

Original:

Partida / Starter: 10455505 / AA10018400 (DAEWOO)

Aplicação / Application: DAEWOO: TOWNER, FORD EURO



Ford / Motorcraft

UF - 1.183/4 4 escovas / brushes

Especificações / Features: 12V - Escova / Brush: 8,2 x 19,2 x 22,3

Original: F7RU11434BA, F7RUBA

Partida / Starter: 4878768, 93BB11000JB, 97BB11000BB / BC, 97CA11000AB, 97VB11000A / AA / AB / B / BA, 98AB11000AC / BC, 98VB11000B1A / B3A / BA, F3RZ11002A / 2B/ 2C, F50Y11002A, YC1U11000AB

Aplicação / Application: FORD: F-100, COURIER, RANGER DIESEL, TRANSIT, FIESTA, FOCUS, MONDEO, ESCORT, ORION



Hitachi / Mitsubishi

UF - 1.180 /4 4 escovas / brushes

Especificações / Features: 12V - Escova / Brush: 4,5 x 12 x 12,2

Original:



Partida / Starter:

Aplicação / Application: CHRYSLER, DODGE, HYSTER: EMPILHADEIRA / FORKLIFT, MITSUBISHI, NISSAN: VEÍCULOS COM MOTORES / VEHICLES WITH ENGINE GA15, RENAULT

Hitachi

UF - 1.205/4 4 escovas / brushes

Especificações / Features: 12V, Tipo / Type: PMGR - Escova / Brush: 4,5 x 14 x 17

Original:



Partida / Starter:

S114-753, C, S114-755, S114-756, S114-766A, S114-767, 752 1122-03 (DENSO)

Aplicação / Application:

ACURA, ISUZU, BMW: 335, NISSAN: SENTRA

Hitachi

UF - 1.214/4 4 escovas / brushes

Especificações / Features: 12V, Tipo / Type: OSGR - Escova / Brush: 7 x 19 x 15,2

Original: 2130-13022



Partida / Starter:

S13-121, 2,3 KW 12V, RFB S114482, RFB S131068, S13-114

Aplicação / Application:

ISUZU: 8.94478-863-0, KOMATSU: EMPILHADEIRA/ FORKLIFT FG40, NISSAN: EMPILHADEIRA / FORKLIFT, (PARTIDAS RFB S114482), CAPISTAR 2.3D, 2.3 TD, 2.5 TD, 2.7 TD, KING VAN 2.3 D, 2.5 D, URVAN 2.0, 2.3 TD, TD27, TERRANO 2.7 TD, PICK UP D. (PARTIDAS RFB S131068), GMC: 7.110

Hitachi

UF - 1.215/4 4 escovas / brushes

Especificações / Features: 12V, Tipo / Type: G/R 1,4 Kw - Escova / Brush: 6,8 x 14 x 15

Original: 2114-79001, 23378 M4901 23378 - m4901



Partida / Starter:

S114-252/ 253/ 254/ 255/ 257/ 258/ 264/ 296/ 322/ 344/ 357/ 393/ 429/ 458

Aplicação / Application:

NISSAN: CD17, ISUZU, MASSEY-FERGUSON, TOYOTA, YANMAR

Iskra

UF - 1.213/4 4 escovas / brushes

Especificações / Features: 12V - Escova / Brush: 10 x 25 x 23

Original: 16.906.708



Partida / Starter:

AZJ 3313 K4W Z9 11.130.664 / 679 / 695 / 739, AZJ 3216 / 3226 / 3236 / 3261, 15.0679 / 0695 / 0739 / 1063

Aplicação / Application:

NEW HOLLAND, VALTRA (VALMET): TRATORES

Magneti Marelli



UF - 1.139
UF - 1.139/2 2 escovas / brushes
UF - 1.139/4 4 escovas / brushes

Especificações / Features: 12V, Tipo / Type: E95R - Escova / Brush: 8 x 19 x 18,2

Original: 855 403 41

Partida / Starter: 632 218 31, 632 220 30 / 31 / 34 / 35 / 36 / 38 / 39, 632 221 30 / 31

Aplicação / Application: IVECO: FURGÃO, FIAT: DUCATO

Magneti Marelli



UF - 1.140
UF - 1.140/3 3 escovas / brushes

Especificações / Features: 12V, Tipo / Type: E80E 0,9-12 - Escova / Brush: 7 x 13 x 17,5

Original: 832 244 61, 832 253 26

Partida / Starter: 631 020 03, 631 020 04, 631 020 07, 631 020 08, 632 229 00, 632 229 01, 632 230 85, 632 231 01, 632 231 03, 632 231 08, 632 931 01

Aplicação / Application: FIAT: FIORINO - 1.0 / 1.5 / 1.6 / 2.0, PALIO, SIENA, STRADA - 1.0 / 1.3, TIPO, UNO MILLE

Magneti Marelli



UF - 1.141
UF - 1.141/4 4 escovas / brushes

Especificações / Features: 12V, Tipo / Type: E80 0,8/1-12 - Escova / Brush: 7 x 13 x 17,5

Original: 832 212 41

Partida / Starter: 632 228 31, 632 228 33, 632 228 36, 632 228 38, 632 230 31, 632 230 34

Aplicação / Application: FIAT: PALIO, SIENA - 1.6, STRADA - 1.6, TIPO, TOYOTA: 18R

Magneti Marelli



UF - 1.202/2 2 escovas / brushes

Especificações / Features: 12V - Escova / Brush: 7 x 13 x 17,5

Original: 9945553, 83225326

Partida / Starter: E80, E80E, 63101000 /02, 63201008, 63222889/97, 63222905

Aplicação / Application: FIAT: MILLE, SIENA 1.0 8V (FIRE) >01, PALIO 1.0 8V 96/00 ,1.0/1.3 8V (FIRE) >01

Mitsuba



UF - 1.199/4 4 escovas / brushes

Especificações / Features: 12V - Escova / Brush: 5 x 17 x 16

Original:

Partida / Starter: 31200-P30-902, SM402-13, SM402-13N, SM442

Aplicação / Application: HONDA

Mitsuba



UF - 1.216/4 4 escovas / brushes

Especificações / Features: **12V, Tipo / Type:** PMGR 1,6 Kw - Escova / Brush: 4,7 x 12 x 11,5

Original: 04312-PSA-305, 31210-PSA-J51

Partida / Starter: SM612-05, SM612-09, SM612-063M, SM612-09 (HONDA: 31200-RAA-A51 /RM /RAA43 /RAA51, 31200PPA505, 1200PPAA01 /02 /03 /51. LESTER 17816 /844 /870 /959)

Aplicação / Application: ACURA: TSX 2.4L, HONDA: ACCORD 2.4L, CR-V 2.4L, ELEMENT 2.4L

Mitsubishi



UF - 1.142

Especificações / Features: **12V, Tipo / Type:** ME20165A4 / OSGR / PLGR - Escova / Brush: 7 x 12 x 16

UF - 1.142/2 2 escovas / brushes

UF - 1.142/4 4 escovas / brushes

Original: M649X20471, ME701467

Partida / Starter: M8T 75071, ME201650, M2T84071, M2T87071, M2T87971, M 008 T75 071, M 002 T87 771 /71ZA/ 71ZT / 671, (MANDO MG-120413), TM000A36101

Aplicação / Application: AUDI, BOBCAT, CHEVROLET-GM: S10 C/ MOTOR MWM 2.8 SPRINT, CLARK, DODGE, FORD, HYUNDAI: H100 (COM PARTIDA DE MANDO), KIA: TS 2500, MAZDA, MITSUBISHI: L200 SPORT HPE/ OUTDOOR, PAJERO SPORT 2.8D, TRATOR, PLYMOUTH, RE-NAULT: MASTER ATÉ 2005, SUBARU, TOYOTA

Mitsubishi



UF - 1.143/2 2 escovas / brushes

Especificações / Features: **24V, Tipo / Type:** OSGR / PLGR - Escova / Brush: 7 x 12 x 17

UF - 1.143/4 4 escovas / brushes

Original: M649X20771, ME701495

Partida / Starter: M8T 80071, ME 012995, M8T80171, M8T85071

Aplicação / Application: BOBCAT, CLARK, MITSUBISHI: TRATOR, ONAN, TORO, TOYOTA

Mitsubishi



UF - 1.144

Especificações / Features: **12V, Tipo / Type:** OSGR / PLGR - Escova / Brush: 7 x 18 x 18,5

UF - 1.144/2 2 escovas / brushes

UF - 1.144/4 4 escovas / brushes

Original: M649T05071, ME700127

Partida / Starter: M2T54271, M2T65271, M2T54172, M2T54371, MG120413 (MANDO)

Aplicação / Application: ACURA, CASE, DODGE, KUBOTA: MOTORES FRIGORÍFICOS, MAZDA, MITSUBISHI: L-200, L-300 - TURBO, LIBERO, NISSAN: NISSAN FRONTIER 3.2 - 1999..., TORO, YALE, HYUNDAI: H1, H100, HR

Mitsubishi



UF - 1.145/2 2 escovas / brushes

Especificações / Features: **24V, Tipo / Type:** OSGR / PLGR - Escova / Brush: 7 x 18 x 18,5

UF - 1.145/4 4 escovas / brushes

Original: M649T05072, ME700140

Partida / Starter: M002T67871, ME017035, M002T67881, ME017085, M2T65271, M2T65272, M2T66272

Aplicação / Application: CASE, KUBOTA: MOTORES FRIGORÍFICOS, MITSUBISHI: CAMINHÃO, YALE

Mitsubishi



UF - 1.146/2 2 escovas / brushes
UF - 1.146/4 4 escovas / brushes

Especificações / Features: **12V, Tipo / Type: PLGR** - Escova / Brush: 8 x 24 x 18

Original: F4TZ-11061-A, SBE-351

Partida / Starter: M8T50171, F4TZ-11002B, M8T50071, M8T55171, ME087764, M008T60871 /872 /873 (32B66-02500)

Aplicação / Application: CATERPILLAR: 320C, FORD: VAN, PICK-UP - 7.3 L - DIESEL, MITSUBISHI

Mitsubishi



UF - 1.147/2 2 escovas / brushes
UF - 1.147/4 4 escovas / brushes

Especificações / Features: **24V, Tipo / Type: PLGR** - Escova / Brush: 8 x 24 x 18

Original: M649X20671, ME701448

Partida / Starter: M8T60071, ME077796, M8T60271, M8T60371, M8T60372, M8T60771

Aplicação / Application: CATERPILLAR: EMPILHADEIRA / FORKLIFT, FORD, MITSUBISHI: FUSO

Mitsubishi



UF - 1.155
UF - 1.155/2 2 escovas / brushes
UF - 1.155/4 4 escovas / brushes

Especificações / Features: **12V, Tipo / Type: PMGR** - Escova / Brush: 4,5 x 12 x 17

CABO CURTO / SHORT CABLE (85mm)

Original: M649T01271, MD611217

Partida / Starter: M1T60081 /281, M1T71381, M1T72581 /583 /681, M1T72583G, M1T73281 /283, M1T77881 /8981 /9081, TM000A08401

Aplicação / Application: CHRYSLER: NEON, STRATUS, CLARK: EMPILHADEIRA / FORKLIFT, DODGE: 1989 > 2000, HYUNDAI: ELANTRA, EXCEL, KOMATSU: EMPILHADEIRA / FORKLIFT, MAZDA - 1989 > 2000, MITSUBISHI: EMPILHADEIRAS / FORKLIFT, ECLIPSE 2.0, 3000GT, PAJERO 3.0, NISSAN: PULSAR, STANZA, EMPILHADEIRAS / FORKLIFT, TOYOTA: EMPILHADEIRA / FORKLIFT, YALE: EMPILHADEIRA / FORKLIFT

Mitsubishi



UF - 1.156
UF - 1.156/2 2 escovas / brushes
UF - 1.156/4 4 escovas / brushes

Especificações / Features: **12V, Tipo / Type: PMGR** - Escova / Brush: 4,5 x 12 x 17

CABO LONGO / LONG CABLE (110mm)

Original: M649T01271

Partida / Starter: M1T70381, M1T70481, M1T70485, M1T70781, M1T70881, M1T71081, M1T71281, M1T71581, M1T71681, M1T71881

Aplicação / Application: CATERPILLAR, CHEVROLET-GM, CHRYSLER, CLARK: EMPILHADEIRA / FORKLIFT C/ MITSUBISHI (CGP 25), DODGE: RAIDER 2.6L, RAM 50 PICKUP 2.0L, 2.4L, 2.6L, DODGE COLT: PLYMOUTH COLT 1.6L, DODGE COLT VISTA: PLYMOUTH COLT VISTA 2.0L, EAGLE: SUMMIT 2.4L, TALON 2.0L, FORD, GEO, HYUNDAI: EXCEL, H100, ELANTRA 1.6L, 1.8L, 2.0L, TIBURON 1.8L, 2.0L, SONATA 2.0L, TUCSON 2.0L, INFINITI, JEEP: CHEROKEE / WRANGLER (97-98), KIA: SPECTRA 2.0L, MAZDA: RX7 1.3L TURBO, RX7 1.3L, PICKUP 2.2L, MERCURY, MITSUBISHI: ECLIPSE 2.0L, 2.0L TURBO, 2.4L, EXPO 2.4L, GALANT 2.4L, NISSAN: D21, PATHFINDER 3.0 V6 90->95, PLYMOUTH, SUBARU, SUZUKI, YALE: EMPILHADEIRA / FORKLIFT C/ MITSUBISHI (CGP 25)

Mitsubishi



UF - 1.157
UF - 1.157/2 2 escovas / brushes
UF - 1.157/4 4 escovas / brushes

Especificações / Features: **12V, Tipo / Type: PMGR** - Escova / Brush: 4,5 x 18 x 17

CABO CURTO / SHORT CABLE

Original: F32Z-11061-B, SBE-342, 835 036 71, 832 244 61, 832 253 26

Partida / Starter: M1T74081, M1T74181, M1T74281, M1T74381, M1T74481, M1T74482, M1T74581, M1T74583, M1T74781, M1T74781A, M1T75281, M1T75283, M1T75381, M1T75681, M1T76281, M1T95081

Aplicação / Application: AMC, CHEVROLET-GM, DODGE, EAGLE, FORD, GEO, HYUNDAI, INFINITI, JEEP, MAZDA, MITSUBISHI, SUBARU, SUZUKI, TOYOTA: 2L, 3L

Mitsubishi



UF - 1.158
UF - 1.158/2 2 escovas / brushes
UF - 1.158/4 4 escovas / brushes

Especificações / Features: **12V, Tipo / Type: PMGR** - Escova / Brush: 4,5 x 18 x 17
CABO LONGO / LONG CABLE

Original: M649T01671, F32Z-11061-B, SBE342

Partida / Starter: M1T74283, M1T75181, M1T75581, M1T76081

Aplicação / Application: JEEP: CHEROKEE SPORT XJ, 1989 > 1998, MAZDA: 1989 > 1998

Mitsubishi



UF - 1.159
UF - 1.159/2 2 escovas / brushes
UF - 1.159/4 4 escovas / brushes

Especificações / Features: **12V, Tipo / Type: OSGR** - 4 CAVALETES / 4 Brackets - Escova / Brush: 7 x 10 x 18

Original: M649T04471, MD607420

Partida / Starter: M2T50181, M2T50585, M2T51085, M2T52181, M2T52681, M2T52881, M2T52882, M2T53181, M2T53781, M2T53785, M2T58581

Aplicação / Application: BOBCAT, CLARK, DODGE, FORD, GEHL, HYUNDAI: ACCENT, IHC, INGERSOLL-RAND, MAZDA, MELROE, MITSUBISHI, NISSAN, NISSAN: EMPILHADEIRAS / FORKLIFT, ONAN, PERKINS, PLYMOUTH, TORO, YALE: EMPILHADEIRA / FORKLIFT C/ PARTIDA MITSUBISHI

Mitsubishi



UF - 1.160
UF - 1.160/3 3 escovas / brushes

Especificações / Features: **12V, Tipo / Type: DD OSGR** - 3 CAVALETES / 3 Brackets - Escova / Brush: 7 x 10 x 18

Original: M649T04471

Partida / Starter: M2T20181D, M2T30481, M2T30581, M2T30981, M2T31081, M2T32281, M2T32581, M2T37081, M2T42381, M2T42985, M2T43681, M2T43781, M2T43881, M2T44781, M2T49881

Aplicação / Application: DODGE, EAGLE, FORD, HYSTER, HYUNDAI: EXCEL, JOHN DEERE, KIA, KUBOTA, LINCOLN ELECTRIC, MAZDA, MERCURY, MITSUBISHI, MITSUBISHI: EMPILHADEIRAS / FORKLIFT, NISSAN: EMPILHADEIRAS / FORKLIFT, ONAN, PLYMOUTH, SUZUKI, WOODS, HYSTER: EMPILHADEIRAS / FORKLIFT c/ partida 918139600, YALE: EMPILHADEIRAS / FORKLIFT c/ partida 010476 DN

Mitsubishi



UF - 1.178/4 4 escovas / brushes

Especificações / Features: **12V, Tipo / Type: PMGR** - Escova / Brush: 4,5 x 12 x 12,8 - Cabo longo / Long cable.

Original:

Partida / Starter: 9181 396-00 (FF184 00 / 000T92581), M0T60081 /82, M0T60186 /87, M0T80281 /381 /581 /783 /981, M0T81081 /281 /284 /681, M0T82081 /281, M0T83981, M0T84881ZC, M0T85081, M0T85881, M0T86481, M0T91181ZC, M1T78681, M1T79482, M1T84381, M1T84381/ 4981, M1T85881, M1T86081/ 6182

Aplicação / Application: CHEVROLET-GM, CHRYSLER: CONCORDE, CITROEN: C5 (01-04), PICASSO, DODGE: INTREPID 2.7L, HYSTER: EMPILHADEIRA / FORKLIFT. 95-05, JEEP, KIA: SPORTAGE, MAZDA: MPV 3.0L, PROTEGE 1.6L, 1.8L, 2.0L, MITSUBISHI: PAJERO/ MONTERO: 3.0L (00-03), 3.5L (99-04), 3.8L (01-02), MIRAGE 1.5L, 1.8L, NISSAN: 200SX 1.6L (95-98), EMPILHADEIRA / FORKLIFT, SENTRA 1.6L (95-99), FRONTIER 2.4L (99-01), PICKUP 2.4L, LIFT TRUCK NISSAN, XTERRA 2.4L (00-01), PEUGEOT: 206, 406 (99-04), PLYMOUTH, SUBARU: FOREST 2.5L, IMPREZA (97-03), 2.2L, 2.5L, OUTBACK 2.2L, 2.5L, SUZUKI

Mitsubishi



UF - 1.179/4 4 escovas / brushes

Especificações / Features: **12V, Tipo / Type: PMGR** - Escova / Brush: 4,5 x 12 x 12,8, Cabo curto / Short cable.

Original:

Partida / Starter: M000T843814, MD61 9097 / 9311

Aplicação / Application: HYSTER: EMPILHADEIRA / FORKLIFT. 95-05: CHRYSLER, DODGE, MAZDA, MITSUBISHI, NISSAN, SUBARU

Mitsubishi

UF - 1.187/4 4 escovas / brushes

Especificações / Features: **24V** - Escova / Brush: 8 x 30 x 18,2

Original:

Partida / Starter: M009T644471ZA (2T0911023G) , MM0097662572ZA, 2509110223A

Aplicação / Application: **VOLKSWAGEN:** CONSTELLATION 25 370, **VOLVO:** NH / FH



Mitsubishi

UF - 1.200/4 4 escovas / brushes

Especificações / Features: Escova / Brush: 5 x 17 x 16

Original:

Partida / Starter: SM 402-03, SM 402 202

Aplicação / Application: **ISUZU, ACURA, HONDA:** CIVIC, ACCORD 2.2L, PRELUDE 2.2L /2.3L, ODYSSEY 2.2L /2.3L



Mitsubishi

UF - 1.231/4 4 escovas / brushes

Especificações / Features: **12V, 0,8 Kw** - Escova / Brush: 5 x 10,6 x 12,5

Original:

Partida / Starter: M2T40081, M3T32581 /82 /83 /91 /92 /93, M3T41081 /83, M3T42781, Mitsubishi Motors MD001333, MD034120, MD066761, MD081567 /568, MD100431, MD162836 /837 /838, MD180239. MANDO LESTER 16-940, MANDO MC109032, M39376

Aplicação / Application: **HYUNDAI:** ELANTRA, EXCEL, SITEMA, **DODGE:** 81-94, PLYMOUTH 1.4L, 1.5L, 1.6L, 1.8L, 2.0L, 2.4L, **EAGLE:** 89-96, ENGINES 1.5L, 1.8L, 2.4L, **MITSUBISHI:** 83-96, ENGINES 1.5L, 1.6L, 1.8L, 2.0L, 2.4L



Mitsubishi

UF - 1.234/4 4 escovas / brushes

Especificações / Features: **12V, Tipo / Type: MR9943 (PMGR)** - 1,2 Kw - Escova / Brush: 4,5 x 12 x 12 - GIRO SENTIDO HORÁRIO / Clockwise Rotation

Original:

Partida / Starter: M00T30771, M000T32071ZC, M000T32071, MOT32071, MOT32071ZC. (CHRYSLER 05034555AA, 5034555AA)

Aplicação / Application: **MITSUBISHI:** PAJERO TR4, PAJERO IO 2.0L 1999-2003, LANCER 1.6/ 2.0 2003-2007, COLT 1.6 /2.0 2003-2007, **CHRYSLER:** SEBRING 2.4L(144) L4 2007-2009, **DODGE:** AVENGER 2.4L(144) L4 2008-2009, CALIBER 1.8L(110) L4 2007-2009, CALIBER 2.0L(122) L4 2007-2009, CALIBER 2.4L(144) L4 2007-2009, JOURNEY 2.4L(144) L4 2009, **FIAT:** FREEMOUNT, **JEEP:** COMPASS 2.0L(122) L4 2007-2009, COMPASS 2.4L(144) L4 2007-2009, PATRIOT 2.0L(122) L4 2007-2009, PATRIOT 2.4L(144) L4 2007-2009



LANÇAMENTO
New product

Nippondenso

UF - 1.153

Especificações / Features: **12V, Tipo / Type: OSGR** - Escova / Brush: 8 x 25 x 21

UF - 1.153/2 2 escovas / brushes

UF - 1.153/4 4 escovas / brushes

Original: 28140-77090, 3964427

Partida / Starter: 028000-5520/ 5880/ 6880/ 6561/ 5560/ 7221/ 7231/ 9160/ 9040, 128000-0216 /5090 /1560 /4111, 28100-58030 /54260, 428000-1850

Aplicação / Application: **ALLIS-CHALMERS, ASIA MOTORS:** TOPIC, CASE, CATERPILLAR, CUMMINS, DAIHATSU, DODGE, HINO, ISUZU, TRUCK, JOHN DEERE, KOMATSU, KUBOTA, MITSUI-DEUTZ, TELEDYNE/CONTINENTAL, TOYOTA: EMPILHADEIRA / FORKLIFT., VERSATILE, WHITE, YANMAR, TOYOTA: BANDEIRANTES COM MOTOR 14B, **HYUNDAI:** H100



Nippondenso



UF - 1.154

Especificações / Features: 12V, Tipo / Type: OSGR - Escova / Brush: 8 x 25 x 15, Base Ø 74,9

UF - 1.154/2 2 escovas / brushes

UF - 1.154/4 4 escovas / brushes

Original: 028510-0640, 28140-50020, 28140-54070

Partida / Starter: 028000-9030, 028000-8130, 028000-7001, 028000-7791, 028000-2880, 028000-7370, 028000-7372, 028000-7373, 128000-0040, 128000-1180, 128000-0960, 228000-0240, 228000-0400 /5023, 28100-67050

Aplicação / Application: ALLIS-CHALMERS, CATERPILLAR, CHEVROLET-GM, DODGE, GMC, ISUZU, KIA MOTORS: BESTA 2.7, KOMATSU, KUBOTA, LEXUS, MITSUI-DEUTZ, THERMO KING, TOYOTA: HILUX 2.8 (<-2002)

Nippondenso



UF - 1.161

Especificações / Features: 24V, Tipo / Type: OSGR - Escova / Brush: 8 x 25 x 21

UF - 1.161/2 2 escovas / brushes

UF - 1.161/4 4 escovas / brushes

Original: 028510-0500, 28140-77090

Partida / Starter: 028000-5530 / 5690 / 5300 / 5570 / 6460 / 6200 / 7810 / 5860 / 5861 / 5550 / 6010 / 6012 / 9040 / 9760 / 9140, 128000-1560 / 1561 / 1570 / 1571 / 8620 / 8621

Aplicação / Application: ALLIS - CHALMERS, ASIA MOTORS: TOPIC, CASE, CATERPILLAR, CUMMINS, DAIHATSU, DODGE, HINO, ISUZU: TRUCK, JOHN DEERE, KOMATSU, KUBOTA, MITSUI-DEUTZ, TELEDYNE/CONTINENTAL, TOYOTA: EMPILHADEIRA / FORKLIFT, COASTER, VERSATILE, WHITE, YANMAR

Nippondenso



UF - 1.169/4

Especificações / Features: 12V, Tipo / Type: OSGR - Escova / Brush: 10 x 30 x 20

Original: 028510-0880, 1.81118-0430, 28140-1310A

Partida / Starter: 128000-0492 / 2450 / 2470 / 4220 / 4910 / 5370 / 5510 / 5620 / 5730, 81100-234-0, 228000-331 / 332 / 573 / 585 / 6870

Aplicação / Application: CATERPILLAR, CUMMINS, CASE, ISUZU

Nippondenso



UF - 1.170/4

Especificações / Features: 24V, Tipo / Type: OSGR - 5,5 Kw - Escova / Brush: 10 x 30 x 20

Original: 028510-0880, 181118-043-0, 28140-1310A

Partida / Starter: 128000-4250 /2740, 128000-4685, 128000-2560

Aplicação / Application: CATERPILLAR, CUMMINS, CASE, DODGE: TRUCK (DIESEL), ISUZU, CASE

Nippondenso/Denso/Delco



UF - 1.208/4

Especificações / Features: 12V, Tipo / Type: OSGR - Escova / Brush: 7 x 16 x 16

Original: 028510-0750 / -5320

Partida / Starter: 12 800-701 / 712 / 756 / 771 / 822 / 845 / 878 / 938 / 975, 22 800-036 / 047 / 071 / 090 / 162 / 255 / 301 / 303 / 328 / 399 / 642 / 720 / 8110 / 8111, DELCO: 10455703 / 709, DENSO FIRST TIME: 280-0299

Aplicação / Application: ACURA, CHRYSLER, DODGE, EAGLE, GEO, GM: CORVETTE V8 5.7L (350) 88-91 92-96, HONDA, ISUZU, PLYMOUTH, TOYOTA: EMPILHADEIRA / FORKLIFT, HARLEY-DAVIDSON

Nippondenso



UF - 1.209/4 4 escovas / brushes

Especificações / Features: **12V, Tipo / Type: OSGR - Escova / Brush: 6,5 x 12,9 x 14,2**

Original: 028510-5190

Partida / Starter: 128000-5210 / 5211 / 5680 / 5682 / 6420 / 6422 / 6720 / 6721 / 7400, 22800-7091 / 9642, 428000-0321 / 0960 / 3420

Aplicação / Application: **DENSO, GEO, HONDA:** CIVIC 1.7L (2001-2004), 1.8L (2006-2008), FIT 1.5L (2007-2008), **ISUZU, KUBOTA:** EMPILHADEIRA / FORKLIFT, **TOYOTA, SUZUKI, YANMAR**

Nippondenso



UF - 1.211/4 4 escovas / brushes

Especificações / Features: **12V, Tipo / Type: OSGR - Escova / Brush: 8 x 25 x 15, Base Ø = 81,7**

Original: 028510-5010

Partida / Starter: 128000-0832 / 5350 / 5760 / 9560, 22800-0200 / 0391, 28140-60040-000

Aplicação / Application: **KIA / ASIA MOTORS:** BESTA 2.7, 2.8, 3.0, CAMINHÃO BONGO, **DAIHATSU**

Nippondenso



UF - 1.212/4 4 escovas / brushes

Especificações / Features: **12V, Tipo / Type: OSGR - Escova / Brush: 7 x 25 x 15,5**

Original: 028510-5800

Partida / Starter: 28100-54380, 228000-2120 / 2680 / 2690 / 2700 / 2980 / 3260 / 3840 / 3850 / 3851 / 4570 / 4571 / 4580 / 4590 / 4740 / 4750 / 5120 / 5861 / 8430 / 8440

Aplicação / Application: **ACURA, DODGE, GEHL, LEXUS, HYSTER, PETTER, NEW HOLLAND, TOYOTA:** SL, DYNA 100 (95->) / 150 2.4 (87-88), HIACE 2.4 (84-89) / HILUX 2.4 (89->), LAND CRUISER 2.4D (84->), **YALE**

Prestolite



UF - 1.130

Especificações / Features: **12V, Tipo / Type: M93R - Escova / Brush: 8 x 19 x 18,2**

UF - 1.130/2 2 escovas / brushes

(DELPHI / LUCAS) KO 12066

UF - 1.130/4 4 escovas / brushes

Original: 352.58.637 KO 12038 / KO 12039

Partida / Starter: 352.58.580 / 940 / 950 / 490 / 540 / 660 / 690 / 710 / 820 / 880 / 960, 352.59.040 / 400, 352.613.05

Aplicação / Application: **AGRALE:** ÔNIBUS VOLARE, **CHEVROLET-GM:** BLAZER DLX, PICK-UP S10 C/ MOTOR MAXION HS, PICK-UP D20, SILVERADO C/ MOTOR MWM, **CUMMINS:** MOTORES SÉRIES 6BT (DIANTEIRO) / B6 / BT5.9L, **FORD:** CARGO 1416 / 1722 / 1716, F-1000, F-14000 C/ MWM, PICK-UP F-100 / F-1000 / RANGER, **JOHN DEERE:** TRATORES, **MASSEY-FERGUSON:** TRATOR C/ MOTOR 4 CIL., **MAXION:** MOTORES, **MERCEDES-BENZ:** 180D - KOMBI ESPANHOLA, ÔNIBUS, CAMINHÕES, **SPRINTER C/ MOTOR MAXION HS,** **PERKINS:** MOTORES 4.203 / 3.152 / 4.236 / 6.354, **PEUGEOT:** 504, 505, VÁRIOS C/ MOTOR INDENOR, **VOLKSWAGEN:** CAMINHÃO, **LAND ROVER:** DEFENDER / DISCOVERY 4CC 2.5 15-160

Prestolite



UF - 1.135

Especificações / Features: **12V, Tipo / Type: M74R - Escova / Brush: 4,5 x 14 x 17**

UF - 1.135/2 2 escovas / brushes

(DELPHI / LUCAS)

UF - 1.135/4 4 escovas / brushes

Original: 352.58.566

Partida / Starter: 352.58.400, 352.58.430, 352.58.510, 352.58.560, 352.58.600, 352.58.730, 352.58.750, 352.58.790, 352.58.850, 352.58.860, 352.58.890, 352.612.60

Aplicação / Application: **CHEVROLET-GM:** PICK-UP C20, SILVERADO - C/ MOTOR 6 CIL. GASOLINA, CORSA 1.4 / 1.6, CORSA COMBO 1.4 / 1.6, **FIAT:** 128 SUPER EUROPA, 147 BRIO/SPR/SPT, DUNA 1300/1500/1.4/1.6, FIORINO 1.4/1.6, PICK-UP 1.4/1.6, REGATTA 85 S 1300/1500 / TIPO 1.4 / 1.6, REGATTA SC 1300/1500, REGATTA WEEKEND 1300/1500, SPAZIO 1300/1500, UNO 1.4/1.6, VÁRIOS 1.3/1.5, **RENAULT:** CLIO 1.8 / 1.6, R 19 1.8/1.4/1.6/1.7 C/ CARBURADOR, 19 1.8/1.6, **PEUGEOT:** 205 / 306 / 405 / BOXER, **FORD:** ESCORT ZETEC '97/1.8/2.0, FOCUS-ZETEC 1.8, MONDEO 1.8/2.0/ZETEC, FIESTA 1300 / 1.4 (COM E SEM AR), RANGER DURATEC 2.3 GAS. / 3.0L NGD INT., **NISSAN:** FRONTIER, XTERRA, **TROLLER:** T4 3.0L NGD INT., **VOLKSWAGEN:** GOL 1.6/1.8/2.0 (COM AR) / 1.000 (BRASIL), SAVEIRO CHT 1.6

Prestolite



UF - 1.195		Especificações / Features: 24V, Tipo / Type: M100 - Escova / Brush: 8 x 25 x 21
UF - 1.195/2	2 escovas / brushes	(DELPHI / LUCAS / INDIEL)
UF - 1.195/4	4 escovas / brushes	Original: K-01266
Partida / Starter:	352.59.240 / 440 / 460 / 770 / 780, 352.61.000 / 130	
Aplicação / Application:	CUMMINS, MWM, MERCEDES-BENZ	

Prestolite



UF - 1.196/2	2 escovas / brushes	Especificações / Features: 12V, Tipo / Type: M100 - Escova / Brush: 8 x 25 x 21
UF - 1.196/4	4 escovas / brushes	(DELPHI / LUCAS / INDIEL)
		Original: K-01236, 35262079
Partida / Starter:	352 59 200 / 260 / 290 / 450 / 500 / 510 / 520 / 530 / 550 / 730 / 810 / 820 / 830 / 840, 352.60.830 / 840 / 900 / 910, 352.61.050 / 160	
Aplicação / Application:	CATERPILLAR, CHRYSLER, CUMMINS, FORD, FREIGHTLINER, GRADALL, INTERNATIONAL NAVISTAR, JOHN DEERE, DODGE: RAM 2.500 CUMMINS 6CC 5.9L., VOLKSWAGEN	

Valeo



UF - 1.138/2	2 escovas / brushes	Especificações / Features: 12V, Tipo / Type: D6RA, PMGR - Escova / Brush: 4,5 / 9T x 11 x 18
		Original: 133647, 594070
Partida / Starter:	432598 (D6RA5), 432622 (D6RA133), 438127 (BD7E10), D6RA5 / 6 / 12 / 16 / 18 / 20 / 61 / 65 / 85 / 165 / 185	
Aplicação / Application:	RENAULT: CLIO 1.8i, LAGUNA 1.8i / 2.0i, MÉGANE 1.6i / 2.0i, R19 1.4i / 1.6 / 1.8, CHEVROLET-GM: CORSAEFI 1.0 / MPFI 1.0, PEUGEOT: 309 - 1.1, 1.4, 405 - 1.4, CITROEN: AX -1.0,1.1,1.3,1.4, BX-1.0, XSARA 1.6, XM V6TT	

Valeo



UF - 1.163/4	4 escovas / brushes	Especificações / Features: 12V, Tipo / Type: D7G11 - Escova / Brush: 7 x 13 x 10,8
		Original:
Partida / Starter:	8200225336 / 338 (D7G11)	
Aplicação / Application:	RENAULT: MASTER ELETRÔNICO DCI120 (2005 >)	

Valeo



UF - 1.171/4	4 escovas / brushes	Especificações / Features: 12V, Tipo / Type: D7E, DD - Escova / Brush: 6,5 x 8 x 11
		Original: 187517, 594351, 594479, 594290
Partida / Starter:	D7E4 / 6 / 8 / 11 / 15 / 18 / 19 / 20 / 22 / 23 / 27 / 28 / 39 / 52, D7ED28, BD7E17 / 44	
Aplicação / Application:	FIAT: PALIO, STILO, CHEVROLET-GM: ASTRA, CELTA, CORSA, MERIVA, PEUGEOT: 206, RENAULT: CLIO, KANGOO, MEGANE, R19, R11, R12, R19, SCENIC, KIA: SPORTAGE	



UF - 1.172/2 2 escovas / brushes

Especificações / Features: **12V, Tipo / Type: PMGR** - Escova / Brush: 4,7 / 9T x 11 x 14

Original: 181961, 594072

Partida / Starter: D6RA8 /10 /572

Aplicação / Application: PEUGEOT, DEUTZ, JEEP, LOMBARDINI, MERCEDES, SATURN, TORO, VOLVO PENTA



UF - 1.173/3 3 escovas / brushes

Especificações / Features: **12V, Tipo / Type: DD** - Escova / Brush: 6,5 x 8 x 11

Original: 494818

Partida / Starter: USC 867838-864608 G, D7E34

Aplicação / Application: FORD: FIESTA, COURIER, KA, ESCORT, ECOSPORT

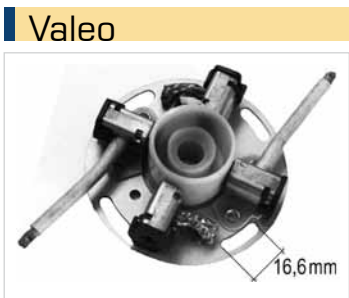

UF - 1.186/4 4 escovas / brushes

Especificações / Features: **12V, Tipo / Type: D7R Series** - Escova / Brush: 7 x 14 x 14

Original:

Partida / Starter: 0041518901, 004151890180, 0041519201, 004151920180, 0041519701, 004151970180, 0051511301, 005151130180, 005151130187, D7524, D7R1 /2 /3 /4 /5 /8 /11 /12 /14 /15 /16 /17 /18 /19 /20 /22 /25 /26 /27 /28 /33 /34 /35 /36 /40 /41 /42 /43 /44 /46 /47 /48 /49 /51 /53 /57 /64 /65 /70 /S1 /S7 /S29 /S30 /S31 /S50 /S129 /S130 /S131 /S150 / SA2 /SA4 /SA5 /SA7 /SA8 /SA10 /SA11, TM000A36101 (DSL 36100-42350)

Aplicação / Application: HYUNDAI: HR, H100, KIA: BONGO, MB: SPRINTER CDI 311/313, MITSUBISHI: L200, KATANA, RENAULT: MASTER 2010->



UF - 1.203/4 4 escovas / brushes

Especificações / Features: **12V, Tipo / Type: D7E, DD** - Escova / Brush: 6,5 x 8 x 11

Original: 594381

Partida / Starter: D7ES6

Aplicação / Application: VOLKSWAGEN: PÓLO, GOLF 1.6 E FOX



UF - 1.204/3 3 escovas / brushes

Especificações / Features: **12V, Tipo / Type: D7E, DD** - Escova / Brush: 6,5 x 8 x 11

Original: 594290

Partida / Starter: D7E1 / 16 / 24 / 29 / 30 / 31 / 32 / 33 / 35 / 36 / 37 / 39 / 43

Aplicação / Application: FIAT: 147, DUNA, ELBA, FIORINO, OGGI, PALIO, PANORAMA, PICKUP, PREMIO, SIENA, SPAZIO E UNO, FORD: FIESTA, COURIER, KA, ESCORT E ECOSPORT, PEUGEOT: 206

Valeo



LANÇAMENTO
New product

UF - 1.207/4 4 escovas / brushes

Especificações / Features: **12V, Tipo / Type: OSGR** - 3,1 Kw - Escova / Brush: 9 x 18 x 22 - Giro Sentido Horário / Clockwise Rotation

Original: 182318

Partida / Starter: D9R73, D9R116, D9R144, 184202, 455537, 184202

Aplicação / Application: **RENAULT:** TRAFIC DIESEL, **VOLVO PENTA:** EMBARCAÇÕES COM MOTORES DIESEL / **MARINES DIESEL ENGINES:** 21-42 SERIES : API MARINE #15097OE, ARCO #97255, IAT, AD31A/ B, AD41B, AQAD30A, AQAD31A, AQB41, AOD40A, AQAD40A, AQD41 / DP / SP, AQAD 41 / DP / SP, D40 / TD40, KAD43P, KAD43PA, KAD44P, MD 30 / TMD 30 / TAM30, MD5C / MS2, TAM31, TAM41B , TDM 40/ 41, TAM4 61B, KAD 42, KAMD300, KAD300A

Valeo



UF - 1.229/4 4 escovas / brushes

Especificações / Features: **12V** - Escova / Brush: 7 x 14 x 14

Original:

Partida / Starter: 432644, 455720, 0986017260, 001109250, 550.509.102, 0031512901 /9801, 0041518901 /9201 /9701, 0051511301 /6601, 5151130180 /187, A0031512901 /9801 /3501, A0041514401 /5601, D7R1 /2 /3 /4 /5 /6 /7 /11 /19 /28 /34 /35 /43 /44 /46 /47 /48, D9R149, ND162, GXE4850

Aplicação / Application: **MERCEDES-BENZ:** CLASSE C, E, S, G, V, CLK, SPRINTER, UNIMOG, VIANO, VITO, VARIO

Valeo



LANÇAMENTO
New product

UF - 1.232/4 4 escovas / brushes

Especificações / Features: **12V, Tipo / Type: D6 / D7 Series** - 0,9 Kw - 9 Dentes / Teeth, 25 mm -

Escova / Brush: 3,5 / 6,5T x 10 x 15 - Giro Sentido Horário / Clockwise Rotation

Original: 195253

Partida / Starter: AC713850M, D6G3, 9648644680, 9618725080, 436062, 438093, 438129,455748, D6RA100, DGRA37, D6RA57, D6RA571, D6RA572, D7E16, D7E3, D7E5, D7E51, D7E16, D7E23, D7E5

Aplicação / Application: **CITRÔEN:** C3 1.6, C4 XSARA PICASSO 1.6 16V 2007 ->, C4 1.5 2005 ->, BERLINGO 1.1/1.4/1.6i, **PEUGEOT:** 206 1.4/1.6 16V 2000 ->, 307 1.4/1.6, PARTNER 1.1/1.4/1.6i, RANCH 1.4i, **RENAULT:** CLIO 1.6 16V 2000 ->, KANGOO 1.6 16V (K4M 2000 MOTOR / ENGINE)



UNIFAP

www.unifap.com.br

Bosch

UF - 2.201/2 2 escovas / brushes

Especificações / Features: **14V, Tipo / Type: K1** - Escova / Brush: 5 x 10 x 17

Original: 1 124 336 050

Alternador / Alternator: 9 120 080 012, 9 120 080 182, 9 120 080 183

Aplicação / Application: **AGCO:** NOVOS TRATORES, **AGRALE-DEUTZ:** 8001 - 8501 TDX, **CASE:** 2000 - 2470, 4000 - 4490, W 36, **KOMATSU:** D 30 E **MASSEY-FERGUSON:** SÉRIES MF 1000 / 3000 / 4000 / 5000 / 6000, **MAXION:** MAXION IDEAL 1175 / 9070 / 9075 / 9090 ; 750 ; 9150 / 9170, SÉRIE D C/ MOTOR D 229-6, **SLC:** 6000 - 6200 / 6200 TURBO ; 7000 - 7200 / 7700 / TURBO, **MERCEDES-BENZ:** SÉRIES - 6T L, 8T L, 10T L, 11T L, 12T L, 13T L, 14T L, 14T LP, 15 T L, 16 T L, 17 T L, 18 T L, 20 T L, 22 T L, 23 T L, SÉRIES - 24 T, O, OF, OH, **AGRALE-DEUTZ:** 1600 D, 4200 / 4230 / 4300, M 80 / 85 / 90, TX 1600, **CASE:** W18, W 20 B, **CBT:** 1065 / 1105 / 2080 / 2105 / 8060 4X4 / 8240 / 8260 4X4, **KOMATSU:** D 50 A, **MÜELLER:** VIBRO RT 62, **MWM-DIESEL:** SÉRIE D C/ MOTOR D 229-3 / 229-4 / 229-6 / TD 229-6, **TOYOTA:** BANDEIRANTE



Bosch

UF - 2.202/2 2 escovas / brushes

Especificações / Features: **12V** - Escova / Brush: 6,3 x 6,3 x 12,7

Original: 419001

Alternador / Alternator:

Aplicação / Application: **FORD:** CORCEL, F1000, F4000, MAVERICK, **CATERPILLAR:** TRATORES, **CLARK:** TRATORES, **DODGE:** POLARA, **MASSEY-FERGUSON:** TRATORES, **MERCEDES-BENZ:** CAMINHÕES, **VALMET:** TRATORES



Bosch

UF - 2.204/2 2 escovas / brushes

Especificações / Features: **24V** - Escova / Brush: 5 x 10 x 17

Original: 1 124 336 057

Alternador / Alternator:

Aplicação / Application: **MWM :** MOTORES, **MERCEDES-BENZ,** **SCANIA,** **VOLVO**



Bosch

UF - 2.206/2 2 escovas / brushes

Especificações / Features: **12V** - Escova / Brush: 6,3 x 6,3 x 12,7

Original: 419008

Alternador / Alternator:

Aplicação / Application: **FORD:** CAMINHÕES, **VOLKSWAGEN:** CAMINHÕES



Bosch

UF - 2.212/2 2 escovas / brushes

Especificações / Features: **12V** - Escova / Brush: 5 x 8 x 15

Utilizado com / Used with GAUSS GA-009

Original: 9 121 080 281

Alternador / Alternator: 9120 080 041 /061 /072 /090 /122, F 000 LD0 108

Aplicação / Application: **VOLKSWAGEN:** BRASÍLIA, KOMBI, SEDAN, FUSCA, GOL, SAVEIRO, (REFRIGERADOS AAR)



Delco

UF - 2.203/2 2 escovas / brushes

Especificações / Features: **12V** - Escova / Brush: 5 x 8 x 13,2

Original: 3472316

Alternador / Alternator:

Aplicação / Application: **CHEVROLET-GM:** CHEVETTE - 1973 >, OPALA - 1973 >



Delco



UF - 2.205/2 2 escovas / brushes **Especificações / Features:** 12V - Escova / Brush: 5 x 8 x 18

Original: 1876876, D 776, 1984462

Alternador / Alternator: 10SI / 12SI / 27SI . TYPE 100 . IR / EF
Aplicação / Application: CHEVROLET-GM: MONZA , OPALA, CARAVAN

Delco



UF - 2.211/2 2 escovas / brushes **Especificações / Features:** 12V - Escova / Brush: 5 x 8 x 22

Original: 10472881 / 10473364 / 10490180

Alternador / Alternator: 1101218 / 1101196 / 1101199 / 1101551 / 10480125 / CS121 / CS130
Aplicação / Application: CHEVROLET - GM, DAEWOOD, OPEL, VAUXHALL

Delco



UF - 2.213/2 2 escovas / brushes **Especificações / Features:** 12V/24V - Escova / Brush: 5 x 6 x 22

Original: 1979724, 10467934

Alternador / Alternator: 19010205, 15SI / TYPE 116, 21SI, SERIES IR / EF
Aplicação / Application: MERCEDES-BENZ

Delco



UF - 2.214/2 2 escovas / brushes **Especificações / Features:** 12V - Escova / Brush: 4,5 x 8 x 22

Original: 10475011

Alternador / Alternator: Delco Coreano 100A, CS130D, 3493947, 10479914, 10479914, 1047923, 947, 955
Aplicação / Application: CHEVROLET - GM, DAEWOOD, OPEL, SAAB, VAUXHALL

Delco



UF - 2.215/2 2 escovas / brushes **Especificações / Features:** 12V - Escova / Brush: 4,5 x 8 x 22

Original: 10475746

Alternador / Alternator: Delco CS 130D série IR / IF, 10479214, 10479215
Aplicação / Application: CHEVROLET-GM, BUICK, PONTIAC, OLDSMOBILE, DAEWOOD

Delco



UF - 2.219/2 2 escovas / brushes **Especificações / Features:** 12V, 140A - Escova / Brush: 5 x 8 x 22

Original: 1989702

Alternador / Alternator: 10480124, 10479809, 10479817, D775, CS144 - IR / IF SERIES
Aplicação / Application: CHEVROLET-GM

Delco



UF - 2.220/2 2 escovas / brushes **Especificações / Features:** 12V, Escova com guia de molas / Brush with guide to spring - Escova / Brush: 5 x 8 x 18

Original: 1876873, D766

Alternador / Alternator: 27 SI / TYPE 200 SERIES IR / EF
Aplicação / Application: CHEVROLET - GM

Ford / Motorcraft



UF - 2.216/2 2 escovas / brushes

Especificações / Features: 12V - Escova / Brush: 4 x 7,5 x 18

Original: F1DZ-10347-A

Alternador / Alternator: GB320, IR / IF 3G SERIES, 2C2U - 10300-BB, F6AU-10300-AA / AB

Aplicação / Application: FORD: F250, F-350, F-1000, CONTINENTAL, COUGAR, ESCORT, EXPLORER, SABLE, LINCOLN, MERCURY, RANGER, TAURUS, TEMPO, THUNDERBIRD, TRACER, TOPAZ, TOWN CAR

Ford / Motorcraft



UF - 2.217/2 2 escovas / brushes

Especificações / Features: 12V - Escova / Brush: 4 x 7,5 x 18,5

Original: E9PU-10320-AA

Alternador / Alternator: E9DF-10300-CA, F0DF-10300-AA, F1VU-10300-BB, 3G SERIES IR / IF

Aplicação / Application: FORD: F250, F-350, F-1000, BRONCO 3.6, CONTINENTAL, COUGAR, ESCORT, EXPLORER, SABLE, LINCOLN, MERCURY, RANGER, TAURUS, TEMPO, THUNDERBIRD, TRACER, TOPAZ, TOWN CAR

Ford / Motorcraft



UF - 2.218/2 2 escovas / brushes

Especificações / Features: 12V - Escova / Brush: 4 x 7,5 x 12

Original: E43Z-10320-A, GC-402

Alternador / Alternator: E43F-10300-EA / PA / RA, E43Z-10346-D, E53F-10300AA/BA/DA; IR/EF

Aplicação / Application: FORD: BRONCO 2.6, MERCURY

Ford / Visteon



UF - 2.221/2 2 escovas / brushes

Especificações / Features: 12V - Escova / Brush: 4,5 x 8,3 x 16,3

Utilizado com / Used with GAUSS GA-350 e 360

Original:

Alternador / Alternator: RC28 SERIES

Aplicação / Application: FORD: FIESTA, FOCUS, KA, ECOSPORT, COURIER

Prestolite / Delphi



UF - 2.207/2 2 escovas / brushes

Especificações / Features: 12V - Escova / Brush: 5 x 8 x 26

Original: 352.14.128

Alternador / Alternator: 352.13.950 / 955; 352.14.085 / 095 / 190 / 445; 12V 80>90A

Aplicação / Application: PEUGEOT, RENAULT: R19 1.6, VOLKSWAGEN

Prestolite / Delphi



UF - 2.208/2 2 escovas / brushes

Especificações / Features: 12V - Escova / Brush: 4,5 x 8 x 16,5

Original: 352.12.715

Alternador / Alternator: 352 13 850 12V 70A

Aplicação / Application: MERCEDES-BENZ

Prestolite / Delphi



UF - 2.209/2 2 escovas / brushes

Especificações / Features: 24V - Escova / Brush: 4,5 x 8 x 18,5

Original: 352.13.010

Alternador / Alternator: 352.13.670/ 680/ 690/ 845/ 865/ 970, 352.14.130/ 170/ 560, MB12100R / 24055R / 24090R, SC 12100R / 24055R / 24090R

Aplicação / Application: FORD, MERCEDES-BENZ, PERKINS, RENAULT, SCANIA, VOLKSWAGEN

Prestolite / Delphi

UF - 2.210/2 2 escovas / brushes

Especificações / Features: 12V / 24V - Escova / Brush: 4,5 x 8 x 18,5



Original: 352.13.406

Alternador / Alternator: 352.13.685 / 690 / 725 / 730, 352.14.305, M02409R 12 /24V 55>90A

Aplicação / Application: DEUTZ, EL DETALLE, FORD, PERKINS, RENAULT: TRAFIC C/ AR T 352, 6.354 DIESEL, R18 2.0 / 2.2, R21 2.1, VOLKSWAGEN

Porta Escovas | Porta escovas para sistema elétrico de arrefecimento
Brush holder for cooling electric car system

Diversos

UF - 6.605/4 4 escovas / brushes

Especificações / Features: Escova / Brush: 7 x 8 x 17, s/ Supressor ruído / Without noise suppressor

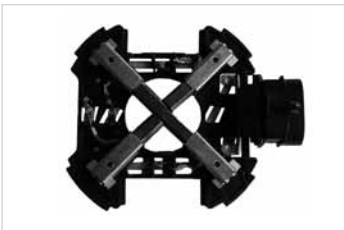

Original:

Motor / Motor

Aplicação / Application: RENAULT: KANGOO, 9 A 19. PEUGEOT: 405, 306, 205. FIAT: PALIO, SIENA, UNO, DUNA. FORD: FIESTA, ESCORT, SIERRA, FOCUS.

Diversos

UF - 6.606/4 4 escovas / brushes

Especificações / Features: Escova / Brush: 7 x 8 x 17, c/ Supressor ruído / With noise suppressor



Original:

Motor / Motor

Aplicação / Application: RENAULT: CANGOO, 9 A 19. PEUGEOT: 405, 306, 205. FIAT: PALIO, SIENA, UNO, TEMPRA, TIPO, DUNA. FORD: FIESTA, ESCORT, SIERRA, FOCUS 1.8L, GM: MERIVA.

Diversos

UF - 6.607/4 4 escovas / brushes

Especificações / Features: Escova / Brush: 7 x 8 x 17



Original:

Motor / Motor

Aplicação / Application: RENAULT, PEUGEOT, FIAT, FORD

Diversos

UF - 6.608/4 4 escovas / brushes

Especificações / Features: Escova / Brush: 7 x 8 x 17



Original:

Motor / Motor

Aplicação / Application: RENAULT: 19

Diversos

UF - 6.609/4 4 escovas / brushes

Especificações / Features: Escova / Brush: 7 x 8 x 17



Original:

Motor / Motor

Aplicação / Application: FIAT: PALIO

Diversos

UF - 6.610/4 4 escovas / brushes

Especificações / Features: Escova / Brush: 7 x 8 x 17



Original: _____

Motor / Motor _____

Aplicação / Application: FIAT: UNO - DIESEL, DUNA - GASOLINA

Diversos

UF - 6.611/4 4 escovas / brushes

Especificações / Features: Escova / Brush: 7 x 8 x 17



Original: _____

Motor / Motor _____

Aplicação / Application: PEUGEOT: 405

Porta Escovas | Para Direção Elétrica
Brush holders for Electric Power Steering Wheel Pump

Valeo

UF - 6.612/4 4 escovas / brushes

Especificações / Features: Escova / Brush: 6 x 12,5 x 20



Original: _____

Motor / Motor _____

Aplicação / Application: DIREÇÃO ELÉTRICA / ELECTRIC POWER STEERING WHEEL PUMP
 CITROEN: SAXO, PEUGEOT: 106, RENAULT: KANGOO, SCENIC

Porta Escovas | Para Limpadores de Para Brisa
Brush holders for Windshield Wiper

Bosch

UF - 6.601/3 3 escovas / brushes

Especificações / Features: 12V, Tipo / Type: CHP -

Escova / Brush: 6,3 x 6,3 x 12

Original: 9 390 082 022

Aplicação / Application: CHEVROLET-GM, FIAT,
 MERCEDES-BENZ, SCANIA, VOLKSWAGEN: FUSCA
 1.3 / 1.5



Bosch

UF - 6.602/3 3 escovas / brushes

Especificações / Features: 12V

Escova / Brush: 4,5 x 6 x 10,5

Original: 9 390 083 018

Aplicação / Application: CHEVROLET-GM, FIAT: UNO,
 FORD, VOLKSWAGEN



Delco

UF - 6.603/3 3 escovas / brushes

Especificações / Features: 12V

Escova / Brush: 5 x 5 x 11,5

Original: _____

Aplicação / Application: CHEVROLET-GM: D-20,
 MONZA, OPALA



Porta Escovas | Para Levantador de Vidro
Brush holder for Window Lift Motor

Mabuchi/Carro

UF - 6.604/2 2 escovas / brushes

Especificações / Features: 12V

Original: _____

Aplicação / Application: UNIVERSAL: PARA LADO DI-
 REITO OU ESQUERDO, COM E SEM CONECTOR



Honda



UF - 9.901/2 2 escovas / brushes **Especificações / Features:** 12V, Escova / Brush: 6 x 10 x 13,5

Original: 31206

Partida / Starter: 901QTY1M9T11

Aplicação / Application: **HONDA:** CBX AERO 150; CBX 200, CG TITAN 125, NX 150 ; NX 200, SAHARA 350, XR 200

Honda / Yamaha



UF - 9.902/4 4 escovas / brushes **Especificações / Features:** 12V, Escova / Brush: 5 x 10 x 12,5

Original: 31206 MMS 008, IVJ 81844 000

Partida / Starter: 31200MJO006, ZUG 8184000

Aplicação / Application: **HONDA:** HONDA 750 - REPARO 31201 ICG7 000, **YAMAHA:** TENERÉ 1 FAROL - REP. 3 AJ 81801 00, XV 250 - VIRAGO, YBR

Yamaha



UF - 9.903/2 2 escovas / brushes **Especificações / Features:** 12V, Escova / Brush: 6 x 9,5 x 10

Original:

Partida / Starter:

Aplicação / Application: **YAMAHA:** YBR

Kawasaki



UF - 9.904/4 4 escovas / brushes **Especificações / Features:** 12V, Escova / Brush: 5 x 10 x 12,5. Base 3mm maior que / Base bigger than: UF-9.902/4

Original:

Partida / Starter:

Aplicação / Application: **KAWASAKI, JET-SKI, MOTO 900 / 1100 CC**

Honda



UF - 9.905/2 2 escovas / brushes **Especificações / Features:** 12V, Escova / Brush: 6 x 7,5 x 8

Original: 9 390 083 018

Partida / Starter:

Aplicação / Application: **HONDA:** CG 150

Honda



UF - 9.906/2 2 escovas / brushes **Especificações / Features:** 12V, Escova / Brush: 6 x 7,5 x 8

Original:

Partida / Starter:

Aplicação / Application: **HONDA:** BIZ 100

Nippondenso



UF - 9.907/2 2 escovas / brushes **Especificações / Features:** 12V, Escova / Brush: 6 x 9 x 12

Original: 028510-0632

Partida / Starter: NIPPONDENSO 028000-9281/-8410, 128000-2760 /-4242/-4630/-4861/-5142, 228000-2780/-4550/-4560

Aplicação / Application: **JET SKI BOMBARDIER SEA-DOO**

Bosch

UF-3301 Original: 409031095

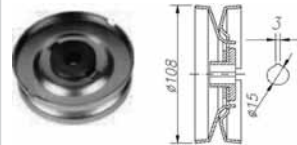

1 canal / groove

Dinamo / Dynamo: (WAPSA)
Aplicação / Application: **VOLKSWAGEN:** SEDAN, BRASÍLIA E KOMBI

Bosch

UF-3302 Original: 4 090 031 096

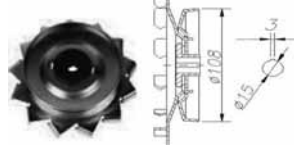

1 canal / groove

Alternador / Alternator: (WAPSA)
Aplicação / Application: **VOLKSWAGEN:** SEDAN, BRASÍLIA E KOMBI

Bosch

UF-3303 Original: 404 053, 404 059,

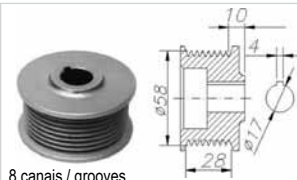

8 canais / grooves

9 121 450 566, 9 121 450 940
Alternador / Alternator: 9 121 450 014 (WAPSA)
Aplicação / Application: **VOLKSWAGEN:** CAMINHÕES 13210 / 15210 / 22210 - C/ MOTOR CUMMINS, SÉRIE C EXPORTAÇÃO; CAMINHÕES 16170 / 14170 / 16210 - C/ CUMMINS SÉRIE C

Bosch

UF-3305 Original: 1 126 601 524

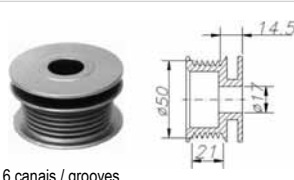

6 canais / grooves

Alternador / Alternator: 0 120 335 010, 0120 485 046, 0 123 310 001 / 002 / 007 / 019 / 020, 0 123 315 001 / 002, 0 123 320 001 / 002 / 003 / 006 / 007 / 009, 0 123 325 005, 0 123 340 001/002 / 003, 0 123 505 005 / 011, 0 123 510 001 / 006 / 008 / 009 / 054, 0 123 515 011 / 014, 0 123 540 001, 0 124 325 043, 0 124 325 061

Aplicação / Application: **AUDI:** CABRIO 1.9 TDI, 801.9 TDI, A6 1.9 TDI, **FORD:** GALAXI 1.9 TDI, **MERCEDES-BENZ:** C180T 1.8, ALTERNADOR KC (R) 14V 90A, **SEAT:** ALHAMBRA 2.0/1.9, AROSA 1.0/1.4, CITY GOLF 1.6, CORDOBA 1.4/ 1.6/ 1.8/ 1.9/ 2.0, IBIZA 1.9/ 1.8/ 1.6/ 1.4/ 2.0, INCA 1.4 /1.6 /1.9, TOLEDO 2.0/ 1.9/ 1.8/ 1.6, **SKODA:** FELICIA 1.6 MPFI, PICK-UP 1.6 MPFI, **VOLKSWAGEN:** CALIFORNIA 1.9/ 2.5/ 2.0, CADDY 1.4/ 1.6/ 1.6, PICK-UP /1.9 SDI, CARAVELLE 1.9/ 2.5/ 2.0/ 1.9 TURBO, CORRADO 2.0, EUROVAN 2.5, GOL 1.0 MI, GOLF CABRIOLET 1.9/ 1.8/ 1.6/ 2.0/ 1.9 TDI, GOLF III 1.4/ 1.6/ 1.8/ 1.9/ 2.0/ TDI / VARIANT/ SYNCRO/ TURBO, JETTA 1.8/ 1.9/ 2.0 TDI, MULTIVAN 1.9/ 2.0/ D/ TURBO, PARATI 1.0 MI 16V - 96/97, PASSAT 1.6 /1.8 /1.9 /2.0 /D/ SYNCRO/ TDI, POLO 1.0/ 1.3/ 1.4/ 1.6/ 1.8/ 1.9/ CLASSIC/ 1.05, POLO VARIANT 1.4/ 1.6/ 1.9/ TDI /CLASSIC, SHARAN 1.9 /2.0 /TDI, TRANSPORTER 1.9 /2.0 /2.5 /SYNCRO, VENTO 1.4 /1.6 /1.8 /1.9 /2.0 /SDI/ TDI /TURBO

Bosch

UF-3304 Original: 465 145

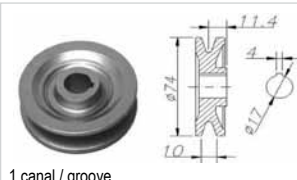

1 canal / groove

Alternador / Alternator: (WAPSA)
Aplicação / Application: **VOLVO:** CAMINHÕES E ÔNIBUS

Bosch

UF-3306 Original: 9 123 080 070

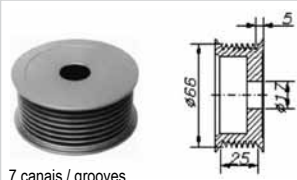

7 canais / grooves

Alternador / Alternator: 9 000 083 068, 9 120 080 212 / 226 / 230 / F 000 LDO 100 / 102 / 114 / 115
Aplicação / Application: **CHEVROLET-GM:** S10 2.5 C/ MOTOR MAXION, ALTERNADOR K1 (R) 14V 30, 85A; **FORD:** F1000 HSD 2.5 C/ MOTOR MAXION ; F1000 T 4.0 ; RANGER 2.5 C/ MOTOR MWM ALTERNADOR K1 (R) 14V 28 70A; **MERCEDES-BENZ:** SPRINTER 2.5, ANO 09/96 C/ MOTOR OM 014A, ALTERNADOR K1(R) 14V 30, 85A

Bosch

UF-3307 Original: 9 123 080 009

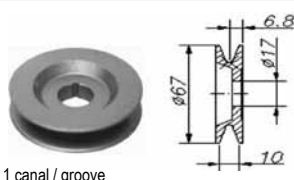

1 canal / groove

Alternador / Alternator: 9 120 080 500, F 000 LDO 500
Aplicação / Application: **CHEVROLET-GM:** Corsa 1.0

Bosch

UF-3308 Original: 9 121 080 137

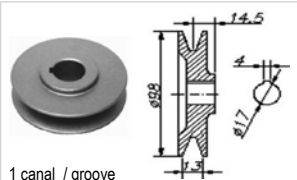

1 canal / groove

Alternador / Alternator: 9 120 080 020 / 058 / 084 / 101 / 104 / 112 / 126 / 159 / 166 / 181 / 183
Aplicação / Application: **AGRALE-DEUTZ:** CAMINHÕES - TX1600, TRATORES - 4200/440/4400, **CASE:** PÁ CARREGADEIRA - W18 / W20, **CBT:** TRATORES - 1065 / 1105 / 2080 / 2105 / 2600, **CLARK:** PÁ CARREGADEIRA - MICHIGAN 55A / 65R / 75III, **KOMATSU:**

TRATOR ESTEIRA D30E / D50A / D50P, **MASSEY-FERGUSON:** COLHEITADEIRA / COMBINE, MOTOR INDUSTRIAL, TRATORES, **MERCEDES-BENZ:** CAMINHÕES, MICRO-ÔNIBUS, ÔNIBUS, CHASSI P/ ÔNIBUS, MOTORES INDUSTRIAL E MARÍTIMO SÉRIE OM

Bosch

UF-3309 Original: 9 121 080 151

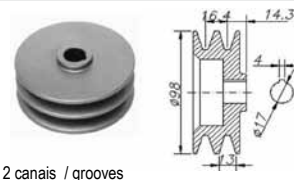

2 canais / grooves

Alternador / Alternator: 9 120 080 022 / 091 / 102 / 119 / 140 / 160 / 183
Aplicação / Application: **MASSEY-FERGUSON,** **MERCEDES-BENZ**

Bosch

UF-3310 Original: 9 121 080 179

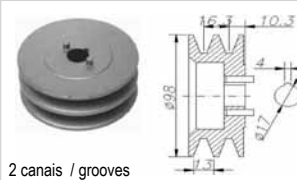

2 canais / grooves

Alternador / Alternator: 9 120 080 031 / 083 / 113 / 182
Aplicação / Application: **MASSEY-FERGUSON:** COLHEITADEIRA / COMBINE - MF 5650, **MERCEDES-BENZ:** CHASSI P/ ÔNIBUS -OF1113 / 1313 / 1316; OH 1113 / 1313 / 1316 / 1318 / 1419 / 1517, ÔNIBUS - O364 / O365

Bosch

UF-3315 Original: 9 121 080 897

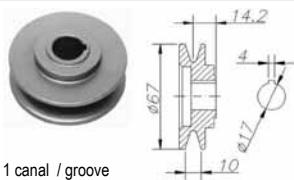

1 canal / groove

Alternador / Alternator: 9 120 080 096 / 098 / 169
Aplicação / Application: **CHEVROLET-GM**

Bosch

UF - 3.318 Original: 404 049, 9 121 450 506

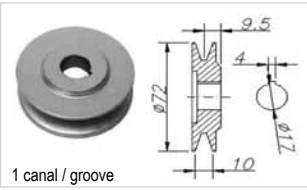

1 canal / groove

Alternador / Alternator: (WAPSA)
Aplicação / Application: FORD: DEL REY - C/ AR
CONDICIONADO E DIREÇÃO HIDRÁULICA ATÉ 06/87
(14V 55A); ESCORT - TODOS

Bosch

UF - 3.319 Original: 404 025, 9 121 450 510

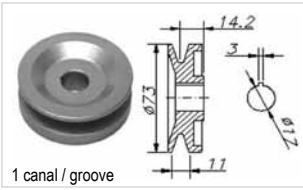

1 canal / groove

Alternador / Alternator: (WAPSA)
Aplicação / Application: AGRALE: MOTOR ESTACIONÁRIO - M790, TRATORES - T4100 / T4200, FORD: CAMINHÕES - F100 / F350 / F600 À GASOLINA, BELINA II, CORCEL II, DEL REY, GALAXIE, JEEP, LANDAU, LTD, MAVERICK, PAMPA, PICK-UP, RURAL, SCALA

Bosch

UF - 3.320 Original: 404 019, 9 121 450 490

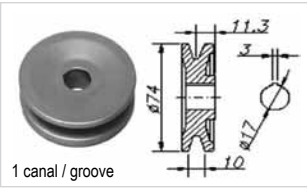

1 canal / groove

Alternador / Alternator: (WAPSA)
Aplicação / Application: FORD: CAMINHÕES - F1000 / F11000 / F13000 / F14000 / F19000 / F2000 / F22000 / F4000 - TODOS C/ MOTOR MWM 4 E 6 CIL.

Bosch

UF - 3.321 Original: 404 043, 9 121 450 502

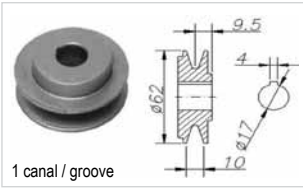

1 canal / groove

Alternador / Alternator: (WAPSA)
Aplicação / Application: FORD: DEL REY - C/ AR CONDICIONADO, ESCORT - GHIA / GL / GLS / XR3 - TODOS ATÉ 07/86

Bosch

UF - 3.322 Original: 9 121 080 254

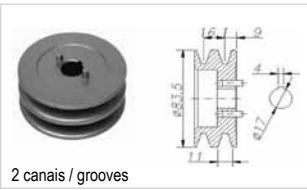

2 canais / grooves

Alternador / Alternator: 9 121 080 254
Aplicação / Application: FIAT: CAMINHÕES - 180 / 210CM - ATÉ 11/75

Bosch

UF - 3.323 Original: 9 121 080 808

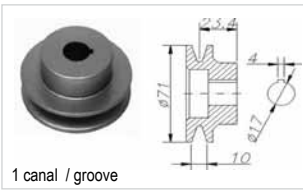

1 canal / groove

Alternador / Alternator: 9 120 080 089 / 120 / 221
Aplicação / Application: FIAT: FIAT 147, FIORINO - ATÉ 09/79

Bosch

UF - 3.324 Original: 9 121 080 127

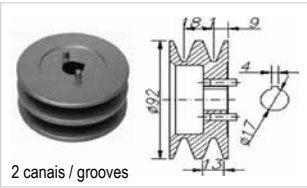

2 canais / grooves

Alternador / Alternator: 9 120 080 062 / 144
Aplicação / Application: MASSEY-FERGUSON: TRATOR - MF4780 C/ MOTOR SCANIA DN 11, SCANIA: CAMINHÕES - L110/111/ LK140/141/ LKS140/141/ LS110/111/ LT110/111/ LTS110/111/ T112M, ÔNIBUS - B111 / B1115

Bosch

UF - 3.325 Original: 1 126 600 488

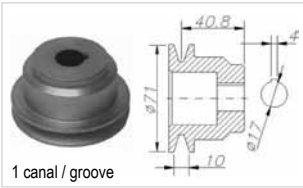

1 canal / groove

Alternador / Alternator: 9 120 080 089 / 120 / 221
Aplicação / Application: VOLKSWAGEN: GOL - CL, GL, GT, GTI, GTS, KOMBI - 1.6 A DIESEL, PARATI - CL, GL, GLS, PASSAT - 1.5 / 1.6 / GTS 1.8, QUANTUM - CL, GL, GLS, SANTANA - CL, GL, LS

Bosch

UF - 3.326 Original: 404 023, 9 121 450 492

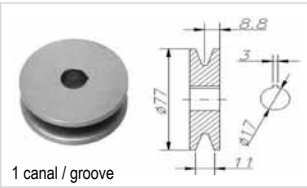

1 canal / groove

Alternador / Alternator: (WAPSA)
Aplicação / Application: VOLKSWAGEN: CAMINHÕES: E11 / E13 / E21 / VW 6.140 - A ÀLCOOL, DODGE: CAMINHÕES - D100 / D400 / D700 / D900, CHARGER / DART SE / GRAN GROUP / RT / SEDAN

Bosch

UF - 3.327 Original: 404 026, 9 121 450 499

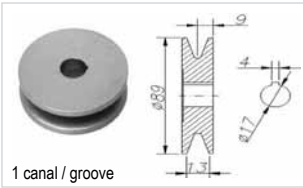

1 canal / groove

Alternador / Alternator: (WAPSA)
Aplicação / Application: FORD: TRATORES 4610 / 5610 / 6610 / 7610 E OUTROS

Bosch

UF - 3.328 Original: 9 101 080 024

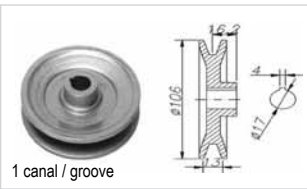

1 canal / groove

Dínamo / Dynamo: (WAPSA)
Aplicação / Application: MASSEY-FERGUSON: TRATORES MF50X, MF55X, MF65R, MF65X, MF85X, MF95, MF95I

Bosch

UF - 3.329 Original: 116019

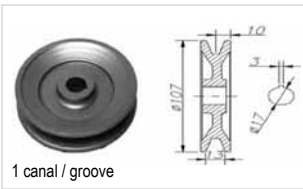

1 canal / groove

Alternador / Alternator: (WAPSA)
Aplicação / Application: MASSEY-FERGUSON: COLHEITADEIRA / COMBINE MF220, TRATORES MF235, MF250, MF252, MF265, MF275, MF285, MF290, MF50X, MF55X, MF65X, MF95I, MF95X

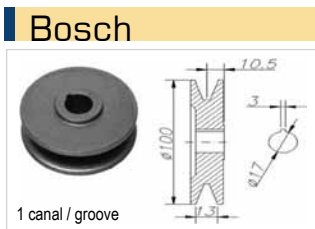

UF-3330 Original: 404 029, 9 121 450 494

Alternador / Alternator: (WAPSA)

Aplicação / Application: CLARK: PÁ-CARREG. MINI BOB CAT, MASSEY-FERGUSON: TRATORES - MF235 / MF250 / MF265 / MF275 / MF285 / MF290 / MF290 (ÁL-COOL) / MF290RA (MOT.PERKINS AE-4.236) / MF85X / MF95X - TDS C/ALT.WAPSA-A PARTIR DE 07/78, MERCEDES: CAMINHÕES, MICRO-ÔNIBUS, MOTOR MARÍTIMO, ÔNIBUS-TDS C/ MOTORES OM 314 /321/ 326/ 352/ 352A/ 355-6/ 355-S

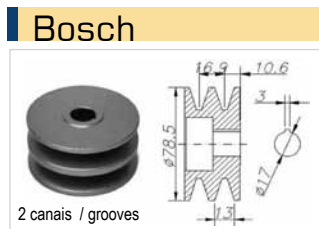

UF-3331 Original: 404 037, 9 121 450 500

Alternador / Alternator: (WAPSA)

Aplicação / Application: MASSEY-FERGUSON: TRATORES - MF296

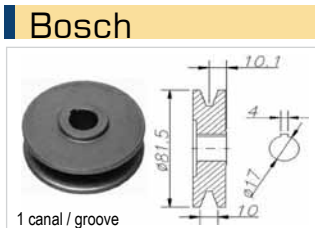

UF-3332 Original: 9 121 080 399

Alternador / Alternator: 9 120 080 045 / 057 / 107

Aplicação / Application: VALMET: TRATOR - 110ID / 621D / 651D / 851D / 118 / 138/4 / 88 / 68

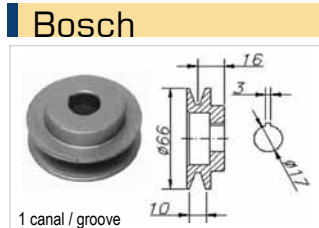

UF-3336 Original: 9 122 080 236

Alternador / Alternator:

Aplicação / Application: FIAT: ELBA - 1.6, PRÊMIO - 14V 22, 55A, UNO - 14V 23, 55A

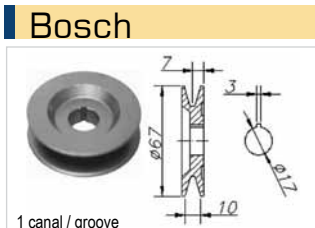

UF-3337 Original: 9 122 080 702

Alternador / Alternator: 9 120 080 169 / 180 / 203

Aplicação / Application: CHEVROLET-GM: IPANE-MA - 1.8, KADETT - 1.8 /2.0 C/ AR CONDICIONADO, MONZA - 1.8 / 2.0 / 2.0I

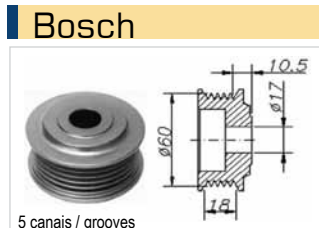

UF-3338 Original: 9 122 080 409

Alternador / Alternator: 9 120 080 168 / 172

Aplicação / Application: CHEVROLET-GM: IPANE-MA - 1.8 C/ AR CONDICIONADO, KADETT - 1.8 / 2.0 ; MONZA - CLASSIC MPFI

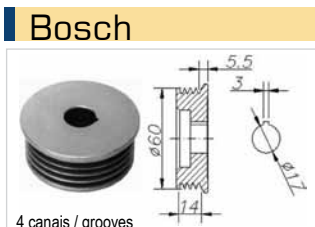

UF-3339 Original: 9 122 080 693

Alternador / Alternator: 9 120 080 165

Aplicação / Application: FIAT: ELBA - 1.6, ÁLCOOL/ GASOLINA, COM AR CONDICIONADO, PRÊMIO, UNO 1.6R/MPi

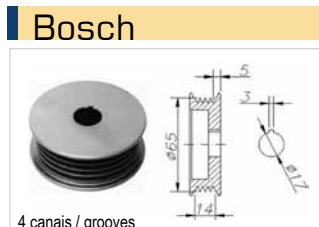

UF-3341 Original: 9 122 080 420

Alternador / Alternator: 9 120 080 170 / 171

Aplicação / Application: CHEVROLET-GM: IPANE-MA - 1.8 C/ AR CONDICIONADO ; KADETT - 1.8 / 2.0 ; MONZA - CLASSIC MPFI, FIAT: TEMPRA - 2000 16V 2.0I TURBO - SÉRIE OURO / PRATA

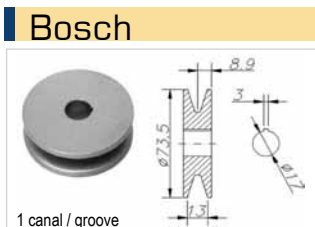

UF-3342 Original: 404 001

Alternador / Alternator: (WAPSA)

Aplicação / Application: CLARK: EMPILHAD. CFY20 / CFY25 - C/ MOTOR PERKINS 6 CIL., EMPILHAD. CHY100 / CHY120 / CHY140 / CHY60 / CHY70 / CHY80 ; MINI PÁ CARREG. BOB CAT, FORD: AERO WILLYS E ITAMARATY - 73>, JEEP, PICK-UP, RURAL - 6 CIL - 73>

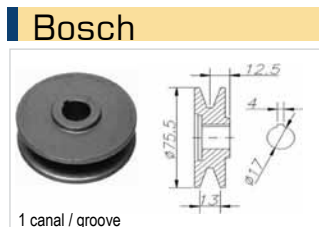

UF-3343 Original: 9 121 080 286

Alternador / Alternator: 9 120 080 054 / 107

Aplicação / Application: AGRALE: TRATORES - 4200 / 440 / 4400 - TODOS ATÉ 08/85, TOYOTA: UTILITÁRIO BANDEIRANTE - (MBS-OM314) ATÉ 12/87, YANMAR: MICRO TRATOR - NS11, MOTOR BT 83 / 22 - ATÉ 12/86

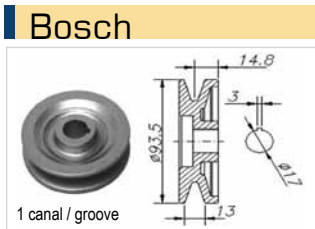

UF-3344 Original: 404 066, 9 121 450 487

Alternador / Alternator: (WAPSA)

Aplicação / Application: CLARK: PÁ CARREGADEIRA MICHIGAN - 65R / 75A / 75II / 75III, FORD: CAMINHÕES - F11000 / F12000 / F13000 / F600 / F750 COM MOTOR-PERKINS 4 E 6 CIL., HYSTER: EMPILHADEIRA/ FORKLIFT - 110J / 130J / 150J - TODOS C/ MOTOR PERKINS 4236

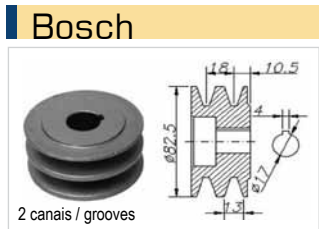

UF-3346 Original: 404 055, 9 121 450 898

Alternador / Alternator: 9 120 450 005 / 006 / 124

Aplicação / Application: FORD: CARGO - 1113/1114/11 17/1215/1218/1313/1314/1317/1415/1418/1419/1514/15 17/1615/1618/1619/2215/2218/2319/35300/3224/F6000/ F7000/FTO-TC/HTA/NA/TC/TCA/TCP, NEW HOLLAND: FTO-TCP/ T-SÉRIE TF42/ TR86/96 / TX30 / TX32/34/36

Bosch

UF - 3.347

Original: 404 036, 9 121 450 496

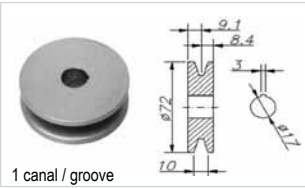

1 canal / groove

Alternador / Alternator: 9 120 450 015, 9 120 450 020

(WAPSA)

Aplicação / Application: VOLKSWAGEN: CAMINHÕES

12140 - C/ MOTOR MWM, 6 TON. 14V 35A, 6.90, 7.90, 7110, 11140

Bosch

UF - 3.348

Original: 9 121 456 184

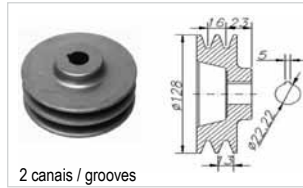

2 canais / grooves

Alternador / Alternator: 9 120 456 040

Aplicação / Application: MERCEDES-BENZ: ÔNIBUS C/ MOTOR SÉRIE BR400

Bosch

UF - 3.349

Original: 404 054, 9 121 456 137

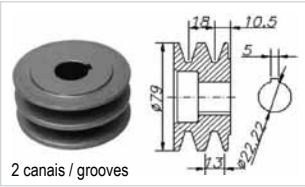

2 canais / grooves

Alternador / Alternator: 9 120 456 005, 9 120 456 025

(WAPSA)

Aplicação / Application: FORD: CAMINHÕES CARGO -

1113 / 1114 / 1117 / 1215 / 1218 / 1313 / 1314 / 1317 / 1415 / 1418 / 1419 / 1514 / 1517 / 1615 / 1618 / 1619 / 2215 / 2218 / 2218T / 2319 / 3224 TURBO / 3530, TODOS C/ 14V 90A, CAMINHÕES 1419 / 1619 / 2319 TODOS ATÉ 1987 C/ 14V 90A, MÜLLER: TRATOR AGRÍC. TM 31 (14V 90A); VOLVO: ÔNIBUS B58 E B10M (28V 75A)

Bosch

UF - 3.350

Original: 9 122 080 925

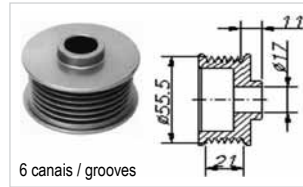

6 canais / grooves

Alternador / Alternator: 9 120 080 215

Aplicação / Application: RENAULT: CLIO - 1.6I -AS, R9 - AM/AS, R11 - AM/AS, R19 1.6I - AM / AS / BR

Bosch

UF - 3.351

Original: 9 121 456 033

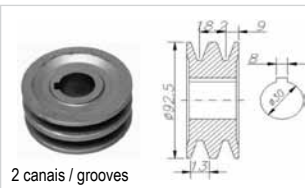

2 canais / grooves

Alternador / Alternator: 9 120 456 003 / 014 / 016

Aplicação / Application: SCANIA: CHASSIS P/ ÔNIBUS - F112HL / 113HL / K113CL / K113TL / L113CL / S113AL / S113CL

Bosch

UF - 3.352

Original: 9 122 080 604

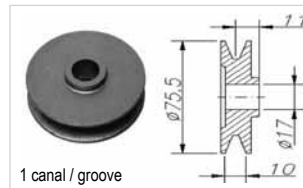

1 canal / groove

Alternador / Alternator: 9 120 080 192 / 195

Aplicação / Application: CHEVROLET-GM: D20 - 4.1 LTS. - 14V 21, 23, 55, 75A - (03/1992->)

Bosch

UF - 3.353

Original: 9 122 080 633

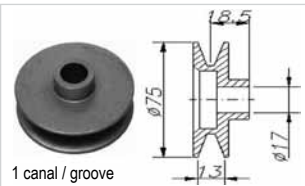

1 canal / groove

Alternador / Alternator: 9 120 080 196 / 197

Aplicação / Application: CHEVROLET-GM: D20 / D40 / D6000 / BONANZA / VERANEIO - COM E SEMAR CONDICIONADO, À DIESEL (03/1992->)

Bosch

UF - 3.355

Original: 9 122 080 030

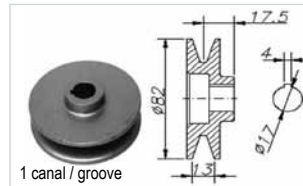

1 canal / groove

Alternador / Alternator: 9 120 080 130 / 157 / 188

Aplicação / Application: VALMET: TRATORES / TRACTORS - 118 / 138 / 78 / 88 / 128 / 128 4X / 68 / 68 CAFÉ / 880 / 880 4X

Bosch

UF - 3.356

Original: 9 121 456 162

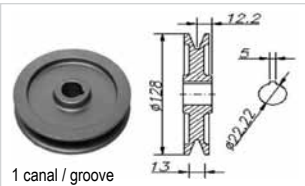

1 canal / groove

Alternador / Alternator: _____

Aplicação / Application: MERCEDES-BENZ: ÔNIBUS - C/ MOTOR M36, O371 RS, PLATAFORMA - O371 RS A, O371 RSD, O371 UP

Bosch

UF - 3.358

Original: _____

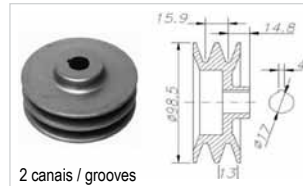

2 canais / grooves

Alternador / Alternator: 9 120 080 147, 9 120 080 181

Aplicação / Application: MERCEDES-BENZ: L1214 / 1218 / 1414 / 1418 / 1614 / LS1625 / 1630 / LS1935 / LS1941

Bosch

UF - 3.360

Original: 9 122 080 295

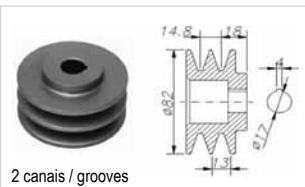

2 canais / grooves

Alternador / Alternator: 9 120 080 157 / 188

Aplicação / Application: VALMET: TRATORES - 980 / 1580 / 1780 - COM MOTOR MWM

Bosch

UF - 3.361

Original: 3 431 557 116

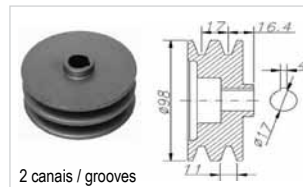

2 canais / grooves

Alternador / Alternator: _____

Aplicação / Application: MERCEDES-BENZ

Bosch

UF-3363 Original: 9 121 456 155

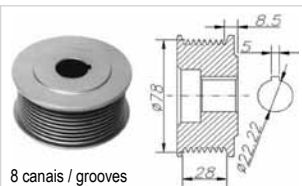

8 canais / grooves

Alternador / Alternator: 9 120 456 026 / 030
Aplicação / Application: FORD: ÔNIBUS - VOLKSBUS
 RANDOM: CAMINHÃO - FORA DE ESTRADA, VALMET:
 TRATORES, CAMINHÃO, VOLKSWAGEN: CAMINHÕES
 - 22.210/23.210 - C/ MOTOR CUMMINS EQ. COMERCIAL
 E PRIM. RIO, CHASSI P/ ÔNIBUS - VOLKSBUS

Bosch

UF-3365 Original: 0 101 549 124

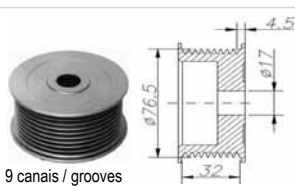

9 canais / grooves

Alternador / Alternator: _____
Aplicação / Application: MERCEDES-BENZ: CAMI-
 NHÕES 1938 S / 1938 LS

Bosch

UF-3368 Original: F 000 LD1 373

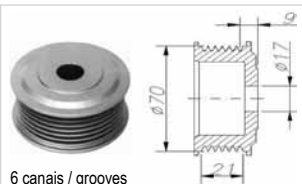

6 canais / grooves

Alternador / Alternator: 9 120 080 232, F 000 LD0 117
Aplicação / Application: FORD: F1000; CHEVROLET-
 GM: S10, D 6150, SILVERADO 6.0T/DLX - C/ AR CON-
 DICIONADO, SCANIA: CHASSI P/ ÔNIBUS C/ MOTOR
 DN11 / DS11 / DS11.34 / DSC 11.18

Bosch

UF-3369 Original: 9 122 080 929

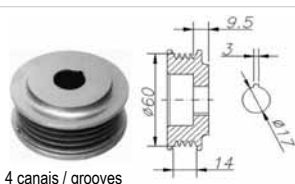

4 canais / grooves

Alternador / Alternator: _____
Aplicação / Application: FIAT: UNO - 1.6, PREMIO - 1.6,
 ELBA - 1.6 - TODOS COM DIREÇÃO HIDRÁULICA

Bosch

UF-3371 Original: F 00M 991 149

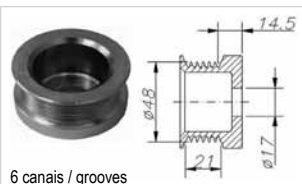

6 canais / grooves

Alternador / Alternator: 0 124 215 006, 0 124 215 008
Aplicação / Application: VOLKSWAGEN: GOL - 1.000,
 SANTANA - 16V

Bosch

UF-3372 Original: _____

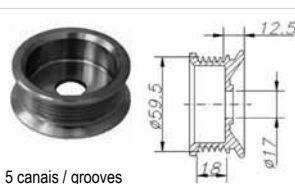

5 canais / grooves

Alternador / Alternator: _____
Aplicação / Application: CHEVROLET-GM: CORSA,
 KADETT, MONZA

Bosch

UF-3373 Original: _____

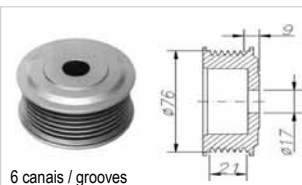

6 canais / grooves

Alternador / Alternator: _____
Aplicação / Application: FORD: F250 - 4,2 MWM 6 CC -
 90A - 14V

Bosch

UF-3374 Original: _____

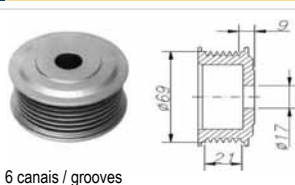

6 canais / grooves

Alternador / Alternator: _____
Aplicação / Application: FORD: F250 - 3.9
 CUMMINS 4 CC - 90A - 1999 >

Bosch

UF-3375 Original: F 00M 991 073

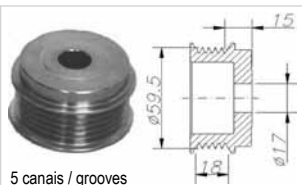

5 canais / grooves

Alternador / Alternator: 0 124 415 012
Aplicação / Application: FIAT: PALIO - 16V (TODOS)

Bosch

UF-3376 Original: _____

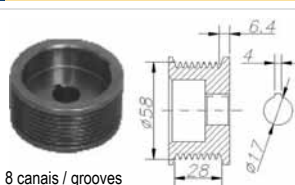

8 canais / grooves

Alternador / Alternator: 9 120 080 136
Aplicação / Application: VOLKSWAGEN: CAMI-
 NHÕES 16270 / 14170 / 14210 C/ MOTORES CUM-
 MINS K1 65 A - 14V

Bosch

UF-3377 Original: 404 059, 9 121 450 940

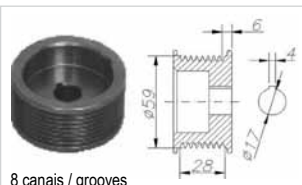

8 canais / grooves

Alternador / Alternator: (WAPSA)
Aplicação / Application: VOLKSWAGEN: CAMINHÕES
 16170 / 16220, FORD: CARGO

Bosch

UF-3379 Original: 1 126 600 975

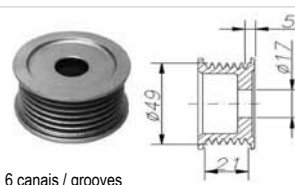

6 canais / grooves

Alternador / Alternator: 70 e 120A
Aplicação / Application: CHEVROLET-GM: ASTRA,
 CORSA, VECTRA

Bosch

UF-3380 Original: _____

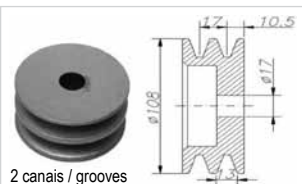

2 canais / grooves

Alternador / Alternator: _____
Aplicação / Application: CATERPILLAR: PÁ-CARRE-
 GADEIRA 938

Bosch

UF-3381 Original: _____

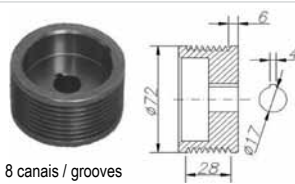

8 canais / grooves

Alternador / Alternator: 0 120 468 131, 0 120 468 132
Aplicação / Application: SCANIA: SCANIA T-114/
 114340 / 124360 / 124400 / 124420 / HTN / 144460 /
 144530 ; R-114 / 144460 / 144530 / 164480 / TR-124360
 / 124400 / 124420 / 124420-HTI

Bosch

UF-3382 Original: 9 122 080 533

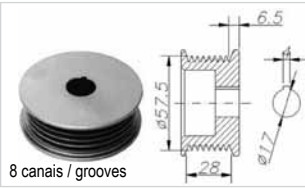

Alternador / Alternator: F 000 LD0 106, 9 120 080 184, 9 120 080 187, 9 120 080 202
Aplicação / Application: CASE: SÉRIE 580H, SH4X2, SH 4X4, TDS 3.9L E MOT. CUMMINS, ALT.K1-14V 23/65A, VOLKSWAGEN: 7.100(4.0), 8.140 TURBO (4.3), 12.140 (4.3) C/ MOTOR / ENGINE MWM, 12.170, 14.170, 16.170/200 (5.8) C/ MOT. CUMMINS-ALT. K1 14V 3/65A

Bosch

UF-3387 Original: _____

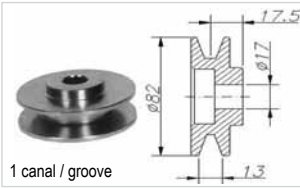

Alternador / Alternator: _____
Aplicação / Application: KIA: BESTA GS

Bosch

UF-3388 Original: _____

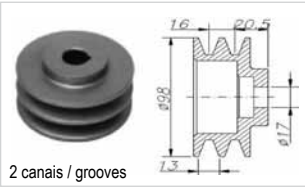

Alternador / Alternator: _____
Aplicação / Application: MERCEDES-BENZ: COM ALTERNADORES 120 A

Bosch

UF-3390 Original: F 00M 991 060

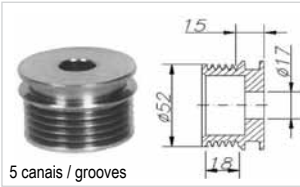

Alternador / Alternator: 0 124 325 023
Aplicação / Application: MERCEDES-BENZ: CLASSE A

Bosch

UF-3392 Original: 9 123 080 080

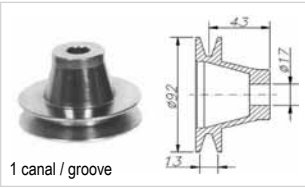

Alternador / Alternator: 9 129 080 207
Aplicação / Application: IVECO: CAMINHÕES - 120E / 150E / 150T / 160E

Bosch

UF-3395 Original: _____

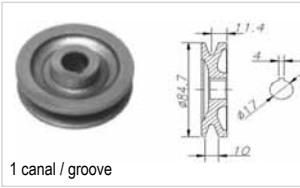

Alternador / Alternator: Nº VOLVO: 420433
Aplicação / Application: VOLVO: EDC

Bosch

UF-3396 Original: F 00M LD1 313

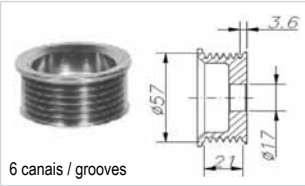

Alternador / Alternator: 0 124 315 018 /020 /021 /022, 0 124 325 041/ 042/ 066/ 076
Aplicação / Application: VOLKSWAGEN: GOL II 1.0I / 1.6I / 1.6 MI / 1.8 I / 1.8 MI / 2.0 MI / 2.0 MI 16V, LOGUS 1.6I / 1.8 / 1.8I / 2.0 / MI, PARATI II - 1.6I / 1.6MI / 1.8I / 1.8MI / 2.0I / 2.0 MI / 2.0 MI 16V / PARATI

III - 1.6 MI / 1.8 MI / 1.9 D / 2.0 MI, POINTER 1.8 / 1.8I / 2.0 / 2.0 MI, QUANTUM 1.8 / 1.8I / 1.8 MI / 2.0I / 2.0 MI, SANTANA 1.8 / 1.8I / 1.8MI / 2.0I / 2.0MI, SAVEIRO II - 1.6MI / 1.8MI / 2.0MI / SAVEIRO III - 1.6MI / 1.8MI / 1.9D / 2.0MI

Bosch

UF-3401 Original: _____

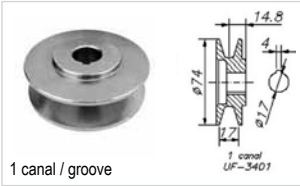

Alternador / Alternator: _____
Aplicação / Application: FORD: F1000 COM ALTERNADOR BOSCH

Bosch

UF-3402 Original: _____



Alternador / Alternator: _____
Aplicação / Application: MERCEDES-BENZ: MODELOS LEVES DE ATÉ 4 TON.

Bosch

UF-3406 Original: _____

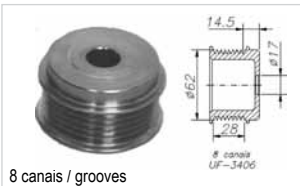

Alternador / Alternator: 0 124 555 009
Aplicação / Application: VOLVO: FH / GLOBO TRATO, B10 M (ELETRÔNICO), B12 B (ELETRÔNICO), FH12, FM, NH12

Bosch

UF-3407 Original: _____

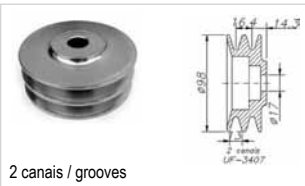

Alternador / Alternator: 0 124 325 118
Aplicação / Application: MERCEDES-BENZ: CAMINHÕES

Bosch

UF-3408 Original: 9 122 080 456

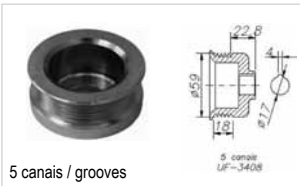

Alternador / Alternator: _____
Aplicação / Application: FIAT: FIORINO, PRÊMIO, UNO

Bosch **UF-3.420** Original: _____

Alternador / Alternator: 0120689562-140A (140 A – 24V)

Aplicação / Application: SCANIA: 124, SCANIA SÉRIE: 114 (K 124 1997→), 93 (F94 – L94 – K94 1998 →).

8 canais / grooves

Bosch **UF-3.422** Original: F 00M 991 169

Alternador / Alternator: 1721 – 012455011, 1620 – 0124325098

Aplicação / Application: MERCEDES-BENZ

2 canais / grooves

Bosch **UF-3.424** Original: 409031095

Dínamo: _____

Aplicação / Application: FIAT: UNO, CHEVROLET: CHEVETTE, VOLKSWAGEN: SEDAN, BRASÍLIA E KOMBI (PARA VEÍCULOS QUE TRAFEGAM EM ÁREAS URBANAS, QUE NECESSITAM DE RECARGA MAIS RÁPIDA PARA A BATERIA) UTILIZAR CORREIA 10X888

1 canal / groove

Bosch **UF-3.425** Original: F 00M 991 177

Alternador / Alternator: 0124555016

Aplicação / Application: MERCEDES-BENZ

8 canais / grooves

Bosch **UF-3.426** Original: _____

Alternador / Alternator: 9 120 456 003 140A

Aplicação / Application: SCANIA: F 112 HL, K 113, K 113 CL, K 113 CL/TL, K 113 HL, K 113 TL, K 113 AL, K 113 AL/CL, S 113CL, S 113. MERCEDES-BENZ: O 400 RS, O 400 RSD, O 400 RSL, OHL 1628L, OHL 1635, EQUIPAMENTOS DE REFRIGERAÇÃO

2 canais / grooves

Bosch **UF-3.427** Original: _____

Alternador / Alternator: 0 124 325 064

Aplicação / Application: FORD: F-250, F-350, F-4000

Em desenvolvimento
Development process

8 canais / grooves

Bosch **UF-3.428** Original: F00M 991321

Alternador / Alternator: 0 124 515 100

Aplicação / Application: FIAT: DUCATO, DAILY

Em desenvolvimento
Development process

6 canais / grooves

Bosch **UF-3.430** Original: F000D1 429

Alternador / Alternator: F 00LD0_T1_28v_140AMP

Aplicação / Application: MERCEDES-BENZ

Em desenvolvimento
Development process

9 canais / grooves

Bosch **UF-3.435** Original: _____

Alternador / Alternator: 0 120 689 571, 9 120 456 053, F 000 LD0 212

Aplicação / Application: MERCEDES-BENZ: SÉRIES 14t, 18t, 20t, 25t, 26t, 33t, 41t, O ,OH, CLIMABUSS: SISTEMAS DE AR-CONDICIONADO/ Air-Conditioning System (ALTERNADORES T1 / Alternators T1 140 AMP)

LANÇAMENTO
New product

2 canal / groove

Delco **UF-3.311** Original: 7331171

Alternador / Alternator: _____

Aplicação / Application: CHEVROLET-GM: PICK-UP D10 - 1979 >

1 canal / groove

Delco **UF-3.312** Original: 7320683

Alternador / Alternator: _____

Aplicação / Application: CHEVROLET-GM: PICK-UP C10 - 6 CIL. - 67 A 81, CAMINHÕES - A14C / C14C

1 canal / groove

Delco **UF-3.313** Original: 7322421

Alternador / Alternator: _____

Aplicação / Application: CHEVROLET-GM: OPALA - 1969 A 1974; PICK-UP - A10 / C10 - 4 CIL. - 1976 >

1 canal / groove

Delco **UF-3.314** Original: 7332366

Alternador / Alternator: _____

Aplicação / Application: CHEVROLET-GM: CHEVETTE - 1973 > OPALA - 1975>

1 canal / groove

Delco **UF-3.316** Original: 94632531

Alternador / Alternator: _____

Aplicação / Application: CHEVROLET-GM: MONZA

1 canal / groove

Delco

UF-3317

Original: 94648532

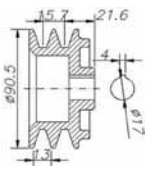

2 canais / grooves

Alternador / Alternator:

Aplicação / Application: **CHEVROLET-GM: A10 / C10 / D20 / D40** - todos com direção hidráulica

Delco

UF-3340

Original: 93205378

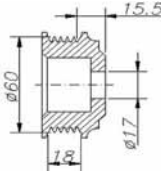

5 canais / grooves

Alternador / Alternator:

Aplicação / Application: **CHEVROLET-GM: KADETT** - após 91 c/ direção hidráulica, MONZA

Ford / Motorcraft

UF-3393

Original: F5TU-AA

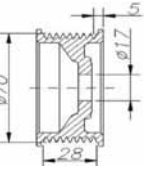

8 canais / grooves

Alternador / Alternator:

AC F6HU-AA / 98111216

Aplicação / Application: **FORD: F250 c/ alternador Motorcraft**

Ford / Motorcraft

UF-3399

Original: F07U A2A

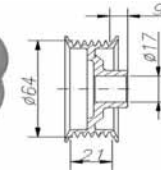

6 canais / grooves

Alternador / Alternator:

F6TU97081905 (14V, 105A)

Aplicação / Application: **FORD: RANGER 4.0 V6 GAS.**

Magneti Marelli

UF-3421

Original:

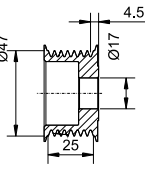

8 canais / grooves

Alternador / Alternator:

540226610/611

Aplicação / Application: **LAND ROVER**

Mitsubishi

UF-3397

Original:

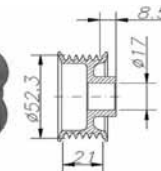

6 canais / grooves

Alternador / Alternator:

A005TA2591, A002T82091

Aplicação / Application: **FORD: COURIER C/ MOTOR ZETEC, ALTERNADOR MITSUBISHI - 14V 70A E ALTERNADOR HITACHI - 14V, 70A**

Mitsubishi

UF-3398

Original: XS6U A2A

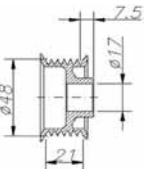

6 canais / grooves

Alternador / Alternator:

XS6110300AA

Aplicação / Application: **FORD: COURIER, FIESTA - C/ MOTOR ROKAN 16V, ALTERNADOR 14V, 75A**

Mitsubishi

UF-3404

Original:

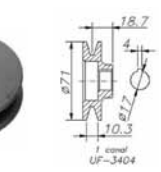

1 canal / groove

Alternador / Alternator:

Aplicação / Application: **MITSUBISHI: EMPILHADEIRA/ FORKLIFT COM ALTERNADOR MITSUBISHI**

Mitsubishi

UF-3419

Original:

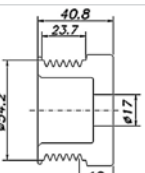

6 canal / grooves

Alternador / Alternator:

Aplicação / Application: **CATERPILLAR: 320**

Mitsubishi

UF-3423

Original:



1 canal / groove

Alternador / Alternator:

23100 - 50K 10 A 7 T 03371

Aplicação / Application: **NISSAN: EMPILHADEIRAS/ Forklift**

Mitsubishi

UF-3434

Original:

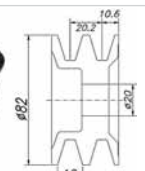

2 canais / grooves

Alternador / Alternator:

A4TU3586, A4T66785,

A4TU3521, A4TU7686

Aplicação / Application: **CATERPILLAR: 320, 50A, 24V, ESCAVADEIRA 320 E 320L, 50A 24V**

Nippondenso

UF-3366

Original:

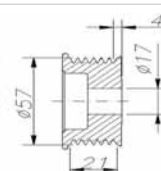

6 canais / grooves

Alternador / Alternator:

ER / IF - IR - IF (90A)

Aplicação / Application: **CHEVROLET-GM CHRYSLER, DODGE, EAGLE, JEEP, LEXUS, PLYMOUTH, TOYOTA**

Nippondenso

UF-3410

Original: 10.12.11/2671

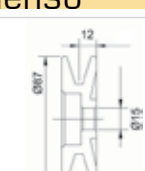

1 canal / groove

Alternador / Alternator:

Aplicação / Application: **TOYOTA: BANDEIRANTES, JIPE, PICAPE C/ MOTOR TOYOTA 14B 3.7L (DIESEL)**

Prestolite

(Delphi/Indiel/Lucas)

UF-3333

Original: 2Y4213

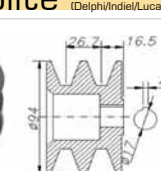

2 canais / grooves

Alternador / Alternator:

Aplicação / Application: **CATERPILLAR: CATERPILLAR - FURO PEQUENO**

Prestolite (Delphi/Indie/Lucas)

UF-3334 Original: 2Y8924

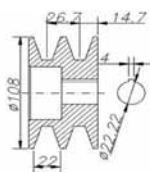

2 canais / grooves

Alternador / Alternator: _____
Aplicação / Application: **CATERPILLAR:**
CATERPILLAR - FURO GRANDE

Prestolite (Delphi/Indie/Lucas)

UF-3359 Original: 2Y 4206

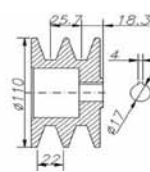

2 canais / grooves

Alternador / Alternator: _____
Aplicação / Application: **CATERPILLAR**

Prestolite (Delphi/Indie/Lucas)

UF-3362 Original: 2P6265/4N8090

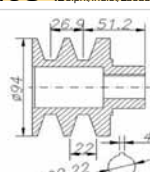

2 canais / grooves

Alternador / Alternator: _____
Aplicação / Application: **CATERPILLAR:**
COM ALTERNADOR PRESTOLITE

Valeo

UF-3378 Original: _____

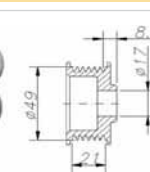

6 canais / grooves

Alternador / Alternator: 439427
Aplicação / Application: **CHEVROLET-GM:** ASTRA, CORSA, VECTRA - TODOS C/ ALT. VALEO 100A

Valeo

UF-3391 Original: 2542347-A

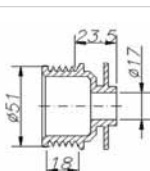

5 canais / grooves

Alternador / Alternator: _____
Aplicação / Application: **MERCEDES-BENZ:**
CLASSE A - C/ ALTERNADOR VALEO

Valeo

UF-3405 Original: _____

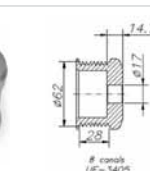

8 canais / grooves

Alternador / Alternator: A14N183M
Aplicação / Application: **VOLVO:** FH, NH / GLOBO TRATO, COM ALTERNADOR VALEO

Valeo / Bosch

UF-3409 Original: Valeo: SGSSG9B 047

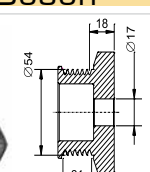

6 canais / grooves

254-2548A, Bosch: 012425031
Alternador / Alternator: 8200 103726-90A, 0 124 325 024 /031, 0 124 415 013 /014/ 038/ 040/ 041, 0 986 042 720/ 770
Aplicação / Application: **RENAULT:** LOGAN, ESPACE, KANGOO, LAGUNA, MEGANE E SCENIC, CITROEN

Valeo

UF-3411 Original: 593518

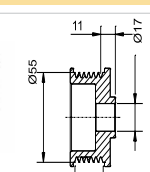

6 canais / grooves

Alternador / Alternator: _____
Aplicação / Application: **RENAULT**

Valeo

UF-3412 Original: 592920

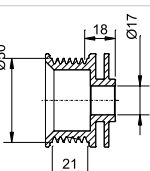

6 canais / grooves

Alternador / Alternator: _____
Aplicação / Application: **VOLKSWAGEN, AUDI**

Valeo

UF-3413 Original: 493813

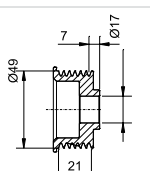

6 canais / grooves

Alternador / Alternator: 43 9466
Aplicação / Application: **FORD:** COURIER 1.0, 1.6, ESCORT 1.6, 1.6 SW, FIESTA 1.0, 1.6 / SEDAN, KA 1.0, 1.6, NOVO FIESTA 1.0, 1.6

Valeo

UF-3414 Original: 493802

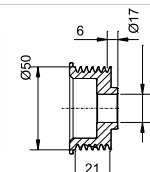

6 canais / grooves

Alternador / Alternator: _____
Aplicação / Application: **CHEVROLET - GM**

Valeo

UF-3415 Original: 493807

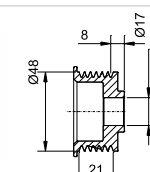

6 canais / grooves

Alternador / Alternator: _____
Aplicação / Application: **FORD**

Valeo **UF - 3.416** Original: 493804

Alternador / Alternator: _____
Aplicação / Application: **CITROEN, PEUGEOT**

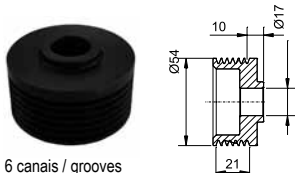

6 canais / grooves

Valeo **UF - 3.417** Original: 493800

Alternador / Alternator: _____
Aplicação / Application: **CHEVROLET - GM**

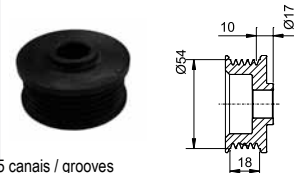

5 canais / grooves

Valeo **UF - 3.418** Original: 593623

Alternador / Alternator: _____
Aplicação / Application: **PEUGEOT**



3 canais / grooves

Valeo **UF - 3.429** Original: _____

Alternador / Alternator: **A13VI179**
Aplicação / Application: **RENAULT: MASTER COM MOTOR IVECO**

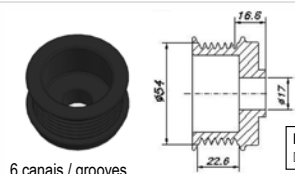

6 canais / grooves

Em desenvolvimento
Development process

Valeo **UF - 3.432** Original: _____

Alternador / Alternator: **0 124 325 064**
Aplicação / Application: **VOLVO**

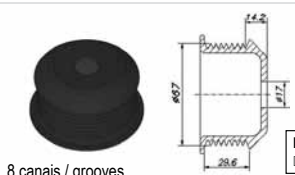

8 canais / grooves

Em desenvolvimento
Development process

Diversos **UF - 3.335** Original: 625/0333653

Alternador / Alternator: _____
Aplicação / Application: **SCANIA: MOTORES / ENGINES (04/87->)**

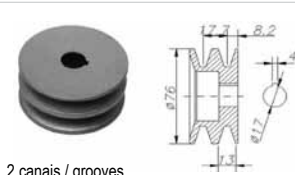

2 canais / grooves

Diversos **UF - 3.345** Original: 7 079 314

Alternador / Alternator: _____
Aplicação / Application: **FIAT: PALIO**



6 canais / grooves

Diversos **UF - 3.354** Original: _____

Alternador / Alternator: _____
Aplicação / Application: **MAZDA, MERCURI, MIT-SUBISHI**

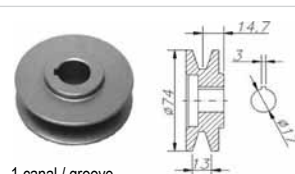

1 canal / groove

Diversos **UF - 3.357** Original: 113903109-2

Alternador / Alternator: _____
Aplicação / Application: **VOLKSWAGEN: SEDAN - TO-DOS C/ DÍNAMO 6V**

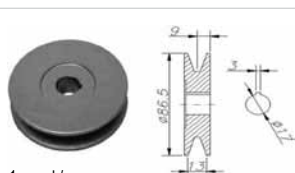

1 canal / groove

Diversos **UF - 3.364** Original: _____

Alternador / Alternator: _____
Aplicação / Application: **VALMET: SÉRIE 1795**

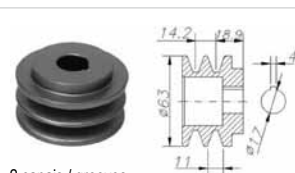

2 canais / grooves

Diversos **UF - 3.367** Original: _____

Alternador / Alternator: _____
Aplicação / Application: **PEUGEOT: 405 - 1.6 / 1.8 / 1.9, 406 - 1.6 / 1.8, CITROEN: XSARA - 1.8, ZX - 1.6 / 1.8 / 1.9 / 2.0**

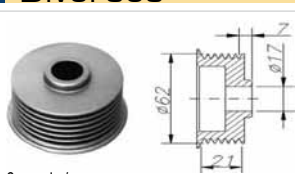

6 canais / grooves

Diversos **UF - 3.370** Original: _____

Alternador / Alternator: _____
Aplicação / Application: **RENAULT, CITROEN, PEUGEOT**



6 canais / grooves

Diversos **UF - 3.383** Original: 82610900

Alternador / Alternator: _____
 Aplicação / Application: VALMET: TRATORES - 1780 / 1280 - C/ MOTOR MWM (PAINEL DIGITAL)

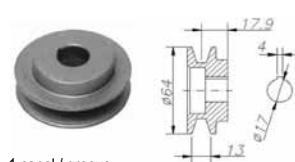

1 canal / groove

Diversos **UF - 3.384** Original: 82610900

Alternador / Alternator: _____
 Aplicação / Application: VALMET: TRATORES - 1780 / 1280 - C/ MOTOR MWM (PAINEL DIGITAL)

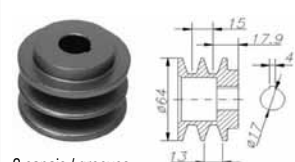

2 canais / grooves

Diversos **UF - 3.385** Original: 82024500

Alternador / Alternator: _____
 Aplicação / Application: VALMET: TRATORES - BH180 / BH140

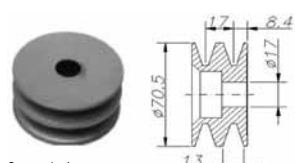

2 canais / grooves

Diversos **UF - 3.386** Original: 82024400

Alternador / Alternator: _____
 Aplicação / Application: VALMET: TRATORES - BM110 / BM985

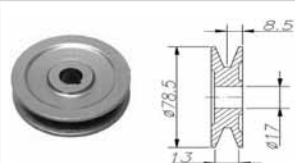

1 canal / groove

Diversos **UF - 3.389** Original: _____

Alternador / Alternator: _____
 Aplicação / Application: OUTRAS: CONDICIONADOR DE AR PARA ÔNIBUS

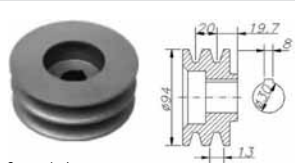

2 canais / grooves

Diversos **UF - 3.394** Original: _____

Alternador / Alternator: _____
 Aplicação / Application: SCANIA: COM AR CONDICIONADO - ALTERNADOR 105A

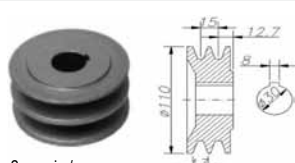

2 canais / grooves

Diversos **UF - 3.400** Original: _____

Alternador / Alternator: _____
 Aplicação / Application: CHEVROLET-GM: VECTRA C/ AR-CONDICIONADO 120A, MARCOPOLO: MICRO ÔNIBUS VOLARE

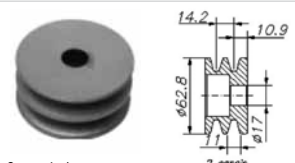

2 canais / grooves

Diversos **UF - 3.403** Original: _____

Alternador / Alternator: _____
 Aplicação / Application: CHEVROLET-GM: PICK-UP C 10 - 6 CIL. - 1967 A 1981, CAMINHÕES A14C / C14C

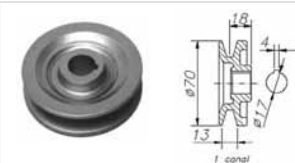

1 canal / groove

Diversos / ZM Motores **UF - 3.431** Original: _____

Alternador / Alternator: ZM 9010501
 Aplicação / Application: GREEN HORSE: TRATORES AGRICOLAS

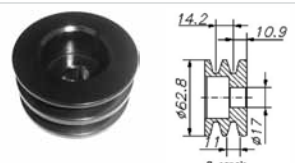

2 canais / grooves

Diversos **UF - 3.433** Original: _____

Alternador / Alternator: _____
 Aplicação / Application: VOLVO: EMPILHADEIRA LINDE / FORKLIFT

Em desenvolvimento
Development process

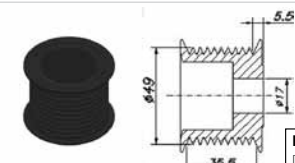

10 canais / grooves

Bosch | **UF - 33.002**

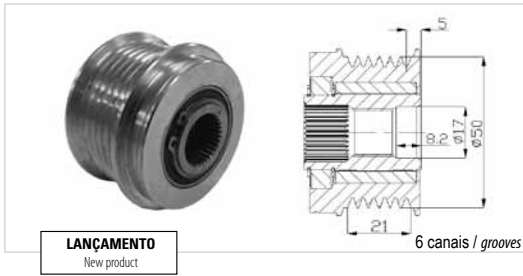

Original: **BOSCH:** F00M991134, **INA:** F2269625, F2269628

Alternador / Alternator: **BOSCH:** 0124325114, 0124515089, **CHEVROLET-GM:** 93322958

Aplicação / Application: **CHEVROLET-GM:** ASTRA 1.8 /2.0 /2.4 16V, VECTRA 2.0 /2.2 /2.4 16V, ZAFIRA 2.0 /2.0 16V

Bosch | **UF - 33.004**

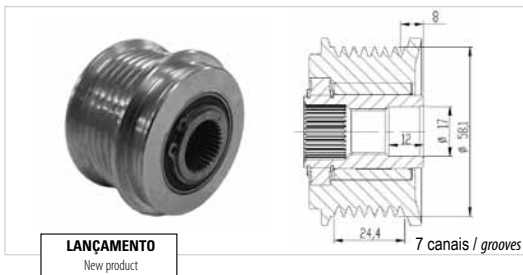

Original: **BOSCH:** F00M991221, F00M991916, **TOYOTA:** 274150L020

Alternador / Alternator: **BOSCH:** 0124315033, 0124315034

Aplicação / Application: **TOYOTA:** HILUX 2.5 / 2.8 / 3.0 MOTOR / ENGINE D4D 2005 ->

Bosch | **UF - 33.007**

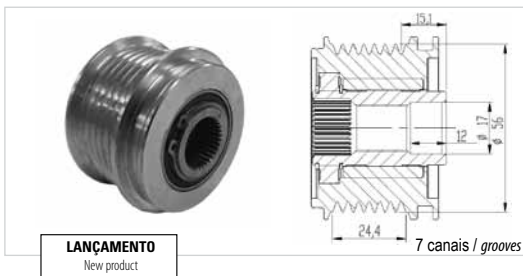

Original: **BOSCH:** F00M991138, **CARGO:** 234793, **IKA:** 335681, **INA:** F2320012, **MERCEDES-BENZ:** 2711540902, 2711550016, **VALEO:** 593625

Alternador / Alternator: **BOSCH:** 0124615022, 0124615028

Aplicação / Application: **MERCEDES-BENZ:** C 160/C 180 KOMPRESSOR /SPORTCOUPE, Cabrio, CLK 200 CGI KOMPRESSOR, COUPE, E 200 KOMPRESSOR, T C 200 CGI KOMPRESSOR /-SPORTCOUPE, T C 230 KOMPRESSOR /-SPORTCOUPE, T SLK 200 KOMPRESSOR

Bosch | **UF - 33.008**

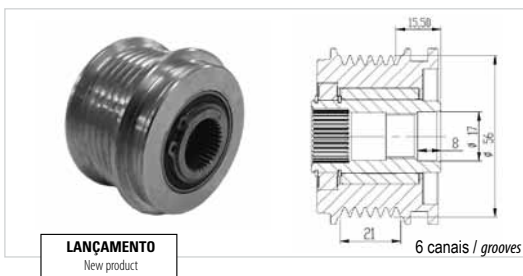

Original: **BOSCH:** 1126601568, 6033GD5036, **IKA:** 3518, **INA:** F2256444, F2256445, F2256446, F2256447, F228215, **LUK:** 535000310, **MERCEDES-BENZ:** 6021500060, **REMY:** 6041500060, 6041500360, **VALEO:** 2547128, 593495

Alternador / Alternator: **BOSCH:** 0123320041, 0123320046, 0123320062, 0123510038, 0123510049, 0123510080, 0123510101, 6033GB3040, 6033GB3031, 6033GB3030, 6033G30408, **MERCEDES-BENZ:** 011154

Aplicação / Application: **MERCEDES-BENZ:** C200 TD, C220 TD, C250 TD, E200 D, TD, E220 D, TD, E250 D, TD, E290 D, TD, E300 D, TD, G300 TD, G-CLASS OM 602 MIT TOPFGENERATOR S300 TD, SPRINTER 208, 210, 212, 308, 310, 312, 408, 410, 412, 512, 612, 812. UNIMOG. VARIO.

Bosch

UF - 33.011

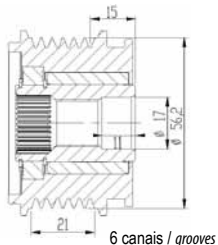

LANÇAMENTO
New product

Original: **BOSCH:** F00M991002, F00M991122, **HITACHI:** GD2149981, **IKA:** 3520, **INA:** F2276284, F2276285, F2276286, F2276287, **LUK:** 535000410, 535001210, **VALEO:** 2546778, **VOLKSWAGEN:** 022903119AM, 028903119A, 028903119AM, 028903119T, 038903119A

Alternador / Alternator: **BOSCH:** 0124315001, 0124315013, 0124325001, 0124325012, 0124325047, 0124325073, 0124325083, 0124325101, 0124515010, 0124515022, 0124515117, 0124525027, 0124525039, 0124525050, 0124615017, 028903028E, 028903029G, **VOLKSWAGEN:** 021903119G

Aplicação / Application: **AUDI:** A 2 1.4 TD A2 1.4 TDI, PDE. A3 1.6, 1.8, QUATTRO, 1.8 T, 1.9 TDI, 1.9 TDI QUATTRO, S3 QUATTRO. A3 1.9 TD. TT COUPE 1.8 T, 1.8 T QUATTRO. TT ROADSTER 1.8 T, 1.8 T QUATTRO. TT 168 T, TT 168 T - QUATTRO. TT 1.8 T, 1.8 T QUATTRO. **FORD:** GALAXY 1.9 TDI. **SEAT:** ALHAMBRA 1.8 T 20V, 1.9 TDI, 2.8 V6, 2.8 V6 4. AROSA 1.4 TDI. CORDOBA 1.4 DSI, TDI. CORDOBA 1.9 DSI, TDI, D, TD. CORDOBA 1.9 Vario DSI, TDI, D, TD. IBIZA II 1.9 TDI. IBIZA III 1.9 TDI, SDI. IBIZA IV 1.4 TDI. IBIZA IV 1.9 TDI, SDI. INCA 1.9 SDI. LEON 1.6, 1.8 20V, 1.8 20V T, 1.8 T CUPRA R, 1.9 SDI, 1.9 TDI, 1.9 TDI SYNCRO, 2.8 CUPRA 4. TOLEDO II 1.6, 1.8 20V, 1.9 TDI, 2.3 V5, 2.3 V5 20V. **SKODA:** FABIA 1.9 TDI, COMBI 1.9 TDI, SALLON 1.9 TDI. OCTAVIA 1.6, 1.8 T, 1.8 T 4x4, 1.9 TDI, 2.0, RS 1.8 T. PRAKTIK 1.9 SDI. **VOLKSWAGEN:** BORA 1.9 TDI, 2.0, 2.3 VRS. GOLF IV 1.9 SDI, TDI. GOLF IV 1.9 VARIANT SDI, TDI. GOLF IV SDI, TDI. LUPO 1.2, 1.4 TDI. NEW BEETLE 1.9 TDI, 2.0. POLO 1.4 TDI 1.9 SDI, TDI. SHARAN 1.9 TDI.

Mitsubishi

UF - 33.010

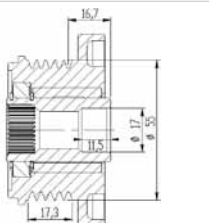

LANÇAMENTO
New product

Original: **MITSUBISHI:** A660C300EX, **RENAULT:** 8200113636, **IKA:** 3 5316 1, **CARGO:** 233797, **INA:** 535 0116 10

Alternador / Alternator: _____

Aplicação / Application: **MITSUBISHI, NISSAN:** MICRA 1.5 DIESEL, **RENAULT:** CLIO II, III, MEGANE II, III, SCENIC II

Nippondenso

UF - 33.005

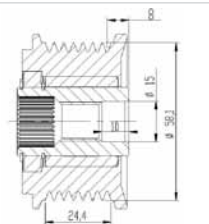

LANÇAMENTO
New product

Original: **NIPPONDENSO:** 0210401070, 1042103410, **CARGO:** 236763, **IKA:** 353791, **INA:** F567525, **LUK:** 535017310, **TOYOTA:** 270600L20, 274150I030, 2741530020

Alternador / Alternator: **NIPPONDENSO:** TG42109010, 1022112810, 1022115600, 1022115670, 2706030020, 2706030030

Aplicação / Application: **TOYOTA:** HIACE IV 2.4 D-4D, HILUX 3.0 / 3.0 SW4

Valeo

UF - 33.001

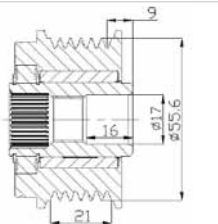

LANÇAMENTO
New product

Original: **VALEO:** 2220306, 2548207, **IKA:** 3558, **INA:** F233593, F2335932, **NYTRON:** 1221

Alternador / Alternator: **VALEO:** SG10B017, 2542434

Aplicação / Application: **CHEVROLET-GM:** BLAZER MWM 2.8D, S10 MWM 2.8D, TRACKER MWM 2.8D, **MERCEDES-BENZ:** SPRINTER, **NISSAN-DATSUN:** FRONTIER MWM 2.8D, TROLLER: T4 MWM 2.8D

Valeo

UF - 33.003

Original: CHEVROLET-GM: 93387684, INA: F236716

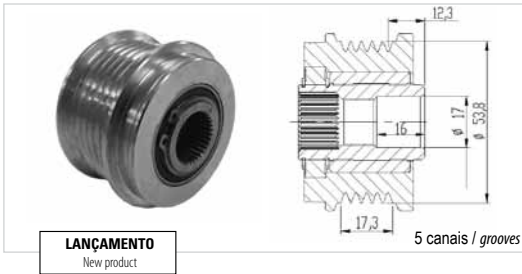

Alternador / Alternator: VALEO: B2220147A, SG10B034, CHEVROLET-GM: 93387684

Aplicação / Application: FIAT: DOBLO 1.8 OHCI (2003->) C/ AC., PALIO 1.8 OHCI (2002->) C/ AC., STILO 1.8 OHCI 2003->) C/ AC, CHEVROLET-GM: MERIVA 1.8 8V (2002 / 2003), CORSA 1.8 OHCI (2002->) C/ AC - S/ DH. CORSA SEDAN OHCI (2002->) C/ AC - S/ DH

Valeo

UF - 33.006

Original: VALEO: 2655703, CARGO: 237674, HYUNDAI: K406701, IKA: 335891, INA: F2327741, 23277401, 23277403, 23277403, 23277404, 23277404, 23277405, 23277405, 2327741, 535007910, KIA: 406607

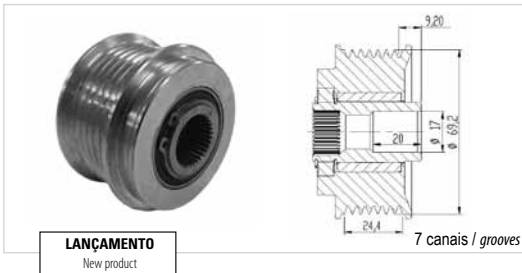

Alternador / Alternator: VALEO: 2605359, HYUNDAI: 37300-4A001, 37300-4A002, 37300-4A003, KIA: 37300-4A110, 37300-4A111, 37300-4A112, 37300-4A113, 37300-4A201, 37300-4A202, 37300-4A203, MANDO: AF111382, AF111393

Aplicação / Application: HYUNDAI: H1, PORTER PICK-UP, STAREX 2.5L 4 CIL., KIA: SORENTO 2.5 CRDi. 2.5 4 CIL.

Valeo

UF - 33.009

Original: VALEO: 493839, RENAULT: 110616, 7700110616

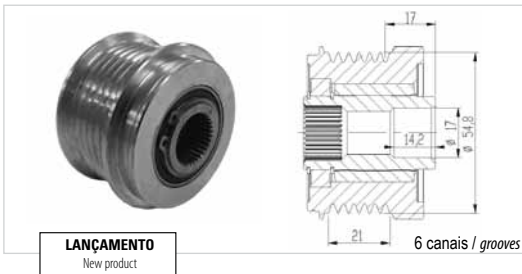

Alternador / Alternator: VALEO: SG9B033, 2542420A, 2542420B, 2542420C, 2542548A, 437311, 437622, BOSCH: LRB460, 0124415007, 0124415013, 0124415014, 0986041850, 0986042770, 4185, 4277, LUCAS: LRB00460, RENAULT: 7700421477, 7700434900, 8200030635, 8800030635

Aplicação / Application: RENAULT: CLIO II 1.6 16V, LAGUNA 1.6 16V (05/1998-01/2001), LAGUNA 1.8 (05/1998-01/2001), MEGANE II 1.6 16V, MEGANE 1.4 /1.6, SANDERO, SCENIC RX4 2.0

Bosch **UF - 4.401** Tipo / Type: **MPB e MPJ**

Original: 214013

Partida / Starter: 9 000 083 043 / 065 / 066 / 068;
9 000 453 016 / 020 / 033 / 034 / 038 / 041 / 044 / 045 / 046
/ 047 / 048 / 049 / 050 / 051 / 052 / 053 / 054 / 060 / 061

Aplicação / Application: **AGRALE-DEUTZ, CASE, CBT, CHEVROLET-GM, CHRYSLER, CLARK, EATON,**

FIAT-ALLIS, FORD, HYSTER, MASSEY-FERGUSON, NEW HOLLAND, VOLKSWAGEN

APLICAÇÃO / APPLICATION: UF-1.102 / 1.103 / 1.110 / 1.111

Bosch **UF - 4.403** Tipo / Type: **EF**

Original: 9 001 082 207

Partida / Starter: 0 001 211 219, 9 000 082 028 / 033 /
042 / 046 / 049 / 053 / 054 / 059 / 061 / 064 / 066 / 069
/ 070 / 073 / 074 / 078 / 079 / 082 / 083, F 000 ALO 301,
F 000 ALO 306

Aplicação / Application: **AGRALE-DEUTZ, CHEVROLET-GM, FIAT, FORD, GURGEL, LADA, MOTOR TIETÊ,**

VOLKSWAGEN, YANMAR

APLICAÇÃO / APPLICATION: UF-1.101

Bosch **UF - 4.406** Tipo / Type: **MWB**

Original: 214006 (WAPSA)

Partida / Starter: 9 000 451 017

Aplicação / Application: **VOLKSWAGEN, FORD:**
ESCORT - ÁLCOOL E TRANSMISSÃO AUTOMÁTICA /
AUTOMATIC TRANSMISSION

APLICAÇÃO / APPLICATION: UF-1.107

Bosch **UF - 4.407** Tipo / Type: **MWB**

Original: 214011 (WAPSA)

Partida / Starter: _____

Aplicação / Application: **VOLKSWAGEN, FORD**

APLICAÇÃO / APPLICATION: UF-1.107

Bosch **UF - 4.411** Tipo / Type: **DA, DW, DM**

Original: 1 001 933 111

Partida / Starter: F 000 ALO 401

Aplicação / Application: **VOLKSWAGEN: GOL, PARATI GERAÇÃO 2 E 3 COM MOTORES 1.0 MI, 16V E TURBO A PARTIR DE SETEMBRO/2001, PARTIDAS DW E DM, GM, FIAT: DUCATO, FORD**

Bosch **UF - 4.416** Tipo / Type: **EV**

Original: 9 003 333 931

Partida / Starter: 0 001 223 505 / 003 / 010, 0 001 231 003

Aplicação / Application: **FORD, FIAT: DUCATO, IVECO, MBB**

Bosch **UF - 4.402** Tipo / Type: **JF**

Original: 2 001 933 134 / 135

Partida / Starter: 0 001 362 046/ 081, 0 001 367 029/ 054/ 061, 0 001 368 001/ 069/ 300/ 301/ 302/ 306/ 307/ 309, 0 001 369 014, 9 000 083 028/ 029/ 031/ 035/ 036/ 038/ 042/ 043/ 050/ 053/ 054/ 055/ 056/ 058/ 059/ 061/ 062/ 063/ 064/ 065/ 066/ 067/ 068/ 069/ 071/ 072/ 073/ 074/ 075/ 076/ 077, 9 000 453 072/ 074/ 075/ 076/ 077/ 079/ 080/ 082/ 083/ 086/ 088/ 089/ 090/ 091, F 000 ALO 602 / 700.

Aplicação / Application: **AGRALE-DETZ, CASE, CBT, CHEVROLET-GM, EL DETALLE, FIAT, FIAT-ALLIS, FORD, IVECO, JOHN DEERE, KOMATSU, MASSEY-FERGUSON, MAXION, MERCEDES-BENZ, MÜELLER, MWM-DIESEL, NEW HOLLAND, PERKINS, PUMA, SLC, TOYOTA, VALMET, VOLKSWAGEN, VOLVO, YANMAR**

APLICAÇÃO / APPLICATION: UF-1.104 / 1.105 / 1.112 / 1.113

Bosch **UF - 4.404** Tipo / Type: **JD**

Original: 9 001 083 243

Partida / Starter: 9 000 083 024, 9 000 083 053, 9 000 083 069, 9 000 083 072

Aplicação / Application: **FIAT: 70 / 100 /130, AGRALE-DEUTZ: 1800 D, BX 4.60 / 60, TX 1600, CASE: W18 / W 20 / W 20 B, CBT: 1065 / 1105 / 2080 / 2105 / 8060 4X4, MERCEDES-BENZ: SÉRIES - 6T L, 10T, 11T L, 13T L, 15T L, 20T L, 22T L, O, SLC: 6200, 6200 TURBO, 7200 / 7700 / TURBO, MÜELLER: VIBRO RT 62 / 82, MWM-DIESEL: D 229-3 / 229-4 / 229-6, TBD 229-EC-6, TD 229-6, SLC: 7000 - 7200 TURBO, VALMET: 62 ID, 65 ID, 85 ID, 110 ID, 685, 685 ECO, MASSEY-FERGUSON: MF-200-235 / 265 / 265/4**

Bosch **UF - 4.408** Tipo / Type: **ED**

Original: 9 001 082 261

Partida / Starter: _____

Aplicação / Application: **FORD: CORCEL, VOLKSWAGEN**

Bosch **UF - 4.415** Tipo / Type: **DM, DW**

Original: 1 001 933 000 / 101 / 059

Partida / Starter: _____

Aplicação / Application: **FIAT, CHEVROLET-GM, NISSAN, TROLLER**

Bosch **UF - 4.427** Tipo / Type: **JE**

Original: 2 001 933-021 / N° Antigo - 9 001 453 645

Partida / Starter: _____

Aplicação / Application: **MERCEDES-BENZ, CARGO, CAMINHÃO VOLKSWAGEN**

Bosch / Delco

UF - 4.428 Tipo / Type: **JE**



Original: 2 001 933 018/ 021, DELCO 1907195
Partida / Starter: 0 001 371 004/ 005/ 006/ 007/ 008/
010/ 012/ 013, 0 001 372 001/ 002/ 003/ 004/ 005/ 006
Aplicação / Application: CASE: W 36 B TURBO, CUMMINS:
CT 6 CT 8.3, KENWORTH: 13.120/ 22.210/ 23.210, VOLKSWA-
GEN: 16T 16.210, MBB: 16L L 1625, 18TLLG 1825, 19TLLS 1938,

23TL LAL/LK2325, 26TLLS 2638. SCANIA: SÉRIES 114, 124, DS, DSC E DSI.

Delco

UF - 4.409 Tipo / Type: **28MT**



Original: 10456464
Partida / Starter: 113277, 10479621
Aplicação / Application: CUMMINS: MOTORES
3,96 KW 24V, MOTORES 2,90 KW 12V

Delco

UF - 4.422



Original: PG 260
Partida / Starter: 900890, 9000891, 2415.198 ED.T
Aplicação / Application: CHEVROLET-GM: ASTRA,
BLAZER / S10 VORTEC V6 4.3L, VECTRA, CORSA,
FORD: ECOSPORT

Delco

UF - 4.432 Tipo / Type: **38MT**



Original: 10512089
Partida / Starter: 8200005, 8200025, 8200053, 8200072,
8200077, 200078, 200356
Aplicação / Application: CUMMINS, FORD,
VOLKSWAGEN

Magneti Marelli

UF - 4.417



Original:
Partida / Starter: Magneti Marelli
Aplicação / Application: FIAT

Mitsubishi

UF - 4.420



Original:
Partida / Starter: CGP 25/ MOT80081/ 381/ 881/ 981-
MOT81081
Aplicação / Application: CHEVROLET-GM, CLARK,
YALE

Delco

UF - 4.405



Original: 11932205
Partida / Starter:
Aplicação / Application: CHEVROLET-GM: OPALA,
CARAVAN

Delco

UF - 4.410 Tipo / Type: **28MT**



Original: 10457361
Partida / Starter: 10479626
Aplicação / Application: MERCEDES-BENZ: CAMI-
NHÕES E ÔNIBUS 712 / 912 / 914 / 1215 / 1417 / 1625 /
1628 / 1632 / 1721 / 1725 / 2423

Delco

UF - 4.431 Tipo / Type: **29MT**



Original: 10515804, 10515805
Partida / Starter: 8200003 / 004 / 054 / 064 / 138 / 196 / 231
/ 292 / 295 / 296 / 297 / 326 / 331 / 357 / 386 / 474 / 478 / 495
/ 511 / 512
Aplicação / Application: CNH, FORD, MERCEDES-
BENZ, VOLVO, VOLKSWAGEN

Iskra

UF - 4.433 Tipo / Type: **AZF4595, Z10, 4,2 Kw**



Original: 16.908.457 / 16.908.335
Partida / Starter: 11.131.370, 11.131.659
Aplicação / Application: NEW HOLLAND: COMBINE
CS 660 - CUMMINS L6 8.3 280CV (COLHEITADEIRA /
COMBINE)

LANÇAMENTO
New product

Magneti Marelli

UF - 4.424



Original:
Partida / Starter: MT67, MT68, MT71, MT72
Aplicação / Application: AGRIFULL, CARRARO,
FIAT ALLIS, FIAT IVECO, RUGGERINI, SIMIT, SLANZ

Mitsubishi

UF - 4.421



Original: MD611223, M864X09771
Partida / Starter: M000T32071ZC, M000T32071,
MOT32071, MOT32071ZC. (CHRYSLER 05034555AA,
5034555AA), PMGR M1T 60081
Aplicação / Application: CHRYSLER: SEBRING 2.4L(144)
L4 (07-09), DODGE: AVENGER 2.4L(144) L4 (08-09),

CALIBER 1.8L(110) / 2.0L(122) / 2.4L(144) L4 (07-09), JOURNEY 2.4L(144) L4 2009, ISUZU: C-240 DIESEL
ENGINES, MAZDA: EMPILHADEIRA / FORKLIFT, MITSUBISHI: EMPILHADEIRA / FORKLIFT, PAJERO, PEU-
GEOT: 405, JEEP: COMPASS 2.0L(122) / 2.4L(144) L4 (07-09), PATRIOT 2.0L(122) / 2.4L(144) L4 (07-09),
PATRIOT L4 (07-09), MERCURY, SUBARU, SUZUKI, YALE: EMPILHADEIRA / FORKLIFT

Motorcraft **UF-4.425** Tipo / Type: **PMGR**

Original: SZ-847 (Ford E90Z-11067-A)

Partida / Starter: Ford PMGR E90F11000AA / BA, E9SF11000AA / BA, F02F11000AA, F07U11000AAA / BA, F0CF11000AA, F17U11000AB, F1VU11000AA.

Aplicação / Application: FORD: ECOSPORT, KA, FIESTA, COURIER, ESCORT, BRONCO

Motorcraft **UF-4.429** Tipo / Type: **PMGR**

Original:

Partida / Starter: FORD PMGR (Mancal de acionamento curto / Noseless Starter)

Aplicação / Application: VOLKSWAGEM: GOL, PARATI, SAVEIRO

Prestolite **UF - 4.412** Tipo / Type: **M74R, Com Mola**

Original: K01331 (Delphi / Lucas / Indiel)

Partida / Starter: M74R

Aplicação / Application: RENAULT, PEUGEOT, VOLKSWAGEM, CHEVROLET-GM, FORD, FIAT

Prestolite **UF - 4.413** Tipo / Type: **M93/100, Com Mola**

Original: K01401 (Delphi / Lucas / Indiel)

Partida / Starter: M93-12V, M100 12/24V

Aplicação / Application: AGRALE, FORD, CHEVROLET-GM, CUMMINS, VOLKSWAGEM, MERCEDES-BENZ, PEUGEOT, JOHN DEERE, MAXION

Prestolite **UF - 4.414** Tipo / Type: **M93/100, Sem mola**

Original: K01190 (Delphi / Lucas / Indiel)

Partida / Starter: M93-12V, M100 12/24V

Aplicação / Application: AGRALE, FORD, CHEVROLET-GM, CUMMINS, VOLKSWAGEM, MERCEDES-BENZ, PEUGEOT, JOHN DEERE, MAXION

Valeo **UF - 4.418** Tipo / Type: **D7E**

Original:

Partida / Starter: D7E- 56, 12V, 2415.198 ED.T

Aplicação / Application: CHEVROLET-GM: CORSA, FORD, VOLKSWAGEN

Valeo **UF - 4.419** Tipo / Type: **D7E**

Original:

Partida / Starter: D7E- 34, 12V, D7E- 43, 12V 27H4.116 FS , 05L5.068 WAL-F

Aplicação / Application: CHEVROLET-GM: CORSA, VOLKSWAGEN, FORD, RENAULT, CITROEN, PEUGEOT, FIAT: STILO E PALIO 1.8

Valeo **UF - 4.423** Tipo / Type: **D6R**

Original:

Partida / Starter: D6RA65 165, D6RA85 185

Aplicação / Application: CHEVROLET-GM: CORSA, RENAULT, PEUGEOT, CITROEN.

Valeo **UF - 4.430** Tipo / Type: **D7R**

Original:

Partida / Starter: 0041518901, 004151890180, 0041519201, 004151920180, 0041519701, 04151970180, 0051511301, 005151130180 /87

Aplicação / Application: MB, RENAULT, MITSUBISHI, HYUNDAI, KIA

Reparos Para Garfos
Repairs for Engaging levers

Bosch **R - 4.411**

Tipo / Type: **DA, DW, DM**

Partida / Starter: F 000 AL0 401

Aplicação / Application: VOLKSWAGEM: GOL, PARATI GERAÇÃO 2 E 3 COM MOTORES 1.0 MI, 16V E TURBO A PARTIR DE SETEMBRO/2001, PARTIDAS DW E DM, GM, FIAT: DUCATO, FORD

Bosch **R - 4.415**

Tipo / Type: **DM, DW**

Partida / Starter:

Aplicação / Application: FIAT, CHEVROLET-GM, NISSAN, TROLLER

Bosch **R - 4.416**

Tipo / Type: **EV**

Partida / Starter: 0 001 223 505 / 003 / 010, 0 001 231 003

Aplicação / Application: FORD, FIAT: DUCATO, IVECO, MBB

Bosch

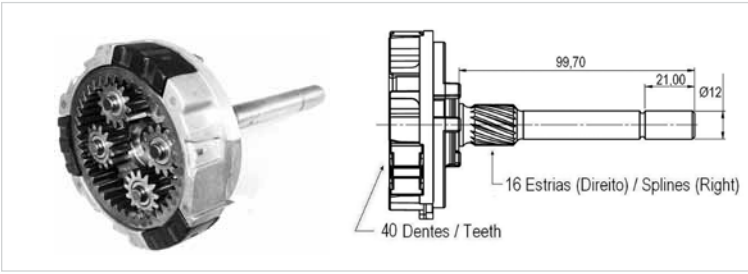

UF-11.003

Tipo / Type: EV 12v - 2.3 Kw

Original: 6 033 AD0 053

Partida / Starter: 0 001 223 001/ 009/ 010/ 013

Aplicação / Application: FIAT: DUCATO 10 2.8 TD/ TD EGR (97-02), FORD: F-250 6CC MWM 6.07 TCA (99->), IVECO: DAILY 12 8140 (97->), PEUGEOT: JUMPER

Bosch

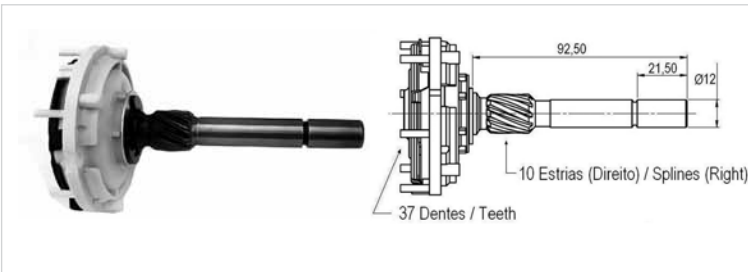

UF - 11.010

Tipo / Type: DW

Original: 1 006 200 110

Partida / Starter: 0 001 107 009/ 015, 9 000 081 004

Aplicação / Application: ALFA ROMEO: ALFA 145-1.6ie, CHEVROLET-GM: ASTRA/ BLAZER/ IPANEMA/ KADETT/ OMEGA/ S-10/ VECTRA/ ZAFIRA, OPEL: ASTRA/ CALIBRA/ OMEGA/ VECTRA

Bosch

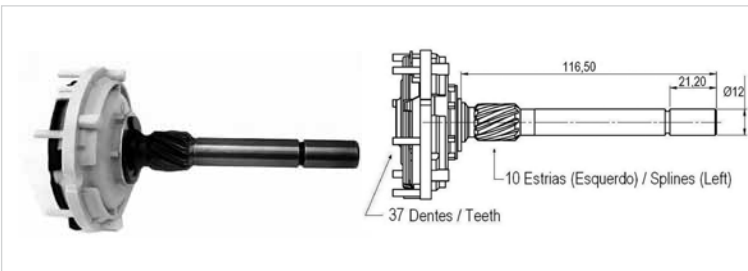

UF - 11.015

Tipo / Type: DW

Original: F 000 AL1 015

Partida / Starter: 9 000 081 001/002

Aplicação / Application: FORD: ESCORT 1.6i / 1.8i / 2.0i ; VERONA 1.8i / 2.0i, SEAT: INCA 1.6 EFI, VOLKSWAGEN: LOGUS 1.6/1.8/2.0/i/Mi / POINTER 1.8/2.0/i/Mi / VAN 1.6Mi

Bosch

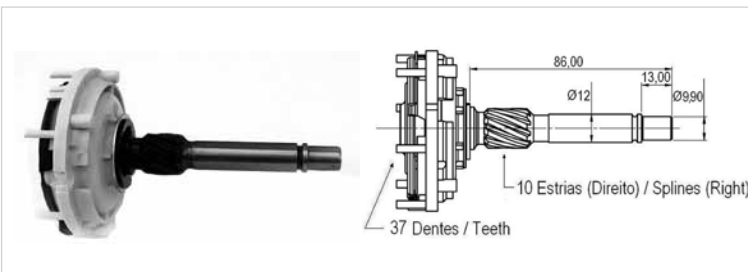

UF - 11.018

Tipo / Type: DW

Original: 1 006 200 123 (1 006 200 018)

Partida / Starter: 0 001 108 026 / 048 / 136 / 146 / 154 / 159 / 0 001 109 040, F 005 M00 012 / 014

Aplicação / Application: AUDI: 100 - 2.2 / 200 2.2TURBO, CITROEN: BERLINGO/ XANTIA/ XM/ XSARA/ ZX, PEUGEOT: 306/ 405/ 605/ 806/ PARTNER, ALFA ROMEO: ALFA 155 2.0TS /156 /164 /166 /SPIDER, FIAT: CROMA 2.0ie / 16V / TURBO, JEEP: CHEROKEE 2.5i, LAND ROVER: RANGE ROVER I / II, HOLDEN: CALAIS 5.0/ CAPRICE 5.0/ STATESMAN 5.0, CHEVROLET-GM: OMEGA IMPORTADO (AUSTRALIA) 3.8/V6

Bosch

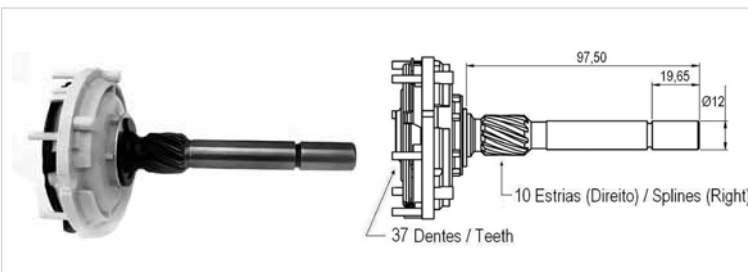

UF - 11.019

Tipo / Type: DW

Original: F 000 AL1 019

Partida / Starter: 9 000 081 006, 9 000 081 007

Aplicação / Application: VOLKSWAGEN: GOL, PARATI, QUANTUM, SANTANA, SAVEIRO, VOYAGE

Bosch

UF - 11.029 Tipo / Type:

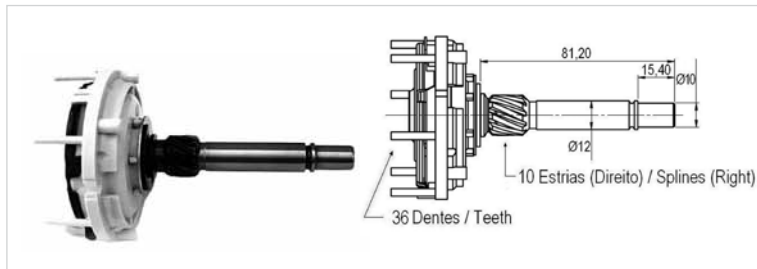

Original: 2 337 1F4 029

Partida / Starter: 9 008 046 015

Aplicação / Application: NISSAN

Bosch

UF - 11.037 Tipo / Type: DW

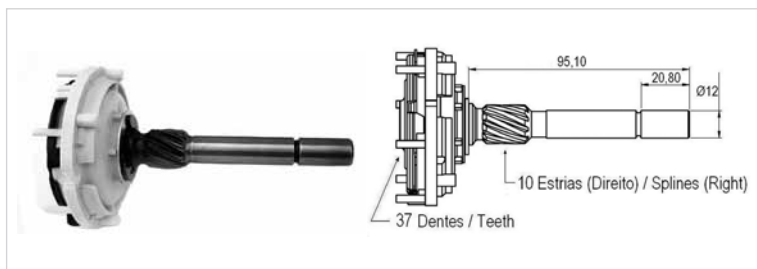

Original: F 000 AL1 017 (F 000 AL1 037)

Partida / Starter: 9 000 081 005, 9 000 081 008, F 000 AL0 100

Aplicação / Application: FIAT: TEMPRA 2.0 / MPI / SPI / 8V / 16V / TURBO, PALIO 1.6 16V, PALIO WEEKEND 1.6 16V, TEMPRA TURBO 2.0 MPI 8V

Bosch

UF-11.056 Tipo/Type: EV 12volts - 2,20 Kw

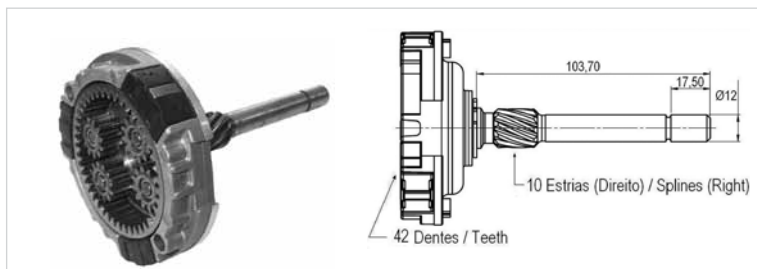

Original: 9 001 337 056 (9 003 336 268)

Partida / Starter: 0 001 218 108 / 137/165/722, 9 000 331 419

Aplicação / Application: MBB: CLASSE S600 SEC V12 / S 600 (MOTOR 120-982) 09.1996>08.1999, 600 SEL (MOTOR 120.980) 04.1991>05.1993, S600 (MOTOR 120.980) 06.1993>09.1995. SÉRIE MB 100D (MOTOR OM 616.963) 09.1991>01.1996, MB 180D (MOTOR 616) 04.1994>, SSANGYONG: MUSSO 2.9 DIESEL (MOTOR OM 662 D29) 07.1993>

Bosch

UF - 11.058 Tipo / Type: DW

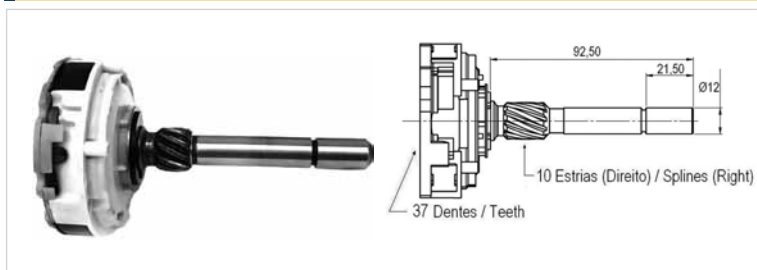

Original: 1 006 200 058

Partida / Starter: 0 001 107 045

Aplicação / Application: OPEL: CALIBRA 2.0i 16V - 09/93 > 08/96, ASTRA 2.0i - 01/95 > 02/98, CHEVROLET-GM: ASTRA, ASTRA SEDAN 2.0i 16V - 02/99>07/01, VECTRA 2.0 16V - 04/96 > 11/97, ZAFIRA 2.0 SFI 16V - 04/01>

Bosch

UF - 11.059 Tipo / Type: DW

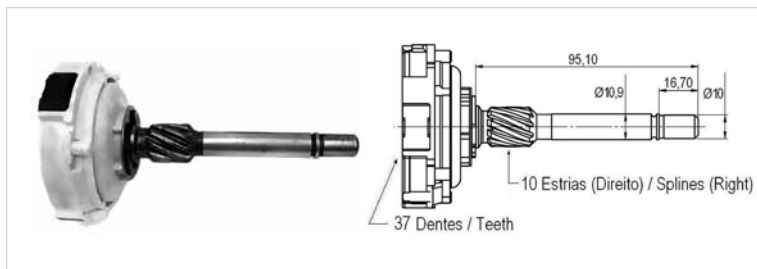

Original: 1 006 200 059 (1 006 200 098)

Partida / Starter: 0 001 108 123, 0 001 108 124, 0 001 108 134, 0 001 108 160, 0 001 108 995, 0 001 107 403

Aplicação / Application: MERCEDES-BENZ: C 180 / T-Modell / 200 / 220 / 230, CLK 230 K.P., E 230, ML 230, SLK 230 K.R., 124-200E, CHRYSLER, DODGE: DAKOTA 2.5 D, GRAND CARAVAN 2.5, VOYAGER 2.5/3.3 / 3.6

Bosch

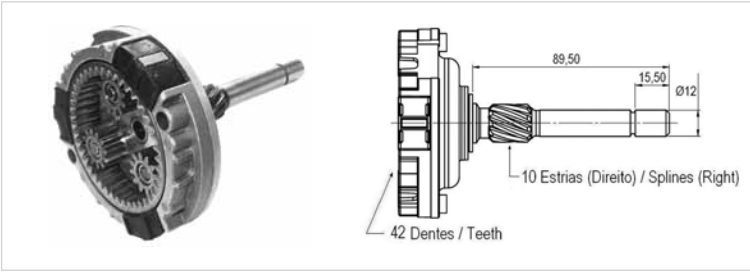

UF-11.067

Tipo/Type: **EV**

Original: 9 001 337 067 (9 001 336 285)

Partida / Starter: 9 000 331 406

Aplicação / Application: **CHEVROLET-GM: ASTRA, BLAZER, S10, VECTRA - II(SOHC) 1.8/2.0/2.2 - 8V ATÉ 03/2001**

Bosch

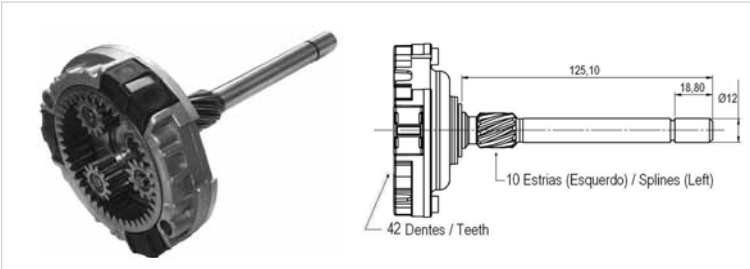

UF-11.073

Tipo/Type: **EV Anti-horário / Counter clockwise**

Original: 9 001 337 073

Partida / Starter: 0 001 218 116 / 117

Aplicação / Application: **VOLKSWAGEN: TRANSPORTER 2.4D, SYNCRO (90-94)**

Bosch

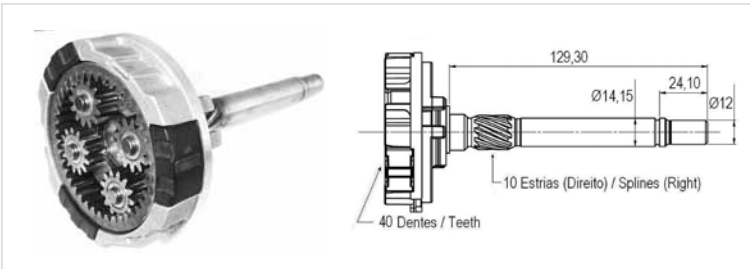

UF-11.090

Tipo/Type: **EV, 12v - 2,6 Kw**

Original: 6 033 AD0 090 / 108, 6 033 AC0 252

Partida / Starter: 0 001 223 505

Aplicação / Application: **FORD: F-250 4CC CUMMINS 4BTAA (98->), F-4000**

Bosch

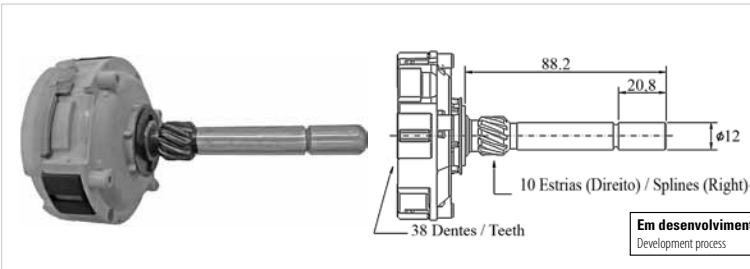

UF - 11.099

Tipo/Type:

Original: 1 006 200 099 / 218

Partida / Starter: 0 001 109 014 / 018 / 026/ 036 / 048 / 300, 0 001 110 012, F 000 AL1 401

Aplicação / Application: **CITROEN: RELAY 2.8, FIAT: DUCATO 2.3 / 2.8, ULYSSE 1.9TD / 2.1TD (95-98), STRADA 1.9D (00 ->), STRADA 1.7TDS (99 ->), PUNTO 1.7 D/ TD (95 - 99), MB: 410D SPRINTER (97 ->00), 312D SPRINTER (95->00), NISSAN: FRONTIER, PEUGEOT: BOXER 2.8**

Bosch

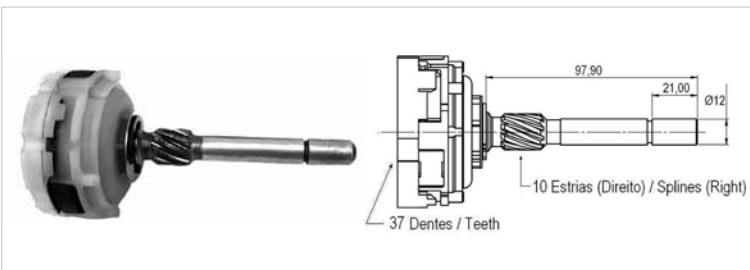

UF - 11.104

Tipo/Type: **DW**

Original: 1 006 200 104 (1 006 200 134)

Partida / Starter: 0 001 107 048, 0 001 108 064 / 080 / 088 / 101 / 102 / 113 / 121 / 143

Aplicação / Application: **MERCEDES-BENZ: E 190 2.3 ; 124 - 230 E, BMW: 325 I ; 525 I, CHEVROLET-GM: OMEGA 3.0I/4.0I; SUPREMA 3.0I/4.0I; C20; SILVERADO 4.1, OPEL: OMEGA 2.4 I / 2.6 I / 3.0 I / EVOLUTION 500 / 3.6I, VOLVO: 740 2.0 INJECTION ; 940 2.3 TURBO ; 960 2.3 TURBO INTERC., AUDI: 80 2.2 RS2 ; 80 2.2 QUATTRO S2 ; S6 2.2 T, 80 - 2.6 / 2.8 ; 80 QUATTRO 2.6 ; 100 - 2.8 ; A6 2.6, FIAT: BRAVA ; FIORINO ; MAREA ; PALIO ; WEEKEND ; SIENA ; STILO ; STRADA, FORD: ESCORT 1.6I 16V / CABRIO / TURNIER / XR3I ; MONDEO 1.8I/2.0I, RENAULT: CLIO 2.0I WILLIAMS ; LAGUNA 2.0 I**

Bosch

UF - 11.111

Tipo / Type: **LT**

Original: F 000 AL1 974

Partida / Starter: F 000 AL0 111

Aplicação / Application: **TOYOTA: HILUX/ SW4 D4D 2.5/ 2.8/ 3.0 DIESEL (2006 ->)**

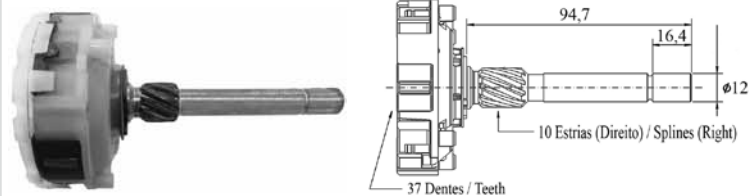

Bosch

UF - 11.117

Tipo / Type:

Original: 1 006 200 117 (2.2363.0)

Partida / Starter: 0 001 125 001 / 002 / 005 / 006 / 007 / 008 / 009 / 010 / 012 / 013 / 021 / 022 / 031 / 032 / 035 / 036 / 042 / 043 / 051 / 052

Aplicação / Application: **AUDI: A2/A3/S3 1.9 TDI, FORD: GALAXY 1.9 / 2.0 / 2.3 / 2.8 TDI / VR6, SEAT: ALHAMBRA, CORDOBA, IBIZA II, LEON, TOLEDO 1.7D/ 1.9D/ TD/ TDI/ SDI/ V5, SKODA: FABIA, OCTAVIA 1.4TDI/ 1.9 SDI/TDI, TDI, MB: V280, VOLKSWAGEN: BORA, CANDYII, CABRIO, CORRADO, EUROVAN, GOLF , JETTA, NEW BEETLE, PASSAT, POLO, SHARAN – MOTORES/ Engines 1.4/ 1.5D/1.6D/1.8GTI/ 1.9 SDI/TDI / V5/ V6 / 2.8 VR6 / 2.9 VR6. TRANSPORTER 1.2/ 1.5 / 1.6 / 1.9TD / 2.4D, 2.5/ 2.5 SYNCRO / TDI / 2.8 VR6, VENTO 1.9D/ SDI/ TDI/ TDI/ VR6**

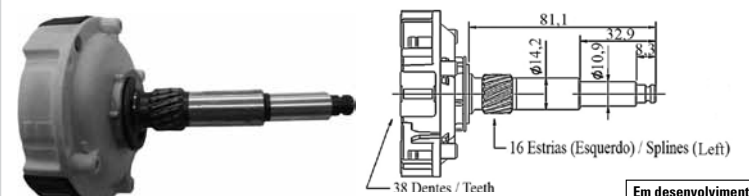

Bosch

UF-11.118

Tipo / Type:

Original: 1 006 200 118 (2.2364.0)

Partida / Starter: 0 001 124 011 / 012, 0 001 125 039 / 040

Aplicação / Application: **SEAT: AROSC 1.7SDI, VOLKSWAGEN: LUPO 1.7 SDI , POLO 1.7/ 1.9D SDI**

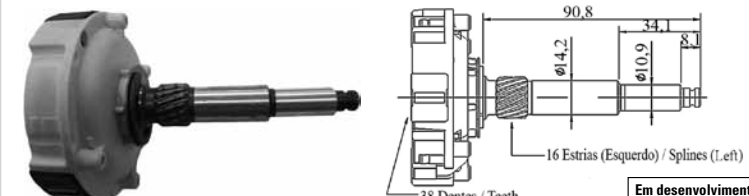

Bosch

UF - 11.122

Tipo / Type:

Original: 1 006 200 122 (2.235.0)

Partida / Starter: 0 001 125 042

Aplicação / Application: **SEAT: ALHAMBRA/ CORDOBA 1.9 TDI (97-01), VOLKSWAGEN: GOLF 1.9 TDI (97-01)**

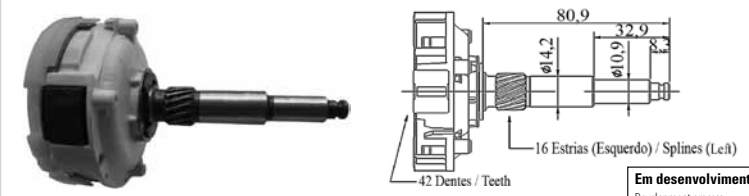

Bosch

UF - 11.123

Tipo / Type: **DW**

Original: 1 006 200 121

Partida / Starter: 0 001 107 056 – 12v 0 001 107 100 / 101 / 108

Aplicação / Application: **ALFA ROMEO, AUDI, CITROEN, LANCIA, OPEL, PEUGEOT, RENAULT, SEAT, VAUXHALL, VOLKSWAGEN.**

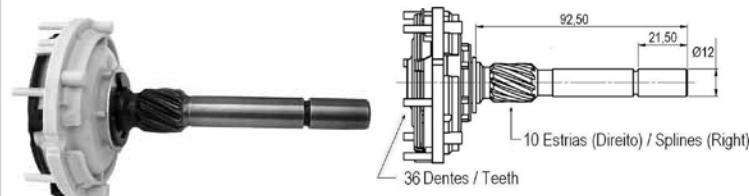

Bosch

UF-11.126

Tipo / Type:

Original: 1 006 200 126 (2.2366.0)

Partida / Starter: 0 001 125 501 / 502

Aplicação / Application: VOLKSWAGEN: LT 2.5 TD (99-), LT 2.5 TD 4X4 (85-01)

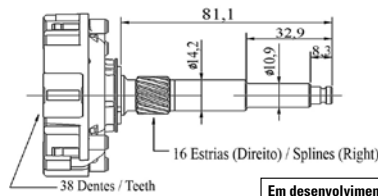

Em desenvolvimento
Development process

Bosch

UF - 11.128

Tipo / Type: DW

Original: 1 006 200 128 (F 000 AL0 128)

Partida / Starter: 0 001 107 007, 0 001 107 020

Aplicação / Application: FIAT: TEMPRA 2.0 i.e. S.W., TIPO 1.8 /2.0 i.e. /16V, VOLKSWAGEN: GOLF 1.8 /II 1.8 E III 1.8, PASSAT (IMPORT) 2.0, AUDI: A3 1.8/ 1.8T, SEAT: ALHAMBRA, CORDOBA, IBIZA

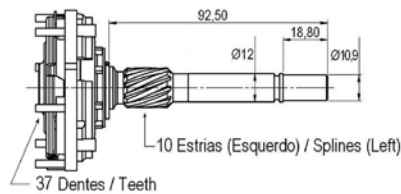

Bosch

UF-11.143

Tipo / Type:

Original: 1 006 200 143 (2.2367.0)

Partida / Starter: 0 001 123 001, 0 001 124 015, 0 001 125 025, 0 986 022 470

Aplicação / Application: PORSCHE: BOXSTER (96-04) 2.5/ 2.7/ 3.2, 911 CARRERA / CARRERA 3.6, 912, 996, 997, GT3, CAYENNE 2002

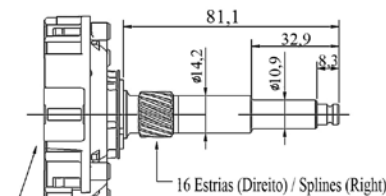

Em desenvolvimento
Development process

Bosch

UF - 11.145

Tipo / Type: DW

Original: 1 006 200 145

Partida / Starter: 0 001 107 037 / 048, 0 001 108 157/169

Aplicação / Application: MERCEDES-BENZ, BMW: 328i (1998)

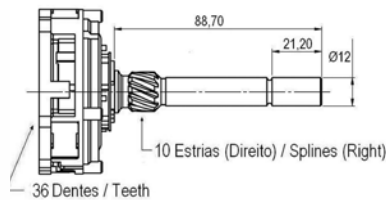

Bosch

UF - 11.153

Tipo / Type: DW

Original: 1 006 200 153

Partida / Starter: 0 001 107 075 – 12v Bosch 183, F 000 AL0 106

Aplicação / Application: TOYOTA: COROLLA 1.8i 16V - 08.1998 → 06.2002

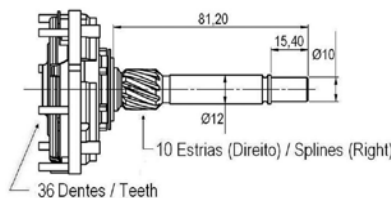

Bosch

UF - 11.161 Tipo / Type: **DW**

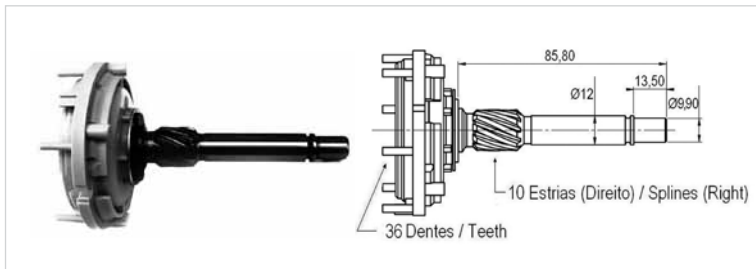

Original: 1 006 200 161

Partida / Starter: 0 001 106 017

Aplicação / Application: **RENAULT: LAGUNA 2.0 I 16V**

Bosch

UF - 11.307 Tipo / Type: **DW**

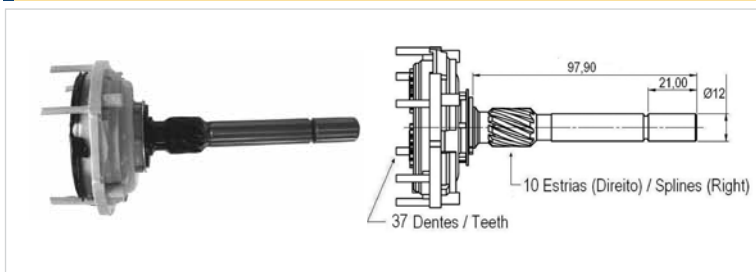

Original: 1 005 821 307

Partida / Starter: 0 001 108 013 /021 /022 /023 /026 /027 /030 /031 /032 /035 /037 /038 /040 /045 /046 /051 /053 /056 /061 /066 /068 /069 /070 /072 /073 /076 /077 /081 /084 /091 /093 /094 /095 /103 /104 /105 /135 /137 /144 /151 /154 /159, 0 001 109 040

Aplicação / Application: **ALFA: 156 BERLINA / SPORT WAGON / ALFA 164 / 166 / SPIDER, AUDI: 100 1.6 / 200 2.2 TURBO, CHRYSLER: GRAND CARAVAN 3.0I LE, FIAT: TEMpra 2.0IE / TIPO 1.8/2.0IE/16V, JEEP: CHEROKEE 2.5U, LAND ROVER: DEFENDER/ DISCOVERY/ RANGE ROVER I/II, VOLKSWAGEN: GOLF 1.8 / II 1.8 / PASSAT (IMP.) 2.0, CHEVROLET-GM: OMEGA 3.0I / 4.1I / SUPREMA 3.0I/4.1I / C20, OPEL: OMEGA 2.4I/2.6I/3.0I / EVOLUT 500/3.6, ALFA ROMEO: ALFA 156 2.5 24V / SW / 164 2.5 / 3.0 TD / IE / V6 12/24V / 166 3.0 / V6 24V / SPIDER 3.0 V6 12V**

Bosch

UF-11.590 Tipo/Type: **EV 12volts - 2,20 Kw**

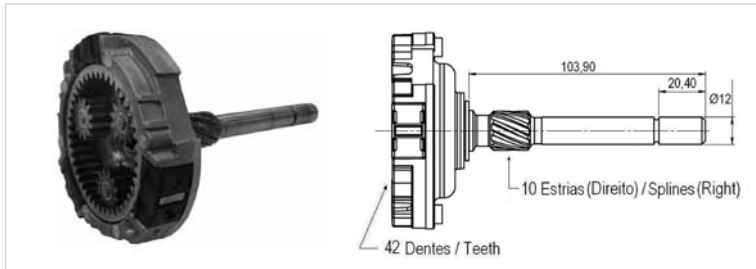

Original: 9 001 337 059

Partida / Starter: 0 001 218 011 / 122 / 159 / 168 / 171 / 174 / 177, 0 001 109 300, 9 000 331 432 / 433

Aplicação / Application: **OPEL: FRONTERA 2.3 TD (MOTOR 23 DTR TURBO), OMEGA 2.3 TD (MOTOR 23DTR) 09.1988>03.1994, (MOTOR 23YDT) 09.1986> 08.1988, FIAT: DUCATO 10 2.5 D (MOTOR 8140.67) 03.1994 > 03.1998 E TD EGR (MOTOR 8140.47) 03.1994> 03.1998, MBB: 310D SPRINTER (MOTOR OM014A) 09.1996> 10.1996> 12.1996, 01.1997>, 312D (MOTOR OM014LA) 08.1999 >, 412D (MOTOR OM014LA) 10.1999 >, LAND ROVER: DEFENDER 2.5 TURBO DIESEL (MOTOR GEMINI TCI DI 23L) 08.1990> 12.2001, (MOTOR MAXION HS4TCC) 08.1998>, DISCOVERY 2.5 TDI (MOTOR 12L / 21L) 09.1989>09.1994, (MOTOR 19L) 10.1993>12.1998, RANGE ROVER I 2.5 TDI CLASSIC (MOTOR**

14L) 10.1992>09.1994, (MOTOR 300 TDI 10.1994>04.1996). RANGE ROVER II 2.5 DT/DSE (MOTOR M51-D25) 09.1994>09.2002, IVECO: DAILY 10 (MOTOR 8140) 11.1997>, DODGE: DAKOTA 2.5D (MOTOR MAGNUM 2.5 L-4) 10.1998>, FORD: F-1000 10.1995>, F-1000 HSD 10.1995>, CHEVROLET-GM: BLAZER 2.5 DIESEL (MOTOR 4A) 08.1997>, RENAULT: JUMPER

Prestolite

UF-12.100 Tipo/Type: **M100R**

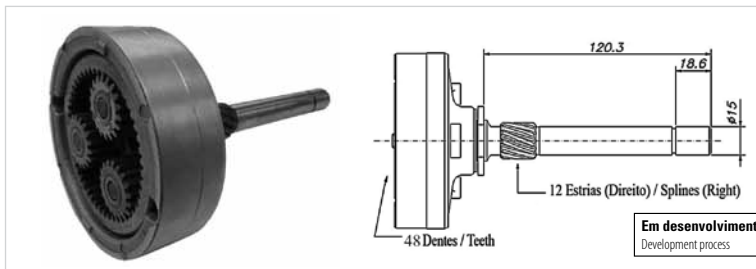

Original: K01497

Partida / Starter: 35259200 /60 /90, 35259340 /60, 35259440 /50 /60, 35259520 /50, 35259730 /70 /80, 35259810 /30 /40, 35260830 /40 /70, 35261000 /50, 35261130 /60 /85, 35261900, 35262010

Aplicação / Application: **AGRALE: MARRUÁ MWM SPRINT 4.07, CATERPILLAR: BLUE BIRD USA CAT 3126 7.2 - BLUE BIRD USA CAT 3126 7.2 (OCP), CUMMINS: CUMMINS ISB02 5.8 - CUMMINS C 8.3 CUMMINS B, JOHN DEERE: 7820 6081H 6 CIL. CEIFEIRA 1550 6081H 6 CIL. 8.12 - TRATOR 6 CIL. FORD: CUMMINS B 5.9, CARGO 2422/ 2425/ 2630 CUMMINS 6CTAA 8.3 - CARGO 2425 MIXER CUMMINS 6CTAA 8.3, FREIGHTLINER: NAVISTAR V8 7.3, GRADALL: TRATOR 4045 JOHN DEERE**

4 CIL. 4.5, INTERNACIONAL ENGINES: CAMINHÃO NAVISTAR DT446 - I6 7.6 - DT444E - V8 7.3 - DT-360 5.9, VALTRA: TRATOR BH140/ BH160/ BH180 SISU 6CIL. - TRATOR BL77 SISU 3CIL. - TRATOR BI88 SISU 4 CIL. - TRATOR BM100/ BM120 SISU 4CIL. - TRATOR LIVIANO 685C /785C MWM 3 CIL. - TRATOR PESADO 1280/ 1580 MWM 6 CIL. - TRATOR PESADO 1780 MWM 6, MBB: O371 6 CIL. - OF215 6 CIL. - ÔNIBUS 1214/ 1414/ 1418/ 1614 CAIXA AUTOMÁTICA, PAUNI: MINIBUS CUMMINS 4BT 3.9, MWM: 4 E 6 CIL. - MWM SERIES X10 E 229 SERIES, VW ÔNIBUS: ÔNIBUS MWM 4 E 6 CIL., VOLVO: LÍNEA VM: VM17 MWM SERIES X10 E 229 SERIES - LÍNEA VM: VM23 MWM SERIES X10 E 229 SERIES

Prestolite

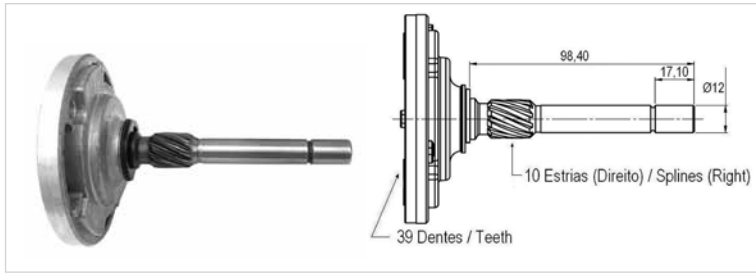

UF - 12.147 Tipo / Type: **M93R**

Original: 352.58.669, (K21147)

Partida / Starter: 352.58.580 / 940 / 950 / 490 / 540 / 660 / 690 / 710 / 820 / 880 / 960, 352.59.040 / 50, 352.60.828

Aplicação / Application: **AGRALE:** ÔNIBUS VOLARE, **CHEVROLET-GM:** BLAZER DLX, PICK-UP S10 C/ MOTOR MAXION HS, PICK-UP D20, SILVERADO C/ MOTOR MWM, **CUMMINS:** MOTORES SÉRIES 6BT (DIANTEIRO) / B6 / BT5.9L, **FORD:** CARGO 1416 / 1722 / 1716, F-1000, F-14000 C/ MWM, F-100, RANGER, **JOHN DEERE:** TRATORES, **MASSEY-FERGUSON:** TRATOR C/ MOTOR 4 CIL., **MAXION:** MOTORES, **MERCEDES-BENZ:** 180D - KOMBI ESPANHOLA, ÔNIBUS, CAMINHÕES, MB 180 D, SPRINTER C/ MOTOR MAXION HS, **PERKINS:** MOTORES 4.203/ 3.152/ 4.236/ 6.354, **PEUGEOT:** 504, 505, VÁRIOS C/ MOTOR INDENOR, **VOLKSWAGEN:** CAMINHÃO 15-160

Prestolite

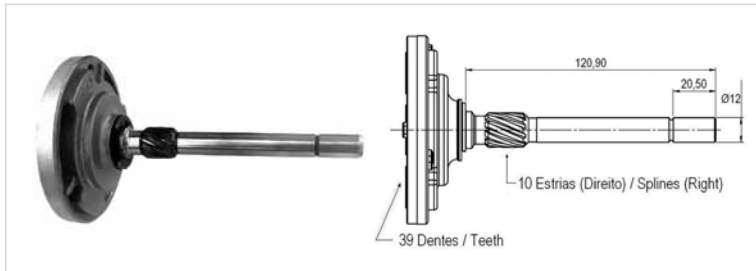

UF - 12.149 Tipo / Type: **M93R**

Original: 352.58.853, (K21149 / KJD08 / KJD09)

Partida / Starter: 352.58.880 / 940 / 950 / 990, 352.59.000 / 130 / 210 / 680 / 620 / 630 / 650 / 670 / 690 / 660

Aplicação / Application: **MERCEDES-BENZ:** ÔNIBUS, **CUMMINS:** MOTORES CUMMINS SÉRIE B, DIMEX: ÔNIBUS, **FORD:** CAMINHÕES, PICK UP F100

Prestolite

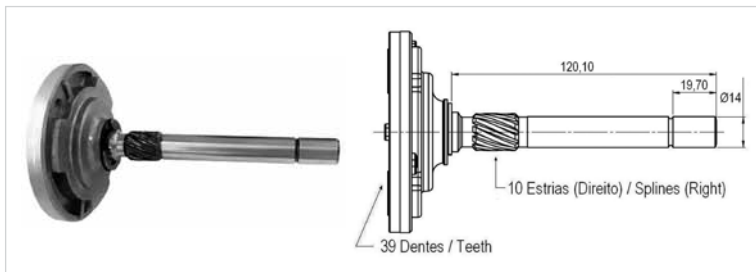

UF - 12.212 Tipo / Type: **M93R**

Original: 352.59.959 (K01212)

Partida / Starter: 352.59.380 / 680

Aplicação / Application: **SHELHURST, MERCEDES-BENZ:** ONIBUS 6CC

Prestolite

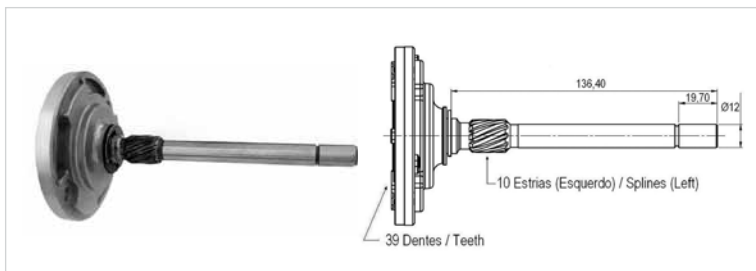

UF - 12.219 Tipo / Type: **M93R**

Original: 352.59.859, (K01219)

Partida / Starter: 352.59.480

Aplicação / Application: **VOLKSWAGEN:** G. IZQ. VW SUDAFRICA

Prestolite

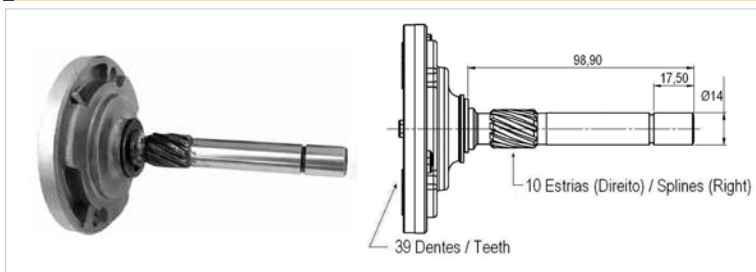

UF - 12.221 Tipo / Type: **M93R**

Original: 352.59.952 (K01221 / K01284)

Partida / Starter: 352.59.310 / 710 / 720, 352.61.020 / 175

Aplicação / Application: **AGCO:** TRATOR 6 CILINDROS **PEUGEOT:** C/ MOTOR INDENOR, **INDENOR:** MOTORES INDENOR 6.305 / 6.354, **FORD:** POWER STROKE

Prestolite

UF - 12.222 Tipo / Type: **M93R**

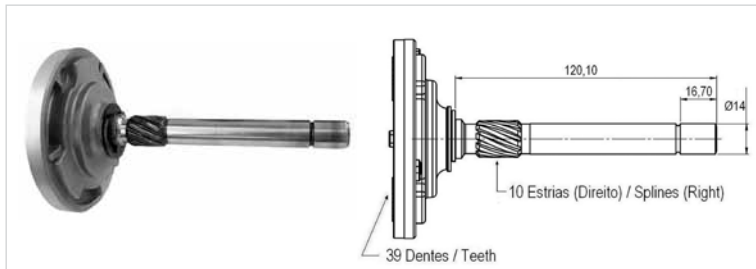

Original: 352.59.465 (K01222 / K01261 / K01349 / K01469 / K21148 / KJD20 / KJD21)
Partida / Starter: 352.59.300 / 430 / 580 / 590 / 600 / 620 / 630 / 650 / 660 / 670 / 690 / 750 / 760 / 880 / 900, 352.60.940 / 950, 352.61.070 / 120 / 155 / 190 / 355 / 360 / 420
Aplicação / Application: **DEUTZ AGCO:** TRATOR, **JOHN DEERE,** CUMMINS: MOTORES / VM MOTOR, **FORD:** F100, **PERKINS:** D-28 MT, **MWM:** 4 E 6 CILINDROS, **FORD:** C/ MOTORES CUMMINS E CUMMINS 4BT, **MAXION:** MOTOR S4, **INTERNACIONAL SOUTH AMERICAN,** **GRADALL, AGRALE:** MOTOR MWM, **INTERNACIONAL BRAZIL, MASSEY-FERGUSON:** TRATOR C/ MOTOR PERKINS

Prestolite

UF - 12.343 Tipo / Type: **M93R**

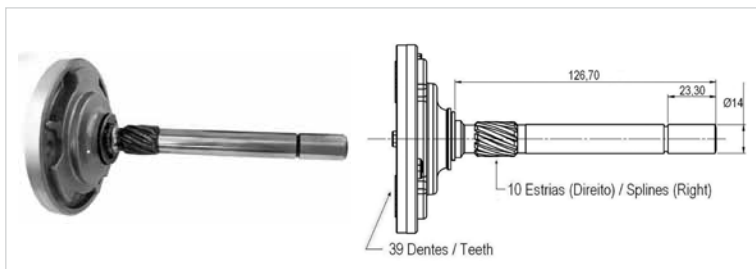

Original: 352.59.915 (K01343)
Partida / Starter: 352.59.640 / 870
Aplicação / Application: **CUMMINS:** MOTORES B / 4BT / 6BT / 6BTAA, **VOLKSVAGEN:** CAMINHÕES C/ MOTORES CUMMINS, **FORD:** CAMINHÕES C/ MOTORES CUMMINS

Ford / Motorcraft

UF - 13.119 Tipo / Type:

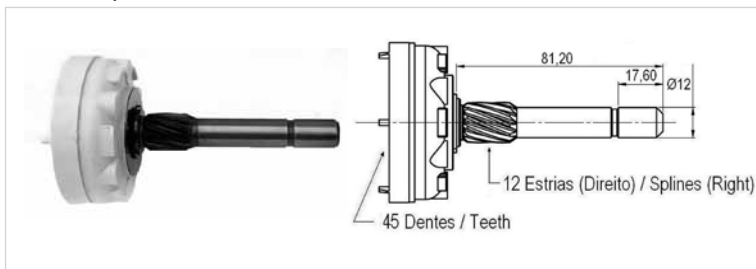

Original:
Partida / Starter: 96BB 11000, AA 7.119 BI
Aplicação / Application: **FORD:** ESCORT, FIESTA, KA

Ford / Motorcraft

UF - 13.120 Tipo / Type:

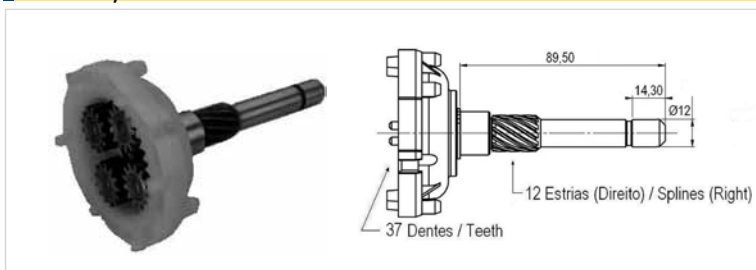

Original:
Partida / Starter: F8TU-11.000 DD 9251-AI
Aplicação / Application: **FORD:** RANGER, ECO-SPORT

Ford / Motorcraft

UF - 13.121 Tipo / Type: (Eixo curto / Short Shaft)

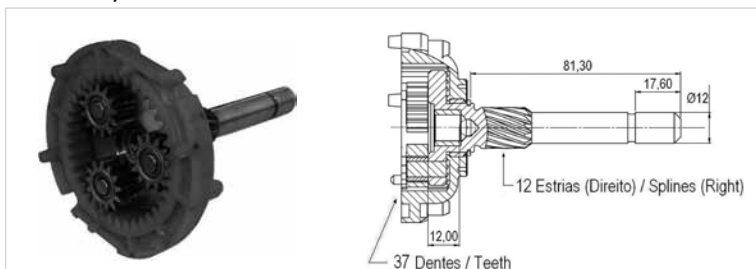

Original:
Partida / Starter: F07UAA716A
Aplicação / Application: **FORD:** RANGER V6 4.0 GAS., EXPLORER V6 4.0

Ford / Motorcraft

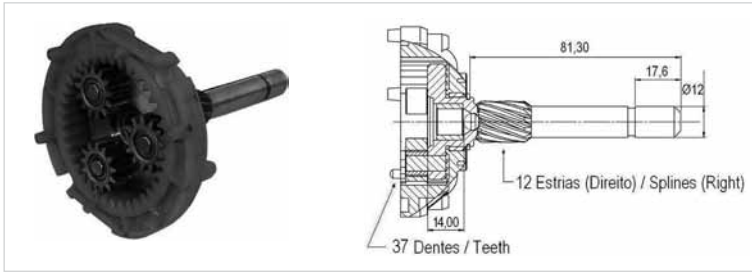

UF - 13.122

Tipo/Type: (Eixo Longo / Long Shaft)

Original:

Partida / Starter: F2TUAAC27A

Aplicação / Application: CHEVROLET-GM: ASTRA, BLAZER, S10, VECTRA - II(SOHC) 1.8/2.0/2.2 - 8V ATÉ 03/2001

Delco

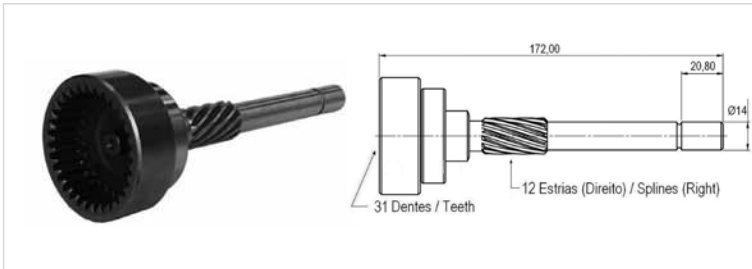

UF-14.032

Tipo/Type: 28MT (Acompanha rolamento / bearing include)

Original: 10457032 (Eixo curto / Short Shaft: 172 mm)

Partida / Starter: 1113276, 113277, 113291, 10479605, 10479623, 10479629, 10479634, 10479643, 10479644, 104796651, 10479652, 10479564, 10479655, 10479645.

Aplicação / Application: AGCO: ARG. DICUMAR 6BT-F700. DYNAPAC. G-DRIVE. INGERSOLL RAND 95, 110, 125. METALFOR PULVERIZADOR. MULLER DTV140, SKIDER, TM-14. ZANELLO. TIMBERJACK 610 FORWARDER, 450C, 480C (MOTOR CUMMINS 4B3.9, 4BT3.9, 6B5.9, 6BTAA) TIMBERJACK: 608, 608 HARVESTER. CIBER VIBRADOR. KOMATSU PC200 ESCAVADEIRA (MO-

TOR CUMMINS 4B3.9, 4BT3.9, 6B5.9, 6BT5.9, 6BTAA) FIAT: ALLIS (MOTOR CUMMINS 6BT5.9 COM EMBREAGEM BANHADAA ÓLEO, GRADER PG140 E PG160 (MOTOR FORD 7.5L GMA, PÁ CARREFADEIRA FR128 E TRATOR DE ESTEIRA 7D, GRADER FG-1402.2.CASE GRADER 845 E 845.2, PÁ CARREGADEIRA W20, FD 170, CREMALHEIRA A BANHO DE ÓLEO FORD: F12000 E F14000 (MOTOR CUMMINS B 5.9 LITROS 160CV), CASE: RETROESCAVADEIRA 580L E 580L SE. CUMMINS: 4B3.9, 4BT3.9, 6B5.9, 6BT5.9, 6BTAA. MBB: 710, 1418R, 1720, 1720K, L 1620, LO 814 (MOTOR OM 364 E OM 366 EM 12V), OF 1721, OH 1420, OH 1621L, OH 1623 (MOTOR OM 364 E OM 366 EM 24V). TRATORES: 5410 (MOTOR 4045D 4 CIL. 4,5L). TRATORES 2140, 2850, 3140, 3350, 3540, 3550 (MOTOR 6359 E 4239D). TRATORES 1420, 2330, 2420, 2530, 2730 (MOTOR 3 E 4 CIL.). TRATORES 5600, 5700 E 6300 (MOTOR 4039D E T 4 CIL. 3,9L). TRATORES 6600 (MOTOR 6059T 6 CIL. 5,9L). TRATORES 627, 727, 3420, 3530, 4420, 4530, (MOTOR 6 CIL.)

Delco

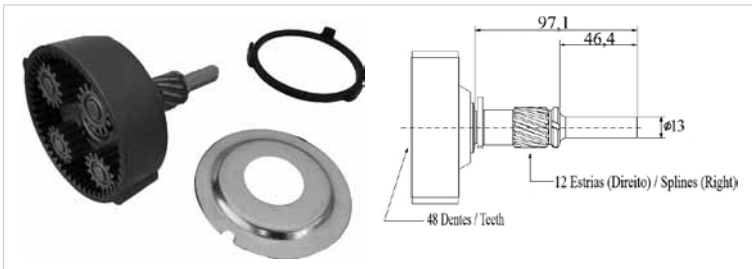

UF - 14.095

Tipo/Type: 38MT

Original: 10512095

Partida / Starter: 8200005, 8200025, 8200053, 8200072, 8200077, 200078, 200356

Aplicação / Application: CUMMINS: MOTORES C E ISC DE 8,3 LITROS, FORD: CARGO 16,22 1630, 2422, 2425, 2622, 2626, 2630, 2631, 3222, 4030, COM MOTOR CUMMINS 6CTAA 8,3 LITROS, CARGO ELETRÔNICO 2632, 2932, 532 E 5032, VOLKSWAGEN: CAMINHÕES 17-220, 17-310, 23-210, 23-220, 23-310, 24-220, 26-220, 26-260, 26-310 - COM MOTOR CUMMINS 6CTAA 8.3 LITROS, CAMINHÕES 31-370, 25-370, 19-370 COMO MOTOR 9,3 LITROS INTERNATIONAL E 18-310, 19-320, 31-320, TITAN TRACTOR E CONSTELLATION COM MOTOR CUMMINS ISC 8,3 LITROS. ÔNIBUS 19320EOT - QUÉOPS EVOLUTION COM MOTOR CUMMINS ISC 8,3 LITROS, CAMINHÕES 18.310 TITAN TRACTOR.

Delco

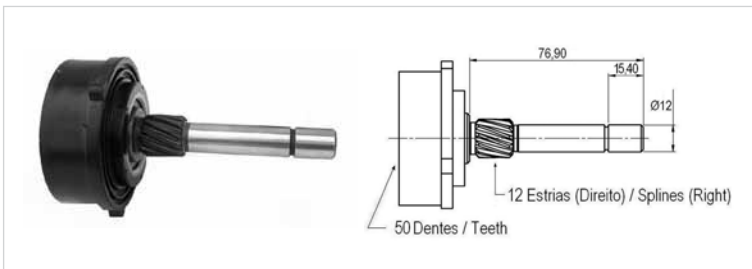

UF - 14.150

Tipo/Type: PG150S

Original:

Partida / Starter: 9000846, 9000794

Aplicação / Application: CHEVROLET-GM: ASTRA, BLAZER, S10, VECTRA - II(SOHC) 1.8/2.0/2.2 - 8V ATÉ 03/2001

Delco

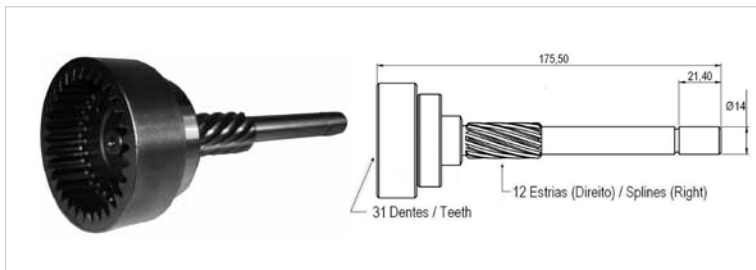

UF-14.357

Tipo/Type: **28MT (Acompanha rolamento / bearing include)**

Original: 10457357 (Eixo Longo / Long Shaft: 175,5mm)

Partida / Starter: 10479650 (24v)

Aplicação / Application: **MBB:** 712C, 715, 914C, 915C, 1215, 1218EL, 1218L, 1418EL, 1418L, 1718, 1725, 2423, 2428, LO 914, O 500M, O 500U, OF 1417 COM MOTORES OM 904 E OM 906 ELETRÔNICOS EM 24V.

Delco

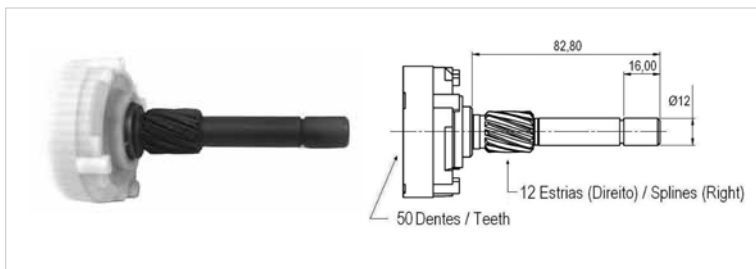

UF - 14.368

Tipo/Type: **PG260B,C,D**

Original: 10504495

Partida / Starter: 9000890, 9000891, 9000893 /944 /948 /978 /981, 8000006 /090 /158 /159 /188, 93374341 / 342

Aplicação / Application: **CHEVROLET-GM:** ASTRA, BLAZER, S10; VECTRA - II(SOHC) 1.8/2.0/2.2 8V APÓS 03/2001, - II(DOHC) 2.0/2.2 16V

Delco

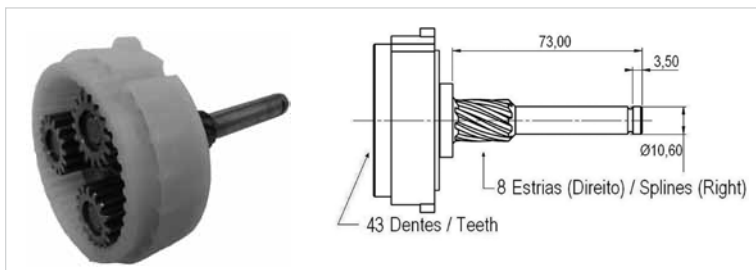

UF-14.711

Tipo/Type: **PG260D**

Original:

Partida / Starter: 10455711

Aplicação / Application: **CHEVROLET-GM:** OMEGA GLS 95>98, OMEGA CD 6CC 4.1 MPFI, SUPREMA CD 6CC 4.1 MPFI

Delco

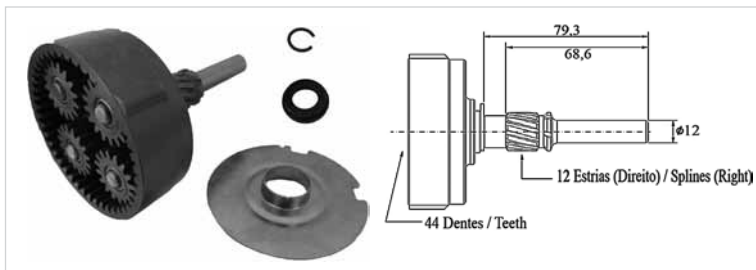

UF - 14.811

Tipo / Type: **29MT**

Original: 10515811, 10515810, 10518783

Partida / Starter: 8200003, 8200004, 8200054, 8200064, 8200138, 8200196, 8200231, 8200292, 8200295, 8200296, 8200297, 8200326, 8200331, 8200357, 8200386, 8200474, 8200478, 8200495, 8200511, 8200512

Aplicação / Application: **CNH, FORD, MERCEDES-BENZ, VOLVO, VOLKSWAGEN**

Obs: Planetária 29MT conjunto antigo: Relação 6/12 [6 estrias impulsor (BZM 9999)/12 estrias planetária]. Existe a Planetária 29MT conjunto moderno (Em desenvolvimento): Relação 7/14 [7 estrias impulsor (ZEN 1679)/14 estrias planetária]. **Notes:** Planetary Gear for 29MT old model: Gear ratio 6/12 (6 splines Drive (BZM 9999)/ 12 splines Planetary Gear) There are a Planetary Gear for 29MT new model (Developing): Gear ratio 7/14 (7 splines Drive (ZEN 1679)/ 14 splines Planetary Gear).

Delco

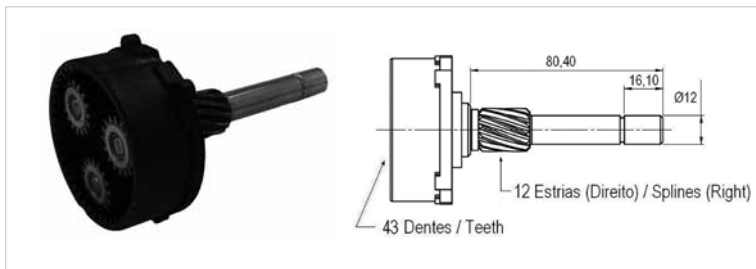

UF - 14.890

Tipo/Type: **PG260G**

Original: 10492410

Partida / Starter: 8000014, 9000973, 9 000 871

Aplicação / Application: **CHEVROLET-GM:** BLAZER E S-10 C/ MOTOR VORTEC V6 4.3

Delco

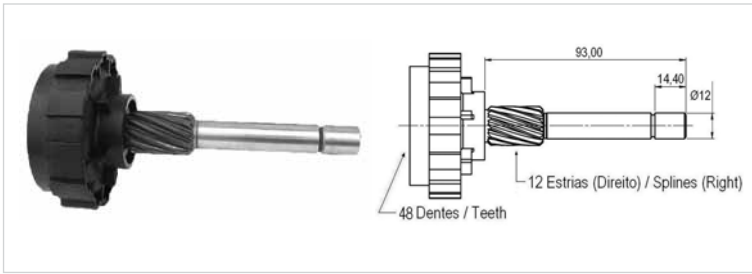

UF - 14.910 Tipo/Type: PG260M / PMGR

Original: 10475626

Partida / Starter: 9 000 786 / 798 / 804 / 805 / 806 / 812 / 819 / 820 / 821 / 827 / 834 / 835 / 844 / 850 / 851 / 853 / 860 / 861 / 862 / 863 / 864 / 866 / 867 / 899 / 900 / 910, 10476598

Aplicação / Application: CHEVROLET-GM, CLARK

Mitsubishi

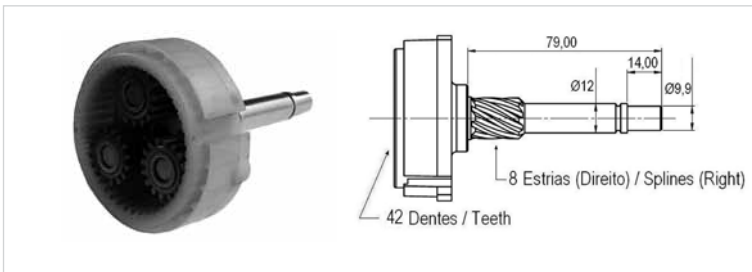

UF - 15.100 Tipo / Type:

Original: MOTO081/ 80381/ 80881/ 80981/ 81081

Partida / Starter: M000T92581

Aplicação / Application: CHEVROLET-GM: S-10, ISUZU: C-240 DIESEL ENGINES, MAZDA: EMPILHADEIRA / FORKLIFT, FP13-18-X56 – MXS MIATA, PROTEGE, MPV, MITSUBISHI: EMPILHADEIRA / FORKLIFT, NISSAN, VOLARE: MICRO ÔNIBUS, YALE: EMPILHADEIRA / FORKLIFT

Mitsubishi

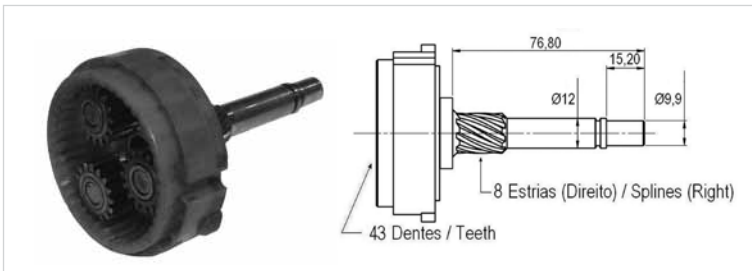

UF-15.101 Tipo/Type:

Original:

Partida / Starter: M001T79781 12V

Aplicação / Application: CLARK: EMPILHADEIRA / FORKLIFT, HYUNDAI: SONATA, MITSUBISHI: EMPILHADEIRA / FORKLIFT, PAJERO V6 GAS, VOLARE: ELETRÔNICO

Mitsubishi

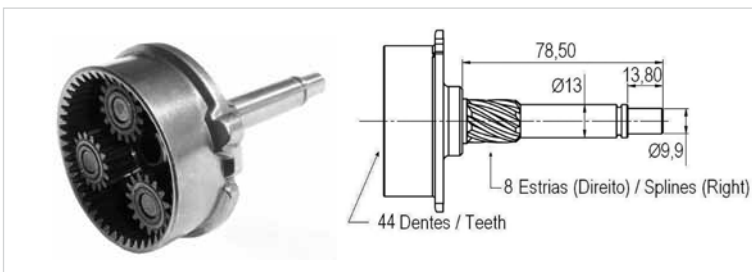

UF - 15.103 Tipo/Type:

Original: MOTO081/ 80381/ 80881/ 80981/ 81081

Partida / Starter: M 002 T87 771/ 171 ZT

Aplicação / Application: CHEVROLET-GM: S-10 C/ MOTOR MWM 4 CC 2.8 SPRINT, MITSUBISHI: L200 SPORT HPE, L300, TROLLER: T4 2.8 TD MWM 4 CC SPRINT (2001->), VOLARE

Mitsubishi

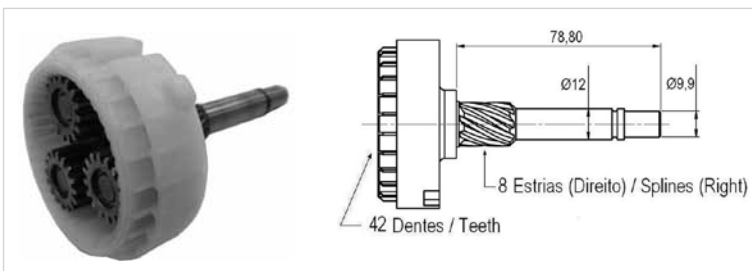

UF-15.104 Tipo/Type:

Original:

Partida / Starter:

Aplicação / Application: HYSTER: EMPILHADEIRA / FORKLIFT, RENAULT

Valeo

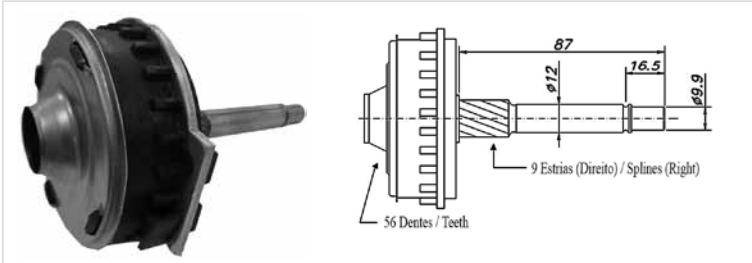

UF-16.101

12V, Tipo/Type: **DSL36100** - 2,2 Kw

Original: _____

Partida / Starter: **DSL36100, TM00A31201, TM00A36101**

Aplicação / Application: **HYUNDAI: HR, ACCENT 1.5 CRDI, KIA: BONGO, CEE'D 1.5, SORENTO 2.5 TURBO DIESEL, K2700, MERCEDES-BENZ: SPRINTER**

Valeo

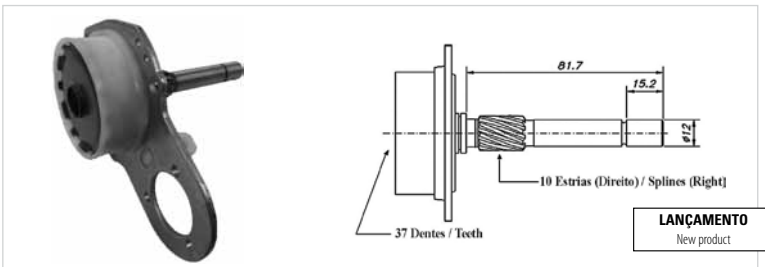

UF-16.102

Original: _____

Partida / Starter: **D6RA85, D6RA185**

Aplicação / Application: **CHEVROLET-GM, RENAULT, PEUGEOT, CITROEN, SATURN**

Valeo

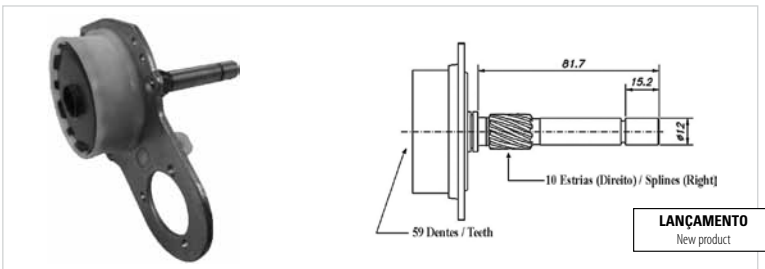

UF-16.103

Original: _____

Partida / Starter: **D6RA65, D6RA165**

Aplicação / Application: **CHEVROLET-GM, RENAULT, PEUGEOT, CITROEN, SATURN**

Valeo

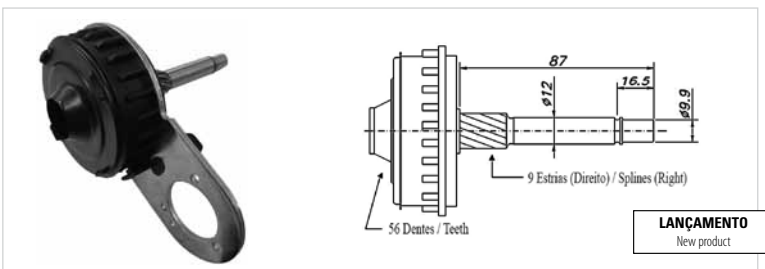

UF-16.104

12V, Tipo/Type: **DSL36100** - 2,2 Kw

Original: _____

Partida / Starter: **D7R11, D7R12, D7R13, D7R15, D7R151, D7R16, D7R18, D7R19, D7R20, D7R24, D7R25, D7R26, D7R27, D7R28, D7R33, D7R34, D7R35, D7R53**

Aplicação / Application: **AUDI: A3 (97-00) MOTORES CODIGO/ ENGINE CODE – ASV, CITROEN: X-SARA, 14 1.4/ 1.5/ 4X4, SAXO 1.5 (96-03), ZX 1.4/ 1.5/ 1.9 TD, C.A.91-97, 2CV 602 (70-90), AX, AMI, ACADIANE, DYANE, MEHARI, SAXO, BERLINGO 1.8D / 1.9D / 2.0 HDI, FIAT: SCUDO TD, JPX: JIPE MONTEZ, PEUGEOT: 106 1.4 D (92-96)/ 1.5 D (94-05), 206 MOTEUR 1.9D DW8, 405 DIESEL, PARTNER, VOLVO: 400TD, 440 TD, 460 TD, ROVER: AGRUPA 1.4 D (92-95), 114D (92-94), 115D (94-97), TATRA, LANCIA: PHEDRA 2.0 / 2.2 JTD (02), Z 2.0 JTD (99-00), SUZUKI: GRAND VITARA 1.9L D (05), SAMURAI 1.9L TD (98), OPEL: VIVARO 1.9L (01), NISSAN: MICRA 1.5 D, K11 (98-02), PRIMERA 1.9L (03), MERCEDES-BENZ: SPRINTER, 190D 2.2L D / 2.5L D (84-89), 300D, CD, SD, SDL, TD 2.5L D, TD 3.0L D, 3.5L D (86-93), 350SD, SDL 3.5LD (91), E CLASS 3.0L D (95-99), S CLASS 3.5L D (94-95), SEAT, SKODA: OCTAVIA A4 (01-11) MOTORES CODIGO/ ENGINE CODES: AQM, AGR, ALH, AHF, ASV, VOLKSWAGEN: BEETLE (99-01), BORA (02-05), GOLF MK4 (98-06), TODOS COM MOTORES CÓDIGO / ALL WITH ENGINE CODES: ASV, AQM, AGR, ALH, AHF, ASV, RENAULT: CLIO EXPRESS, MEGANE EXPRESS, R19 D, R21 D, AVANTIME 2.2 DCI 150CV, ESCAPE III 2.2, LAGUNA/ LAGUNA GRANDTOUR 2.2 DT 113CV, LAGUNA/ LAGUNA GRANDTOUR II 2.2 DCI 140 / 150CV, SAFRANE II 2.2, VELSATIS 2.2, TRAFIC II 2.5, MASTER 2.2 / 2.5 CDI (2010 ->), HYUNDAI: HR**

Bosch

R - 0055

Original: 1 006 200 145



Motor de Partida / Starter: 0 001 107 037/048, 0 001 108 157 / 169

Aplicação / Application: MERCEDES - BENZ, BMW, **APLICAÇÃO / Application:** UF-11.058, UF-11.145

Bosch

R - 0056

Original: 1 006 200 110/123/128,



37 dentes / teeth

F 000 AL1 015/017/019

Motor de Partida / Starter: 0 001 107 007 / 009 / 015 / 020, 0 001 108 026 / 048 / 136 / 146 / 154 / 159, 0 001 109 040, 9 000 081 001 / 005 / 006 / 007 / 008, F 000 AL0 100, F 005 M00 012 / 014

Aplicação / Application: Para motores partida Bosch - DW
APLICAÇÃO / Application: UF-11.010 / 11.015 / 11.018 / 11.019 / 11.037 / 11.128

Bosch

R - 0057

Original: 1 005 821 307



37 dentes / teeth

Motor de Partida / Starter: 0 001 107 003, 0 001 108 013/ 021/ 022/ 023/ 026/ 027/ 030/ 031/ 032/ 035/ 037/ 038/ 040 /045 /046 /051 /052 /053 /056 /061 /066/ 068/ 069 /070/ 072/ 073/ 076/ 077/ 081/ 084/ 091/ 092/ 093/ 094/ 095/ 103/ 104/ 105/ 135/ 137/ 144/ 151/ 154/ 159, 0 001 109 040

Aplicação / Application: ALFA / AUDI / CHRYSLER / FIAT / JEEP / ROVER / VOLKSWAGEM * UF-11.307

Bosch

R - 0058

Original: 1 006 200 161



36 dentes / teeth

Motor de Partida / Starter: 0 001 106 012 / 017 / 022 / 023, 0 001 107 056 / 100 / 101 / 108

Aplicação / Application: ALFA ROMEO, AUDI, CITROEN, LANCIA, OPEL, PEUGEOT, RENAULT, SEAT, VAUSHALL, VOLKSWAGEN

APLICAÇÃO / Application: UF-11.161, UF-11.123, UF-11.153

Bosch

R - 0060

Original: 2 337 1F4 029



36 dentes / teeth

Motor de Partida / Starter: 9 008 046 015

Aplicação / Application: NISSAN

APLICAÇÃO / Application: UF-11.029

Bosch

R - 0061

Original: 1 006 200 059



(1 006 200 098)

Motor de Partida / Starter: 0 001 107 403, 0 001 108 123 / 124 / 134 / 160 / 995

Aplicação / Application: MERCEDES-BENZ, CHRYSLER
APLICAÇÃO / Application: UF-11.059

Bosch

R - 0080

Original: 1 006 200



37 dentes / teeth

110/123/128, F 000 AL1 015/017/019

Motor de Partida / Starter: 0 001 107 007 / 009 / 015 / 020, 0 001 108 026 / 048 / 136 / 146 / 154 / 159, 0 001 109 040, 9 000 081 001 / 005 / 006 / 007 / 008, F 000 AL0 100, F 005 M00 012 / 014

Aplicação / Application: Para motores partida Bosch - DW
APLICAÇÃO / Application: UF-11.010 / 11.015 / 11.018 / 11.019 / 11.037 / 11.128

Bosch

R - 0062

Original: 1 006 200 104



Motor de Partida / Starter: 0 001 107 048, 0 001 108 064 / 080 / 088 / 101 / 102 / 113 / 121 / 143

Aplicação / Application: MERCEDES-BENZ, BMW, CHEVROLET-GM, OPEL, VOLVO, AUDI, FIAT, FORD, RENAULT

APLICAÇÃO / Application: UF-11.104

Bosch

R - 0083

Original: 1 006 200 161



36 dentes / teeth

Motor de Partida / Starter: 0 001 106 012 / 017 / 022 / 023, 0 001 107 056 / 100 / 101 / 108

Aplicação / Application: ALFA ROMEO, AUDI, CITROEN, LANCIA, OPEL, PEUGEOT, RENAULT, SEAT, VAUSHALL, VOLKSWAGEN

APLICAÇÃO / Application: UF-11.161, UF-11.123, UF-11.153

Bosch

R - 0085

Original: 2 337 1F4 029



36 dentes / teeth

Motor de Partida / Starter: 9 008 046 015

Aplicação / Application: NISSAN

APLICAÇÃO / Application: UF-11.029

Bosch

R - 0086

Original: 1 006 200 059

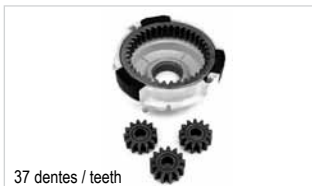

37 dentes / teeth

(1 006 200 098)

Motor de Partida / Starter: 0 001 107 403, 0 001 108 123 / 124 / 134 / 160 / 995, 0 001 109 306

Aplicação / Application: MERCEDES-BENZ: C 180/ T-Modell/200/220/230, CLK 230 K.P. E 230, ML 230 SLK 230 K.R., 124-200E, CHRYSLER: DODGE DAKOTA 2.5 D, GRAND CARAVAN 2.5, VOYAGER 2.5/3.3 / 3.6

APLICAÇÃO / Application: UF-11.059

Bosch

R - 0087

Original: 1 006 200 104



37 dentes / teeth

Motor de Partida / Starter: 0 001 107 048, 0 001 108 064 / 080 / 088 / 101 / 102 / 113 / 121 / 143

Aplicação / Application: MERCEDES-BENZ, BMW, CHEVROLET-GM, OPEL, VOLVO, AUDI, FIAT, FORD, RENAULT

APLICAÇÃO / Application: UF-11.104

Bosch

R - 0090

Original: 1 006 200 145



36 dentes / teeth

Motor de Partida / Starter: 0 001 107 037 / 048, 0 001 108 157 / 169

Aplicação / Application: MERCEDES-BENZ, BMW

APLICAÇÃO / Application: UF-11.145

Bosch

R - 0094

Original:



37 dentes / teeth

Motor de Partida / Starter: 0 001 107 045

Aplicação / Application: OPEL: CALIBRA 2.0i 16V - 09/93 > 08/96, ASTRA 2.0i, 01/95 > 02/98, CHEVROLET-GM: ASTRA, ASTRA SEDAN 2.0i 16V - 02/99 > 07/01, VECTRA 2.0 16V 04/96 > 11/97, ZAFIRA 2.0 SFI 16V 04/01 > . **APLICAÇÃO / Application:** UF-11.058

Delco

R - 0063

Original: 9 000 981



50 dentes / teeth

Motor de Partida / Starter: 9000846, 9000794, 9000981

Aplicação / Application: CHEVROLET-GM: ASTRA, BLAZER, S10, VECTRA - II (SOHC) 1.8 / 2.0 / 2.2 - 8V ATÉ 03 / 2001

APLICAÇÃO / Application: UF-14.150

Delco

R - 0064

Original:



50 dentes / teeth

Motor de Partida / Starter: 9000890, 9000891, 9000893, (PG260D)

Aplicação / Application: CHEVROLET-GM: ASTRA; BLAZER; S10; VECTRA - II (SOHC) 1.8 / 2.0 / 2.2 8V APÓS 03/2001, VECTRA - II (DOHC) 2.0 / 2.2 16V

APLICAÇÃO / Application: UF-14.368

Delco

R - 0065

Original: 10476598



48 dentes / teeth

Motor de Partida / Starter: 9 000 786 / 798 / 804 / 805 / 806 / 812 / 819 / 820 / 821 / 822 / 827 / 834 / 835 / 844 / 850 / 851 / 853 / 860 / 861 / 862 / 863 / 864 / 866 / 867 / 899 / 900, 10476598

Aplicação / Application: CHEVROLET-GM: BLAZER / S10 4.3 V6, CLARK: EMPILHADEIRA / FORKLIFT C / CGP25

APLICAÇÃO / Application: UF-14.910

Delco

R - 0071

Original: 10450720



43 dentes / teeth

Motor de Partida / Starter:

Aplicação / Application: CHEVROLET-GM: BLAZER, S-10 c/ MOTOR VORTEC V6 4.3

REPARO DA PLANETÁRIA UF-14.890

Delco

R - 0088

Original: 9 000 981



50 dentes / teeth

Motor de Partida / Starter: 9000846, 9000794

Aplicação / Application: CHEVROLET-GM: ASTRA, BLAZER, S10, VECTRA - Todos c/ motor II (SOHC) 1.8 / 2.0 / 2.2 8V até 03/2001

APLICAÇÃO / Application: UF-14.150

Delco

R - 0089

Original:



50 dentes / teeth

Motor de Partida / Starter: 9000890, 9000891, 9000893, (PG260D)

Aplicação / Application: CHEVROLET-GM: ASTRA; BLAZER; S10; VECTRA - II (SOHC) 1.8 / 2.0 / 2.2 8V, APÓS 03/2001; VECTRA - II (DOHC) 2.0 / 2.2 16V

APLICAÇÃO / Application: UF-14.368

Delco

R - 0091

Original: 10476598



48 dentes / teeth

Motor de Partida / Starter: 9 000 786 / 798 / 804 / 805 / 806 / 812 / 819 / 820 / 827 / 834 / 835 / 844 / 850 / 851 / 853 / 860 / 861 / 862 / 863 / 864 / 866 / 867 / 899 / 900 / 910

Aplicação / Application: CHEVROLET-GM: BLAZER/ S10 4.3 V6, CLARK: EMPILHADEIRA / FORKLIFT C/ CGP25. **APLICAÇÃO / Application:** UF-14.910

Delco

R - 0097

Original: 10450720



43 dentes / teeth

Motor de Partida / Starter: 8000034, 9000973

Aplicação / Application: CHEVROLET-GM: BLAZER/ S-10 c/ MOTOR VORTEC V6 4.3
REPARO DA PLANETÁRIA UF-14.890

Ford / Motorcraft

R - 0059

Original:



45 dentes / teeth

Motor de Partida / Starter: 96BB 11000-AA 7.119 BI

Aplicação / Application: FORD: ESCORT, FIESTA, KA, MONDEO

APLICAÇÃO / Application: UF-13.119

Ford / Motorcraft

R - 0067

Original:



37 dentes / teeth

Motor de Partida / Starter: F8TU-11.000 DD 9251-AI

Aplicação / Application: FORD: RANGER, ECOES-PORT, BRONCO

APLICAÇÃO / Application: UF-13.120/ 13.121/ 13.122

Ford / Motorcraft

R - 0084

Original:



45 dentes / teeth

Motor de Partida / Starter: 96BB 11000-AA 7.119 BI

Aplicação / Application: FORD: ESCORT, FIESTA, KA

APLICAÇÃO / Application: UF-13.119

Ford / Motorcraft

R - 0092

Original: c/ 4 engrenagens

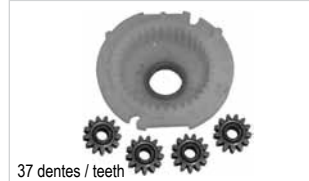

37 dentes / teeth

Motor de Partida / Starter: F8TU-11.000 DD 9251-AI

Aplicação / Application: FORD: RANGER, ECOES-PORT.

APLICAÇÃO / Application: UF-13.120

Ford / Motorcraft

R - 0093

Original: c/ 3 engrenagens

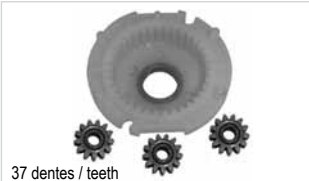

37 dentes / teeth

Motor de Partida / Starter: F07UAA716A, F2TUAA7C27A

Aplicação / Application: FORD: RANGER 4.0 GAS., EXPLORER 4.0, F-1000 (GAS.), F-4000 4.9 L.

APLICAÇÃO / Application: UF-13.121/ 13.122

Mitsubishi / Delco

R - 0066

Original:



43 dentes / teeth

Motor de Partida / Starter: CGP 25

Aplicação / Application: CHEVROLET-GM: OMEGA/ SUPREMA GLS 95-98, CD 6CC 4.1 MPFI, CLARK: EMPILHADEIRAS/ FORKLIFT, HYUNDAI: SONATA, MITSUBISHI: EMPILHADEIRAS/ FORKLIFT, PAJERO V6 GAS.

APLICAÇÃO / Application: UF-15.101, UF-14.711

Mitsubishi

R - 0070

Original: M135X01571



42 dentes / teeth

Motor de Partida / Starter: MOTO081 / 80381 / 80881 / 80981 / 81091

Aplicação / Application: MAZDA: FP13-18-X56 - MXS MIATA, PROTEGE, MPV, CHEVROLET-GM: S-10, VOLARE: MICRO ÔNIBUS, NISSAN

APLICAÇÃO / Application: UF-15.100

Mitsubishi

R - 0072

Original:



43 dentes / teeth

Motor de Partida / Starter: MANDO, MITSUBISHI PMGR

Aplicação / Application: (1985 - 2000) AMC, CHEVROLET-GM, CHRYSLER, DODGE, EAGLE, FORD, GEO, HYUNDAI, INFINITI, JEEP, MAZDA, MERCURY, MITSUBISHI, NISSAN, PLYMOUTH, SUBARU, SUZUKI, CATERPILLAR, CLARK

Mitsubishi

R - 0073

Original: _____



42 dentes / teeth

Motor de Partida / Starter: _____
Aplicação / Application: HYSTER:EMPILHADEIRA/
 FORKLIFT, RENAULT
APLICAÇÃO / Application: UF-15.104

Mitsubishi

R - 0096

Original: M135X01571



42 dentes / teeth

Motor de Partida / Starter: MOTO081 / 80381 / 80881 /
 80981 / 81091
Aplicação / Application: MAZDA: FP13-18-X56 – MXS
 MIATA, PROTEGE, MPV, CHEVROLET-GM: S-10 , VO-
 LARE: MICRO ÔNIBUS, NISSAN
APLICAÇÃO / Application: UF-15.100

Mitsubishi

R - 0098

Original: _____

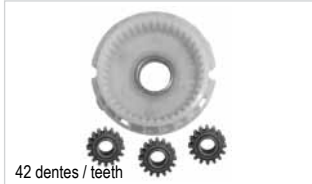

42 dentes / teeth

Motor de Partida / Starter: _____
Aplicação / Application: HYSTER:EMPILHADEIRA/
 FORKLIFT, RENAULT
APLICAÇÃO / Application: UF-15.104

Mitsubishi

R - 0099

Original: _____



43 dentes / teeth

Motor de Partida / Starter: Mando, Mitsubishi PMGR
Aplicação / Application: (1985 – 2000) AMC, CHE-
 VROLET-GM, CHRYSLER, DODGE, EAGLE, FORD,
 GEO, HYUNDAI, INFINITI, JEEP, MAZDA, MERCURY,
 MITSUBISHI, NISSAN, PLYMOUTH, SUBARU, SU-
 ZUKI, CATERPILLAR, CLARK

Mitsubishi / Delco

R - 0100

Original: _____

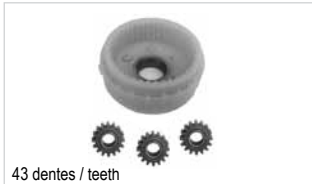

43 dentes / teeth

Motor de Partida / Starter: CGP 25
Aplicação / Application: CHEVROLET-GM: OME-
 GA/SUPREMA GLS 95-98/ CD 6CC 4.1 MPFI,
 CLARK: EMPILHADEIRA/ FORKLIFT, MITSUBISHI:
 EMPILHADEIRA/ FORKLIFT, PAJERO V6 GAS.
APLICAÇÃO / APPLICATION: UF-15.101, UF-14.711

Mitsubishi

R - 0101

Original: _____



44 dentes / teeth

Motor de Partida / Starter: M 002 T87 771/ 171 ZT
Aplicação / Application: CHEVROLET-GM: S-10 C/
 MOTOR MWM 2.8 SPRINT, MITSUBISHI: L200 SPORT
 HPE, TROLLER: T4 2.8 TD MWM 4 CC SPRINT (2001->)
APLICAÇÃO / Application: UF-15.103

Mitsubishi

R - 0102

Original: _____



44 dentes / teeth

Motor de Partida / Starter: M 002 T87 771/ 171 ZT
Aplicação / Application: CHEVROLET-GM: S-10 C/
 MOTOR MWM 2.8 SPRINT, MITSUBISHI: L200 SPORT
 HPE, TROLLER: T4 2.8 TD MWM 4 CC SPRINT (2001->)
APLICAÇÃO / Application: UF-15.103

Mitsubishi

R - 0103

Original: _____



Motor de Partida / Starter: M001T79781 12V, M 002 T87
 771/ 171 ZT
Aplicação / Application: CLARK, MITSUBISHI,
 CHEVROLET-GM, HYSTER, RENAULT
APLICAÇÃO / Application: UF-15.101, UF-15.103, UF-
 15.104 REPARO AMORTECEDOR

Valeo

R - 0068

Original: _____



37 dentes / teeth

Motor de Partida / Starter: D6RA85.185 – 37 Dentes.
Aplicação / Application: CHEVROLET-GM, RE-
 NAULT, PEUGEOT, CITROEN
APLICAÇÃO / Application: UF-16.102

Valeo

R - 0069

Original: _____



59 dentes / teeth

Motor de Partida / Starter: D6RA65.165 – 59 Dentes.
Aplicação / Application: CHEVROLET-GM, RENAULT,
 PEUGEOT, CITROEN
APLICAÇÃO / Application: UF-16.103

Prestolite

R - 0082

Original: 1 126 600 975



39 dentes / teeth

Motor de Partida / Starter: 352.58.580 / 940 / 950 / 490 /
 540 / 660 / 690 / 710 / 820 / 880 / 960 / 040
Aplicação / Application: AGRALE: ÔNIBUS VOLARE,
 CHEVROLET-GM: BLAZER DLX, PICK-UP S10 C/ MOTOR
 MAXION HS, PICK-UP D20, SILVERADO C/ MOTOR MWM,
 CUMMINS: MOTORES SÉRIES 6BT (DIANTEIRO) / B6 /

Prestolite

R - 0095

Original: _____



Motor de Partida / Starter: _____
Aplicação / Application: 352.58.580/ 940/ 950/ 490/ 540/
 660/ 690/ 710/ 820/ 880/ 940/ 950/ 960/ 990, 352.59.000/
 040/ 130/ 210/ 380/ 465/ 480/ 620/ 630/ 650/ 660/ 670/
 680/ 690/ 915/ 952.
APLICAÇÃO / Application:
 UF-12.147/ 149/ 212/ 219/ 221/ 222/ 343

BT5.9L, FORD: CARGO 1416 / 1722 / 1716, F-14000 C/ MWM, F-1000, RANGER, JOHN DEERE: TRATO-
 RES, MASSEY-FERGUSON: TRATOR C/ MOTOR 4 CIL, MAXION: MOTORES, MERCEDES-BENZ: 180D
 - KOMBI ESPANHOLA, ÔNIBUS, CAMINHÕES, MB 180 D, ÔNIBUS, SPRINTER C/ MOTOR MAXION HS,
 PERKINS: MOTORES 4.203 / 3.152 / 4.236 / 6.354, PEUGEOT: 504, 505, VÁRIOS C/ MOTOR INDENOR,
 VOLKSWAGEN: CAMINHÃO 15-160.

APLICAÇÃO / Application: UF- 12.147/ 12.149/ 12.212/ 12.219/ 12.221/ 12.222/ 12.343

Prestolite

R - 0104

Original: K01189 / K01256



Motor de Partida / Starter: 35259200 /40 /60 /90, 35259340 /60, 35259440 /50 /60, 35259500 /20 /50, 35259730 /70 /80, 35259810 /20 /30 /40, 35260830 /40 /70, 35260900 /10, 35261000 /50, 35261130 /35 /60 /85, 35261345 /85 /95, 35261445, 35261680 /90, 35261740 /70 /80, 35261900, 35262010 /20, 35262130 /90

Aplicação / Application: **AGRALE:** MARRUÁ MWM SPRINT 4.07, **CATERPILLAR:** BLUE BIRD USA CAT 3126 7.2 /7.2 (OCP), **CUMMINS:** ISB02 5.8C 8.3B/ELET., 5.9 C, 6CT 8.3C, 6CTA 8.3C, **CNH (CASE, NEW HOLLAND):** LÍNEA TM EXITUS: TM135, TM150, TM150, TM165, TM180, TS100, TS110, TS120, GENESIS POWERSTAR, **DEUTZ:** ÔNIBUS DEUTZ 1013 L6, **DIMEX:** CAMINHÃO CUMMINS C, **DON ROQUE:** COLHEITADEIRA / **COMBINE** RV125, RV150H CUMMINS C8.3/ELECT, **JOHN DEERE:** 7820 6081H 6 CIL. COLHEITADEIRA / **COMBINE** 1550, 6081H 6 CIL. 8.12, TRATOR 6 CIL. - 5410 4045D 4 CIL.4.5 - 5600 4039D 4 CIL. 3.9 - 5700 4039T 4 CIL. 3.9 - 6300 4039T 4 CIL. 3.9 - 6600 6059T 6 CIL. 5.9 - 5320N, 3029T 3 CIL. 2.9 - 5520N 4045T 4 CIL. 4.5, BULLDOZER 570/ 570 A 6 CIL. - TRATOR 627/ 727 6 CIL. - TRATOR 1420/ 2330/ 2420/ 2530/ 2730 TODOS 3 E 4 CIL. - TRATOR 2850 6.359/ 3140 6.359/ 3350 6.359/ 3540 6.359/ 3550 6.359 4.239 D. - TRATOR 3420/ 3530/ 4420/4530/ 6005/ 7505 TODOS 6 CIL., **FORD:** CUMMINS B 5.9, CARGO 2422 /2425 /2630 CUMMINS 6CTAA 8.3, CARGO 2425 MIXER CUMMINS 6CTAA 8.3, CAMINHÃO F650 CAT3126 7.2 (OCP), **FREIGHTLINER:** NAVISTAR V8 7.3, **GRANDALL:** TRATOR 4045 JOHN DEERE 4CIL. 4.5, **INTERNACIONAL ENGINES:** CAMINHÃO NAVISTAR DT446 - 16 7.6, DT444E, V8 7.3, DT-360 5.9, 6.0, NGV - V8 6.0, **VALTRA:** TRATOR BH140 /BH160 /BH180 SISU 6CIL., TRATOR BL77 SISU 3CIL., TRATOR BL88 /BM100 /BM110 /BM120 SISU 4CIL., TRATOR LIVIANO 685C /785C MWM 3CIL, TRATOR PESADO 1280 /1580 /1780 MWM 6CIL., **MBB:** O371 6CIL., OF215 6CIL., ÔNIBUS 1214 /1414 /1418 /1614 CAIXA AUTOMÁTICA, **PAUNI:** MINIBUS CUMMINS 4BT 3.9, **MWN:** 4 E 6CIL., MWM SERIES X10 E 229 SERIES, **VM ÔNIBUS:** MWM 4 E 6CIL., MINIBUS CUMMINS 6B ELETRÔNICO 5.9, **VW CAMINHÕES:** CAMINHÃO PESADO 17.220 /26.220 /26.260 CUMMINS 6CTAA 8.3, CAMINHÃO 23.220 CUMMINS, 6CTAA 8, TITAN 17.310 /18.310 /23.310 /26.310 TODOS CUMMINS 6CTAA 8.3, **VOLVO:** LÍNEA VM: VM17 /VM23 MWM SERIES X10 E 229 SERIES, **ZANELLO:**TRATOR 160 /180, PTRAC CUMMINS B 5.9

APLICAÇÃO / Application: UF - 12.100

Prestolite

R - 0105

Original: _____



Motor de Partida / Starter: 35259200 /40 /60 /90, 35259340 /60, 35259440 /50 /60, 35259500 /20 /50, 35259730 /70 /80, 35259810 /20 /30 /40, 35260830 /40 /70, 35260900 /10, 35261000 /50, 35261130 /35 /60 /85, 35261345 /85 /95, 35261445, 35261680 /90, 35261740 /70 /80, 35261900, 35262010 /20, 35262130 /90

Aplicação / Application: **AGRALE:** MARRUÁ MWM SPRINT 4.07, **CATERPILLAR:** BLUE BIRD USA CAT 3126 7.2 /7.2 (OCP), **CUMMINS:** ISB02 5.8C 8.3B/ELET., 5.9 C, 6CT 8.3C, 6CTA 8.3C, **CNH (CASE, NEW HOLLAND):** LÍNEA TM EXITUS: TM135, TM150, TM150, TM165, TM180, TS100, TS110, TS120, GENESIS POWERSTAR, **DEUTZ:** ÔNIBUS DEUTZ 1013 L6, **DIMEX:** CAMINHÃO CUMMINS C, **DON ROQUE:** COLHEITADEIRA / **COMBINE** RV125, RV150H CUMMINS C8.3/ELECT, **JOHN DEERE:** 7820 6081H 6 CIL. COLHEITADEIRA / **COMBINE** 1550, 6081H 6 CIL. 8.12, TRATOR 6 CIL. - 5410 4045D 4 CIL.4.5 - 5600 4039D 4 CIL. 3.9 - 5700 4039T 4 CIL. 3.9 - 6300 4039T 4 CIL. 3.9 - 6600 6059T 6 CIL. 5.9 - 5320N, 3029T 3 CIL. 2.9 - 5520N 4045T 4 CIL. 4.5, BULLDOZER 570/ 570 A 6 CIL. - TRATOR 627/ 727 6 CIL. - TRATOR 1420/ 2330/ 2420/ 2530/ 2730 TODOS 3 E 4 CIL. - TRATOR 2850 6.359/ 3140 6.359/ 3350 6.359/ 3540 6.359/ 3550 6.359 4.239 D. - TRATOR 3420/ 3530/ 4420/4530/ 6005/ 7505 TODOS 6 CIL., **FORD:** CUMMINS B 5.9, CARGO 2422 /2425 /2630 CUMMINS 6CTAA 8.3, CARGO 2425 MIXER CUMMINS 6CTAA 8.3, CAMINHÃO F650 CAT3126 7.2 (OCP), **FREIGHTLINER:** NAVISTAR V8 7.3, **GRANDALL:** TRATOR 4045 JOHN DEERE 4CIL. 4.5, **INTERNACIONAL ENGINES:** CAMINHÃO NAVISTAR DT446 - 16 7.6, DT444E, V8 7.3, DT-360 5.9, 6.0, NGV - V8 6.0, **VALTRA:** TRATOR BH140 /BH160 /BH180 SISU 6CIL., TRATOR BL77 SISU 3CIL., TRATOR BL88 /BM100 /BM110 /BM120 SISU 4CIL., TRATOR LIVIANO 685C /785C MWM 3CIL, TRATOR PESADO 1280 /1580 /1780 MWM 6CIL., **MBB:** O371 6CIL., OF215 6CIL., ÔNIBUS 1214 /1414 /1418 /1614 CAIXA AUTOMÁTICA, **PAUNI:** MINIBUS CUMMINS 4BT 3.9, **MWN:** 4 E 6CIL., MWM SERIES X10 E 229 SERIES, **VM ÔNIBUS:** MWM 4 E 6CIL., MINIBUS CUMMINS 6B ELETRÔNICO 5.9, **VW CAMINHÕES:** CAMINHÃO PESADO 17.220 /26.220 /26.260 CUMMINS 6CTAA 8.3, CAMINHÃO 23.220 CUMMINS, 6CTAA 8, TITAN 17.310 /18.310 /23.310 /26.310 TODOS CUMMINS 6CTAA 8.3, **VOLVO:** LÍNEA VM: VM17 /VM23 MWM SERIES X10 E 229 SERIES, **ZANELLO:**TRATOR 160 /180, PTRAC CUMMINS B 5.9

APLICAÇÃO / Application: UF - 12.100



www.unifap.com.br

Bosch

UF - 7.701

Especificações / Features: **Comprimento / Length: 323 mm**



Original: 2 003 050 056
Partida / Starter: KB, 0 001 410 016 / 019 / 021 / 041 / 046 / 050
Aplicação / Application: CASE, CATERPILLAR, FIAT-ALLIS: CAMINHÕES, IVECO: CAMINHÕES, KOMATSU, MERCEDES-BENZ, SCANIA, VOLSWAGEN: CAMINHÕES, VOLVO

Bosch / Delco

UF - 7.702

Especificações / Features: **Comprimento / Length: 289.5 mm**



Em desenvolvimento
Development process

Original: BOSCH: 2 003 050 076, DELCO: 19024393
Partida / Starter: 19024013, 19024038, 19024135
Aplicação / Application: VOLVO, MERCEDES: CAMINHÃO E ÔNIBUS 24V

Bosch / Delco

UF - 7.703

Especificações / Features: **Comprimento / Length: 324.5 mm**



Em desenvolvimento
Development process

Original: BOSCH: 2 003 050 075, DELCO: 19024392
Partida / Starter: 19024079
Aplicação / Application: SCANIA: CAMINHÃO E ÔNIBUS 24V

Bosch

UF - 7.704

Especificações / Features: **Comprimento / Length: 308,5 mm**



Em desenvolvimento
Development process

Original: BOSCH: 2 003 050 040
Partida / Starter: 0 001 417 001 / 002 / 012 / 013 / 022
Aplicação / Application: MERCEDES - BENZ

Mancal Intermediário KB | Drive Shaft Frame KB

Bosch

UF - 8.801

Especificações / Features:



Original: 2 005 825 077
Partida / Starter: KB
Aplicação / Application: CASE, CATERPILLAR, FIAT-ALLIS: CAMINHÕES, IVECO: CAMINHÕES, KOMATSU, MERCEDES-BENZ, SCANIA, VOLSWAGEN: CAMINHÕES, VOLVO

Capa Mancal do Coletor KB | Starter Cover KB

Bosch

UF - 8.802

Especificações / Features: **Tipo/ Type: KB**



Original: 2 000 580 121

Partida / Starter: KB TODAS / ALL

Aplicação / Application: CASE, CATERPILLAR, FIAT-ALLIS, IVECO, KOMATSU, MERCEDES-BENZ, SCANIA, VOLVO, VOLKSWAGEN

Mancal do Coletor EF | Brackets C.E. EF

Bosch

UF-8.803

Especificações / Features: **Tipo/ Type: EF, 12volts - 0,70 Kw e 0,80 Kw**



Original: 2 005 852 008

Partida / Starter: 0 001 211 209 / 210 / 218 / 219, 9 000 082 021 / 025 / 028 / 030 / 045 / 051 / 082

Aplicação / Application: AGRALE-DEUTZ: 4100, M70/80/85/90/93ID, TX1100, CHEVROLET-GM: CHEVETTE, HATCH, CHEVY 500, MARAJÓ, FIAT: PREMIO/RALLY/SPAZIO, DUNA 60/70/WEEKEND, UNO 1.1/MILLE/ELX/EP, 147 FIORINO 1.5, ELBA 1.5, PRÊMIO 1.5, UNO 1.5/1.6, 147/147 CITY/EUROPA/FIORINO/GLS/OGGI/PANORAMA/PICK-UP/ ELBA 1.5, PRÊMIO 1.5, TEMPRA 2.0 MPI/SPI 16V/ 8V, TEMPRA 2.0 TURBO, TIPO 1.6 i.e., UNO 1.6 MPI, FORD: BELLINA 1.8, DEL REY 1.8; PAMPA 1.8, ROYALE 1.8 / 2.0, VERSAILLES 1.8 / 2.0, GURGEL: BR 800, TOCANTINS L, TR, VOLKSWAGEN: SEDAN, SUPERMINI, KARMANN GHIA 1600, SP, 600/1700; VARIANT II 1600, BRASÍLIA 1.3/1.6, FUSCA 1300/1500/1600, 302, 307, 309, GOL 1.8, KOMBI 1.6, GOL 1.0, GOL II 1.0i, II / III / 1.6, SAVEIRO 1.6, VOYAGE 1.6, 1.6, SAVEIRO 1.6, VOYAGE 1.5/1.6, QUANTUM 2.0i, SANTANA 2.0i, YANMAR: BT22 / 23MICROTRATORES CT 11 / TC 11 SUPER, LADA: NIVA 1.5 / 1.6, MOTORES TIETE: 950 / 950 L

Buchas do Alternador | Bushing for Alternators

Bosch

UF - 5.506

Especificações / Features: **PARA ROLAMENTO / BEARING N° 6201**



Original: 1 120 591 060

Alternador / Alternator:

Aplicação / Application: CASE, IVECO, VOLVO, SCANIA, MERCEDES-BENZ, FORD, CARGO

Bosch

UF - 5.507

Especificações / Features: **PARA ROLAMENTO / BEARING N° 6201**



Original: 1 120 591 082

Alternador / Alternator:

Aplicação / Application: CHEVROLET-GM, VALMET, FORD, VOLKSWAGEN

Bosch

UF - 5.508

Especificações / Features: **PARA ROLAMENTO / BEARING N° 6203**



Original: 1 120 591 103

Alternador / Alternator:

Aplicação / Application: CHEVROLET-GM, VOLKSWAGEN

LP-0001

Conjunto Completo / Complete Part

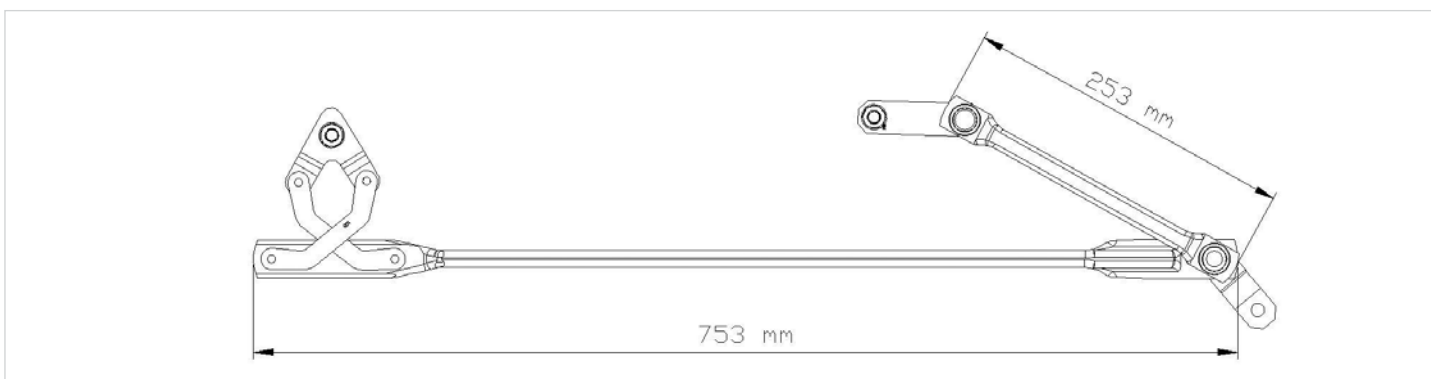

Aplicação / Application: **MBB:** (CARA CHATA) 1938S, 1944S (1998->) , ATEGO E AXOR (<-2006)
 LP-0001-01 TAMBÉM APLICA / ALSO APPLIES IN **VOLVO:** NH (1999->)

LP-0001: Reparos | Repairs

LP-0001-01 Barra Longa / Long Arm



LP-0001-02 Barra Curta / Short Arm



LP-0001-03 Pivô / Pivot



LP-0001-04 Manivela / Crank Arm



LP-0002

Conjunto Completo / Complete Part

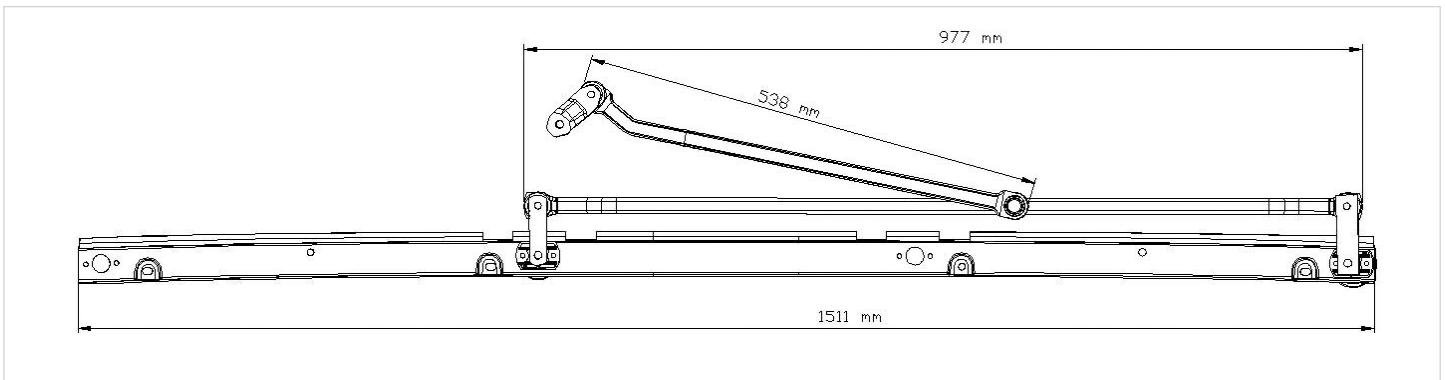

Aplicação / Application: MBB: LS 1938, 1942 (LADO ESQUERDO DO MOTOR) / LEFT SIDE MOTOR

LP-0002 : Reparos | Repairs

LP-0002-01 Barra Longa / Long Arm



LP-0022-02 Barra Curta / Short Arm



LP-0002-03 Pivô Longo / Long Pivot

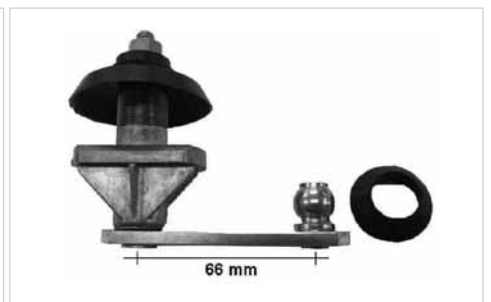

LP-0002-04 Pivô Curto / Short Pivot



LP-0022-05 Manivela / Crank Arm



LP-0002-06 Suporte do Conjunto / Bracket Set

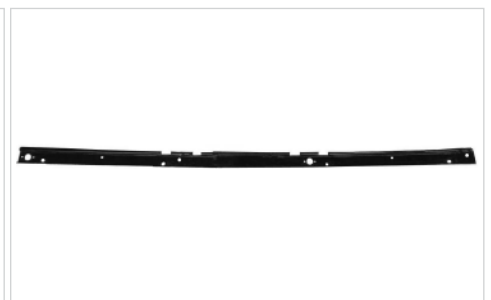

LP-0003

Conjunto Completo / Complete Part

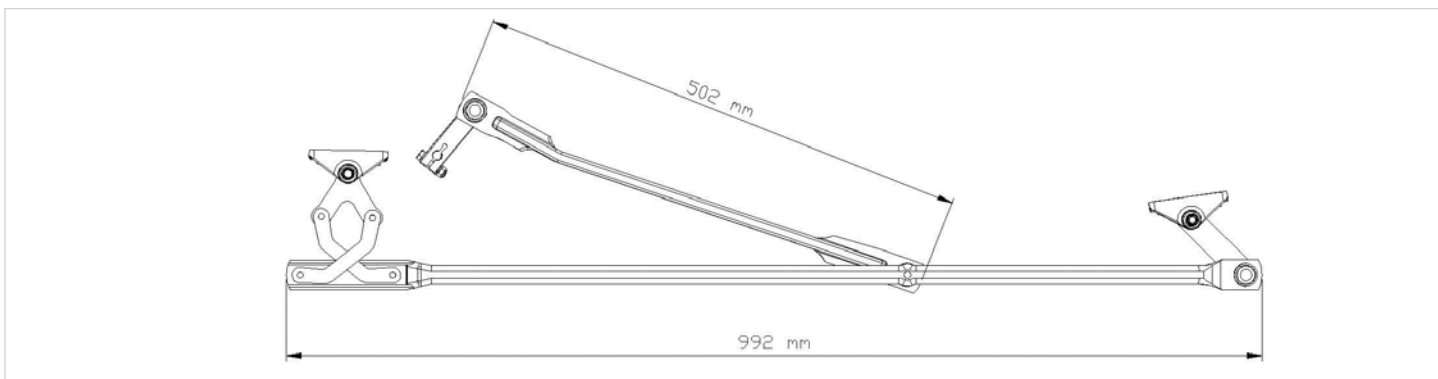

Aplicação / Application: SCANIA: T113, T143 (1993->), R113, R143 (1991->)

LP-0003 : Reparos | Repairs

LP-0003-01

Barra Longa / Long Arm



LP-0003-02

Barra Curta / Short Arm



LP-0003-03

Pivô / Pivot



LP-0003-04

Manivela / Crank Arm



LP-0004

Conjunto Completo / Complete Part

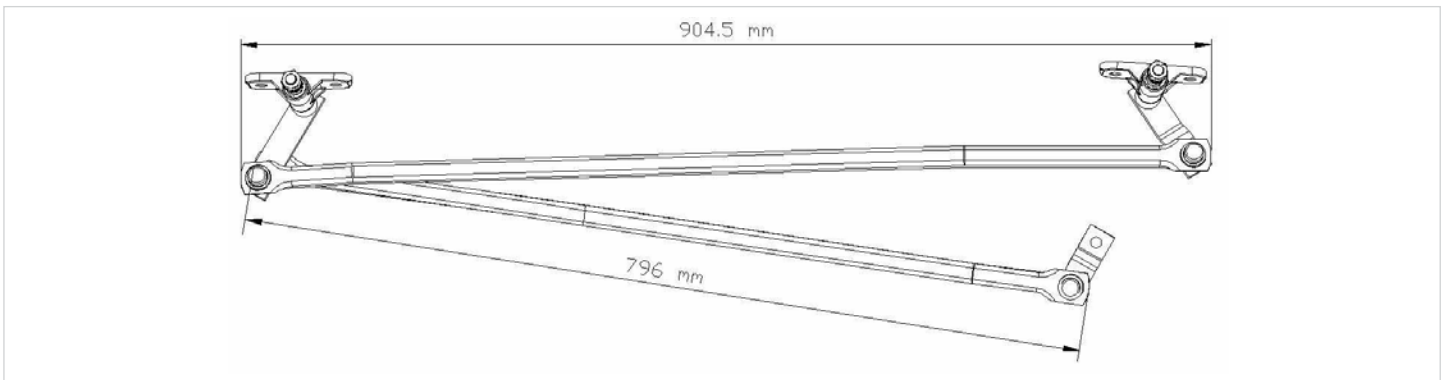

Aplicação / Application: SCANIA: SÉRIE 4 (1998->)

LP-0004: Reparos | Repairs

LP-0004-01

Barra Longa / Long Arm



LP-0004-02

Barra Curta / Short Arm

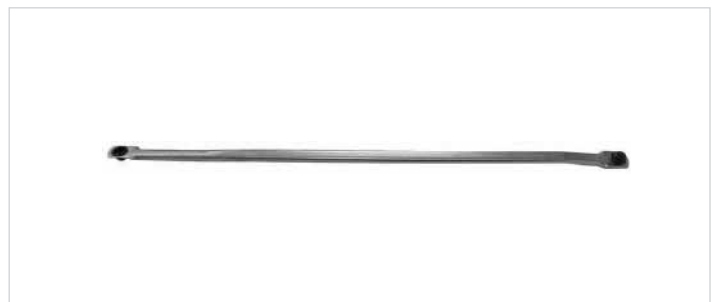

LP-0004-03 Pivô Longo / Long Pivot

LP-0004-04 Pivô Curto / Short Pivot

LP-0004-05 Manivela / Crank Arm



LP-0005

Conjunto Completo / Complete Part

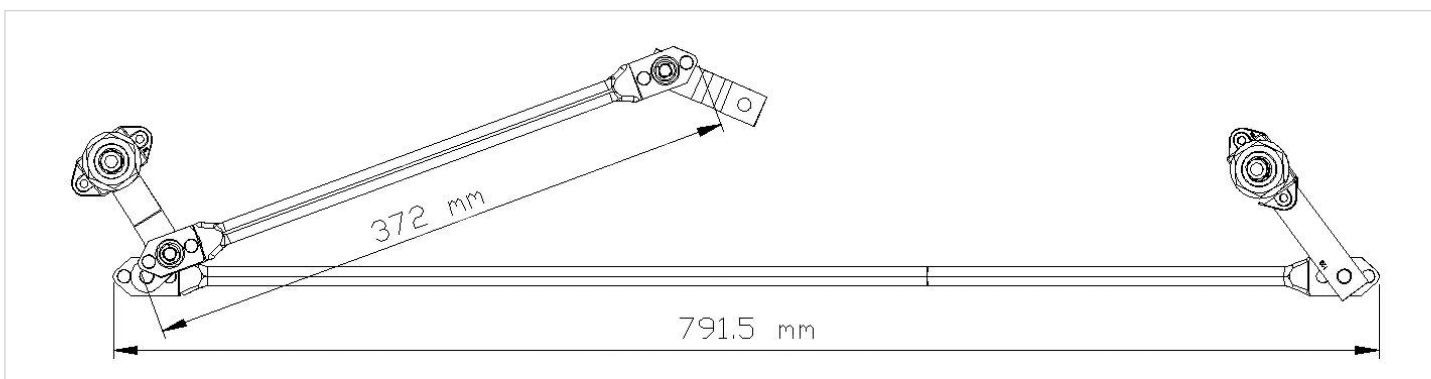

Aplicação / Application: **FORD: CARGO (TODOS) / (ALL)**

LP-0005: Reparos | Repairs

LP-0005-01

Barra Longa / Long Arm



LP-0005-02

Barra Curta / Short Arm



LP-0005-03 Pivô Longo / Long Pivot

LP-0005-04 Pivô Curto / Short Pivot

LP-0005-05 Manivela / Crank Arm



LP-0006

Conjunto Completo / Complete Part

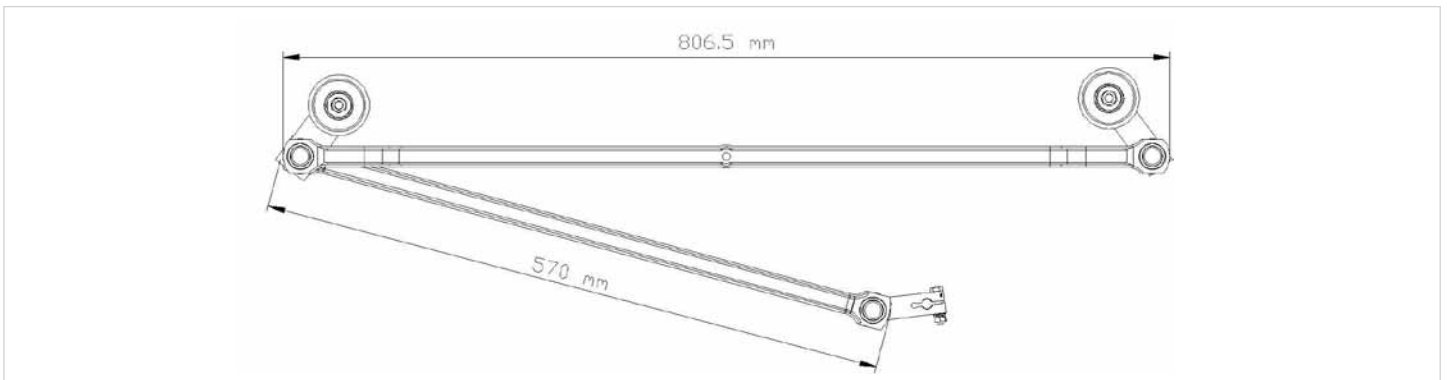

Aplicação / Application: MBB: 709, 710, 711, 712, 914, 1114, 1620, CARA CHATA, SÉRIE L (1988 ->)
(LADO DIREITO DO MOTOR / RIGHT SIDE MOTOR)

LP-0006: Reparos | Repairs

LP-0006-01

Barra Longa / Long Arm



LP-0006-02

Barra Curta / Short Arm



LP-0006-03 **Pivô Longo / Long Pivot**

LP-0006-04 **Pivô Curto / Short Pivot**

LP-0006-05 **Manivela / Crank Arm**



LP-0007

Conjunto Completo / Complete Part

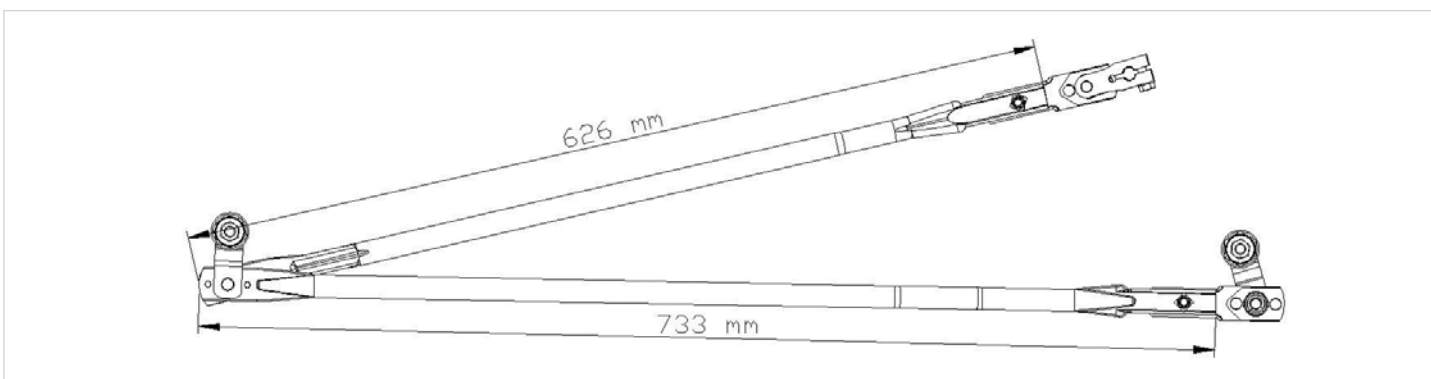

Aplicação / Application: **MBB: L-608, L-708 (<-1988)**

LP-0007: Reparos | Repairs

LP-0007-01

Barra Longa / Long Arm



LP-0007-02

Barra Curta / Short Arm



LP-0007-03 Pivô Direito / Right Pivot

LP-0007-04 Pivô Esquerdo / Left Pivot

LP-0007-05 Manivela / Crank Arm



LP-0008

Conjunto Completo / Complete Part

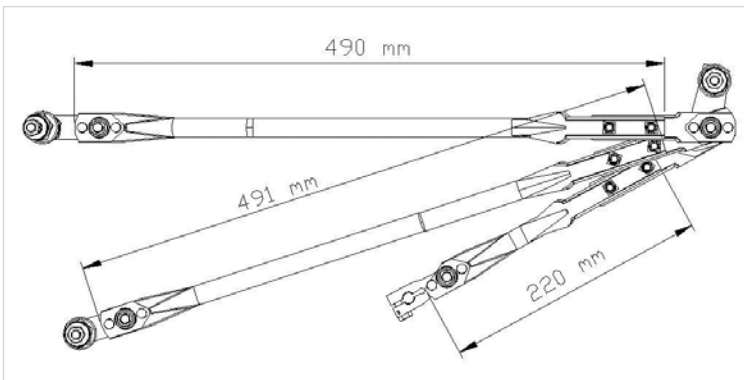

LP-0008: Reparos | Repairs

LP-0008-01

Barra Longa / Long Arm



Aplicação / Application: **MBB: 3 LIMPADORES / WIPERS (1975 a 1988)**

LP-0008-02 Barra Média / Medium Arm

LP-0008-03 Barra Curta / Short Arm

LP-0008-04 Pivô Esquerdo / Left Pivot



LP-0008-05 Pivô Central / Center Pivot

LP-0008-06 Pivô Direito / Right Pivot

LP-0008-07 Manivela / Crank Arm



LP-0009

Conjunto Completo / Complete Part

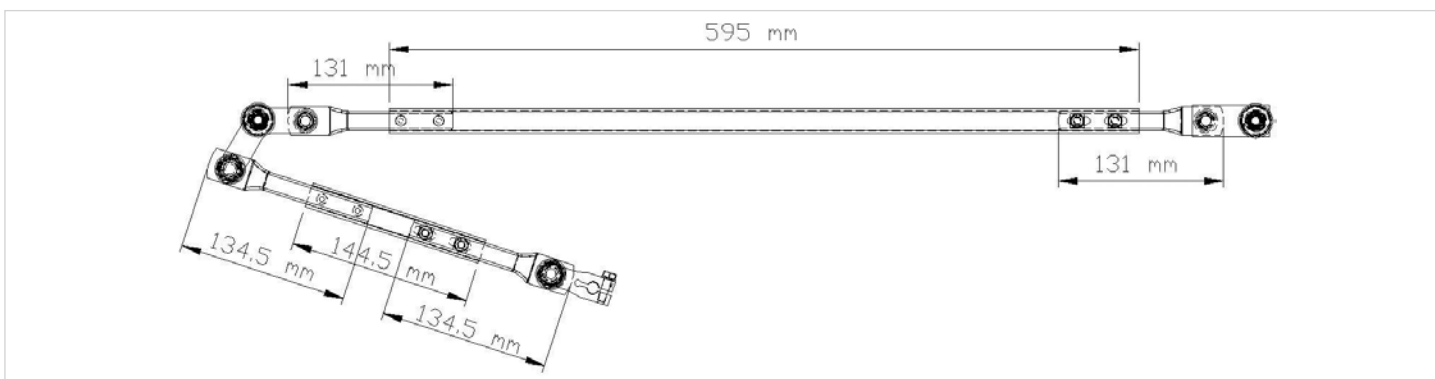

Aplicação / Application: VOLVO: N10, 12, NL10, 12 (1981->)

LP-0009: Reparos | Repairs

LP-0009-01

Barra Longa / Long Arm



LP-0009-02

Barra Curta / Short Arm



LP-0009-03 Terminal "V" / "V" Link

LP-0009-04 Terminal / Link

LP-0009-05 Manivela / Crank Arm



LP-0010

Conjunto Completo / Complete Part

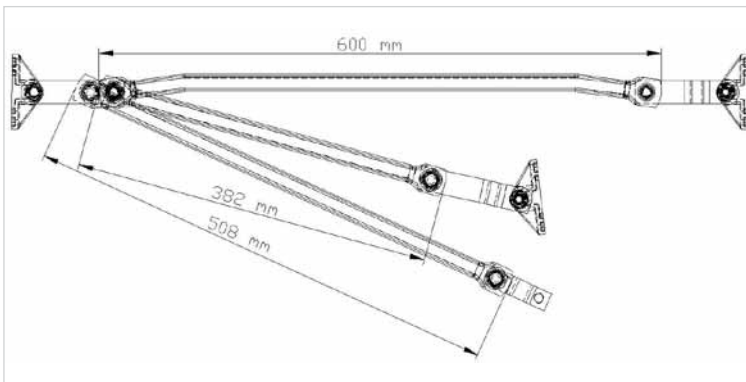

LP-0010: Reparos | Repairs

LP-0010-01

Barra Longa / Long Arm



Aplicação / Application: **SCANIA:** T112, T142, R112, R142 (1981->)

LP-0010-02 Barra Média / Medium Arm

LP-0010-03 Barra Curta / Short Arm

LP-0010-04 Pivô Curto / Short Pivot



LP-0010-05 Pivô Longo / Long Pivot

LP-0010-06 Pivô Duplo / Double Pivot

LP-0010-07 Manivela / Crank Arm



LP-0011

Conjunto Completo / Complete Part

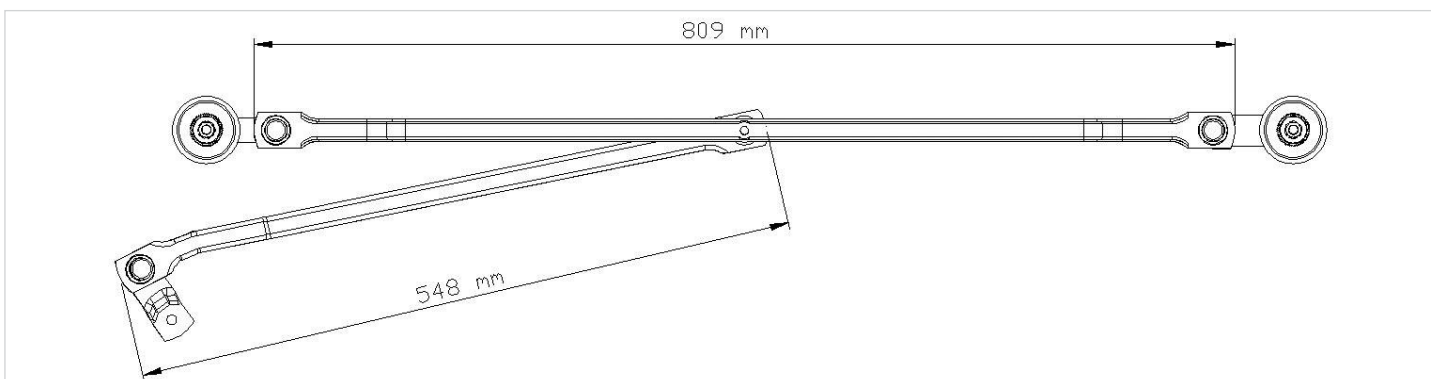

Aplicação / Application: **MBB:** 1618 SÉRIE L (1998->) - (LADO ESQUERDO DO MOTOR) / (LEFT SIDE MOTOR)
 LP-0011-05 TAMBÉM APLICA EM / ALSO APPLIES IN **MBB:** 712C, 914C (1998->), CARA CHATA (1997->)
 (LADO ESQUERDO DO MOTOR) / (LEFT SIDE MOTOR), SÉRIE L 1620 (L, LA, LK, LAK, LS, LB) (2001->)

LP-0011: Reparos | Repairs

LP-0011-01

Barra Longa / Long Arm



LP-0011-02

Barra Curta / Short Arm



LP-0011-03

Pivô Longo / Long Pivot

LP-0011-04

Pivô Curto / Short Pivot

LP-0011-05

Manivela / Crank Arm



LP-0013

Conjunto Completo / Complete Part

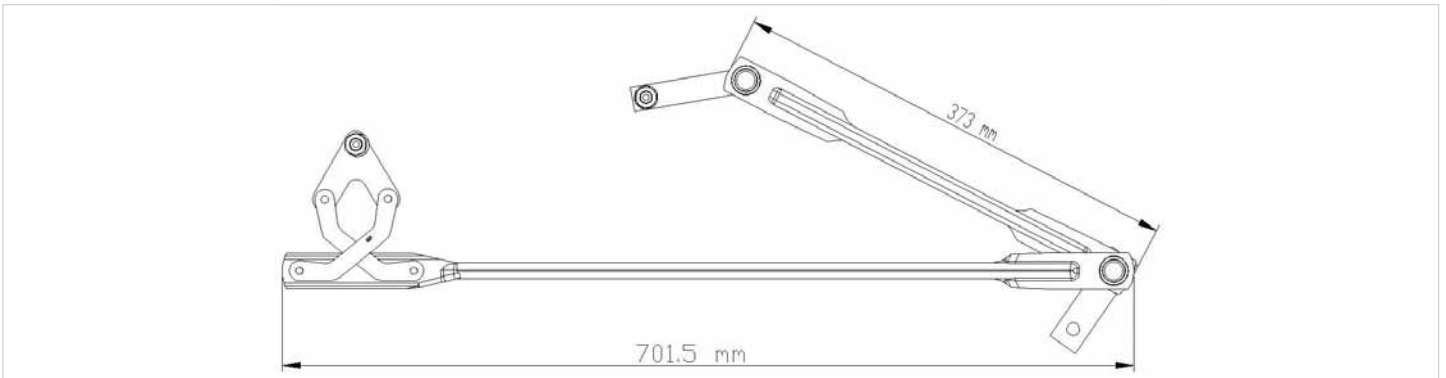

Aplicação / Application: VOLVO: NH12, FH12, FM 10, FM 12 (1999->)

LP-0013 : Reparos | Repairs

LP-0012-01

Barra Longa / Long Arm



LP-0013-02

Barra Curta / Short Arm



LP-0013-03

Pivô / Pivot



LP-0013-04

Manivela / Crank Arm



LP-0015

Conjunto Completo / Complete Part

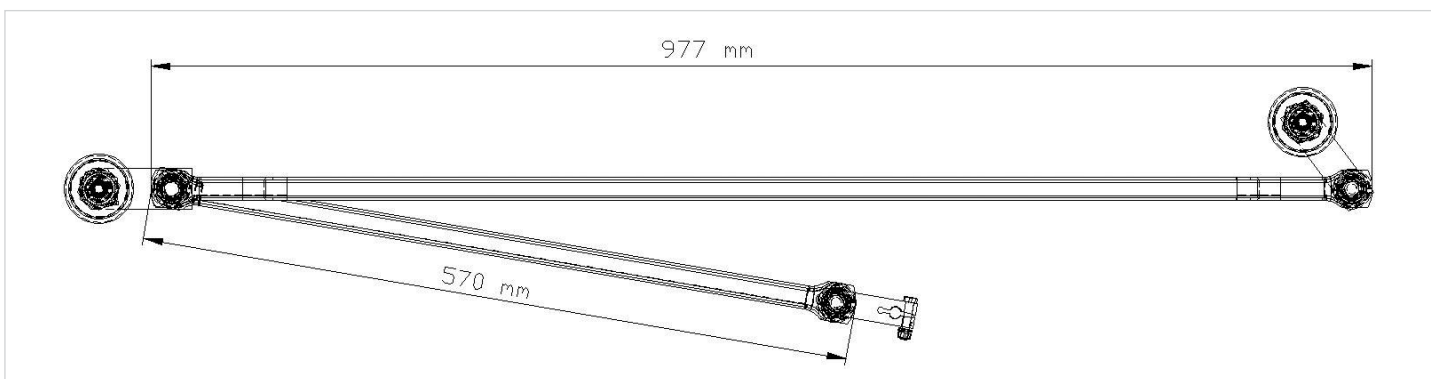

Aplicação / Application: MBB: 1935, 1941, SÉRIE L (1988->) - (LADO DIREITO DO MOTOR) / (RIGHT SIDE MOTOR)

LP-0015: Reparos | Repairs

LP-0015-01

Barra Longa / Long Arm



LP-0006-02

Barra Curta / Short Arm



LP-0006-03

Pivô Longo / Long Pivot

LP-0006-04

Pivô Curto / Short Pivot

LP-0006-05

Manivela / Crank Arm



LP-0019

Conjunto Completo / Complete Part

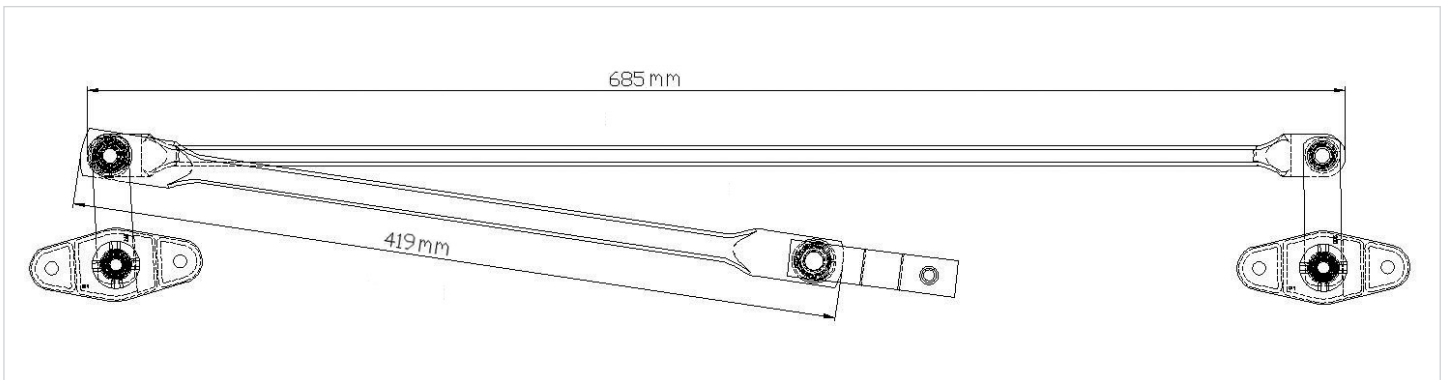

Aplicação / Application: VW: 6T, 7T (1982-1992), 11T Á 16T, 22T (1992-2000) MOTOR WAPSA

LP-0019: Reparos | Repairs

LP-0019-01

Barra Longa / Long Arm



LP-0019-02

Barra Curta / Short Arm



LP-0019-03 Pivô Direito / Right Pivot

LP-0019-04 Pivô Esquerdo / Left Pivot

LP-0019-05 Manivela / Crank Arm



LP-0021

Conjunto Completo / Complete Part

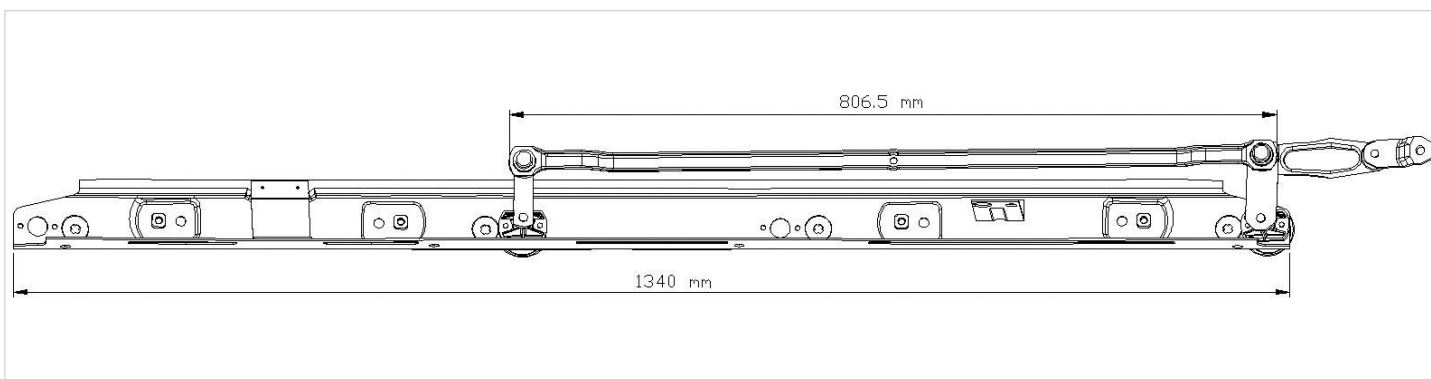

Aplicação / Application: **MBB: 712C, 914C (1998->) - LADO ESQUERDO DO MOTOR / LEFT SIDE MOTOR**

LP-0021: Reparos | Repairs

LP-0006-01 Barra Longa / Long Arm



LP-0021-02 Barra Curta / Short Arm



LP-0021-03 Pivô Duplo / Double Pivot



LP-0021-04 Pivô Curto / Short Pivot



LP-0011-05 Manivela / Crank Arm



LP-0021-06 Suporte do Conjunto / Bracket Set



LP-0022

Conjunto Completo / Complete Part

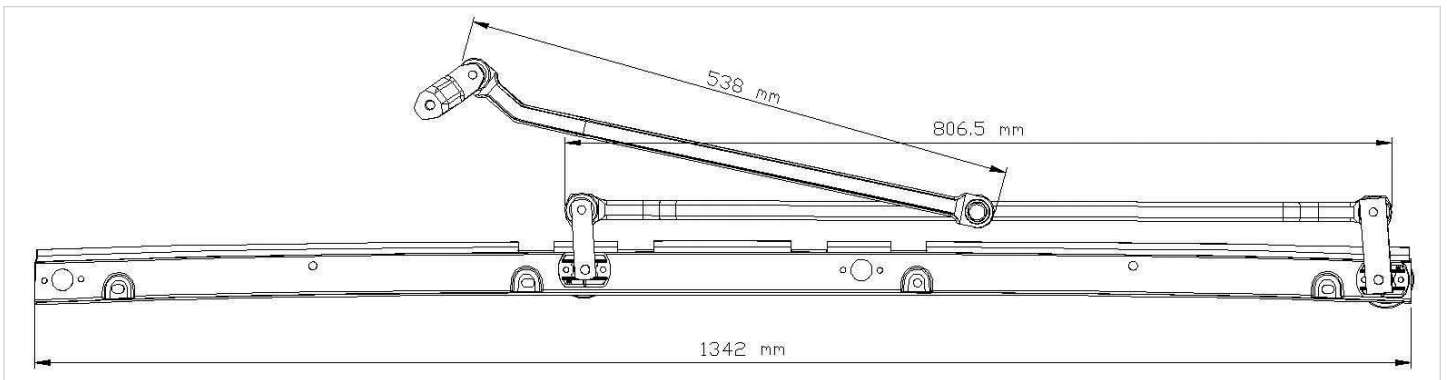

Aplicação / Application: MBB: 1620 (1996->) - LADO ESQUERDO DO MOTOR / LEFT SIDE MOTOR

LP-0022: Reparos | Repairs

LP-0006-01 Barra Longa / Long Arm

LP-0022-02 Barra Curta / Short Arm

LP-0002-03 Pivô Longo / Long Pivot

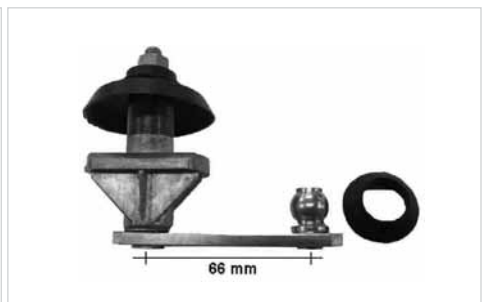

LP-0002-04 Pivô Curto / Short Pivot

LP-0022-05 Manivela / Crank Arm

LP-0022-06 Suporte do Conjunto / Bracket Set

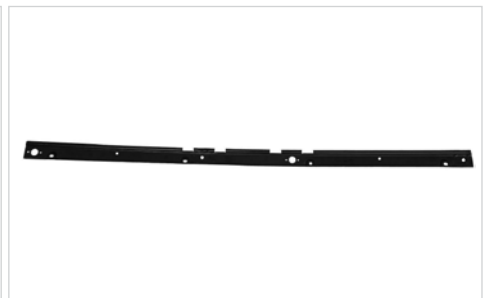
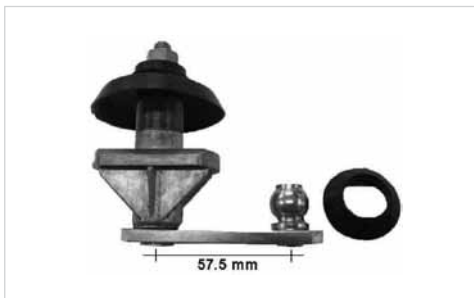

LP-0027

Conjunto Completo / Complete Part

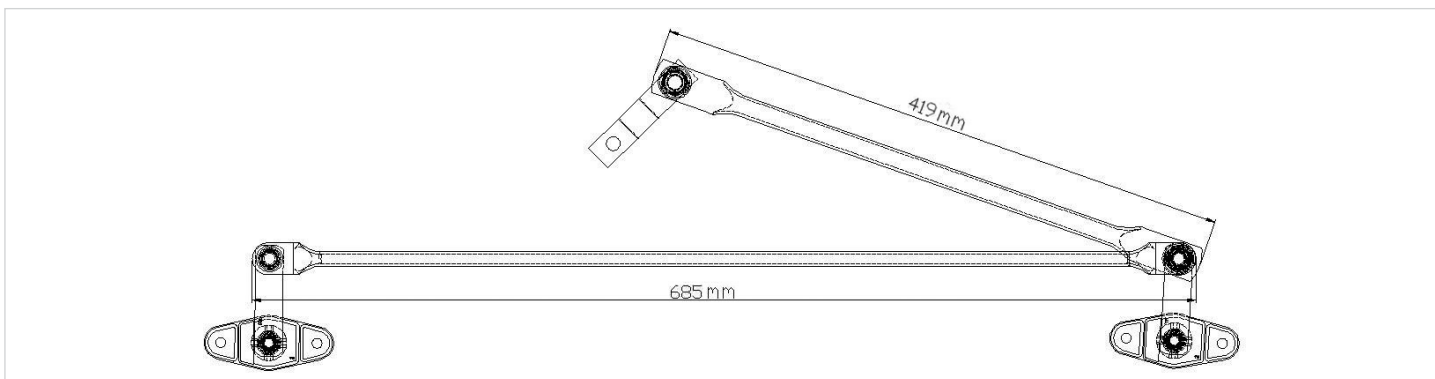

Aplicação / Application: VW: 6T, 7T (1982-1992), 11T Á 16T, 22T (1992-2000) MOTOR BOSCH

LP-0027: Reparos | Repairs

LP-0019-01

Barra Longa / Long Arm



LP-0019-02

Barra Curta / Short Arm



LP-0019-03 Pivô Direito / Right Pivot

LP-0019-04 Pivô Esquerdo / Left Pivot

LP-0027-05 Manivela / Crank Arm



Legenda:

- LM:** Lado Motriz / Engine Side
- LC:** Lado Coletor / Commutator Side
- I:** Intermediária / Intermediate
- PLAN.:** Planetária / Planetary Gear

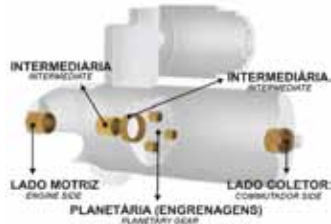

LM

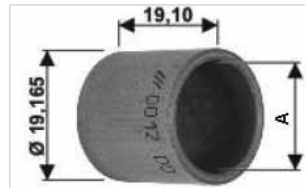

BC1-0012-00 STD A = Ø 16,002

Aplicação / Application: MBB, FORD, VOLKSWAGEN.

Observação / Note: CAIXA COM 10 PEÇAS / BOX WITH 10 PIECES. (DELCO REMY: 42MT)

LM / LC

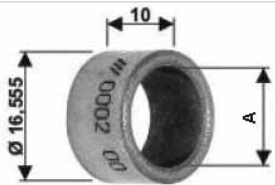

BC1-0002-00 STD A = Ø 12,548
BC1-0002-02 2X A = Ø 12,426

Aplicação / Application: FIAT, FORD, CHEVROLET-GM, PEUGEOT, VOLKSWAGEN: CAMINHÃO / TRUCK, DODGE, SCANIA

Observação / Note: CAIXA COM 10 PEÇAS / BOX WITH 10 PIECES. (BOSCH: JF)

I

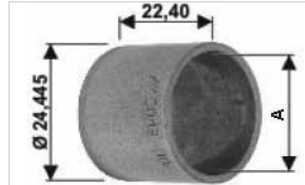

BC1-0013-00 STD A = Ø 21,325

Aplicação / Application: MBB, FORD, VOLKSWAGEN.

Observação / Note: CAIXA COM 10 PEÇAS / BOX WITH 10 PIECES. (DELCO REMY: 42MT)

LM

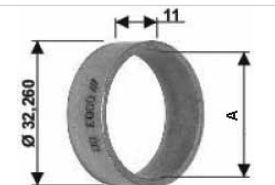

BC1-0003-00 STD A = Ø 28,385

Aplicação / Application: VOLKSWAGEN: GOL, PARATI, SANTANA, LOGUS 1.8, 2.0, POINTER, GOLF GTI 2.0, FORD: FIESTA 1.4, ESCORT 1.6

Observação / Note: CAIXA COM 10 PEÇAS / BOX WITH 10 PIECES

LM / LC

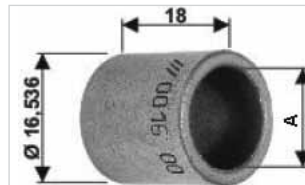

BC1-0016-00 STD A = Ø 12,522

BC1-0016-02 2X A = Ø 12,395

Aplicação / Application: CBT: TRATORES / TRACTORS 1105, 2105, 8240, CASE 960, POCLAIN, CLARK MB JD / JF - OM 352, JEEP, TOYOTA: BANDEIRANTE OM 352

Observação / Note: CAIXA COM 10 PEÇAS / BOX WITH 10 PIECES. (BOSCH: JD / JF)

LC



BC1-0009-00 STD A = Ø 12,548
BC1-0009-02 2X A = Ø 12,426

Aplicação / Application: VOLKSWAGEN: GOL, PASSAT, SANTANA, FIAT: 147, OGGI, FORD: CORCEL, PAMPA, ESCORT, CHEVROLET-GM: IPANEMA, KADET, MONZA

Observação / Note: CAIXA COM 10 PEÇAS / BOX WITH 10 PIECES

LM

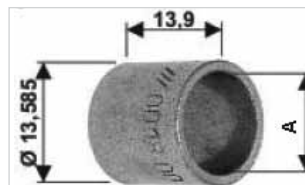

BC1-0018-00 STD A = Ø 11,048

BC1-0018-02 2X A = Ø 10,921

Aplicação / Application: VOLKSWAGEN: 1300, 1500, 1600, BRASILIA, SP2, VARIANT, KOMBI, FORD: AERO WILLYS, JEEP, RURAL, PICK-UP F75, MAVERICK 4, 6 CIL.

Observação / Note: CAIXA COM 10 PEÇAS / BOX WITH 10 PIECES

LM

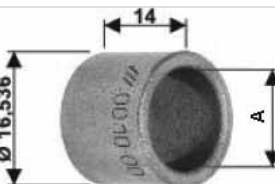

BC1-0010-00 STD A = Ø 12,522
BC1-0010-02 2X A = Ø 12,395

Aplicação / Application: MOTORES ESTACIONÁRIOS / STATIONARY ENGINES: AGRALE, CBT, CLARK, VALMET, CHEVROLET-GM, VOLKSWAGEN

Observação / Note: CAIXA COM 10 PEÇAS / BOX WITH 10 PIECES

LM



BC1-0019-00 STD A = Ø 12,063

BC1-0019-02 2X A = Ø 11,936

Aplicação / Application: CHEVROLET-GM: OPALA 2500, CARAVAN 2500, CHEVETTE, CORCEL I, II, BELIANA I, II, PAMPA, DEL-REY

Observação / Note: CAIXA COM 10 PEÇAS / BOX WITH 10 PIECES

LM / LC

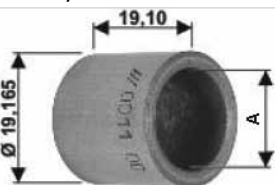

BC1-0011-00 STD A = Ø 14,428
BC1-0011-02 2X A = Ø 14,301

Aplicação / Application: MBB, FORD, VOLKSWAGEN: 37MT E 42MT

Observação / Note: CAIXA COM 10 PEÇAS / BOX WITH 10 PIECES. (DELCO REMY: 37 MT / 42MT)

LM

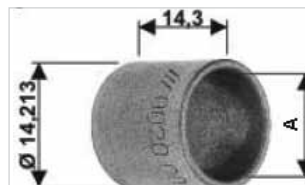

BC1-0020-00 STD A = Ø 12,063

BC1-0020-02 2X A = Ø 11,938

Aplicação / Application: FIAT, FORD, CHEVROLET-GM, VOLKSWAGEN, PEUGEOT, RENAULT

Observação / Note: CAIXA COM 10 PEÇAS / BOX WITH 10 PIECES

Legenda:

- LM: Lado Motriz / Engine Side
- LC: Lado Coletor / Commutator Side
- I: Intermediária / Intermediate
- PLAN.: Planetária / Planetary Gear

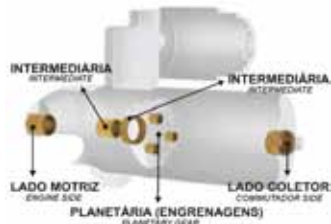

LC

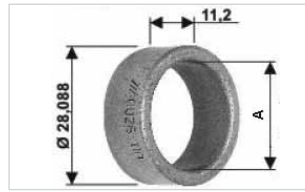

BC1-0026-00 STD A = Ø 22,128
BC1-0026-02 2X A = Ø 22,001

Aplicação / Application: VOLVO: N10, FNM, MBB, SSB

Observação / Note: CAIXA COM 10 PEÇAS / BOX WITH 10 PIECES. (BOSCH KB)

LM

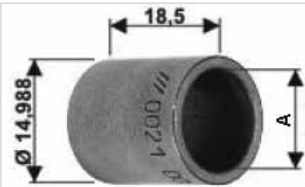

BC1-0021-00 STD A = Ø 11,998
BC1-0021-02 2X A = Ø 11,873

Aplicação / Application: FORD: GALAXIE, LANDAU, JEEP, RURAL, MAVERICK, KF: GUINDASTES / CRANE, HYSTER

Observação / Note: CAIXA COM 10 PEÇAS / BOX WITH 10 PIECES

LM

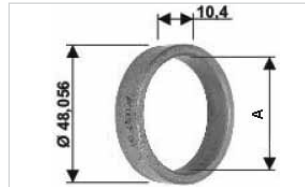

BC1-0027-00 STD A = Ø 40,093
BC1-0027-02 2X A = Ø 39,966

Aplicação / Application: VOLVO: N10, FNM, MBB, SSB

Observação / Note: CAIXA COM 10 PEÇAS / BOX WITH 10 PIECES. (BOSCH: KB)

LC

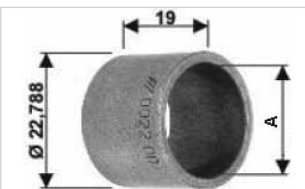

BC1-0022-00 STD A = Ø 18,830
BC1-0022-02 2X A = Ø 18,690

Aplicação / Application: CBT: CAMINHÕES / TRUCKS, FORD, CHEVROLET-GM, VOLKSWAGEN: C/ MOTOR / ENGINE PERKINS, FORD: F1000, F4000, AGRALE: TRATOR / TRACTOR T4200, CASE: 580

Observação / Note: CAIXA COM 10 PEÇAS / BOX WITH 10 PIECES

LM

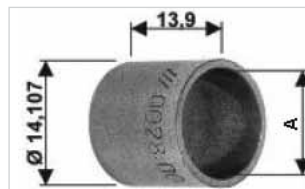

BC1-0028-00 STD A = Ø 12,088
BC1-0028-02 2X A = Ø 11,963

Aplicação / Application: FIAT: 147 (TODOS / ALL), VOLKSWAGEN: PASSAT, GOL, VOYAGE (10/81->)

Observação / Note: CAIXA COM 10 PEÇAS / BOX WITH 10 PIECES

LM

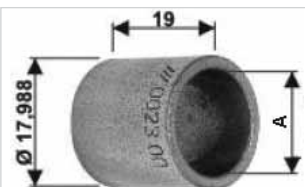

BC1-0023-00 STD A = Ø 14,325
BC1-0023-02 2X A = Ø 14,160

Aplicação / Application: CBT: CAMINHÕES, FORD, CHEVROLET-GM, VOLKSWAGEN C/ MOTOR / ENGINE PERKINS, MWM, VALMET: EIXO GROSSO / THICK SHAFT

Observação / Note: CAIXA COM 10 PEÇAS / BOX WITH 10 PIECES

LC

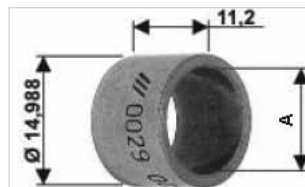

BC1-0029-00 STD A = Ø 11,998
BC1-0029-02 2X A = Ø 11,873

Aplicação / Application: VOLKSWAGEN: KOMBI, PASSAT, GOL, VOYAGE E SEDAN (10/81->)

Observação / Note: CAIXA COM 10 PEÇAS / BOX WITH 10 PIECES

LC



BC1-0024-00 STD A = Ø 15,748
BC1-0024-02 2X A = Ø 15,621

Aplicação / Application: MB, CBT: TRATORES / TRACTORS, AGRALE: MOTORES MWM DIESEL / MWM DIESEL ENGINES

Observação / Note: CAIXA COM 10 PEÇAS / BOX WITH 10 PIECES (BOSCH: JF / JD)

I

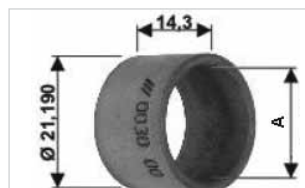

BC1-0030-00 STD A = Ø 17,903
BC1-0030-02 2X A = Ø 17,781

Aplicação / Application: VOLKSWAGEN: KOMBI DIESEL, PASSAT, GOL, VOYAGE, SEDAN (10/81->), FIAT: 147 (TODOS / ALL)

Observação / Note: CAIXA COM 10 PEÇAS / BOX WITH 10 PIECES

I

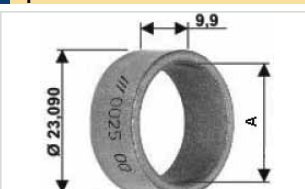

BC1-0025-00 STD A = Ø 19,101
BC1-0025-02 2X A = Ø 18,974

Aplicação / Application: MB, CBT: TRATORES / TRACTORS, AGRALE: MOTORES MWM DIESEL / MWM DIESEL ENGINES

Observação / Note: CAIXA COM 10 PEÇAS / BOX WITH 10 PIECES. (BOSCH: JF / JD)

LM

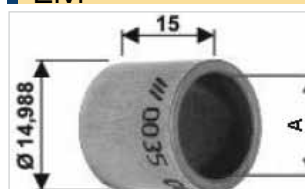

BC1-0035-00 STD A = Ø 11,998

Aplicação / Application: DODGE: 1800, WILLYS / FORD: RURAL, JEEP, CLARK: EMPILHADEIRA / FORKLIFT

Observação / Note: CAIXA COM 10 PEÇAS / BOX WITH 10 PIECES

Legenda:

- LM:** Lado Motriz / Engine Side
- LC:** Lado Coletor / Commutator Side
- I:** Intermediária / Intermediate
- PLAN.:** Planetária / Planetary Gear

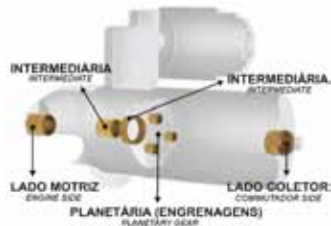

LC

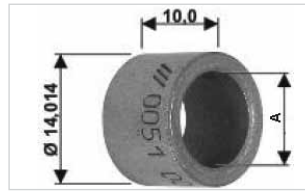

BC1-0051-00 STD A = Ø 10,060

Aplicação / Application: FIAT: PALIO WEEKEND, SIENA, STRADA, TIPO, TEMPRA

Observação / Note: CAIXA COM 10 PEÇAS / BOX WITH 10 PIECES

LC



BC1-0037-00 STD A = Ø 10,048
BC1-0037-02 2X A = Ø 9,943

Aplicação / Application: VOLKSWAGEN: GOL MI E BOLINHA, CHEVROLET-GM: CORSA, OMEGA, VECTOR, FORD: ESCORT

Observação / Note: CAIXA COM 10 PEÇAS / BOX WITH 10 PIECES

LM

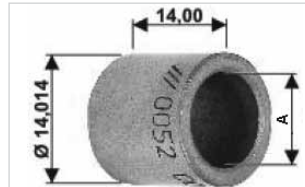

BC1-0052-00 STD A = Ø 10,060

Aplicação / Application: FIAT: PALIO WEEKEND, SIENA, STRADA, TIPO, TEMPRA

Observação / Note: CAIXA COM 10 PEÇAS / BOX WITH 10 PIECES

LC

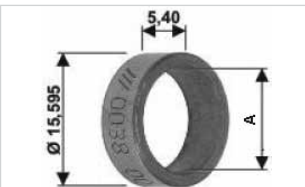

BC1-0038-00 STD A = Ø 12,095
BC1-0038-02 2X A = Ø 11,970

Aplicação / Application: FORD: FIESTA TURBO 1.0, 1.4, VERONA C/ MOTOR AUDI 2.0 (827) / AUDI ENGINE, ESCORT ZETEC, FIAT: PALIO TURBO 1.0, 1.5, 1.6

Observação / Note: CAIXA COM 10 PEÇAS / BOX WITH 10 PIECES

LM / I

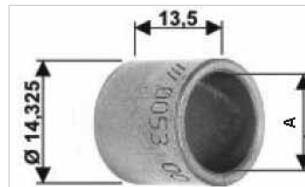

BC1-0053-00 STD A = Ø 11,215

Aplicação / Application: FIAT: FIORINO, UNO, TIPO, PREMIO, ELBA, MB: OF1316, OH1316, OH1318, OH1320, O371, OF215, OF1315

Observação / Note: CAIXA COM 10 PEÇAS / BOX WITH 10 PIECES

LM / I

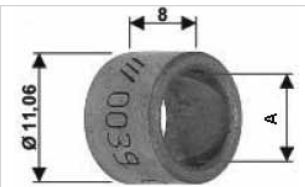

BC1-0039-00 STD A = Ø 8,100
BC1-0039-02 2X A = Ø 7,970

Aplicação / Application: FORD: ECOSPORT, KA, FIESTA 1.0, 1.6, ESCORT 1.6, VERONA, SPRINTER, F250, FIAT: PALIO, SIENA E STRADA 1.0, 1.4 8V FIRE

Observação / Note: CAIXA COM 10 PEÇAS / BOX WITH 10 PIECES

LM

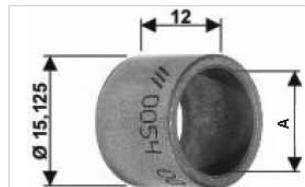

BC1-0054-00 STD A = Ø 12,080

Aplicação / Application: IVECO, MASSEY FERGUSON: TRATORES / TRACTORS

Observação / Note: CAIXA COM 10 PEÇAS / BOX WITH 10 PIECES

I

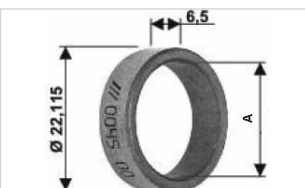

BC1-0045-00 STD A = Ø 18,015

Aplicação / Application: FORD: ESCORT, VERONA MOTOR ZETEC / ZETEC ENGINE, F250, SPRINTER

Observação / Note: CAIXA COM 10 PEÇAS / BOX WITH 10 PIECES

LM

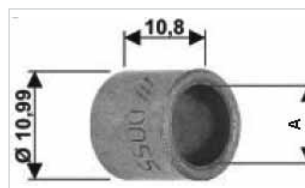

BC1-0055-00 STD A = Ø 8,00

Aplicação / Application: VOLKSWAGEN: GOL (BOLA), SANTANA, SAVEIRO, PARATI

Observação / Note: CAIXA COM 10 PEÇAS / BOX WITH 10 PIECES

LM

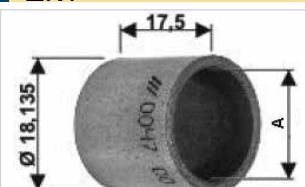

BC1-0047-00 STD A = Ø 15,063

Aplicação / Application: CHEVROLET-GM: D20, TRAFIC, FORD: F1000, F4000 MWM 4CC, JOHN DEERE

Observação / Note: CAIXA COM 10 PEÇAS / BOX WITH 10 PIECES

LM

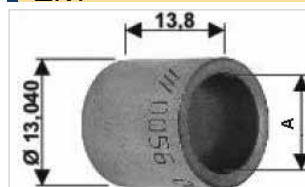

BC1-0056-00 STD A = Ø 10,050

Aplicação / Application: VOLKSWAGEN: CAMINHÕES / TRUCKS 24V (PRESTOLITE M100R), MWM: MOTORES DE PARTIDA / STARTER ENGINES M100R 12 E 24V

Observação / Note: CAIXA COM 10 PEÇAS / BOX WITH 10 PIECES

Legenda:

- LM: Lado Motriz / Engine Side
- LC: Lado Coletor / Commutator Side
- I: Intermediária / Intermediate
- PLAN.: Planetária / Planetary Gear

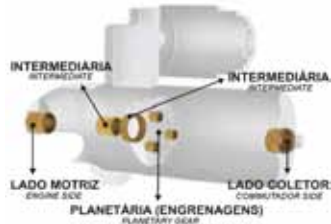

LC

BC1-0057-00 STD A = Ø 21,840

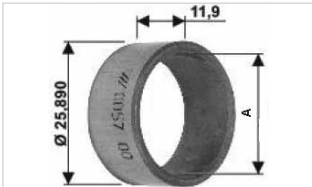

Aplicação / Application: VOLKSWAGEN: CAMINHÕES / TRUCKS 24V
(PRESTOLITE M100R), MWM: MOTORES DE PARTIDA / STARTER ENGINES M100R 12 E 24V

Observação / Note: CAIXA COM 10 PEÇAS / BOX WITH 10 PIECES

I

BC1-0058-00 STD A = Ø 15,063

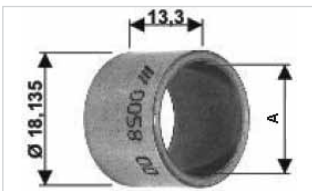

Aplicação / Application: VOLKSWAGEN: CAMINHÕES / TRUCKS 24V
(PRESTOLITE M100R), MWM: MOTORES DE PARTIDA / STARTER ENGINES M100R 12 E 24V

Observação / Note: CAIXA COM 10 PEÇAS / BOX WITH 10 PIECES

LM

BC1-0059-00 STD A = Ø 14,100



Aplicação / Application: FORD: CARGO, MERCEDES-BENZ: SPRINTER, MASSEY FERGUSON, IVECO

Observação / Note: CAIXA COM 10 PEÇAS / BOX WITH 10 PIECES

PLAN. / LC

BC1-0063-00 STD A = Ø 18,015



Aplicação / Application: FORD, GM, LAND ROVER, MASSEY FERGUSON.

Observação / Note: CAIXA COM 10 PEÇAS / BOX WITH 10 PIECES. UNIFAP: PLANETÁRIAS 11.025, 11.059, 11.104, 12.149, 12.212, 12.219, 12.221, 12.222

PLAN.

BC1-0066-00 STD A = Ø 18,015

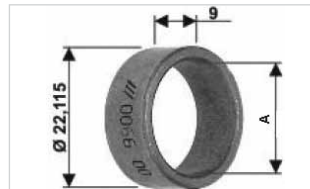

Aplicação / Application: FIAT: TEMPRA, TIPO, CHEVROLET-GM: OMEGA, SUPREMA, VOLKSWAGEN: GOLF 1.8, PASSAT 2.0, AUDI, ALFA ROMEO, CHRYSLER

Observação / Note: CAIXA COM 10 PEÇAS / BOX WITH 10 PIECES. UNIFAP: PLANETÁRIA 11.307

PLAN. / LC

BC1-0071-00 STD A = Ø 8,02

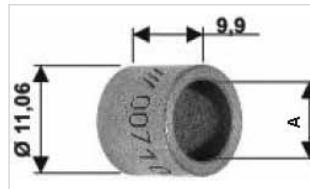

Aplicação / Application: MERCEDES-BENZ: SÉRIE - 7T, 9T, 12T, 14T, 16T, 24T, O

Observação / Note: CAIXA COM 10 PEÇAS / BOX WITH 10 PIECES. UNIFAP: PLANETÁRIAS: 11.003, 11.010, 11.015

PLAN. / I

BC1-0074-00 STD A = Ø 18,015



Aplicação / Application: VEÍCULOS RENAULT MOTOR VALEO D6RA133

Observação / Note: CAIXA COM 10 PEÇAS / BOX WITH 10 PIECES. UNIFAP: PLANETÁRIAS 11.010, 11.015, 11.018, 11.019

PLAN.

BC1-0079-00 STD A = Ø 10,044



Aplicação / Application: CHEVROLET-GM: BLAZER / S10 VORTEC V6 4.3

Observação / Note: CAIXA COM 10 PEÇAS / BOX WITH 10 PIECES. UNIFAP: PLANETÁRIA 14.890

PLAN.

BC1-0081-00 STD A = Ø 18,015



Aplicação / Application: CHEVROLET-GM: ASTRA, BLAZER, S10, VECTRA, FORD: F250 MWM 4.2 6CC, FIAT: VOLKSWAGEN

Observação / Note: CAIXA COM 10 PEÇAS / BOX WITH 10 PIECES. UNIFAP: PLANETÁRIAS: 11.010, 11.056, 11.067, 11.073, 11.090, 11.590

PRESTOLITE / LUCAS / INDIEL
KT-0001-00

Aplicação / Application: **VOLKSWAGEN:**
 C/ MOTORES / ENGINES CUMMINS 24V
 5.9 E 8.3, **FORD:** POWER STROKE C/
 MOTOR NAVISTAR V8 7.3. (PRESTOLITE,
 LUCAS, INDIEL: M100R)

WAPSA
KT-0002-00
KT-0002-02

Aplicação / Application: **VOLKSWA-**
GEN: CAMINHÕES, **FORD:** MOTORES
 PERKINS E MWM - EIXO GROSSO /
 THICK SHAFT

BOSCH
KT-0003-00
KT-0003-02

Aplicação / Application: **VOLKSWAGEN:**
 FOX 1.0 / 1.6, POLO 1.6 (2005 ->)
 (BOSCH: DA)

BOSCH / ROHER
KT-0004-00
KT-0004-02

Aplicação / Application: **AGRALE, CASE,**
CBT, VOLKSWAGEN: MOTOR / ENGINE
 MWM, **FORD:** CARGO, **MASSEY FER-**
GUSON, MAXION, MERCEDES-BENZ.
 (BOSCH: JF)

BOSCH / DELCO
KT-0005-00
KT-0005-02

Aplicação / Application: **VOLKSWAGEN:**
 FUSCA, GOL 1.3, 1.5, 1.6 (<-12/93),
 KOMBI 1.6 (ALC./GAS.) (08/82...12/93),
 BRASÍLIA 1.3, 1.6 (10/74...12/81), **FORD:**
 CORCEL, BELINA II, DEL REY (<-82)

BOSCH
KT-0006-00

Aplicação / Application: **VOLKSWAGEN:**
 POLO 1.6, 1.0 16V, POLO SEDAN (2002->)
 (ARA, BAH), POLO 2.0, POLO SEDAN 2.0
 APÓS 2002 (BBX), **VOLVO:** S80 T6, S80
 2.9. (BOSCH: DB)

MAGNETI MARELLI
KT-0007-00

Aplicação / Application: **FIAT: PALIO,**
 PALIO WEEKEND COM MOTOR 1.6 16V,
 SIENA E TIPO

PRESTOLITE / LUCAS / INDIEL
KT-0010-00

Aplicação / Application: **AGRALE, FORD:**
 F1000, F350, F4000, **JOHN DEERE,**
VOLKSWAGEN

PRESTOLITE / LUCAS / INDIEL
KT-0011-00

Aplicação / Application: **FORD: RANGER,**
 SILVERADO, SPRINTER

BOSCH
KT-0012-00
KT-0012-02

Aplicação / Application: **FIAT: UNO MILLE,**
 FIORINO, ELBA, PRÊMIO, 147, OGGI,
 PANORAMA, PICK-UP, SPAZIO, **FORD:**
 CORCEL, DEL-REY, BELINA. (BOSCH:
 DM / DW / EF)

BOSCH / WAPSA

KT-0013-00
KT-0013-02



Aplicação / Application: **VOLKSWAGEN:**
SEDAN 1300, 1500, 1600 4P, KOMBI,
KARMANN GUIA, VARIANT, BRASÍLIA,
SP-2 APÓS 67, **FORD:** AERO WILLYS,
RURAL, F75, MAVERICK 6CC

DELCO

KT-0015-00



Aplicação / Application: **FORD:** MOTOR
/ ENGINE CUMMINS SC 61, 12 E 24V,
MERCEDES-BENZ: MOTORES SÉRIE
BR-400 12 E 24V, **VOLKSWAGEN:**
MOTOR / ENGINE CUMMINS SÉRIE C 12 E
24V. (DELCO REMY: 42MT)

BOSCH

KT-0017-00



Aplicação / Application: **CHEVROLET-**
GM: OMEGA 2.2, 3.0, VECTRA, CORSA,
GOLF GTI, **MERCEDES-BENZ:** MB180D
(OM616), FURGÃO, PICK-UP, SPRINTER.
(**BOSCH:** DW)

BOSCH / DELCO / NASHVILLE

KT-0019-00
KT-0019-02



Aplicação / Application: **SCANIA:** SÉRIES
F, K, L, N, S, BN, **MERCEDES-BENZ,**
FIAT, VOLVO. (**BOSCH:** KB, DELCO
REMY: KB)

BOSCH

KT-0021-00



Aplicação / Application: **VOLKSWAGEN:**
GOL GII (BOLA), SANTANA, PARATI,
SAVEIRO. (**BOSCH:** DW)

BOSCH

KT-0022-00
KT-0022-02



Aplicação / Application: **CHEVROLET-**
GM: OMEGA 2.2, 3.0, CORSA 1.0, 1.4,
VECTRA 2.0, 2.2 POWERTECH

BOSCH / DELCO

KT-0024-00
KT-0024-02



Aplicação / Application: **CHEVROLET-GM:**
CARAVAN 4CIL., CHEVETE, MARAJÓ
(ALC. E GAS.) (<01/81), CHEVETE
1.4, MARAJÓ 1.4 (ALC. E GAS.)
(02/75...07/77). (**BOSCH:** EF / DW)

BOSCH

KT-0025-00
KT-0025-02



Aplicação / Application: **VOLKSWAGEN:**
GOL CLI 1.6 (SEM AR), 1.8 (COM AR).
(**BOSCH:** DW)

LUCAS

KT-0028-00



Aplicação / Application: **VOLKSWAGEN:**
GOL, PARATI, SAVEIRO, **FORD:** ESCORT
HOBBY, GUARUJÁ, **FIAT:** UNO 1.6

LUCAS / WAPSA

KT-0030-00
KT-0030-02



Aplicação / Application: **VOLKSWAGEN:**
LOGUS, POINTER

WAPSA

KT-0031-00
KT-0031-02

Aplicação / Application: VOLKSWA-
 GEN: PASSAT, GOL, SANTANA, FORD:
 ESCORT, PAMPA

WAPSA

KT-0032-00
KT-0032-02

Aplicação / Application: VOLKSWAGEN:
 KOMBI DIESEL E TODOS REFRI. AAR,
 GOL SEDAN 1300, 1500, KOMBI, BRASI-
 LIA, SAVEIRO (ALC. E GAS.) (07/82->)

BOSCH

KT-0034-00

Aplicação / Application: FORD: FIESTA
 1.0/ 1.3/ 1.4/ GSG/ TBL/ JBC/ J6B/ CVH14
 /PTE /ESCORT

VALEO

KT-0036-00

Aplicação / Application: FORD: ECOS-
 PORT, KA, FIESTA 1.0 /1.0 SUPERCHAR-
 GER, 1.6 ZETEC ROCAM, NOVO FIESTA
 1.0, 1.6 ZETEC ROCAM, ESCORT 1.6
 ZETEC ROCAM (07/99->). (VALEO: D7E)

BOSCH

KT-0037-00
KT-0037-02

Aplicação / Application: FIAT: PALIO,
 SIENA, STRADA 1.0 /1.4 8V FIRE 178
 ANO 03/2000. (BOSCH: DM)

BOSCH

KT-0041-00

Aplicação / Application: VOLKSWAGEN:
 GOL, PARATI, SANTANA, LOGUS 1.8 /2.0,
 POINTER, GOLF GTI 2.0, FORD: FIESTA
 1.4, ESCORT 1.6. (BOSCH: DA / DB /
 DM / DW)

BOSCH

KT-0042-00

Aplicação / Application: VOLKSWAGEN:
 GOL MI (BOLA), PARATI MI, FOX 1.0 /1.6
 (05->) E POLO 1.6 (05->). (BOSCH: DA)

VALEO

KT-0060-00

Aplicação / Application: CHEVROLET-GM:
 CELTA, FORD: FIESTA, KA, COURIER

BOSCH

KT-0064-00

Aplicação / Application: AUDI: A6, A8

LUCAS / INDIEL

KT-0065-00

Aplicação / Application: VOLKSWAGEN:
 POINTER, POLO, ORION.

VALEO

KT-0068-00



Aplicação / Application: RENAULT.
(VALEO: TS10E3)

NIPPONDENSO

KT-0073-00



Aplicação / Application: CATERPILLAR,
CUMMINS, CASE

MITSUBISHI

KT-0074-00



Aplicação / Application: MITSUBISHI:
L200, L300, PAJERO, TOYOTA, FORD:
RANGER

MANDO

KT-0075-00



Aplicação / Application: MITSUBISHI:
L200, EMPILHADEIRA / FORKLIFT, KIA:
BESTA

NIPPONDENSO

KT-0076-00



Aplicação / Application: KIA: BESTA 2.2

BOSCH

KT-0078-00



Aplicação / Application: CHEVROLET-GM:
ESCORT, VERONA (EQ. PRIMÁRIO E EQ.
COMERCIAL) COM MOTOR AP 93/94,
VOLKSWAGEN: LOGUS, POINTER,
POLO CLASSIC (<-01/00) (EQ. PRIMÁRIO
E EQ. COMERCIAL). (BOSCH: DM / DW)

BOSCH

KT-0079-00
KT-0079-02



Aplicação / Application: AUDI: A6,
CHEVROLET-GM: OMEGA GLS 2.0 /2.2
EFI, VOLKSWAGEN: GOL GTS 16V
(BOSCH: DW)

WAPSA

KT-0081-00
KT-0081-02



Aplicação / Application: FIAT: 147,
FIORINO, PANORAMA, CHEVROLET-
GM: CARAVAN, CHEVETTE, MARAJÓ,
MONZA, OPALA

BOSCH

KT-0082-00
KT-0082-02



Aplicação / Application: BMW: 316I,
318I, 320I, 323, 325I, 328, 525I, Z3, FIAT:
MAREA, MAREA WEEKEND, LAND
ROVER: DEFENDER, DISCOVERY,
RANGE ROVER

Porta Escovas Brush Holders		Página Page												
UF - 1.101	Bosch	1	UF - 1.169	Nippondenso	24	UF - 2.204	Bosch	29	UF - 3.332	Bosch	37	UF - 3.402	Bosch	40
UF - 1.102	Bosch	1	UF - 1.170	Nippondenso	24	UF - 2.205	Delco	30	UF - 3.333	Prestolite	42	UF - 3.403	Diversos	45
UF - 1.103	Bosch	1	UF - 1.171	Valeo	26	UF - 2.206	Bosch	29	UF - 3.334	Prestolite	43	UF - 3.404	Mitsubishi	42
UF - 1.104	Bosch	1	UF - 1.172	Valeo	27	UF - 2.207	Prestolite/ Delphi	31	UF - 3.335	Diversos	44	UF - 3.405	Valeo	43
UF - 1.105	Bosch	2	UF - 1.173	Valeo	27	UF - 2.208	Prestolite/ Delphi	31	UF - 3.336	Bosch	37	UF - 3.406	Bosch	40
UF - 1.106	Bosch	2	UF - 1.174	Bosch	8	UF - 2.209	Prestolite/ Delphi	31	UF - 3.337	Bosch	37	UF - 3.407	Bosch	40
UF - 1.107	Bosch	2	UF - 1.175	Bosch	8	UF - 2.210	Prestolite/ Delphi	32	UF - 3.338	Bosch	37	UF - 3.408	Bosch	40
UF - 1.108	Ford/ Motorcraft	16	UF - 1.176	Ford/ Motorcraft	17	UF - 2.211	Delco	30	UF - 3.339	Bosch	37	UF - 3.409	Valeo/ Bosch	43
UF - 1.109	Ford/ Motorcraft	17	UF - 1.177	Ford/ Motorcraft	17	UF - 2.212	Bosch	29	UF - 3.340	Delco	42	UF - 3.410	Nippondenso	42
UF - 1.110	Bosch	2	UF - 1.178	Mitsubishi	22	UF - 2.213	Delco	30	UF - 3.341	Bosch	37	UF - 3.411	Valeo	43
UF - 1.111	Bosch	3	UF - 1.179	Mitsubishi	22	UF - 2.214	Delco	30	UF - 3.342	Bosch	37	UF - 3.412	Valeo	43
UF - 1.112	Bosch	3	UF - 1.180	Hitachi/ Mitsubishi	18	UF - 2.215	Delco	30	UF - 3.343	Bosch	37	UF - 3.413	Valeo	43
UF - 1.113	Bosch	3	UF - 1.181	Delco	13	UF - 2.216	Ford/ Motorcraft	31	UF - 3.344	Bosch	37	UF - 3.414	Valeo	43
UF - 1.114	Bosch	3	UF - 1.182	Delco	14	UF - 2.217	Ford/ Motorcraft	31	UF - 3.345	Diversos	44	UF - 3.415	Valeo	43
UF - 1.115	Bosch	3	UF - 1.183	Ford/ Motorcraft	17	UF - 2.218	Ford/ Motorcraft	31	UF - 3.346	Bosch	37	UF - 3.416	Valeo	44
UF - 1.116	Bosch	4	UF - 1.184	Delco	14	UF - 2.219	Delco	30	UF - 3.347	Bosch	38	UF - 3.417	Valeo	44
UF - 1.117	Bosch	4	UF - 1.185	Delco	14	UF - 2.220	Delco	30	UF - 3.348	Bosch	38	UF - 3.418	Valeo	44
UF - 1.118	Bosch	4	UF - 1.186	Valeo	27	UF - 2.221	Ford/ Visteon	31	UF - 3.349	Bosch	38	UF - 3.419	Mitsubishi	42
UF - 1.119	Bosch	4	UF - 1.187	Mitsubishi	23	UF - 9.901	Honda	34	UF - 3.350	Bosch	38	UF - 3.420	Bosch	41
UF - 1.120	Delco	11	UF - 1.188	Delco	14	UF - 9.902	Honda/ Yamaha	34	UF - 3.351	Bosch	38	UF - 3.421	Magneti Marelli	42
UF - 1.121	Delco	12	UF - 1.189	Delco	14	UF - 9.903	Yamaha	34	UF - 3.352	Bosch	38	UF - 3.422	Bosch	41
UF - 1.122	Delco	12	UF - 1.190	Delco	15	UF - 9.904	Kawasaki	34	UF - 3.353	Bosch	38	UF - 3.423	Mitsubishi	42
UF - 1.123	Delco	12	UF - 1.191	Delco	15	UF - 9.905	Honda	34	UF - 3.354	Diversos	44	UF - 3.424	Bosch	41
UF - 1.124	Bosch	4	UF - 1.192	Delco	15	UF - 9.906	Honda	34	UF - 3.355	Bosch	38	UF - 3.425	Bosch	41
UF - 1.125	Bosch	5	UF - 1.193	Delco	15	UF - 9.907	Nippondenso	34	UF - 3.356	Bosch	38	UF - 3.426	Bosch	41
UF - 1.126	Bosch	5	UF - 1.194	Bosch	8	UF - 6.601	Bosch	33	UF - 3.357	Diversos	44	UF - 3.427	Bosch	41
UF - 1.127	Bosch	5	UF - 1.195	Prestolite	26	UF - 6.602	Bosch	33	UF - 3.358	Bosch	38	UF - 3.428	Bosch	41
UF - 1.128	Bosch	5	UF - 1.196	Prestolite	26	UF - 6.603	Delco	33	UF - 3.359	Prestolite	43	UF - 3.429	Valeo	44
UF - 1.129	Bosch	5	UF - 1.197	Bosch	8	UF - 6.604	Mabuchi/ Carto	33	UF - 3.360	Bosch	38	UF - 3.430	Bosch	41
UF - 1.130	Prestolite	25	UF - 1.198	Bosch	8	UF - 6.605	Diversos	32	UF - 3.361	Bosch	38	UF - 3.431	Diversos	45
UF - 1.131	Bosch	6	UF - 1.199	Mitsuba	19	UF - 6.606	Diversos	32	UF - 3.362	Prestolite	43	UF - 3.432	Valeo	44
UF - 1.132	Bosch	6	UF - 1.200	Mitsubishi	23	UF - 6.607	Diversos	32	UF - 3.363	Bosch	39	UF - 3.433	Diversos	45
UF - 1.133	Delco	12	UF - 1.201	Bosch	9	UF - 6.608	Diversos	32	UF - 3.364	Diversos	44	UF - 3.434	Mitsubishi	42
UF - 1.134	Delco	12	UF - 1.202	Magneti Marelli	19	UF - 6.609	Diversos	32	UF - 3.365	Bosch	39	UF - 3.435	Bosch	41
UF - 1.135	Prestolite	25	UF - 1.203	Valeo	27	UF - 6.610	Diversos	33	UF - 3.366	Nippondenso	42	Polias Roda-Livre Free Wheel Pulleys		Página Page
UF - 1.136	Bosch	6	UF - 1.204	Valeo	27	UF - 6.611	Diversos	33	UF - 3.367	Diversos	44	UF - 33.001	Valeo	47
UF - 1.137	Ford/ Motorcraft	17	UF - 1.205	Hitachi	18	UF - 6.612	Valeo	33	UF - 3.368	Bosch	39	UF - 33.002	Bosch	46
UF - 1.138	Valeo	26	UF - 1.206	Bosch	9	Polias Pulleys		Página Page	UF - 3.369	Bosch	39	UF - 33.003	Valeo	48
UF - 1.139	Magneti Marelli	19	UF - 1.207	Valeo	28	UF - 3.301	Bosch	35	UF - 3.370	Diversos	44	UF - 33.004	Bosch	46
UF - 1.140	Magneti Marelli	19	UF - 1.208	Nippondenso	24	UF - 3.302	Bosch	35	UF - 3.371	Bosch	39	UF - 33.005	Nippondenso	47
UF - 1.141	Magneti Marelli	19	UF - 1.209	Nippondenso	25	UF - 3.303	Bosch	35	UF - 3.372	Bosch	39	UF - 33.006	Valeo	48
UF - 1.142	Mitsubishi	20	UF - 1.210	Bosch	9	UF - 3.304	Bosch	35	UF - 3.373	Bosch	39	UF - 33.007	Bosch	46
UF - 1.143	Mitsubishi	20	UF - 1.211	Nippondenso	25	UF - 3.305	Bosch	35	UF - 3.374	Bosch	39	UF - 33.008	Bosch	46
UF - 1.144	Mitsubishi	20	UF - 1.212	Nippondenso	25	UF - 3.306	Bosch	35	UF - 3.375	Bosch	39	UF - 33.009	Valeo	48
UF - 1.145	Mitsubishi	20	UF - 1.213	Iskra	18	UF - 3.307	Bosch	35	UF - 3.376	Bosch	39	UF - 33.010	Mitsubishi	47
UF - 1.146	Mitsubishi	21	UF - 1.214	Hitachi	18	UF - 3.308	Bosch	35	UF - 3.377	Bosch	39	UF - 33.011	Bosch	47
UF - 1.147	Mitsubishi	21	UF - 1.215	Hitachi	18	UF - 3.309	Bosch	35	UF - 3.378	Valeo	43	Planetárias Planetary Gears		Página Page
UF - 1.148	Delco	13	UF - 1.216	Mitsuba	20	UF - 3.310	Bosch	35	UF - 3.379	Bosch	39	UF - 11.003	Bosch	52
UF - 1.149	Delco	13	UF - 1.217	Bosch	9	UF - 3.311	Bosch	35	UF - 3.380	Bosch	39	UF - 11.010	Bosch	52
UF - 1.150	Bosch	6	UF - 1.218	Bosch	9	UF - 3.312	Delco	41	UF - 3.381	Bosch	39	UF - 11.015	Bosch	52
UF - 1.151	Bosch	6	UF - 1.219	Bosch	10	UF - 3.313	Delco	41	UF - 3.382	Bosch	40	UF - 11.018	Bosch	52
UF - 1.152	Bosch	7	UF - 1.220	Delco	16	UF - 3.314	Delco	41	UF - 3.383	Diversos	45	UF - 11.019	Bosch	52
UF - 1.153	Nippondenso	23	UF - 1.221	Delco	16	UF - 3.315	Delco	41	UF - 3.384	Diversos	45	UF - 11.029	Bosch	53
UF - 1.154	Nippondenso	24	UF - 1.222	Bosch	10	UF - 3.316	Delco	41	UF - 3.385	Diversos	45	UF - 11.037	Bosch	53
UF - 1.155	Mitsubishi	21	UF - 1.223	Bosch	10	UF - 3.317	Delco	42	UF - 3.386	Diversos	45	UF - 11.056	Bosch	53
UF - 1.156	Mitsubishi	21	UF - 1.224	Bosch	10	UF - 3.318	Delco	42	UF - 3.387	Bosch	40	UF - 11.058	Bosch	53
UF - 1.157	Mitsubishi	21	UF - 1.225	Bosch	10	UF - 3.319	Delco	42	UF - 3.388	Bosch	40	UF - 11.059	Bosch	53
UF - 1.158	Mitsubishi	22	UF - 1.226	Bosch	11	UF - 3.320	Bosch	36	UF - 3.389	Diversos	45	UF - 11.067	Bosch	54
UF - 1.159	Mitsubishi	22	UF - 1.227	Bosch	11	UF - 3.321	Bosch	36	UF - 3.390	Bosch	40	UF - 11.073	Bosch	54
UF - 1.160	Mitsubishi	22	UF - 1.228	Delco	16	UF - 3.322	Bosch	36	UF - 3.391	Valeo	43	UF - 11.090	Bosch	54
UF - 1.161	Nippondenso	24	UF - 1.229	Valeo	28	UF - 3.323	Bosch	36	UF - 3.392	Bosch	40	UF - 11.099	Bosch	54
UF - 1.162	Bosch	7	UF - 1.230	Delco	16	UF - 3.324	Bosch	36	UF - 3.393	Ford/ Motorcraft	42	UF - 11.104	Bosch	54
UF - 1.163	Valeo	26	UF - 1.231	Mitsubishi	23	UF - 3.325	Bosch	36	UF - 3.394	Diversos	45	UF - 11.111	Bosch	55
UF - 1.164	Bosch	7	UF - 1.232	Valeo	28	UF - 3.326	Bosch	36	UF - 3.395	Bosch	40	UF - 11.112	Bosch	55
UF - 1.165	Bosch	7	UF - 1.233	Bosch	11	UF - 3.327	Bosch	36	UF - 3.396	Bosch	40	UF - 11.117	Bosch	55
UF - 1.166	Bosch	7	UF - 1.234	Mitsubishi	23	UF - 3.328	Bosch	36	UF - 3.397	Mitsubishi	42	UF - 11.118	Bosch	55
UF - 1.167	Delco	13	UF - 1.235	Bosch	11	UF - 3.329	Bosch	36	UF - 3.398	Mitsubishi	42	UF - 11.122	Bosch	55
UF - 1.168	Delco	13	UF - 2.201	Bosch	29	UF - 3.330	Bosch	37	UF - 3.399	Ford/ Motorcraft	42	UF - 11.123	Bosch	55
			UF - 2.202	Bosch	29	UF - 3.331	Bosch	37	UF - 3.400	Diversos	45	UF - 11.126	Bosch	56
			UF - 2.203	Delco	29				UF - 3.401	Bosch	40			



Cadastre-se para receber catálogo, brindes e novidades / Sign up to receive catalog, gifts and news.

Empresa / Company: _____

Nome / Name: _____

Endereço / Address: _____

Bairro / Neighborhood: _____ CEP / Zip Code: _____

Cidade / City: _____ Estado / Province: _____

Fone / Phone: _____ E-mail: _____

Preencha, recorte e envie via FAX, correio ou e-mail conforme os dados ao lado.

Fill, cut and send by FAX, mailing or e-mail as the following information.



Unifap Indústria Metalúrgica Ltda
 Rua: João Barbieri, 605
 Barracão - Gaspar - SC - Brasil
 CEP: 89.110-000
 Fone / Fax: 55 (47) 3332-8179
 unifap@unifap.com.br

UF - 11.128	Bosch	56	R - 0089	Delco	65	UF - 7.704	Bosch	69	BC1 - 0071	Unifap	90
UF - 11.143	Bosch	56	R - 0090	Bosch	65	Mancais / Tampa		Página	BC1 - 0074	Unifap	90
UF - 11.145	Bosch	56	R - 0091	Delco	66	Housings / Cover		Page	BC1 - 0079	Unifap	90
UF - 11.153	Bosch	56	R - 0092	Ford/ Motorcraft	66	UF - 8.801	Bosch	69	BC1 - 0081	Unifap	90
UF - 11.161	Bosch	57	R - 0093	Ford/ Motorcraft	66	UF - 8.802	Bosch	70	Kit Buchas		Página
UF - 11.307	Bosch	57	R - 0094	Bosch	65	UF - 8.803	Bosch	70	Bushes Kit		Page
UF - 11.590	Bosch	57	R - 0095	Prestolite	67	Articulação de Acionamento para Limpador		Página	KT - 0001	Prestolite	91
UF - 12.100	Prestolite	57	R - 0096	Mitsubishi	67	de Para-brisa		Page	KT - 0002	Wapsa	91
UF - 12.147	Prestolite	58	R - 0097	Delco	66	Window Wiper Linkage Transmission			KT - 0003	Bosch	91
UF - 12.149	Prestolite	58	R - 0098	Mitsubishi	67	LP - 0001	Unifap	71	KT - 0004	Bosch / Roher	91
UF - 12.212	Prestolite	58	R - 0099	Mitsubishi	67	LP - 0002	Unifap	72	KT - 0005	Bosch / Delco	91
UF - 12.219	Prestolite	58	R - 0100	Mitsubishi/ Delco	67	LP - 0003	Unifap	73	KT - 0006	Bosch	91
UF - 12.221	Prestolite	58	R - 0101	Mitsubishi	67	LP - 0004	Unifap	74	KT - 0007	Magneti Marelli	91
UF - 12.222	Prestolite	59	R - 0102	Mitsubishi	67	LP - 0005	Unifap	75	KT - 0010	Prestolite	91
UF - 12.343	Prestolite	59	R - 0103	Mitsubishi	67	LP - 0006	Unifap	76	KT - 0011	Prestolite	91
UF - 13.119	Ford/ Motorcraft	59	R - 0104	Prestolite	68	LP - 0007	Unifap	77	KT - 0012	Bosch	91
UF - 13.120	Ford/ Motorcraft	59	R - 0105	Prestolite	68	LP - 0008	Unifap	77	KT - 0013	Bosch / Wapsa	92
UF - 13.121	Ford/ Motorcraft	59	Garfos		Página	LP - 0009	Unifap	78	KT - 0015	Delco	92
UF - 13.122	Ford/ Motorcraft	60	Engaging Levers		Page	LP - 0010	Unifap	79	KT - 0017	Bosch	92
UF - 14.032	Delco	60	UF - 4.401	Bosch	49	LP - 0011	Unifap	80	KT - 0019	Bosch / Delco / Nashville	92
UF - 14.095	Delco	60	UF - 4.402	Bosch	49	LP - 0012-01	Unifap	81	KT - 0021	Bosch	92
UF - 14.150	Delco	60	UF - 4.403	Bosch	49	LP - 0013	Unifap	81	KT - 0022	Bosch	92
UF - 14.357	Delco	61	UF - 4.404	Bosch	49	LP - 0015	Unifap	82	KT - 0024	Bosch / Delco	92
UF - 14.368	Delco	61	UF - 4.405	Delco	50	LP - 0019	Unifap	83	KT - 0025	Bosch	92
UF - 14.711	Delco	61	UF - 4.406	Bosch	49	LP - 0021	Unifap	84	KT - 0028	Lucas	92
UF - 14.811	Delco	61	UF - 4.407	Bosch	49	LP - 0022	Unifap	85	KT - 0030	Lucas Wapsa	92
UF - 14.890	Delco	61	UF - 4.408	Bosch	49	LP - 0027	Unifap	86	KT - 0031	Wapsa	93
UF - 14.910	Delco	62	UF - 4.409	Delco	50	Buchas Sinterizadas		Página	KT - 0032	Wapsa	93
UF - 15.100	Mitsubishi	62	UF - 4.410	Delco	50	Sintered Bushes		Page	KT - 0034	Bosch	93
UF - 15.101	Mitsubishi	62	UF - 4.411	Bosch	49	BC1 - 0002	Unifap	87	KT - 0036	Valeo	93
UF - 15.103	Mitsubishi	62	UF - 4.412	Prestolite	51	BC1 - 0003	Unifap	87	KT - 0037	Bosch	93
UF - 15.104	Mitsubishi	62	UF - 4.413	Prestolite	51	BC1 - 0009	Unifap	87	KT - 0041	Bosch	93
UF - 16.101	Valeo	63	UF - 4.414	Prestolite	51	BC1 - 0010	Unifap	87	KT - 0042	Bosch	93
UF - 16.102	Valeo	63	UF - 4.415	Bosch	49	BC1 - 0011	Unifap	87	KT - 0060	Valeo	93
UF - 16.103	Valeo	63	UF - 4.416	Bosch	49	BC1 - 0012	Unifap	87	KT - 0064	Bosch	93
UF - 16.104	Valeo	63	UF - 4.417	Magneti Marelli	50	BC1 - 0013	Unifap	87	KT - 0065	Lucas	93
Reparos			UF - 4.418	Valeo	51	BC1 - 0016	Unifap	87	KT - 0068	Valeo	94
Repair Kit			UF - 4.419	Valeo	51	BC1 - 0018	Unifap	87	KT - 0073	Nippondenso	94
R - 0055	Bosch	64	UF - 4.420	Mitsubishi	50	BC1 - 0019	Unifap	87	KT - 0074	Mitsubishi	94
R - 0056	Bosch	64	UF - 4.421	Mitsubishi	50	BC1 - 0020	Unifap	87	KT - 0075	Mando	94
R - 0057	Bosch	64	UF - 4.422	Delco	50	BC1 - 0021	Unifap	88	KT - 0076	Nippondenso	94
R - 0058	Bosch	64	UF - 4.423	Valeo	51	BC1 - 0022	Unifap	88	KT - 0078	Bosch	94
R - 0059	Ford/ Motorcraft	66	UF - 4.424	Magneti Marelli	50	BC1 - 0023	Unifap	88	KT - 0079	Bosch	94
R - 0060	Bosch	64	UF - 4.425	Ford/ Motorcraft	51	BC1 - 0024	Unifap	88	KT - 0081	Wapsa	94
R - 0061	Bosch	64	UF - 4.427	Bosch	49	BC1 - 0025	Unifap	88	KT - 0082	Bosch	94
R - 0062	Bosch	64	UF - 4.428	Bosch/ Delco	50	BC1 - 0026	Unifap	88	Total Produtos / All Products		567
R - 0063	Delco	65	UF - 4.429	Ford/ Motorcraft	51	BC1 - 0027	Unifap	88			
R - 0064	Delco	65	UF - 4.430	Valeo	51	BC1 - 0028	Unifap	88			
R - 0065	Delco	65	UF - 4.431	Delco	50	BC1 - 0029	Unifap	88			
R - 0066	Mitsubishi/ Delco	66	UF - 4.432	Delco	50	BC1 - 0030	Unifap	88			
R - 0067	Ford/ Motorcraft	66	UF - 4.433	Delco	50	BC1 - 0035	Unifap	88			
R - 0068	Valeo	67	UF - 4.434	Iskra	50	BC1 - 0037	Unifap	89			
R - 0069	Valeo	67	Reparos para Garfos		Página	BC1 - 0038	Unifap	89			
R - 0070	Mitsubishi	66	Repairs for Engaging levers		Page	BC1 - 0039	Unifap	89			
R - 0071	Delco	65	R - 4.411	Bosch	51	BC1 - 0045	Unifap	89			
R - 0072	Mitsubishi	66	R - 4.415	Bosch	51	BC1 - 0047	Unifap	89			
R - 0073	Mitsubishi	67	R - 4.416	Bosch	51	BC1 - 0051	Unifap	89			
R - 0080	Bosch	64	Buchas do Alternador		Página	BC1 - 0052	Unifap	89			
R - 0081	Bosch	64	Bushing for Alternators		Page	BC1 - 0053	Unifap	89			
R - 0082	Prestolite	67	UF - 5.506	Bosch	70	BC1 - 0054	Unifap	89			
R - 0083	Bosch	64	UF - 5.507	Bosch	70	BC1 - 0055	Unifap	89			
R - 0084	Ford/ Motorcraft	66	UF - 5.508	Bosch	70	BC1 - 0056	Unifap	89			
R - 0085	Bosch	64	Haste de Partida		Página	BC1 - 0057	Unifap	90			
R - 0086	Bosch	65	Engagement Rod KB		Page	BC1 - 0058	Unifap	90			
R - 0087	Bosch	65	UF - 7.701	Bosch	69	BC1 - 0059	Unifap	90			
R - 0088	Delco	65	UF - 7.702	Bosch	69	BC1 - 0063	Unifap	90			
			UF - 7.703	Bosch	69	BC1 - 0066	Unifap	90			

Todos os nomes de fabricantes e seus respectivos códigos de peças foram utilizados exclusivamente para referência, a UNIFAP não se responsabiliza por possíveis erros relacionados / All manufacturer's names and number are used for reference purposes only, UNIFAP assumes no responsibility for possible mistakes.



Vendas Internacionais
International Sales
55 47 3332.8383
unifap@unifap.com.br
www.unifap.com.br

Gerência Comercial Reposição Brasil:

Irmãos Ferreira Ltda
Sérgio Ferreira - sergio@unifap.com.br
(11) 9 8615-2409, 9 7791-4606, 55*115*60558

Representantes Brasil:

Amazonas, Roraima e Amapá
G.F. Representações
92 3238.7609 gfrep.am@gmail.com

Alagoas, Bahia e Sergipe
Servo Representação
75 3623.0627 servo@servo.com.br

Ceará e Piauí
Norpress Representações
85 3248.2625 norpres@ig.com.br

Espírito Santo
Esthavic Representações
27 3033.3230 esthavic@esthavic.com.br

Goias, Tocantins e Distrito Federal
Carlos A. Fedato
62 3095.2005 fedato@terra.com.br

Maranhão e Pará
Saragão Representações Ltda
91 3235-0680 sumapa@uol.com.br

Mato Grosso e Mato Grosso do Sul
Enoch Representações
67 3382.6788 enochcom@terra.com.br

Minas Gerais
Pro-Mar Representações
31 3332.9411 promarbh@promarbh.com.br

Paraná e Santa Catarina
HSW Representações
44 3025.5990 hsw@hsw.ind.br

Pernambuco, Paraíba e Rio Grande do Norte
Mano Representações
81 3075.4982 vendas@manorepresentacoes.com.br

Rio Grande do Sul
Rozane's Representações
51 3428.6575 rozanez@terra.com.br

Rio de Janeiro
Ricser Representações
21 2215.2164 rioconsultor@terra.com.br

Rondônia e Acre
Valdez Com. e Repr. Ltda
69 3441.3878 contato@valdez.com.br

São Paulo Capital e Grande São Paulo
Empatia Representações
11 2358.2129 empatiarep@yahoo.com.br

São Paulo Interior
Agea Representações
19 3212.1287 agearepres@uol.com.br





Peças Automotivas | *Automotive Parts*

2013/14

www.unifap.com.br



UNIFAP INDÚSTRIA METALÚRGICA LTDA

Rua João Barbieri, 605 - Bairro Barracão
Gaspar - SC | Brasil | CEP: 89110-000
fone / fax 55 47 3332.8383 / 8179
unifap@unifap.com.br