

Hunter®

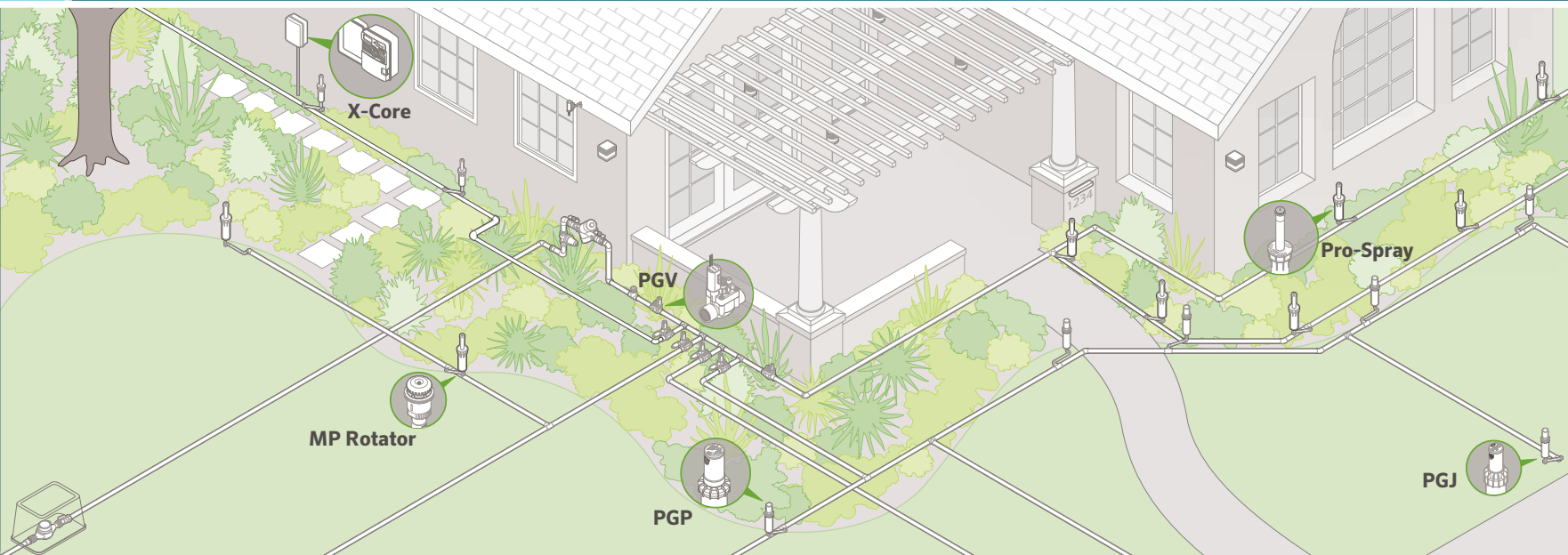

X-CORE[®]

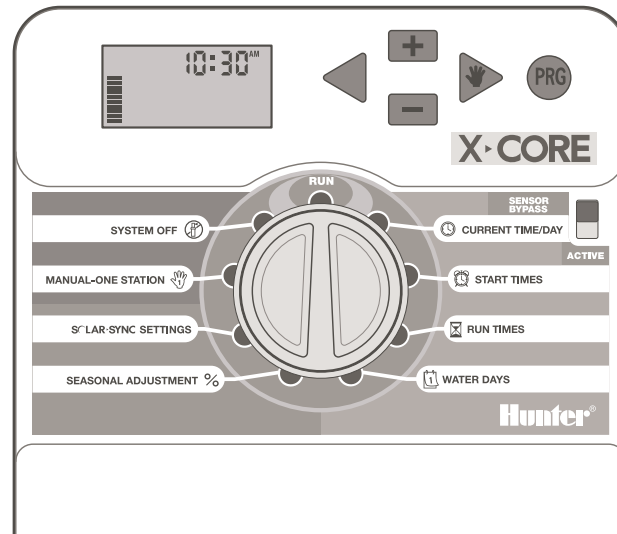

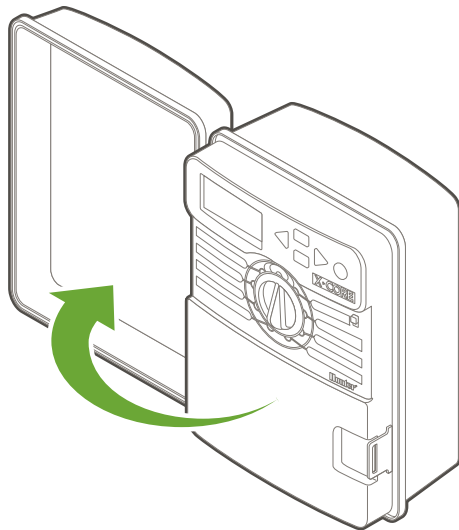
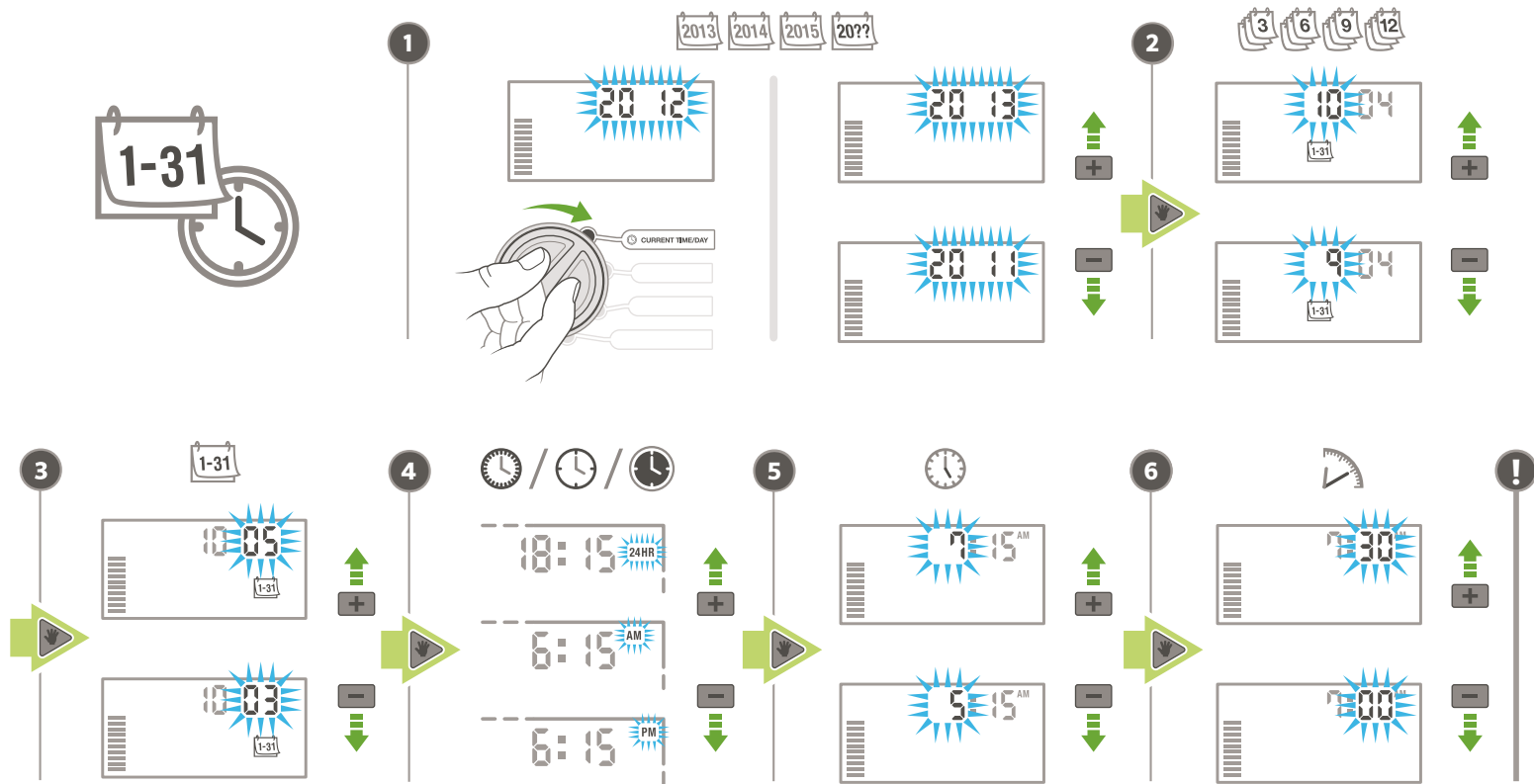

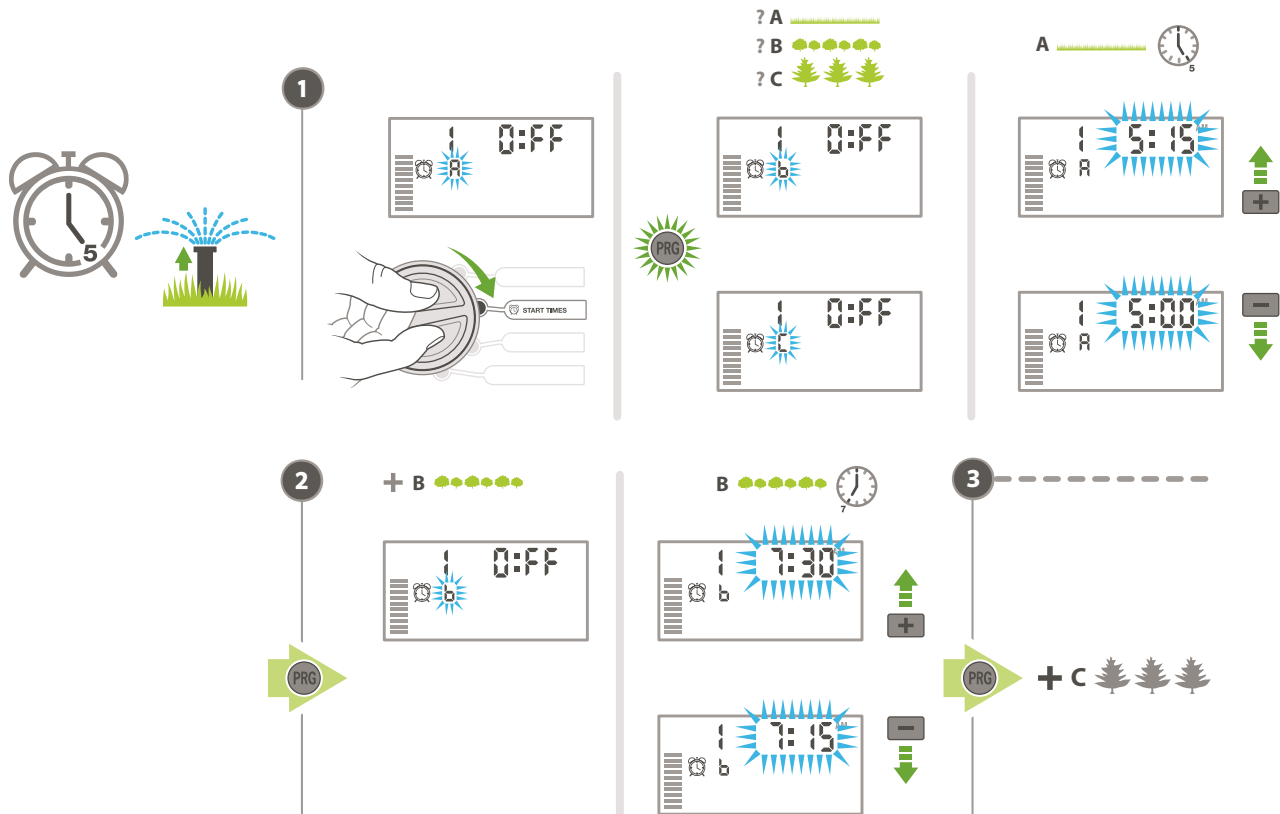

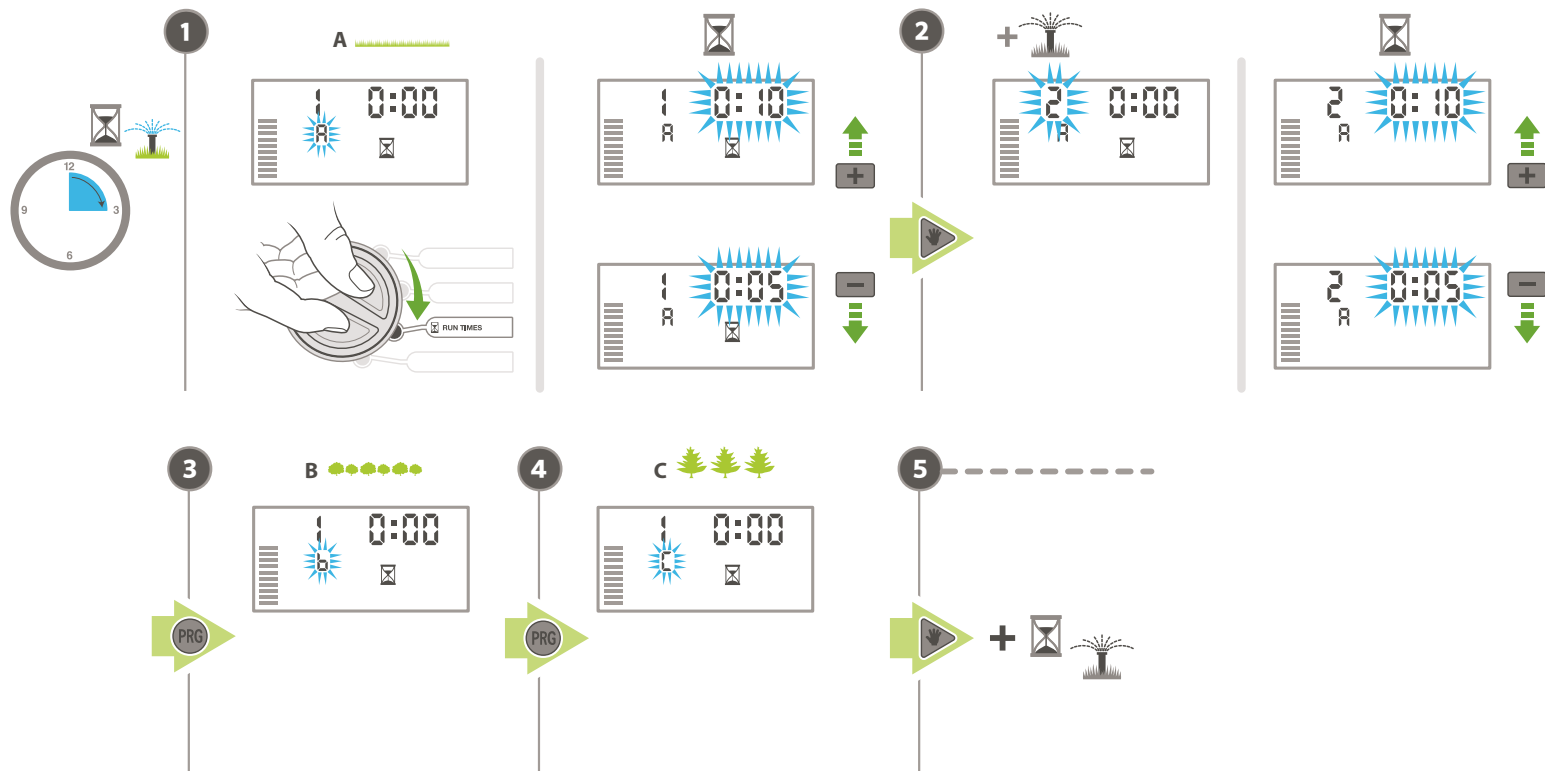

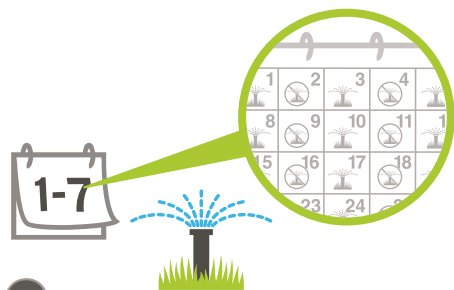

1

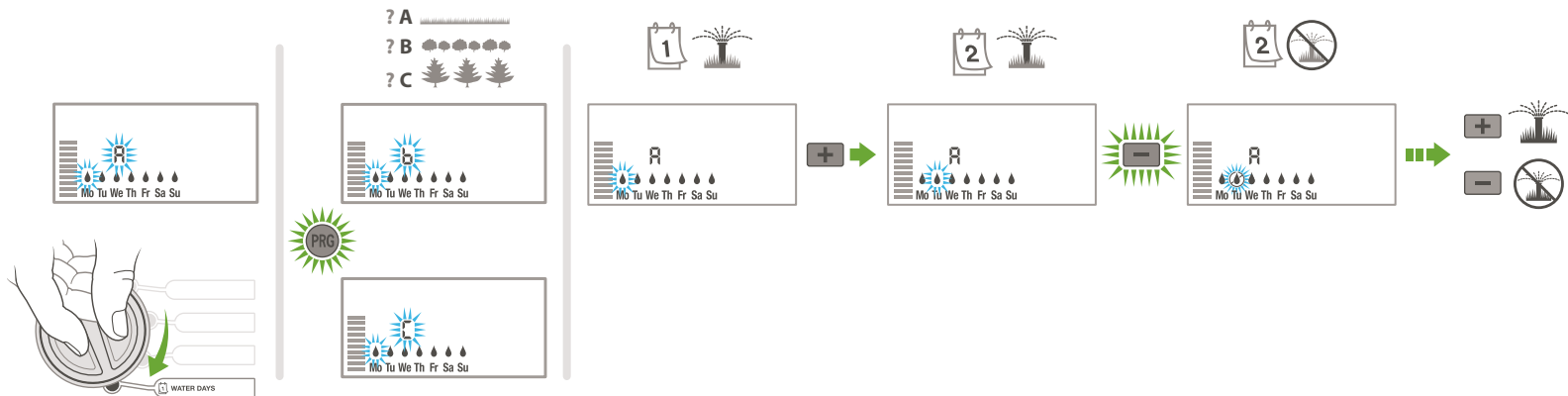

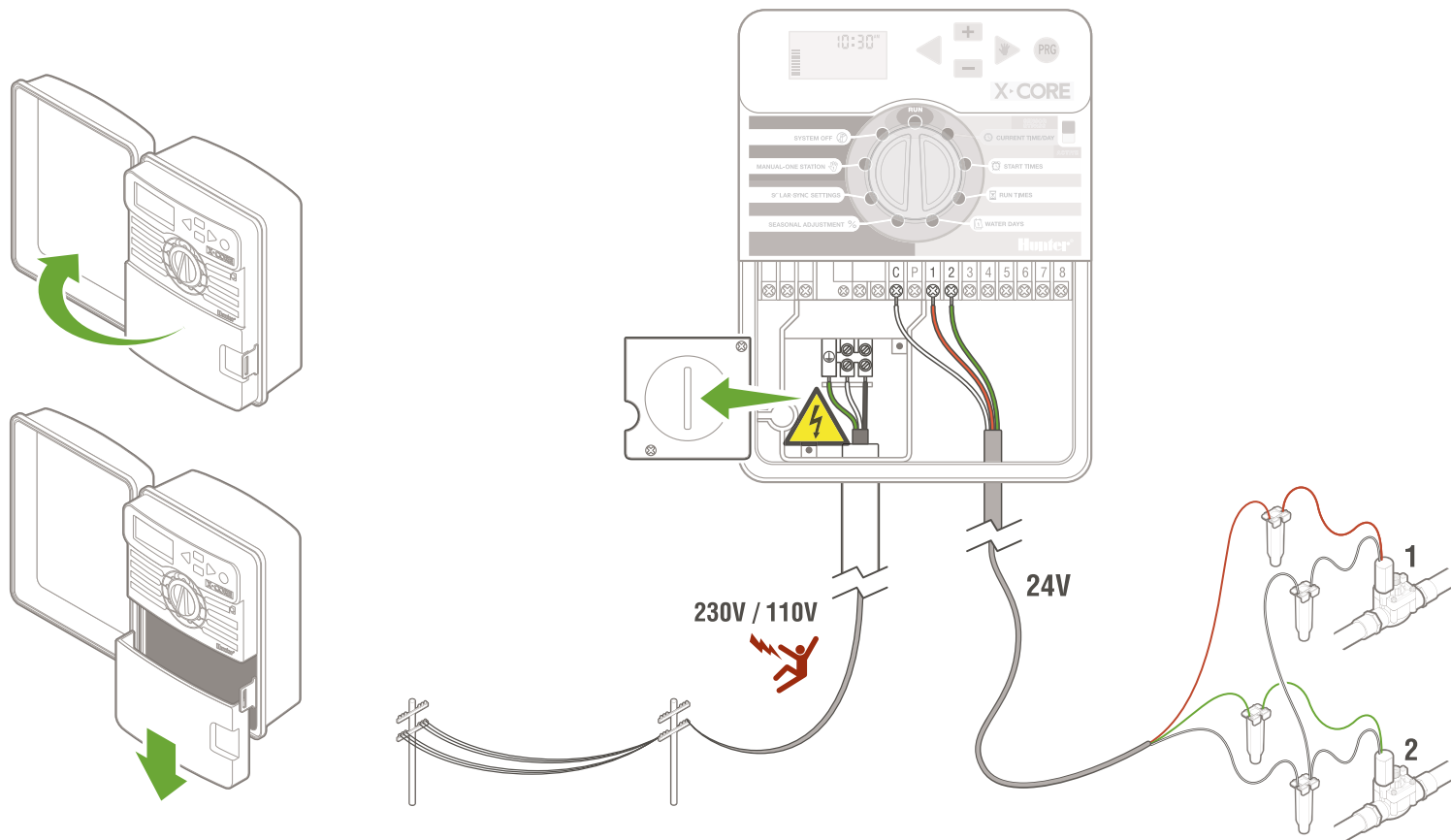

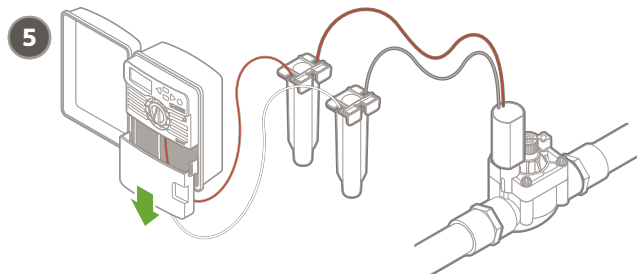
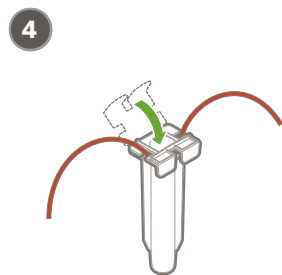
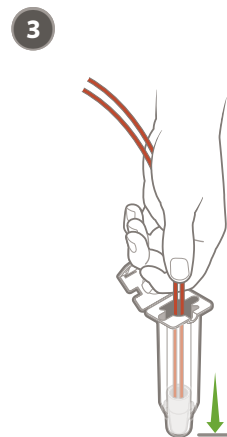
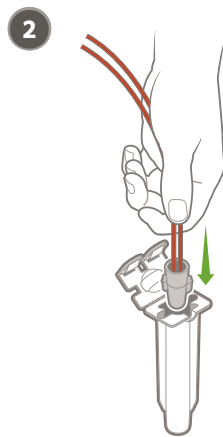
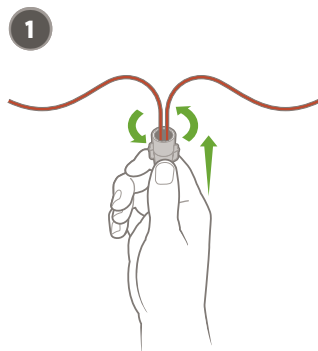
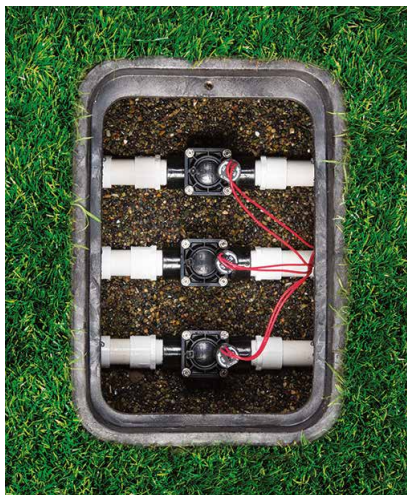

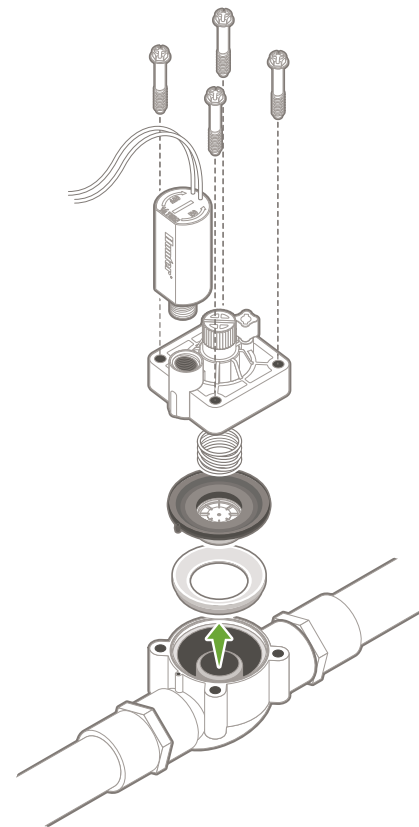
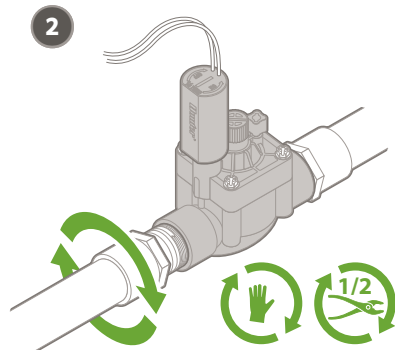
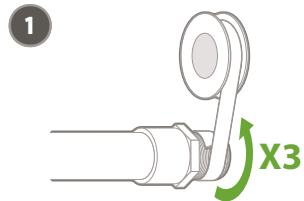
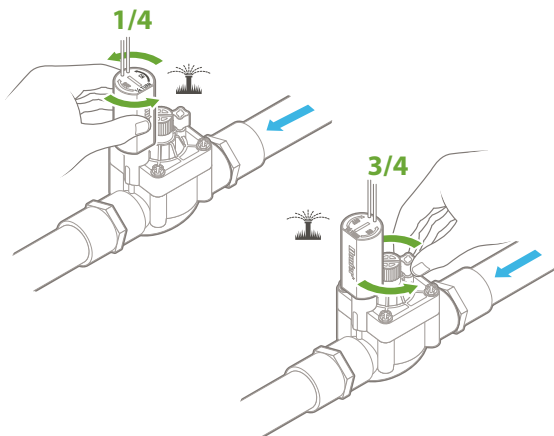
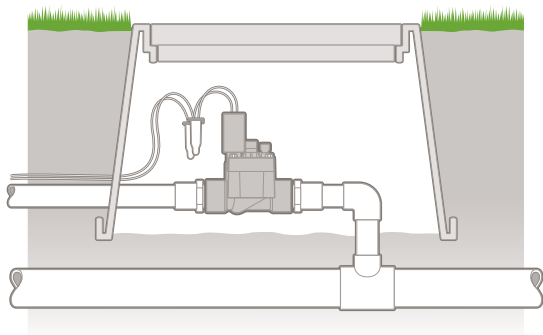

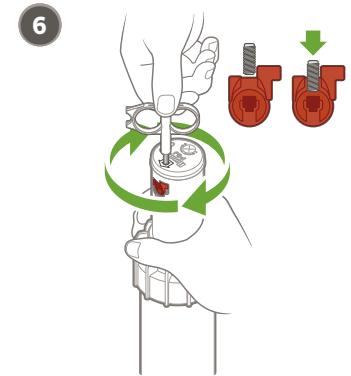
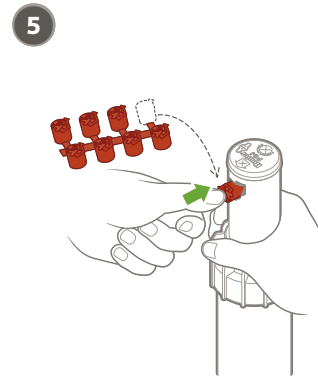
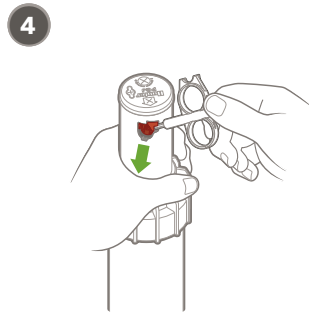
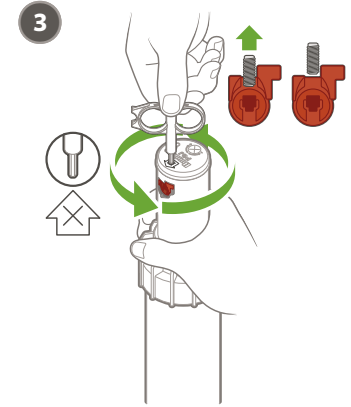
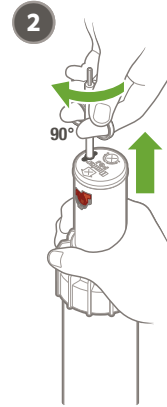
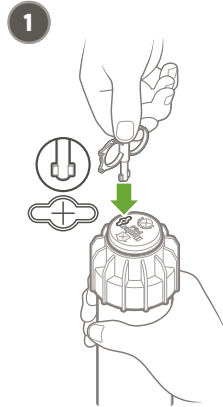

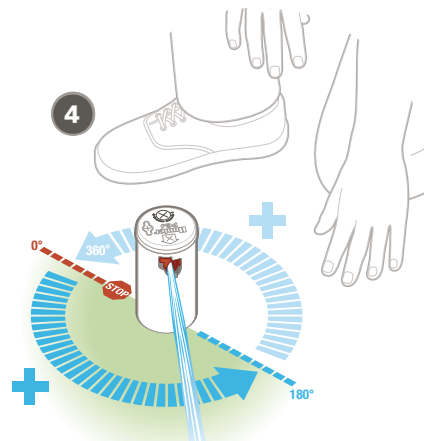
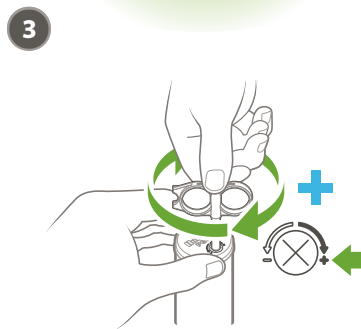
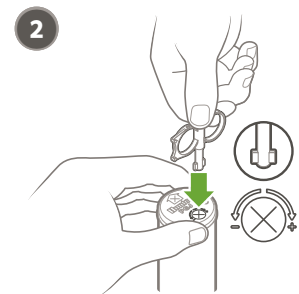
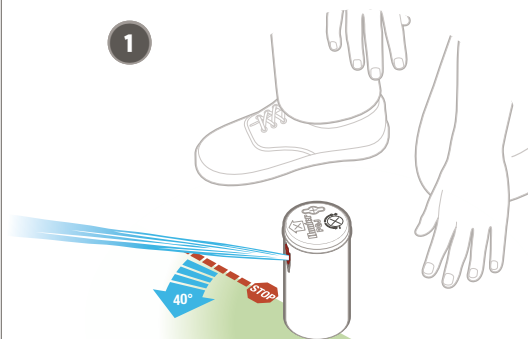
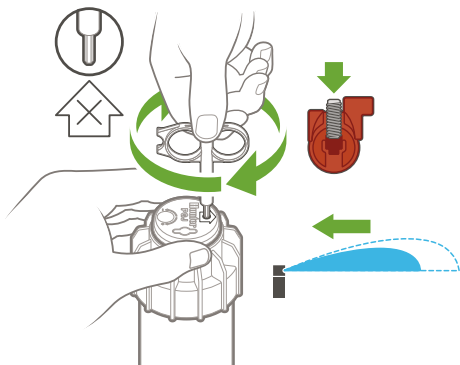
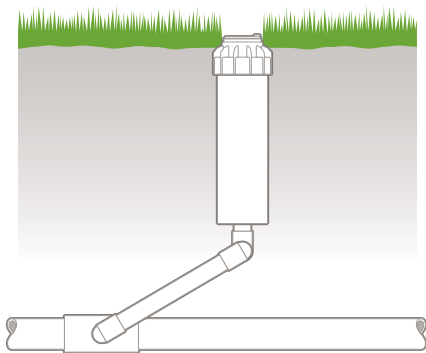



.75



1.7-3.8 Bar
170-380 kPa
30-50 PSI



2.2-3.4 l/m
0.6-0.9 GPM



4.6 m-5.2 m
(15'-17')



1.0



1.7-3.8 Bar
170-380 kPa
30-50 PSI



3.0-4.2 l/m
0.9-1.1 GPM



5.5 m-5.8 m
(18'-19')



1.5



1.7-3.8 Bar
170-380 kPa
30-50 PSI



4.5-6.7 l/m
1.3-1.7 GPM

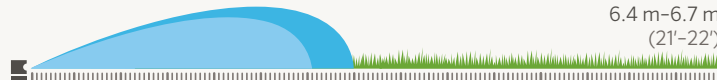

6.4 m-6.7 m
(21'-22')



2.0



1.7-3.8 Bar
170-380 kPa
30-50 PSI



5.6-9.3 l/m
1.7-2.3 GPM



7.3 m-7.6 m
(24'-25')



2.5



1.7-3.8 Bar
170-380 kPa
30-50 PSI



7.6-10.9 l/m
2.2-2.8 GPM

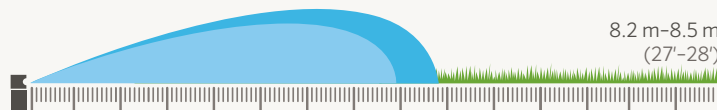

3.0



1.7-3.8 Bar
170-380 kPa
30-50 PSI



8.5-13.7 l/m
2.5-3.4 GPM

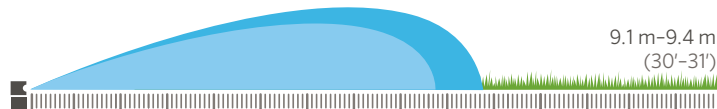

4.0



1.7-3.8 Bar
170-380 kPa
30-50 PSI



13.3-16.7 l/m
3.7-4.3 GPM

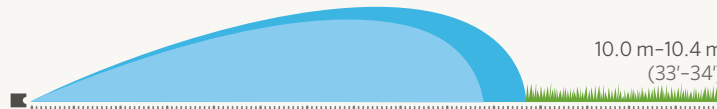

5.0



1.7-3.8 Bar
170-380 kPa
30-50 PSI



17.0-20.5 l/m
4.7-5.3 GPM





PGP-ADJ



1

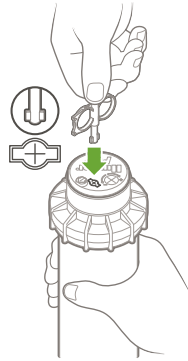

2

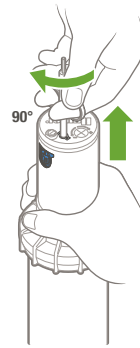

3

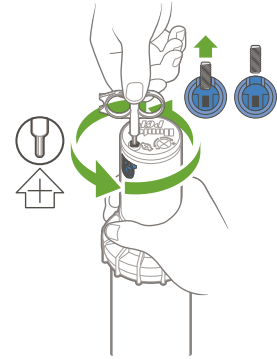

4

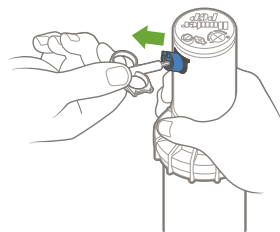

5

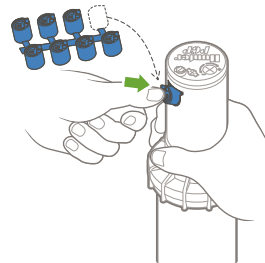

6

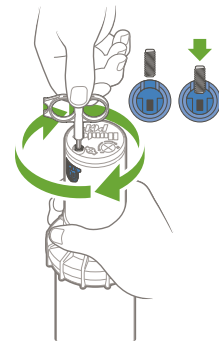

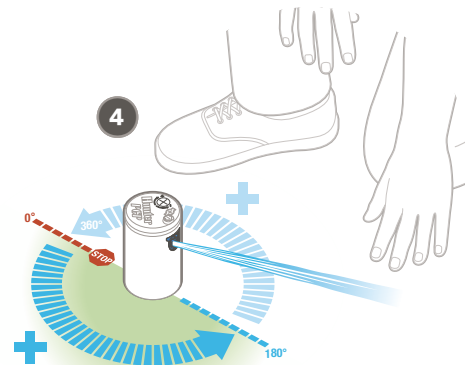
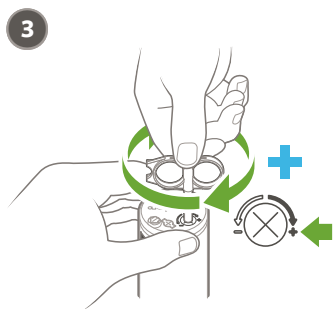
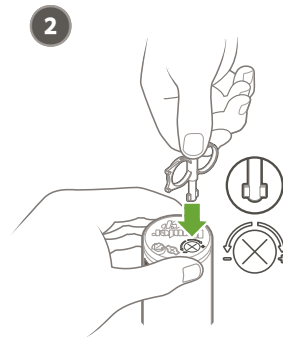
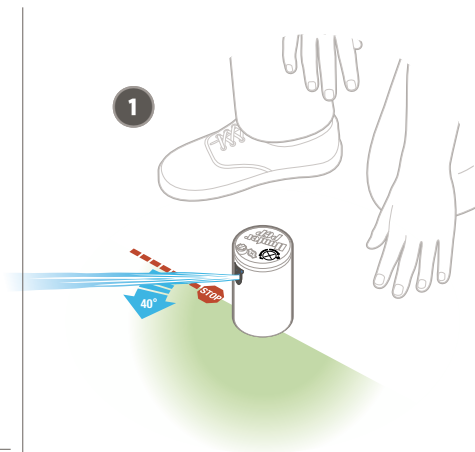
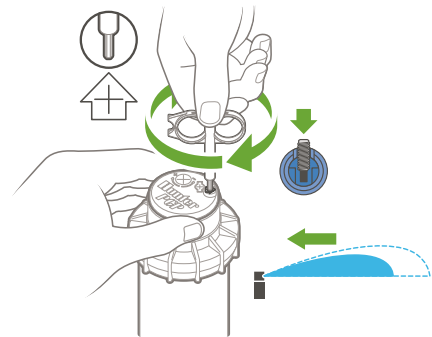
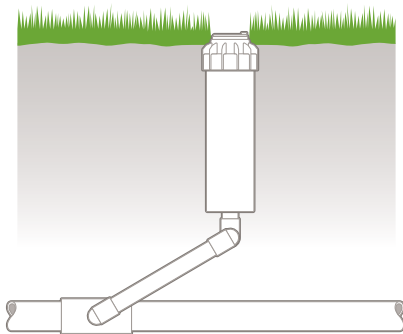



1.5



1.7-4.5 Bar
170-450 kPa
25-65 PSI



4.5-7.2 l/m
1.2-1.9 GPM

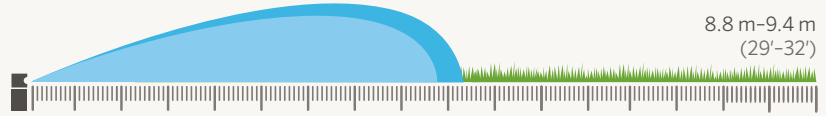

8.8 m-9.4 m
(29'-32')



2.0



1.7-4.5 Bar
170-450 kPa
25-65 PSI



5.4-8.8 l/m
1.4-2.3 GPM

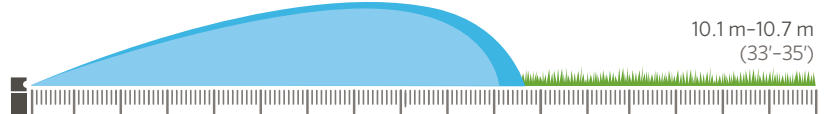

10.1 m-10.7 m
(33'-35')



2.5



1.7-4.5 Bar
170-450 kPa
25-65 PSI



6.6-11.1 l/m
1.7-2.9 GPM

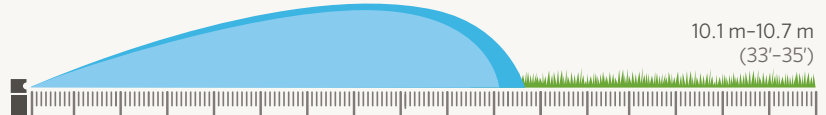

10.1 m-10.7 m
(33'-35')



3.0



1.7-4.5 Bar
170-450 kPa
25-65 PSI



8.4-14.0 l/m
2.2-3.7 GPM

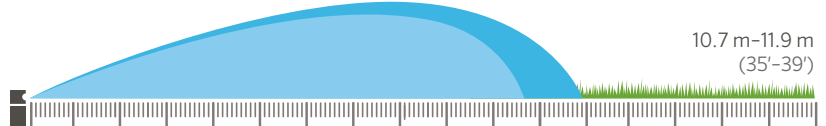

10.7 m-11.9 m
(35'-39')



4.0



1.7-4.5 Bar
170-450 kPa
25-65 PSI



11.3-18.3 l/m
3.0-4.8 GPM

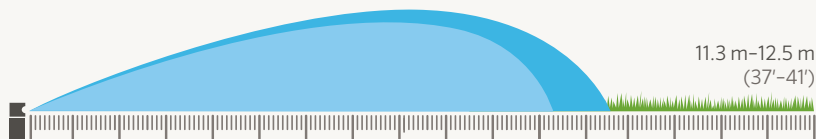

5.0



1.7-4.5 Bar
170-450 kPa
25-65 PSI



14.0-23.4 l/m
3.7-6.2 GPM

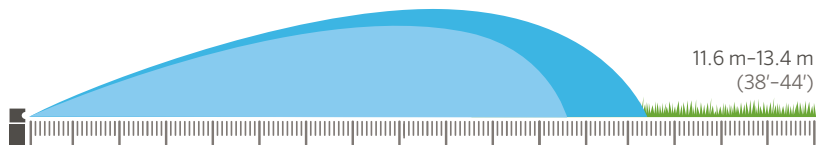

6.0



1.7-4.5 Bar
170-450 kPa
25-65 PSI



16.8-27.9 l/m
4.3-7.3 GPM

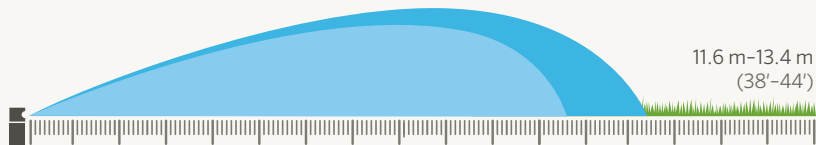

8.0



1.7-4.5 Bar
170-450 kPa
25-65 PSI



22.5-36.9 l/m
6.0-9.8 GPM

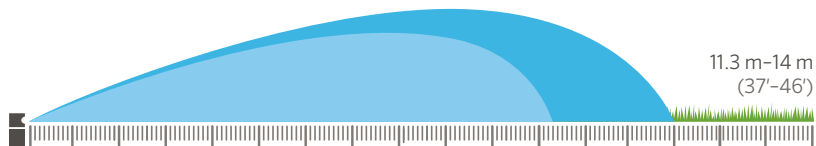

MP ROTATOR[®]



1

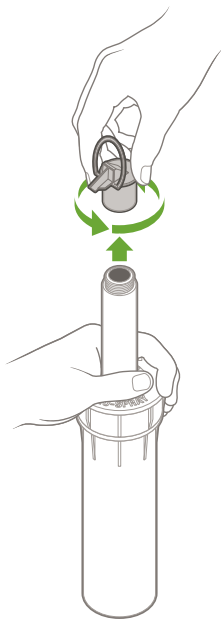

2

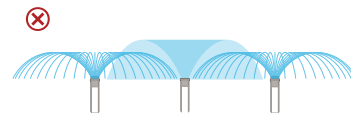
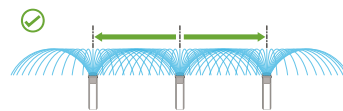
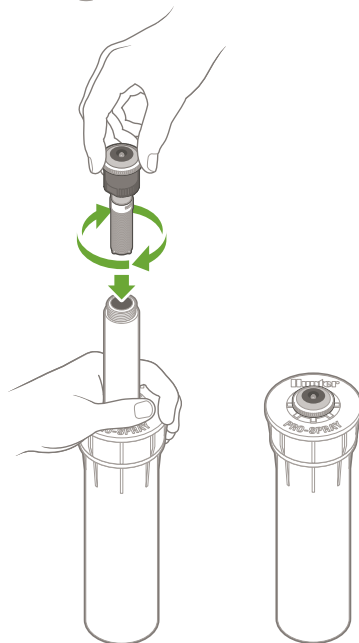

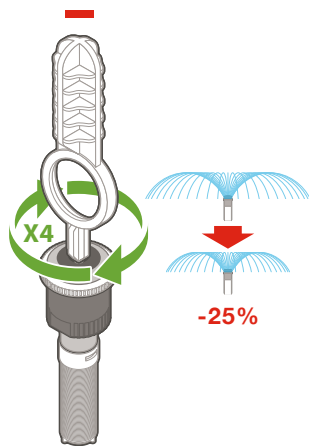
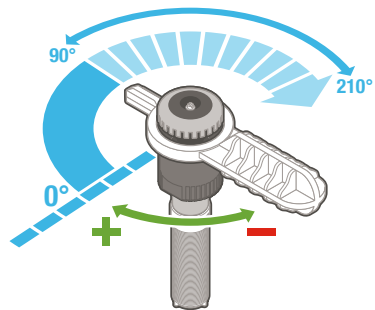

90°-210°



210°-270°



360°



MP800SR90



MP800SR360



MP800SR



MP100090



MP1000210



MP1000360



MP1000



MP200090



MP2000210



MP2000360



MP2000

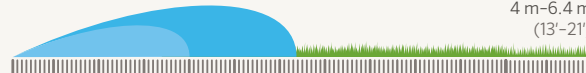

MP300090



MP3000210



MP3000360



MP3000



MP350090



MP3500



PS ULTRA / PRO-SPRAY®



1

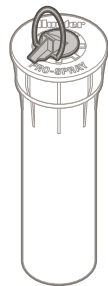

2

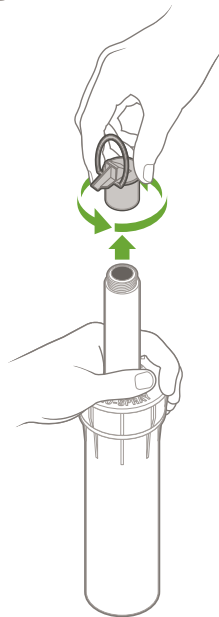

3

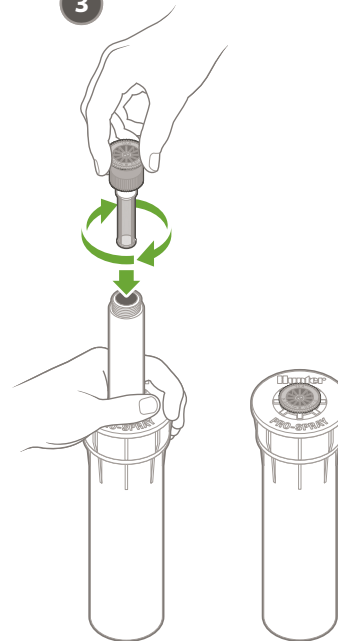

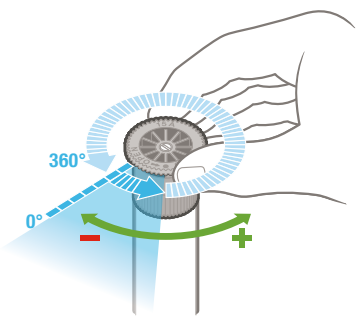
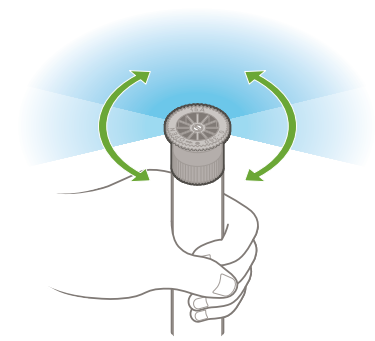
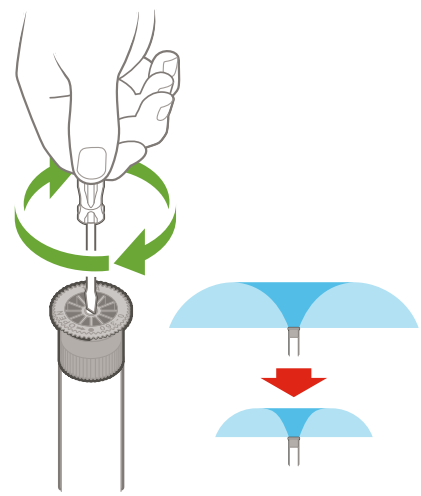
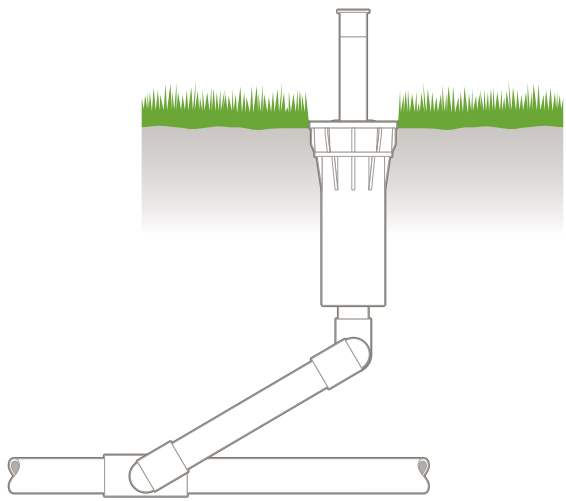



10A



1.0–3.0 Bar
100–300 kPa
20–40 PSI



0.7–9.5 l/m
0.2–2.3 GPM



2.6–3.5 m
(9'–11')



12A



1.0–3.0 Bar
100–300 kPa
20–40 PSI



0.7–13.4 l/m
0.3–3.4 GPM



3.2 m–4.1 m
(11'–13')



15A



1.0–3.0 Bar
100–300 kPa
20–40 PSI



1.3–18.0 l/m
0.4–4.5 GPM



4.0 m–5.2 m
(14'–17')



17A



1.0–3.0 Bar
100–300 kPa
20–40 PSI



1.7–21.7 l/m
0.5–5.5 GPM



4.6 m–5.8 m
(16'–19')

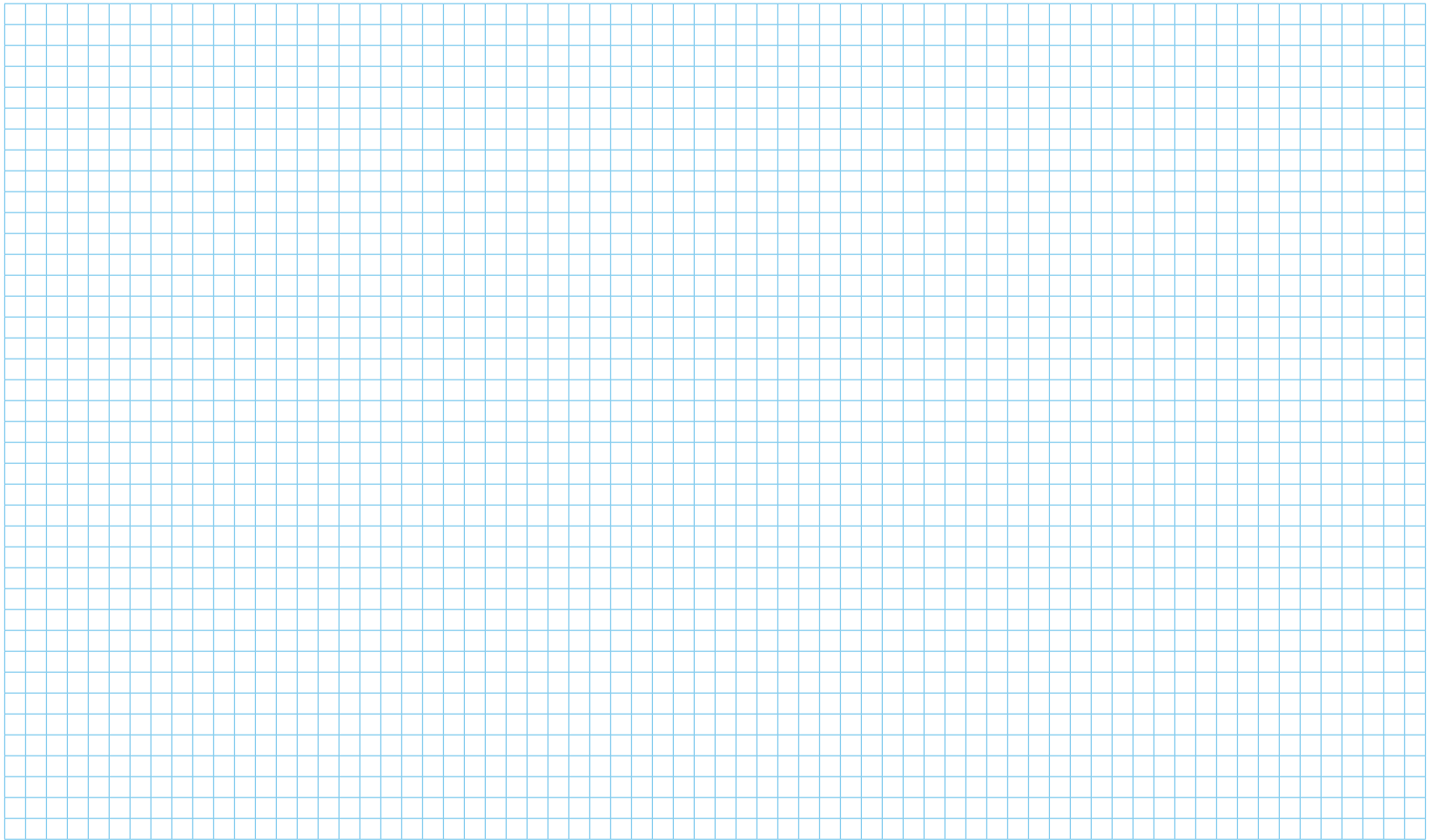

Hunter[®]

