

OWNER'S MANUAL

XPLORER

XR 500

XRT 500

XR 500 EPS

XRT 500 EPS

XR 500 LE

XRT 500 LE



READ THIS MANUAL CAREFULLY!

It contains important safety information.

**This vehicle should not be operated by those
under 16 years of age.**

Dear customer:

Our ATV is manufactured under a strict quality control system. Separate documents supplied to the dealer provide information on Product Warranty and Emissions Warranty. Failure to follow instructions for emission parts replacement may violate U.S. Federal Law (40 CFR part 1068.105 (b)) and be subject to fines and other penalties as described in the Clean Air Act.

The use of non-Original Equipment Manufacturer (OEM) approved parts may void the vehicle warranty. Catastrophic damage to the drivetrain components due to excessive speed may result from driving the vehicle above specified speed. Damage caused by excessive speed may cause a loss of vehicle control, is costly, is considered abuse and will not be covered under the warranty.

This warranty excludes:

1. Using unspecified engine oil.
2. Improper maintenance or repairs.
3. Using non-original or modified accessories and parts.
4. Operating the vehicle improperly without regard for instructions in the owner's manual.
5. Normal wear and tear items: seat, spark plug, bulbs, wires, filters, battery, brakes, belt, chain, sprockets, tires ... etc.

- ◆ Before you operate your new ATV, We highly recommend these important points:
- ◆ Read your Owner's Manual.
- ◆ A child under 16 years old should not operate an ATV with an engine size greater than 90 cc.
- ◆ Take the training course before your operate ATV, ask your dealer for information.
- ◆ This ATV is designed for one person only.

CALIFORNIA Proposition 65 Warning

WARNING: Motor vehicles may contain fuels, oils and fluids, battery posts, terminals and related accessories which contain lead and lead compounds and other chemicals identified by the State of California to potentially cause cancer, birth defects, and other reproductive harm. These chemicals are found in vehicles, vehicle parts and accessories, both new and replacements. During maintenance, these vehicles generate used oil, waste fluids, grease, fumes and particulates, all identified by the State of California to potentially cause cancer, birth defects, and other reproductive harm.

Never modify the vehicle in any way that will alter the weight distribution of the vehicle, decrease its stability or increase the speed beyond the factory specifications. Such modifications can cause serious personal injury or death. The manufacturer prohibits and disclaims responsibility for any such modifications or any other alteration which would adversely affect the safety of the vehicle. The vehicle manufacturer reserves the right to incorporate engineering and design changes to products in this manual, without obligation to include these changes on units sold previously.

The information contained in this manual may be revised periodically by the manufacturer, and therefore is subject to change without notice.

The manufacturer **DISCLAIMS LIABILITY FOR ERRORS IN THIS MANUAL**, and **SPECIFICALLY DISCLAIMS LIABILITY FOR INCIDENTAL AND CONSEQUENTIAL DAMAGES** resulting from the use of the information and material in this manual.

NAME: _____

ADDRESS: _____

TELEPHONE: _____

PURCHASE DATE: _____ mm/dd/yyyy

ATV MODEL: _____

FRAME NO: _____

ENGINE NUMBER: _____

KEY NUMBER: _____

INTRODUCTION

Read this manual carefully before operating this vehicle. This manual should stay with vehicle if it is sold. This manual will provide you with a good basic understanding of the features and operation of this ATV. This manual includes important safety information. It provides information about special techniques and skills necessary to ride the ATV. It also includes basic maintenance and inspection procedures. If you have any questions regarding the operation or maintenance of your ATV, please consult dealer.

AN IMPORTANT SAFETY MESSAGE:

- ◆ Read this manual carefully and completely before operating your ATV. Make sure you understand all instructions.
- ◆ For Type 1 ATVs, Category G (general Use Model) ATV. An ATV intended for recreational and/or utility use by an operator age 16 or older.
- ◆ Pay attention to the warning and notice labels on the ATV.
- ◆ Never operate an ATV without proper training or instruction. For a training course, please consult a dealer.
- ◆ This ATV is designed for a single rider, do not carry a passenger.

IMPORTANT MANUAL INFORMATION

FAILURE TO FOLLOW THE WARNINGS CONTAINED IN THIS MANUAL CAN RESULT IN SERIOUS INJURY OR DEATH.

Particularly important information is distinguished in this manual by the following notations:

	This is safety alert symbol. It is used to alert you to potential personal injury hazards. Obey all safety messages that follow this symbol to avoid possible injury or death.
WARNING!	Indicates a hazardous situation that, if not avoided, could result in death or serious injury.
CAUTION!	Indicates special precautions that must be taken to avoid damage to the vehicle or other property.
NOTE	Provides key information to make procedures easier or clearer.

* Product and specifications are subject to change without notice.

IMPORTANT NOTICE

This ATV is designed and manufactured for off-road use and single rider. It is illegal and unsafe to operate this ATV on any public street, road or highway.

This ATV complies with all applicable off-road noise level and spark arrester laws and regulations in effect at the time of manufacture.

Please check your local riding laws and regulations before operating this ATV.

TABLE OF CONTENTS

SPECIFICATIONS	8
IMPORTANT IDENTIFICATION NUMBERS.....	10
LOCATION OF THE WARNING AND SPECIFICATION LABELS	11
SAFETY INFORMATION	16
PRE-OPERATION CHECKS.....	18
VEHICLE CONTROLS	20
INSTRUMENT AND CONTROL FUNCTION	21
IGNITION SWITCH FUNCTION / POSITION.....	21
SIGNS AND FUNCTIONS.....	21
STARTING THE ENGINE	21
FOUR WHEEL BRAKE LEVER (WITH PARKING BRAKE)	22
REAR BRAKE PEDAL.....	22
SHIFT LEVER.....	23
SHIFT LEVER INSTRUCTIONS:.....	23
2WD/4WD/LOCK SWITCH	24
2WD/4WD/LOCK SWITCH:.....	24
2WD/4WD	24
4WD/LOCK	25
TIRES.....	27
TIRE PRESSURE	27
TIRE WEAR LIMIT.....	27
TIRE INFORMATION	27
AFTER MARKET TIRES AND RIMS.....	28
COOLANT	28
CHECKING THE COOLANT LEVEL.....	28
CHANGING THE COOLANT.....	29
RECOMMENDED ANTIFREEZE:.....	30
COOLANT QUANTITY:.....	30
STEERING LOCK	30
SPEEDOMETER	30
PANEL DESCRIPTIONS	30
FUNCTIONS.....	31
BUTTON OPERATIONS	32
MODE BUTTON.....	32
RESET FUNCTION	32
TIME FUNCTION	32
EPS (ELECTRIC POWER STEERING) FUNCTION	33
SPARK PLUG	33
REMOVING THE SPARK PLUG	33

CHECKING THE SPARK PLUG.....	33
INSTALLING THE SPARK PLUG	33
AIR CLEANER.....	34
ENGINE OIL AND OIL FILTER.....	35
CHECKING THE ENGINE OIL LEVEL.....	35
CHANGING THE ENGINE OIL (WITH OR WITHOUT OIL FILTER REPLACEMENT)	36
DIFFERENTIAL GEAR OIL.....	37
CHANGING THE DIFFERENTIAL GEAR OIL (FRONT DIFFERENTIAL).....	37
DRAIN BOLT	37
FILLER BOLT	37
CHECK BOLT	37
FINAL GEAR OIL (REAR DIFFERENTIAL)	38
CHECKING THE FINAL GEAR DRIVE OIL	38
CHANGING THE FINAL GEAR OIL (REAR DIFFERENTIAL).....	39
SEAT.....	39
STORAGE COMPARTMENTS.....	40
BATTERY AND FUSES.....	40
TO REMOVE THE BATTERY.....	40
TO CHARGE THE BATTERY.....	41
TO STORE BATTERY.....	41
TO INSTALL THE BATTERY	41
FUSES.....	41
REPLACING A FUSE.....	42
REPLACING A HEADLIGHT BULB	43
ADJUSTING A HEADLIGHT BEAM	43
REPLACING THE TAIL/ BRAKE LIGHT BULB	43
AUXILIARY DC JACK.....	44
PRECAUTION OF ATV RIDING	45
RIDE WITH CARE.....	45
APPAREL	46
PRE-OPERATION CHECKS.....	47
LOADING AND ACCESSORIES	47
MAXIMUM LOADING LIMIT.....	47
DURING OPERATION	48
MODIFICATIONS AND ACCESSORIES	48
EXHAUST SYSTEM.....	48
CLEANING THE SPARK ARRESTER.....	49
TURNING YOUR ATV.....	50
CLIMBING UPHILL	51
RIDING DOWN HILL.....	53
CROSSING A SLOPE	54

CROSSING THROUGH SHALLOW WATER.....54
RIDING OVER ROUGH TERRAIN55
SLIDING AND SKIDDING.....55
WHAT TO DO.....56
PERIODIC MAINTENANCE.....57
CLEANING AND STORAGE.....60
STORAGE60
TROUBLE SHOOTING.....62
MAINTENANCE RECORD.....64
CONSUMER INFORMATION.....66
IDENTIFICATION NUMBER.....66
KEY IDENTIFICATION NUMBER:66
VEHICLE IDENTIFICATION (FRAME) NUMBER:.....66
KEY IDENTIFICATION NUMBER66
WARRANTY STATEMENT:67

SPECIFICATIONS

		Xplore XR	Xplore XRT	
Overall Length		2155/84.8	2360/92.9	[mm/inch]
Overall Width		1235/48.6	1235/48.6	[mm/inch]
Overall Height		1250/49.2	1250/49.2	[mm/inch]
Wheel Base		1280/50.4	1450/57.1	[mm/inch]
Type		4-Stroke Engine		
Installation and arrangement		Vertical, below center, incline		
Fuel Used		87 Octane		
Cycle/Cooling		4-stroke/Water cooled		
Cylinder	Bore	Ø 92/3.62		[mm/inch]
	Stroke	75.6/2.97		[mm/inch]
	Number/ Arrangement	Single Cylinder		
Displacement		503		[cc]
Compression Ratio		10.2+/-0.5		
Max. Power / RPM		28.9 / 5500		[kw/rpm]
Max. Torque / RPM		46.1 / 5500		g[Nm/rpm]
Ignition		ECU		
Starting System		Electrical starter		
Air filtration		Sponge		
Suspension System	Front	Double A-Arm		
	Rear	Double A Arm		
Tire Specifications	Front	25X8-12		
		26X8-14		
	Rear	25X10-12		
		26X10-14		
Rim		Aluminum / Steel		
Brake System	Front	Disk (Ø 200/7.8)		[mm/inch]
	Rear	Disk (Ø 180/7.08)		[mm/inch]
Performance	Climb Ability	< 25		
Reduction	Primary Reduction	Belt		
	Secondary Reduction	Gear / Sprocket		
	Clutch	Centrifugal, dry type		
	Transmission	C.V.T., auto speed change		

Speedometer		0 ~ 300		[km/hr]
Horn		93 ~ 112		[dB/A]
Fuel capacity		16	4.2	[l/gal]
Lubrication System		Forced circulation & splashing		
Engine oil	Engine oil		SAE 10 W/ 40	
	Capacity with filter		3.85	1.0 [l/gal]
Gear lubrication	Front Differential	Spec.	SAE 85W-90	
		Capacity	350	0.09 [ml/gal]
	Rear Gear	Spec.	SAE 85W-90	
		Capacity	450	0.11 [ml/gal]
Spark Plug		NGK CR7E		
Battery		12/18		V/AH
Lamps	Front Lamps (HI/LO)		60×2	[W]
	Rear Lamps		5×1	[W]
	Brake Lamps		21×1	[W]
	Turn Lamps		10×4	[W]

This list is only for reference; the parts are according to real vehicle.
 Any modification may be done without prior notice.

IMPORTANT IDENTIFICATION NUMBERS

1. Frame Number:

Record chassis and engine number for future reference.

Number is located front right hand side of chassis as shown in (1).

2. Engine number is located front of the engine as shown in (2).

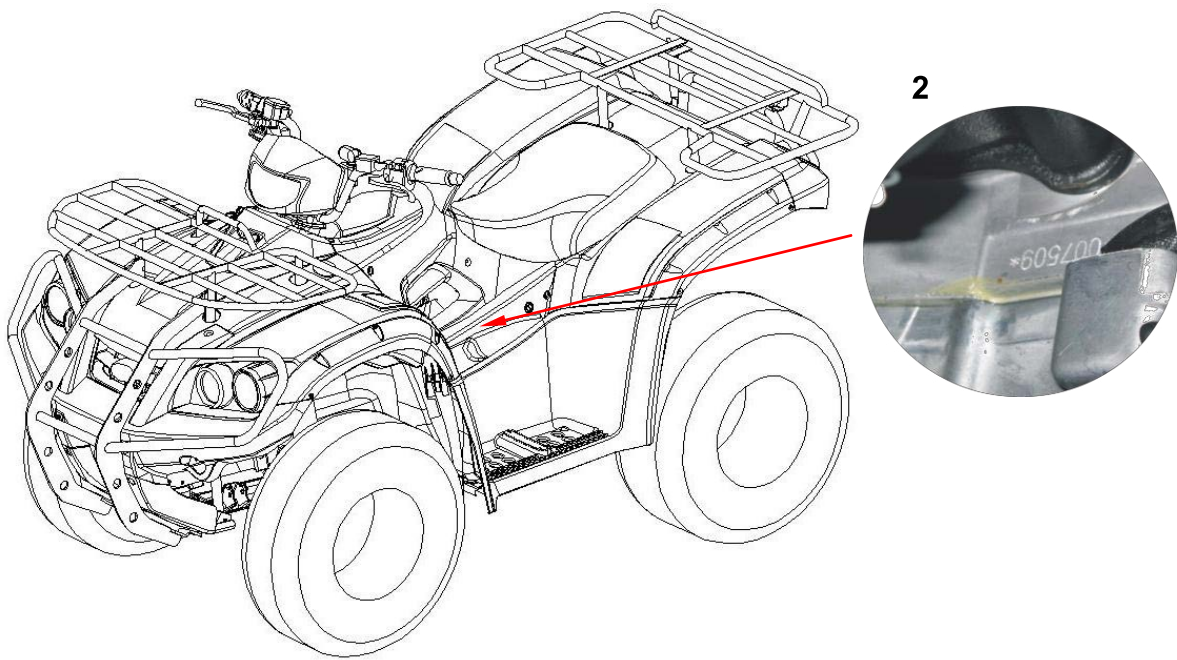
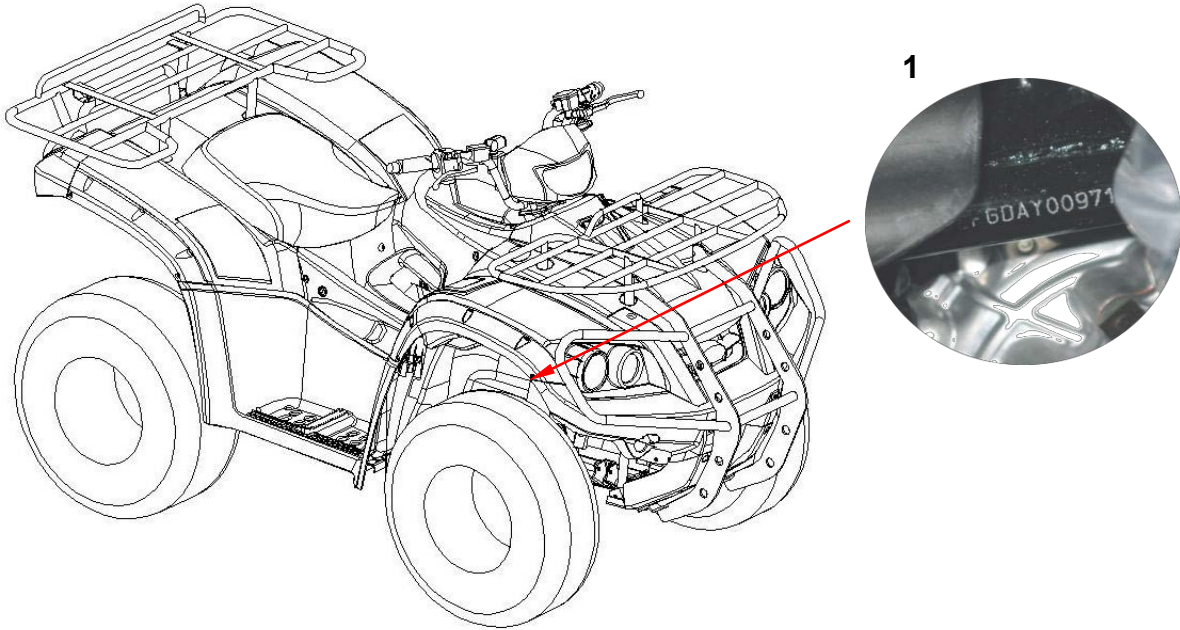

LOCATION OF THE WARNING AND SPECIFICATION LABELS

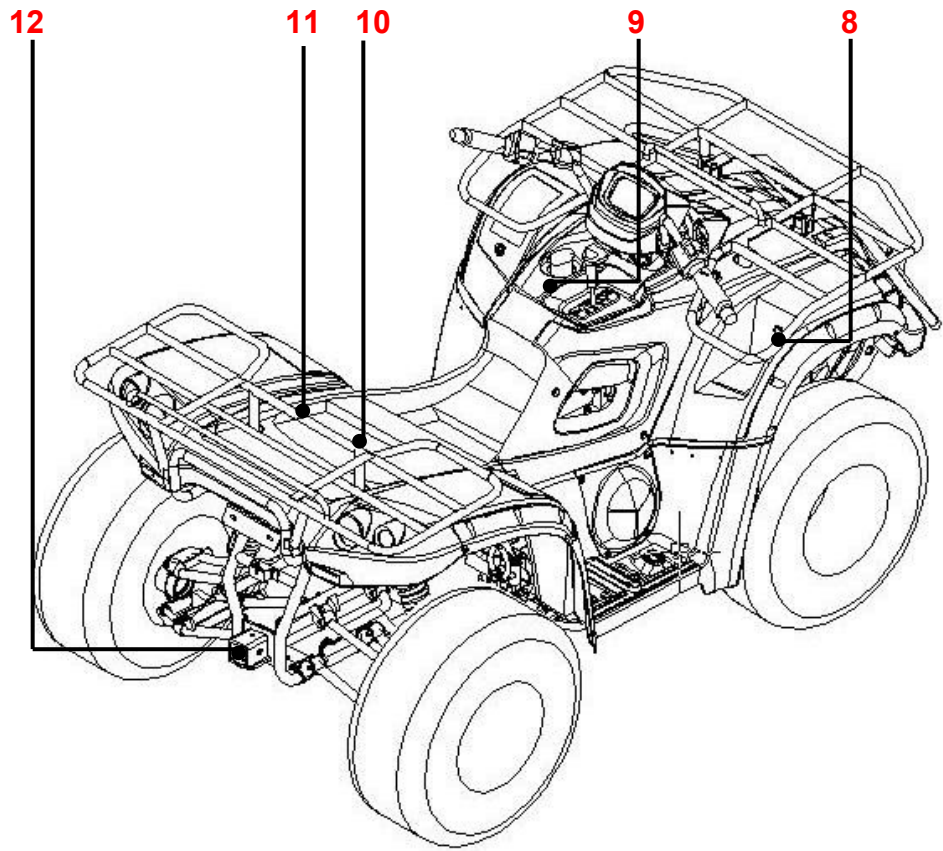
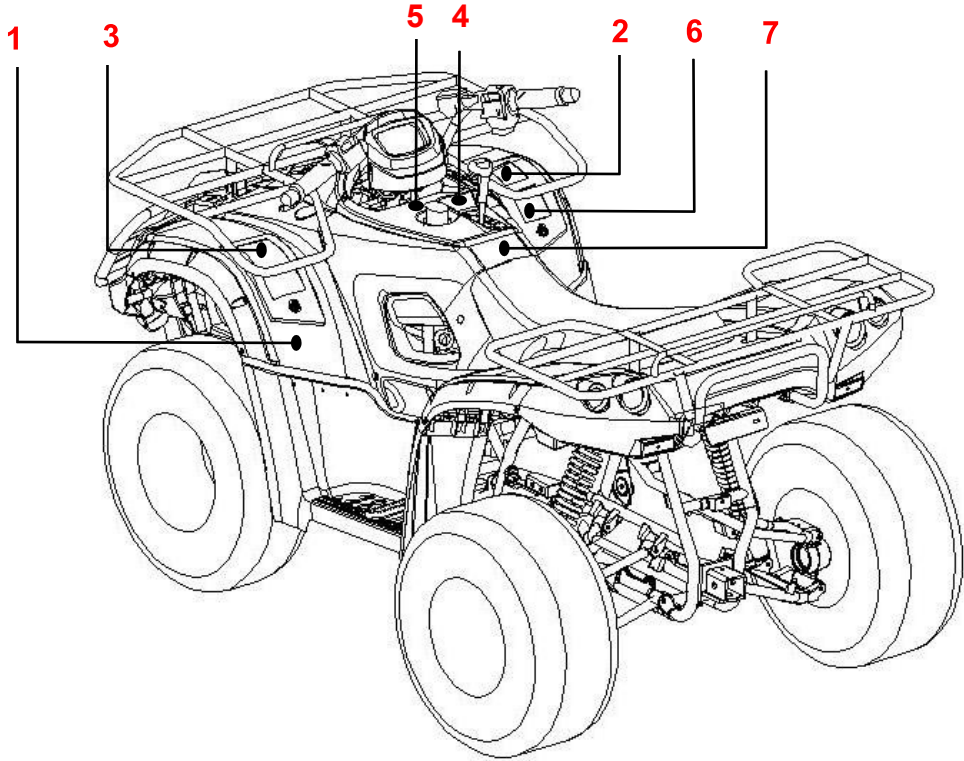

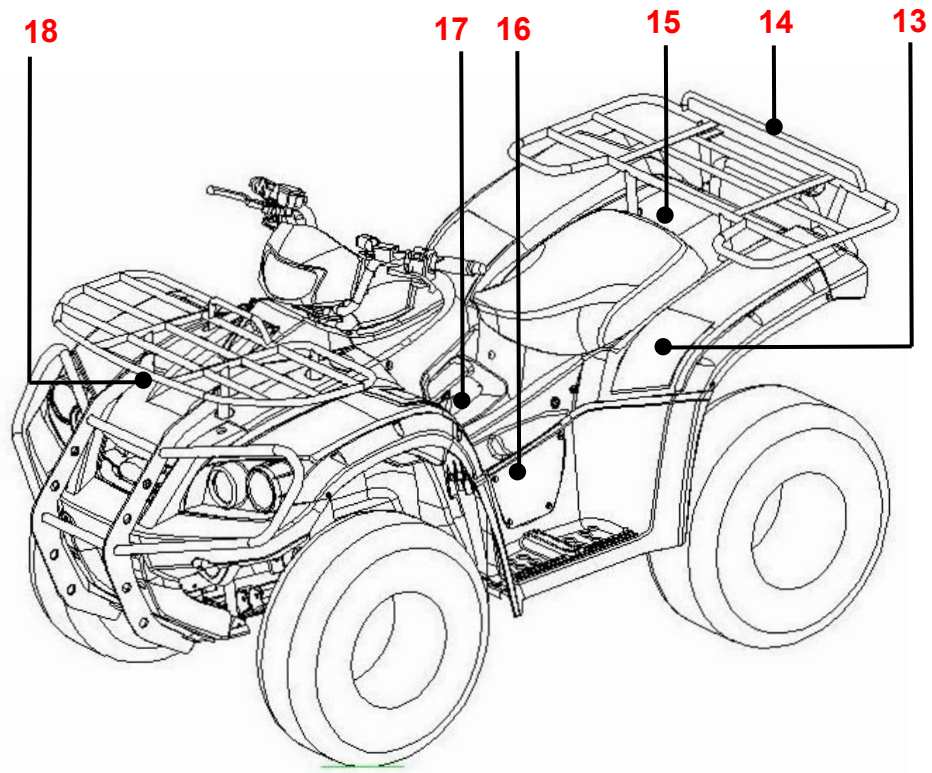

Read and understand all of the labels on your ATV. These labels contain important information for safe and proper operation.

Never remove any labels from your ATV. If a label becomes difficult to read or comes off, request a replacement label from your dealer.

⚠ WARNING

- Never operate this ATV on HILLS steeper than 25 degrees $\angle 25^\circ$. To prevent flipover on hilly terrain, when going up or down, use throttle and brakes gradually.
- REVERSE operation can be dangerous even at low speeds. Steering becomes difficult. To prevent flipover, avoid sudden braking or sharp turns.
- Use OVERRIDE for reverse speed limiter with caution. To prevent loss of control, never activate override button with open throttle.
- When this ATV is not in operation or unattended, leave shift lever in the park position.

518313

2.

⚠ WARNING

Failure to stop vehicle completely before doing the following could result in you being thrown from the ATV.

TO ENGAGE REVERSE RANGE:

- stop vehicle completely.
- shift transmission to neutral.
- apply either hand or foot brake.
- shift range lever fully to R range.

TO ENGAGE HI-LO RANGE:

- stop vehicle completely.
- bring engine to idle.
- applying brake while shifting range lever.

Hi-range: Normal riding.
Lo-range: Severe load conditions.

Refer to User's guide for more information.

518861

(1 up)

⚠ WARNING

Failure to stop vehicle completely before doing the following could result in your being thrown from the ATV.

TO engage reverse range:

- Stop vehicle completely.
- Shift transmission to neutral.
- Apply either hand or foot brake.
- Shift range lever fully to R range.

TO engage Hi-Lo range:

- Stop vehicle completely.
- Bring engine to idle.
- Shift range lever with applying brake.

TO engage parking range :

- Stop vehicle completely.
- Apply either hand or foot brake.
- Shift transmission to P.

Refer to User's guide for more information.

516761

(2 up)

3.

⚠ WARNING

Improper ATV use can result in SEVERE INJURY or DEATH.

ALWAYS USE AN APPROVED HELMET AND PROTECTIVE GEAR

NEVER USE ON PUBLIC ROADS

NEVER CARRY PASSENGERS

NEVER USE WITH DRUGS OR ALCOHOL

NEVER operate:

- without proper training or instruction.
- at speeds too fast for your skills or the conditions.
- on public roads - a collision can occur with another vehicle.
- with passengers - passengers affect balance and steering and increase risk of losing control.

ALWAYS:

- use proper riding techniques to avoid vehicle overturns on hills and rough terrain and in turns.
- avoid paved surfaces - pavement may seriously affect handling and control.

READ OWNER'S MANUAL, FOLLOW ALL INSTRUCTIONS AND WARNINGS.

514648

(1 up)

⚠ WARNING

Improper use can result in SEVERE INJURY or DEATH

ALWAYS USE AN APPROVED HELMET AND PROTECTIVE GEAR FOR DRIVER AND PASSENGER

NEVER USE ON PUBLIC ROADS

NEVER CARRY MORE THAN ONE PASSENGER

NEVER USE WITH DRUGS OR ALCOHOL

NEVER operate :

- without proper ATV training or instruction
- at speeds too fast for your skills or the conditions
- on public roads - a collision can occur with another vehicle
- with a passenger unless passenger seat is securely in place

THE OPERATOR MUST ALWAYS :

- use proper riding techniques to avoid overturns on hills and rough terrain and in turns
- avoid paved surfaces - pavement may seriously affect handling and control
- reduce speed and use extra caution at all times when carrying a passenger - dismount passenger when conditions require
- make sure passenger reads and understands this label and passenger safety label

LOCATE AND READ OPERATOR'S MANUAL. FOLLOW ALL INSTRUCTIONS AND WARNINGS

518560

(2 up)

4.



5.



6.

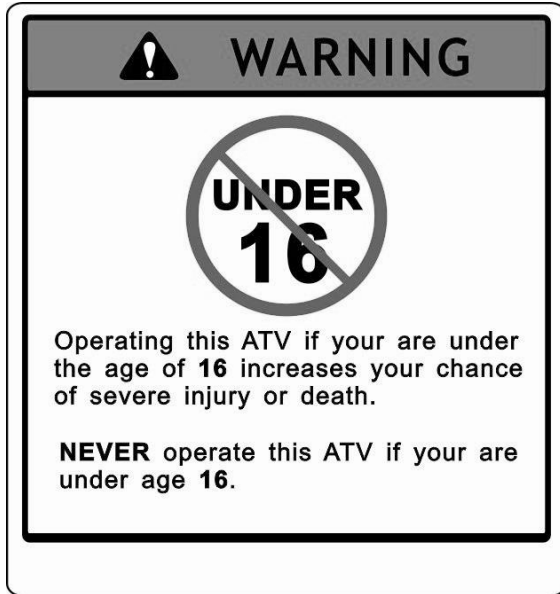

7.



8.

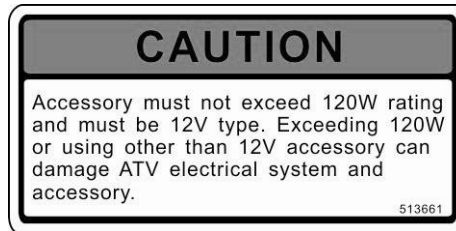

9.



10.

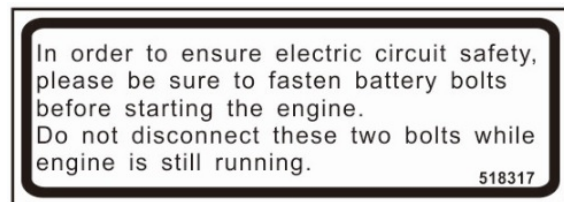

11.

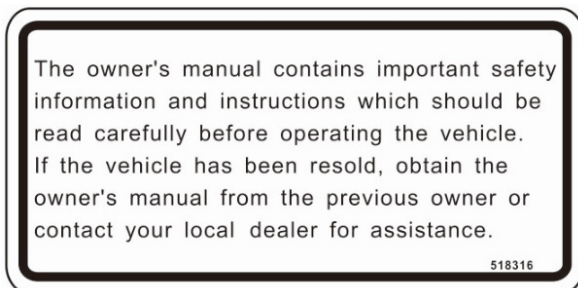

12.



SAFETY INFORMATION

AN ATV IS NOT A TOY AND CAN BE HAZARDOUS TO OPERATE

An ATV handles differently from other vehicles, including motorcycles and cars. A collision or rollover can occur quickly, even during routine maneuvers such as turning and riding on hills or over obstacles, if you fail to take proper precautions.

SEVERE INJURY OR DEATH can result if you do not follow these instructions:

- ◆ Read this manual and all labels carefully and follow the operating procedures described. Never operate an ATV without proper training or instruction. TAKE A TRAINING COURSE. Beginners should receive training from a certified instructor. Contact an authorized ATV dealer to find out about the training courses nearest you, visit www.atvsafety.org, or call 1-800-887-2887 to register for free ATV safety training. We are offering a \$100 incentive for completion of the ASI approved safety training.
- ◆ FOR MORE INFORMATION ABOUT ATV SAFETY in the United States, call the Consumer Product Safety Commission at 1-800-638-2772, or visit www.cpsc.gov, or visit www.atvsafety.org.
- ◆ Always follow the age recommendation:
- ◆ A child under 16 years old should never operate an ATV with engine size greater than 90 cc.
- ◆ NEVER ALLOW A CHILD UNDER AGE 16 TO OPERATE AN ATV without adult supervision, and never allow continued use of an ATV by a child if he or she does not have the abilities to operate it safely.
- ◆ NEVER CARRY A PASSENGER ON AN ATV.
- ◆ Always avoid operating an ATV on any sidewalks, driveways, parking lots and streets.
- ◆ Never operate an ATV on any public street, road or highway, even dirt or gravel one.
- ◆ Never operate an ATV without wearing an approved motorcycle helmet that fits properly. You should also wear eye protection (goggles or face shield), gloves, boots, a long-sleeved shirt or a jacket and long pants.
- ◆ Never consume alcohol or drugs before or while operating this ATV.
- ◆ Never operate at speeds too fast for your skills or the riding conditions. Always go at a speed that is proper for the terrain, visibility, operating conditions and your experience.
- ◆ Never attempt wheelies, jumps or other stunts.
- ◆ Always inspect your ATV each time you use it to make sure it is in safe operating condition. Always follow the inspection and maintenance procedures and schedules described in this manual. Always keep both hands on the handlebars and both feet on the footboards of the ATV during operation.
- ◆ Always go slowly and be extra careful when operating on unfamiliar terrain. Always be alert to changing terrain conditions when operating the ATV.
- ◆ Never operate on excessively rough, slippery or loose terrain until you have learned and practiced the skills necessary to control the ATV on such terrain, Always be especially cautious on these kinds of terrain.
- ◆ Always follow proper procedures for turning as described in this manual. Practice turning at low speeds before attempting to turn at faster speeds and never turns at excessive speeds.
- ◆ Never operate the ATV on hills too steep for the ATV or for your abilities. Practice on smaller hills before attempting larger hills.
- ◆ Always follow proper procedures for climbing hills as described in this manual. Check the terrain carefully before you start up any hill. Never climb hills with excessively slippery or loose surfaces. Shift your weight forward. Never open the throttle suddenly. Never go over the top of a hill at high speed.
- ◆ Always follow proper procedures for going down hills and for braking on hills as described in this manual. Check the terrain carefully before you start down any hill. Shift your weight backward. Never go down a hill at high speed. Avoid going down a hill at an angle that would cause the vehicle to lean sharply to one

side. Go straight down the hill where possible.

- ◆ Always follow proper procedures for crossing the side of a hill as described in this manual. Avoid hills with excessively slippery or loose surfaces. Shift your weight to the uphill side of the ATV. Never attempt to turn the ATV around on any hill until you have mastered the turning technique described in this manual on level ground. Avoid crossing the side of steep hill if possible.
- ◆ Always use proper procedures if you stall or roll backwards when climbing a hill. To avoid stalling, use the proper gear range and maintain a steady speed when climbing a hill. If you stall or roll backwards, follow the special procedure for braking described in this manual. Dismount on the uphill side or to a side if pointed straight uphill. Turn the ATV around and remount, following the procedure described in this manual.
- ◆ Always check for obstacles before operating in a new area.
- ◆ Never attempt to operate over large obstacles, such as large rocks or fallen trees. Always follow proper procedures when operating over obstacles as described in this manual.
- ◆ Always be careful when skidding or sliding. Learn to safety control skidding or sliding by practicing at low speeds and on level, smooth terrain. On extremely slippery surfaces, such as ice, go slowly and be very cautious in order to reduce the chance of skidding or sliding out of control.
- ◆ Never operate an ATV in fast flowing water or in water deeper than that recommended in this manual. Remember that the wet brakes may have reduced stopping ability. Test your brakes after leaving water. If necessary, apply them several times to let friction dry out the linings.
- ◆ Always be sure there are no obstacles or people behind you when you operate in reverse. When it is safe to proceed in reverse, go slowly.
- ◆ Always use the size and type of tires specified in this manual.
- ◆ Always maintain proper tire pressure as described in this manual.
- ◆ Never modify an ATV through improper installation or use of accessories.
- ◆ Never exceed the stated load capacity for an ATV. Cargo should be properly distributed and securely attached. Reduce speed and follow instructions in this manual or carrying cargo or pulling a trailer. Allow greater distance for braking.

 **WARNING!**

All engine exhaust contains carbon monoxide, a deadly gas. Carbon Monoxide is a colorless, odorless, tasteless gas, which may be present even if you do not see or smell any engine exhaust. Avoid Carbon Monoxide Poisoning.

- ◆ Do not run engine indoors. Even if you try to ventilate engine exhaust with fans or open windows and doors, carbon monoxide can rapidly reach dangerous levels.
- ◆ Do not run engine in poorly ventilated or partially enclosed areas such as barns, garages or carports.
- ◆ Do not run engine outdoors where engine exhaust can be drawn into a building through openings such as window and doors.

PRE-OPERATION CHECKS

Inspect your vehicle each time you use it to make sure the vehicle is in safe operating condition. Always follow the inspection and maintenance procedures and schedules described in Owner's Manual.



Failure to inspect or maintain the vehicle properly increase the possibility of accident or equipment damage. Do not operate the vehicle if you find any problem. If a problem cannot be corrected by the procedures provided in this manual, have the vehicle inspected by the dealer.

Before using this vehicle, check the following points:

ITEM	ROUTINE
Fuel	<ul style="list-style-type: none"> ◆ Check fuel level in fuel tank and add recommended fuel if necessary. ◆ Check fuel line for leakage. Correct if necessary.
Engine oil	<ul style="list-style-type: none"> ◆ Check oil level in engine and add recommended oil to specified level if necessary. ◆ Check ATV for oil leakage. Correct if necessary.
Final gear oil	<ul style="list-style-type: none"> ◆ Check ATV for oil leakage. Correct if necessary.
Differential gear oil	<ul style="list-style-type: none"> ◆ Check ATV for oil leakage. Correct if necessary.
Coolant	<ul style="list-style-type: none"> ◆ Check coolant level in reservoir and add recommended coolant to specified level if necessary. ◆ Check cooling system for leakage. Correct if necessary.
Front brake	<ul style="list-style-type: none"> ◆ Check operation, if soft or spongy, have the dealer bleed hydraulic system. ◆ Check brake pads for wear and replace if necessary. ◆ Check brake fluid level in reservoir and add recommended brake fluid to specified level if necessary. ◆ Check hydraulic system for leakage. Correct if necessary.
Rear brake	<ul style="list-style-type: none"> ◆ Check operation and correct if necessary. ◆ Lubricate cables if necessary. ◆ Check lever and pedal free play and adjust if necessary.
Throttle lever	<ul style="list-style-type: none"> ◆ Make sure that operation is smooth. Lubricate cable and lever housing if necessary. ◆ Check lever free play and adjust if necessary.
Control cables	<ul style="list-style-type: none"> ◆ Make sure that operation is smooth. Lubricate if necessary.
Wheels and tires	<ul style="list-style-type: none"> ◆ Check wheel condition and replace if damaged. ◆ Check tire condition and tread depth. Replace if necessary. ◆ Check air pressure. Correct if necessary.

Brake pedal	◆ Make sure that operation is smooth. Lubricate pedal pivoting point if necessary.
Brake levers	◆ Make sure that operation is smooth. Lubricate lever pivoting point if necessary.
Axle boots	◆ Check for cracks or damage and replace if necessary.
Chassis fasteners	◆ Make sure that all nuts, bolts and screws are properly tightened.
Instruments, light and switches	◆ Check operation and correct if necessary.

Vehicle Controls

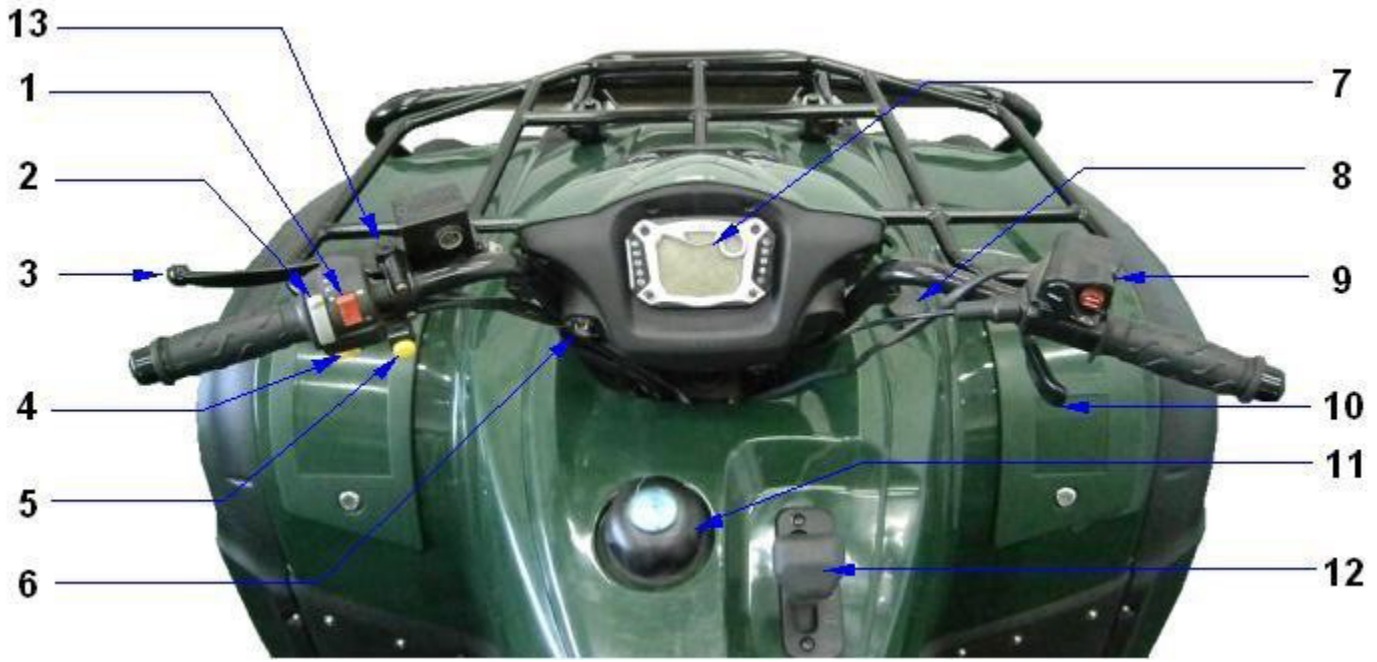

- 1. Stop Switch
- 2. High/Low beam Switch
- 3. Four Wheel Brake Lever
- 4. Starter Switch
- 5. Override
- 6. Ignition Switch
- 7. Speedometer & Display

- 8. Auxiliary DC jack
- 9. 2WD/4WD/LOCK Switch
- 10. Throttle
- 11. Fuel Tank Cap
- 12. L/H/N/R Lever
- 13. Parking Brake

INSTRUMENT AND CONTROL FUNCTION

1.IGNITION SWITCH FUNCTION / POSITION

Position	Function	Key Out
	Position Lamp	NO
ON	All electrical systems operational	NO
OFF	While parking	YES



2.SIGNS AND FUNCTIONS

Position	Name	Function
	Starter Switch	Start engine
	Dimmer Switch	Hi-Beam/Lo-Beam Switch
	Stop Switch	Stop engine
	Run Engine	Engage the engine to run



Starting the engine

brake must be applied.

Remove the function of over-ride

1. Set the shift gear at "R" then press over-ride button (press and hold the button).
2. When pressure on the button is released, reverse gear speed will be limited again



OVERRIDE

3.FOUR WHEEL BRAKE LEVER (WITH PARKING BRAKE)

The four wheel brake lever is located on the left handlebar. To apply the brake, pull the brake lever toward the handlebar grip.

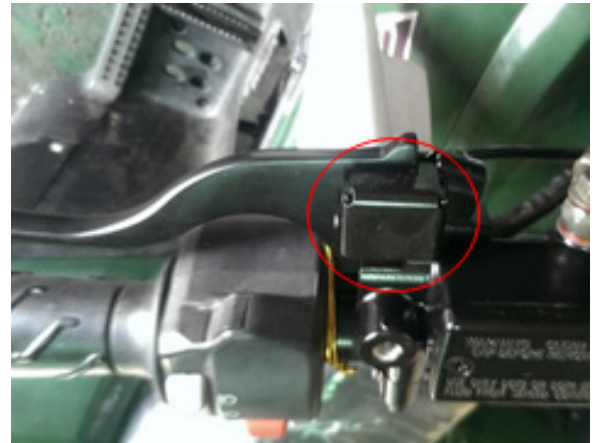

4.REAR BRAKE PEDAL

The rear brake (pedal) is located on the right side of the ATV. To apply the rear brake, push down on the brake pedal.



WARNING!

- ◆ Before each trip check whether the accustomed resistance is present when pressure is applied to the brake lever. Check the brake fluid level, the level must be between the minimum and maximum level markings.
- ◆ Before each trip check the brake actuating system. The gap between the end of the brake lever and the handlebar should be approximately 12 mm (0.5 inch). Inform your local dealer of any deviations.
- ◆ Irregularities of brakes such as leaks and poor performance should be dealt with by an authorized dealer.

NOTE: The brake fluid level must be above the MIN mark. If the level keeps going down, have an authorized dealer check it. Always use DOT #4 brake fluid.



5.SHIFT LEVER



L: High torque use

H: Normal use

N: Neutral

R: Reverse use

Shift lever instructions:

1. Engine starts only in Neutral (N) position.
2. Lift up and hold the pull rod of shift lever to disengage and move the shift lever from N to H, L or R. (L shift is used for rough surfaces)

While shifting between gears (H,L,R) the vehicle must be at a complete stand still.

3. For reverse, with the brake on, push the knob in and move the shift lever from N to R.
4. Must make sure the "N" gear position indicator is lighting when operate "N" gear shift

CAUTION!

Operating the shift lever when vehicle is moving can be hazardous. This is strictly prohibited.

Always wait until the vehicle stops completely, do not operate the ATV at high speed in reverse under any circumstances.

6.2WD/4WD/LOCK SWITCH

The 2WD/4WD/LOCK SELECT BUTTON is used to change the engine drive power to two wheels or all four wheels. Select 2WD, 4WD or LOCK based on different terrain conditions.



2WD: Engage the engine power on rear wheels only. This is mainly used for normal riding.

4WD: Engage the engine power on all four wheels. There is a limited slip gear assembly inside the front differential to engage the right and left front wheels at different speeds. 4WD provides much more traction than 2WD and should be used when riding on wet and slippery surfaces.

LOCK: Engage the engine power on all four wheels without engaging the limited slip gear assembly.

This provides traction to all four wheels evenly and should be used when two or more wheels lose traction.

2WD/4WD/LOCK Switch:

2WD/4WD



WARNING!

Always stop the ATV before changing from two-wheel drive to four-wheel drive and vice versa. The ATV handles differently in two-wheel drive than in four wheel drive in some circumstances. Changing from the two-wheel drive to four-wheel drive or vice versa while moving may cause the ATV to unexpectedly handle differently. This could distract the operator and increase the risk of losing control and causing an accident.

This ATV is equipped with a switch to change from two-wheel drive to four-wheel drive and vice versa. Select the appropriate drive according to the terrain and the conditions.

“2WD” (two-wheel drive): Power is supplied to the rear wheels.

“4WD” (four-wheel drive): Power is supplied to the rear and front wheels.

To change from two-wheel drive to four-wheel drive, stop the ATV and push the button in to the “4WD” position. Then, the four-wheel-drive indicator “” is displayed on the in the multi-function display.

To change from four-wheel drive to two-wheel drive, stop the ATV and push the button in to reset it to the 2WD position. The two-wheel drive indicator is displayed on the multi-function display.



4WD/LOCK

 **WARNING!**

Always ride at a slow speed when the ATV is in differential gear lock and allow extra time and distance for maneuvers.

All wheels turn at the same speed when the differential gear is locked, so it takes more effort to turn the ATV. The effort needed to turn increases with the riding speed. You may lose control and have an accident if you cannot make a sharp enough turn for the speed you are traveling.

This ATV is equipped with a switch allowing you to lock the differential gear when in four-wheel drive. Select the appropriate switch position according to the terrain and the conditions.

- ◆ **“4WD”** (four-wheel drive): Power is supplied to the rear and front wheels.
- ◆ **“LOCK”** (four-wheel drive with the differential gear locked): Power is supplied to the rear and front wheels and the differential gear is locked. Unlike in four-wheel drive, all wheels turn at the same speed.

To lock the differential gear in four-wheel drive, make sure the four-wheel drive button is pushed in to the “4WD” position.

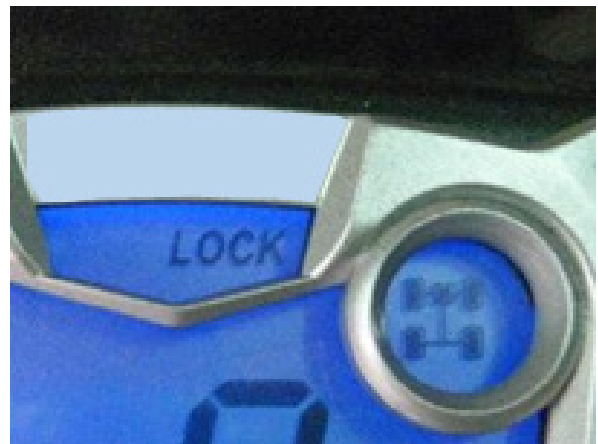

Stop the ATV, make sure the 4WD button is pushed in, then turn the differential gear lock lever to the LOCK position. When the differential gear is locked, the differential gear lock indicator “LOCK” will come on along with the indicator “” in the multi-function display.



To release the differential gear lock, stop the ATV and turn the lock lever to the “4WD” position.

NOTE: Riding before the differential gear lock is properly engaged will cause the vehicle speed to be limited until engagement is complete.

 **WARNING!**

Turning the lock lever when the ATV is moving is extremely dangerous and you may lose control of the vehicle. The gear box mechanism can be damaged if the lever is moved while the ATV is in motion. Always stop the ATV completely before shifting between 2WD, 4WD and LOCK.

7.TIRES

Check tire pressure regularly to make sure it is at the recommended specifications. Also check for wear and damage.

Tire pressure

Use the low-pressure tire gauge to check and adjust tire pressure when tires are cold. Tire pressure must be equal on both sides.



WARNING!

Operation of this vehicle with improper tire pressure may cause severe injury or death from loss control or rollover. Tire pressure below the minimum specified could also cause the tire to separate from the rim under severe riding condition.



Set the tire pressure to the following specifications:		Xplorer XR 500 / XRT 500
Recommend	Front	7 psi (0.492kgf/ cm ²)
	Rear	7 psi (0.492kgf/ cm ²)

The low-pressure tire gauge is included as standard equipment. Make two measurements of the tire pressure and use the second reading. Dust or dirt in the gauge could cause the first reading to be incorrect.

Tire wear limit

When the tire tread depth decreases to 3 mm (0.12 in.) due to wear, replace the tire

Tire information

This ATV is equipped with tubeless tires with valves.

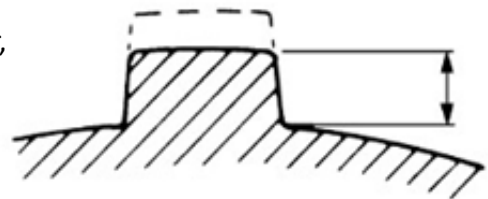

WARNING!

Use of improper tires on this ATV may cause loss of control, increasing your risk of an accident.

After extensive tests, only the tires listed below have been approved for this model by the vehicle manufacturer.

Model		Xplorer XR 500 / XRT 500	
Front	Size	AT25*8-12	AT26*8-14
	Type	Tubeless	
Rear	Size	AT25*10-12	AT26*10-14
	Type	Tubeless	



WARNING!

Contact your dealer to have tires installed on the rims. Never attempt to change the tires on the rims yourself.

After market tires and rims

The tires and rims that came with your ATV were designed to match the performance capabilities and to provide the best combination of handling, braking and comfort. Other tires, rims, sizes and combinations may not be appropriate.

8.COOLANT

The coolant level should be checked before each ride. In addition, the coolant must be changed at the intervals specified in the periodic maintenance and lubrication chart.

Checking the coolant level

1. Place the ATV on a level surface.

NOTE: The coolant level must be checked on a cold engine since the level varies with engine temperature.

2. Check the coolant level in the coolant reservoir.

NOTE: The coolant should be between the minimum and maximum level marks.



If the coolant is at or below the minimum level mark, remove the coolant reservoir cap, add coolant or distilled water to the maximum level mark and install the reservoir cap.

 **CAUTION!**

If coolant is not available, use distilled water or soft tap water instead. Do not use hard water since it is harmful to the engine. If water has been used instead of coolant, replace it with coolant as soon as possible; otherwise the cooling system will not be protected against frost and corrosion. If water has been added to the coolant, have a dealer check the antifreeze content of the coolant as soon as possible, otherwise the effectiveness of the coolant will be reduced.

 **Coolant reservoir capacity (up to the maximum level mark): 1.2 L (1.25 quarts)****Changing the coolant** **WARNING!**

Wait for the engine and radiator to cool before removing the radiator cap. You could be burned by hot fluid and steam blown out under pressure. Always place a thick rag over the cap when opening. Allow any remaining pressure to escape before completely removing the cap.



1. Place the ATV on a level surface. Turn the key to the OFF position and remove it from the vehicle.
2. Remove front cover.
3. Place a container under the engine and then remove the coolant drain bolt and its gasket.
4. Remove the radiator cap.
5. Remove reservoir cap.
6. Disconnect the coolant reservoir hose on the coolant reservoir side and allow the coolant to drain from the coolant reservoir.
7. After draining the coolant, thoroughly flush the cooling system with clean tap water.
8. Install the coolant drain bolt and its new gasket and then tighten the bolt.
9. Connect the coolant reservoir hose.
10. Pour the recommended coolant into the reservoir to the maximum level mark and then install the reservoir cap.

 **CAUTION!**

Mix antifreeze with distilled water only. However, if distilled water is not available, soft water may be used for refilling. Do not use hard water since it is harmful to the engine.

11. Pour the recommended coolant into the radiator until it is full. Antifreeze/water mixture ratio: 1:1

Recommended antifreeze:

High quality ethylene glycol antifreeze containing corrosion inhibitors for aluminum engines.

Coolant quantity:

Radiator capacity (including all routing): 2.2 L (2.3 quarts)

Reservoir capacity (up to the maximum level mark): 1.2 L (1.25 quarts)

12. Install the radiator cap, start the engine let it idle for several minutes and then turn it off.
13. Remove the radiator cap to check the coolant level in the radiator. If it is low, add sufficient coolant until it reaches the top of the radiator and then install the radiator cap.
14. Start the engine and then check for coolant leakage.
15. Install the front cover.
16. Remove key.

9. STEERING LOCK



The steering lock in principle should be used for theft protection. The handlebar is to be turned to the left and the key in the steering lock pressed and turned simultaneously as shown.



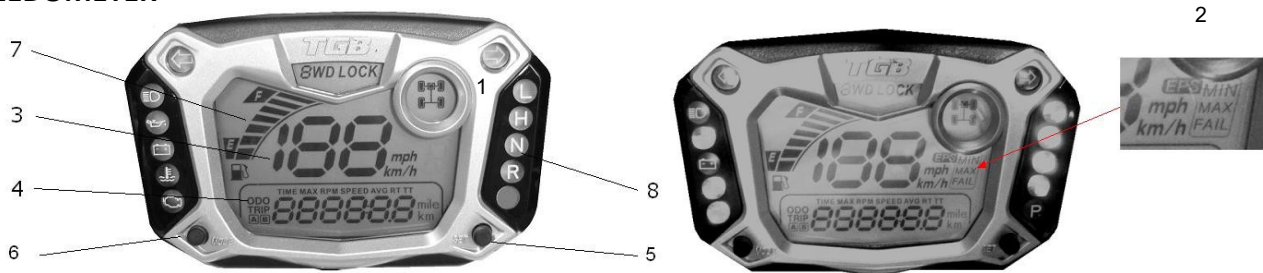

Remove key.

10. SPEEDOMETER



PANEL DESCRIPTIONS

- | | |
|-------------------------------------|------------------------------|
| 1. 2WD/ 4WD indicator | 5. SET Button |
| 2. EPS Mode (for EPS model) | 6. MODE Button. |
| 3. 1st row display: Speedometer | 7. Fuel Meter bar (Optional) |
| 4. 2nd row display: Other functions | 8. LED Indicator symbols |

	High-Beam Headlamp/Blue	L/H	Drive Gear/ Green
	Engine oil indicator/Red	N	Neutral Gear/ Green
	Battery charge indicator	R	Reverse Gear/ Green
	Engine coolant Temperature/ Red		
	Engine check / Yellow (EFI model)		

1. Engine oil indicator (Red): if this light turns on, check the oil level, if oil level is good, please contact your local dealer for inspection.
 2. Temperature indicator (Red): if the light is on with the engine running it implies that there is a cooling system problem. Please contact with your local dealer for inspection.
 3. Battery charge warning light: if the light is illuminated while the engine is running, it implies there is a malfunction of the battery system. Please contact your local dealer for inspection.
- ⚙️ When the ignition switch is turned on the oil indicator, temperature indicator and battery indicator will run a self-diagnostic. If the system does not run the self-diagnostic program there is a malfunction in the system. Please contact your local dealer for inspection.
4. Turn signal light (Green): on use of turn signal, lights will flash with an audible warning. Hazard warning: both left and right turn signal lights will flash with and audible warning.
 5. Engine check light (Yellow): if this light turns on, please contact with your local dealer for inspection.



WARNING!

- ◆ The Engine oil warning light will illuminate when the oil level is too low. After adding the correct amount of oil the warning light will turn off. Never operate the vehicle with the oil warning light illuminated.
- ◆ Operating the vehicle with the oil warning light illuminated will cause severe damage to the engine, the engine will over heat.

FUNCTIONS

RPM: Digital Tachometer

1. RPM is displayed in 2nd row.
2. Digital tachometer displays up to 19,900 RPM.
3. Tachometer signal is picked up from either the ECU or the ignition coil.

MAX RPM: Maximum Tachometer

1. MAX RPM is displayed on 2nd row.
2. Displays highest tachometer reading achieved after last RESET operation.

SPEED: Speed Meter

1. Speedometer display is on 1st row of the screen.
2. Displays speedometer reading up to 300.0 Km/H or 187.5 MPH.

MAX SPEED: Maximum Speed Meter

1. MAX is displayed on 1st row.
2. Displays highest speed achieved after last RESET operation.

SPEED AVG: Average Speed Meter

1. AVG is displayed on 2nd row.
2. Calculates average speed from last RESET.

TRIP A & TRIP B: Trip Meter A & B

1. TRIP function registers cumulative trip distance from last RESET while ATV is being ridden.
2. Display is on 2nd row of screen.

ODO: Odometer

1. ODO registers cumulative distance traveled during vehicle operation.
2. ODO data is stored in memory even when power is off.

RT: Riding Timer

1. Calculates total operation time from last RESET.
2. Count automatically begins with vehicle movement.

TT: Total Riding Timer

1. Calculates total operation time from the beginning of vehicle use.
2. Count automatically begins with vehicle movement.
3. TT data is stored in memory even when power is off.

Fuel Meter (Only for models with the function)

1. 7 bar graphic indicator of fuel status.
2. Last bar flashes to indicate low fuel level.

BUTTON OPERATIONS

MODE BUTTON

1. Press the MODE button to cycle through all of the available functions and display the value for each.

ODO → RPM → TRIP A → TRIP B → MAX SPEED → SPEED AVG → RT → TT → MAX RPM → TIME → EPS → ODO

2. Press the MODE button and hold it for 10 seconds to change the display between KMH and MPH.

RESET FUNCTION

1. Press the MODE button to scroll to the desired screen, then press the MODE and SET buttons simultaneously and hold them for 6 seconds to reset the stored value to zero. Each function must be reset individually.
2. ODO, Clock and TT data cannot be reset.

TIME FUNCTION

1. Press the MODE button to cycle through to the ODO screen for TYPE I or the TIME screen for TYPE II, then press the MODE and SET buttons simultaneously for 3 seconds to set the time.
2. When the digit is blinking, press the SET button to reach the desired number then press the MODE button to move to the next digit.
3. After setting the time, press the MODE and SET buttons simultaneously to save the time and go back to the ODO screen.
4. During setting, if the digits are not changed for more than 10 seconds, the system will auto-save and go back to the time screen.
5. When speed is over 10 KMH, the setting will save automatically.

EPS (Electric Power Steering) FUNCTION

The EPS indicator turns on when you press the MODE button and scroll to the EPS function. You can engage or disengage the EPS function as needed. The indicator will remain on when the EPS is engaged and the ignition is turned ON, you can set the steering torque to Max or Min.

MIN: Low steering torque, used for smooth terrain and high speed.

MAX: High steering torque, used for rough terrain and low speed.

FAIL: EPS failure, the screen will blink to indicate an EPS malfunction, the defect code will be shown on the bottom line of the screen, the letter c followed by four numbers.

11.SPARK PLUG

Checking the spark plug.

The spark plug is an important engine component, which is easy to check. Since heat and deposits will cause any spark plug to slowly erode, the spark plug should be removed and checked in accordance with the periodic maintenance and lubrication chart. In addition, the condition of the spark plug can reveal the condition of the engine.

Removing the spark plug

1. Remove spark plug wire.
2. Remove dirt and debris from around the spark plug.
3. Remove the spark plug with a spark plug wrench.

Checking the spark plug

1. Check that the porcelain insulator around the center electrode of the spark plug is a medium to light tan (the ideal color when the ATV is ridden normally).

NOTE: If the spark plug shows a distinctly different color, the engine could be operating improperly. Do not attempt to diagnose such problems yourself. Instead have your dealer check the ATV.

2. Check the spark plug for electrode erosion and excessive carbon or other deposits and replace it if necessary.

Specified spark plug: NGK/CR7E

3. Measure the spark plug gap with a wire thickness gauge and if necessary, adjust the gap to specification.

Spark plug gap: 0.7~0.8 mm

Installing the spark plug

1. Clean the surface of the spark plug gasket and its mating surface and then wipe off any grime from the spark plug threads.
2. Install the spark plug with the spark plug wrench and then tighten it to the specified torque.

Tightening torque:

Spark plug: 17.6 Nm or 13 ft. lbs.

NOTE: If a torque wrench is not available when installing the spark plug, a good estimate of the correct torque is 1/4 -1/2 turn past finger tight. However the spark plug should be tightened to the specified torque as soon as possible.

3. Install the spark plug wire.



12. AIR CLEANER

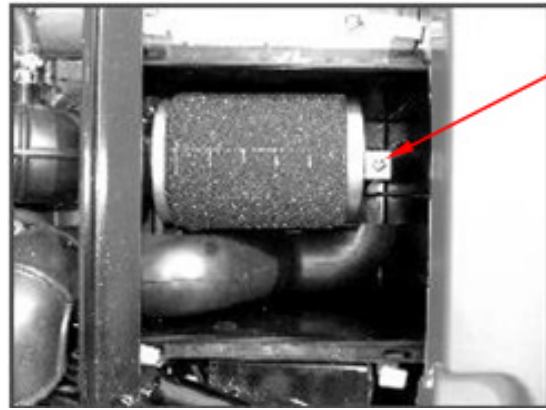
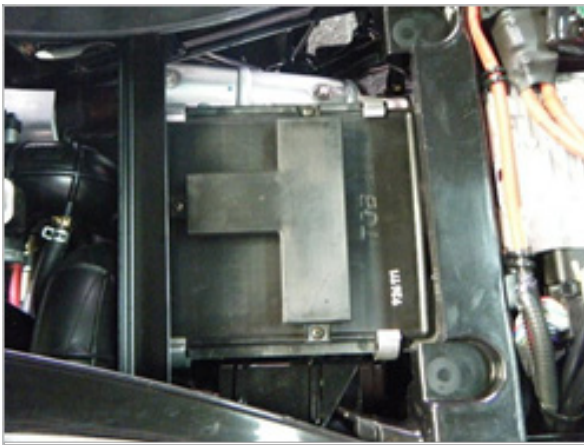

1. Remove the seat.
2. Release the four latches that secure the air cleaner cover, remove the cover.
3. Loosen the clamp strip screw and remove the air cleaner element.
4. Clean the element with non-flammable solvent.



Always use parts cleaning solvent to clean the sponge material. Never use low-flash-point solvents or gasoline to clean the sponge material because the engine could catch fire or explode.

5. Squeeze the excess solvent out of the sponge material and let it dry.



Do not twist the sponge material when squeezing it.

6. Apply foam air filter oil or other quality foam air filter oil to the sponge material.
NOTE: The sponge material should be wet but not dripping.

13. ENGINE OIL AND OIL FILTER

The engine oil level should be checked before each ride. In addition, the oil must be changed and the oil filter replaced at the intervals specified in the periodic maintenance and lubrication chart. To check the engine oil level

1. Place the ATV on a level surface and remove the side access cover.
2. Check the engine oil level on a cold engine

Checking the engine oil level

1. Place the ATV on a level surface and remove the side access cover.
2. Check the engine oil level on a cold engine



NOTE: If the engine was started before checking the oil level, be sure to warm up the engine sufficiently and then wait at least ten minutes until the oil settles for an accurate reading.

3. Remove the engine oil filler cap and then wipe the engine oil dipstick off with a clean rag.



CAUTION!

A common dipstick is used for both 500cc and 1000cc model ATV's and levels are read at two different areas on the dipstick depending on the model. It is clearly marked for both 500cc and 1000cc models. Ensure you use the correct area of the dipstick to check oil level for your particular model.

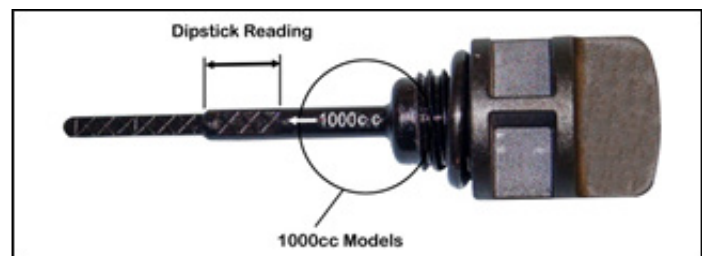

4. Insert the dipstick into the filler hole ensuring it is threaded in clockwise and tightened down. Remove it again to check the oil level

NOTE: The engine oil should be between the minimum and the maximum level mark.

5. If the engine oil is not between the minimum and the maximum level mark, add sufficient oil of the recommended type to raise it to the correct level.

NOTE: Be sure the engine oil is at the correct level, otherwise engine damage may result.

6. Insert the dipstick into the oil filler hole and then tighten the engine oil filler cap.
7. Install the side cover.

Changing the engine oil (with or without oil filter replacement)

1. Place the ATV on a level surface and raise it up with lift or jack.
2. Start the engine, warm it up for several minutes and then turn off.
3. Place an oil pan under the engine to collect the used oil.
4. Remove the engine oil drain bolt and its gasket to drain the oil from the crankcase.

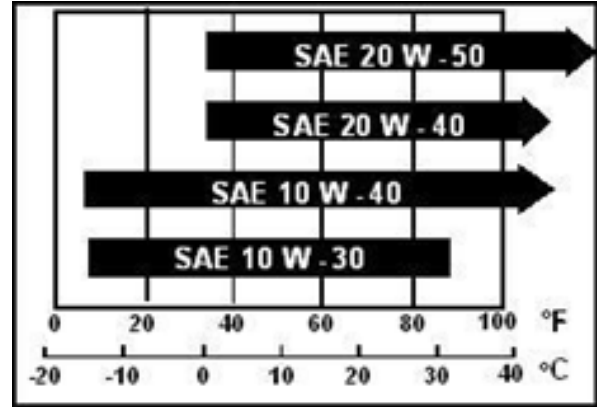

NOTE: Dispose of lubricant in accordance with local regulations.

⚙️ Skip the steps 5-7, if the oil filter cartridge is not being replaced.

5. Remove the left internal fender.
6. Remove the oil filter cartridge with an oil filter wrench.
7. Apply a thin coat of engine oil to the O-ring of new oil filter.
8. Install the new oil filter and tighten securely.
9. Install the engine oil drain bolt and its new gasket and then tighten the bolt to the specified torque.
Tighten torque: 23.5 Nm or 17.4 ft. lb
10. Refill with the specified amount of the recommended engine oil and then install and tighten the engine oil filler cap.

Oil quantity:

Without oil filter replacement: 3.5 L (3.6 quarts)

With oil filter replacement: 3.85 L (4 quarts)

⚙️ **Be sure to wipe off spilled oil on any parts after the engine and exhaust system have cooled down.**

CAUTION!

- ◆ In order to prevent clutch slippage (since the engine oil also lubricates the clutch), do not mix any chemical additives.
- ◆ Make sure that no foreign material enters the crankcase.

11. Start the engine and then let it idle for several minutes while checking it for oil leakage. If oil is leaking, immediately turn the engine off and check for the cause.
12. Turn the engine off, wait at least ten minutes and then check the oil level and correct it if necessary.

14. DIFFERENTIAL GEAR OIL

The differential gear case must be checked for oil leakage before each ride. If any leakage is found, have a dealer check and repair the ATV. In addition, the differential gear oil level must be checked and the oil changed as follows at the intervals specified in the periodic maintenance and lubrication chart.

Checking the differential gear oil level

1. Place the ATV on a level surface.
2. Remove the differential gear oil filler bolt and its gasket and then check the oil level in the differential gear case. The oil level should be at the brim of the filler hole.

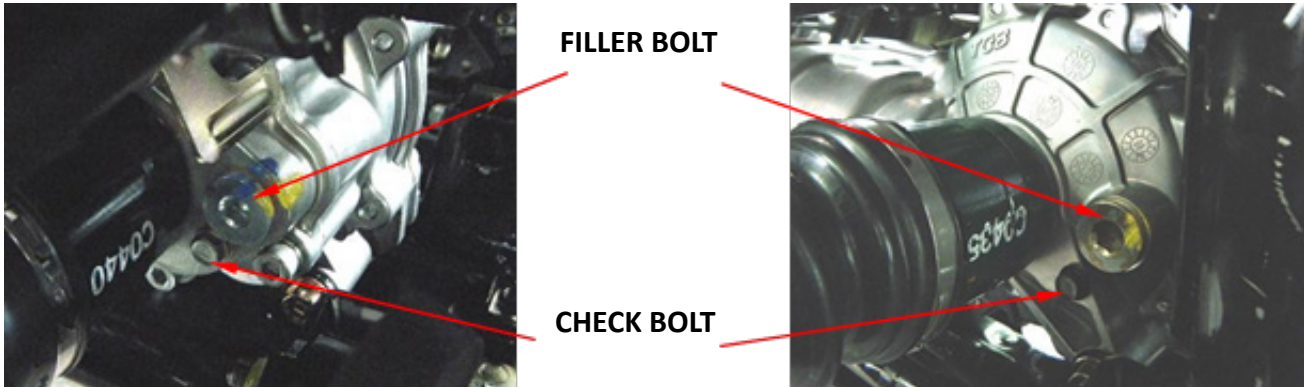

3. If the oil is below the brim of the filler hole, add sufficient oil of the recommended type to raise it to the correct level.
4. Check the gasket for damage and replace it if necessary.
5. Install the oil filler bolt and its gasket and then tighten the bolt to the specified torque.

Tighten torque:

filler bolt: 32.36 Nm or 24 ft. lb

check bolt: 7.8 Nm or 69 in. lb

Changing the differential gear oil (front differential)

1. Place the ATV on a level surface and raise up with a lift or jack.
2. Place an oil pan under the differential gear case to collect the used oil.
3. Remove the differential gear oil filler bolt, the differential gear oil drain bolt and their gaskets to drain the oil from the differential gear case.



NOTE: Dispose of lubricant in accordance with local regulations.

4. Install the drain bolt and its new gasket and then tighten the bolt to the specified torque.

Tighten torque: 32.36 Nm or 24 t. lb

5. Refill with recommended differential gear oil.

Oil quantity: SAE 85W-90, 350 L (0.09 G)

6. Check the oil filler bolt gasket for damage and replace it if necessary.

7. Install the oil filler bolt and its gasket and then tighten the bolt to the specified torque.

Tighten torque: 32.36 Nm or 24 t. lb

8. Check the differential gear case for oil leakage. If oil is leaking, check for the cause.

15.FINAL GEAR OIL (rear differential)

The final gear case must be checked for oil leakage before each ride. If any leakage is found, have a dealer check and repair the ATV. In addition, the final gear oil level must be checked and the oil changed as follow at the intervals specified in the periodic maintenance and lubrication chart.

Checking the final gear drive oil

1. Place the ATV on a level surface.
2. Remove the final gear oil filler bolt and its gasket and then check the oil level in the final gear case. The oil level should be at the brim of the filler hole.

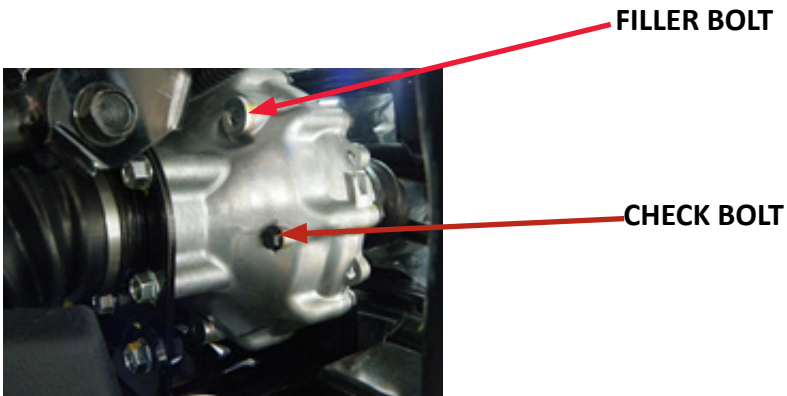

3. If the oil is below the brim of the filler hole, add sufficient oil of the recommended type to raise it to the correct level.
4. Check the oil filler bolt gasket for damage and replace it if necessary.
5. Install the oil filler bolt and its gasket and then tighten the bolt to the specified torque.

Tighten torque:

filler bolt: 32.36 Nm or 24 ft. lb

check bolt: 7.8 Nm or 69 in. lb

Changing the final gear oil (rear differential)

1. Place the ATV on a level surface and raise up with a lift or jack.
2. Place an oil pan under the final gear case to collect the used oil.
3. Remove the final gear oil filler bolt; the final gear oil drain bolt and their gaskets to drain the oil from the final gear case.

NOTE: Dispose of lubricant in accordance with local regulations.

4. Install the drain bolt and its new gasket and then tighten the bolt to the specified torque.

Tighten torque: 32.36 Nm or 24 ft. lb

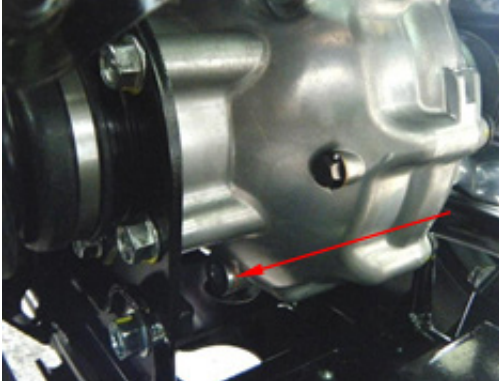

DRAIN BOLT

5. Refill with the recommended final gear oil to the brim of the filler hole as shown.

Oil quantity: SAE 85W-90, 500ml (0.13 G)

6. Check the oil filler bolt gasket for damage and replace it if necessary.
7. Install the oil filler bolt and its gasket and then tighten the bolt to the specified torque.

Tighten torque: 32.36 Nm or 24 t. lb

8. Check the final gear case for oil leakage. If oil is leaking, check for the cause.

16.SEAT

To remove the seat

1. Open the lock by turning the key.
2. Pull up on the seat at the rear.

To install the seat

Insert the tongue on the front of the seat into seat holders and push down on the seat at the rear. Make sure that the seat is securely fitted.



13.STORAGE COMPARTMENTS

This ATV equipped with two storage compartments located at the front right and left side. To access the storage compartment, insert the key in the lock and turn to unlock, remove the storage compartment cover.



DRAIN PLUG



When storing any documents in the storage compartments, be sure to wrap them in a plastic bag so that they will not get wet. When washing the ATV, be careful not to let any water enter the storage compartments.

If any water has collected in a storage compartment, remove the drain plug to allow the water to drain. Dry the compartment with a cloth and install the drain plug.

18.BATTERY AND FUSES

The battery is located under the seat. This model is equipped with a maintenance free battery. There is no need to check the electrolyte or to add distilled water. However, the battery lead connections need to be checked and tightened if necessary.



WARNING!

- ◆ Battery electrolyte is poisonous and dangerous as it contains sulfuric acid, which can cause severe burns. Avoid contact with skin, eyes or clothing. Always shield your eyes when working near batteries.
- ◆ Batteries produce explosive gases. Keep sparks, flame, cigarettes or other sources of ignition away. Ventilate when charging or using in an enclosed space.

KEEP OUT OF REACH OF CHILDREN



CAUTION!

When removing the battery, the ignition switch must be off and the negative lead must be disconnected before the positive lead.

To remove the battery

1. Remove the seat.
2. Remove the battery holding plate by removing two bolts.
3. Disconnect the negative battery lead first then the positive battery lead by removing their bolts.
4. Pull the battery out of its compartment.



To charge the battery

If the battery is discharged and will not allow the vehicle to start. Use a constant voltage battery charger to charge the battery. Keep in mind that the battery tends to discharge more quickly if the ATV is equipped with optional electrical accessories.



To charge the maintenance free battery, a special (constant voltage) battery charger is required. Using a conventional battery charger will damage the battery.

To store battery

1. If the ATV will not be used for more than one month, remove the battery, fully charge it and then place it in a cool dry place.
2. If the battery will be stored for more than two months, check it at least once a month and fully charge it if necessary.



Always keep the battery charged. Storing a discharged battery can cause permanent battery damage.

To install the battery

1. Place the battery in its compartment.
2. Connect the positive battery lead first then connect the negative battery lead by installing their bolts.



When installing the battery, the ignition switch must be off and the positive lead must be connected before the negative lead.

3. Install the battery holding plate by installing the bolts.
4. Install the seat.

FUSES

There are two fuse boxes, one is the main fuse box and the other is the EPS fuse box (for the EPS equipped model). For EPS model, the MAXI fuse is located in the EPS fuse box, which is on the right side under the seat.

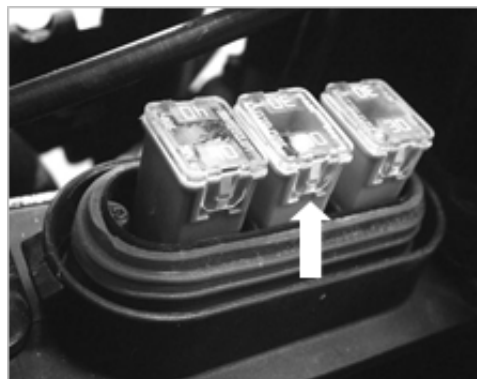

For **Non EPS** model, the MAXI fuse is located beside the starter relay.

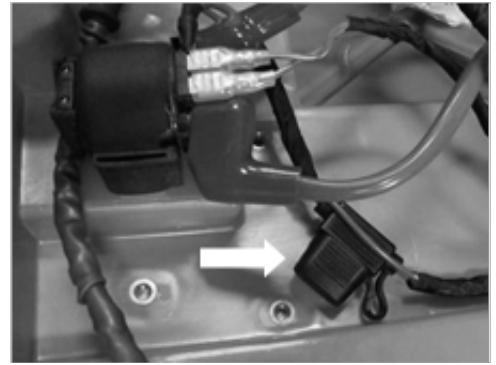

Replacing a fuse

The main fuse box and the EPS fuse box are located under the seat

HEAD HI 15A	IGNITION 10A	TAIL 10A		F.P RELAY
HEAD LO 15A	P-SOURCE 10A	SPACE FUSE 20A		
FUEL PUMP 10A	P-SOURCE 10A	FAN RELAY		MAIN.P RELAY
EPI SYSTEM 10A	FAN 20A			



EPS 40A	MAXI 30A	CHARGER 30A
GREEN	PINK	PINK

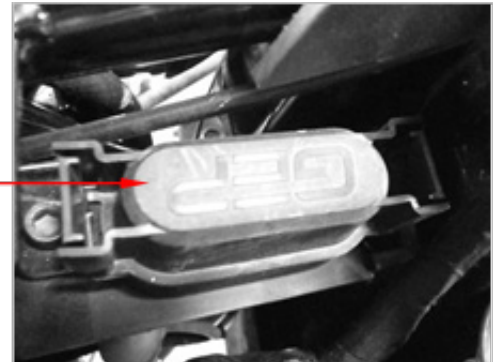

If a fuse is blown, replace it as follows.

1. Turn the key to "OFF" and turn off all electrical circuits.

! CAUTION!

To prevent accident short-circuiting; turn off the ignition switch when checking or replacing a fuse.

2. Remove the blown fuse and then install a new fuse of the specified amperage

! WARNING!

Always use a fuse of the specified rating and never use a substitute object in place of the proper fuse. An improper fuse or a substitute object can cause damage to the electrical system, which could lead to a fire.

3. Turn the key "ON" and turn on the electrical circuits to check if the devices operate.
4. If the fuse immediately blows again, have a dealer check the electrical system.

19. REPLACING A HEADLIGHT BULB

If a headlight bulb burns out, replace it as follows.

1. Disconnect the wiring connector.
2. Turn the headlight bulb counterclockwise then remove it.

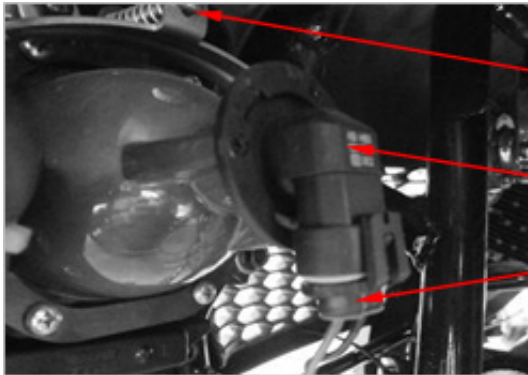

ADJUSTING SCREW

BULB

CONNECTOR

3. Insert a new headlight bulb, and turn clockwise to lock in place.
4. Connect the wiring connector.

CAUTION!

Do not touch the glass part of the headlight bulb to keep it free from oil, otherwise the transparency of the glass; the luminosity of the bulb and the bulb life will be adversely affected. Thoroughly clean off any dirt and fingerprints on the headlight bulb using a cloth moistened with alcohol or thinner.

5. Adjust the headlight beam if necessary.

Adjusting a headlight beam

CAUTION!

It is advisable to have a dealer make this adjustment.

To raise a headlight beam, turn the headlight beam adjusting screw in clockwise. To lower a headlight beam, turn the adjusting screw in counterclockwise.

20. REPLACING THE TAIL/ BRAKE LIGHT BULB

If the tail /brake light bulb burns out, replace it as follows.

1. Remove the cover at the rear of the tail/brake light by pulling it off.

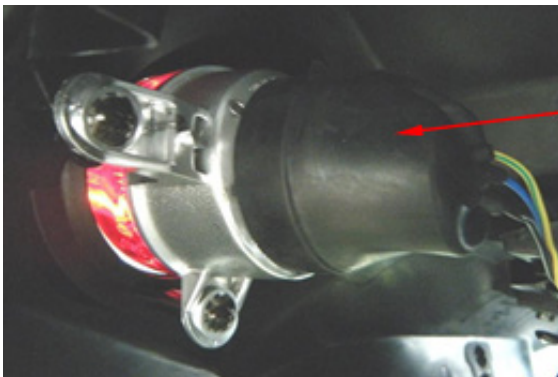

COVER

2. Remove the tail / brake light bulb holder (together with bulb) by turning it counterclockwise.

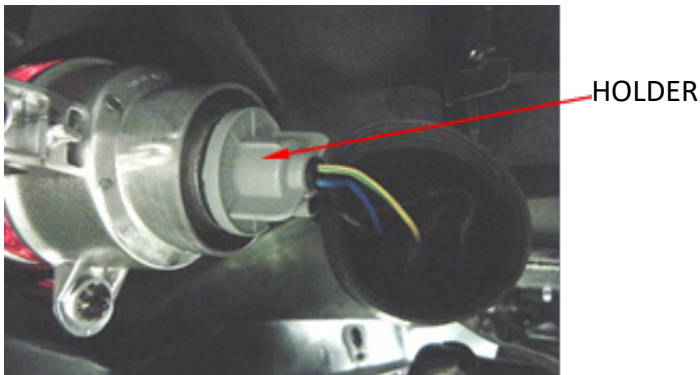

3. Remove the burnt out bulb by pushing it in and turning it counterclockwise.
4. Insert a new bulb into the bulb holder, push it in and then turn it clockwise until it stops.
5. Install the bulb holder (together with the bulb) by turning it clockwise.
6. Install the cover.

21. AUXILIARY DC JACK

The auxiliary DC jack is located at the front right side of the ATV. The Auxiliary DC jack can be used for suitable work lights, radios, etc. The auxiliary DC jack should only be used when the engine is running and light switch is set to "OFF". When the auxiliary DC jack is being used the electric current should not exceed 5 A.

1. When the auxiliary DC jack is not being used, cover it with the cap.
2. Set the light switch to "OFF".
3. Turn the accessory off.
4. Start the engine.
5. Open the auxiliary DC jack cap and then insert the accessory power plug into the jack.
6. Turn the accessory on.



CAUTION!

- ◆ Do not use accessories requiring more than 5 A. This may overload the current and cause the fuse to blow.
- ◆ If accessories are used without the engine running or with the headlights turned on, the battery will lose its charge and engine starting may become difficult.
- ◆ Do not use an automotive cigarette lighter or other accessories with plug that gets hot
- ◆ because the jack can be damaged.

PRECAUTION OF ATV RIDING

This ATV is for recreation and utility use. This section, riding your ATV, provides general ATV riding instructions for recreational riding. The skills and techniques described in this section however are appropriate for all types of riding. Riding your ATV requires special skills acquired through practice over a period of time. Take the time to learn the basic techniques well before attempting more difficult maneuvers.

Be sure you have read this Owner's Manual completely and understand the operation of the controls. Pay particular attention to the safety information. Also read all warning and notice labels on your ATV.

RIDE WITH CARE

 **WARNING!**

- ◆ Do not operate this ATV or allow anyone else to operate it without proper instruction. The risk of an accident is greatly increased if the operator does not know how to operate the ATV properly in different situations and on different types of terrain.
- ◆ Do not operate this ATV at speeds too fast for your skills or the conditions as this increases your chances of losing control of the ATV and having an accident. Always travel a speed that is proper for the terrain, visibility and operating conditions and your experience.

Beginning and inexperienced operator should complete the certified training course. They should then regularly practice the skills learned in the course and the operating techniques described in this Owner's Manual.

Riding your ATV requires skills acquired through practice over a period of time.

Do not attempt to operate at maximum performance until you are totally familiar with the ATV's handling and performance characteristics. Take the time to learn the basic techniques well before attempting more difficult maneuvers. Become familiar with this ATV at slow speeds first, even if you are an experienced operator.

Not recommended for children under 16 years of age.

 **WARNING!**

A child under 16 should never operate an ATV with engine size greater than 90 cc. ATV use by children is not recommended.



This ATV is designed to carry the operator and cargo only, passengers are prohibited.

The long seat is to allow the operator to shift position as needed during operation. It is not for carrying passengers.

 **WARNING!**

Never carry a passenger. Carrying a passenger on this ATV greatly reduces your ability to balance and control this ATV. You could have an accident, resulting in severe injury or death to you and / or your passenger.



Apparel

An approved helmet and other personal protective equipment can reduce the severity of injuries in an accident.

Always wear the following to reduce risk of injury in an accident:

- ◆ Approved motorcycle helmet that fits properly.
- ◆ Eye protection (goggles, helmet face shield or protective eyewear)
- ◆ Over the ankle boots, gloves, long sleeved shirt or jacket and long pants.

An approved helmet and other personal protective equipment can reduce the severity of injuries in an accident.

 **WARNING!**

Operating without an approved motorcycle helmet increases your chances of a severe head injury or death in the event of an accident.

Wear eye protection when operating your ATV to reduce the risk of a serious accident or injury. Eye protection such as a face shield or goggles may reduce the risk of foreign material getting in your eyes and help prevent loss of vision.

 **WARNING!**

Operating without eye protection can result in an accident and increases your chances of a severe injury in the event of an accident.

Do not operate after or while consuming alcohol or drugs.

The operator's performance capability is reduced by the influence of alcohol or drugs. Consuming alcohol or drugs could seriously affect your judgment, cause you to react more slowly and affect your balance and perception.



**WARNING**

Never consume alcohol or drugs before or while driving this ATV. You increase your chance of an accident.

Pre-operation checks

Always inspect your ATV each time you use it to make sure the ATV is in safe operating condition. Perform the pre-operation checks listed on this manual. Always follow the inspection and maintenance procedures and schedules described in the Owner's Manual

**WARNING**

Failure to inspect the ATV before operating it and to maintain it properly increases the possibility of accident or equipment damage.

Loading and accessories**WARNING!**

Improper loading or towing can increase the risk of loss of control, an overturn or other accident. To reduce the risk of an accident:

- ◆ Do not exceed the maximum loading limits for the vehicle.
- ◆ Keep weight on racks centered side to side and as low as possible. Be sure cargo is secured—a loose load could change the vehicle handling unexpectedly.
- ◆ Make sure the load does not interfere with your control or ability to see where you are going.
- ◆ Tie down cargo in the trailer securely. Make sure cargo in the trailer cannot move around. A shifting load can cause an accident.
- ◆ Reduce speed and allow more room to stop. A heavier vehicle takes longer to stop.
- ◆ Avoid hills and rough terrain. Choose terrain carefully. Use extreme caution when towing or carrying a load on inclines.
- ◆ Turn gradually and go slowly.

Take extra precautions when driving with a load or trailer. Follow these instructions and always use common sense and good judgment when carrying cargo or towing a trailer.

MAXIMUM LOADING LIMIT

Front carrier: 30 kg

Rear carrier: 50kg

Trailer max weight: 200 kg on level ground

Hitch max vertical weight: 35 kg

Drive more slowly than you would without a load. The more weight you carry, the slower you should go. It is good practice to drive slowly (shift into first gear or low drive if available on this model) whenever you are carrying heavier loads or when towing a trailer.

During operation

Always keep your feet on the foot boards during operations.

 **WARNING!**

Removing even one hand or foot can reduce your ability to control the ATV or could cause you to lose your balance and fall off of the ATV.

Avoid wheelies and jumping.

 **WARNING!**

Attempting wheelies, jumps and other stunts increases the chance of an accident, including an overturn. Never attempt stunts, such as wheelies or jumps. Don't try to show off.

Modifications and accessories

Never modify this ATV through improper installation or use of accessories or other modification. All parts and accessories added to this ATV should be genuine parts and should be installed and used according to instructions. If you have questions, please consult an authorized ATV dealer.

 **WARNING!**

Operating this ATV with improper modifications may cause changes in handling, which in some situations could lead to an accident.

Exhaust system

 **WARNING!**

- ◆ Dry grass or brush or other combustible material accumulated around the engine area could catch fire. Do not operate, idle or park the ATV in dry grass or other dry ground cover. Keep the engine area free of dry grass, brush or other combustible material.
- ◆ Someone touching the exhaust system during or after operation could be burned. Do not touch the hot exhaust system; do not park the ATV in a place where others might be likely to touch it

The muffler and other engine parts become extremely hot during operation and remain hot after the engine has stopped. To reduce the risk of fire during operation or after leaving the ATV, do not let brush, grass and other materials collect under the vehicle, near the muffler or exhaust pipe or next to other hot parts. Check under the vehicle after operating in areas where combustible materials may have collected. Do not idle or park the vehicle in long dry grass or other dry ground cover.

To prevent burns, avoid touching the exhaust system. Park the ATV in a place where pedestrians or children are not likely to touch it.

Cleaning the spark arrester

Be sure the exhaust pipe and muffler are cool before cleaning the spark arrester.

1. Install the bolts and tighten them to the specified torque. 1 Nm or 8 in lb. (10 kgf-cm³)
2. Remove the bolts.
3. Remove the tailpipe by pulling it out of the muffler.
4. Tap the tailpipe lightly, and then use a wire brush to remove any carbon deposits from the spark arrester portion of the tailpipe and inside of the tailpipe housing.
5. Insert the tailpipe into the muffler and align the bolt holes.

 **WARNING!**

Do not start the engine when cleaning the spark arrester, otherwise it could cause injury to the eyes, burns, carbon monoxide poisoning, possibly leading to death, and start a fire. Always let the exhaust system cool prior to touching exhaust components.

BE CAREFUL WHERE YOU RIDE

This ATV is designed for a single person and OFF-ROAD use only.

 **WARNING!**

Paved surfaces may seriously affect handling and control of the ATV and may cause the ATV to go out of control. Always avoid paved surfaces, including sidewalks, driveways, parking lots and streets.

Do not ride on any public road, street or highway. Riding on public roads can result in collisions with other vehicles. In many states it is illegal to operate ATVs on public streets, roads and highways.

 **WARNING!**

Never operate this ATV on any public street, road or highway, even dirt or gravel roads. You could collide with another vehicle.

Know the terrain where you ride. Ride cautiously in unfamiliar areas. Stay alert for holes, rocks or roots in the terrain and other hidden hazards, which may cause the ATV to overturn.

 **WARNING!**

The ATV could go out of control if you do not have enough time to react to hidden rocks, bumps or holes. Go slowly and be extra careful when operating on unfamiliar terrain. Always be alert to changing terrain conditions when operating the ATV.

Do not operate on rough, slippery or loose terrain until you have learned and practiced the skills necessary to control the ATV on such terrain. Always be especially cautious on these kinds of terrain.

 **WARNING!**

Failure to use extra care when operating on excessively rough, slippery or loose terrain could cause loss of traction or ATV control which could result in an accident, including an overturn.

When riding in an area where you might not easily be seen such as desert terrain, mount a caution flag on the ATV. DO NOT use the flagpole bracket as a trailer hitch.

 **WARNING!**

You could collide with another vehicle if operating in off-road areas where you cannot easily be seen. Mount a caution flag on the ATV to make you more visible. Watch carefully for other vehicles.

Do not ride in areas posted “no trespassing”.

Do not ride on private property without getting permission.

Select a large and flat area off-road to become familiar with your ATV. Make sure that this area is free of obstacles and other riders. You should practice control of the throttle, brakes, shifting procedures and turning techniques in this area before trying more difficult terrain.

Shift to the park position and follow the instruction to start the engine. Once it has warmed up you are ready to begin riding your ATV. With the engine idling, shift the drive select lever into the low gear position or high gear position. Apply the throttle slowly and smoothly.

If the throttle is applied too abruptly, the front wheels may lift off the ground, resulting in a loss of directional control. Avoid higher speeds until you are thoroughly familiar with operation of your ATV.

When slowing down or stopping, release the throttle and apply the brakes smoothly and evenly. Improper use of the brakes can cause the tires to lose traction, reducing control and increasing the possibility of an accident.

 **CAUTION!**

Do not shift from low gear to high gear without coming a complete stop. Damage to the engine or drive train may occur.

TURNING YOUR ATV

 **WARNING!**

Always follow proper procedures for turning as described in this Owner’s Manual. Practice turning at low speeds before attempting to turn at faster speeds. Do not turn at speeds too fast for your skills or the conditions. ATV could go out of control causing a collision or overturn.

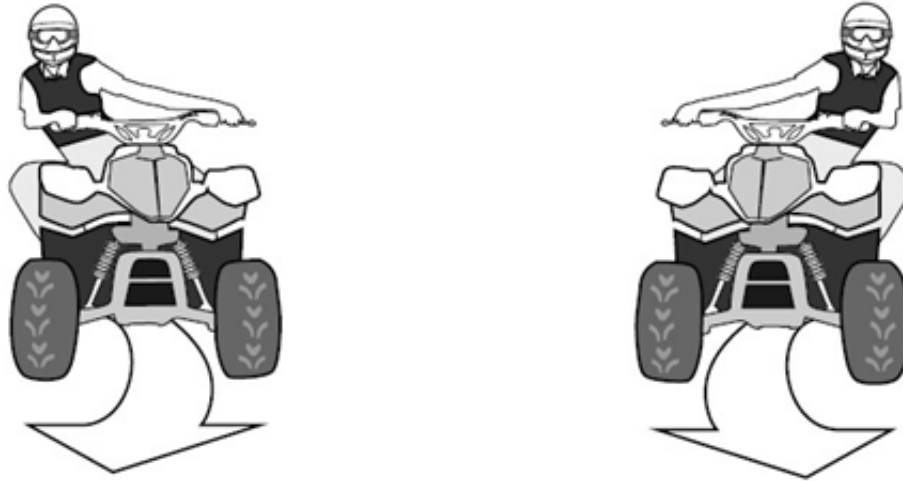

To achieve maximum traction while riding off-road, the two rear wheels turn together at the same speed. Therefore, unless the wheel on the inside of the turn is allowed to slip or lose some traction, the ATV will resist turning. A special turning technique must be used to allow the ATV to make turns quickly and easily. It is essential that this skill be learned first at low speed.

As you approach a curve, slow down and begin to turn the handlebars in the desired direction. As you do so, put your weight on the foot board to the outside of the turn (opposite your desired direction) and lean your upper body into the turn. Use the throttle to maintain an even speed through the turn. This maneuver will let the wheel on the inside of the turn slip slightly allowing the ATV to make the turn properly.

This procedure should be practiced at slow speed many times in a large off-road area with no obstacles. If an incorrect technique is used, your ATV may continue to go straight. If the ATV doesn't turn, come to a stop and then practice the procedure again. If the riding surface is slippery or loose, it may help to position more of your weight over the front wheels by moving forward on the seat.

Once you have learned this technique, you should be able to perform it at higher speeds or in tighter curves.

Improper riding procedures such as abrupt throttle changes, excessive braking, incorrect body movement or too much speed for the sharpness of the turn may cause the ATV to tip. If the ATV begins to tip over to the outside while negotiating a turn, lean more to the inside. It may also be necessary to gradually let off on the throttle and steer to the outside of the turn to avoid tipping over.

Remember: Avoid higher speeds until you are thoroughly familiar with the operation of your ATV.

CLIMBING UPHILL

CAUTION!

Climbing hills improperly can cause overturns or loss of control. Use proper riding techniques described in this Owner's Manual.

- ◆ Never operate the ATV on hills too steep for the ATV or for your abilities. The ATV can overturn more easily on extremely steep hills than on level surfaces or small hills.
- ◆ Always check the terrain carefully before you start up any hill. Never climb hills with excessively slippery or loose surfaces.

- ◆ Shift your weight forward.
- ◆ Never open the throttle suddenly. The ATV could flip over backwards.
- ◆ Never go over the top of any hill at high speed. An obstacle, a sharp drop or another vehicle or person could be on the other side of the hill.
- ◆ Never attempt to turn the ATV around on any hill until you have mastered the turning technique as described in the Owner's Manual on level ground. Be very careful when turning on any hill.
- ◆ Avoid crossing the side of a steep hill if possible. When crossing the side of a hill, shift your weight to the uphill side of the ATV.



Do not attempt to climb hills until you have mastered basic maneuvers on flat ground. Always check the terrain carefully before attempting any hill. In all cases avoid inclines with slippery or loose surfaces or obstacles that might cause you to lose control.

To climb a hill, you need traction, momentum and steady throttle. For more traction and control for climbing steeper and/or rougher slopes, select the "4WD" or 4WD-LOCK. Travel fast enough to maintain momentum but not so fast that you cannot react to changes in the terrain as you climb.

It is important when climbing a hill to make sure that your weight is transferred forward on the ATV. This can be accomplished by leaning forward and on steeper inclines, standing on the footboards and leaning forward over the handlebars. Whenever possible, ride straight up hills.

Slow down when you reach the crest of the hill if you cannot see clearly what is on the other side there could be another person, an obstacle or a sharp drop off. Use common sense and remember that some hills are too steep for you to climb or descend.

If you are climbing a hill and you find that you have not properly judged your ability to make it to the top, you should turn the ATV around while you still have forward motion and go down the hill. If your ATV has stalled or stopped and you believe you can continue up the hill, restart carefully to make sure you do not lift the front wheels which could cause you to lose control. If you are unable to continue up the hill, dismount the ATV on the uphill side. Physically turn the ATV around and then descend the hill.

If you start to roll backwards, DO NOT apply either brake abruptly. If you are in "2WD", apply only the front brake. When fully stopped, apply the rear brake as well and then shift to the park position. If you are in "4WD" because all wheels are interconnected by the drive train, applying either brake will brake all wheels, therefore avoid sudden application of either the front or rear brake as the wheels on the uphill side could come off the ground. The ATV could easily tip over backwards. Apply both the front and rear brakes gradually. When fully stopped, shift to the park position and dismount the ATV immediately on the uphill side or to a side if pointed straight uphill. Turn the ATV around and remount, following the procedure described in the Owner's Manual.

 **WARNING!**

Stalling, rolling backwards or improperly dismounting while climbing a hill could result in ATV overturning. If you cannot control the ATV, dismount immediately on the uphill side.

RIDING DOWN HILL

 **WARNING!**

Going down a hill improperly could cause overturns or loss of control. Always follow proper procedures for going down hills as described in this Owner's Manual.

- ◆ Always check the terrain carefully before you start down any hill.
- ◆ Never operate the ATV on hills too steep for the ATV or for your ability. The ATV can overturn more easily on extremely steep hills than on level surfaces or small hills.
- ◆ Shift your weight backward and to the uphill side.
- ◆ Never go down a hill at high speed.
- ◆ Avoid going down a hill at an angle that would cause the ATV to lean sharply to one side. Go straight down the hill where possible.
- ◆ Improper braking can cause the wheels on the hillside to come off the ground or cause loss of traction. Apply brakes gradually. If in "2WD", apply only the rear brake.

When riding your ATV downhill, shift your weight as far to the rear and uphill side of the ATV as possible. Move back on the seat and sit with your arms straight. Engine compression will do most of the braking for you. For maximum engine compression braking effect, select the low gear position and change to "4WD" before beginning to descend the hill.

Use caution while descending a hill with loose or slippery surfaces. Braking ability and traction may be adversely affected by these surfaces. Improper braking may also cause a loss of traction.

When this ATV is in "4WD", all wheels are interconnected by drive train. This means that applying either the front brake or the rear brake will brake all wheels. When descending hills, using either brake lever or the brake pedal will brake the wheels on the downhill side. Avoid sudden application of either the front or rear brake because the wheels on the uphill side could come off the ground. Apply both the front and rear brakes gradually.

Whenever possible, ride your ATV straight downhill. Avoid sharp angles, which could allow the ATV to tip or roll over. Carefully choose your path and ride no faster than you will be able to react to obstacles, which may appear.



CROSSING A SLOPE

WARNING!

Improperly crossing hills or turning on hills could cause loss of control or cause the ATV to overturn.

- ◆ Always follow proper procedures as described in the Owner's Manual.
- ◆ Avoid hills with excessively slippery or loose surfaces.
- ◆ Avoid crossing the side of a steep hill.
- ◆ Shift your weight to the uphill side of the ATV.
- ◆ Never attempt to turn the ATV around on any hill until you have mastered the turning technique as described in the Owner's Manual on level ground. Be very careful when turning on any hill.

Traversing a sloping surface on your ATV requires you to properly position your weight to maintain proper balance. Be sure that you have learned the basic riding skills on flat ground before attempting to cross a sloping surface. Avoid slopes with slippery surfaces or rough terrain that may upset your balance.

As you travel across a slope, lean your body in the uphill direction. It may be necessary to correct the steering when riding on loose surfaces by pointing the front wheels slightly uphill. When riding on slopes, be sure not to make sharp turns either up or down hill.

If your ATV does begin to tip over, gradually steer in the downhill direction if there are no obstacles in your path. As you regain proper balance, gradually steer again in the direction you wish to travel.



CROSSING THROUGH SHALLOW WATER

WARNING!

Operating this vehicle through deep or fast flowing water can lead to loss of control or an overturn. To reduce your risk of drowning or other injuries, use care when crossing through water. Never operate this ATV water deeper than the depth specified in your Owner's Manual, as tires may float, increasing the risk of an overturn.

The ATV can be used to cross slow moving, shallow water of up to maximum of 35 cm (14 in) in depth. Before entering the water, choose your path carefully. Enter where there is no sharp drop off, and avoid rocks or other obstacles, which may be slippery or upset the ATV. Drive slowly and carefully.

Test your brakes after leaving the water. If necessary apply them several times to let the friction dry out the linings. Do not continue to ride your ATV without verifying that you have regained proper braking ability.

 **WARNING!**

Wet brakes may have reduced stopping ability, which could cause loss of control.

After riding your ATV in water, be sure to drain the trapped water by removing the check hose at the bottom of the air filter case, remove the drive belt case drain bolt and front storage compartment drain plug to drain any water that may have accumulated.

 **NOTICE!**

Un-drained water can cause damage or improper operation.

RIDING OVER ROUGH TERRAIN

 **WARNING!**

Riding improperly over obstacles could cause loss of control or a collision. Before operating in a new area, check for obstacles. Never attempt to ride over large obstacles, such as large rocks or fallen trees. When you go over obstacles, always follow proper procedures as described in the Owner's Manual.

Riding over rough terrain should be done with caution. Look out for obstacles, which could cause damage to the ATV or could lead to an upset or accident. Be sure to keep your feet firmly mounted on the footboards at all times. Avoid jumping the ATV as loss of control and damage to the ATV may result.

SLIDING AND SKIDDING

 **WARNING!**

Skidding or sliding improperly may cause you to lose control of this ATV. You may also regain traction unexpectedly, which may cause the ATV to overturn.

- ◆ Learn to safety control skidding or sliding by practicing at low speeds and on level, smooth terrain.
- ◆ ON extremely slippery surfaces such as ice, go slowly and be very cautious in order to reduce the chance of skidding or sliding out of control.

Care should be used when riding on loose or slippery surfaces since the ATV may slide. If unexpected and uncorrected, sliding could lead to an accident.

To reduce the tendency for the front wheels to slide in loose or slippery conditions, positioning your weight over the front wheels will sometimes help.

If the rear wheels of your ATV start to slide sideways, control can usually be regained by steering in direction of the slide. Applying the brakes or accelerating is not recommended until you have corrected the slide.

With practice, over a period of time, skill at controlled sliding can be developed. The terrain should be chosen carefully before attempting such maneuvers since both stability and control are reduced. Bear in mind that sliding maneuvers should always be avoided on extremely slippery surfaces, such as ice, since all control may be lost.

WHAT TO DO

◆ **If your ATV doesn't turn when you want it to:**

Bring ATV to a stop and practice the turning maneuvers again. Be sure you are putting your weight on the foot board to the outside of the turn. Position your weight over the front wheels for better control

◆ **If your ATV begins to tip while turning:**

Lean more into the turn to regain balance. If necessary, gradually let off the throttle and / or steer to the outside of the turn.

◆ **If your ATV starts to slide sideways:**

Steer in direction of the slide if you have the room. Applying the brakes or accelerating is not recommended until you have corrected the slide.

◆ **If your ATV can't make it up a hill you are trying to climb:**

Turn the ATV around if you still have forward speed. If not, stop, dismount on the uphill side of the ATV and physically turn the ATV around. If the ATV starts to slip backwards, DO NOT USE THE REAR BRAKE IF THE ATV IS IN "2WD"- The ATV may tip over on top of you. Dismount the ATV on the uphill side.

◆ **If your ATV is traversing a sloping surface:**

Be sure to ride with your weight positioned towards the uphill side of the ATV to maintain proper balance. If the ATV starts to tip, steer down the hill to regain balance. If you discover that the ATV is going to tip over, dismount on the uphill side.

◆ **If your ATV encounters shallow water:**

Ride slowly and carefully through slow moving water, watching for obstacles. Be sure to let water drain from the ATV and CHECK YOUR BRAKES FOR PROPER OPERATION when you come out of the water. DO not continue to ride your ATV until you have regained adequate braking ability.

PERIODIC MAINTENANCE

Periodic inspection, adjustment and lubrication will keep your vehicle in the safest and most efficient condition possible. Safety is an obligation of the vehicle owner/operator.



WARNING!

Failure to properly maintain the vehicle or performing maintenance activities incorrectly may increase your risk of injury or death during service or while using the vehicle. If you are not familiar with vehicle service, have a dealer perform the service.



WARNING!

Turn off the engine when performing maintenance unless otherwise specified.

- ◆ A running engine has moving parts that can catch on body parts or clothing and electrical parts that can cause shocks or fires.
- ◆ Running the engine while servicing can lead to eye injury, burns, fire or carbon monoxide poisoning possibly leading to death.



WARNING!

Brake discs, calipers, drums and linings can become very hot during use. To avoid possible burns, let brake components cool before touching them.

The intervals given in the periodic maintenance charts should be considered as a general guide under normal riding conditions. However, **depending on the weather, terrain, geographical location and individual use, the maintenance intervals may need to be shortened.**

NO.	ITEM	Check or maintenance job	Whichever comes first	INITIAL		EVERY		
				MONTH	1	3	6	12
				Km	200	1000	2000	4000
				Mi	120	600	1200	2400
1	Exhaust system	◆Check for leakage and replace gasket if necessary		T	T	T	T	
		◆Check for looseness and tighten all screw clamps and joints if necessary		I	I	I	I	
2	Valves	◆Check valve clearance and adjust if necessary		I		I	I	
3	Air filter element	◆Clean and replace if necessary			I	I	I	
4	Spark plug	◆Check condition and clean, re-gap or replace if necessary				I	I	
5	Engine oil	◆Change						
		◆Check ATV for oil leakage and correct if necessary		R		R	R	

6	Engine oil filter	◆Replace	R		R	R
7	Engine oil strainer	◆Clean	I		I	I
8	Differential gear oil	◆Change	R		R	R
		◆Check ATV for oil leakage and correct if necessary	Replace every 4 years			
9	Final gear oil	◆Change	R		R	R
		◆Check ATV for oil leakage and correct if necessary	Replace every 4 years			
10	Fuel line	◆Check fuel hoses for cracks or other damage and replace if necessary			I	I
11	Fuel filter	◆Replace	Every 2 years			
12	Front brake	◆Check operation and correct if necessary				
		◆Check fluid level and ATV for fluid leakage and correct if necessary	I	I	I	I
		wReplace brake pads	Whenever worn to the limit			
13	Rear brake	◆Check operation and correct if necessary				
		◆Check the brake lever and pedal free play and adjust if necessary	I	I	I	I
		◆Check brake friction plate wear and replace if necessary	I	I	I	I
14	Brake hoses	◆Check for cracks or other damage and replace if necessary		I	I	I
		◆Replace	Every 4 years			
15	Wheels	◆Check run out and for damage and replace if necessary	I		I	I
16	Tires	◆Check tread depth and for damage and replace if necessary			I	I
		◆Check air pressure and balance and correct it if necessary			I	I
17	Wheel hub bearings	◆Check for looseness or damage and replace if necessary	I		I	I
18	Drive Belt	◆Check for wear, cracks or other damage and replace if necessary			I	I
19	Drive shaft universal joint	◆Lubricate with grease			L	L
20	Chassis fasteners	◆Make sure that all nuts, bolts and screws are properly tightened	T	T	T	T

21	Shock absorber assemblies	<ul style="list-style-type: none"> ◆ Check operation and correct if necessary ◆ Check for oil leakage and replace if necessary 			I	I
22	Rear knuckle pivots	<ul style="list-style-type: none"> ◆ Lubricate with grease 			L	L
23	Steering shaft	<ul style="list-style-type: none"> ◆ Lubricate with grease 			L	L
24	Steering system	<ul style="list-style-type: none"> ◆ Check operation and repair or replace if damaged ◆ Check toe-in and adjust if necessary 	I	I	I	I
25	Engine mount	<ul style="list-style-type: none"> ◆ Check for the cracks or other damage and replace if necessary 			I	I
26	Transmission boots	<ul style="list-style-type: none"> ◆ Check for the cracks or other damage and replace if necessary 	I	I	I	I

L: Lubricate **C:** Clean **R:** Replace
T: Tighten **I:** Inspection, cleaning and adjustment

Have your ATV serviced and checked by an authorized dealer. Ensure the service book is stamped and signed. Failure to do so could invalidate your warranty. The maintenance schedule is based on months of use or kilometers traveled. Do the scheduled maintenance based on whichever comes first.

 **CAUTION!**

- ◆ Some maintenance items need more frequent service if you are riding in unusually wet, sandy or muddy areas or at full throttle.
- ◆ Hydraulic brake service
- ◆ Regularly check and if necessary correct the brake fluid level.
- ◆ Every two years replace the internal components of the brake master cylinder and calipers and change the brake fluid.
- ◆ Replace the brake hoses every four years and if cracked or damaged.
- ◆ Remove the carbon deposits in cylinder head, piston and exhaust system when power is obviously lower than normal.
- ◆ Perform maintenance and check when continuous abnormal misfire, after-fire and overheating occur.

CLEANING AND STORAGE

Cleaning

Frequent, thorough cleaning of your ATV will not only enhance its appearance but will improve its general performance and extend the useful life of many components.

1. Before cleaning the ATV:
 - a. Block off the end of the exhaust pipe to prevent water entry. A plastic bag and strong rubber band may be used.
 - b. Make sure the spark plug and all filler caps are properly installed.
2. If the engine case is excessively greasy, apply degreaser with a paintbrush. Do not apply degreaser to wheel axles.
3. Rinse the dirt and degreaser off with a garden hose. Use only enough pressure to do the job.

**WARNING!**

- Wet brakes may have reduced stopping ability, increasing the chance of an accident. Test the brakes after washing. Apply the brakes several times at slow speeds to let friction dry out the linings.
- Excessive water pressure may cause water seepage and deterioration of wheel bearing, brakes, transmission seals and electrical devices. Many expensive repair bills have resulted from improper high-pressure detergent applications such as those available in coin-operated car washers.

4. Once most of the dirt has been hosed off, wash all surfaces with warm water and mild, detergent-type soap. An old toothbrush or bottlebrush is handy for hard to reach places.
5. Rinse the ATV off immediately with clean water and dry all surfaces with a chamois, clean towel or soft absorbing cloth.
6. Clean the seat with vinyl upholstery cleaner to keep the cover pliable and glossy.
7. Automotive type wax may be applied to all painted and chrome plated surfaces. Avoid combination cleaner-waxes. Many contain abrasives, which may mar the paint or protective finish. When finished cleaning, start the engine and let it idle for several minutes.

Storage

Short-term

Always store your ATV in a cool, dry place and if necessary, protect it against dust with a porous cover.

**WARNING!**

Storing the ATV in a poorly ventilated room or covering it with a tarp while it is still wet, will allow water and humidity to seep in and cause rust. To prevent corrosion, avoid damp cellars, stables and area where strong chemicals are stored.

Long-term

Before storing your ATV for several months:

1. Follow all the instructions in the “Cleaning” section of this chapter.
2. Turn the fuel cock lever to “OFF”.
3. Fill up the fuel tank and add fuel stabilizer to prevent the fuel from deteriorating.
4. Perform the following steps to protect the cylinder, piston rings, etc. from corrosion.
 - a. Remove the spark plug cap and spark plug.
 - b. Pour a teaspoonful of engine oil into the spark plug bore.
 - c. Install the spark plug cap onto the spark plug and then place the spark plug on the cylinder head so that the electrodes are grounded.
 - d. Turn the engine over several times with the starter.
 - e. Remove the spark plug cap from the spark plug and then install the spark plug and the spark plug cap.
5. Lubricate all control cables and the pivoting points of all levers and pedals.
6. Check and if necessary, correct the tire air pressure and then block up the ATV so that all of its wheels are off the ground. Alternatively, turn the wheels a little every month in order to prevent the tires from becoming degraded in one spot.
7. Cover the muffler outlet with a plastic bag to prevent moisture from entering it.
8. Remove the battery and fully charge it. Store it in a cool, dry place and charge it once a month. Do not store the battery in an excessively cold or warm place less than 0oC or more than 30oC.
9. Make necessary repairs before storing the ATV.

TROUBLE SHOOTING

Contact your dealer for service if you're unable to identify solutions using the following charts.

Engine doesn't turn over.

Possible cause	Solution
Tripped circuit breaker	Reset the breaker
Low battery voltage	Recharge battery to 12.5 VDC
Loose battery connections	Check all connections and ignition
Loose solenoid connections	Check all connections and ignition

Engine turns over but fails to start

Possible cause	Solution
Out of fuel	Refuel
Clogged fuel filter	Inspect and clean or replace
Water is present in fuel	Drain the fuel system and refuel
Fouled or defective spark plug	Inspect plug, replace if necessary
Crankcase filled with water or fuel	Immediately see your dealer
Clogged fuel filter	Replace the filter
Low battery voltage	Recharge battery to 12.5 VDC
Mechanical failure	See your dealer

Engine pins or knocks

Possible cause	Solution
Poor quality or low octane fuel	Replace with recommended fuel
Incorrect ignition timing	See your dealer
Incorrect spark plug gap or heat range	Set gap to specs or replace plugs

Engine backfires

Possible cause	Solution
Weak spark from spark plugs	Inspect, clean and/or replace spark plugs
Incorrect spark plug gap or heat range	Set gap to specs or replace plugs
Old or non-recommended fuel	Replace with new fuel
Incorrectly installed spark plug wires	See your dealer
Incorrect ignition timing	See your dealer
Mechanical failure	See your dealer

Engine run irregularly, stalls or misfires

Possible weak spark cause	Solution
Fouled or defective spark plugs	Inspect, clean and/or replace spark plugs
Worn or defective spark plug wires	See your dealer
Incorrect spark plug gap or heat range	Set gap to specs or replace plugs

Loose ignition connections	Check all connections and tighten
Water present in fuel	Replace with new fuel
Low battery voltage	Recharge battery to 12.5 VDC
Kinked or plugged fuel vent line	Inspect and replace
Incorrect fuel	Replace with recommended fuel
Clogged air filter	Inspect and clean or replace
Reverse speed limiter malfunction	See your dealer
Electronic throttle control malfunction	See your dealer
Other mechanical failure	See your dealer
Possible lean mixture fuel cause	Solution
Low or contaminated fuel	Add or change fuel, clean the fuel system
Low octane fuel	Replace with recommended fuel
Clogged fuel filter	Replace filter
Possible rich mixture fuel cause	Solution
Fuel is very high octane	Replace with lower octane fuel

Engine stops or loses power

Possible cause	Solution
Out of fuel	Refuel
Kinked or plugged fuel vent line	Inspect and replace
Water present in fuel	Replace with new fuel
Fouled or defective spark plugs	Inspect, clean and/or replace spark plugs
Worn or defective spark plug wires	See your dealer
Incorrect spark plug gap or heat range	Set gap to specs or replace plugs
Loose ignition connections	Check all connections and tighten
Low battery voltage	Recharge battery to 12.5 VDC
Incorrect fuel	Replace with recommended fuel
Clogged air filter	Inspect and clean or replace
Reverse speed limiter malfunction	See your dealer
Electronic throttle control malfunction	See your dealer
Other mechanical failure	See your dealer
Overheated engine	Clean radiator screen and core if equipped Clean engine exterior See your dealer

MAINTENANCE RECORD

P.D.I.

Date:

Odometer reading:

Dealer stamp:

1st Service.

Date:

Odometer reading:

Dealer stamp:

2nd Service.

Date:

Odometer reading:

Dealer stamp:

3rd Service.

Date:

Odometer reading:

Dealer stamp:

4th Service.

Date:

Odometer reading:

Dealer stamp:

5th Service.

Date:

Odometer reading:

Dealer stamp:

6th Service

Date:

Odometer reading:

Dealer stamp:

7th Service.

Date:

Odometer reading:

Dealer stamp:

8th Service. Date:

Odometer reading:

Dealer stamp:

9th Service. Date:

Odometer reading:

Dealer stamp:

10th Service. Date:

Odometer reading:

Dealer stamp:

11th Service. Date:

Odometer reading:

Dealer stamp:

12th Service. Date:

Odometer reading:

Dealer stamp:

13th Service. Date:

Odometer reading:

Dealer stamp:

14th Service Date:

Odometer reading:

Dealer stamp:

15th Service. Date:

Odometer reading:

Dealer stamp:

CONSUMER INFORMATION

IDENTIFICATION NUMBER

Record the key identification number, vehicle identification number and model label information in the spaces provided below for assistance when ordering spare parts from your dealer or for reference in case the ATV is stolen.

KEY IDENTIFICATION NUMBER:

VEHICLE IDENTIFICATION (FRAME) NUMBER:

KEY IDENTIFICATION NUMBER

The key identification number is stamped into the key. Record this number in the space provided and uses it for reference when ordering a new key.



Vehicle identification (frame) number is stamped into the frame The vehicle identification number is used to identify your ATV.

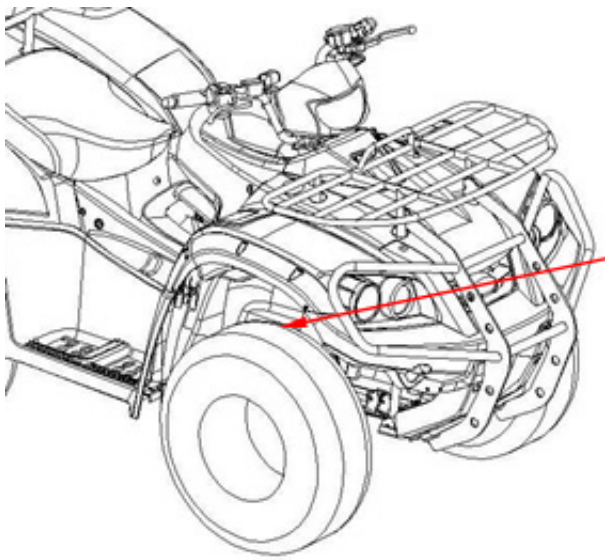



LIMITED WARRANTY

ARGO warrants its vehicles, sold by authorized ARGO dealers, from defects in material or workmanship for the period and under the conditions described herein.

The ARGO must be purchased as new and unused by its first owner from an Authorized ARGO Dealer in the country in which the sale occurred.

If the ownership of a product is transferred during the warranty coverage period, this limited warranty, subject to its terms and conditions, shall also be transferred.

This warranty covers parts and labour charges for repair or replacement of defective parts. Parts must be genuine ARGO parts, and repairs must be performed by an authorized ARGO Dealer. Dealers must keep defective parts for 90 days following the repair, in the event that ARGO requires the part for further inspection.

WARRANTY COVERAGE PERIOD

The warranty period is limited to 12 months from the date of sale, for personal or commercial use. For emission-related components; please also refer to the US EPA Emission Related Warranty contained herein. The repair or replacement of parts or the performance of service under this warranty does not extend the life of this warranty beyond its original expiration date.

WARRANTY LIMITATIONS & EXCLUSIONS

This ARGO limited warranty will become null and void if:

- The ARGO was used for racing or any other competitive activity, at any point, even by a previous owner.
- The ARGO was operated in a manner inconsistent with the recommended operation described in the ARGO Operator's Manual.
- The ARGO has been altered or modified in such a way so as to affect its operation, performance or durability, or has been altered or modified to change its intended use.
- The scheduled maintenance per the ARGO Operator's Manual has not been followed.
- The mandatory Pre-Delivery Inspection (PDI) has not been completed and documented by an authorized ARGO dealer.

This ARGO limited warranty does not cover the following items:

- Failures that are not caused by a defect in material or workmanship.
- Claims of defective design.
- Damage caused by Acts of God
- Accidental damage
- Normal wear and tear



GO
ANYWHERE

- Damages or failures resulting from improper lubrication and fluids; See the Operator's Manual for ARGO approved lubricants and procedures.
- Damage caused by failure to provide proper maintenance and/or storage, as described in the ARGO Operator's Manual.
- Damage caused by abuse, abnormal use, neglect or operation of the product in a manner inconsistent with the recommended operation described in the ARGO Operator's Manual.
- Damage caused by use of aftermarket or unapproved components, accessories, or attachments
- Unauthorized repairs; or repairs made by an unauthorized repair center.
- Incidental or consequential damages, or damages of any kind including without limitation towing, storage, telephone, rental, taxi, inconvenience, insurance coverage, loan payments, loss of time, loss of income.

WHAT TO DO TO OBTAIN WARRANTY COVERAGE

The customer must cease using the ARGO upon the appearance of an anomaly. The customer must notify an authorized ARGO dealer within three (3) days of the appearance of a defect, and provide it with reasonable access to the product and reasonable opportunity to repair it.

Please contact an authorized ARGO dealer to resolve any warranty issues.



U.S. EPA & CARB EVAPORATIVE EMISSIONS WARRANTY COVERAGE

ARGO warrants to the purchaser and each subsequent purchaser that the ARGO emissions system is:

- Designed, built and equipped so as to conform with all applicable regulations
- Free from defects in materials and workmanship that cause the failure of a warranted part to be identical in all material respects to that part as described in ARGO's application for certification. The warranty period is limited to 30 months from date of sale.

Subject to certain conditions and exclusions as stated below, the warranty on emission-related parts is as follows:

- Any warranted part that is not scheduled for replacement as required maintenance in the written instructions supplied, is warranted for the warranty period stated above. If the part fails during the period of warranty coverage, the part will be repaired or replaced by ARGO. Any such part repaired or replaced under warranty will be warranted for the remainder of the period.
- Any warranted part that is scheduled only for regular inspection in the written instructions supplied is warranted for the warranty period stated above. Any such part repaired or replaced under warranty will be warranted for the remaining warranty period.
- Any warranted part that is scheduled for replacement as required maintenance in the written instructions supplied is warranted for the period of time before the first scheduled replacement date for that part. If the part fails before the first scheduled replacement, the part will be repaired or replaced by. Any such part repaired or replaced under warranty will be warranted for the remainder of the period prior to the first scheduled replacement point for the part.
- Repair or replacement of any warranted part under the warranty provisions herein must be performed at a warranty station at no charge to the owner.
- The Argo owner will not be charged for diagnostic labor that is directly associated with diagnosis of a defective, emission-related warranted part, provided that such diagnostic work is performed at a warranty station.
- ARGO is liable for damages to other engine or equipment components proximately caused by a failure under warranty of any warranted part.
- Throughout the ARGO warranty period stated above, ARGO will maintain a supply of warranted parts sufficient to meet the expected demand for such parts.
- Any replacement part may be used in the performance of any warranty maintenance or repairs and must be provided without charge to the owner. Such use will not reduce the warranty obligations of ARGO.
- Add-on or modified parts that are not exempted by the Air Resources Board may not be used. The use of any non-exempted add-on or modified parts by the purchaser will be grounds for disallowing a warranty claims. ARGO will not be liable to warrant failures of warranted parts caused by the use of a non-exempted add-on or modified part.



U.S. EPA & CARB EVAPORATIVE EMISSIONS WARRANTED PARTS:

The repair or replacement of any warranted part otherwise eligible for warranty coverage may be excluded from such warranty coverage if ARGO demonstrates that the vehicle has been abused, neglected, or improperly maintained, and that such abuse, neglect, or improper maintenance was the direct cause of the need for repair or replacement of the part. That notwithstanding, any adjustment of a component that has a factory installed, and properly operating, adjustment limiting device is still eligible for warranty coverage. The following emission warranty parts are covered:

For exhaust emissions, emission-related components include any engine parts related to the following systems:

1. Air-induction system
2. Fuel system
3. Ignition system
4. Exhaust gas recirculation systems

The following parts are also considered emission-related components for exhaust emissions:

1. Aftertreatment devices
2. Crankcase ventilation valves
3. Sensors
4. Electronic control units

The following parts are considered emission-related components for evaporative emissions:

1. Fuel Tank
2. Fuel Cap
3. Fuel Line
4. Fuel Line Fittings
5. Clamps*
6. Pressure Relief Valves*
7. Control Valves*
8. Control Solenoids*
9. Electronic Controls*
10. Vacuum Control Diaphragms*
11. Control Cables*
12. Control Linkages*
13. Purge Valves
14. Vapor Hoses†
15. Liquid/Vapor Separator
16. Carbon Canister†
17. Canister Mounting Brackets
18. Carburetor Purge Port Connector

*As related to the evaporative emission control system.

†Applicable to California models only.