



CENTER OF TECHNOLOGICAL INITIATIVES, LLC

info@cti-sumy.com.ua

Custom-made machines for you



Welding machine



Welding machine



Welding machine

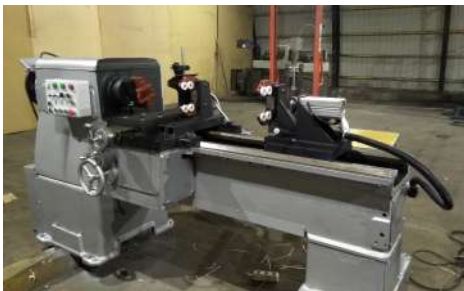

Semi-automatic welding machine

Contact us:

 <http://cti-sumy.com.ua>

 info@cti-sumy.com.ua
sales1@cti-sumy.com.ua

 <https://www.facebook.com/cti.sumy>

 <https://www.youtube.com/channel/UCyYGmKVZ2FwZnoX4RV8Is0g>

This manual is brought to you by CTI LLC.

We have more than 10 years of experience in machine building and will gladly help you to increase productivity at your manufacturing facility!

Taking into account the peculiarities of your manufacture we can make a custom machine that will help you simplify the production process.

We offer to perform the whole range of works:



Designing



Production



Assembly



GE Fanuc Automation

Computer Numerical Control Products

Series 0i-Model C
Series 0i Mate-Model C

Parameter Manual

GFZ-64120EN/01

June 2004

Warnings, Cautions, and Notes as Used in this Publication

Warning

Warning notices are used in this publication to emphasize that hazardous voltages, currents, temperatures, or other conditions that could cause personal injury exist in this equipment or may be associated with its use.

In situations where inattention could cause either personal injury or damage to equipment, a Warning notice is used.

Caution

Caution notices are used where equipment might be damaged if care is not taken.

Note

Notes merely call attention to information that is especially significant to understanding and operating the equipment.

This document is based on information available at the time of its publication. While efforts have been made to be accurate, the information contained herein does not purport to cover all details or variations in hardware or software, nor to provide for every possible contingency in connection with installation, operation, or maintenance. Features may be described herein which are not present in all hardware and software systems. GE Fanuc Automation assumes no obligation of notice to holders of this document with respect to changes subsequently made.

GE Fanuc Automation makes no representation or warranty, expressed, implied, or statutory with respect to, and assumes no responsibility for the accuracy, completeness, sufficiency, or usefulness of the information contained herein. No warranties of merchantability or fitness for purpose shall apply.

DEFINITION OF WARNING, CAUTION, AND NOTE

This manual includes safety precautions for protecting the user and preventing damage to the machine. Precautions are classified into Warning and Caution according to their bearing on safety. Also, supplementary information is described as a Note. Read the Warning, Caution, and Note thoroughly before attempting to use the machine.

 **WARNING**

Applied when there is a danger of the user being injured or when there is a danger of both the user being injured and the equipment being damaged if the approved procedure is not observed.

 **CAUTION**

Applied when there is a danger of the equipment being damaged, if the approved procedure is not observed.

NOTE

The Note is used to indicate supplementary information other than Warning and Caution.

- Read this manual carefully, and store it in a safe place.

PREFACE

The models covered by this manual, and their abbreviations are :

Model name		Abbreviation	
FANUC Series 0i -TC	0i -TC	Series 0i -C	0i
FANUC Series 0i -MC	0i -MC		
FANUC Series 0i Mate -TC	0i Mate -TC	Series 0i Mate -C	0i Mate
FANUC Series 0i Mate -MC	0i Mate -MC		

NOTE

- 1 For ease of explanation, the models may be classified as follows:
 T series: 0i -TC/0i Mate -TC
 M series: 0i -MC/0i Mate -MC
- 2 Some functions described in this manual may not be applied to some products.
 For details, refer to the DESCRIPTIONS (B-64112EN).
- 3 The 0i /0i Mate requires setting of parameters to enable part of basic functions. For the parameters to be set, see Section 4.46, "PARAMETERS OF FS0i BASIC FUNCTIONS".

Related manuals of Series 0i/0iMate-MODEL C

The following table lists the manuals related to Series 0i/0iMate-MODEL C. This manual is indicated by an asterisk(*).

Related manuals of Series 0i/0iMate-MODEL C

Manual name	Specification number	
DESCRIPTIONS	B-64112EN	
CONNECTION MANUAL (HARDWARE)	B-64113EN	
CONNECTION MANUAL (FUNCTION)	B-64113EN-1	
Series 0i-TC OPERATOR'S MANUAL	B-64114EN	
Series 0i-MC OPERATOR'S MANUAL	B-64124EN	
Series 0iMate-TC OPERATOR'S MANUAL	B-64134EN	
Series 0iMate-MC OPERATOR'S MANUAL	B-64144EN	
MAINTENANCE MANUAL	B-64115EN	
PARAMETER MANUAL	B-64120EN	*
PMC		
PMC Ladder Language PROGRAMMING MANUAL	B-61863E	
PMC C Language PROGRAMMING MANUAL	B-61863E-1	
Network		
Profibus-DP Board OPERATOR'S MANUAL	B-62924EN	
FAST Ethernet Board/FAST DATA SERVER OPERATOR'S MANUAL	B-63644EN	
Ethernet Board/DATA SERVER Board OPERATOR'S MANUAL	B-63354EN	
DeviceNet Board OPERATOR'S MANUAL	B-63404EN	
PC function		
Screen Display Function OPERATOR'S MANUAL	B-63164EN	
Open CNC		
FANUC Open CNC OPERATOR'S MANUAL (Basic Operation Package 1(For Windows 95/NT))	B-62994EN	
FANUC Open CNC OPERATOR'S MANUAL (DNC Operation Management Package)	B-63214EN	

Related manuals of SERVO MOTOR α is/ α i/ β is/ β i series

The following table lists the manuals related to SERVO MOTOR α is/ α i/ β is/ β i series

Manual name	Specification number
FANUC AC SERVO MOTOR α is series FANUC AC SERVO MOTOR α i series DESCRIPTIONS	B-65262EN
FANUC AC SPINDLE MOTOR α i series DESCRIPTIONS	B-65272EN
FANUC AC SERVO MOTOR β is series DESCRIPTIONS	B-65302EN
FANUC AC SPINDLE MOTOR β i series DESCRIPTIONS	B-65312EN
FANUC SERVO AMPLIFIER α i series DESCRIPTIONS	B-65282EN
FANUC SERVO AMPLIFIER β i series DESCRIPTIONS	B-65322EN
FANUC SERVO MOTOR α is series FANUC SERVO MOTOR α i series FANUC AC SPINDLE MOTOR α i series FANUC SERVO AMPLIFIER α i series MAINTENANCE MANUAL	B-65285EN
FANUC SERVO MOTOR β is series FANUC AC SPINDLE MOTOR β i series FANUC SERVO AMPLIFIER β i series MAINTENANCE MANUAL	B-65325EN
FANUC AC SERVO MOTOR α is series FANUC AC SERVO MOTOR α i series FANUC AC SERVO MOTOR β is series PARAMETER MANUAL	B-65270EN
FANUC AC SPINDLE MOTOR α i series FANUC AC SPINDLE MOTOR β i series PARAMETER MANUAL	B-65280EN

TABLE OF CONTENTS

DEFINITION OF WARNING, CAUTION, AND NOTE	s-1
PREFACE	p-1
1 DISPLAYING PARAMETERS.....	1
2 SETTING PARAMETERS FROM MDI	3
3 INPUTTING AND OUTPUTTING PARAMETERS THROUGH THE READER/PUNCHER INTERFACE	5
3.1 OUTPUTTING PARAMETERS THROUGH THE READER/PUNCHER INTERFACE	6
3.2 INPUTTING PARAMETERS THROUGH THE READER/PUNCHER INTERFACE	7
4 DESCRIPTION OF PARAMETERS	8
4.1 PARAMETERS OF SETTING.....	10
4.2 PARAMETERS OF READER/PUNCHER INTERFACE, REMOTE BUFFER, DNC1, DNC2, AND M-NET INTERFACE.....	15
4.2.1 Parameters Common to all Channels.....	16
4.2.2 Parameters of Channel 1 (I/O CHANNEL=0)	17
4.2.3 Parameters of Channel 1 (I/O CHANNEL=1)	19
4.2.4 Parameters of Channel 2 (I/O CHANNEL=2)	19
4.3 PARAMETERS OF DNC2 INTERFACE	22
4.4 PARAMETERS OF REMOTE DIAGNOSIS.....	25
4.5 PARAMETER OF MEMORY CARD INTERFACE	28
4.6 PARAMETERS OF DATA SERVER.....	29
4.7 PARAMETERS OF ETHERNET.....	30
4.8 PARAMETERS OF POWER MATE CNC MANAGER.....	31
4.9 PARAMETERS OF AXIS CONTROL/INCREMENT SYSTEM.....	32
4.10 PARAMETERS OF COORDINATES.....	44
4.11 PARAMETERS OF STROKE CHECK.....	50
4.12 PARAMETERS OF THE CHUCK AND TAILSTOCK BARRIER (T SERIES).....	56
4.13 PARAMETERS OF FEEDRATE	60
4.14 PARAMETERS OF ACCELERATION/DECELERATION CONTROL	79
4.15 PARAMETERS OF SERVO (1 OF 2)	102
4.16 PARAMETERS OF DI/DO	137

4.17	PARAMETERS OF DISPLAY AND EDIT (1 OF 2).....	143
4.18	PARAMETERS OF PROGRAMS	169
4.19	PARAMETERS OF PITCH ERROR COMPENSATION	178
4.20	PARAMETERS OF SPINDLE CONTROL	186
4.21	PARAMETERS OF TOOL COMPENSATION	223
4.22	PARAMETERS OF CANNED CYCLES.....	235
4.22.1	Parameter of canned Cycle for Drilling.....	235
4.22.2	Parameter of Thread Cutting Cycle.....	242
4.22.3	Parameter of Multiple Repetitive Canned Cycle.....	242
4.22.4	Parameters of Peck Drilling Cycle of a Small Diameter	246
4.23	PARAMETERS OF RIGID TAPPING	251
4.24	PARAMETERS OF SCALING/COORDINATE ROTATION	275
4.25	PARAMETERS OF UNI-DIRECTIONAL POSITIONING	277
4.26	PARAMETERS OF POLAR COORDINATE INTERPOLATION	279
4.27	PARAMETERS OF NORMAL DIRECTION CONTROL.....	281
4.28	PARAMETERS OF INDEXING INDEX TABLE.....	285
4.29	PARAMETERS OF CUSTOM MACROS	287
4.30	PARAMETERS OF PATTERN DATA INPUT	296
4.31	PARAMETERS OF SKIP FUNCTION	297
4.32	PARAMETERS OF AUTOMATIC TOOL COMPENSATION (T SERIES) AND AUTOMATIC TOOL LENGTH COMPENSATION (M SERIES)	303
4.33	PARAMETERS OF EXTERNAL DATA INPUT/OUTPUT	305
4.34	PARAMETERS OF GRAPHIC DISPLAY	306
4.34.1	Parameters of Graphic Display/Dynamic Graphic Display.....	306
4.34.2	Parameters of Graphic Color.....	308
4.35	PARAMETERS OF DISPLAYING OPERATION TIME AND NUMBER OF PARTS.....	311
4.36	PARAMETERS OF TOOL LIFE MANAGEMENT	315
4.37	PARAMETERS OF POSITION SWITCH FUNCTIONS.....	321
4.38	PARAMETERS OF MANUAL OPERATION AND AUTOMATIC OPERATION.....	325
4.39	PARAMETERS OF MANUAL HANDLE FEED, MANUAL HANDLE INTERRUPTION AND TOOL DIRECTION HANDLE FEED	330
4.40	PARAMETERS OF BUTT-TYPE REFERENCE POSITION SETTING.....	334
4.41	PARAMETERS OF SOFTWARE OPERATOR'S PANEL	336
4.42	PARAMETERS OF PROGRAM RESTART	339
4.43	PARAMETERS OF POLYGON TURNING	340

4.44	PARAMETERS OF GENERAL-PURPOSE RETRACTION	343
4.45	PARAMETERS OF AXIS CONTROL BY PMC	345
4.46	PARAMETERS OF FS0i BASIC FUNCTIONS	352
4.47	PARAMETERS OF ANGULAR AXIS CONTROL	355
4.48	PARAMETERS OF SIMPLE SYNCHRONOUS CONTROL	358
4.49	PARAMETERS OF SEQUENCE NUMBER COMPARISON AND STOP ..	367
4.50	OTHER PARAMETERS	368
4.51	PARAMETERS OF FAILURE DIAGNOSIS	373
4.52	PARAMETERS OF MAINTENANCE	374
4.53	PARAMETERS OF SERVO SPEED CHECK	375
4.54	PARAMETERS OF MANUAL HANDLE FUNCTION	376
4.55	PARAMETERS OF ACCELERATION CONTROL	378
4.56	PARAMETERS OF OPERATION HISTORY	380
4.57	PARAMETERS OF DISPLAY AND EDIT (2/2)	385
4.58	PARAMETERS OF MACHINING CONDITION SELECTION	387
4.59	PARAMETERS OF SERVO (2)	391



APPENDIX

A	CHARACTER CODE LIST	395
----------	----------------------------------	------------

1

DISPLAYING PARAMETERS

Follow the procedure below to display parameters.

- (1) Press the  function key on the MDI as many times as required, or alternatively, press the  function key once, then the PARAM section display soft key. The parameter screen is then selected.

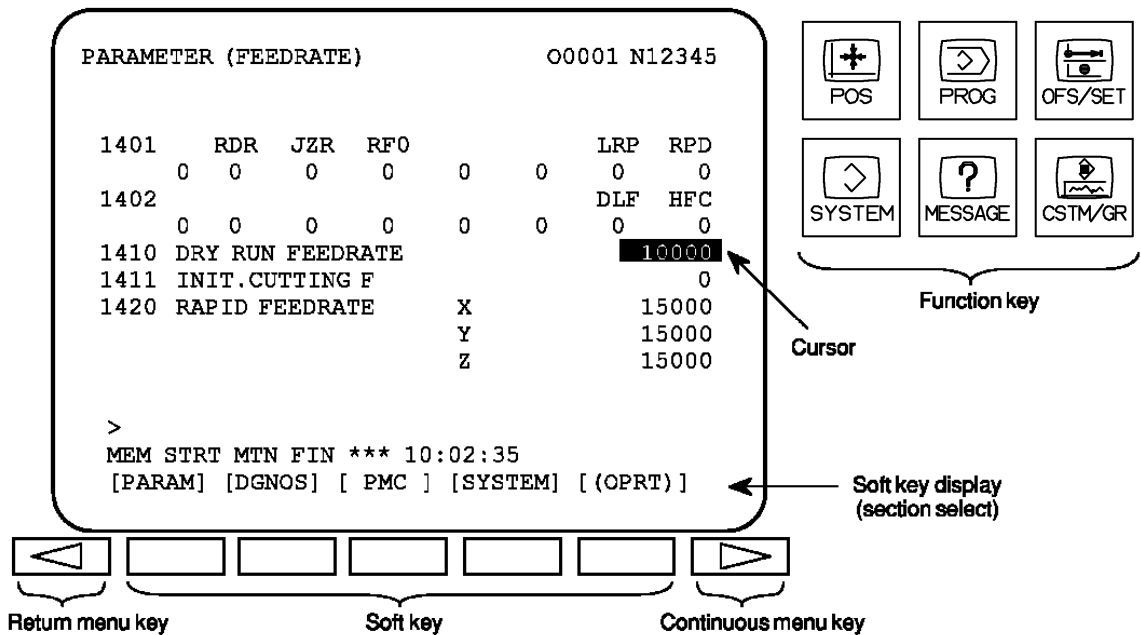

- (2) The parameter screen consists of multiple pages. Use step (a) or (b) to display the page that contains the parameter you want to display.
 - (a) Use the page select key or the cursor move keys to display the desired page.
 - (b) Enter the data number of the parameter you want to display from the keyboard, then press the [NO.SRH] soft key. The parameter page containing the specified data number appears with the cursor positioned at the data number. (The data is displayed in reverse video.)

NOTE
 If key entry is started with the section select soft keys displayed, they are replaced automatically by operation select soft keys including [NO.SRH]. Pressing the [(OPRT)] soft key can also cause the operation select keys to be displayed.



```
>  
MEM STRT MTN FIN *** 10:02:34  
[NO.SRH] [ ON:1 ] [ OFF:0 ] [+INPUT] [INPUT ]
```

← Data entered from the keyboard
← Soft key display (section select)

2

SETTING PARAMETERS FROM MDI

Follow the procedure below to set parameters.

- (1) Place the NC in the MDI mode or the emergency stop state.
- (2) Follow the substeps below to enable writing of parameters.
 1. To display the setting screen, press the  function key as many times as required, or alternatively press the  function key once, then the [SETTING] section select soft key. The first page of the setting screen appears.
 2. Position the cursor on "PARAMETER WRITE" using the cursor move keys.

```



SETTING (HANDY)                00001  N00010
PARAMETER WRITE = 0 (0:DISABLE 1:ENABLE)
TV CHECK           = 0 (0:OFF   1:ON)
PUNCH CODE        = 0 (0:EIA   1:ISO)
INPUT UNIT        = 0 (0:MM    1:INCH)
I/O CHANNEL       = 0 (0-3:CHANNEL NO.)
  
```

3. Press the [(OPRT)] soft key to display operation select soft keys.

```

>
MDI STOP *** ** 10:03:02
[NO.SRH] [ ON:1 ] [ OFF:0 ] [+INPUT] [INPUT]
  
```

← Soft key display
(section select)

4. To set "PARAMETER WRITE=" to 1, press the ON:1 soft key, or alternatively enter 1 and press the INPUT soft key. From now on, the parameters can be set. At the same time an alarm condition (P/S100 PARAMETER WRITE ENABLE) occurs in the CNC.
- (3) To display the parameter screen, press the  function key as many times as required, or alternatively press the  function key once, then the PARAM section select soft key. (See "1. Displaying Parameters.")
- (4) Display the page containing the parameter you want to set, and position the cursor on the parameter. (See "1. Displaying Parameters.")
- (5) Enter data, then press the [INPUT] soft key. The parameter indicated by the cursor is set to the entered data.

[Example] 12000 [INPUT]

PARAMETER (FEEDRATE)		00001 N00010			
1401	RDR		JZR	RPD	
	0 0 0 0	0	0	0	0
1402		JRV			
	0 0 0 0	0	0	0	0
1410	DRY RUN FEEDRATE			12000	
1412				0	
1420	RAPID FEEDRATEX			15000	
		Y		15000	
		Z		15000	

>

MDI STOP *** ** ALM 0:03:10

[NO.SRH] [ON:1] [OFF:0] [+INPUT] [INPUT]

Note: An arrow labeled "Cursor" points to the value 12000 in the table.

Data can be entered continuously for parameters, starting at the selected parameter, by separating each data item with a semicolon (;).

[Example]

Entering 10;20;30;40 and pressing the INPUT key assigns values 10, 20, 30, and 40 to parameters in order starting at the parameter indicated by the cursor.



- (6) Repeat steps (4) and (5) as required.
- (7) If parameter setting is complete, set "PARAMETER WRITE=" to 0 on the setting screen to disable further parameter setting.
- (8) Reset the NC to release the alarm condition (P/S100).
If an alarm condition (P/S000 PLEASE TURN OFF POWER) occurs in the NC, turn it off before continuing operation.

3

INPUTTING AND OUTPUTTING PARAMETERS THROUGH THE READER/PUNCHER INTERFACE

This section explains the parameter input/output procedures for input/output devices connected to the reader/puncher interface. The following description assumes the input/output devices are ready for input/output. It also assumes parameters peculiar to the input/output devices, such as the baud rate and the number of stop bits, have been set in advance. (See 4.2.)

3.1 OUTPUTTING PARAMETERS THROUGH THE READER/PUNCHER INTERFACE

- (1) Select the EDIT mode or set to Emergency stop.
- (2) To select the parameter screen, press the  function key as many times as required, or alternatively press the  function key once, then the PARAM section select soft key.
- (3) Press the [(OPRT)] soft key to display operation select soft keys, then press the forward menu key located at the right-hand side of the soft keys to display another set of operation select keys including [PUNCH].

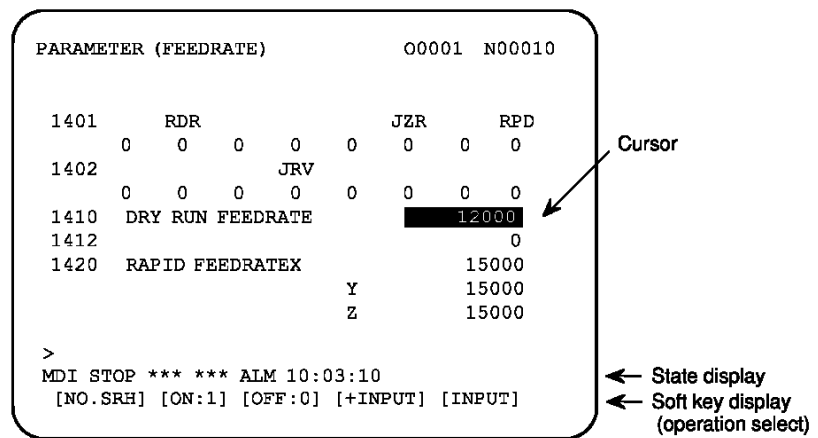

PARAMETER (FEEDRATE)		00001 N00010	
1401	RDR	JZR	RPD
	0 0 0 0	0 0 0 0	
1402	JRV		
	0 0 0 0	0 0 0 0	
1410	DRY RUN FEEDRATE		12000
1412			0
1420	RAPID FEEDRATEX		15000
	Y		15000
	Z		15000

>
MDI STOP *** ** ALM 10:03:10
[NO.SRH] [ON:1] [OFF:0] [+INPUT] [INPUT]

- (4) Pressing the [PUNCH] soft key changes the soft key display as shown below:

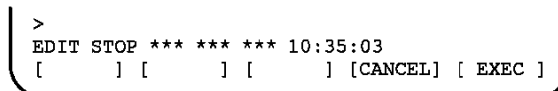

>
EDIT STOP *** ** 10:35:03
[] [] [] [CANCEL] [EXEC]



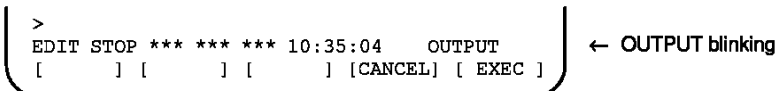

- (5) Press the [EXEC] soft key to start parameter output. When parameters are being output, "OUTPUT" blinks in the state display field on the lower part of the screen.



>
EDIT STOP *** ** 10:35:04 OUTPUT
[] [] [] [CANCEL] [EXEC]

- (6) When parameter output terminates, "OUTPUT" stops blinking. Press the  key to interrupt parameter output.

3.2 INPUTTING PARAMETERS THROUGH THE READER/PUNCHER INTERFACE

- (1) Place the NC in the emergency stop state.
- (2) Enable parameter writing.
 1. To display the setting screen, press the  function key as many times as required, or alternatively press the  function key once, then the [SETTING] section select soft key. The first page of the setting screen appears.
 2. Position the cursor on "PARAMETER WRITE" using the cursor move keys.
 3. Press the [(OPRT)] soft key to display operation select soft keys.
 4. To set "PARAMETER WRITE=" to 1, press the ON:1 soft key, or alternatively enter 1, then press the [INPUT] soft key. From now on, parameters can be set. At the same time an alarm condition (P/S100 PARAMETER WRITE ENABLE) occurs in the NC.
- (3) To select the parameter screen, press the  function key as many times as required, or alternatively press the  key once, then [PARAM] soft key.
- (4) Press the [(OPRT)] soft key to display operation select keys, then press the forward menu key located at the right-hand side of the soft keys to display another set of operation select soft keys including [READ].

```

>
EDIT STOP -EMG- ALM 10:37:30
[      ] [ READ ] [PUNCH] [      ] [      ]
    
```

← State display
← Soft key display

- (5) Pressing the [READ] soft key changes the soft key display as shown below:

```

>
EDIT STOP -EMG- ALM 10:37:30
[      ] [      ] [      ] [CANCEL] [ EXEC ]
    
```

- (6) Press the [EXEC] soft key to start inputting parameters from the input/output device. When parameters are being input, "INPUT" blinks in the state display field on the lower part of the screen.

```

>
EDIT STOP -EMG- ALM 10:37:30 INPUT
[      ] [      ] [      ] [CANCEL] [ EXEC ]
    
```

← INPUT blinking

- (7) When parameter input terminates, "INPUT" stops blinking. Press the  key to interrupt parameter input.
- (8) When parameter read terminates, "INPUT" stops blinking, and an alarm condition (P/S000) occurs in the NC. Turn it off before continuing operation.

4

DESCRIPTION OF PARAMETERS

Parameters are classified by data type as follows:

Table 4 Data Types and Valid Data Ranges of Parameters

Data type	Valid data range	Remarks
Bit	0 or 1	
Bit axis		
Byte	-128 to 127	In some parameters, signs are ignored.
Byte axis	0 to 255	
Word	-32768 to 32767	In some parameters, signs are ignored.
Word axis	0 to 65535	
2-word	-99999999 to 99999999	
2-word axis		

NOTE

- 1 For the bit type and bit axis type parameters, a single data number is assigned to 8 bits. Each bit has a different meaning.
- 2 The axis type allows data to be set separately for each control axis.
- 3 The valid data range for each data type indicates a general range. The range varies according to the parameters. For the valid data range of a specific parameter, see the explanation of the parameter.

(1) Notation of bit type and bit axis type parameters
[Example]

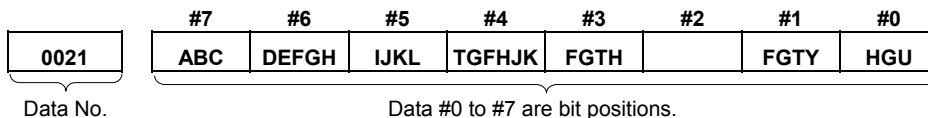

(2) Notation of parameters other than bit type and bit axis type

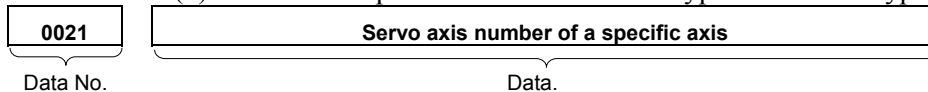

NOTE

- 1 The bits left blank in 4. DESCRIPTION OF PARAMETERS and parameter numbers that appear on the display but are not found in the parameter list are reserved for future expansion. They must always be 0.
- 2 Parameters having different meanings between the T series and M series and parameters that are valid only for the T or M series are indicated in two levels as shown below. Parameters left blank are unavailable.

Example1

Parameter 5010 has different meanings for the T series and M series.

5010	Tool nose radius compensation ...	T series
	Tool compensation C ...	M series

Example2

DPI is a parameter common to the M and T series, but GSB and GSC are parameters valid only for the T series.

	#7	#6		#0	
3401	GSC	GSB		DPI	T series
				DPI	M series

Example3

The following parameter is provided only for the M series.

1450		T series
	F1 digit feed ...	M series

4.1 PARAMETERS OF SETTING

	#7	#6	#5	#4	#3	#2	#1	#0
0000			SEQ			INI	ISO	TVC

Setting entry is acceptable.

[Data type] Bit

TVC TV check
 0 : Not performed
 1 : Performed

ISO Code used for data output
 0 : EIA code
 1 : ISO code

INI Unit of input
 0 : In mm
 1 : In inches

SEQ Automatic insertion of sequence numbers
 0: Not performed
 1: Performed

When a program is prepared by using MDI keys in the part program storage and edit mode, a sequence number can automatically be assigned to each block in set increments. Set the increment to parameter 3216.

	#7	#6	#5	#4	#3	#2	#1	#0
0001							FCV	

Setting entry is acceptable.

[Data type] Bit

FCV Tape format
 0: Series 0 standard format
 (Series 16/18 compatible format)
 1: Series 10 / 11 format

NOTE

Programs created in the Series 10 / 11 tape format can be used for operation on the following functions:

- 1 Subprogram call M98
- 2 Thread cutting with equal leads G32 (T series)
- 3 Canned cycle G90, G92, G94 (T series)
- 4 Multiple repetitive canned cycle G71 to G76 (T series)
- 5 Drilling canned cycle G73, G74, G76, G80 to G89 (M series)
- 6 Cutter compensation C (M series)

2 When the tape format used in the Series 10/11 is used for this CNC, some limits may add. Refer to the Series 0i/0i Mate-MODEL C OPERATOR'S MANUAL.

	#7	#6	#5	#4	#3	#2	#1	#0
0002	SJZ							RDG

Setting entry is acceptable.

[Data type]
RDG

Bit
Remote diagnosis is
0: Not performed.
1: Performed.

To use an RS-232-C serial port for performing remote diagnosis, connect and setup the modem, cable, and the like, then set 1 in this parameter. When using a modem card, the setting is not necessary.

SJZ

Manual reference position is performed as follows:
0: When no reference position has been set, reference position return is performed using deceleration dogs. When a reference position is already set, reference position return is performed using rapid traverse and deceleration dogs are ignored.
1: Reference position return is performed using deceleration dogs at all times.

NOTE

SJZ is enabled when bit 3 (HJZ) of parameter No.1005 is set to 1. When a reference position is set without a dog, (i.e. when bit 1 (DLZ) of parameter No.1002 is set to 1 or bit 1 (DLZx) of parameter No.1005 is set to 1) reference position return after reference position setting is performed using rapid traverse at all times, regardless of the setting of SJZ.

	#7	#6	#5	#4	#3	#2	#1	#0
0012	RMVx			AICx				MIRx
	RMVx							MIRx

Setting entry is acceptable.

[Data type]
MIRx

Bit axis
Mirror image for each axis
0: Mirror image is off.
1: Mirror image is on.

AICx

The travel distance of an axis command is:
0: Determined by the value specified with the address.
1: Always handled as an incremental value.

0020	I/O CHANNEL: Selection of an input/output device or selection of input device in the foreground
------	--

[Data type]
[Valid data range]

Setting entry is acceptable.

Byte
0 to 35

I/O CHANNEL: Selection of the input/output device to be used
The CNC provides the following interfaces for data transfer to and from the host computer and external input/output devices:

- Input/output device interface (RS-232-C serial port 1, 2)
- DNC2 interface

Data input/output can be performed with a personal computer connected via FOCAS1/Ethernet or FOCAS1/HSSB. Data input/output can be performed with the Power Mate CNC via the FANUC I/O Link.

This parameter selects the interface used to transfer data to and from an input/output device.

Setting	Description		
0, 1	RS-232-C serial port 1		
2	RS-232-C serial port 2		
4	Memory card interface		
5	Data server interface		
6	The DNC operation is performed or M198 is specified by FOCAS1/ Ethernet.		
10	DNC2 interface, OSI-Ethernet		
15	M198 is specified by FOCAS1/HSSB. (Bit 1 (NWD) of parameter No. 8706) must also be specified.)		
20 21 22 to 34 35	<table style="border: none;"> <tr> <td style="border: none;">Group 0 Group 1 Group 2 to Group 14 Group 15</td> <td style="border: none; padding-left: 10px;">} Data is transferred between the CNC and a power mate CNC in group n (n: 0 to 15) via the FANUC I/O Link.</td> </tr> </table>	Group 0 Group 1 Group 2 to Group 14 Group 15	} Data is transferred between the CNC and a power mate CNC in group n (n: 0 to 15) via the FANUC I/O Link.
Group 0 Group 1 Group 2 to Group 14 Group 15	} Data is transferred between the CNC and a power mate CNC in group n (n: 0 to 15) via the FANUC I/O Link.		

Supplemental remark 1

If the DNC operation is performed with FOCAS1/HSSB, the setting of parameter No. 20 does not matter. The DMMC signal <G042.7> is used.

Supplemental remark 2

If bit 0 (IO4) of parameter No. 110 is set to control the I/O channels separately, the I/O channels can be divided into four types: input and output in the foreground and input and output in the background. If so, parameter No. 20 becomes a parameter for selecting the input device in the foreground.

NOTE

- 1 An input/output device can also be selected using the setting screen. Usually, the setting screen is used.
- 2 The specifications (such as the baud rate and the number of stop bits) of the input/output devices to be connected must be set in the corresponding parameters for each interface beforehand. (See Section 4.2.) I/O CHANNEL = 0 and I/O CHANNEL = 1 represent input/output devices connected to RS-232-C serial port 1. Separate parameters for the baud rate, stop bits, and other specifications are provided for each channel.

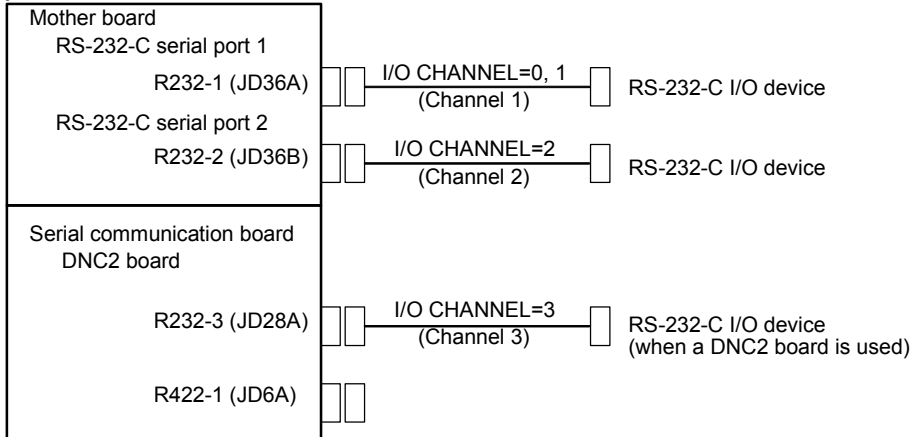

- 3 The input/output unit interface may be referred to as the reader/punch interface. RS-232-C serial port 1 and RS-232-C serial port 2 are also referred to as channel 1 and channel 2, respectively.

0021	Setting of the output device in the foreground
0022	Setting of the input device in the background
0023	Setting of the output device in the background

Setting entry is acceptable.

[Data type] Byte

[Valid data range] 0 to 2, 5, 10

These parameters are valid only when bit 0 (IO4) of parameter No. 110 is set to control the I/O channels separately.

The parameters set individual input/output devices if the I/O channels are divided into these four types: input and output in the foreground and input and output in the background. The input device in the foreground is set in parameter No. 20. For the details of the settings, see the table provided with the description of parameter No. 20.

NOTE

If different input/output devices are simultaneously used in the foreground and background, just a value from 0 to 2 can be specified for the background device.

If an attempt is made to use a busy input/output device, an alarm (P/S233 or BP/S233) will be raised. Note that the settings 0 and 1 indicate the same input/output device.

4.2 PARAMETERS OF READER/PUNCHER INTERFACE, REMOTE BUFFER, DNC1, DNC2, AND M-NET INTERFACE

Before data (programs, parameters, and so on) can be input from and output to an external input/output device via the input/output device interface (RS-232-C serial port), the parameters explained below must be set.

In the I/O CHANNEL setting parameter, the input/output device to be used is selected by specifying one of the two channels (RS-232-C serial port 1 and RS-232-C serial port 2) that is connected to the input/output device.

In addition, the specifications of an input/output device connected to each channel (such as the specification number, baud rate, and number of stop bits of the input/output device) must be set in parameters corresponding to each channel in advance.

For channel 1, two combinations of parameters to specify the input/output device data are provided.

The following shows the interrelation between the input/output device interface parameters for the channels.

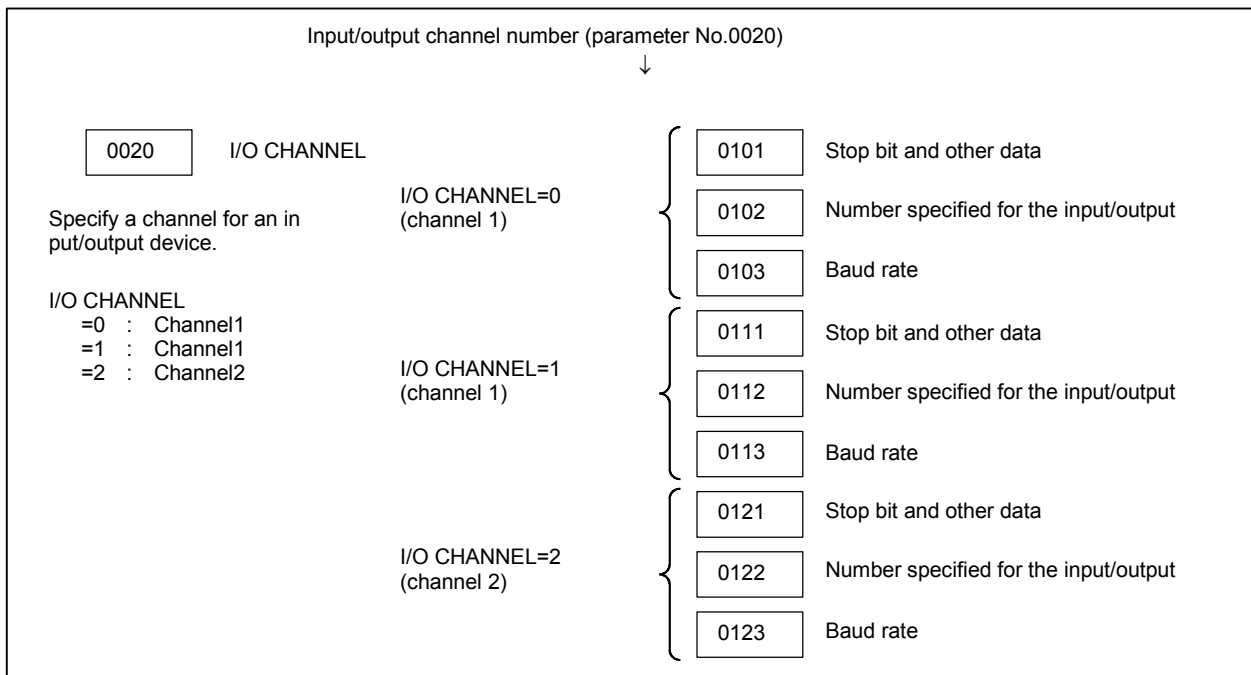

Fig.4.2 I/O Device Interface Settings

4.2.1 Parameters Common to all Channels

0024	Port for communication with the PMC ladder development tool (FANUC LADDER-III)
------	--

The following parameter can be set at "Setting screen".

[Data type] Byte

This parameter sets the port to be used for communication with the PMC ladder development tool (FANUC LADDER-III).

0 : According to the setting on the PMC online screen
 1 : RS-232-C serial port 1 (JD36A)
 2 : RS-232-C serial port 2 (JD36B)
 10 : High-speed interface (HSSB (COP7) or Ethernet)
 11 : High-speed interface or RS-232-C serial port 1
 12 : High-speed interface or RS-232-C serial port 2

0100	#7	#6	#5	#4	#3	#2	#1	#0
	ENS	IOP	ND3		NCR	CRF	CTV	

[Data type] Bit

CTV: Character counting for TV check in the comment section of a program.
 0 : Performed
 1 : Not performed

CRF EOB (end of block) to be output in the ISO code:
 0: Depends on the setting of bit 3 (NCR) of parameter No. 100.
 1: is "CR""LF".

NOTE

The EOB output patterns are as shown below:

NCR	CRF	EOB output format
0	0	"LF" "CR" "CR"
0	1	"CR" "LF"
1	0	"LF"
1	1	"CR" "LF"

NCR Output of the end of block (EOB) in ISO code
 0 : LF, CR, CR are output.
 1 : Only LF is output.

ND3 In DNC operation, a program is:
 0 : Read block by block. (A DC3 code is output for each block.)
 1 : Read continuously until the buffer becomes full. (A DC3 code is output when the buffer becomes full.)

NOTE
 In general, reading is performed more efficiently when ND3 set to 1. This specification reduces the number of buffering interruptions caused by reading of a series of blocks specifying short movements. This in turn reduces the effective cycle time.

- IOP Specifies how to stop program input/output operations.
 0 : An NC reset can stop program input/output operations.
 1 : Only the [STOP] soft key can stop program input/output operations. (An reset cannot stop program input/output operations.)
- ENS Action taken when a NULL code is found during read of EIA code
 0 : An alarm is generated.
 1 : The NULL code is ignored.

	#7	#6	#5	#4	#3	#2	#1	#0
0110								IO4

[Data type] Bit
 IO4 Separate control of I/O channel numbers is:
 0: Not performed.
 1: Performed.
 If the I/O channels are not separately controlled, set the input/output device in parameter No. 20.
 If the I/O channels are separately controlled, set the input device and output device in the foreground and the input device and output device in the background in parameters No. 20 to No. 23 respectively.
 Separate control of I/O channels makes it possible to perform background editing, program input/output, and the like during the DNC operation.

4.2.2 Parameters of Channel 1 (I/O CHANNEL=0)

	#7	#6	#5	#4	#3	#2	#1	#0
0101	NFD				ASI			SB2
	NFD				ASI		HAD	SB2

[Data type] Bit
 SB2 The number of stop bits
 0 : 1
 1 : 2
 HAD An alarm raised for the internal handy file is:
 0: Not displayed in detail on the NC screen. (PS alarm 86 is displayed.)
 1: Displayed in detail on the NC screen.

- ASI Code used at data input
 0 : EIA or ISO code (input: determined automatically, output: setting of bit 1 of parameter No. 0000)
 1 : ASCII code for both input and output

NOTE

When ASCII code is to be used for inputting and outputting data (when ASI is set to 1), also set bit 1 of parameter No. 0000 to 1.

- NFD Feed before and after the data at data output
 0 : Output
 1 : Not output

NOTE

When input/output devices other than the FANUC PPR are used, set NFD to 1.

0102

Number specified for the input/output device (when the I/O CHANNEL is set to 0)

[Data type]

Byte

Set the number specified for the input/output device used when the I/O CHANNEL is set to 0, with one of the set values listed in Table 4.2.2 (a).

Table 4.2.2 (a) Set value and Input/Output Device

Set value	Input/output device
0	RS-232-C (Used control codes DC1 to DC4)
1	FANUC CASSETTE ADAPTOR 1 (FANUC CASSETTE B1/B2)
2	FANUC CASSETTE ADAPTOR 3 (FANUC CASSETTE F1)
3	FANUC PROGRAM FILE Mate, FANUC FA Card Adaptor FANUC FLOPPY CASSETTE ADAPTOR, FANUC Handy File FANUC SYSTEM P-MODEL H
4	RS-232-C (Not used control codes DC1 to DC4)
5	Portable tape reader
6	FANUC PPR FANUC SYSTEM P-MODEL G, FANUC SYSTEM P-MODEL H

0103	Baud rate (when the I/O CHANNEL is set to 0)
-------------	---

[Data type] Byte
Set baud rate of the input/output device used when the I/O CHANNEL is set to 0, with a set value in Table 4.2.2 (b).

Table 4.2.2 (b)

Set value	Baud rate (bps)	Set value	Baud rate (bps)
1	50	7	600
2	100	8	1200
3	110	9	2400
4	150	10	4800
5	200	11	9600
6	300	12	19200

4.2.3 Parameters of Channel 1 (I/O CHANNEL=1)

	#7	#6	#5	#4	#3	#2	#1	#0
0111	NFD				ASI			SB2

[Data type] Bit
These parameters are used when I/O CHANNEL is set to 1. The meanings of the bits are the same as for parameter 0101.

0112	Number specified for the input/output device (when I/O CHANNEL is set to 1)
-------------	--

[Data type] Byte
Set the number specified for the input/output device used when the I/O CHANNEL is set to 1, with one of the set values listed in Table 4.2.2 (a).

0113	Baud rate (when I/O CHANNEL is set to 1)
-------------	---

[Data type] Byte
Set the baud rate of the input/output device used when I/O CHANNEL is set to 1, with a value in Table 4.2.2 (b).

4.2.4 Parameters of Channel 2 (I/O CHANNEL=2)

	#7	#6	#5	#4	#3	#2	#1	#0
0121	NFD				ASI			SB2

[Data type] Bit
These parameters are used when I/O CHANNEL is set to 2. The meanings of the bits are the same as for parameter 0101.

0122	Number specified for the input/output device (when I/O CHANNEL is set to 2)
-------------	--

[Data type] Byte

Set the number specified for the input/output device used when I/O CHANNEL is set to 2, with a value in Table 4.2.2 (a).

0123	Baud rate (when the I/O CHANNEL is set to 2)
------	---

[Data type] Byte
Set the baud rate of the input/output device used when I/O CHANNEL is set to 2, with a value in Table 4.2.2 (b).

	#7	#6	#5	#4	#3	#2	#1	#0
0134				NCD		SYN	PRY	

NOTE
When this parameter is set, the power must be turned off before operation is continued.

[Data type] Bit
 PRY Parity bit
 0: Not used
 1: Used
 SYN Reset/alarm in protocol B
 0: Not reported to the host
 1: Reported to the host with SYN and NAK codes
 NCD CD (signal quality detection) of the RS-232-C interface
 0: Checked
 1: Not checked

	#7	#6	#5	#4	#3	#2	#1	#0
0135	RMS					PRA	ETX	ASC

NOTE
When this parameter is set, the power must be turned off before operation is continued.

[Data type] Bit
 ASC Communication code except NC data
 0: ISO code
 1: ASCII code
 ETX End code for protocol A or extended protocol A
 0: CR code in ASCII/ISO
 1: ETX code in ASCII/ISO

NOTE
Use of ASCII/ISO is specified by ASC.

PRA Communication protocol
 0: Protocol B
 1: Protocol A
 RMS State of remote/tape operation when protocol A is used
 0: Always 0 is returned.

1: Contents of the change request of the remote/tape operation in the SET command from the host is returned.

	#7	#6	#5	#4	#3	#2	#1	#0
0138	MDN	OWN						

- [Data type] Bit
- OWN When NC data or an NC program is output to a memory card, a message for file overwrite confirmation is:
 0 : Displayed.
 1 : Not displayed.
- MDN The DNC operation function by a memory card is:
 0: Disabled.
 1: Enabled. (A PCMCIA card attachment is required.)

NOTE
 Use a PCMCIA card attachment suited to the CNC to secure the memory card in the CNC.

4.3 PARAMETERS OF DNC2 INTERFACE

	#7	#6	#5	#4	#3	#2	#1	#0
0140					ECD	NCE		BCC

NOTE
When this parameter is set, the power must be turned off before operation is continued.

- [Data type] Bit
- BCC The BCC value (block check characters) for the DNC2 interface is:
0: Checked.
1: Not checked.
Even if the BCC value is not checked, the BCC value itself must be specified.
- NCE The ER (RS-232-C) and TR (RS422) signals are:
0: Checked.
1: Not checked.
This parameter is dedicated to the DNC2 interface.
- ECD Error code of negative acknowledgment
0: A four-digit hexadecimal error code is added to a negative acknowledgment.
1: No error code is added to a negative acknowledgment.
This parameter is dedicated to the DNC2 interface.

NOTE
To use FANUC DNC2 communications library for the host computer, set this parameter to 1.

0143	Time limit specified for the timer monitoring a response (DNC2 interface)
------	---

NOTE
When this parameter is set, the power must be turned off before operation is continued.

- [Data type] Byte
- [Unit of data] sec
- [Valid data range] 1 to 60 (The standard setting is 3.)

0144	Time limit specified for the timer monitoring the EOT signal (DNC2 interface)
------	---

NOTE
When this parameter is set, the power must be turned off before operation is continued.

- [Data type] Byte
- [Unit of data] sec
- [Valid data range] 1 to 60 (The standard setting is 5.)

0145

Time required for switching RECV and SEND (DNC2 interface)

NOTE

When this parameter is set, the power must be turned off before operation is continued.

[Data type] Byte
 [Unit of data] sec
 [Valid data range] 1 to 60 (The standard setting is 1.)

0146

Number of times the system retries holding communication (DNC2 interface)

NOTE

When this parameter is set, the power must be turned off before operation is continued.

[Data type] Byte
 [Unit of data] sec
 [Valid data range] 1 to 10 (The standard setting is 3.)
 Set the maximum number of times the system retries holding communication with the remote device if the remote device uses an invalid protocol in the data-link layer or the remote device does not respond to the request.

0147

Number of times the system sends the message in response to the NAK signal (DNC2 interface)

NOTE

When this parameter is set, the power must be turned off before operation is continued.

[Data type] Byte
 [Unit of data] Number of times
 [Valid data range] 1 to 10 (The standard setting is 2.)
 Set the maximum number of times the system retries sending the message in response to the NAK signal.

0148

Number of characters in overrun (DNC2) interface)

NOTE

When this parameter is set, the power must be turned off before operation is continued.

[Data type] Byte
 [Valid data range] 10 to 225 (The standard setting is 10.)
 Set the number of characters the system can receive after transmission is stopped (CS off).

0149

Number of characters in the data section of the communication packet
(DNC2 interface)

NOTE
When this parameter is set, the power must be turned off before operation is continued.

[Data type]
[Valid range]

Word
80 to 256 (The standard setting is 256.)
The standard setting is 256. If the specified value is out of range, a value of 80 or 256 is used.
This parameter determines the maximum length of the packet used in transmission over the DNC2 interface. Including the two characters at the start of the packet, the four characters used for a command, and the three characters at the end, the maximum number of characters in the packet is nine plus the number specified in parameter No.0149.

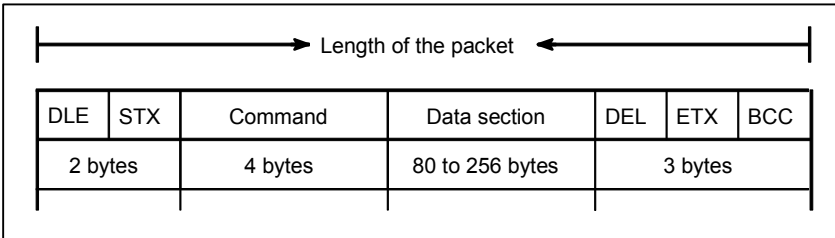

4.4 PARAMETERS OF REMOTE DIAGNOSIS

	#7	#6	#5	#4	#3	#2	#1	#0
0002								RDG

[Data type] Bit
 RDG Remote diagnosis is:
 0: Not performed.
 1: Performed.
 If an RS-232-C serial port is used to carry out remote diagnosis, connect and set up the modem, cable, and the like, then set 1 in this parameter.

	#7	#6	#5	#4	#3	#2	#1	#0
0201						NCR	ASC	SB2

[Data type] Bit
 SB2 The number of stop bits is
 0: 1.
 1: 2.
 To carry out remote diagnosis, set 0.
 ASC The code to be used for data output is:
 0: ISO code.
 1: ASCII code.
 To carry out remote diagnosis, set 1.
 NCR EOB (end of block) is output as:
 0: "LF""CR""CR".
 1: Just as "LF".
 To carry out remote diagnosis, set 1.

0203	Baud rate (for remote diagnosis)
------	----------------------------------

[Data type] Byte
 Set the baud rate of data input/output by remote diagnosis, with reference to the tables given below.

When using an RS-232-C serial port

Set value	Baud rate (bps)
1	50
2	100
3	110
4	150
5	200
6	300

Set value	Baud rate (bps)
7	600
8	1200
9	2400
10	4800
11	9600
12	19200

NOTE
 The tables above indicate the baud rates of communication between the CNC and modem. The actual communication baud rate may be lowered, depending on the modem and communication line.

0204	Remote diagnosis channel
-------------	---------------------------------

[Data type] Byte
 [Valid data range] 0, 1, 2
 The interface to be used for remote diagnosis is:
 0,1 : RS-232-C serial port 1 (channel 1).
 2 : RS-232-C serial port 2 (channel 2).

0211	Password 1 for remote diagnosis
-------------	--

0212	Password 2 for remote diagnosis
-------------	--

0213	Password 3 for remote diagnosis
-------------	--

[Data type] 2-word
 [Valid data range] 1 to 99999999
 Specify a password for using the remote diagnosis function.
 The remote diagnosis function has the following password settings.
 Data can be protected by preventing a third party from accessing any system parameter or machining program without permission.

- Password 1:
 Set a password for the whole service of the remote diagnosis function. (The whole remote diagnosis service is available only when this password is input on the host side (PC, for instance).)
- Password 2:
 Set a password of a part program. (The input/output, verification, and the like of a program are possible only when this password is input on the host side (PC, for instance).)
- Password 3:
 Set a password of a parameter. (The input/output or the like of a parameter is possible only when this password is input on the host side (PC, for instance).)

NOTE
 Once any value other than 0 is specified as a password, the password can be changed only when the same value is specified in the corresponding keyword (parameters No. 221 to No. 223). If any value other than 0 is specified as a password, the password setting is not displayed on the parameter screen (blank display is provided).
 Take great care when setting the password.

0221	Keyword 1 for remote diagnosis
-------------	---------------------------------------

0222	Keyword 2 for remote diagnosis
-------------	---------------------------------------

0223**Keyword 3 for remote diagnosis**

[Data type] 2-word

[Valid range] 1 to 99999999

Set a keyword corresponding to a password of the remote diagnosis function.

Keyword 1: Keyword for password 1 (parameter No. 211)

Keyword 2: Keyword for password 2 (parameter No. 212)

Keyword 3: Keyword for password 3 (parameter No. 213)

If any value other than 0 is specified as a password (parameters No. 211 to No. 213), the password can be changed only when the same value is specified as the corresponding keyword.

NOTE

The keyword value is reset to 0 at power-up. On the parameter screen, the keyword setting is not displayed (blank display is provided).

4.5 PARAMETER OF MEMORY CARD INTERFACE

	#7	#6	#5	#4	#3	#2	#1	#0
0300								PCM

[Data type] Bit
 PCM If the CNC screen display function is enabled, when a memory card interface is provided on the NC side (HSSB connection),
 0 : The memory card interface on the NC side is used.
 1 : The memory card interface on the PC side is used.
 This parameter is valid when parameter No. 20 is set to 4 (memory card interface). This parameter is valid only while the CNC screen display function is active.

4.6 PARAMETERS OF DATA SERVER

	#7	#6	#5	#4	#3	#2	#1	#0
0900							ONS	DSV

[Data type] Bit

DSV The data server function is

0: Enabled

1: Disabled

ONS When the O number of the data server file name and the O number in an NC program do not match:

0: The O number of the file name takes priority.

1: The O number in the NC program takes priority.

0921	OS selected for host computer 1 of data server
-------------	---

0922	OS selected for host computer 2 of data server
-------------	---

0923	OS selected for host computer 3 of data server
-------------	---

[Data type] Word

[Valid data range] 0 to 1

0: Windows95/98/NT is selected.

1: UNIX or VMS is selected.

0924	Latency setting for DNC1/Ethernet or FOCAS1/Ethernet
-------------	---

[Data type] Word

[Unit of data] ms

[Valid data range] 0 to 255

Set service latency of FOCAS1/Ethernet while FOCAS1/Ethernet is used together with the data server function.

If a value between 0 and 2 is set, 2 ms is assumed.

4.7 PARAMETERS OF ETHERNET

0931	Special character code corresponding to soft key [CHAR-1]
0932	Special character code corresponding to soft key [CHAR-2]
0933	Special character code corresponding to soft key [CHAR-3]
0934	Special character code corresponding to soft key [CHAR-4]
0935	Special character code corresponding to soft key [CHAR-5]

[Data type] Byte
 [Valid data range] 32 to 95

These parameters are provided to allow a special character that is not provided on the MDI panel but needed in a user name, password, or login DIR to be input by pressing a soft key on the Ethernet parameter screen.

If a value other than 0 is input as a parameter, the special character assigned to the corresponding input soft key [CHAR-1] to [CHAR-5] is displayed.

The special character codes correspond to the ASCII codes.

Sample special character codes

Special character	Code	Special character	Code	Special character	Code
Blank	32)	41	<	60
!	33	*	42	>	62
"	34	+	43	?	63
#	35	,	44	@	64
\$	36	-	45	[91
%	37	.	46	^	92
&	38	/	47	#	93
'	39	:	58]	94
(40	;	59	_	95

4.8 PARAMETERS OF POWER MATE CNC MANAGER

	#7	#6	#5	#4	#3	#2	#1	#0
0960			ASG	SPW	PMN	MD2	MD1	SLV

[Data type] Bit

SLV When the power mate CNC manager is selected, the screen displays:
 0 : One slave.
 1 : Up to four slaves with the screen divided into four.

MD1,MD2 These parameters set a slave parameter input/output destination.

MD2	MD1	Input/output destination
0	0	Part program storage
0	1	Memory card

In either case, slave parameters are output in program format.

PMN The power mate CNC manager function is:

0 : Enabled.
 1 : Disabled. (Communication with slaves is not performed.)

SPW The power mate CNC manager allows parameters of slaves to be set:

0 : Regardless of the PWE settings.
 1 : According to the PWE settings.

ASG Whether the number of bytes allocated to the input/output destination of the β amplifier with the I/O Link is 16 bytes or not is :

0 : Not checked.
 1 : Checked.

4.9 PARAMETERS OF AXIS CONTROL/INCREMENT SYSTEM

	#7	#6	#5	#4	#3	#2	#1	#0
1001								INM

NOTE
When this parameter is set, the power must be turned off before operation is continued.

[Data type] Bit
INM Least command increment on the linear axis
0 : In mm (metric system machine)
1 : In inches (inch system machine)

	#7	#6	#5	#4	#3	#2	#1	#0
1002	IDG			XIK		SFD	DLZ	JAX
	IDG			XIK	AZR	SFD	DLZ	JAX

[Data type] Bit
JAX Number of axes controlled simultaneously in manual continuous feed, manual rapid traverse and manual reference position return
0 : 1 axis
1 : 3 axes
DLZ Function setting the reference position without dog
0 : Disabled
1 : Enabled (enabled for all axes)

NOTE
1 This function can be specified for each axis by DLZx, bit 1 of parameter No.1005.
2 For a system including an axis of Cs contour control or spindle positioning, avoid using this parameter. Use bit 1 (DLZx) of parameter No. 1005 instead to set just a required axis.

SFD The function for shifting the reference position is
0: Not used.
1: Used.
AZR When no reference position is set, the G28 command causes:
0: Reference position return using deceleration dogs (as during manual reference position return) to be executed.
1: P/S alarm No.090 to be issued.

NOTE
 When reference position return without dogs is specified, (when bit 1 (DLZ) of parameter No.1002 is set to 1. The G28 command specified before a reference position causes P/S alarm No.090, regardless of the setting of AZR.

- XIK When LRP, bit 1 of parameter No.1401, is set to 0, namely, when positioning is performed using non-linear type positioning, if an interlock is applied to the machine along one of axes in positioning,
 - 0: The machine stops moving along the axis for which the interlock is applied and continues to move along the other axes.
 - 1: The machine stops moving along all the axes.
- IDG When the reference position is set without dogs, automatic setting of the IDGx parameter (bit 0 of parameter No.1012) to prevent the reference position from being set again is:
 - 0: Not performed.
 - 1: Performed.

	#7	#6	#5	#4	#3	#2	#1	#0
1004	IPR						ISC	
	IPR	IPI					ISC	ISA

NOTE
 When this parameter is set, the power must be turned off before operation is continued.

[Data type]
 ISA, ISC, ISD

Bit
 The least input increment and least command increment are set.

ISC	ISA	Least input increment and least command increment	Symbol
0	0	0.001 mm, 0.001 deg, or 0.0001 inch	IS-B
0	1	0.01 mm, 0.01 deg, or 0.001 inch	IS-A
1	0	0.0001 mm, 0.0001 deg, or 0.00001 inch	IS-C

NOTE
 IS-A cannot be used at present.

- IPI Bit 7 (IPR) of parameter No. 1004 is:
 - 0: A parameter that requires a power-off operation to make the setting valid, and that becomes invalid for inch input.
 - 1: A parameter that does not require a power-off operation, and that is also valid for inch input.
- IPR Whether the least input increment for each axis is set to a value 10 times as large as the least command increment is specified, in increment systems of IS-B or IS-C at setting mm.
 - 0: The least input increment is not set to a value 10 times as large as the least command increment.
 - 1: The least input increment is set to a value 10 times as large as the least command increment.

If IPR is set to 1, the least input increment is set as follows:

Input increment	Least input increment
IS-B	0.01 mm, 0.01 deg, or 0.0001 inch
IS-C	0.001 mm, 0.001 deg, or 0.00001 inch

NOTE

For IS-A, the least input increment cannot be set to a value 10 times as large as the least command increment.

The least input increment is not multiplied by 10 also when the calculator-type decimal point input (bit 0 (DPI) of parameter No. 3401) is used.

	#7	#6	#5	#4	#3	#2	#1	#0
1005			EDMx	EDPx	HJZx		DLZx	ZRNx

[Data type]

Bit axis

ZRNx

When a command specifying the movement except for G28 is issued in automatic operation (MEM, MDI, or DNC) and when a return to the reference position has not been performed since the power was turned on

0 : An alarm is generated (P/S alarm 224).

1 : An alarm is not generated.

NOTE

- 1 The state in which the reference position has not been established refers to that state in which reference position return has not been performed after power-on when an absolute position detector is not being used, or that state in which the association of the machine position with the position detected with the absolute position detector has not been completed (see the description of bit 4 (APZx) of parameter No. 1815) when an absolute position detector is being used.
- 2 To use a function that establishes the reference point and makes a movement with a command other than G28, such as an axis of Cs contour control, set this parameter for the relative axis.
- 3 When the Cs axis coordinate setup function (bit 2 (CSF) of parameter No. 3712) is used, it is recommended that this parameter be set to 0.

DLZx Function for setting the reference position without dogs

0 : Disabled

1 : Enabled

NOTE

- 1 When bit 1 (DLZ) of parameter No. 1002 is 0, DLZx is enabled. When bit 1 (DLZ) of parameter No. 1002 is 1, DLZx is disabled, and the function for setting the reference position without dogs is enabled for all axes.
- 2 Do not set this parameter for the Cs contour control axis or spindle positioning axis.

- HJZx When a reference position is already set:
- 0 : Manual reference position return is performed with deceleration dogs.
 - 1 : Manual reference position return is performed using rapid traverse without deceleration dogs, or manual reference position return is performed with deceleration dogs, depending on the setting of bit 7 (SJZ) of parameter No.0002.

NOTE

When the function (see bit 1 (DLZ) of parameter No. 1002) for setting the reference position without dogs is used, positioning to a reference position is always performed using rapid traverse in reference position return after establishment of the reference position, regardless of the setting of HJZ.

- EDPx External deceleration signal in the positive direction for each axis
- 0 : Valid only for rapid traverse
 - 1 : Valid for rapid traverse and cutting feed
- EDMx External deceleration signal in the negative direction for each axis
- 0 : Valid only for rapid traverse
 - 1 : Valid for rapid traverse and cutting feed

1006	#7	#6	#5	#4	#3	#2	#1	#0
			ZMIx		DIAx		ROSx	ROTx
			ZMIx				ROSx	ROTx

NOTE
When this parameter is set, the power must be turned off before operation is continued.

[Data type] Bit axis
ROTx, ROSx Setting linear or rotation axis.

ROSx	ROTx	Meaning
0	0	Linear axis (1) Inch/metric conversion is done. (2) All coordinate values are linear axis type. (Is not rounded in 0 to 360°) (3) Stored pitch error compensation is linear axis type (Refer to parameter No.3624)
0	1	Rotation axis (A type) (1) Inch/metric conversion is not done. (2) Machine coordinate values are rounded in 0 to 360°. Absolute coordinate values are rounded or not rounded by parameter No.1008#0(ROAx) and #2(RRLx). (3) Stored pitch error compensation is the rotation type. (Refer to parameter No.3624) (4) Automatic reference position return (G28, G30) is done in the reference position return direction and the move amount does not exceed one rotation.
1	0	Setting is invalid (unused)
1	1	Rotation axis (B type) (1) Inch/metric conversion, absolute coordinate values and relative coordinate values are not done. (2) Machine coordinate values, absolute coordinate values and relative coordinate values are linear axis type. (Is not rounded in 0 to 360°). (3) Stored pitch error compensation is linear axis type (Refer to parameter No.3624) (4) Cannot be used with the rotation axis roll over function and the index table indexing function (M series)

For the rotation axis used for cylindrical interpolation, set ROTx to 1.

DIAx Either a diameter or radius is set to be used for specifying the amount of travel on each axis.

- 0 : Radius
- 1 : Diameter

ZMIx The direction of reference position return.

- 0 : Positive direction
- 1 : Negative direction

NOTE
The direction of the initial backlash, which occurs when power is switched on, is opposite to the direction of a reference position return.

	#7	#6	#5	#4	#3	#2	#1	#0
1007						OKIx	ALZx	RTLx
						OKIx		

[Data type] Bit axis

RTLx The reference position return operation for a rotation axis is:
 0 : Of rotation axis type.
 1 : Of linear axis type.

NOTE

The rotation axis type reference position return operation and the linear axis type reference position return operation differ in behavior as follows, depending on when the dog (the deceleration signal for reference position return) is pressed:

- Linear axis type:
When the dog is pressed before the one-rotation signal is seized, P/S alarm No. 090 is issued.
- Rotation axis type:
When the dog is pressed before the one-rotation signal is seized, the reference position return operation is continued without issuing an alarm.

ALZx An automatic reference position return operation causes:
 0 : A return to the reference position by positioning.
When a reference position return has not been performed even once since power-on, a return to the reference position is performed in the same sequence as for the manual reference position return operation.
 1 : A return to the reference position in the same sequence as for the manual reference position return operation.

NOTE

This parameter has no influence on axes for which a reference position return is performed without dogs.

OKIx In reference position setting by pressing an axis against a stopper, after a reference position return is completed, P/S alarm 000 is:
 0 : Issued.
(If this setting is made, an absolute position detector is required when the function of reference position setting by pressing an axis against a stopper is used.)
 1 : Not issued.
(If this setting is made, no absolute position detector is required even when the function of reference position setting by pressing an axis against a stopper is used.)

	#7	#6	#5	#4	#3	#2	#1	#0
1008			RMCx			RRLx	RABx	ROAx

NOTE
When this parameter is set, the power must be turned off before operation is continued.

[Data type] Bit axis
ROAx The roll-over function of a rotation axis is
0 : Invalid
1 : Valid

NOTE
ROAx specifies the function only for a rotation axis (for which ROTx, #0 of parameter No.1006, is set to 1)

RABx In the absolute commands, the axis rotates in the direction
0 : In which the distance to the target is shorter.
1 : Specified by the sign of command value.

NOTE
RABx is valid only when ROAx is 1.

RRLx Relative coordinates are
0 : Not rounded by the amount of the shift per one rotation
1 : Rounded by the amount of the shift per one rotation

NOTE
1 RRLx is valid only when ROAx is 1.
2 Assign the amount of the shift per one rotation in parameter No.1260.

RMCx When machine coordinate system selection (G53) or high-speed machine coordinate system selection (G53P1) is specified, for the roll-over function of a rotation axis, the setting of bit 1 (RABx) of parameter No. 1008, which sets the direction of rotation for absolute commands, is:
0 : Invalid.
1 : Valid.

1010	Number of CNC-controlled axes
------	-------------------------------

NOTE
When this parameter is set, the power must be turned off before operation is continued.

[Data type] Byte
[Valid data range] 1, 2, 3, ..., the number of controlled axes

Set the maximum number of axes that can be controlled by the CNC.

Examples

Suppose that the first axis is the X axis, and the second and subsequent axes are the Y, Z, and A axes in that order, and that they are controlled as follows:

X, Y, and Z axes: Controlled by the CNC

A axis: Controlled by the PMC

Then set this parameter to 3 (total 3: 1st to 3rd axes)

With this setting, the fourth axis (A axis) is controlled only by the PMC, and therefore cannot be controlled directly by the CNC.

	#7	#6	#5	#4	#3	#2	#1	#0
1012								IDGx

[Data type] Bit axis

IDGx The function for setting the reference position again, without dogs, is:
 0 : Not inhibited.
 1 : Inhibited.

NOTE

- 1 IDGx is enabled when the IDG parameter (bit 7 of parameter No.1002) is 1.
- 2 When the function for setting the reference position without dogs is used, and the reference position is lost for some reason, an alarm requesting reference position return (No.300) is generated when the power is next turned on. If the operator performs reference position return, as a result of mistakenly identifying the alarm as that requesting the operator to perform a normal reference position return, an invalid reference position may be set. To prevent such an operator error, the IDGx parameter is provided to prevent the reference position from being set again without dogs.
 - (1) If the IDG parameter (bit 7 of parameter No.1002) is set to 1, the IDGx parameter (bit 0 of parameter No.1012) is automatically set to 1 when the reference position is set using the function for setting the reference position without dogs. This prevents the reference position from being set again without dogs.
 - (2) Once the reference position is prevented from being set for an axis again, without dogs, any attempt to set the reference position for the axis without dogs results in the output of an alarm (No.090).
 - (3) When the reference position must be set again without dogs, set IDGx to 0 before setting the reference position.

1015	#7	#6	#5	#4	#3	#2	#1	#0
	DWT	WIC	SVS	ZRL	RHR			
	DWT	WIC		ZRL	RHR			

- [Data type] Bit
- RHR After increment system (inch/metric) switching, for the rotation axis, the first G28 command causes reference position return:
 0 : At a low speed.
 1 : At a high speed/
- ZRL For high-speed reference position return according to G28, second to fourth reference position return according to G30, and G53 command:
 0 : Non-linear type positioning is performed.
 1 : Linear type positioning is performed.
 This parameter is valid when bit 1 (LRP) of parameter No. 1401 is set to 1.
- SVS When the servo along an axis is turned off, simple synchronous control is:
 0 : Released.
 1 : Not released.
- WIC Direct input of measured values for workpiece origin offsets is:
 0 : Enabled only in a selected workpiece coordinate system.
 1 : Enabled in all coordinate systems.

NOTE
 If this parameter is set to 0, measured values can be input directly only in the currently selected workpiece coordinate system or external workpiece coordinate system. If a measured value is input directly for a workpiece origin offset in another coordinate system, a warning is issued.

- DWT When a dwell time is specified with P, the unit of data is:
 0 : 1 ms for IS-B, or 0.1 ms for IS-C.
 1 : 1 ms. (Not depending on the increment system.)

1020	Program axis name for each axis
-------------	--

- [Data type] Byte axis
 Set the program axis name for each controlled axis, using one of the values listed in the following table:

Axis name	Setting	Axis name	Setting	Axis name	Setting	Axis name	Setting
X	88	U	85	A	65	E	69
Y	89	V	86	B	66	-	-
Z	90	W	87	C	67	-	-

NOTE

- 1 With the T series, when G code system A is used, neither U, V, nor W can be used as an axis name. Only when G code system B or C is used, U, V, and W can be used as axis names.
- 2 The same axis name cannot be assigned to more than one axis.
- 3 When the secondary auxiliary function (option) is provided, the address used by the secondary auxiliary function (address B with the T series or, with the M series, the address specified in parameter No.3460) cannot be used as an axis name.
- 4 With the T series, when address C or A is used for chamfering, corner rounding, or direct drawing dimension programming (when the CCR parameter (bit 4 of parameter No.3405) is set to 1), addresses C or A cannot be used as an axis name.
- 5 Only with the T series, address E can be used as an axis name. Address E cannot be used with the M series. When address E is used as an axis name, note the following:
 - When G code system A is used, address E is always assigned to an absolute command.
 - When an equal-lead threading command (G32) is issued in the FS10/11 command format, address E cannot be used to specify the thread lead. Use address F to specify the thread lead.

1022

Setting of each axis in the basic coordinate system

NOTE

When this parameter is set, power must be turned off before operation is continued.

[Data type]

Byte axis

To determine the following planes used for circular interpolation, cutter compensation C (for the M series), tool nose radius compensation (for the T series), etc., each control axis is set to one of the basic three axes X, Y, and Z, or an axis parallel to the X, Y, or Z axis.

- G17: Plane Xp-Yp
- G18: Plane Zp-Xp
- G19: Plane Yp-Zp

Only one axis can be set for each of the three basic axes X, Y, and Z, but two or more parallel axes can be set.

Set value	Meaning
0	Neither the basic three axes nor a parallel axis
1	X axis of the basic three axes

Set value	Meaning
2	Y axis of the basic three axes
3	Z axis of the basic three axes
5	Axis parallel to the X axis
6	Axis parallel to the Y axis
7	Axis parallel to the Z axis

1023

Number of the servo axis for each axis

NOTE

When this parameter is set, power must be turned off before operation is continued.

[Data type]
[Valid data range]

Byte axis

1, 2, 3, ..., number of control axes /-1,-2

Set the servo axis for each control axis.

Usually set to same number as the control axis number.

The control axis number is the order number that is used for setting the axis-type parameters or axis-type machine signals

To use a controlled axis as a spindle, specify -1.

Setting parameter CSS (bit 7 of parameter No. 3704) to 1 enables the second serial spindle to be assigned as Cs contour axis.

To use the second serial spindle as the Cs contour axis, set -2.

To use a hypothetical Cs axis for Cs contour control, also make a setting for spindle assignment.

Refer to FSSB section of CONNECTION MANUAL (Function) (B-64113EN-1).

4.10 PARAMETERS OF COORDINATES

	#7	#6	#5	#4	#3	#2	#1	#0
1201	WZR		AWK			ZCL		
			AWK			ZCL		

- [Data type] Bit
- ZCL Local coordinate system when the manual reference position return is performed
 0 : The local coordinate system is not canceled.
 1 : The local coordinate system is canceled.
- AWK When the workpiece zero point offset value is changed
 0 : The absolute position display changed when the next buffering block is performed.
 1 : The absolute position display is changed immediately. (Valid when automatic operation is not being started)
 Changed value is valid after buffering the next block.
- WZR Upon reset, the workpiece coordinate system is:
 0 : Not returned to that specified with G54
 1 : Returned to that specified with G54

	#7	#6	#5	#4	#3	#2	#1	#0
1202			SNC		RLC	G50	EWS	EWD
			SNC	G52	RLC			

- [Data type] Bit
- EWD The shift direction of the workpiece coordinate system is:
 0 : The direction specified by the external workpiece zero point offset value
 1 : In the opposite direction to that specified by the external workpiece zero point offset value

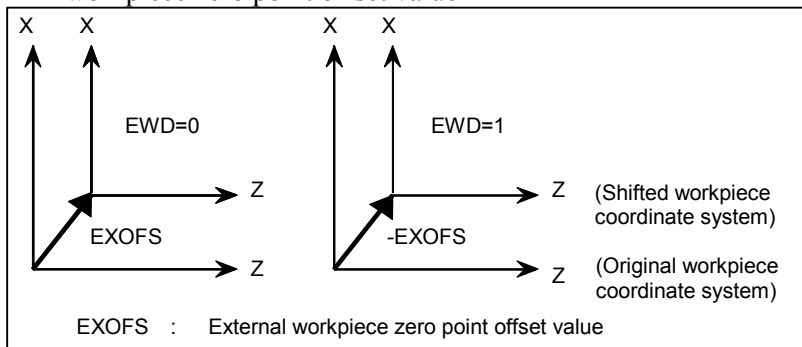

- EWS Shift value of the workpiece coordinate system and external workpiece zero point offset value are
 0 : Stored in the separate memory areas.
 1 : Stored in the same memory area, that is, the shift and the offset values are the same.

- G50 If the G50 command for setting a coordinate system (or the G92 command in G command system B or C) is specified,
 0 : G50 is executed and no alarm is issued.
 1 : G50 is not executed and a P/S alarm (No. 010) is issued.
- RLC Local coordinate system is
 0 : Not cancelled by reset
 1 : Cancelled by reset
- G52 In local coordinate system setting (G52), a cutter compensation vector is:
 0 : Not considered.
 1 : Considered.

NOTE
 Select a local coordinate system setting operation when cutter compensation is applied, and when two or more blocks specifying no movement exist prior to the specification of G52, or when G52 is specified after cutter compensation mode is canceled without eliminating the offset vector.

- SNC After a servo alarm is released, the local coordinate system (G52 or G92 (M series), or G52 or G50 (T series)) is:
 0 : Cleared.
 1 : Not cleared.

NOTE
 Even when this parameter is set to 1, the local coordinate system is cleared if a setting is made to allow the local coordinate system to be canceled by a reset (bit 3 (RLC) of parameter No. 1202 = 1).

	#7	#6	#5	#4	#3	#2	#1	#0
1203		MMD				68A		EMC
		MMD						EMC

- [Data type] Bit
 EMC The extended external machine zero point shift function is:
 0: Disabled.
 1: Enabled.

NOTE
 When the extended machine zero point shift function is enabled, the conventional external machine zero point shift function is disabled.

- 68A In automatic coordinate system setting of an absolute position detector in the mode of mirror image of facing two posts (G68):
 0 : Mirror image of facing two posts is not considered.
 1 : Mirror image of facing two posts is considered.

MMD In manual operation, the direction of axis movement for an axis for which the mirror image function is enabled is:
 0 : Not the same direction as in automatic operation.
 1 : The same direction as in automatic operation.

	#7	#6	#5	#4	#3	#2	#1	#0
1205			R2O	R1O				

[Data type] Bit
 R1O Signal output for the first reference position is:
 0 : Disabled.
 1 : Enabled.
 The reference position signal output function is required. See the description of parameter No.1245.
 R2O Signal output for the second reference position is:
 0 : Disabled.
 1 : Enabled.
 The reference position signal output function is required. See the description of parameter No.1246.

1220	External workpiece zero point offset value
------	--

[Data type] 2-word axis
 [Unit of data]

Input increment	IS-A	IS-B	IS-C	Unit
Linear axis (input in mm)	0.01	0.001	0.0001	mm
Linear axis (input in inches)	0.001	0.0001	0.00001	inch
Rotation axis	0.01	0.001	0.0001	deg

[Valid data range] -99999999 to 99999999
 This is one of the parameters that give the position of the origin of workpiece coordinate system (G54 to G59). It gives an offset of the workpiece origin common to all workpiece coordinate systems.
 In general, the offset varies depending on the workpiece coordinate systems. The value can be set from the PMC using the external data input function.

1221	Workpiece zero point offset value in workpiece coordinate system 1 (G54)
1222	Workpiece zero point offset value in workpiece coordinate system 2(G55)
1223	Workpiece zero point offset value in workpiece coordinate system 3(G56)
1224	Workpiece zero point offset value in workpiece coordinate system 4 (G57)
1225	Workpiece zero point offset value in workpiece coordinate system 5 (G58)
1226	Workpiece zero point offset value in workpiece coordinate system 6 (G59)

[Data type] 2-word axis
 [Unit of data]

Input increment	IS-A	IS-B	IS-C	Unit
Linear axis (input in mm)	0.01	0.001	0.0001	mm
Linear axis (input in inches)	0.001	0.0001	0.00001	inch
Rotation axis	0.01	0.001	0.0001	deg

[Valid data range] -99999999 to 99999999
 The workpiece zero point offset values in workpiece coordinate systems 1 to 6 (G54 to G59) are set.

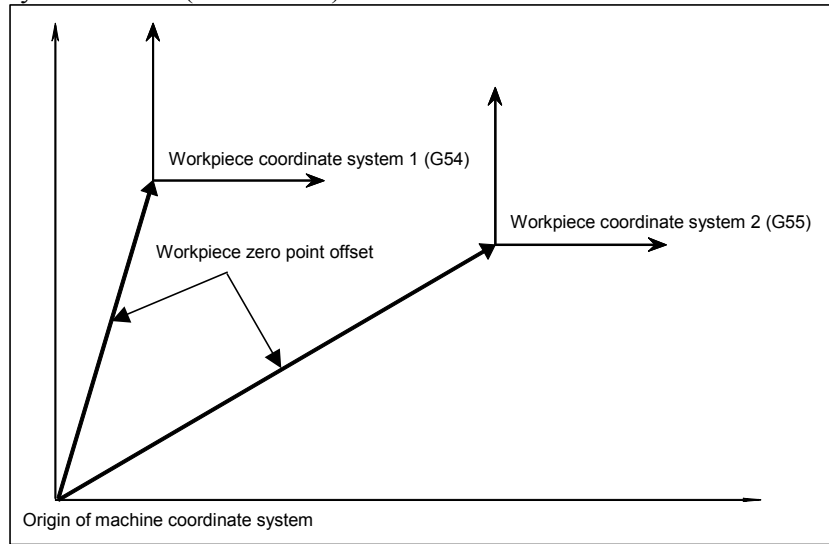

NOTE
 The workpiece origin offset can also be set using the workpiece coordinate system screen.

1240	Coordinate value of the first reference position on each axis in the machine coordinate system
1241	Coordinate value of the second reference position on each axis in the machine coordinate system
1242	Coordinate value of the third reference position on each axis in the machine coordinate system
1243	Coordinate value of the fourth reference position on each axis in the machine coordinate system

NOTE
When these parameters are set, power must be turned off before operation is continued.

[Data type] 2-word axis
[Unit of data]

Increment system	IS-A	IS-B	IS-C	Unit
Millimeter machine	0.01	0.001	0.0001	mm
Inch machine	0.001	0.0001	0.00001	inch
Rotation axis	0.01	0.001	0.0001	deg

[Valid data range] -99999999 to 99999999
Set the coordinate values of the first to fourth reference positions in the machine coordinate system.

1260	Amount of a shift per one rotation of a rotation axis
------	--

NOTE
When this parameter is set, the power must be turned off before operation is continued.

[Data type] 2-word axis
[Unit of data]

Increment system	Unit of data	Standard value
IS-A	0.01 deg	36000
IS-B	0.001 deg	360000
IS-C	0.0001 deg	3600000

[Valid data range] 1000 to 99999999
Set the amount of a shift per one rotation of a rotation axis.
For the rotation axis used for cylindrical interpolation, set the standard value.

1280	First address of the signal group used by the external machine zero point shift extension
-------------	--

[Data type]
[Valid data range]

Word
0 to 65535
Set the first address of the signal group used by the external machine zero point shift extension. If 100 is specified, R0100 to R0115 can be used.

R0100	Shift amount of external machine zero point shift extension for the first axis (LOW)
R0101	Shift amount of external machine zero point shift extension for the first axis (HIGH)
R0102	Shift amount of external machine zero point shift extension for the second axis (LOW)
R0103	Shift amount of external machine zero point shift extension for the second axis (HIGH)
:	:
R0114	Shift amount of external machine zero point shift extension for the eighth axis (LOW)
R0115	Shift amount of external machine zero point shift extension for the eighth axis (HIGH)

NOTE

- 1 If the specified number is not present, the external machine zero point shift extension is disabled.
- 2 A shift amount of the external machine zero point shift extension can be written from the macro executer.
- 3 This parameter is valid when bit 0 (EMC) of parameter No. 1203 is set to 1.

1290	Distance between two opposite tool posts in mirror image
-------------	---

[Data type]
[Unit of data]

2-word

Increment system	IS-A	IS-B	IS-C	Unit
Millimeter machine	0.01	0.001	0.0001	mm
Inch machine	0.001	0.0001	0.00001	inch

[Valid data range]

0 to 99999999
Set the distance between two opposite tool posts in mirror image.

4.11 PARAMETERS OF STROKE CHECK

	#7	#6	#5	#4	#3	#2	#1	#0
1300	BFA	LZR	RL3			LMS		OUT
	BFA	LZR				LMS		OUT

- [Data type] Bit
- OUT The area inside or outside of the stored stroke check 2 is set as an inhibition area (setting by the parameters No.1322 and No.1323).
 0: Inside
 1: Outside
- LMS The EXLM <G007#6> signal for switching stored stroke check
 0: Disabled
 1: Enabled

NOTE

Stored stroke check 1 supports two pairs of parameters for setting the prohibited area. The stored stroke limit switching signal is used to enable either of the prohibited areas set with these parameter pairs.

(1) Prohibited area I:
 Parameters No.1320 and No.1321

(2) Prohibited area II:
 Parameters No.1326 and No.1327

- RL3 Stored stroke check 3 release signal RLSOT3 <G007#4> is
 0: Disabled
 1: Enabled
- LZR Checking of stored stroke check 1 during the time from power-on to the manual position reference return
 0: The stroke check 1 is checked.
 1: The stroke check 1 is not checked

NOTE

When an absolute position detector is used and a reference position is already set upon power-up, stored stroke limit check 1 is started immediately after power-up, regardless of the setting.

- BFA When a command that exceeds a stored stroke check is issued
 0: An alarm is generated after the stroke check is exceeded.
 1: An alarm is generated before the stroke check is exceeded.

NOTE
 The tool stops at a point up to F/7500 mm short of or ahead of the boundary.
 (F: Feedrate when the tool reaches the boundary (mm/min))

	#7	#6	#5	#4	#3	#2	#1	#0
1301	PLC	OTF		OF1	OTA	NPC		DLM

- [Data type] Bit
- DLM The stored stroke limit switching signals <G104, G105> for each axial direction is:
 0: Disabled.
 1: Enabled.
- NPC As part of the stroke limit check performed before movement, the movement specified in G31 (skip) and G37 (automatic tool length measurement (for M series) or automatic tool compensation (for T series)) blocks is:
 0: Checked
 1: Not checked
- OTA If the tool is already in the prohibited area at power-up, an alarm of stored stroke limit 2 (inside) or stored stroke limit 3 is:
 0: Immediately raised.
 1: Not raised before a movement is made.
 Remark) When the alarm is immediately raised, the system enters the state before power-down.
 If this parameter is set to 1, no alarm is raised before a movement is made. If the direction of this movement is a direction away from the prohibited area, movements can be made in the opposite direction only. Accordingly, there is danger that the tool enters the prohibited area without an alarm.
- OF1 If the tool is moved into the range allowed on the axis after an alarm is raised by stored stroke check 1,
 0: The alarm is not canceled before a reset is made.
 1: The OT alarm is immediately canceled.

NOTE
 In the cases below, the automatic release function is disabled. To release an alarm, a reset operation is required.

- 1 When a setting is made to issue an alarm before a stored stroke limit is exceeded (bit 7 (BFA) of parameter No. 1300)
- 2 When an another overtravel alarm (such as stored stroke check 2 and stored stroke check 3) is already issued

- OTF When an overtravel alarm is issued:
 0 : No signal is output.
 1 : Signals are output to F124 and F126.
- PLC Stroke limit check before movement is:
 0: Not performed
 1: Performed

	#7	#6	#5	#4	#3	#2	#1	#0
1310							OT3x	OT2x
								OT2x

- [Data type] Bit axis
- OT2x Whether stored stroke check 2 is checked for each axis is set.
 0: Stored stroke check 2 is not checked.
 1: Stored stroke check 2 is checked.
- OT3x Whether stored stroke check 3 is checked for each axis is set.
 0: Stored stroke check 3 is not checked.
 1: Stored stroke check 3 is checked.

1320	Coordinate value l of stored stroke check 1 in the positive direction on each axis
1321	Coordinate value l of stored stroke check 1 in the negative direction on each axis

[Data type] 2-word axis
 [Unit of data]

Increment system	IS-A	IS-B	IS-C	Unit
Millimeter machine	0.01	0.001	0.0001	mm
Inch machine	0.001	0.0001	0.00001	inch
Rotation axis	0.01	0.001	0.0001	deg

[Valid data range] -99999999 to 99999999
 The coordinate values of stored stroke check 1 in the positive and negative directions are set for each axis in the machine coordinate system. The outside area of the two checks set in the parameters is inhibited.

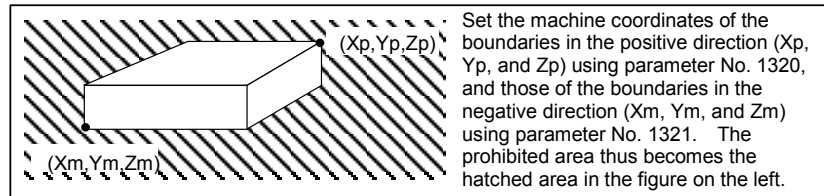

NOTE

- 1 For axes with diameter specification, a diameter value must be set.
- 2 When the parameters are set as follows, the stroke becomes infinite:
 parameter 1320 < parameter 1321
 For movement along the axis for which infinite stroke is set, only increment commands are available. (The stored stroke limit switching signal also becomes invalid.) If an absolute command is issued for this axis, the absolute register may overflow, and normal movement will not result.
- 3 The prohibited area specified with these parameters is invalid if bit 2 (LMS) of parameter No. 1300 is set to 1 and stored stroke limit switching signal EXLM <G007#6> is set to 1. In such a case, the settings of parameters No. 1326 and 1327 are used, instead.

1322 Coordinate value of stored stroke check 2 in the positive direction on each axis

1323 Coordinate value of stored stroke check 2 in the negative direction on each axis

[Data type] 2-word axis
 [Unit of data]

Increment system	IS-A	IS-B	IS-C	Unit
Millimeter machine	0.01	0.001	0.0001	mm
Inch machine	0.001	0.0001	0.00001	inch
Rotation axis	0.01	0.001	0.0001	deg

[Valid data range] -99999999 to 99999999
 Set the coordinate values of stored stroke check 2 in the positive and negative directions for each axis in the machine coordinate system. OUT, #0 of parameter 1300, sets either the area outside of the area inside specified by two checks are the inhibition area.

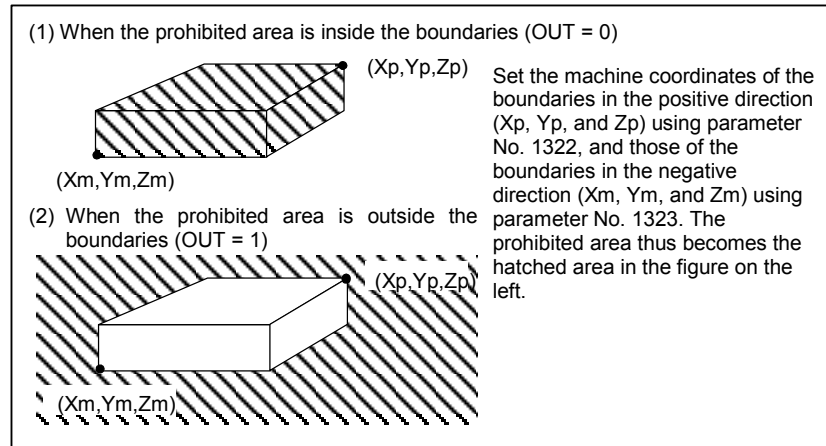

NOTE
 For axes with diameter specification, a diameter value must be set.

1324	Coordinate value of stored stroke check 3 in the positive direction on each axis
------	---

1325	Coordinate value of stored stroke check 3 in the negative direction on each axis
------	---

[Data type] 2-word axis
 [Unit of data]

Increment system	IS-A	IS-B	IS-C	Unit
Millimeter machine	0.01	0.001	0.0001	mm
Inch machine	0.001	0.0001	0.00001	inch
Rotation axis	0.01	0.001	0.0001	deg

[Valid data range] -99999999 to 99999999
 Set the coordinate values of stored stroke check 3 in the positive and negative directions for each axis in the machine coordinate system. The area inside the checks set in the parameter is inhibited.

NOTE

Specify diameters for any axis for which diameter programming is specified.

1326	Coordinate value II of stored stroke check 1 in the positive direction on each axis
------	--

1327	Coordinate value II of stored stroke check 1 in the negative direction on each axis
------	--

[Data type] 2-word axis
 [Unit of data]

Increment system	IS-A	IS-B	IS-C	Unit
Millimeter machine	0.01	0.001	0.0001	mm
Inch machine	0.001	0.0001	0.00001	inch
Rotation axis	0.01	0.001	0.0001	deg

[Valid data range] -99999999 to 99999999
 Set the coordinate values of stored stroke check 1 in the positive and negative directions for each axis in the machine coordinate system. The tool cannot enter the area outside the checks set in the parameter. The inhibition area set in the parameter is enabled when bit 2 (LMS) of parameter No. 1300 is 1 and stored stroke limit switching signal EXLM <G007#6> is 1.

NOTE

- 1 Specify diameter values for any axes for which diameter programming is specified.
- 2 These parameters are invalid if bit 2 (LMS) of parameter No. 1300 is set to 0, or if stored stroke limit switching signal EXLM <G007#6> is set to 0. In such a case, the settings of parameters No. 1320 and 1321 are used, instead.

4.12 PARAMETERS OF THE CHUCK AND TAILSTOCK BARRIER (T SERIES)

1330	Profile of a chuck
------	--------------------

[Data type] Byte
 [Valid data range] 0 or 1
 0: Chuck which holds a workpiece on the inner surface
 1: Chuck which holds a workpiece on the outer surface

1331	Dimensions of the claw of a chuck (L)
------	---------------------------------------

1332	Dimensions of the claw of a chuck (W)
------	---------------------------------------

1333	Dimensions of the part of a claw at which a workpiece is held (L1)
------	--

1334	Dimensions of the part of a claw at which a workpiece is held (W1)
------	--

1335	X coordinate of a chuck (CX)
------	------------------------------

1336	ZX coordinate of a chuck (CZ)
------	-------------------------------

[Data type] 2-word
 [Unit of data]

Increment system	IS-B	IS-C	Unit
Millimeter machine	0.001	0.0001	mm
Inch machine	0.0001	0.00001	inch

[Valid range] No.1331 to No.1334: 0 to 99999999
 No.1335 to No.1336: -99999999 to 99999999
 Specify the profile of a chuck.

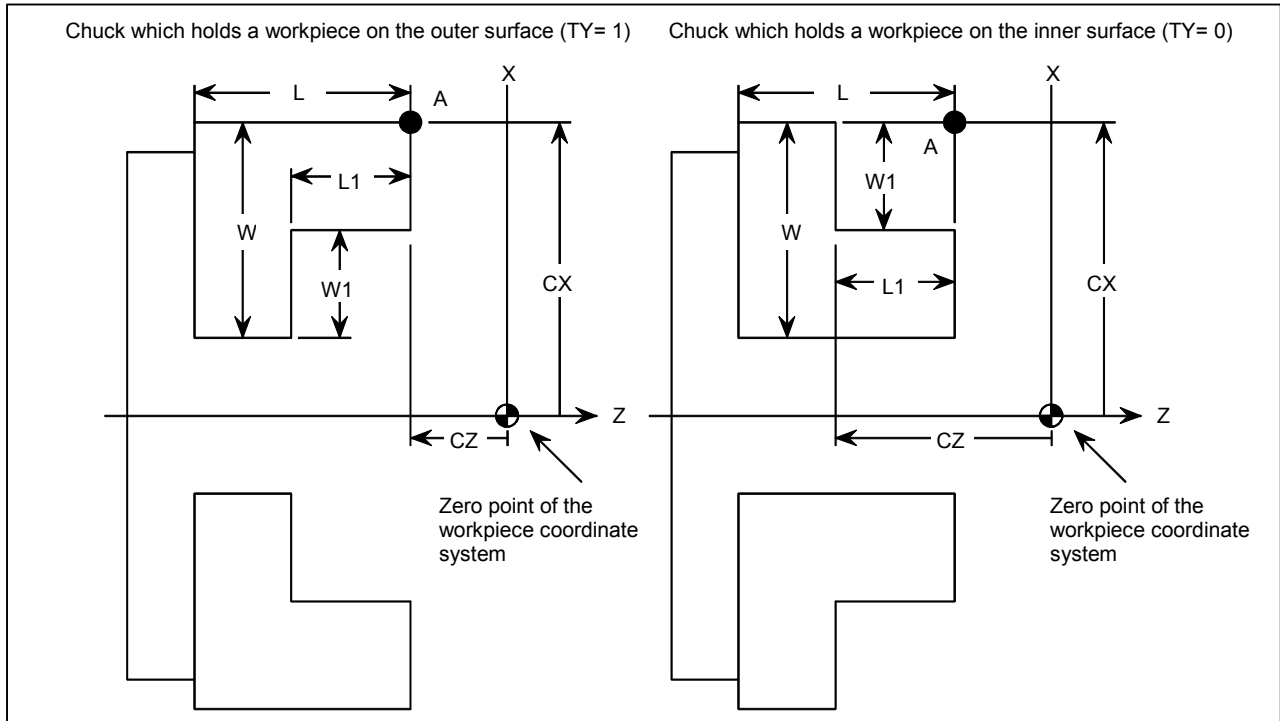

Symbol	Description
Ty	Profile of a chuck (0: Chuck which holds a workpiece on the inner surface, 1: Chuck which holds a workpiece on the outer surface)
CX	X coordinate of a chuck
CZ	Z coordinate of a chuck
L	Dimensions of the claw of a chuck
W	Dimensions of the claw of a chuck (radius input)
L1	Dimensions of the part of a claw at which a workpiece is held
W1	Dimensions of the part of a claw at which a workpiece is held (radius input)

TY Specifies the profile of a chuck. When TY is set to 0, the chuck holding a workpiece on the inner surface is specified. When TY is set to 1, the chuck holding a workpiece on the outer surface is specified. The profile of the chuck is assumed to be symmetrical with respect to the z-axis.

CX, and CZ Specify the position (point A) of a chuck with the coordinates of the workpiece coordinate system. In this case, do not use the coordinates of the machine coordinate system.

NOTE

Specifying the coordinates with a diameter or radius depends on whether the corresponding axis conforms to diameter or radius specification. When the axis conforms to diameter specification, specify the coordinates with a diameter.

L, L1, W and W1 Define the profile of a chuck.

NOTE
 Always specify W and W1 with radiuses. Specify L and L1 with radiuses when the Z-axis conforms to radius specification.

1341	Length of a tailstock (L)
1342	Diameter of a tailstock (D)
1343	Length of a tailstock (L1)
1344	Diameter of a tailstock (D1)
1345	Length of a tailstock (L2)
1346	Diameter of a tailstock (D2)
1347	Diameter of the hole of a tailstock (D3)
1348	Z coordinate of a tailstock (TZ)

[Data type] 2-words
 [Unit of data]

Increment system	IS-B	IS-C	Unit
Millimeter machine	0.001	0.0001	mm
Inch machine	0.0001	0.00001	inch

[Valid range] No.1341 to No.1347: 0 to 99999999
 No.1348: -99999999 to 99999999
 Specify the profile of a tailstock.

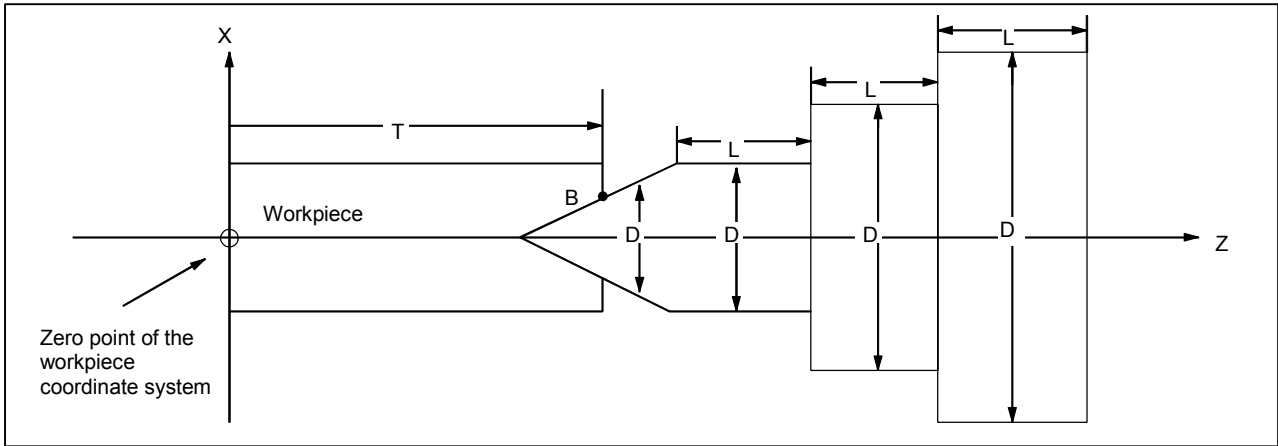

Symbol	Description
TZ	Z-axis coordinate of a tailstock
L	Length of a tailstock
D	Diameter of a tailstock (diameter input)
L1	Length of a tailstock (1)
D1	Diameter of a tailstock (1) (diameter input)
L2	Length of a tailstock (2)
D2	Diameter of a tailstock (2) (diameter input)
D3	Diameter of the hole of a tailstock (diameter input)

TZ: Specifies the position (point B) of a tailstock with the Z-axis coordinate of the workpiece coordinate system. In this case, do not use the coordinate of the machine coordinate system. The profile of a tailstock is assumed to be symmetrical with respect to the Z-axis.

NOTE
 Specifying the position of a tailstock with a radius or diameter depends on whether the Z-axis conforms to radius or diameter specification.

L, L1, L2, D, D1, D2, and D3 Define the profile of a tailstock.

NOTE
 Always specify D, D1, D2, and D3 with diameters. Specify L, L1, and L2 with radiuses if the Z-axis conforms to radius specification.

4.13 PARAMETERS OF FEEDRATE

	#7	#6	#5	#4	#3	#2	#1	#0
1401		RDR	TDR	RF0	JZR		LRP	RPD
		RDR	TDR	RF0			LRP	RPD

- [Data type] Bit
- RPD Manual rapid traverse during the period from power-on time to the completion of the reference position return.
0: Disabled (Jog feed is performed.)
1: Enabled
 - LRP Positioning (G00)
0: Positioning is performed with non-linear type positioning so that the tool moves along each axis independently at rapid traverse.
1: Positioning is performed with linear interpolation so that the tool moves in a straight line.
 - JZR The manual reference position return at JOG feedrate
0: Not performed
1: Performed
 - RF0 When cutting feedrate override is 0% during rapid traverse,
0: The machine tool does not stop moving.
1: The machine tool stops moving.
 - TDR Dry run during threading or tapping (tapping cycle G74 or G84, rigid tapping)
0: Enabled
1: Disabled
 - RDR Dry run for rapid traverse command
0: Disabled
1: Enabled

	#7	#6	#5	#4	#3	#2	#1	#0
1402				JRV		JOV		NPC
						JOV		NPC

- [Data type] Bit
- NPC The feed per rotation command is:
0: Ineffective when a position coder is not provided.
1: Effective even when a position coder is not provided (because the CNC converts it to the feed per minute command from F command S command).

NOTE
To use a position coder, set this parameter to 0. While this parameter is set to 1, threading cannot be performed even if a position coder is provided.

- JOV Job override is:
0: Enabled
1: Disabled (tied to 100%)
- JRV Jog feed or incremental feed is

- 0: Performed at feed per minute.
- 1: Performed at feed per rotation.

NOTE
Specify a feedrate in parameter No.1423.

1403		#7	#6	#5	#4	#3	#2	#1	#0
	RTV								MIF

NOTE
When this parameter is set, the power must be turned off before operation is continued.

- [Data type] Bit
- MIF Cutting feedrates at feed per minute is specified by F commands
- 0: In units of 1 mm/min for millimeter machines or 0.01 inches/min for inch machines.
 - 1: In unit of 0.001 mm/min for millimeter machines or 0.00001 inches/min for inch machines.

NOTE
M series are not equipped with this parameter.
Cutting feedrates are specified by F commands in units of 0.001 mm/min for millimeter machines or 0.00001 inches/min for inch machines.

- RTV Override while the tool is retracting in threading
- 0 : Override is effective.
 - 1 : Override is not effective.

1404		#7	#6	#5	#4	#3	#2	#1	#0
	FC0					FRV	F8A	DLF	HFC
	FC0			HCF	FRV	F8A	DLF	HFC	

- [Data type] Bit
- HFC The feedrate for helical interpolation is:
- 0: Clamped so that the feedrates along an arc and linear axis do not exceed the maximum cutting feedrate specified by parameter (No.1422 or 1430).
 - 1: Clamped so that the composite feedrate along an arc and linear axis does not exceed the maximum cutting feedrate specified by parameter (No.1422).
- DLF After a reference position is set, manual reference position return performed at:
- 0 : Rapid traverse rate (parameter No.1420)
 - 1 : Manual rapid traverse rate (parameter No.1424)

NOTE
 This parameter selects a feedrate for reference position return performed without dogs. This parameter also selects a feedrate when manual reference position return is performed according to bit 7 (SJZ) of parameter No.0002 using rapid traverse without deceleration dogs after a reference position is set.

<For T series>

F8A Valid data range for an F command in feed-per-minute mode
 0: Range specified with bit 0 (MIF) of parameter No.1403
 1:

Increment system	Units	IS-A, IS-B	IS-C
Millimeter input	mm/min	0.001 to 240000.	0.001 to 100000.
Inch input	inch/min	0.00001 to 9600.	0.00001 to 4000.
Rotation axis	deg/min	1 to 240000.	1 to 100000.

<For M series>

F8A Valid data range for an F command with a decimal point in feed-per-minute mode
 0:

Increment system	Units	IS-A, IS-B	IS-C
Millimeter input	mm/min	0.001 to 99999.999.	
Inch input	inch/min	0.00001 to 999.99999.	
Rotation axis (mm)	deg/min	1 to 240000.	1 to 100000.
Rotation axis (inch)	deg/min	1 to 9600.	1 to 4000.

1:

Increment system	Units	IS-A, IS-B	IS-C
Millimeter input	mm/min	0.001 to 240000.	0.001 to 100000.
Inch input	inch/min	0.00001 to 9600.	0.00001 to 4000.
Rotation axis	deg/min	1 to 240000.	1 to 100000.

FRV For inch input, the valid range of the feedrate specified for feed per revolution is:

0: Standard range. (F0.000001 to 9.999999 inches per revolution)
 1: Extended to F50.0 inches per revolution. (F0.000001 to 50.000000 inches per revolution)

HCF In AI contour control (M series), as the feedrate of helical interpolation:

0: A composite feedrate is specified.
 1: A feedrate along the arc is specified.

FC0 Specifies the behavior of the machine tool when a block (G01, G02, G03, etc.) containing a feedrate command (F command) that is 0 is issued during automatic operation, as follows:

0: A P/S alarm (No.011) is displayed, and the block is not executed.
 1: No alarm is displayed, and the block is executed.

	#7	#6	#5	#4	#3	#2	#1	#0
1405		FCI	EDR					

		FCI	EDR				FD3	F1U
--	--	------------	------------	--	--	--	------------	------------

[Data type] Bit

F1U Specifies the units of the data for the parameters that set the feedrates of the F1-digit feed commands (parameter Nos. 1451 to 1459).

Increment system	Units of data	
	When F1U is 0	When F1U is 1
Millimeter machine	0.1 mm/min	1 mm/min
Inch machine	0.001 inch/min	0.1 inch/min
Rotation axis	0.1 deg/min	1 deg/min

FD3 The number of significant digits of the fractional part in the feedrate command (F command) for feed per revolution is:
 0 : Up to two decimal positions (three decimal positions for inch input).

1 : Up to three decimal positions (four decimal positions for inch input).

EDR Selects a parameter for setting the external deceleration applied during interpolation type rapid traverse (bit 1 (LRP) of parameter No. 1401 = 1).

0 : Parameter No. 1426 is used for setting the external deceleration rate applied during interpolation type rapid traverse.

1 : The first axis of parameter No. 1427 is used for setting the external deceleration rate applied during interpolation type rapid traverse.

Similarly, for external deceleration 2, 3, 4, and 5, the first axis of the external deceleration rate parameter for rapid traverse is used if EDR is set to 1.

FCI When the inch input and feed per revolution are set, the clamp feedrate for cutting feed is set to:

0 : 9600 inch/min.

1 : 144000 inch/min.

	#7	#6	#5	#4	#3	#2	#1	#0
1406							ED3	ED2

[Data type] Bit
 ED2 External deceleration 2 is:
 0 : Disabled.
 1 : Enabled.
 ED3 External deceleration 3 is:
 0 : Disabled.
 1 : Enabled.

	#7	#6	#5	#4	#3	#2	#1	#0
1407					ACS			
	ACF				ACS			

[Data type] Bit
 ACS If the reference position return for a Cs axis is not completed when linear interpolation type positioning including the Cs axis is specified:
 0 : A movement is made by non-linear interpolation type positioning (rapid traverse is performed separately for each axis).
 1 : A P/S alarm (No. 5334) is issued.
 ACF In AI advanced preview control or AI contour control mode, the feedrate clamp value is:
 0 : The setting of parameter No. 1432 or the setting of parameter No. 1422, whichever smaller.
 (If one of these settings is 0, a P/S alarm (No. 5157) is issued.)
 1 : The setting of parameter No. 1432 if a non-zero value is set in parameter No. 1432.
 If 0 is set in parameter No. 1432, the setting of parameter No. 1422 is used.
 If 0 is set in parameter No. 1422, a P/S alarm (No. 5157) is issued.
 Parameter No. 1422 = Maximum cutting feedrate
 Parameter No. 1432 = Maximum cutting feedrate for each axis in the advanced preview control mode

	#7	#6	#5	#4	#3	#2	#1	#0
1408								
								RFD

[Data type] Bit axis type
 RFD The feedrate about a rotation axis is controlled:
 0: In the usual method.
 1: By converting the rotation speed about the rotation axis into the travel speed on the circumference of a virtual circle.
 Set the radius of the virtual circle in parameter No. 1465.

1410	Dry run rate
------	--------------

[Data type] Word

[Unit of data, valid data range]

Increment system	Unit of data	Valid data range	
		IS-A, IS-B	IS-C
Millimeter machine	1 mm/min	6 to 15000	6 to 12000
Inch machine	0.1 inch/min	6 to 6000	6 to 4800

Set the dry run rate when the manual feedrate is overridden by 100%.

1411	Cutting feedrate in the automatic mode at power-on (initial value)
-------------	---

The following parameter can be set at "Setting screen".

[Data type] Word

[Unit of data, valid data range]

Increment system	Unit of data	Valid data range
Millimeter machine	1 mm/min	6 to 32767
Inch machine	0.1 inch/min	6 to 32767

When the machine requires little change in cutting feedrate during cutting, a cutting feedrate can be specified in the parameter. This eliminates the need to specify a cutting feedrate (F command) in the NC program.

The cutting feedrate set by this parameter is valid after the CNC is placed in the clear state by power-up or a reset until a feedrate is specified by a program command (F command). After a feedrate is specified by the F command, the feedrate becomes valid.

1420	Rapid traverse rate for each axis
-------------	--

[Data type] 2-word axis

[Unit of data, valid data range]

Increment system	Unit of data	Valid data range	
		IS-A, IS-B	IS-C
Millimeter machine	1 mm/min	30 to 240000	6 to 100000
Inch machine	0.1 inch/min	30 to 96000	6 to 48000
Rotation axis	1 deg/min	30 to 240000	6 to 100000

Set the rapid traverse rate when the rapid traverse override is 100% for each axis.

1421

F0 rate of rapid traverse override for each axis

[Data type] Word axis

[Unit of data, valid data range]

Increment system	Unit of data	Valid data range	
		IS-A, IS-B	IS-C
Millimeter machine	1 mm/min	30 to 15000	30 to 12000
Inch machine	0.1 inch/min	30 to 6000	30 to 4800
Rotation axis	1 deg/min	30 to 15000	30 to 12000

Set the F0 rate of the rapid traverse override for each axis.

Rapid traverse override signal		Override value
ROV2	ROV1	
0	0	100%
0	1	50%
1	0	25%
1	1	F0

F0: Parameter 1421

1422

Maximum cutting feedrate for all axes

[Data type] 2-word

[Unit of data, valid data range]

Increment system	Unit of data	Valid data range	
		IS-A, IS-B	IS-C
Millimeter machine	1 mm/min	6 to 240000	6 to 100000
Inch machine	0.1 inch/min	6 to 96000	6 to 48000

Specify the maximum cutting feedrate.

A feedrate in the tangential direction is clamped in cutting feed so that it does not exceed the feedrate specified in this parameter.

NOTE

- 1 A maximum cutting feedrate can be specified for each axis only during linear interpolation and circular interpolation by using parameter No. 1430.
- 2 Even when parameter No. 1430 is used, clamping to a maximum cutting feedrate based on parameter No. 1422 is enabled during polar coordinate interpolation and cylindrical interpolation.

1423

Feedrate in manual continuous feed (jog feed) for each axis

[Data type] Word axis

- (1) In M series, or in T series when JRV, bit 4 of parameter No.1402, is set to 0 (feed per minute), specify a jog feedrate at feed per minute with an override of 100%.

[Unit of data, valid data range]

Increment system	Unit of data	Valid data range	
		IS-A, IS-B	IS-C
Millimeter machine	1 mm/min	6 to 15000	6 to 12000
Inch machine	0.1 inch/min	6 to 6000	6 to 4800
Rotation axis	1 deg/min	6 to 15000	6 to 12000

- (2) When JRV, bit 4 of parameter No.1402, is set to 1 (feed per revolution) in T series, specify a jog feedrate (feed per revolution) under an override of 100%.

[Unit of data, valid data range]

Increment system	Unit of data	Valid data range
Millimeter machine	0.01 mm/rev	0 to 32767
Inch machine	0.001 mm/rev	
Rotation axis	0.01 deg/rev	

1424

Manual rapid traverse rate for each axis

[Data type] 2-word axis

[Unit of data, valid data range]

Increment system	Unit of data	Valid data range	
		IS-A, IS-B	IS-C
Millimeter machine	1 mm/min	30 to 240000	30 to 100000
Inch machine	0.1 inch/min	30 to 96000	30 to 48000
Rotation axis	1 deg/min	30 to 240000	30 to 100000

Set the rate of manual rapid traverse when the rapid traverse override is 100% for each axis.

NOTE

If 0 is set, the rate set in parameter 1420 is assumed.

1425

FL rate of the reference position return for each axis

[Data type] Word axis

[Unit of data, valid data range]

Increment system	Unit of data	Valid data range	
		IS-A, IS-B	IS-C
Millimeter machine	1 mm/min	6 to 15000	6 to 12000
Inch machine	0.1 inch/min	6 to 6000	6 to 4800
Rotation axis	1 deg/min	6 to 15000	6 to 12000

Set feedrate (FL rate) after deceleration when the reference position return is performed for each axis.

1426	External deceleration rate 1 of cutting feed
-------------	---

[Data type] Word
 [Unit of data, valid data range]

Increment system	Unit of data	Valid data range	
		IS-A, IS-B	IS-C
Millimeter machine	1 mm/min	6 to 15000	6 to 12000
Inch machine	0.1 inch/min	6 to 6000	6 to 4800

Set the external deceleration rate of cutting feed.

1427	External deceleration rate 1 of rapid traverse for each axis
-------------	---

[Data type] Word axis
 [Unit of data, valid data range]

Increment system	Unit of data	Valid data range	
		IS-A, IS-B	IS-C
Millimeter machine	1 mm/min	6 to 15000	6 to 12000
Inch machine	0.1 inch/min	6 to 6000	6 to 4800
Rotation axis	1 deg/min	6 to 15000	6 to 12000

Set the external deceleration rate of rapid traverse for each axis.

1428

Reference position return feedrate

[Data type] 2-word axis

[Unit of data, valid data range]

Increment system	Unit of data	Valid data range	
		IS-A, IS-B	IS-C
Millimeter machine	1 mm/min	30 to 240000	6 to 100000
Inch machine	0.1 inch/min	30 to 96000	6 to 48000
Rotation axis	1 deg/min	30 to 240000	6 to 100000

This parameter sets a rapid traverse rate for reference position return operation using deceleration dogs, or for reference position return operation before a reference position is set.

This parameter is also used to set a feedrate for the rapid traverse command (G00) in automatic operation before a reference position is set.

NOTE

- 1 This parameter is invalid for an axis using the scale with absolute addressing reference marks.
- 2 When 0 is set in this parameter, this parameter disables the reference position return feedrate setting function.

	Before a reference position is set		After a reference position is set	
	No. 1428		No. 1428	
	=0	≠0	=0	≠0
Reference position return by G28	No.1420	No.1428	No.1420	
Raped traverse command (G00) in automatic operation			No.1420 or No.1424 ^{(*)3}	
Manual reference position return	Without dogs ^{(*)1}	No.1424	No.1424	No.1428
	With dogs ^{(*)1}		No.1424	
Manual raped traverse	No.1423 or No.1424 ^{(*)2}		No.1424	

*1 With/without dogs: Reference position return operation not using/using deceleration dogs

*2 For manual rapid traverse before a reference position is set, a jog feedrate (parameter No.1423) or manual raped traverse rate (parameter No.1424) is used according to the setting of bit 0 (RPD) of parameter No.1401.

*3 The rapid traverse rate set in parameter No.1424 or No.1420 is used according to the setting of bit 1 (DLF) of parameter No.1404 when reference position return is performed without dogs, or when reference position return operation is performed with bit 7 (SJZ) of parameter No.0002 set to 1 after a reference position is set (when reference position return operation is performed using rapid traverse without deceleration dogs).

1430	Maximum cutting feedrate for each axis
------	---

[Data type] 2-word axis
 [Unit of data, valid data range]

Increment system	Unit of data	Valid data range	
		IS-A, IS-B	IS-C
Millimeter machine	1 mm/min	6 to 240000	6 to 100000
Inch machine	0.1 inch/min	6 to 96000	6 to 48000
Rotation axis	1 deg/min	6 to 240000	6 to 100000

Specify the maximum cutting feedrate for each axis.
 A feedrate for each axis is clamped in cutting feed so that it does not exceed the maximum feedrate specified for each axis.

NOTE

- 1 This parameter is valid only during linear interpolation and circular interpolation. Even when this parameter is set, clamping to a maximum cutting feedrate based on parameter No. 1422 is enabled during polar coordinate interpolation, cylindrical interpolation, and involute interpolation (M series).
- 2 When this parameter is set to 0 for all axes, clamping to a maximum cutting feedrate based on parameter No. 1422 is enabled.
 This means that if a value other than 0 is set for any of the axes with this parameter, clamping to a maximum cutting feedrate is performed for all axes during linear interpolation or circular interpolation according to this parameter.

1431	Maximum cutting feedrate for all axes in the advanced preview control mode
------	---

[Data type] 2-words
 [Unit of data, valid data range]

Increment system	Unit of data	Valid data range	
		IS-A, IS-B	IS-C
Millimeter machine	1 mm/min	0 to 240000	0 to 100000
Inch machine	0.1 inch/min	0 to 96000	0 to 48000
Rotation axis	1 deg/min	0 to 240000	0 to 100000

Specify the maximum cutting feedrate for all axes in the advanced preview control mode.
 A feedrate in the tangential direction is clamped in cutting feed so that it does not exceed the feedrate specified in this parameter.

NOTE

- 1 To specify the maximum cutting feedrate for each axis, use parameter No.1432 instead.
- 2 In a mode other than the look-ahead mode, the maximum cutting feedrate specified in parameter No.1422 or No.1430 is applied and the feedrate is clamped at the maximum feedrate.

1432

Maximum cutting feedrate for each axis in the advanced preview control mode

Maximum cutting feedrate for each axis in the AI advanced preview control / AI contour control mode or advanced preview control mode

[Data type] 2-word axis
 [Unit of data, valid data range]

Increment system	Unit of data	Valid data range	
		IS-A, IS-B	IS-C
Millimeter machine	1 mm/min	0 to 240000	0 to 100000
Inch machine	0.1 inch/min	0 to 96000	0 to 48000
Rotation axis	1 deg/min	0 to 240000	0 to 100000

Specify the maximum cutting feedrate for each axis in the AI advanced preview control / AI contour control mode or advanced preview control mode.
 A feedrate for each axis is clamped during cutting feed so that it does not exceed the maximum cutting feedrate specified for each axis.

NOTE

- 1 This parameter is effective only in linear and circular interpolation. In polar coordinate and cylindrical interpolation, the maximum feedrate for all axes specified in parameter No.1431 is effective.
- 2 If a setting for each axis is 0, the maximum feedrate specified in parameter No.1431 is applied to all axes and the feedrate is clamped at the maximum feedrate.
- 3 In a mode other than the AI advanced preview control / AI contour control mode or advanced preview mode, the maximum cutting feedrate specified in parameter No.1422 or No.1430 is applied and the feedrate is clamped at the maximum feedrate.

1436	Maximum speed for each axis for the speed check function
-------------	---

[Data type] 2-word axis
 [Unit of data, valid data range]

Increment system	Unit of data	Valid data range	
		IS-A, IS-B	IS-C
Millimeter machine	1 mm/min	0,30 to 240000	0,6 to 100000
Inch machine	0.1 inch/min	0,30 to 96000	0,6 to 48000
Rotation axis	1 deg/min	0,30 to 240000	0,6 to 100000

If 0 is set, this function is disabled.

Set the maximum speed for each axis. If the speed set in this parameter is exceeded, a P/S alarm (No. 5323) indicating an excessive speed is issued, and the movement is decelerated then stopped.

The speed check function checks data obtained by converting this parameter value to the amount of a movement made every 8 ms.

1440	External deceleration rate 2 of cutting feed
-------------	---

[Data type] Word
 [Unit of data, valid data range]

Increment system	Unit of data	Valid data range	
		IS-A, IS-B	IS-C
Millimeter machine	1 mm/min	6 to 15000	6 to 12000
Inch machine	0.1 inch/min	6 to 6000	6 to 4800

Set the external deceleration rate of cutting feed.

1441	External deceleration rate 2 of rapid traverse for each axis
-------------	---

[Data type] Word axis
 [Unit of data, valid data range]

Increment system	Unit of data	Valid data range	
		IS-A, IS-B	IS-C
Millimeter machine	1 mm/min	6 to 15000	6 to 12000
Inch machine	0.1 inch/min	6 to 6000	6 to 4800
Rotation axis	1 deg/min	6 to 15000	6 to 12000

Set the external deceleration rate of rapid traverse for each axis.

1442

Maximum feedrate 2 of manual handle feed for each axis

[Data type]
[Unit of data, valid data range]

Word axis

Increment system	Unit of data	Valid data range	
		IS-A, IS-B	IS-C
Millimeter machine	1 mm/min	6 to 15000	6 to 12000
Inch machine	0.1 inch/min	6 to 6000	6 to 4800
Rotation axis	1 deg/min	6 to 15000	6 to 12000

Set the maximum feedrate of manual handle feed for each axis.

1443

External deceleration rate 3 of cutting feed

[Data type]
[Unit of data, valid data range]

Word

Increment system	Unit of data	Valid data range	
		IS-A, IS-B	IS-C
Millimeter machine	1 mm/min	6 to 15000	6 to 12000
Inch machine	0.1 inch/min	6 to 6000	6 to 4800

Set the external deceleration rate of cutting feed.

1444

External deceleration rate 3 of rapid traverse for each axis

[Data type]
[Unit of data, valid data range]

Word axis

Increment system	Unit of data	Valid data range	
		IS-A, IS-B	IS-C
Millimeter machine	1 mm/min	6 to 15000	6 to 12000
Inch machine	0.1 inch/min	6 to 6000	6 to 4800
Rotation axis	1 deg/min	6 to 15000	6 to 12000

Set the external deceleration rate of rapid traverse for each axis.

1445

Maximum feedrate 3 of manual handle feed for each axis

[Data type]
[Unit of data, valid data range]

Word axis

Increment system	Unit of data	Valid data range	
		IS-A, IS-B	IS-C
Millimeter machine	1 mm/min	6 to 15000	6 to 12000
Inch machine	0.1 inch/min	6 to 6000	6 to 4800
Rotation axis	1 deg/min	6 to 15000	6 to 12000

Set the maximum feedrate of manual handle feed for each axis.

1450

**Change of feedrate for one graduation on the manual pulse generator during
F1 digit feed**

[Data type]	Byte
[Valid data range]	1 to 127
	Set the constant that determines the change in feedrate as the manual pulse generator is rotated one graduation during F1-digit feed.
	$\Delta F = \frac{F \max i}{100n}$ (where, i=1 or 2)
	In the above equation, set n. That is, the number of revolutions of the manual pulse generator, required to reach feedrate Fmaxi is obtained. Fmaxi refers to the upper limit of the feedrate for an F1-digit feed command, and set it in parameter 1460 or 1461.
	Fmax1: Upper limit of the feedrate for F1 to F4 (parameter 1460)
	Fmax2: Upper limit of the feedrate for F5 to F9 (parameter 1461)

1451	Feedrate for F1 digit command F1
1452	Feedrate for F1 digit command F2
1453	Feedrate for F1 digit command F3
1454	Feedrate for F1 digit command F4
1455	Feedrate for F1 digit command F5
1456	Feedrate for F1 digit command F6
1457	Feedrate for F1 digit command F7
1458	Feedrate for F1 digit command F8
1459	Feedrate for F1 digit command F9

The following parameter can be set at "Setting screen".

[Data type] 2-word
 [Unit of data, valid data range]

(1) When the F1U parameter (bit 0 of parameter No.1405) is 0

Increment system	Unit of data	Valid data range	
		IS-A, IS-B	IS-C
Millimeter machine	0.1 mm/min	6 to 150000	6 to 120000
Inch machine	0.01 inch/min	6 to 60000	6 to 48000
Rotation axis	0.1 deg/min	6 to 150000	6 to 120000

(2) When the F1U parameter (bit 0 of parameter No.1405) is 1

Increment system	Unit of data	Valid data range	
		IS-A, IS-B	IS-C
Millimeter machine	1 mm/min	6 to 15000	6 to 12000
Inch machine	0.1 inch/min	6 to 6000	6 to 4800
Rotation axis	1 deg/min	6 to 15000	6 to 12000

These parameters set the feedrates for 1-digit feed commands F1 to F9. When an 1-digit feed command is specified, and the feedrate is changed by turning the manual pulse generator, the parameter-set value also changes accordingly.

1460	
	Upper limit of feedrate for the one-digit F code command (F1 to F4)
1461	
	Upper limit of feedrate for the one-digit F code command (F5 to F9)

[Data type] 2-word

[Unit of data, valid data range]

Increment system	Unit of data	Valid data range	
		IS-A, IS-B	IS-C
Millimeter machine	1 mm/min	6 to 15000	6 to 12000
Inch machine	0.1 inch/min	6 to 6000	6 to 4800
Rotation axis	1 deg/min	6 to 15000	6 to 12000

Set the upper limit of feedrate for the F1-digit feed command.

As the feedrate increases by turning the manual pulse generator, the feedrate is clamped when it reaches the upper limit set. If an F1-digit feed command F1 to F4 is executed, the upper limit is that set in parameter 1460. If an F1-digit command F5 to F9 is executed, the upper limit is that set in parameter 1461.

1465	
	Virtual radius for feedrate control about rotation axis

[Data type] 2-word axis
 [Unit of data]

Increment system	IS-A	IS-B	IS-C	Unit
Metric input	0.01	0.001	0.0001	mm
Inch input				inch

[Valid data range] 0 to 99999999
 Set the radius of a virtual circle when using such a control method that the feedrate of a rotation axis is converted to a travel speed on a circle of a virtual radius.

NOTE

- 1 Note that the increment system remains unchanged regardless of whether metric input or inch input is used.
- 2 This function is enabled when bit 0 (ROT_x) of parameter No. 1006 and bit 0 (RFD_x) of parameter No. 1408 are set to 1.
- 3 Be careful when setting bit 0 (RFD_x) of parameter No. 1408 and parameter No. 1465 (virtual radius). In particular, when this function is used with a small virtual radius value, axis movement speeds up.
- 4 If a large value is set for the amount of travel and parameter No. 1465 (virtual radius), an alarm (P/S 5307: Internal data exceeded an allowable range.) is issued.
- 5 This function cannot be used in the following modes:
 Rapid traverse, inverse time feed (G93), feed per revolution (G94), threading, AI advanced preview control, AI contour control

1466	Feedrate of retraction in the threading cycle

[Data type] 2-word
 [Unit of data, valid data range]

Increment system	Unit of data	Valid data range	
		IS-A, IS-B	IS-C
Millimeter machine	1 mm/min	30 to 240000	6 to 100000
Inch machine	0.1 inch/min	30 to 96000	6 to 48000
Rotation axis	1 deg/min	30 to 240000	6 to 100000

Set the feedrate of retraction in a threading cycle.
 If 0 is set in this parameter, a movement is made at the feedrate (rapid traverse rate) set in parameter No. 1420.

[Example] When G92 is specified

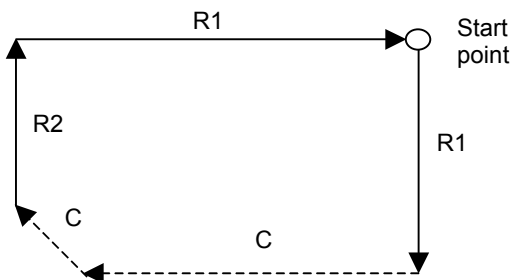

In the above figure, R1 denotes the rapid traverse rate, and C denotes the cutting feedrate.
 Feedrate R2 is set by this parameter. If 0 is set in this parameter, R2 is the same feedrate as R1.

4.14 PARAMETERS OF ACCELERATION/DECELERATION CONTROL

	#7	#6	#5	#4	#3	#2	#1	#0
1601			NCI	RTO				
		ACD	NCI	RTO		OVB		

[Data type] Bit

OVB

Block overlap in cutting feed

0: Blocks are not overlapped in cutting feed.

1: Blocks are overlapped in cutting feed.

Block overlap outputs the pulses remaining at the end of pulse distribution in a block together with distribution pulses in the next block. This eliminates changes in feedrates between blocks.

Block overlap is enabled when blocks containing G01, G02, or G03 are consecutively specified in G64 mode. If minute blocks, however, are specified consecutively, overlap may not be performed.

The following pulses in block F2 are added to the pulses remaining at the end of pulse distribution in block F1.

$$(\text{Number of pulses to be added}) = F2 \times \frac{(\text{Number of pulses required at the end of block F1})}{F1}$$

When F1 = F2

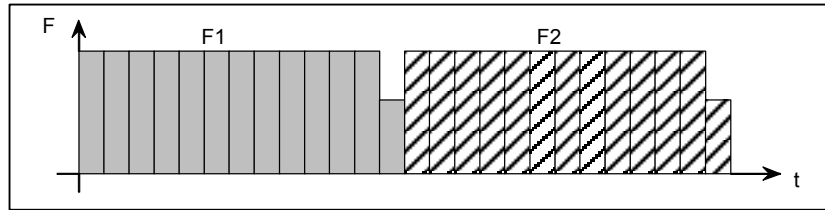

When block overlap is disabled

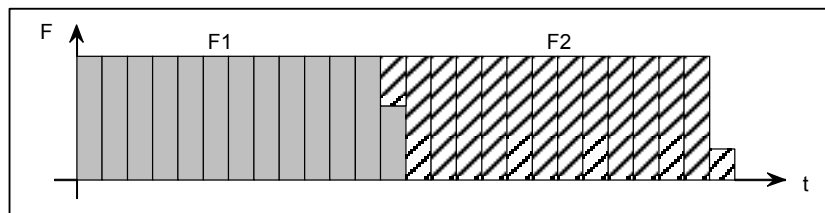

When block overlap is enabled

RTO Block overlap in rapid traverse

0: Blocks are not overlapped in rapid traverse.

1: Blocks are overlapped in rapid traverse.

NOTE

See the description of parameter No.1722.

NCI In-position check at deceleration

0: Performed

1: Not performed

ACD Function for automatically reducing the feedrate at corners (automatic corner override function)
 0 : The function is not used.
 1 : The function is used.

	#7	#6	#5	#4	#3	#2	#1	#0
1602		LS2	G8S	CSD				FWB
		LS2	G8S	CSD	BS2	COV		FWB

[Data type] Bit
 FWB Cutting feed acceleration/deceleration before interpolation
 0 : Type A of acceleration/deceleration before interpolation is used.
 1 : Type B of acceleration/deceleration before interpolation is used.
 Type A:
 When a feedrate is to be changed by a command, acceleration/deceleration starts after the program enters the block in which the command is specified.
 Type B:
 When a feedrate is to be changed by a command, deceleration starts and terminates at the block before the block in which the command is specified.
 When a feedrate is to be changed by a command, acceleration starts after the program enters the block in which the command is specified.

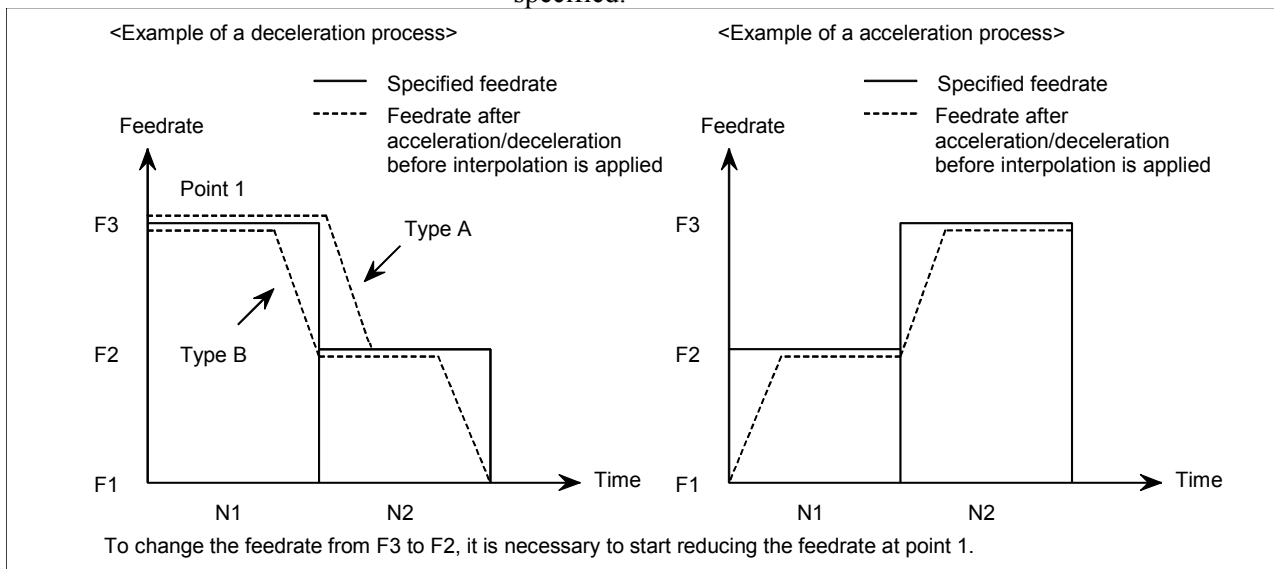

COV The outer arc cutting feedrate change function of the automatic corner override function is:
 0 : Not used.
 1 : Used.

BS2 The type of acceleration/deceleration after interpolation in cutting feed in advanced preview control mode is:
 0 : Specified by bit 6 (LS2) of parameter No. 1602.
 1 : Bell-shaped acceleration/deceleration.

BS2	LS2	Acceleration/deceleration
0	0	Exponential acceleration/deceleration after interpolation
0	1	Linear acceleration/deceleration after interpolation
1	0	Bell-shaped acceleration/deceleration after interpolation. (The option for bell-shaped acceleration/deceleration after interpolation for cutting feed is required.)

CSD In the function for automatically reducing a feedrate at corners,
 0 : Angles are used for controlling the feedrate.
 1 : Differences in feedrates are used for controlling the feedrate.

G8S Serial spindle advanced preview control is:
 0 : Disabled.
 1 : Enabled.
 When enabled, advanced preview control can be applied to the following functions:

- Rigid tapping
- Cs contour control
- Spindle positioning (only when bit 3 of parameter No.1800 is 1)

NOTE
 For Cs contour control and rigid tapping, advanced preview control is valid only for the first spindle. Cs contour control and rigid tapping with the second spindle does not support advanced preview control.

LS2 Type of acceleration/deceleration after interpolation in cutting feed in advanced preview control, AI advanced preview control, or AI contour control mode
 0 : Exponential acceleration/deceleration is applied (advanced preview control), or no acceleration/deceleration is applied (AI advanced preview control and AI contour control).
 1 : Linear acceleration/deceleration is applied.

	#7	#6	#5	#4	#3	#2	#1	#0
1603				RPT				
	BEL	RBL		RPT				

[Data type] Bit
 PRT The acceleration/deceleration of interpolation-type rapid traverse is performed:
 0: With a constant inclination.
 1: With a constant time.

NOTE
 1 The acceleration/deceleration time constant and override for rapid traverse are used.
 2 Rapid traverse block overlap cannot be used.

RBL In the AI advanced preview control / AI contour control, acceleration/deceleration of rapid traverse is:
 0: Linear acceleration/deceleration.

1: Bell-shaped acceleration/deceleration.

NOTE
Bit 4 (PRT) of parameter No. 1603 is invalid.

BEL In the AI contour control mode:
 0 : Linear acceleration/deceleration before look-ahead interpolation is used.
 1 : Bell-shaped acceleration/deceleration before look-ahead interpolation is used.

	#7	#6	#5	#4	#3	#2	#1	#0
1604								
						DS2		

[Data type] Bit
 DS2 When an overtravel alarm is issued for stored stroke check 2 during linear acceleration/deceleration before interpolation, the function to perform deceleration in advance so that the feedrate set in parameter No. 12700 can be attained at the issuance of the alarm is:
 0 : Disabled.
 1 : Enabled.

	#7	#6	#5	#4	#3	#2	#1	#0
1610				JGLx				CTLx
				JGLx			CTBx	CTLx

[Data type] Bit axis
 CTLx Acceleration/deceleration in cutting feed including feed in dry run
 0 : Exponential acceleration/deceleration is applied.
 1 : Linear acceleration/deceleration after interpolation is applied.

NOTE
To use bell-shaped acceleration/deceleration after interpolation, set this parameter to 0 and select the acceleration/deceleration using CTBx, bit 1 of parameter No.1610.

Parameter		Acceleration/deceleration
CTBx	CTLx	
0	0	Exponential acceleration/deceleration
0	1	Linear acceleration/deceleration after interpolation
1	0	Bell-shaped acceleration/deceleration after interpolation

CTBx Acceleration/deceleration in cutting feed including feed in dry run
 0 : Exponential acceleration/deceleration or linear acceleration/deceleration after interpolation is applied (depending on the setting in CTLx, bit 0 of parameter No.1610).

1 : Bell-shaped acceleration/deceleration after interpolation is applied.

NOTE

This parameter is effective only when the function of bell-shaped acceleration/deceleration after interpolation in cutting feed is provided. If the function is not provided, the setting in CTLx, bit 0 of parameter No.1610, determines the type of acceleration/deceleration irrespective of the setting in this parameter.

JGLx Acceleration/deceleration in jog feed
 0 : Exponential acceleration/deceleration is applied.
 1 : Linear acceleration/deceleration after interpolation or bell-shaped acceleration/deceleration after interpolation is applied (depending on which is used for cutting feed).

1620

Time constant T or T₁ used for linear acceleration/deceleration or bell-shaped acceleration/deceleration in rapid traverse for each axis

[Data type] Word axis
 [Unit of data] ms
 [Valid data range] 0 to 4000
 Specify a time constant used for acceleration/deceleration in rapid traverse for each axis.
 (1) When bell-shaped acceleration/deceleration is set
 Set time constant T₁ for bell-shaped acceleration/deceleration in this parameter, and set time constant T₂ in parameter No. 1621.
 (2) When linear acceleration/deceleration is set
 Set time constant T for linear acceleration/deceleration in this parameter, and set 0 in parameter No. 1621.

NOTE

- 1 When parameter No.1621 (time constant T₂ used for bell-shaped acceleration/deceleration in rapid traverse) is set to 0, linear acceleration/deceleration is applied in rapid traverse even if the function is provided. In this case, this parameter stands for a time constant used in linear acceleration/deceleration in rapid traverse.
- 2 Depending on the set time constant values, a movement may be made at a feedrate a little lower than the rapid traverse rate for a certain time before the rapid traverse rate is attained by acceleration. To prevent this, set the time constants to a multiple of 8.

<Rapid traverse linear acceleration/deceleration>

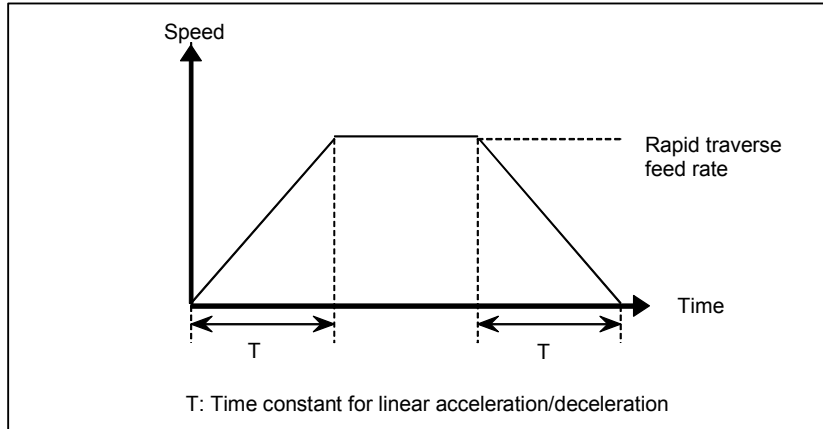

<Rapid traverse bell shaped acceleration/deceleration>

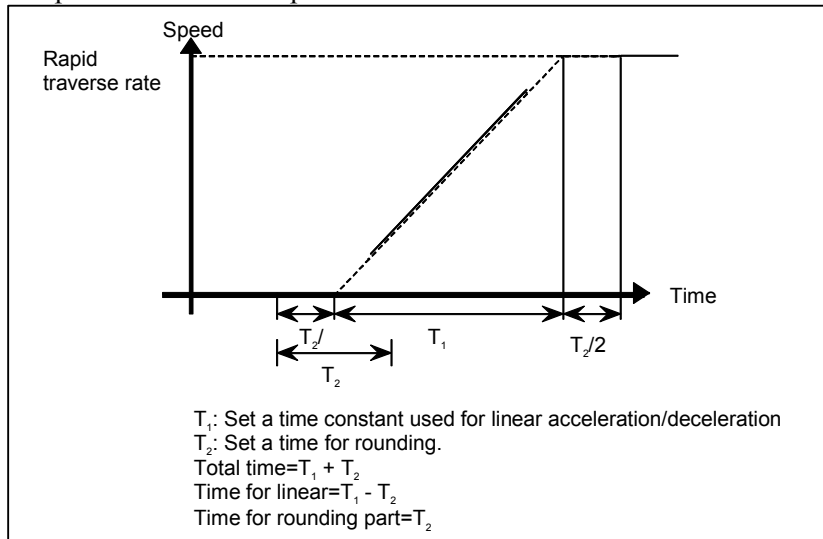

Set the value when the rapid traverse rate is 100%. If it is under 100%, the total time is reduced. (Constant acceleration method)

The value of T_1 is determined from the torque of motor. Usually set the value of T_2 to 24 ms or 32 ms.

1621	Time constant t T_2 used for bell-shaped acceleration/deceleration in rapid traverse for each axis
------	--

[Data type] Word axis
 [Unit of data] ms
 [Valid data range] 0 to 512
 Specify time constant T_2 used for bell-shaped acceleration/deceleration in rapid traverse for each axis.

NOTE

- 1 Set parameter No.1620 to time constant T_1 used for bell-shaped acceleration/deceleration in rapid traverse, and set this parameter to time constant T_2 .
For details of time constants T_1 and T_2 , see the description of parameter No.1620.
- 2 When this parameter is set to 0, linear acceleration/deceleration is applied in rapid traverse. The setting in parameter No.1620 is used as a time constant in linear acceleration/deceleration.

1622

Time constant of exponential acceleration/deceleration or bell-shaped acceleration/deceleration after interpolation, or linear acceleration/deceleration after interpolation in cutting feed for each axis

[Data type]
[Unit of data]
[Valid data range]

Word axis
ms
0 to 4000 (exponential acceleration/deceleration in cutting feed)
0 to 512 (linear or bell-shaped acceleration/deceleration after interpolation in cutting feed)
Set the time constant used for exponential acceleration/deceleration in cutting feed, bell-shaped acceleration/deceleration after interpolation or linear acceleration/deceleration after interpolation in cutting feed for each axis. Except for special applications, the same time constant must be set for all axes in this parameter. If the time constants set for the axes differ from each other, proper straight lines and arcs cannot be obtained.
This parameter is valid for threading, irrespective of the acceleration/deceleration type. For threading cycles G76 and G92 (G78 in the G code system B or C), this parameter is valid for operations other than exponential acceleration/deceleration. (T series)

Bell-shaped acceleration/deceleration after cutting feed interpolation

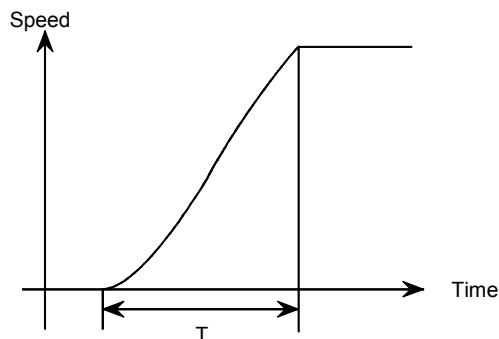

T : Total time. it is constant irrespective of feed rate.
(Time constant is constant).

The curve corresponds to that $T_1 = T/2$ and $T_2 = T/2$ set in parameter No.1620 and 1621.

1623 **FL rate of exponential acceleration/deceleration in cutting feed for each axis**

[Data type]
[Unit of data, valid data range]

Word axis

Increment system	Unit of data	Valid data range	
		IS-A, IS-B	IS-C
Millimeter machine	1 mm/min	0, 6 to 15000	0, 6 to 12000
Inch machine	0.1 inch/min	0, 6 to 6000	0, 6 to 4800
Rotation axis	1 deg/min	0, 6 to 15000	0, 6 to 12000

Set the lower limit (FL rate) of exponential acceleration/deceleration in cutting feed for each axis.

NOTE
Except for special applications, this parameter must be set to 0 for all axes. If a value other than 0 is specified, proper straight lines and arcs cannot be obtained.

1624 **Time constant of exponential acceleration/deceleration or bell-shaped acceleration/deceleration or linear acceleration/deceleration after interpolation, in jog feed for each axis.**

[Data type]
[Unit of data]
[Valid data range]

Word axis
ms

0 to 4000 (exponential acceleration/deceleration in jog feed)
0 to 512 (linear or bell-shaped acceleration/deceleration after interpolation in jog feed)
Set the time constant used for exponential acceleration/deceleration, bell-shaped acceleration/deceleration or linear acceleration/deceleration after interpolation in jog feed for each axis. The type to select depends on the settings of the parameters CTLx, CTBx, and JGLx (Nos. 1610#0, #1, and #4).

1625 **FL rate of exponential acceleration/deceleration in jog feed for each axis.**

[Data type]
[Unit of data, valid data range]

Word axis

Increment system	Unit of data	Valid data range	
		IS-A, IS-B	IS-C
Millimeter machine	1 mm/min	6 to 15000	6 to 12000
Inch machine	0.1 inch/min	6 to 6000	6 to 4800
Rotation axis	1 deg/min	6 to 15000	6 to 12000

Set the lower limit (FL rate) of exponential acceleration/deceleration in cutting feed for each axis.

1626 **Time constant of exponential acceleration/deceleration in the thread cutting cycle for each axis**

[Data type] Word axis
 [Unit of data] ms
 [Valid data range] 0 to 4000
 Set the time constant used for exponential acceleration/deceleration in the thread cutting cycle (G76, G78 (G92 in G code system A)) for each axis.
 If the acceleration type is not exponential acceleration/deceleration, parameter No. 1622 becomes valid.

1627	FL rate of exponential acceleration /deceleration in the thread cutting cycle for each axis

[Data type] Word axis
 [Unit of data, valid data range]

Increment system	Unit of data	Valid data range	
		IS-A, IS-B	IS-C
Millimeter machine	1 mm/min	6 to 15000	6 to 12000
Inch machine	0.1 inch/min	6 to 6000	6 to 4800

Set the lower limit (FL rate) of exponential acceleration/deceleration in the thread cutting cycle (G76, G78 (G92 in G code system A)) for each axis.

1710	Minimum deceleration ratio (MDR) of the inner circular cutting rate in automatic corner override
------	---

[Data type]
[Unit of data]
[Valid data range]

Byte
%
1 to 100

This parameter sets the minimum deceleration ratio (MDR) when the inner circular cutting speed is changed by automatic corner override. In circular cutting with an inward offset, the actual feedrate for a specified feedrate (F) is expressed as follows:

$$F \times \frac{Rc}{Rp}$$

Rc: Radius of the path of the cutter's center.
Rp: Programmed radius

Then, the actual feedrate is controlled so that the feedrate on the programmed path can achieve the specified feedrate F.

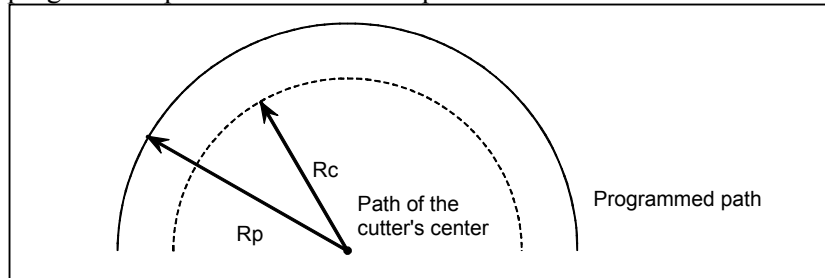

Fig. 4.17 (a) Rp and Rc

If Rc is too small in comparison with Rp, such that $Rc/Rp \rightarrow 0$, the cutter will stop. To prevent this, a minimum deceleration ratio (MDR) is set.

1711	Angle (θp) used to recognize an inner corner in inner corner override
------	--

[Data type]
[Unit of data]
[Valid data range]

Byte
Degree
1 to 179 (standard value = 91)

This parameter sets the angle used to recognize an inner corner for inner corner override by automatic corner override.

1712	Amount of override for an inner corner
------	---

[Data type]
[Unit of data]
[Valid data range]

Byte
%
1 to 100 (standard value = 50)
Set the amount of override for an inner corner.

1713	
	Distance Le from the starting point in inner corner override

[Data type] 2-word
 [Unit of data]

Increment system	IS-A	IS-B	IS-C	Unit
Millimeter input	1	0.1	0.01	mm
Inch input	0.1	0.01	0.001	inch

[Valid data range] 0 to 3999
 Set distance Le from the starting point in an inner corner for corner override.

1714	
	Distance Ls up to the ending point in inner corner override

[Data type] 2-word
 [Unit of data]

Increment system	IS-A	IS-B	IS-C	Unit
Millimeter input	1	0.1	0.01	mm
Inch input	0.1	0.01	0.001	inch

[Valid data range] 0 to 3999
 Set distance Ls up to the end point in an inner corner for corner override.
 If $\theta \leq \theta_p$, the inside of a corner is recognized. (θ_p is set in parameter 1711.)
 When an inner corner is recognized, the feedrate is overridden in the range of Le in the block immediately before the intersection of the corner and Ls in the next block following the intersection.
 Ls and Le are each a straight line connecting the intersection of the corner and a given point on the path of the cutter's center.
 Ls and Le are set in parameters 1713 and 1714.

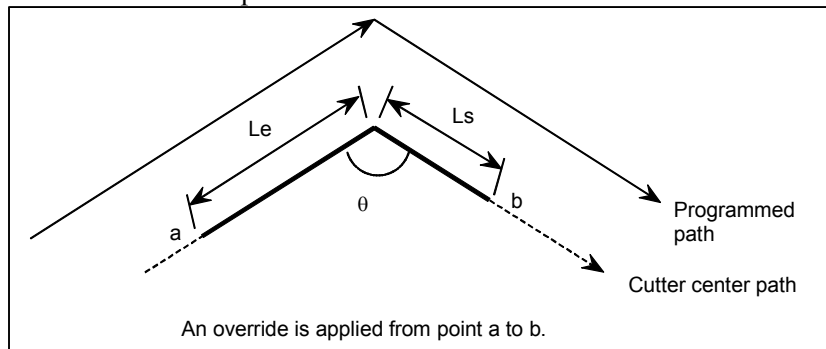

Fig.4.17 (b) Distance Le and Ls in the automatic corner override at an inner corner

1722 **Rapid traverse feedrate reduction ratio for overlapping rapid traverse blocks**

[Data type]
[Unit of data]
[Valid data range]

Byte axis
%
1 to 100

This parameter is used when rapid traverse blocks are arranged successively, or when a rapid traverse block is followed by a block that does not cause movement. When the feedrate for each axis of a block is reduced to the ratio set in this parameter, the execution of the next block is started.

Examples

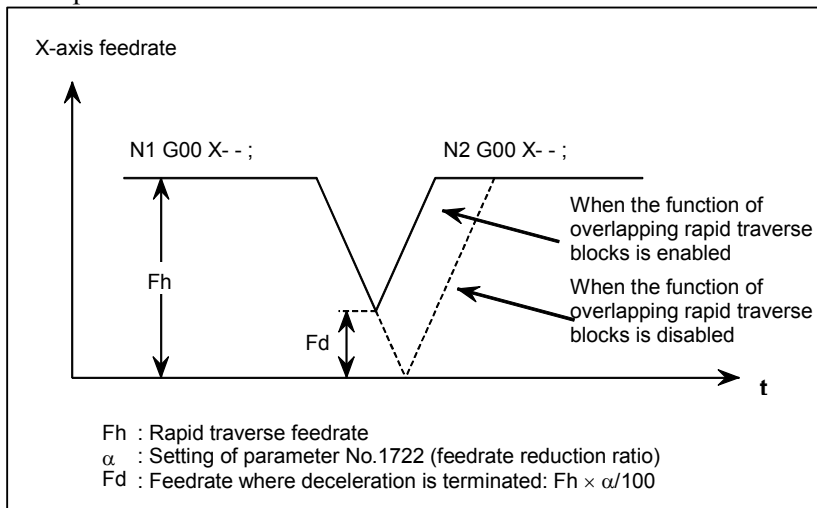

NOTE
The parameter No.1722 is effective when parameter No.1601 #4 (RT0) is set to 1.

1730 **Maximum feedrate for arc radius R**

[Data type]
[Unit of data, valid data range]

Word

Increment system	Unit of data	Valid data range	
		IS-A, IS-B	IS-C
Millimeter machine	1 mm/min	8 to 15000	8 to 12000
Inch machine	0.1 inch/min	8 to 6000	8 to 4800

Set a maximum feedrate for the arc radius set in parameter No.1731.

1731 Arc radius value corresponding to a maximum feedrate

[Data type] 2-word
 [Unit of data]

Increment system	IS-A	IS-B	IS-C	Unit
Linear axis (millimeter machine)	0.01	0.001	0.0001	mm
Linear axis (inch machine)	0.001	0.0001	0.00001	inch

[Valid data range] 1000 to 99999999
 Set the arc radius corresponding to the maximum feedrate set in parameter No.1730.

1732 Minimum value (RV min) for arc radius-based feedrate clamp

[Data type] Word
 [Unit of data, valid data range]

Increment system	Unit of data	Valid data range	
		IS-A, IS-B	IS-C
Millimeter machine	1 mm/min	0 to 15000	0 to 12000
Inch machine	0.1 inch/min	0 to 6000	0 to 4800

The arc radius-based feedrate clamping function reduces the maximum feedrate as the arc radius decreases. When the specified maximum feedrate is not greater than RV min (minimum value for arc radius-based feedrate clamping), RV min is used as the maximum feedrate.

1740 Critical angle subtended by two blocks for automatic corner deceleration

[Data type] 2-word
 [Unit of data] 0.001 deg
 [Valid data range] 0 to 180000

Set a critical angle to be subtended by two blocks for corner deceleration when the angle-based automatic corner deceleration function is used.

The angle subtended by two blocks is defined as θ in the examples shown below.

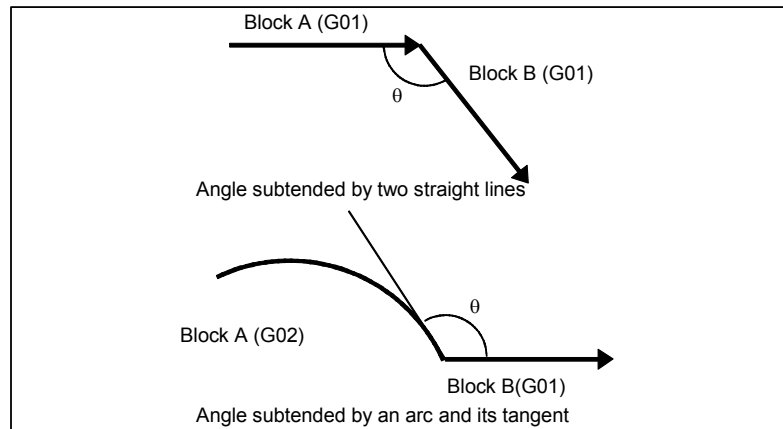

1741	Feedrate
	for assuming the termination of automatic corner deceleration (for acceleration/deceleration after interpolation)

[Data type]
[Unit of data, valid data range]

Word axis

Increment system	Unit of data	Valid data range	
		IS-A, IS-B	IS-C
Millimeter machine	1 mm/min	6 to 15000	6 to 12000
Inch machine	0.1 inch/min	6 to 6000	6 to 4800
Rotation axis	1 deg/min	6 to 15000	6 to 12000

Set the feedrate for assuming the termination of deceleration in automatic corner deceleration.

1762	Exponential acceleration/deceleration time constant for cutting feed in the advanced preview control mode
-------------	--

[Data type]
[Unit of data]
[Valid data range]

Word axis

ms

0 to 4000

Set an exponential acceleration/deceleration time constant for cutting feed in the advanced preview control mode.

1763	Minimum speed in exponential acceleration/deceleration for cutting feed in the advanced preview control mode
-------------	---

[Data type]
[Unit of data, valid data range]

Word axis

Increment system	Unit of data	Valid data range	
		IS-A, IS-B	IS-C
Millimeter machine	1 mm/min	6 to 15000	6 to 12000
Inch machine	0.1 inch/min	6 to 6000	6 to 4800
Rotation axis	1 deg/min	6 to 15000	6 to 12000

Set minimum speed (FL) in exponential acceleration/deceleration for cutting feed in the advanced preview control mode.

1768

Time constant of linear acceleration/deceleration or bell-shaped acceleration/deceleration after interpolation in cutting feed in advanced preview control, AI advanced preview control, or AI contour control mode

[Data type] Word
 [Unit of data] msec
 [Valid data range]

Advanced preview control, AI advanced preview control	0, 8 to 512
AI contour control	0, 4 to 256

Set the time constant to be used for linear or bell-shaped acceleration/deceleration after interpolation in cutting feed in advanced preview control, AI advanced preview control, or AI contour control mode.

NOTE

For bell-shaped acceleration/deceleration, the function of bell-shaped acceleration/deceleration after cutting feed interpolation is required.

1769

Time constant of linear acceleration/deceleration or bell-shaped acceleration/deceleration after interpolation in cutting feed for each axis in advanced preview control, AI advanced preview control, or AI contour control mode

[Data type] Word axis
 [Unit of data] msec
 [Valid data range]

Advanced preview control, AI advanced prevoew control	0, 8 to 512
AI contour control	0, 4 to 256

Set the time constant to be used for linear or bell-shaped acceleration/deceleration after interpolation in cutting feed in advanced preview control, AI advanced preview control, or AI contour control mode for each axis. Which acceleration/deceleration type, the linear or bell-shaped type, is to be used is specified by bit 3 (BS2) and bit 6 (LS2) of parameter No. 1602.

NOTE

- 1 If 0 is set in parameter No. 1769 for all axes, the value set in parameter No. 1768 is used. For other than special purposes, set a time constant in parameter No. 1768, which is common to all axes.
- 2 If a different time constant is set in parameter No. 1769, a correct straight line or arc shape cannot be obtained.

1770

Parameter 1 for setting the acceleration rate of linear acceleration/deceleration before interpolation in advanced preview control, AI advanced preview control, or AI contour control mode (maximum machining speed during linear acceleration/deceleration before interpolation)

[Data type] 2-word
 [Unit of data, valid data range]

Increment system	Unit of data	Valid data range	
		IS-A, IS-B	IS-C
Millimeter machine	1 mm/min	6 to 240000	6 to 100000
Inch machine	0.1 inch/min	6 to 96000	6 to 48000

This parameter is used to set the acceleration rate of linear acceleration/deceleration before interpolation in advanced preview control, AI advanced preview control, or AI contour control mode. In this parameter, set the maximum machining speed during linear acceleration/deceleration before interpolation. Set the time used to reach the maximum machining speed in parameter No.1771.

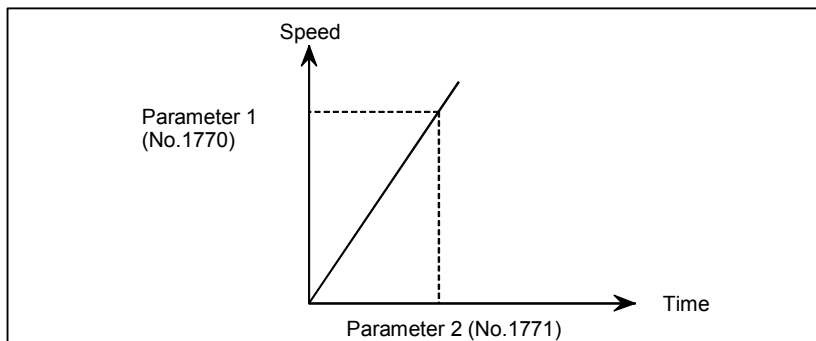

NOTE
 When 0 is set in parameter No.1770 or parameter No.1771, linear acceleration/deceleration before interpolation is disabled.

1771

Parameter 2 for setting the acceleration rate of linear acceleration/deceleration before interpolation in advanced preview control, AI advanced preview control, or AI contour control mode (time until the maximum machining speed is reached during linear acceleration/deceleration before interpolation)

[Data type] Word
 [Unit of data] msec
 [Valid range] 0 to 4000

This parameter is used to set the acceleration rate of linear acceleration/deceleration before interpolation in advanced preview control, AI advanced preview control, or AI contour control mode. In this parameter, set the maximum machining speed during linear acceleration/deceleration before interpolation. In this parameter, set the time (time constant) used to reach the speed set in parameter No.1770.

NOTE

- 1 When 0 is set in parameter No.1770 or parameter No.1771, linear acceleration/deceleration before interpolation is disabled.
- 2 In parameter Nos. 1770 and 1771, set values that satisfy the following:
Parameter No.1770/Parameter No.1771 ≥ 5
- 3 If 0 is set in parameter No. 1770 or 1771 in AI advanced preview control or AI contour control, P/S alarm 5157 is issued.

1772

Time constant for bell-shaped acceleration/deceleration of acceleration time fixed type before look-ahead interpolation

[Data type] Byte
 [Unit of data] msec
 [Valid data range] 0 to 255

This parameter is used to set a time constant when the BEL parameter (bit 7 of parameter No.1603) is set to 1, that is, when bell-shaped acceleration/deceleration before look-ahead interpolation is selected in AI contour control mode. Set the value of t_b as shown below. When 0 is set, linear acceleration/deceleration before interpolation is applied.

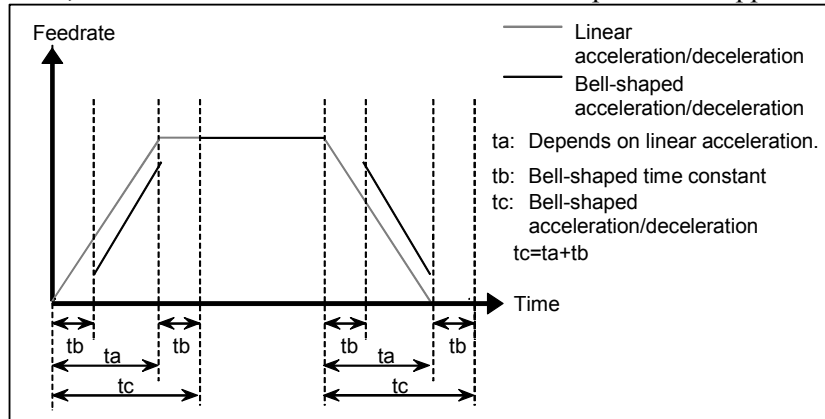

NOTE

The option for bell-shaped acceleration/deceleration before look-ahead interpolation is required. This parameter is enabled only in AI contour control mode.

1773	Time constant T of rapid traverse linear acceleration/deceleration for each axis or time constant T₁ of rapid traverse bell-shaped acceleration/deceleration for each axis in AI contour control mode
------	---

[Data type] Word axis
 [Unit of data] msec
 [Valid data range] 0 to 4000

Set the time constant of rapid traverse acceleration/deceleration in AI contour control mode.

(1) When bit 6 (RBL) of parameter No. 1603 is set to 1 (when bell-shaped acceleration/deceleration is set)
 Set time constant T₁ of bell-shaped acceleration/deceleration in this parameter, and set time constant T₂ in parameter No. 1774.

(2) When bit 6 (RBL) of parameter No. 1603 is set to 0 (when linear acceleration/deceleration is set)
 Set time constant T of linear acceleration/deceleration in this parameter, and set 0 in parameter No. 1774.

For an axis for which 0 is set in this parameter, the value set in parameter No. 1620 is used.

NOTE
 In advanced preview control and AI advanced preview control modes, parameter No. 1773 cannot be used.

1774	Time constant T₂ of rapid traverse bell-shaped acceleration/deceleration for each axis in AI contour control mode
------	---

[Data type] Word axis
 [Unit of data] msec
 [Valid data range] 0 to 512

For each axis, set time constant T₂ of rapid traverse bell-shaped acceleration/deceleration in AI contour control mode. For an axis for which 0 is set in this parameter, the value set in parameter No. 1621 is used.

NOTE

- 1 In advanced preview control and AI advanced preview control modes, parameter No. 1774 cannot be used.
- 2 To perform bell-shaped acceleration/deceleration, set the following parameter:
AI advanced preview control and AI contour control: Bit 6 (RBL) of parameter No. 1603 = 1
- 3 When acceleration/deceleration before interpolation is set for rapid traverse, linear interpolation type positioning is performed.
When the following parameters are set, acceleration/deceleration before interpolation is performed:
AI advanced preview control and AI contour control: Bit 1 (AIR) of parameter No. 7054 = 0
Alternatively, bit 1 (LRP) of parameter No. 1401 = 1 and bit 1 (AIR) of parameter No.7054 = 1

1775	(Must not be used)*(Always set 0.)
1776	(Must not be used)*(Always set 0.)
1777	Minimum speed for the automatic corner deceleration function (for advanced preview control, AI advanced preview control, or AI contour control)

[Data type] Word
 [Unit of data, valid data range]

Increment system	Unit of data	Valid data range	
		IS-A, IS-B	IS-C
Millimeter machine	1 mm/min	6 to 15000	6 to 12000
Inch machine	0.1 inch/min	6 to 6000	6 to 4800

Set a speed at which the number of buffered pulses in deceleration is assumed to be 0 when linear acceleration/deceleration before interpolation is used.

1779	Critical angle subtended by two blocks for automatic corner deceleration (for advanced preview control, AI advanced preview control, or AI contour control)
------	---

[Data type] 2-word
 [Unit of data] 0.001 deg
 [Valid data range] 0 to 180000

Set a critical angle to be subtended by two blocks for corner deceleration when the angle-based automatic corner deceleration function is used.

The angle subtended by two blocks is defined as q in the examples shown below.

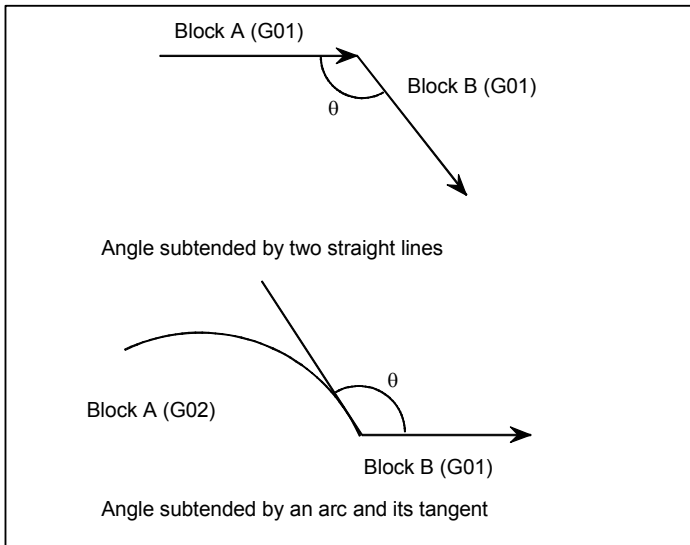

1780

Allowable speed difference for the speed difference-based corner deceleration function (for linear acceleration/deceleration before interpolation)

[Data type]
[Unit of data, valid data range]

Word

Increment system	Unit of data	Valid data range	
		IS-A, IS-B	IS-C
Millimeter machine	1 mm/min	6 to 15000	6 to 12000
Inch machine	0.1 inch/min	6 to 6000	6 to 4800

Set the speed difference for the speed difference-based automatic corner deceleration function when linear acceleration/deceleration before interpolation is used.

1781

Allowable speed difference for the speed difference-based corner deceleration function (linear acceleration/deceleration after interpolation)

[Data type]
[Unit of data, valid data range]

Word axis

Increment system	Unit of data	Valid data range	
		IS-A, IS-B	IS-C
Millimeter machine	1 mm/min	6 to 15000	6 to 12000
Inch machine	0.1 inch/min	6 to 6000	6 to 4800
Rotation axis	1 deg/min	6 to 15000	6 to 12000

Set speed difference for the speed difference-based automatic corner deceleration function when linear acceleration/deceleration after interpolation used.

1783

Allowable speed difference for the speed difference based corner deceleration function (linear acceleration/deceleration before interpolation)

[Data type]
[Unit of data, valid data range]

Word axis

Increment system	Unit of data	Valid data range	
		IS-A, IS-B	IS-C
Millimeter machine	1 mm/min	6 to 15000	6 to 12000
Inch machine	0.1 inch/min	6 to 6000	6 to 4800
Rotation axis	1 deg/min	6 to 15000	6 to 12000

A separate allowable feedrate difference can be set for each axis. The allowable feedrate difference is set for each axis with this parameter. Among the axes that exceed the specified allowable feedrate difference, the axis with the greatest ratio of the actual feedrate difference to the allowable feedrate difference is used as the reference to calculate the reduced feedrate at the corner.

1784

Speed when overtravel alarm has generated during acceleration/deceleration before interpolation

[Data type]
[Unit of data, valid data range]

Word

Increment system	Unit of data	Valid data range	
		IS-A, IS-B	IS-C
Millimeter machine	1 mm/min	6 to 15000	6 to 12000
Inch machine	0.1 inch/min	6 to 6000	6 to 4800
Rotation axis	1 deg/min	6 to 15000	6 to 12000

Deceleration is started beforehand to reach the feedrate set in the parameter when an overtravel alarm is issued (when a limit is reached) during linear acceleration/deceleration before interpolation. By using this parameter, the overrun distance that occurs when an overtravel alarm is output can be reduced.

This setting can be applied also to rapid traverse blocks by setting bit 0 (OTR) of parameter No.7057. (M series)

NOTE

- 1 When 0 is set in this parameter, the control described above is not exercised.
- 2 Use type-B linear acceleration/deceleration before interpolation (by setting bit 0 (FWB) of parameter No.1602 to 1).
- 3 The control described above is applicable only to stored stroke check 1.
- 4 The control described above is performed for the axes specified in the current block and next block. By setting bit 5 (ODA) of parameter No. 7055, the control can be performed just for the axis specified in the current block.

1785	Parameter for determining an allowable acceleration when the feedrate is set by acceleration
-------------	---

[Data type] Word axis
 [Unit of data] ms
 [Valid data range] 0 to 32767

This parameter sets the time required to attain the maximum cutting feedrate to determine the allowable acceleration when the feedrate is determined by acceleration in AI advanced preview control mode or AI contour control mode.

The maximum cutting feedrate and the data set in this parameter are used to determine the allowable acceleration. As the maximum cutting feedrate parameter, parameter No.1432 (maximum cutting feedrate in AI advanced preview control mode or AI contour control mode) is used.

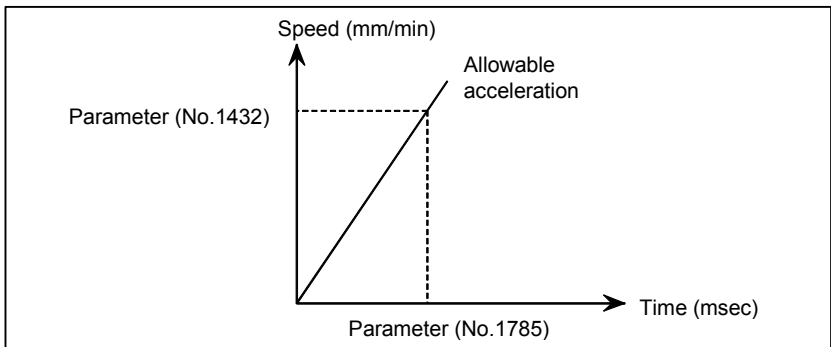

1786	Time (time constant) until the maximum machining speed is reached during linear acceleration/deceleration before interpolation in advanced preview control, AI advanced preview control, or AI contour control mode (for rotation axes)
-------------	--

[Data type] Word
 [Unit of data] msec
 [Valid data range] 0 to 4000

This parameter is used to set the acceleration rate (for rotation axes) of linear acceleration/deceleration before interpolation in advanced preview control, AI advanced preview control, or AI contour control mode.

This parameter sets the time (time constant) required to reach the speed set in parameter No. 1770. The acceleration rate set by this parameter applies to commands containing rotation axes. (The acceleration rate set by parameter No. 1771 applies to commands not containing rotation axes.)

<p>NOTE If 0 is set in this parameter, the acceleration rate set in parameter No. 1771 applies also to commands containing rotation axes.</p>

1787	Time constant of bell-shaped acceleration/deceleration of acceleration time fixed type before look-ahead interpolation in the AI advanced preview control or AI contour control mode (for rotation axes)
------	---

[Data type] Byte
 [Unit of data] msec
 [Valid data range] 0 to 255

This parameter sets the time constant (for rotation axes) when bell-shaped acceleration/deceleration before look-ahead interpolation is selected as the acceleration/deceleration applied in AI advanced preview control or AI contour control mode.

The time constant set in this parameter applies to commands containing rotation axes. (The time constant set in parameter No. 1772 applies to commands not containing rotation axes.)

NOTE

- 1 The option for bell-shaped acceleration/deceleration before look-ahead interpolation is required.
- 2 This parameter is valid only when a non-zero value is set in parameter No. 1786.

4.15 PARAMETERS OF SERVO (1 OF 2)

	#7	#6	#5	#4	#3	#2	#1	#0
1800				RBK	FFR	OZR	CVR	

- [Data type] Bit
- CVR When velocity control ready signal VRDY is set ON before position control ready signal PRDY comes ON
 0: A servo alarm is generated.
 1: A servo alarm is not generated.
- OZR When manual reference position return is attempted in the halt state during automatic operation (feed hold stop state) under any of the conditions listed below:
 0: Manual reference position return is not performed, with P/S alarm No.091.
 1: Manual reference position return is performed without an alarm occurring.
 <Conditions>
 (1) When there is a remaining distance to travel.
 (2) When an auxiliary function (miscellaneous function, spindle-speed function, tool function) is being executed.
 (3) When a cycle such as a dwell cycle or canned cycle is being executed.
- FFR Feed-forward control is enabled for
 0 : Cutting feed only
 1 : Cutting feed and rapid traverse
- RBK Backlash compensation applied separately for cutting feed and rapid traverse
 0: Not performed
 1: Performed

	#7	#6	#5	#4	#3	#2	#1	#0
1801			CIN	CCI			PM2	PM1
			CIN	CCI				

- [Data type] Bit
- PM1, PM2 Sets a gear ratio between the spindle and motor when the servo motor-based speed control function is used.

Magnification	PM2	PM1
1/1	0	0
1/2	0	1
1/4	1	0
1/8	1	1

Magnification=
spindle speed / motor speed

- CCI The in-position area for cutting feed is:
 0 : Set in parameter No.1826 (same as for rapid traverse).
 1 : Set in bit 5 (CIN) of parameter No.1801.

- CIN When bit 4 (CCI) of parameter No.1801 = 1, the in-position area for cutting feed is:
 0 : Use value in parameter No.1827 if the next block is also for cutting feed, or use value in parameter No.1826 if the next block is not for cutting feed.
 1 : Use value in parameter No.1827, regardless of the next block. (The setting of parameter No.1826 is used for rapid traverse, and the setting of parameter No.1827 is used for cutting feed.)

1802	#7	#6	#5	#4	#3	#2	#1	#0
			DPS	B15		DC2	DC4	CTS
	FWC			B15		DC2	DC4	

NOTE
 After this parameter is set, the power needs to be turned off.

- [Data type] Bit
- CTS The servo motor-based speed control function is:
 0 : Not used
 1 : Used
- DC4 The reference position on an encoder (linear scale or rotary encoder) with absolute address reference marks is established as follows:
 0 : An absolute position is established by detecting three reference marks.
 1 : An absolute position is established by detecting four reference marks.

NOTE
 With an encoder with the absolute address zero point (linear scale or rotary encoder) (detection circuit C), the setting of this parameter is invalid.

- DC2 The reference position on the linear scale with absolute address reference mark is established:
 0: As determined by bit 1 (DC4) of parameter No. 1802.
 1: By establishing the absolute position through detection of two reference marks.

NOTE

- 1 When this parameter is set to 1, set the direction of the zero point of the encoder with bit 4 (SCPx) of parameter No. 1817.
- 2 When a rotary encoder with absolute address reference marks is used (bit 3 (DCRx) of parameter No. 1815 = 1), this parameter becomes invalid. Even if this parameter is set to 1, the setting of the DC4 parameter is followed.
- 3 With an encoder with the absolute address zero point (linear scale or rotary encoder) (detection circuit C), the setting of this parameter is invalid.

- B15 In backlash compensation, the travel direction is determined:
 0: Without consideration of the compensation amount (pitch error, external machine coordinate shift, etc.).
 1: In consideration of the compensation amount. (FS15 format)
- DPS When servo motor-based speed control is applied, a position coder is:
 0: Used
 1: Not used
- FWC The processing of command multiplication (CMR) is performed:
 0: After acceleration/deceleration after interpolation.
 1: Before acceleration/deceleration after interpolation.

	#7	#6	#5	#4	#3	#2	#1	#0
1803				TQF			TQA	TQI

- [Data type] Bit
- TQI While torque restriction is applied, in-position check is:
 0: Performed.
 1: Not performed.
 - TQA While torque restriction is applied, checking for an excessive error in the stopped state/during movement is:
 0: Performed.
 1: Not performed.
 - TQF When torque control is performed by an axis control command of the PMC axis control function, follow-up operation is:
 0: Not performed.
 1: Performed.

	#7	#6	#5	#4	#3	#2	#1	#0
1804		SAK	ANA	IVO				

- [Data type] Bit axis
- IVO When an attempt is made to release an emergency stop while the VRDY OFF alarm ignore signal is 1:
 0: The emergency stop state is not released until the VRDY OFF alarm ignore signal is set to 0.
 1: The emergency stop state is released.

NOTE
 When a reset is issued while the VRDY OFF alarm ignore signal is set to 1 and the motor activating current is low, the reset state can also be released, provided this parameter is set to 1.

- ANA When an abnormal load is detected for an axis:
 0 : Movement along all axes is stopped, and a servo alarm is output.
 1 : No servo alarm is output, and movement along only the axes of the group containing the axis with the abnormal load is stopped in interlock mode. (The group number of each axis is set in parameter No.1881.)
- SAK When the VRDY OFF alarm ignore signal IGNVRY is 1, or when the VRDY OFF alarm ignore signals IGVR1 to IGVR8 are 1:
 0 : Servo ready signal SA is set to 0.
 1 : Servo ready signal SA remains set to 1.

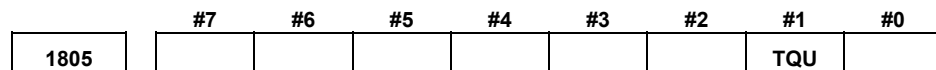

- [Data type] Bit
 TQU If follow-up is not performed by the torque control command of PMC axis control, the servo error counter is:
 0: Updated.
 1: Not updated.

NOTE
 1 This parameter is valid if follow-up is not performed (bit 4 (TQF) of parameter No. 1803 is set to 0).
 2 When torque control is switched to position control, a reference position return must be made.

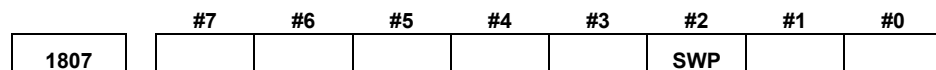

- [Data type] Bit
 SWP When the α i servo amplifier is placed in the warning state (for a cause such as a stopped fan):
 0 : An alarm is issued.
 Automatic operation enters the feed hold state, and the servo axis decelerates and stops.
 1 : No alarm is issued.
 Automatic operation continues. When the amplifier state changes from the warning state to alarm state, servo activation stops.

1815	#7	#6	#5	#4	#3	#2	#1	#0
	NRTx	APCx	APZx	DCRx	DCLx	OPTx		
	NRTx	APCx	APZx	DCRx	DCLx	OPTx	RVSx	

NOTE
 When this parameter has been set, the power must be turned off before operation is continued.

[Data type] Bit axis
 RVSx When rotation axis B type is set for an axis for which a scale not having speed data is used:
 0 : The NC does not maintain speed data.
 1 : The NC maintains speed data.

NOTE

- 1 For axes that are of rotation axis B type and have a movable range of one turn or more, use of a scale having speed data is recommended.
- 2 This parameter is valid only for axes of rotation axis B type.
- 3 The NC maintains speed data observed immediately before power-off and uses the data to obtain coordinates at the next power-on. Therefore, if an axis turns 180 degrees or more while the power is off, the coordinate value may be displaced by one turn or more.
- 4 When you have changed this parameter, establish the reference position again.

OPTx Position detector
 0 : A separate Pulsecoder is not used.
 1 : A separate Pulsecoder is used.
 For an absolute-position system using Inductosyn, set this parameter to 1.

DCLx As a separate position detector:
 0 : Neither an encoder with absolute address reference marks (linear scale or rotary encoder) nor encoder with the absolute address zero point (linear scale or rotary encoder) (detection circuit C) is used.
 1 : An encoder with absolute address reference marks (linear scale or rotary encoder) or encoder with the absolute address zero point (linear scale or rotary encoder) (detection circuit C) is used.

NOTE

When an encoder with absolute address reference marks (linear scale or rotary encoder) or encoder with the absolute address zero point (linear scale or rotary encoder) (detection circuit C) (closed loop system) is used, set bit 1 (OPTx) of parameter No. 1815 to 1. When a linear scale with the absolute address zero point (detection circuit C) (linear motor system) is used, however, set OPTx to 0.

- DCRx As an encoder with absolute address reference marks:
 0 : A linear scale with absolute address reference marks is used.
 1 : A rotary encoder with absolute address reference marks is used.

NOTE

- 1 Set bit 2 (DCLx) of parameter No. 1815 to 1.
- 2 When a rotary encoder with the absolute address zero point (detection circuit C) is used, set this parameter to 0.

- APZx Machine position and position on absolute position detector when the absolute position detector is used
 0 : Not corresponding
 1 : Corresponding

NOTE

When an absolute position detector is used, after primary adjustment is performed or after the absolute position detector is replaced, this parameter must be set to 0, power must be turned off and on, then manual reference position return must be performed. This completes the positional correspondence between the machine position and the position on the absolute position detector, and sets this parameter to 1 automatically.

- APCx Position detector
 0 : Other than absolute position detector
 1 : Absolute position detector (absolute Pulsecoder)
 For an absolute-position system using Inductosyn, set this parameter to 1.
- NRTx When the machine coordinate value on a rotation axis passes the 0-degree point or a point at which the machine coordinate value is rounded off (360 degrees or the setting of parameter No. 1260):
 0 : The zero point (parameter Nos. 1860 and 1861) is updated.
 1 : The zero point (parameter Nos. 1860 and 1861) is not updated.
 When a scale not maintaining speed data is used, set this parameter to 1.

NOTE

- 1 This parameter is valid only for axes of rotation axis A type.
- 2 For axes of rotation axis A type that use a scale having no speed data, be sure to set this parameter.
- 3 When you have changed this parameter, establish the reference position again.

	#7	#6	#5	#4	#3	#2	#1	#0
1817		TANx		SCPx				
		TANx		SCPx	SCRx			

NOTE

When this parameter has been set, the power must be turned off before operation is continued.

[Data type] Bit axis
 SCRx When rotation axis B type is set for an axis for which a scale not having speed data is used, scale data conversion is:
 0 : Not performed.
 1 : Performed.

NOTE

- 1 This parameter is valid only for axes of rotation axis B type.
- 2 When there is no discontinuous point in scale data within the movable range of a rotation axis, do not set this parameter for the axis even if the axis is of rotation axis B type.
- 3 When you have changed this parameter, establish the reference position again.

SCPx When bit 2 (DC2) of parameter No. 1802 is set to 1, the zero point of an encoder with absolute address reference marks (linear scale or rotary encoder) is located:
 0 : On the negative side.
 (The reference position is located on the positive side when viewed from the encoder zero point.)
 1 : On the positive side.
 (The reference position is located on the negative side when viewed from the encoder zero point.)

NOTE

- 1 If an incorrect value is set in this parameter, the coordinate system cannot be established properly. In this case, reverse the setting, and establish the reference position again.
- 2 For an encoder with the absolute address zero point (linear scale or rotary encoder) (detection circuit C), the setting of this parameter is invalid.

TANx Tandem control
 0 : Not used
 1 : Used

NOTE
 Set this parameter to both master axis and slave axis.

	#7	#6	#5	#4	#3	#2	#1	#0
1818					SDCx	DG0x	RF2x	RFSx

[Data type] Bit axis type

RFSx When the reference position has not yet been established on an axis for which an encoder with absolute address reference marks (linear scale or rotary encoder) or encoder with the absolute address zero point (linear scale or rotary encoder) (detection circuit C) is used, an automatic reference position return (G28) causes the following behavior after the reference position is established:
 0: A movement to the reference position is made.
 1: A movement to the reference position is not made, but the operation is completed.

RF2x When the reference position has already been established on an axis for which an encoder with absolute address reference marks (linear scale or rotary encoder) or encoder with the absolute address zero point (linear scale or rotary encoder) (detection circuit C) is used, an automatic reference position return (G28) causes the following behavior:
 0: A movement to the reference position is made.
 1: A movement to the reference position is not made, but the operation is completed.

DG0x For an axis for which an encoder with absolute address reference marks (linear scale or rotary encoder) is used, a reference position return operation by a rapid traverse command or jog feed is:
 0: Disabled.
 1: Enabled.

SDCx An encoder with the absolute address zero point (linear scale or rotary encoder) (detection circuit C) is:
 0 : Not used.
 1 : Used.

NOTE
 After setting this parameter, be sure to turn off the power. Note that P/S 0 (power-off request alarm) is not issued.

	#7	#6	#5	#4	#3	#2	#1	#0
1819						DATx	CRFx	FUPx
	NAHx					DATx	CRFx	FUPx

[Data type] Bit axis
 FUPx To perform follow-up when the servo is off is set for each axis.
 0: The follow-up signal, *FLWU, determines whether follow-up is performed or not.
 When *FLWU is 0, follow-up is performed.
 When *FLWU is 1, follow-up is not performed.
 1: Follow-up is not performed.

NOTE
 When the index table indexing function (M series) is used, be sure to set FUPx of the 4th axis to 1.

CRFx When servo alarm No.445 (software disconnection), No.446 (hardware disconnection), No.447 (hardware disconnection (separate type)), or No.421 (excessive dual position feedback error) is issued:
 0 : The reference position setting remains as is.
 1 : The system enters the reference position undefined state.

DATx With an encoder with absolute address reference marks (linear scale or rotary encoder) or encoder with the absolute address zero point (linear scale or rotary encode), automatic setting of parameter Nos. 1883 and 1884 at the time of a manual reference position return operation is:
 0: Not performed.
 1: Performed.
 The automatic setting is performed according to the following steps:
 <1> Set appropriate values in parameter Nos. 1815, 1821, and 1882.
 * For an encoder with the absolute address zero point (linear scale or rotary encoder) (detection circuit C), parameter No. 1882 need not be set.
 <2> By manual operation, position the machine at the reference position.
 <3> Set this parameter to 1.
 <4> Perform a manual reference position return operation. Upon completion of the manual reference position return operation, parameter Nos.1883 and 1884 are set, and this parameter is automatically set to 0.

NAHx In the advanced preview control mode, advanced feed-forward is:
 0 : Used
 1 : Not used

NOTE
 Set 1 for a PMC-based control axis.

1820

Command multiplier for each axis (CMR)

NOTE

When this parameter has been set, the power must be turned off before operation is continued.

[Data type] Byte axis

Set a command multiplier indicating the ratio of the least command increment to the detection unit for each axis.

Least command increment = detection unit × command multiplier

Relationship between the increment system and the least command increment

(1) T series

			Least input increment	Least command increment
IS-B	Millimeter machine	Millimeter input	0.001 mm (diameter specification)	0.0005 mm
			0.001 mm (radius specification)	0.001 mm
		Inch input	0.0001 inch (diameter specification)	0.0005 mm
			0.0001 inch (radius specification)	0.001 mm
	Inch machine	Millimeter input	0.001 mm (diameter specification)	0.00005 inch
			0.001 mm (radius specification)	0.0001 inch
		Inch input	0.0001 inch (diameter specification)	0.00005 inch
0.0001 inch (radius specification)	0.0001 inch			
Rotation axis			0.001 deg	0.001 deg
IS-C	Millimeter machine	Millimeter input	0.0001 mm (diameter specification)	0.00005 mm
			0.0001 mm (radius specification)	0.0001 mm
		Inch input	0.00001 inch (diameter specification)	0.00005 mm
			0.00001 inch (radius specification)	0.0001 mm
	Inch machine	Millimeter input	0.0001 mm (diameter specification)	0.000005 inch
			0.0001 mm (radius specification)	0.00001 inch
		Inch input	0.00001 inch (diameter specification)	0.000005 inch
			0.00001 inch (radius specification)	0.00001 inch
Rotation axis			0.0001 deg	0.0001 deg

(2) M series

Increment system	Least input increment and least command increment			
	IS-A	IS-B	IS-C	Units
Millimeter machine	0.01	0.001	0.0001	mm
Inch machine	0.001	0.0001	0.00001	inch
Rotation axis	0.01	0.001	0.0001	deg

Setting command multiply (CMR), detection multiply (DMR), and the capacity of the reference counter

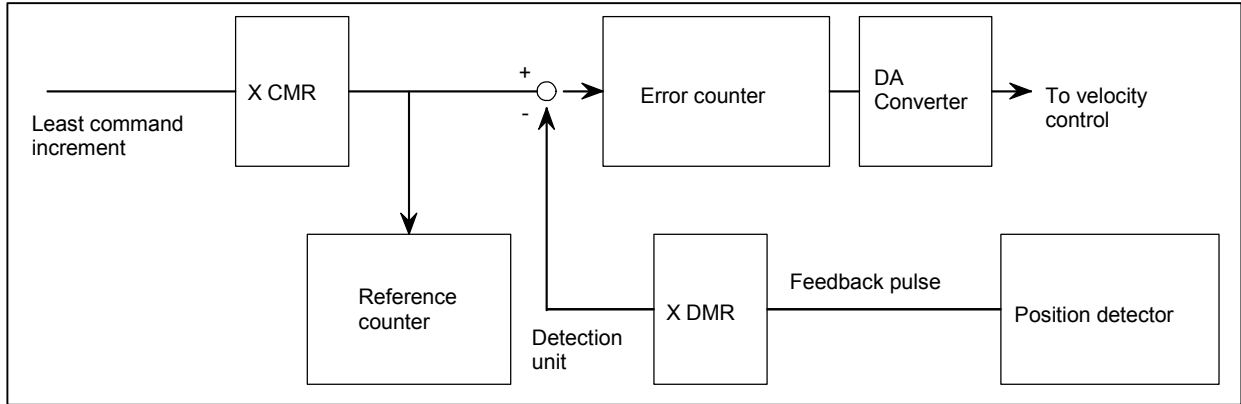

Fig.4.18 (a) CMR, DMR, and the Capacity of the Reference Counter

Set the magnification ratios of CMR and DMR so that the weight of positive inputs to the error counter equals that of negative inputs.

$$\frac{\text{Least command increment}}{\text{CMR}} = \text{Detection unit} = \frac{\text{Feedback pulse unit}}{\text{DMR}}$$

The feedback pulse unit varies according to the type of detector.

$$\text{Feedback pulse unit} = \frac{\text{The amount of travel per rotation of the Pulsecoder}}{\text{The number of pulses per rotation of the Pulsecoder (2000, 2500, or 3000)}}$$

As the size of the reference counter, specify the grid interval for the reference position return in the grid method.

$$\text{Size of the reference counter} = \frac{\text{Grid interval}}{\text{Detection unit}}$$

Grid interval = The amount of travel per rotation of the Pulsecoder

The value set in the parameter is obtained as follows:

- (1) When command multiplier is 1/2 to 1/27

$$\text{Set value} = \frac{1}{(\text{Command multiplier})} + 100$$

Valid data range: 102 to 127

- (2) When command multiply is 1 to 48

$$\text{Set value} = 2 \times \text{command multiplier}$$

Valid data range: 2 to 96

NOTE

When command multiplier is 1 to 48, the set value must be determined so that an integer can be set for command multiplier.

1821

Reference counter size for each axis

NOTE

When this parameter has been set, the power must be turned off before operation is continued.

[Data type] 2-word axis
 [Valid data range] 0 to 99999999

Set the size of the reference counter.

When an encoder with absolute address reference marks (linear scale or rotary encoder) is to be used, set the interval of mark 1 on the encoder with absolute address reference marks (linear scale or rotary encoder).

NOTE

With a scale with the absolute address zero point (detection circuit C), this parameter is used for the normal purpose (for setting the reference counter size for each axis).

1825

Servo loop gain for each axis

[Data type] Word axis
 [Unit of data] 0.01 s^{-1}
 [Valid data range] 1 to 9999

Set the loop gain for position control for each axis.

When the machine performs linear and circular interpolation (cutting), the same value must be set for all axes. When the machine requires positioning only, the values set for the axes may differ from one another. As the loop gain increases, the response by position control is improved. A too large loop gain, however, makes the servo system unstable.

The relationship between the positioning deviation (the number of pulses counted by the error counter) and the feedrate is expressed as follows:

$$\text{Positioning deviation} = \frac{\text{Feedrate}}{60 \times (\text{loop gain})}$$

Unit :

Positioning deviation : mm, inches, or deg
 Feedrate : mm/min, inches/min, or deg/min
 loop gain : s^{-1}

1826	In-position width for each axis
[Data type]	Word axis
[Unit of data]	Detection unit
[Valid data range]	0 to 32767
	The in-position width is set for each axis. When the deviation of the machine position from the specified position (the absolute value of the positioning deviation) is smaller than the in-position width, the machine is assumed to have reached the specified position. (The machine is in the in-position state.)
1827	In-position width in cutting feed for each axis
[Data type]	Word axis
[Unit of data]	Detection unit
[Valid data range]	0 to 32767
	Set an in-position width for each axis in cutting feed. This parameter is valid when bit 4 (CCI) of parameter No.1801=1.
1828	Positioning deviation limit for each axis in movement
[Data type]	2-word axis
[Unit of data]	Detection unit
[Valid data range]	0 to 99999999
	Set the positioning deviation limit in movement for each axis. If the positioning deviation exceeds the positioning deviation limit during movement, a servo alarm is generated, and operation is stopped immediately (as in emergency stop). Generally, set the positioning deviation for rapid traverse plus some margin in this parameter.
1829	Positioning deviation limit for each axis in the stopped state
[Data type]	Word axis
[Unit of data]	Detection unit
[Valid data range]	0 to 32767
	Set the positioning deviation limit in the stopped state for each axis. If, in the stopped state, the positioning deviation exceeds the positioning deviation limit set for stopped state, a servo alarm is generated, and operation is stopped immediately (as in emergency stop).

1830	Axis-by-axis positional deviation limit at servo-off time
[Data type]	2-word axis
[Unit of data]	Detection unit
[Valid data range]	0 to 99999999
	This parameter is used to set a positional deviation limit at servo-off time, on an axis-by-axis basis. If the value specified with this parameter is exceeded at servo-off time, a servo alarm (No.410) is issued to cause an immediate stop (same as an emergency stop). Usually, set the same value as a positional deviation at stop time (parameter No.1829).

NOTE

When this parameter is set to 0, no positional deviation limit check is made at servo-off time.

1836	Servo error amount where reference position return is possible
[Data type]	Byte axis
[Unit of data]	Detection unit
[Valid data range]	0 to 127
	This parameter sets a servo error used to enable reference position return in manual reference position return. In general, set this parameter to 0. (When 0 is set, 128 is assumed as the default.)

NOTE

When bit 0 (PLC01) of parameter No.2000 is set to 1, a value ten times greater than the value set in this parameter is used to make the check.

Example

When the value 10 is set in this parameter, and bit 0 (PLC01) of parameter No.2000 is set to 1, reference

1850	Grid shift and reference position shift for each axis
	NOTE When this parameter has been set, the power must be turned off before operation is continued.
[Data type]	2-word axis
[Unit of data]	Detection unit
[Valid data range]	(1) 0 to 99999999 (for reference shift position) (2) Reference counter size or less (for grid shift)
	To shift the reference position, set the amount of grid shift or reference position shift for each axis. Up to the maximum value counted by the reference counter can be specified as the grid shift. In case of parameter SFD (No.1002#2) is 0: Grid shift In case of parameter SFD (No.1002#2) is 1: Reference shift position

1851 Backlash compensating value for each axis

[Data type] Word axis
 [Unit of data] Detection unit
 [Valid data range] -9999 to +9999
 Set the backlash compensating value for each axis.
 When the machine moves in a direction opposite to the reference position return direction after the power is turned on, the first backlash compensation is performed.

1852 Backlash compensating value used for rapid traverse for each axis

[Data type] Word axis
 [Unit of data] Detection unit
 [Valid data range] -9999 to +9999
 Set the backlash compensating value used in rapid traverse for each axis.
 This parameter is valid when RBK, #4 of parameter 1800, is set to 1.
 More precise machining can be performed by changing the backlash compensating value depending on the feedrate, the rapid traverse or the cutting feed.
 Let the measured backlash at cutting feed be A and the measured backlash at rapid traverse be B. The backlash compensating value is shown below depending on the change of feedrate (cutting feed or rapid traverse) and the change of the direction of movement.

Table 4.18 Backlash Compensating Value

Change of feedrate / Change of direction of movement	Cutting feed to cutting feed	Rapid traverse to rapid traverse	Rapid traverse to cutting feed	Cutting feed to rapid traverse
Same direction	0	0	$\pm\alpha$	$\pm(-\alpha)$
Opposite direction	$\pm A$	$\pm B$	$\pm B (B+\alpha)$	$\pm B (B+\alpha)$

$$\alpha = (A-B)/2$$

The positive or negative direction for compensating values is the direction of movement.

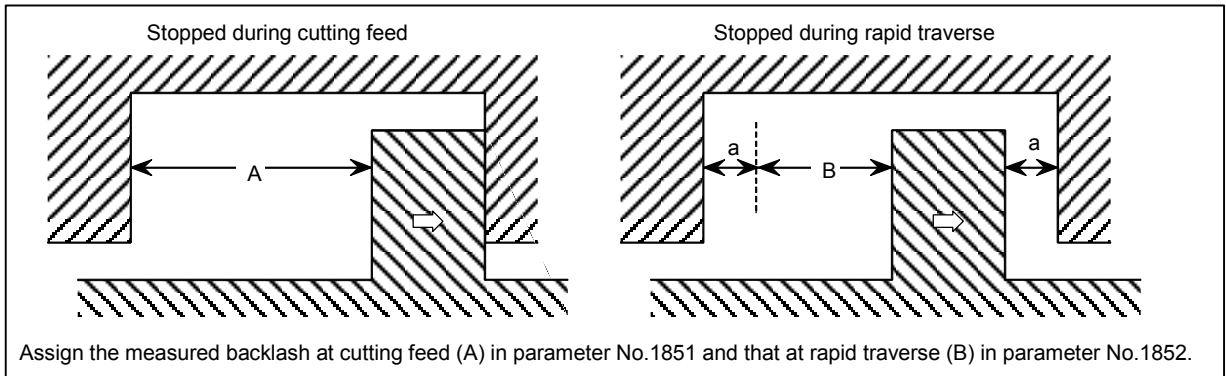

NOTE

- 1 Jog feed is regarded as cutting feed.
- 2 The backlash compensation depending on a rapid traverse and a cutting feed is not performed until the first reference position return is completed after the power is turned on. The normal backlash compensation is performed according to the value specified in parameter No.1851 irrespective of a rapid traverse and a cutting feed.
- 3 The backlash compensation depending on a rapid traverse and a cutting feed is performed only when RBK, bit 4 of parameter No.1800, is set to 1. When RBK is set to 0, the normal backlash is performed.

1867

Threshold for scale data conversion (common to all axes)

[Data type] 2-word
 [Unit of data]

Increment system	IS-A	IS-B	IS-C	Unit
Rotation axis	0.01	0.001	0.0001	deg

[Valid data range] 0 to 99999999

If scale data is greater than the setting of this parameter, data for one turn is subtracted from the scale data so that continuous scale data is obtained within the movable range. The threshold to be set must be the scale data of a position outside the movable range (an angle from a discontinuous point). This parameter is common to all axes. If a non-zero value is set in parameter No. 1868 for an axis, this parameter is invalid for that axis.

NOTE

- 1 When this parameter has been set, the power must be turned off before operation is continued.
- 2 This parameter is valid only for axes for which bit 3 (SCR) of parameter No. 1817 is set to 1.
- 3 When you have changed this parameter, establish the reference position again.

1868	Threshold for scale data conversion (for each axis)

[Data type] 2-word axis
 [Unit of data]

Increment system	IS-A	IS-B	IS-C	Unit
Rotation axis	0.01	0.001	0.0001	deg

[Valid data range] 0 to 99999999
 If scale data is greater than the setting of this parameter, data for one turn is subtracted from the scale data so that continuous scale data is obtained within the movable range. The threshold to be set must be the scale data of a position outside the movable range (an angle from a discontinuous point). For axes for which this parameter is set to 0, the parameter common to all axes (parameter No. 1867) becomes valid.

NOTE

- 1 When this parameter has been set, the power must be turned off before operation is continued.
- 2 This parameter is valid only for axes for which bit 3 (SCR) of parameter No. 1817 is set to 1.
- 3 When you have changed this parameter, establish the reference position again.

1874	Number of the conversion coefficient for inductosyn position detection
-------------	---

1875	Denominator of the conversion coefficient for inductosyn position detection
-------------	--

NOTE
 When this parameter has been set, the power must be turned off before operation is continued.

[Data type] Word axis
 [Valid data range] 1 to 32767
 Set a conversion coefficient for inductosyn position detection for each axis. The value set is determined as follows:

$$\frac{\text{No. 1874}}{\text{No. 1875}} = \frac{\text{Number of position feedback pulses per motor revolution}}{1,000,000}$$

1876	One-pitch interval of the inductosyn
-------------	---

NOTE
 When this parameter has been set, the power must be turned off before operation is continued.

[Data type] Word axis
 [Unit of data] Detection unit
 [Valid data range] 1 to 32767
 Set a one-pitch interval of the inductosyn for each axis.

SUPPLEMENTAL REMARK

To use an absolute-position detector using Inductosyn, set the following digital servo parameters as well:

Bit 4 (INDx) of parameter No. 2015

The absolute-position detect function by Inductosyn is:

0 : Disabled.

1 : Enabled.

Parameter No. 2141 Inductosyn data acquisition time

Set a time requirement for acquiring the Inductosyn data. If the setting is 0, 20 ms is assumed. (For the setting, contact the scale manufacturer.)

1880

Unexpected disturbance torque detection alarm timer

[Data type] Word
 [Unit of data] ms
 [Valid data range] 0 to 32767 (200 msec is assumed when 0 is set)
 This parameter sets the time from the detection of an unexpected disturbance torque until a servo alarm is issued. The specified value is rounded up to the nearest integral multiple of 8 msec.
 [Example]
 When 30 is specified, the value is rounded up to 32 (msec).

1881

Group number when an unexpected disturbance torque is detected

[Data type] Byte axis
 [Valid data range] 0 to 4
 This parameter sets the group number of each axis, used when an unexpected disturbance torque is detected.
 If an unexpected disturbance torque is detected for an axis, only the movement along the axes of the group containing the axis with the unexpected disturbance torque is stopped. If 0 is set for an axis, movement along that axis is stopped whenever an unexpected disturbance torque is detected for any axis.
 [Example]

Assume that the following settings have been made. If an unexpected disturbance torque is detected for the first axis, movement along the first, third, and fourth axes is stopped. If an unexpected disturbance torque is detected for the second axis, movement along the second and fourth axes is stopped.

Parameter No.1881	Setting
(First axis)	1
(Second axis)	2
(Third axis)	1
(Fourth axis)	0

NOTE

This parameter is enabled when the ANA parameter (bit 5 of parameter No.1804) is 1.

1882

Interval of mark 2 on encoder with absolute address reference marks

[Data type] 2-word axis
 [Unit of data] Detection unit
 [Valid data range] 0 to 99999999

This parameter sets the interval of mark 2 on the encoder with absolute address reference marks (linear scale or rotary encoder).

NOTE

For an encoder with the absolute address zero point (linear scale or rotary encoder) (detection circuit C), the setting of this parameter is invalid.

1883

Distance 1 from the mark zero point of an encoder with absolute address reference marks or encoder with the absolute address zero point (detection circuit C) to the reference position

NOTE

When this parameter has been set, the power must be turned off before operation is continued.

[Data type] 2-word axis
 [Unit of data] Detection unit
 [Valid data range] -99999999 to 99999999

1884

Distance 2 from the mark zero point of an encoder with absolute address reference marks or encoder with the absolute address zero point (detection circuit C) to the reference position

NOTE

- 1 When this parameter has been set, the power must be turned off before operation is continued.
- 2 When an encoder with the absolute address zero point (linear scale or rotary encoder) (detection circuit C) is used, specifying a value beyond the valid data range in this parameter can cause P/S 5325 to be issued during the establishment of the reference position.

[Data type] Word axis
 [Unit of data] Detection unit × 100,000,000
 [Valid data range] -20 to 20

This parameter is used when the distance from the zero point of an encoder to the reference position exceeds the setting range of parameter No. 1883.

With parameter Nos.1883 and 1884, set the distance from the zero point of the encoder with absolute address reference marks (linear scale or rotary encoder) or encoder with the absolute address zero point (linear scale or rotary encoder) (detection circuit C) to the

reference position. The distance from the zero point of the encoder to the reference position is obtained from the following equation:

$$\text{Distance from the zero point of the encoder to the reference position} = \text{No.1884} \times 100,000,000 + \text{No.1883}$$

The zero point of the encoder refers to the point at which mark 1 and mark 2 match. Normally, this point is a hypothetical point that does not physically exist on the encoder. (See the figure below.)

If the reference position is located on the positive side when viewed from the zero point of the encoder, set a positive value. If the reference position is located on the negative side when viewed from the zero point of the encoder, set a negative value.

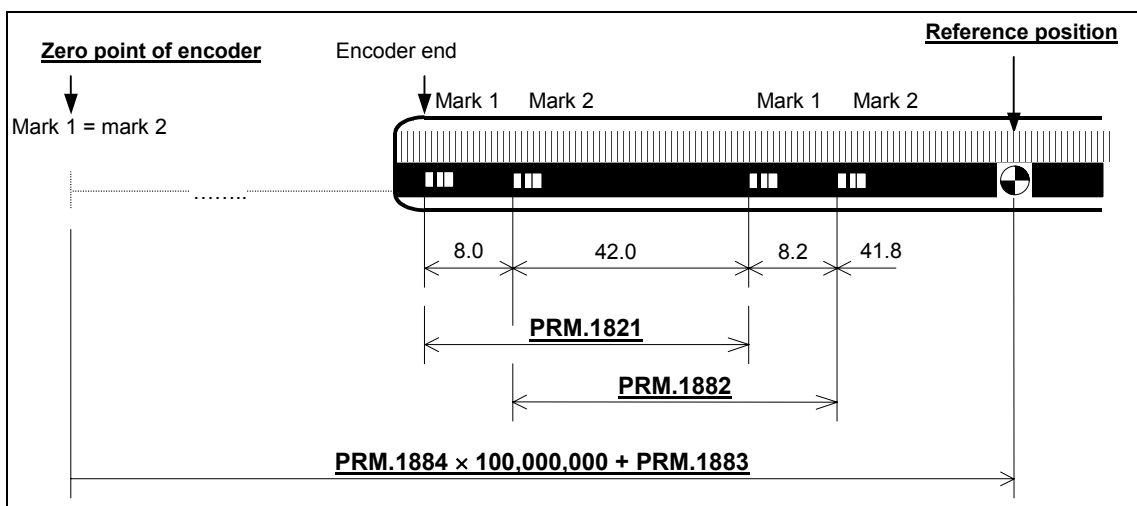

[Example of parameter settings] When an encoder as shown below is used with an IS-B, millimeter machine:

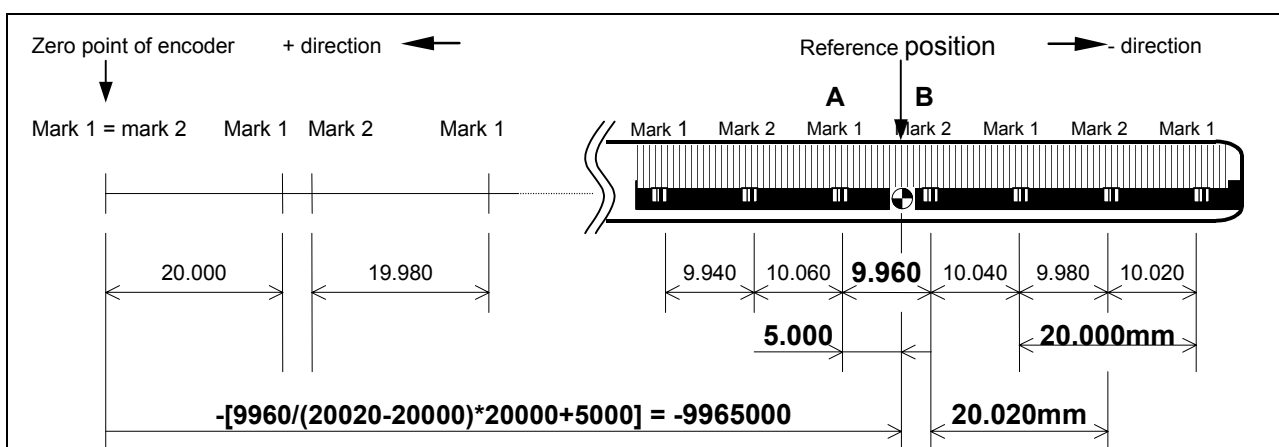

Parameters

- No.1821 (interval of mark 1) = 20000
- No.1882 (interval of mark 2) = 20020
- No.1883 (reference position) = position of point A + 5.000
= distance between A and B/(mark 2 – mark 1) × mark 1 + 5000
= 9960/(20020-20000) × 20000 + 5000
= 9965000

-9965000 (the reference position is on the negative side)

[Setting parameter No. 1883] (For an encoder with absolute address reference marks (linear scale or rotary encoder))

If it is difficult to measure the distance from the zero point of the encoder to the reference position (parameter No. 1883), the distance can be obtained by following the steps below:

- 1 Set the following parameters to use the encoder with absolute address reference marks (linear scale or rotary encoder):
OPTx(No.1815#1)=1,DCLx(No.1815#2)=1,DCRx(No.1815#3)=0/1
Set appropriate values in parameter Nos. 1821 and 1882.
Set parameter No. 1240 to 0.
Set parameter Nos.1883 and 1884 to 0.
- 2 Establish the reference position at an appropriate position.
(As a result of this, the machine coordinate value shows the distance from the zero point of the encoder to the current position.)
- 3 Perform a jog feed or handle feed to position the machine at the accurate reference position.
- 4 In parameter No. 1883, set the result of the conversion of the machine coordinate value observed at this point of time (diagnosis screen No. 301) into the detection unit (by multiplying the value on diagnosis screen No. 301 by CMR).
- 5 If necessary, set parameter No. 1240.

NOTE

This method does not apply if the distance from the zero point of the encoder to the reference position exceeds 99,999,999.

[Setting parameter No. 1883] (For an encoder with the absolute address zero point (linear scale or rotary encoder) (detection circuit C))

The value to be set can be obtained by following the steps below.

- 1 Set bit 1 (OPTx) of parameter No. 1815 to 0 or 1, and bit 2 (DCLx) of parameter No. 1815 to 1 to use the encoder with the absolute address zero point (linear scale or rotary encoder) (detection circuit C).
Set parameter No. 1240 to 0.
Set parameter Nos. 1883 and 1884 to 0.
- 2 Establish the reference position at an appropriate position.
(As a result of this, the machine coordinate value shows the distance from the zero point of the encoder to the current position.)
- 3 Perform a jog feed or handle feed to position the machine at the accurate reference position.
- 4 In parameter No. 1883, set the result of the conversion of the machine coordinate value observed at this point of time (diagnostic screen No. 301) into the detection unit (multiplication of the value on diagnostic screen No. 301 by CMR).
- 5 If necessary, set parameter No. 1240.

NOTE

This method does not apply if the distance from the zero point of the encoder to the reference position exceeds 99,999,999.

1885**Maximum allowable value for total travel during torque control**

[Data type] Word axis
 [Unit of data] Detection unit
 [Valid data range] 0 to 32767

This parameter sets the maximum allowable value for the total travel (error counter value) for an axis placed under torque control, as specified by the axis control command of the PMC axis control function. If the total travel exceeds the parameter-set value while torque control is applied, a servo alarm (No.423) is generated.

NOTE

This parameter is enabled when the TQF parameter (bit 4 of parameter No.1803) is 0 (follow-up is not performed during torque control).

1886**Positional deviation when torque control is canceled**

[Data type] Word axis
 [Unit of data] Detection unit
 [Valid data range] 0 to 32767

This parameter sets the positional deviation used when torque control, performed for an axis according to the axis control command of the PMC axis control function, is canceled and position control is resumed. After the positional deviation has fallen to the parameter-set value, switching to position control is performed.

NOTE

This parameter is enabled when the TQF parameter (bit 4 of parameter No.1803) is 0 (follow-up is not performed during torque control).

1895	Servo motor axis number used for a milling tool
-------------	--

[Data type] Byte
 [Valid data range] 1, 2, 3, ..., number of controlled axes
 This parameter sets the servo motor axis number used for displaying the speed of a milling tool that incorporates a servo motor.

1896	Number of gear teeth on the servo motor axis side
-------------	--

[Data type] Word
 [Valid data range] 1 to 9999
 This parameter sets the number of servo motor axis gear teeth used for displaying the speed of a milling tool that incorporates a servo motor.

1897	Number of gear teeth on the milling axis side
-------------	--

[Data type] Word
 [Valid data range] 1 to 9999
 This parameter sets the number of milling axis gear teeth used for displaying the speed of a milling tool that incorporates a servo motor.

1901	#7	#6	#5	#4	#3	#2	#1	#0
			RFD					

[Data type] Bit
 RFD In jog feed mode, the fine acceleration/deceleration function and feed-forward function are:
 0 : Disabled.
 1 : Enabled.

NOTE

- The axis operating under PMC axis control are not affected by this parameter. For such an axis, the settings for PMC axis control are followed. To enable the fine acceleration/deceleration function and feed-forward function in PMC axis control, advanced preview control for the PMC-controlled axis must be enabled. (See the descriptions of bit 3 (G8C) of parameter No. 8004 and bit 4 (G8R) of parameter No. 8004.)
- Note that when the abnormal load detection function for cutting and rapid traverse is used, setting this parameter changes the threshold value (0: Threshold value for rapid traverse, 1: Threshold value for cutting feed).

	#7	#6	#5	#4	#3	#2	#1	#0
1902							ASE	FMD

NOTE
When this parameter has been set, the power must be turned off before operation is continued.

⚠ WARNING
Be sure to set bits 5 and 7 of parameter No. 1902 to 0. If 1 is set, the safety function may not work properly.

[Data type] Bit
 FMD The FSSB setting mode is:
 0 : Automatic setting mode.
 (When information including an axis-amplifier relationship is set on the FSSB setting screen, parameter Nos. 1023, 1905, 1910 through 1919, 1936, and 1937 are set automatically.)
 1 : Manual setting 2 mode.
 (Set parameter Nos. 1023, 1905, 1910 through 1919, 1936, and 1937 manually.)
 ASE When automatic setting mode is selected for FSSB setting (when the FMD parameter (bit 0 of parameter No.1902) is set to 0), automatic setting is:
 0 : Not completed.
 1 : Completed.
 (This bit is automatically set to 1 upon the completion of automatic setting.)

	#7	#6	#5	#4	#3	#2	#1	#0
1904								DSPx

NOTE
When this parameter has been set, the power must be turned off before operation is continued.

[Data type] Bit axis
 DSPx
 0 : Two axes use one DSP. (Ordinary axes)
 1 : One axis uses one DSP exclusively.

NOTE
Parameter No.1904 is set on the FSSB setting screen. So, parameter No.1904 should not have to be specified directly. This parameter need not be set in FSSB manual setting 2 mode.

	#7	#6	#5	#4	#3	#2	#1	#0
1905	PM2x	PM1x						FSLx

NOTE
 When this parameter has been set, the power must be turned off before operation is continued.

[Data type] Bit axis
 FSLx The type of interface used between the servo amplifier and servo software is:
 0 : Fast type.
 1 : Slow type.
 The user can choose between two interface types for servo data transfer: fast type or slow type. Set this parameter so that the following conditions are satisfied:

- When a one-axis amplifier is used, either the fast type or slow type interface can be used.
- When a two-axis amplifier is used, the use of the fast type for both axes is not allowed. The slow type can be used for both axes.
- When a three-axis amplifier is used, the requirement for a two-axes amplifier described above applies to the first and second axes, and the requirement for a one-axis amplifier, again described above, applies to the third axis.
- When an odd number is specified for parameter No.1023, the fast type interface must be used. However, the slow type may be used for high-speed current loop axis and high-speed interface axis.
- When an even number is specified for parameter No.1023, only the slow type interface can be used. (The FSL bit must always be set to 1.)

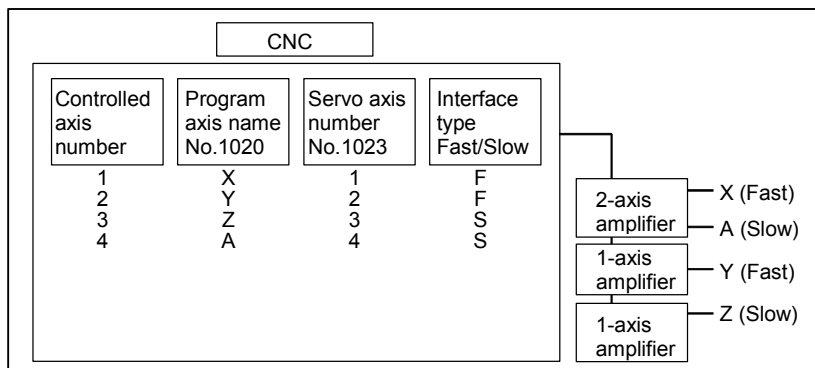

PM1x The first separate detector interface unit is:
 0 : Not used.
 1 : Used.
 PM2x The second separate detector interface unit is:
 0 : Not used.
 1 : Used.

NOTE

When automatic setting mode is selected for FSSB setting (when the FMD parameter (bit 0 of parameter No.1902) is set to 0), parameter No.1905 is automatically set when input is performed with the FSSB setting screen. When manual setting 2 mode is selected for FSSB setting (when the FMD parameter (bit 0 of parameter No.1902) is set to 1), parameter No.1905 must be set directly. When a separate detector interface unit is used, a connector number must be set in the corresponding parameter (No.1936 or No.1937).

1910	Address conversion table value for slave 1 (ATR)
1911	Address conversion table value for slave 2 (ATR)
1912	Address conversion table value for slave 3 (ATR)
1913	Address conversion table value for slave 4 (ATR)
1914	Address conversion table value for slave 5 (ATR)
1915	Address conversion table value for slave 6 (ATR)
1916	Address conversion table value for slave 7 (ATR)
1917	Address conversion table value for slave 8 (ATR)
1918	Address conversion table value for slave 9 (ATR)
1919	Address conversion table value for slave 10 (ATR)

NOTE

After these parameters have been set, the power must be turned off then back on for the settings to become effective.

[Data type]
[Valid data range]

Byte

0 to 3, 16, 40, 48

These parameters set address conversion table values for slaves 1 to 10.

A slave is the generic name given to a device such as a servo amplifier or separate detector interface unit, connected to the CNC via an FSSB optical cable. Smaller numbers, starting from 1 are assigned to slaves closer to the CNC; the maximum number that can be assigned is 10. A two-axis amplifier has two slaves, while a three-axis amplifier has three slaves. Set each parameter as described below,

depending on whether the slave is an amplifier or separate detector interface unit, or when no slave exists.

- When the slave is an amplifier:
Set the value obtained by subtracting 1 from the setting of parameter No.1023 for the axis to which the amplifier is assigned.
- When the slave is a separate detector interface unit:
Set 16 for the first separate detector interface unit (closest to the CNC).
Set 48 for the second separate detector interface unit (furthest from the CNC).
- When no slave exists
Set 40.

NOTE

When automatic setting mode is selected for FSSB setting (when the FMD parameter (bit 0 of parameter No.1902) is set to 0), parameters No.1910 to No.1919 are automatically set when input is performed with the FSSB setting screen. When manual setting 2 mode is selected for FSSB setting (when the FMD parameter (bit 0 of parameter No.1902) is set to 1), parameter No.1910 to No.1919 must be directly set.

• Examples of axis configurations and parameter settings

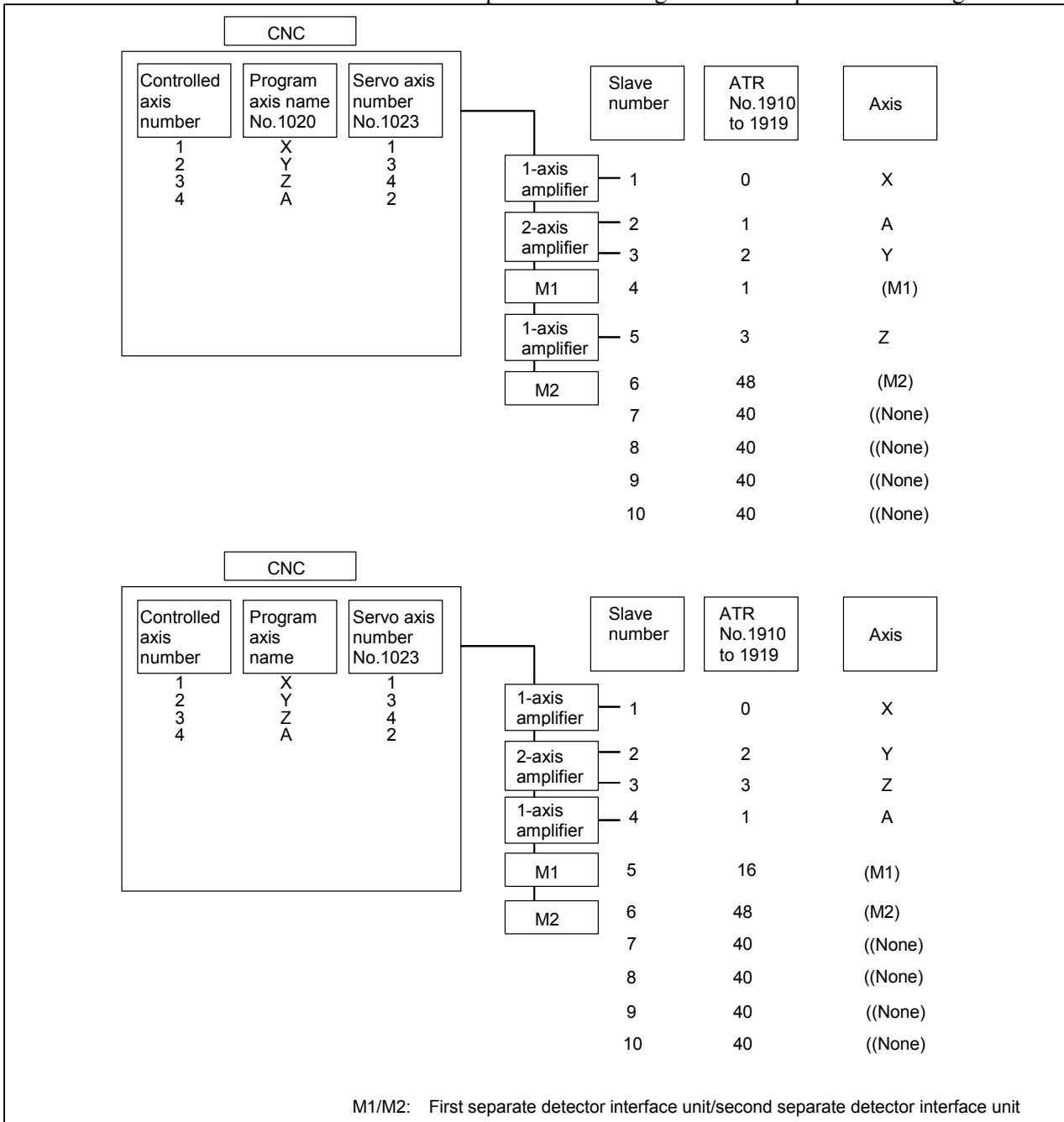

- 1920** **Controlled axis number for slave 1 (dedicated to the FSSB setting screen)**
- 1921** **Controlled axis number for slave 2 (dedicated to the FSSB setting screen)**
- 1922** **Controlled axis number for slave 3 (dedicated to the FSSB setting screen)**
- 1923** **Controlled axis number for slave 4 (dedicated to the FSSB setting screen)**
- 1924** **Controlled axis number for slave 5 (dedicated to the FSSB setting screen)**

1925	Controlled axis number for slave 6 (dedicated to the FSSB setting screen)
1926	Controlled axis number for slave 7 (dedicated to the FSSB setting screen)
1927	Controlled axis number for slave 8 (dedicated to the FSSB setting screen)
1928	Controlled axis number for slave 9 (dedicated to the FSSB setting screen)
1929	Controlled axis number for slave 10 (dedicated to the FSSB setting screen)

NOTE
 After these parameters have been set, the power must be turned off then back on for the settings to become effective.

[Data type] Byte
 [Valid data range] 0 to 3
 These parameters are used to set the controlled axis numbers for slaves 1 to 10.

NOTE
 These parameters are set using the FSSB setting screen. So, these parameters should not normally have to be specified directly. These parameters need not be set in FSSB manual setting mode.

1931	Connector number for the first separate detector interface unit (dedicated to the FSSB setting screen)
1932	Connector number for the second separate detector interface unit (dedicated to the FSSB setting screen)

NOTE
 After these parameters have been set, the power must be turned off then back on for the settings to become effective.

[Data type] Byte axis
 [Valid data range] 0 to number of connectors provided on each separate detector interface unit
 When a separate detector interface unit is used, these parameters set a separate detector interface unit connector number for each axis.

NOTE
 These parameters are set using the FSSB setting screen. So, these parameters should not normally have to be specified directly. These parameters need not be set in FSSB manual setting 2 mode.

1933

Cs contour control axis (dedicated to the FSSB setting screen)

NOTE

When this parameter has been set, the power must be turned off before operation is continued.

[Data type]
[Valid data range]

Byte axis
0, 1

When Cs contour control is to be applied for an axis, this parameter must be set to 1 for that axis.

NOTE

This parameter is set using the FSSB setting screen. So, this parameter should not normally have to be specified directly. This parameter need not be set in FSSB manual setting 2 mode.

1934

Master and slave axis numbers subject to tandem control (dedicated to the FSSB setting screen)

NOTE

When this parameter has been set, the power must be turned off before operation is continued.

[Data type]
[Valid data range]

Byte axis
0 to 3

This parameter is used to set an odd number, and the subsequent even number, for a master axis and slave axis subject to tandem control, respectively.

NOTE

This parameter is set using the FSSB setting screen. So, this parameter should not normally have to be specified directly. This parameter need not be set in FSSB manual setting 2 mode.

1936	Connector number of the first separate detector interface unit
1937	Connector number of the second separate detector interface unit

NOTE

After these parameters have been set, the power must be turned off then back on for the settings to become effective.

[Data type] Byte axis
 [Valid data range] 0 to 7

When a separate detector interface unit is used, each of these parameters sets the value obtained by subtracting 1 from a separate detector interface unit connector number for each axis. That is, values of 0 through 7 are set for connector numbers 1 through 8. In addition, bits 6 and 7 of parameter No.1905 must be set. For an axis that does not use a separate detector interface unit, 0 must be set.

Any connector can be used for any axis, however the connectors in a single separate detector interface unit should be used in ascending order

of connector number. For instance, connector 4 of a separate detector interface unit cannot be used without using connector 3 of the same separate detector interface unit.

Example

Controlled axis	Connector number for the first separate detector interface unit	Connector number for the second separate detector interface unit	No.1936	No.1937	No.1905 (#7, #6)
X	1	Not used	0	0	0, 1
Y	Not used	2	0	1	1, 0
Z	Not used	1	0	0	1, 0
A	Not used	Not used	0	0	0, 0

NOTE

When automatic setting mode is selected for FSSB setting (when bit 0 of parameter No.1902 is set to 0), these parameters are automatically set when input is performed with the FSSB setting screen. When manual setting 2 mode is selected for FSSB setting (when bit 0 of parameter No.1902 is set to 1), these parameters must be set directly.

Parameters No.2000 to 2999 are for digital servo, The following parameters are not explained in this manual. Refer to FANUC AC SERVO MOTOR α i series PARAMETER MANUAL (B-65270EN)

No.	Data type	Contents							
2000	Bit axis				PGEX	PRMC		DGPR	PLC0
2001	Bit axis	AMR7	AMR6	AMR5	AMR4	AMR3	AMR2	AMR1	AMR0
2002	Bit axis					PFSE			
2003	Bit axis	V0FS	OVSC	BLEN	NPSP	PIEN	OBEN	TGAL	
2004	Bit axis					TRW1	TRW0	TIB0	TIA0
2005	Bit axis	SFCM	BRKC					FEED	
2006	Bit axis				ACCF		PKVE		FCBL
2007	Bit axis	FRCA	FAD					IGVRO	ESP2AX
2008	Bit axis	LAXD	PFBS	VCTM	SPPC	SPPR	VFBA	TNDM	
2009	Bit axis	BLST	BLCU				ADBL		SERD
2010	Bit axis	POLE		HBBL	HBPE	BLTE	LINE		
2011	Bit axis			RCCL				FFALWY	SYNMOD
2012	Bit axis	STNG		VCM2	VCM1			MSFE	
2013	Bit axis	APTG							HRV3
2014	Bit axis	(Reserve)							
2015	Bit axis	BZNG	BLAT	TDOU				SSG1	PGTW
2016	Bit axis					K2VC			ABNT
2017	Bit axis	PK25	OVCR	RISC	HTNG				DBST
2018	Bit axis	PFBC					OVR8	MOVO	REVS
2019	Bit axis	DPFB						TANDMP	
2020	Word axis	Motor number							
2021	Word axis	Load inertia ratio							
2022	Word axis	Direction of motor rotation							
2023	Word axis	Number of velocity pulses							
2024	Word axis	Number of position pulses							
2028	Word axis	Position gain switching speed							
2029	Word axis	Effective speed for integral acceleration at low speed							
2030	Word axis	Effective speed for integral deceleration at low speed							
2033	Word axis	Position feedback pulse							
2034	Word axis	Damping control gain							
2039	Word axis	Second-stage acceleration for two-stage backlash acceleration							
2040	Word axis	Current loop integral gain (PK1)							
2041	Word axis	Current loop proportional gain (PK2)							
2042	Word axis	Current loop gain (PK3)							
2043	Word axis	Velocity loop integral gain (PK1V)							
2044	Word axis	Velocity loop proportional gain (PK2V)							
2045	Word axis	Velocity loop incomplete integral gain (PK3V)							
2046	Word axis	Velocity loop gain (PK4V)							
2047	Word axis	Observer parameter (POA1)							
2048	Word axis	Backlash acceleration							
2049	Word axis	Maximum amplitude for dual position feedback							
2050	Word axis	Observer parameter (POK1)							
2051	Word axis	Observer parameter (POK2)							
2053	Word axis	Current dead zone compensation (PPMAX)							
2054	Word axis	Current dead zone compensation (PDDP)							
2055	Word axis	Current dead zone compensation (PHYST)							
2056	Word axis	Current gain change during deceleration (EMFCMP)							
2057	Word axis	D phase current at high-speed operation (PVPA)							

No.	Data type	Contents
2058	Word axis	D phase current limit (PALPH)
2059	Word axis	Counter electromotive force compensation (EMFBAS)
2060	Word axis	Torque limit
2062	Word axis	Overload protection coefficient (OVC1)
2063	Word axis	Overload protection coefficient (OVC2)
2064	Word axis	Soft disconnection alarm level
2065	Word axis	Overload protection coefficient (OCVLMT)
2066	Word axis	Acceleration feedback gain
2067	Word axis	Torque command filter
2068	Word axis	Feed forward coefficient
2069	Word axis	Velocity feed forward coefficient
2070	Word axis	Backlash acceleration timing
2071	Word axis	Backlash acceleration effective duration, time during which the static friction compensation function is enabled
2072	Word axis	Static friction compensation
2073	Word axis	Stop judgment parameter
2074	Word axis	Velocity-dependent current loop gain
2077	Word axis	Overshoot prevention counter
2078	Word axis	Conversion coefficient for dual position feedback (numerator)
2079	Word axis	Conversion coefficient for dual position feedback (denominator)
2080	Word axis	First-order lag time constant for dual position feedback
2081	Word axis	Zero width for dual position feedback
2082	Word axis	Backlash acceleration stop amount
2083	Word axis	Brake control timer (ms)
2084	Word axis	Flexible feed gear (numerator)
2085	Word axis	Flexible feed gear (denominator)
2086	Word axis	Rated current parameter
2087	Word axis	Torque offset /pre-loaded value in tandem control
2088	Word axis	Machine velocity feedback coefficient gain
2089	Word axis	Backlash acceleration base pulse
2091	Word axis	Non-linear control parameter
2092	Word axis	Look-ahead feed forward coefficient
2094	Word axis	Backlash acceleration in negative direction
2095	Word axis	Feed-forward timing adjustment coefficient
2097	Word axis	Static friction compensation stop parameter
2098	Word axis	Current phase lead compensation coefficient
2099	Word axis	N-pulse suppression level
2101	Word axis	Overshoot compensation effective level
2102	Word axis	Final clamp value for actual current limit
2103	Word axis	Amount of track back upon detection of unexpected disturbance torque
2104	Word axis	Abnormal load detection alarm level during cutting (for cutting when switch function is used)
2105	Word axis	Torque constant
2107	Word axis	Velocity loop gain override
2109	Word axis	Fine acceleration/deceleration time constant (for cutting when switch function is used)
2110	Word axis	Magnetic saturation compensation (base/coefficient)
2111	Word axis	Deceleration torque limit (base/coefficient)
2112	Word axis	AMR conversion coefficient 1
2113	Word axis	Attenuation center frequency (Hz) of vibration-damping filter 1
2114	Word axis	Stage 2 acceleration amount override for two-stage backlash acceleration
2116	Word axis	Abnormal load detection, dynamic friction compensation value
2118	Word axis	Excessive error level between semi-closed and closed loops
2119	Word axis	Stop level with variable proportional gain

No.	Data type	Contents							
2126	Word axis	Tandem control , time constant for switching position feedback							
2127	Word axis	Non-interacting control coefficient							
2128	Word axis	Weak magnetic flux compensation (coefficient)							
2129	Word axis	Weak magnetic flux compensation (base/limit)							
2130	Word axis	Two smooth compensation operations per magnetic pole pair							
2131	Word axis	Four smooth compensation operations per magnetic pole pair							
2132	Word axis	Six smooth compensation operations per magnetic pole pair							
2133	Word axis	Deceleration phase delay compensation coefficient (PHDLY1)							
2134	Word axis	Deceleration phase delay compensation coefficient (PHDLY2)							
2137	Word axis	Stage 1 acceleration amount override for two-stage backlash acceleration							
2138	Word axis	Linear motor AMR conversion coefficient 2							
2139	Word axis	Linear motor AMR offset							
2142	Word axis	Threshold for detecting abnormal load during rapid traverse							
2143	Word axis	Fine acceleration/deceleration time constant 2 (at cutting)							
2144	Word axis	Position feed forward coefficient for cutting							
2145	Word axis	Velocity feed forward coefficient for cutting							
2146	Word axis	Two-stage backlash acceleration end timer							
2148	Word axis	Deceleration decision level (HRV control)							
2154	Word axis	Static friction compensation function. Decision level for movement restart after stop.							
2156	Word axis	Torque command filter (at rapid cutting)							
2161	Word axis	OVC magnification at stop (OVCSTP)							
2162	Word axis	Second overload protection coefficient (POVC21)							
2163	Word axis	Second overload protection coefficient (POVC22)							
2164	Word axis	Second overload protection coefficient (POVCLMT2)							
2165	Word axis	Maximum amplifier current							
2167	Word axis	Stage 2 acceleration amount offset for two-stage backlash acceleration							
2177	Word axis	Attenuation band width (Hz) of vibration-damping filter 1							
2180	Word axis	Phase lag compensation in linear motor smooth compensation							
2185	Word axis	Position pulse conversion coefficient							
2200	Bit axis		P2EX	RISCMC		ABGO	IQOB		OVSP
2201	Bit axis		CPEE					RNVL	CROF
2202	Bit axis				DUAL	OVS1	PIAL	VGCG	FADCH
2203	Bit axis			TCMD4X	FRC2		CRPI		
2204	Bit axis	DBS2		PGW2				HSTP10	
2205	Bit axis				HDIS	HD2O	FLDY		
2206	Bit axis	HSSR			HBSF				
2207	Bit axis					PK2D50			
2209	Bit axis		PGAT			FADPGC	FADL		
2210	Bit axis		ESPTM1	ESPTM2			PK12S2		
2211	Bit axis							PHCP	
2212	Bit axis	OVQK	OVQK						
2214	Bit axis				FFCHG				
2215	Bit axis	ABT2						TCPCLR	
2223	Bit axis	BLCUT2							DISOBS
2225	Bit axis						TSA05	TCMD05	
2270	Bit axis	DSTIN	DSTTAN	DSTWA V		ACREF			AMR60
2271	Bit axis						RETR2		
2273	Bit axis							WSVCPY	
2274	Bit axis								HP2048
2275	Bit axis								800PLS
2318	Word axis	Disturbance filter gain							

No.	Data type	Contents
2319	Word axis	Inertial ratio of disturbance filter
2320	Word axis	Inverse function gain of disturbance filter
2321	Word axis	Filter time constant of disturbance filter
2322	Word axis	Acceleration feedback limit of disturbance filter
2323	Word axis	Variable current PI ratio
2324	Word axis	Proportional gain change function at stop Any magnification at stop (for cutting only)
2325	Word axis	Tandem vibration-damping control/integral gain (main axis) Phase coefficient (sub-axis)
2326	Word axis	Disturbance input gain
2327	Word axis	Starting frequency of disturbance input
2328	Word axis	Ending frequency of disturbance input
2329	Word axis	Number of disturbance input measurement points
2333	Word axis	Tandem vibration-damping control/incomplete integral time constant (main axis)
2334	Word axis	Current loop gain magnification (valid only during high-speed HRV current control)
2335	Word axis	Velocity loop gain magnification (valid only during high-speed HV current control)
2338	Word axis	Stage 2 acceleration limit amount for two-stage backlash acceleration
2339	Word axis	Stage 2 acceleration amount for two-stage backlash acceleration (negative direction)
2340	Word axis	Stage 2 acceleration amount override for two-stage backlash acceleration (negative direction)
2341	Word axis	Stage 2 acceleration limit amount for two-stage backlash acceleration (negative direction)
2345	Word axis	Dynamic friction compensation amount at stop in abnormal load detection
2346	Word axis	Dynamic friction compensation limit in abnormal load detection
2352	Word axis	Detection level of active vibration-damping filter
2359	Word axis	Damping of vibration-damping filter 1
2360	Word axis	Attenuation center frequency of vibration-damping filter 2
2361	Word axis	Attenuation band width of vibration-damping filter 2
2362	Word axis	Damping of vibration-damping filter 2
2363	Word axis	Attenuation center frequency of vibration-damping filter 3
2364	Word axis	Attenuation band width of vibration-damping filter 3
2365	Word axis	Damping of vibration-damping filter 3
2366	Word axis	Attenuation center frequency of vibration-damping filter 4
2367	Word axis	Attenuation band width of vibration-damping filter 4
2368	Word axis	Damping of vibration-damping filter 4
2369	Word axis	Two smooth compensation operations per magnetic pole pair (negative direction)
2370	Word axis	Four smooth compensation operations per magnetic pole pair (negative direction)
2371	Word axis	Six smooth compensation operations per magnetic pole pair (negative direction)
2373	Word axis	Pull-up amount of vertical axis pull-up function at emergency stop
2374	Word axis	Pull-up time of vertical axis pull-up function at emergency stop
2395	Word axis	Feed-forward timing adjustment function (when FAD is enabled)

4.16 PARAMETERS OF DI/DO

	#7	#6	#5	#4	#3	#2	#1	#0
3001	MHI			ZPO		RWM		
	MHI					RWM		

- [Data type] Bit
- RWM RWD signal indicating that rewinding is in progress
 0 : Output only when the tape reader is being rewound by the reset and rewind signal RRW
 1 : Output when the tape reader is being rewound or a program in memory is being rewound by the reset and rewind signal RRW
- ZPO The reference position return completion signal for G28 and G30 is:
 0 : Output upon completion of the reference position return operation.
 1 : Output when the machine is positioned at the reference position after the completion of the reference position return operation.

NOTE

If this parameter is set to 0, executing G28 or G30 outputs the reference position return completion signal even when the reference position return operation is performed in the machine lock state.

- MHI Exchange of strobe and completion signals for the M, S, T, and B codes
 0 : Normal
 1 : High-speed

	#7	#6	#5	#4	#3	#2	#1	#0
3002				IOV				

- [Data type] Bit
- IOV For the feedrate override signal and rapid traverse override signal:
 0 : Negative logic is used.
 1 : Positive logic is used.

	#7	#6	#5	#4	#3	#2	#1	#0
3003	MVG	MXV	DEC	DAU	DIT	ITX		ITL
		MXV	DEC		DIT	ITX		ITL

- [Data type] Bit
- ITL Interlock signal
 0 : Enabled
 1 : Disabled
- ITX Interlock signals for each axis
 0 : Enabled
 1 : Disabled

- DIT Interlock for each axis direction
0 : Enabled
1 : Disabled
- DAU If bit 3 (DIT) of parameter No. 3003 is set to 0, the interlock signal of each axial direction is:
0 : Enabled only in manual operation and disabled in automatic operation.
1 : Enabled in both manual operation and automatic operation.
- DEC Deceleration signal (*DEC1 to *DEC4) for reference position return
0 : Deceleration is applied when the signal is 0.
1 : Deceleration is applied when the signal is 1.
- MVX The axis-in-movement signal is set to 0 when:
0 : Distribution for the axis is completed. (The signal is set to 0 in deceleration.)
1 : Deceleration of the axis is terminated, and the current position is in the in-position.
If, however, a parameter specifies not to make in-position during deceleration, the signal turns to "0" at the end of deceleration.
- MVG While drawing using the dynamic graphics function (with no machine movement), the axis-in-movement signal is:
0 : Output
1 : Not output

NOTE
In case of M series the signal is not output.

	#7	#6	#5	#4	#3	#2	#1	#0
3004			OTH				BCY	BSL

- [Data type] Bit
- BSL The block start interlock signal *BSL and cutting block start interlock signal *CSL are:
0 : Disabled.
1 : Enabled.
 - BCY When more than one operation is performed by one block command such as a canned cycle, the block start interlock signal *BSL is:
0 : Checked only at the beginning of the first cycle.
1 : Checked at the beginning of every cycle.

NOTE
This is enabled when the BSL parameter (bit 0 of parameter No.3004) is set to 1.

- OTH The overtravel limit signal is:
0 : Checked
1 : Not checked

WARNING
For safety, usually set 0 to check the overtravel limit signal.

	#7	#6	#5	#4	#3	#2	#1	#0
3006						EPS	EPN	GDC

- GDC As the deceleration signal for reference position return:
 0 : X009 is used.
 1 : G196 is used. (X009 is disabled.)
- EPN Workpiece number search signals are assigned to:
 0 : PN1, PN2, PN4, PN8, and PN16 <G009>.
 1 : EPN0 to EPN13 <G024, G025>.
- EPS When a program is searched using the workpiece number search function, it is started by:
 0 : Automatic operation start signal ST (when automatic operation (memory operation) is started).
 1 : Workpiece number search start signal EPNS <G025#7>. (Search is not started by ST.)

	#7	#6	#5	#4	#3	#2	#1	#0
3008						XSG		

NOTE
 When this parameter is set, the power must be turned off before operation is continued.

- [Data type] Bit
- XSG The signals assigned to X addresses are:
 0 : Fixed to these addresses.
 1 : Able to be re-assigned to any addresses. (Emergency stop signal *ESP <X008#4>, however, cannot be changed.)
 When assignment to any addresses is selected, set parameter Nos. 3012 to 3014.

3010	Time lag in strobe signals MF, SF, TF, and BF
------	---

- [Data type] Word
- [Unit of data] 1 ms
- [Valid data range] 16 to 32767
- The time required to send strobe signals MF, SF, TF, and BF after the M, S, T, and B codes are sent, respectively.

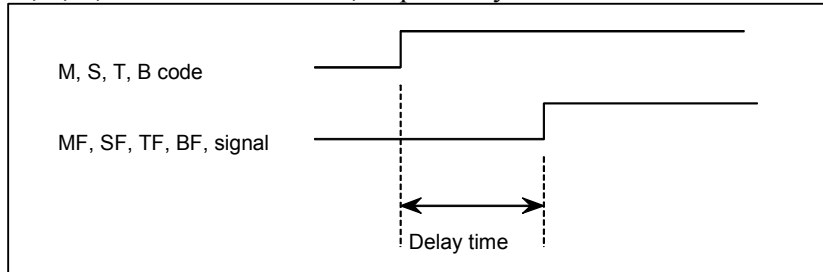

Fig.4.19 (a) Delay Time of the strobe signal

NOTE
 The time is counted in units of 8 ms. If the set value is not a multiple of eight, it is raised to the next multiple of eight.
 Example
 When 30 is set, 32 ms is assumed.
 When 32 is set, 32 ms is assumed.
 When 100 is set, 104 ms is assumed.

3011

Acceptable width of M, S, T, and B function completion signal (FIN)

[Data type] Word
 [Unit of data] 1 ms
 [Valid data range] 16 to 32767

Word

1 ms

16 to 32767

Set the minimum signal width of the valid M, S, T, and B function completion signal (FIN).

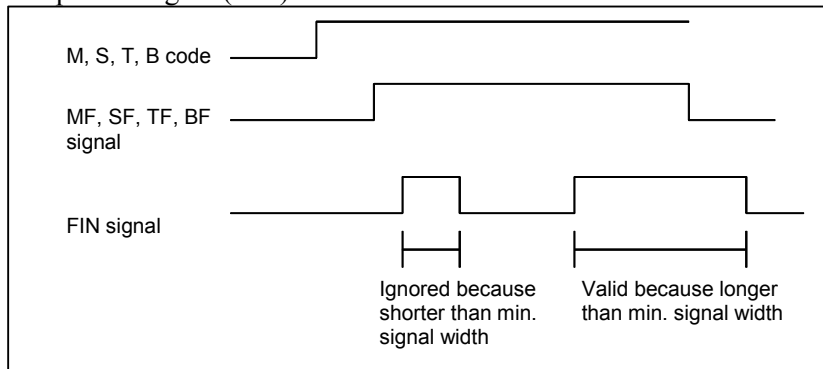

Fig.4.19 (b) Valid width of the FIN (M,S, T, and B function completion) signal

NOTE
 The time is counted in units of 8 ms. If the set value is not a multiple of eight, it is raised to the next multiple of eight.
 Example
 When 30 is set, 32 ms is assumed.

3012

Address to be assigned to skip signals

NOTE

When this parameter is set, the power must be turned off before operation is continued.

[Data type]
[Valid data range]

Word
0 to 127

Set the address to which the skip signals (SKIPn), measurement position arrival signals (XAE, YAE (for the M series only), and ZAE), and manual feed interlock signal for each axis direction and tool compensation amount write signal (\pm MIT1 (for the T series only) and \pm MIT2 (for the T series only)) are assigned.

This parameter is valid when bit 2 (XSG) of parameter No. 3008 is set to 1.

3013

Address to be assigned to reference position return deceleration signals

NOTE

When this parameter is set, the power must be turned off before operation is continued.

[Data type]
[Valid data range]

Word axis
0 to 127

Set the address to which the reference position return deceleration signal for each axis (*DECn) is assigned.

This parameter is valid when bit 2 (XSG) of parameter No. 3008 is set to 1.

3014

Bit position to be assigned to reference position return deceleration signals

NOTE

When this parameter is set, the power must be turned off before operation is continued.

[Data type]
[Valid data range]

Byte axis
0 to 7

Set the bit position to which the reference position return deceleration signal for each axis (*DECn) is assigned. Set the address in parameter No. 3013.

This parameter is valid when bit 2 (XSG) of parameter No. 3008 is set to 1.

3017	Output time of reset signal RST
-------------	--

[Data type] Word
 [Unit of data] 16 ms
 [Valid data range] 0 to 255
 To extend the output time of reset signal RST, the time to be added is specified in this parameter.
 RST signal output time = time required for reset + parameter × 16 ms

3030	Allowable number of digits for the M code
-------------	--

3031	Allowable number of digits for the S code
-------------	--

3032	Allowable number of digits for the T code
-------------	--

3033	Allowable number of digits for the B code
-------------	--

[Data type] Byte
 [Valid data range] 1 to 8
 Set the allowable numbers of digits for the M, S, T, and B codes.

NOTE
 Up to 5 digits can be specified in the S code

4.17 PARAMETERS OF DISPLAY AND EDIT (1 OF 2)

	#7	#6	#5	#4	#3	#2	#1	#0
3100	COR						CEM	

- [Data type] Bit
- CEM On screens such as the operation history screen and help screen, keys on the MDI panel are indicated:
 0 : In English.
 1 : With graphics qualifying for CE marking. (A character generator supporting graphics qualifying for CE marking is required.)
- COR Display
 0 : Monochrome display
 1 : Color display

NOTE

When using the 8.4" LCD, set this bit to 1.

	#7	#6	#5	#4	#3	#2	#1	#0
3101				BGD			KBF	

- [Data type] Bit
- KBF When the screen or mode is changed, the contents of the key-in buffer are:
 0 : Cleared.
 1 : Not cleared.

NOTE

When KBF = 1, the contents of the key-in buffer can all be cleared at one time by pressing the  key followed by the  key.

- BGD In background editing, a program currently selected in the foreground:
 0 : Cannot be selected. (BP/S alarm No.140 is issued disabling selection.)
 1 : Can be selected. (However, the program cannot be edited, only displayed.)

3102	#7	#6	#5	#4	#3	#2	#1	#0
		SPN	HNG	ITA	CHI	FRN	GRM	JPN
	DTH	SPN	HNG	ITA	CHI	FRN	GRM	JPN

3119	#7	#6	#5	#4	#3	#2	#1	#0
							POR	

3190	#7	#6	#5	#4	#3	#2	#1	#0
		CH2	CZE	SWE	HUN	POL		

NOTE
When this parameter has been set, the power must be turned off before operation is continued.

[Data type] Bit
Select the language to be used for the display.

CH2	CZE	SWE	HUN	POL	POR	DTH	SPN	HNG	ITA	CHI	FRN	GRM	JPN	Language
0	0	0	0	0	0	0	0	0	0	0	0	0	0	English
0	0	0	0	0	0	0	0	0	0	0	0	0	1	Japanese
0	0	0	0	0	0	0	0	0	0	0	0	1	0	German
0	0	0	0	0	0	0	0	0	0	0	1	0	0	French
0	0	0	0	0	0	0	0	0	0	1	0	0	0	Chinese (traditional characters)
0	0	0	0	0	0	0	0	0	1	0	0	0	0	Italian
0	0	0	0	0	0	0	0	1	0	0	0	0	0	Korean
0	0	0	0	0	0	0	1	0	0	0	0	0	0	Spanish
0	0	0	0	0	0	1	0	0	0	0	0	0	0	Dutch
0	0	0	0	0	1	0	0	0	0	0	0	0	0	Portuguese
0	0	0	0	1	0	0	0	0	0	0	0	0	0	Polish
0	0	0	1	0	0	0	0	0	0	0	0	0	0	Hungarian
0	0	1	0	0	0	0	0	0	0	0	0	0	0	Swedish
0	1	0	0	0	0	0	0	0	0	0	0	0	0	Czech
1	0	0	0	0	0	0	0	0	0	0	0	0	0	Chinese (simplified characters)

3103	#7	#6	#5	#4	#3	#2	#1	#0
						NMH		

[Data type] Bit
NMH The system alarm history screen is:
0 : Not displayed.
1 : Displayed.

	#7	#6	#5	#4	#3	#2	#1	#0
3104	DAC	DAL	DRC	DRL	PPD			MCN

- [Data type] Bit
 MCN Machine position
 0 : Displayed according to the unit of output.
 (The machine position is displayed regardless of whether metric input or inch input is used; for a machine with metric output, the machine position is displayed in mm, and for a machine with inch output, the machine position is displayed in inches.)
 1 : Displayed according to the unit of input.
 (When input is made in mm, the machine position is displayed in mm, and when input is made in inches, the machine position is displayed in inches accordingly.)
- PPD Relative position display when a coordinate system is set
 0 : Not preset
 1 : Preset

NOTE

When PPD is set to 1 and the absolute position display is preset by one of the following, the relative position display is also preset to the same value as the absolute position display:

- 1) The manual reference position return
- 2) Setting of a coordinate system by G92 (G50 for T series G code system A)

- DRL Relative position
 0 : The actual position displayed takes into account tool length offset (M series) or tool offset (T series).
 1 : The programmed position displayed does not take into account tool length offset (M series) or tool offset (T series).

NOTE

When tool geometry compensation of the T system is to be performed by shifting the coordinate system (with bit 4 (LGT) of parameter No.5002 set to 0), the programmed position, ignoring tool offset, is displayed (with this parameter set to 1), but the programmed position, ignoring tool geometry compensation, cannot be displayed.

- DRC Relative position
 0 : The actual position displayed takes into account cutter compensation (M series) or tool nose radius compensation (T series).
 1 : The programmed position displayed does not take into account cutter compensation (M series) or tool nose radius compensation (T series).

- DAL Absolute position
 0 : The actual position displayed takes into account tool length offset (M series) or tool offset (T series).
 1 : The programmed position displayed does not take into account tool length offset (M series) or tool offset (T series).

NOTE
 When tool geometry compensation of the T system is to be performed by shifting the coordinate system (with bit 4 (LGT) of parameter No.5002 set to 0), the programmed position, ignoring tool offset, is displayed (with this parameter set to 1), but the programmed position, ignoring tool geometry compensation, cannot be displayed.

- DAC Absolute position
 0 : The actual position displayed takes into account cutter compensation (M series) or tool nose radius compensation (T series).
 1 : The programmed position displayed does not take into account cutter compensation (M series) or tool nose radius compensation (T series).

	#7	#6	#5	#4	#3	#2	#1	#0
3105						DPS	PCF	DPF
	SMF					DPS	PCF	DPF

- [Data type] Bit
- DPS Display of the actual speed on the current position display screen, program check screen and program screen (MD1 mode)
 0 : Not displayed
 1 : Displayed
- PCF Addition of the movement of the PMC-controlled axes to the actual speed display
 0 : Added
 1 : Not added

NOTE
 For each setting, movement along any axis other than those controlled by the CNC (see the description of parameter No. 1010) is not reflected in the actual speed display.

- DPS Actual spindle speed and T code
 0 : Not always displayed
 1 : Always displayed

SMF During simplified synchronous control, movement along a slave axis is: (see the parameter No.8311)
 0 : Included in the actual speed display
 1 : Not included in the actual speed display

	#7	#6	#5	#4	#3	#2	#1	#0
3106	OHS		SOV	OPH	SPD		GPL	
	OHS		SOV	OPH			GPL	

[Data type] Bit
 GPL On the program list screen, the list-by-group function is:
 0 : Disabled
 1 : Enabled
 SPD Names for actual spindle speed values are displayed:
 0 : Regardless of the selected spindle position coder (in second position coder selection signal (PC2SLC))
 1 : Depending of the selected spindle position coder (in second position coder selection signal (PC2SLC))

SPD=0		SPD=1	
Spindles 1 and 2		Spindles 1	Spindles 2
S		S1	S2
SACT		SACT1	SACT2
ACT, S			

OPH The operation history screen is:
 0 : Not displayed.
 1 : Displayed.
 SOV The spindle override value is:
 0 : Not displayed.
 1 : Displayed.

NOTE
 This parameter is enabled only when bit 2 (DPS) of parameter No.3105 is set to 1.

OHS Operation history sampling is:
 0 : Performed.
 1 : Not performed.

NOTE
 Normally, set 0 (sampling is performed).

	#7	#6	#5	#4	#3	#2	#1	#0
3107	MDL			SOR	REV	DNC		

[Data type] Bit
 DNC Upon reset, the program display for DNC operation is:
 0 : Not cleared
 1 : Cleared

- REV The actual speed in feed per revolution mode is displayed in:
0 : MM/MIN or INCH/MIN.
1 : MM/REV or INCH/REV.
- SOR Display of the program directory
0 : Programs are listed in the order of registration.
1 : Programs are listed in the order of program number.
- MDL Display of the modal state on the program display screen
0 : Not displayed
1 : Displayed (only in the MDI mode)

	#7	#6	#5	#4	#3	#2	#1	#0
3108	JSP	SLM		WCI		PCT		

- [Data type] Bit
- PCT On the program check screen, T code displayed
0 : is a T code specified in a program (T).
1 : is a T code specified by the PMC (HD. T/NX. T)
 - WCI On the workpiece coordinate system screen, a counter input is:
0 : Disabled.
1 : Enabled.
 - SLM The spindle load meter is:
0 : Not displayed.
1 : Displayed.

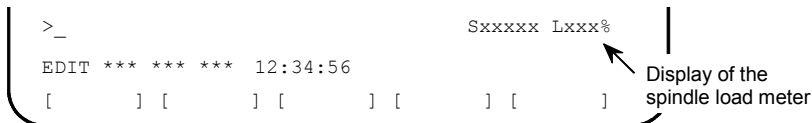

NOTE

- 1 This parameter is enabled only when the DPS parameter (bit 2 of parameter No.3105) is set to 1.
- 2 This is valid only for serial spindles.

- JSP On the current position display screen and program check screen, jog feed is:
0 : Not displayed.
1 : Displayed.

NOTE

In manual operation mode, the jog feedrate is displayed. In automatic operation mode, the dry run feedrate is displayed. In each case, the feedrate to which a manual feedrate override has been applied is displayed.

Screenshot of a CNC control screen showing jog feedrate and other parameters. An arrow points to 'JOG F 8000' with the text 'Jog feedrate'.

	#7	#6	#5	#4	#3	#2	#1	#0
3109			RHD			IKY	DWT	

- [Data type] Bit
- DWT Characters G and W in the display of tool wear/geometry compensation amount
 0 : The characters are displayed at the left of each number.
 1 : The characters are not displayed.
- IKY On the tool offset screen and workpiece shift screen (T series), soft key [INPUT] is:
 0 : Displayed.
 1 : Not displayed.
- RHD When a manual handle interrupt is generated, the relative position display is:
 0 : Not updated.
 1 : Updated.

NOTE
 This parameter is enabled when the INH parameter (bit 2 of parameter No.7100) is 1.

	#7	#6	#5	#4	#3	#2	#1	#0
3110						AHC		OFA
						AHC		

- [Data type] Bit
- OFA The axis names on the offset screen, Y-axis offset screen, and 4th axis offset screen are:
 0 : Always X, Z, and Y.
 1 : As specified by parameter No. 1020.
- AHC With a soft key, the alarm history:
 0 : Can be cleared.
 1 : Cannot be cleared.

	#7	#6	#5	#4	#3	#2	#1	#0
3111	NPA	OPS	OPM			SVP	SPS	SVS

- [Data type] Bit
- SVS Servo tuning screen
 0 : Not displayed
 1 : Displayed
- SPS Spindle tuning screen
 0 : Not displayed
 1 : Displayed
- SVP Synchronization errors displayed on the spindle tuning screen
 0 : Instantaneous values are displayed.
 1 : Peak-hold values are displayed.
- OPM Operating monitor
 0 : Not displayed
 1 : Displayed
- OPS The speedometer on the operating monitor screen indicates:

- 0 : Spindle motor speed
- 1 : Spindle speed
- NPA Action taken when an alarm is generated or when an operator message is entered
 - 0 : The display shifts to the alarm or message screen.
 - 1 : The display does not shift to the alarm or message screen.

	#7	#6	#5	#4	#3	#2	#1	#0
3112			OPH		EAH	OMH		SGD

NOTE
When this parameter is set, the power must be turned off before operation is continued.

- [Data type] Bit
- SGD Servo waveform
 - 0 : Not displayed
 - 1 : Displayed

NOTE
If SGD is set to 1, no graphic display other than servo waveform display is done.

- OMH The external operator message history screen is:
 - 0 : Not displayed.
 - 1 : Displayed.
- EAH Messages of the external alarm/macro alarm in alarm history:
 - 0 : Not recorded
 - 1 : Recorded
- OPH The operation history log function is:
 - 0 : Displayed.
 - 1 : Enable.









	#7	#6	#5	#4	#3	#2	#1	#0
3113	MS1	MS0						MHC

- [Data type] Bit
- MHC External operator message history data:
 - 0 : Cannot be cleared.
 - 1 : Can be cleared.
- (Such data can be cleared using the [CLEAR] soft key.)
- MS0, MS1 A combination of the number of characters preserved as external operator message history data and the number of history data items is set according to the table below.

MS1	MS0	Number of history data characters	Number of history data items
0	0	255	8
0	1	200	10
1	0	100	18
1	1	50	32

NOTE
 When the values of MS0 and MS1 are changed, all preserved external operator message history data is cleared.

	#7	#6	#5	#4	#3	#2	#1	#0
3114		ICS	IUS	IMS	ISY	IOF	IPR	IPO

- [Data type] Bit
- IPO When the  function key is pressed while the position display screen is being displayed:
 0 : The screen is changed.
 1 : The screen is not changed.
 - IPR When the  function key is pressed while the program screen is being displayed:
 0 : The screen is changed.
 1 : The screen is not changed.
 - IOF When the  function key is pressed while the offset/setting screen is being displayed:
 0 : The screen is changed.
 1 : The screen is not changed.
 - ISY When the  function key is pressed while the system screen is being displayed:
 0 : The screen is changed.
 1 : The screen is not changed.
 - IMS When the  function key is pressed while the message screen is being displayed:
 0 : The screen is changed.
 1 : The screen is not changed.
 - IUS When the  (using small MDI unit) or  (using standard MDI unit) function key is pressed while the custom or graphic screen is being displayed:
 0 : The screen is changed.
 1 : The screen is not changed.
 - ICS When the  (using standard MDI unit) function key is pressed while the custom screen is being displayed:
 0 : The screen is changed.
 1 : The screen is not changed.

	#7	#6	#5	#4	#3	#2	#1	#0
3115					NDFx	SFMx	NDAx	NDPx
		D10x			NDFx		NDAx	NDPx

- [Data type] Bit axis
- NDPx Display of the current position for each axis
 0 : The current position is displayed.
 1 : The current position is not displayed.

- NDAx Position display using absolute coordinates and relative coordinates is:
0 : Performed.
1 : Not performed. (Machine coordinates are displayed.)
- SFMx In current position display, subscripts are:
0 : Added to the absolute, relative, and machine coordinate axis names.
1 : Assed only to the machine coordinate axis names.
- NDFx To the actual speed display, axis movement data is:
0 : Added.
1 : Not added.

NOTE

Even if the PCF parameter (bit 1 of parameter No.3105) is set to 0, so as to add PMC controlled axis movement data to the actual speed display, the movement data for a PMC controlled axis for which NDFx is set to 1 is not added to the actual speed display.

- D10x The current positions (absolute position, relative position, machine position, remaining travel, and travel by manual handle interrupt), and workpiece zero-point offset are:
0 : Displayed as usual. (Not multiplied by ten.)
1 : Multiplied by ten, and displayed.

Example:



The current position on the Y-axis is multiplied by ten and displayed.

X 1.2345 → X 1.2345

Y 1.2345 → Y 12.345

Z 1.2345 → Z 1.2345

	#7	#6	#5	#4	#3	#2	#1	#0
3116	MDC	T8D	COA	FOV		PWR		

- [Data type] Bit
- PWR Alarm No.100 (parameter enable) :
- 0 : Clear by  +  key
- 1 : Clear by  key
- FOV In the field of specified feedrate F on the program check screen,
 0 : The specified feedrate is displayed.
 1 : (Specified feedrate) x (override) is displayed.
- COA While an external alarm state is present or while an external message is being displayed, automatic screen erasure is:
 0 : Performed.
 1 : Not performed.
- T8D T codes that are always displayed are displayed with:
 0 : Four digits.
 1 : Eight digits.
 This parameter expands the T code display to eight digits for the continuous S or T display (bit 2 (DPS) of parameter No. 3105 is set to 1).
- MDC Maintenance information by operating soft key :
 0 : All clear disable.
 1 : All clear enable.

	#7	#6	#5	#4	#3	#2	#1	#0
3117						ANS	SPP	
						ANS		SMS

NOTE
 When this parameter is set, the power must be turned off before operation is continued.

- [Data type] Bit
- SMS On the program check screen, the soft key to enable or disable the graph of spindle speed and load is:
 0 : Not displayed.
 1 : Displayed.
- SPP On the diagnostic screen, spindle position data (the number of pulses from the position coder, detected after the detection of the one-revolution signal) is:
 0 : Not displayed.
 1 : Displayed. (Diagnostic Nos. 445 to 447)
- ANS The subscript of each axis name set in parameter No. 3131 is displayed:
 0 : Only when the current position is displayed.
 1 : On the parameter screen, diagnosis screen, alarm screen, and alarm history screen as well as when the current position is displayed.

	#7	#6	#5	#4	#3	#2	#1	#0
--	----	----	----	----	----	----	----	----

3118							AS2	AS1
------	--	--	--	--	--	--	-----	-----

[Data type] Bit
 AS1 to AS2 When the actual spindle speeds (SACT) of the first spindle and second spindle are displayed, each value is:
 0 : The value calculated based on the feedback pulses from the position coder.
 1 : The value calculated from the spindle motor speed (the same as the spindle speed displayed on the operating monitor screen).

	#7	#6	#5	#4	#3	#2	#1	#0
3119	NVG				TPA		POR	

NOTE
 When this parameter is set, the power must be turned off before operation is continued.

[Data type] Bit
 POR Display in Portuguese is:
 0: Disabled.
 1: Enabled.
 TAP When the external touch panel interface option is available, the external touch panel is:
 0: Enabled.
 1: Disabled.
 NVG When a color display device is used, VGA mode is:
 0: Used.
 1: Not used.

3120	Time from the output of an alarm to the termination of sampling (waveform diagnosis function)
------	--

[Data type] Word
 [Unit of data] ms
 [Valid data range] 1 to 32760
 When the waveform diagnosis function is used, this parameter sets the time form the output of a servo alarm until data collection. Storage operation is stopped because of the alarm. (This means that the termination of data collection can be delayed by a specified time.)

3121	Store-type waveform diagnosis data select (waveform diagnosis function)
------	--

[Data type] Byte
 [Valid data range] 0 to 1
 The six types of sampling data in store-type waveform diagnosis are:
 0 : Thermal simulation data.
 1 : Spindle load meter.

3122	Time interval used to record time data in operation history
-------------	--

[Data type] Word
 [Unit of data] min
 [Valid data range] 0 to 1439
 Time data is recorded in operation history at set intervals.
 When 0 is specified in this parameter, 10 minutes is assumed as the default. However, note that time data is not recorded if there is no data to be recorded at the specified time.

3123	Time until automatic screen clear function is applied
-------------	--

[Data type] Byte
 [Unit of data] min
 [Valid data range] 1 to 255
 This parameter specifies the period that must elapse before the automatic screen clear function is applied.
 This parameter is valid when bit 1 (COK) of parameter No. 3208 is 0. However, the automatic screen clear function is disabled if 0 is set in this parameter.

NOTE
 When the automatic screen clear function is enabled, manual screen clearing with CAN+FUNCTION is disabled.

	#7	#6	#5	#4	#3	#2	#1	#0
3124	D08	D07	D06	D05	D04	D03	D02	D01
	#7	#6	#5	#4	#3	#2	#1	#0
3125	D16	D15	D14	D13	D12	D11	D10	D09
	#7	#6	#5	#4	#3	#2	#1	#0
3126	D24	D23	D22	D21	D20	D19	D18	D17
	#7	#6	#5	#4	#3	#2	#1	#0
3127								D25

[Data type] Bit
 Dxx (xx: 01 to 25) When modal G code is displayed on the program check screen, the xx group G code is:
 0 : Displayed.
 1 : Not displayed.

3131	Subscript of each axis name
-------------	------------------------------------

[Data type] Byte axis
 This parameter specifies a subscript (one character) of each axis name with a code.
 The subscript (one character) specified in this parameter is displayed following the axis name.

NOTE
 For characters and codes, see the correspondence table in Appendix A.

[Example]
 When the axes include X, Z, C, and Y, and the following settings are made, the axis names are displayed as XA, Z1, CS, and Y1:
 Parameter 3131x 65 (A)
 Parameter 3131z 49 (1)
 Parameter 3131c 83 (S)
 Parameter 3131y 49 (1)

3132	Axis name (absolute coordinate) for current position display
-------------	---

3133	Axis name (relative coordinate) for current position display
-------------	---

[Data type] Byte axis
 [Valid data range] 0 to 255
 These parameters set the axis name for current position display. When G code system B or C is used, the axis name set in parameter No.3132 is used for both absolute and relative coordinate axes. The values set in these parameters are used only for display. For a command address, the axis name set in parameter No.1020 is used. When 0 is specified in these parameters, the value set in parameter No.1020 is used.

3134	Axis display order on workpiece coordinate system screen and workpiece shift screen
-------------	--

[Data type] Byte axis
 [Valid data range] 0, 1 to the number of controlled axes
 This parameter specifies the order in which axes are displayed on the workpiece coordinate system screen and workpiece shift screen (for T series).
 When the parameters of all axes are set to 0, all axes are displayed. When the parameters of some axes are set, the axes for which a value of 0 is specified do not appear. The displayed axes are consecutive without spaces being left for non-displayed axes.

3151	Number of the axis for which the 1st load meter for the servo motor is used
3152	Number of the axis for which the 2nd load meter for the servo motor is used
3153	Number of the axis for which the 3rd load meter for the servo motor is used
3154	Number of the axis for which the 4th load meter for servo motor is used

[Data type] Byte
 [Valid data range] 0, 1, . . . , the number of control axes
 Set the numbers of the axes for which measurement values on the load meters for the four servo motors are displayed. Set the parameters to 0 for those axes for which a load meter need not be displayed.

3163	Time required to smooth the spindle load meter readings
-------------	--

[Data type] Byte
 [Unit of data] 32 ms
 [Valid data range] 0 to 32
 When the spindle load meter reading is displayed (see the description of the SLM parameter (bit 6 of parameter No.3108)), smoothing can be applied to the spindle load meter reading to prevent flickering. This parameter sets the time width for smoothing.

Setting	Time for smoothing (msec)
0	256
1	32
2	64
3	96
:	:
32	1024

Each smoothing operation is performed for a time width of between 32 ms and 1024 ms.

	#7	#6	#5	#4	#3	#2	#1	#0
3190		CH2	CZE	SWE	HUN	POL		

NOTE
 When this parameter is set, the power must be turned off before operation is continued.

[Data type] Bit
 POL Display in Polish is:
 0 : Not performed.
 1 : Performed.
 HUN Display in Hungarian is:
 0 : Not performed.
 1 : Performed.
 SWE Display in Swedish is:
 0 : Not performed.
 1 : Performed.
 CZE Display in Czech is:

- 0 : Not performed.
- 1 : Performed.
- CH2 Display in Chinese (simplified Chinese characters)
- 0 : Not performed.
- 1 : Performed.

	#7	#6	#5	#4	#3	#2	#1	#0
3191		CAP	FSS		STS			FPS
		CAP			STS	WKI		

- [Data type] Bit
- FPS The unit of values in the display of actual speeds in feed per revolution mode is:
 - 0 : Feedrate per minute.
 - 1 : Feedrate per spindle rotation.
 This parameter is valid when bit 3 (REV) of parameter No. 3107 is set to 1.
 - WKI On the workpiece coordinate system setting screen, the soft key [INPUT] is:
 - 0 : Displayed.
 - 1 : Not displayed.
 - STS When data is input on the setting screen, a confirmation message is:
 - 0 : Not displayed.
 - 1 : Displayed.
 - FSS The feedrate display is switched:
 - 0 : In accordance with the operation state.
 - 1 : By a DI signal.
 - CAP The position of soft key [ALL] that appears by pressing soft key [ERASE] for clearing offset values on the offset screen is:
 - 0 : Not changed.
 - 1 : Changed.

NOTE

Soft key [ALL] is displayed in the same position as soft key [ERASE]. Therefore, when soft key [ERASE] is pressed twice by mistake, offset data may be all cleared.

Since the position of soft key [ALL] is changed when this parameter is set to 1, it is possible to prevent offset data from being all cleared even when soft key [ERASE] is pressed twice by mistake.

	#7	#6	#5	#4	#3	#2	#1	#0
3192			RDM					

[Data type] Bit
RDM The machine remote diagnostic message notification function is:
 0 : Enabled.
 1 : Disabled.

	#7	#6	#5	#4	#3	#2	#1	#0
3195						CPR		

[Data type] Bit
CPR Pressing the [SYSTEM] function key:
 0 : Displays the parameter setting assistance screen.
 1 : Does not display the parameter setting assistance screen.

	#7	#6	#5	#4	#3	#2	#1	#0
3201	MIP	NPE	N99		PUO	REP	RAL	RDL

[Data type] Bit
RDL When a program is registered by input/output device external control
 0 : The new program is registered following the programs already registered.
 1 : All registered programs are deleted, then the new program is registered. Note that programs which are protected from being edited are not deleted.

RAL When programs are registered through the reader/puncher interface
 0 : All programs are registered.
 1 : Only one program is registered.

REP Action in response to an attempt to register a program whose number is the same as that of an existing program
 0 : An alarm is generated.
 1 : The existing program is deleted, then the new program is registered. Note that if the existing program is protected from being edited, it is not deleted, and an alarm is generated.

PUO When address O of a program number is output in ISO code:
 0 : ":" is output.
 1 : "O" is output.

N99 With an M99 block, when bit 6 (NPE) of parameter No.3201 = 0, program registration is assumed to be:
 0 : Completed
 1 : Not completed

NPE With an M02, M30, or M99 block, program registration is assumed to be:
 0 : Completed
 1 : Not completed

MIP Program registration by external start signal (MINP) :
 0 : Not performed.
 1 : Performed.

	#7	#6	#5	#4	#3	#2	#1	#0
--	----	----	----	----	----	----	----	----

3202		PSR	CPD	NE9	OSR	CND	OLV	NE8
------	--	-----	-----	-----	-----	-----	-----	-----

[Data type]	Bit
NE8	<p>Editing of subprograms with program numbers 8000 to 8999</p> <p>0 : Not inhibited</p> <p>1 : Inhibited</p> <p>The following edit operations are disabled:</p> <ol style="list-style-type: none"> (1) Program deletion (Even when deletion of all programs is specified, programs with program numbers 8000 to 8999 are not deleted.) (2) Program output (Even when outputting all programs is specified, programs with program numbers 8000 to 8999 are not output.) (3) Program number search (4) Program editing of registered programs (5) Program registration (6) Program collation (7) Displaying programs
OLV	<p>When a program other than the selected program is deleted or output:</p> <p>0 : The display of the selected program is not held.</p> <p>1 : The display of the selected program is held.</p>
CND	<p>By using the [CONDENSE] soft key on the program directory screen, the program condensing operation is:</p> <p>0 : Not performed. (The [CONDENSE] soft key is not displayed.)</p> <p>1 : Performed.</p>
OSR	<p>In programming number search, when pressing soft key [O-SEARCH] without inputting program number by key :</p> <p>0 : Search the following program number</p> <p>1 : Operation is invalid</p>
NE9	<p>Editing of subprograms with program numbers 9000 to 9999</p> <p>0 : Not inhibited</p> <p>1 : Inhibited</p> <p>The following program editing during operation is invalid.</p> <ol style="list-style-type: none"> (1) Program deletion (Even when deletion of all programs is specified, programs with program numbers 9000 to 9999 are not deleted.) (2) Program punching (Even when punching of all programs is specified, programs with program numbers 9000 to 9999 are not punched.) (3) Program number search (4) Program editing after registration (5) Program registration (6) Program collation (7) Displaying programs
CPD	<p>When an NC program is deleted, a confirmation message and confirmation soft key are:</p> <p>0 : Not output.</p> <p>1 : Output.</p>
PSR	<p>Search for the program number of a protected program</p> <p>0 : Disabled</p> <p>1 : Enabled</p>

NOTE
If this parameter is set, a protected program is also displayed.

	#7	#6	#5	#4	#3	#2	#1	#0
3203	MCL	MER	MIE					

- [Data type] Bit
- MIE After MDI operation is started, program editing during operation is:
0 : Enabled
1 : Disabled
- MER When the last block of a program has been executed at single block operation in the MDI mode, the executed block is:
0 : Not deleted
1 : Deleted

NOTE
When MER is set to 0, the program is deleted if the end-of-record mark (%) is read and executed. (The mark % is automatically inserted at the end of a program.)

- MCL Whether a program prepared in the MDI mode is cleared by reset
0 : Not deleted
1 : deleted

	#7	#6	#5	#4	#3	#2	#1	#0
3204		MKP				EXK		PAR

- [Data type] Bit
- PAR When a small keyboard is used, characters "[" and "]" are:
0 : Used as "[" and "]"
1 : Used as "(" and ")".
- EXK The input character extension function is:
0 : Not used. ([C-EXT] soft key is displayed.)
1 : Used.

NOTE
The [C-EXT] soft key is used to select an operation on the program screen. This soft key enables the entry of "(", ")", and "@" using soft keys. This soft key is useful when using the small MDI keyboard, which does not have the "(", ")", and "@" keys.

- MKP When M02, M30, or EOR(%) is executed during MDI operation, the created MDI program is:
0 : Erased automatically.
1 : Not erased automatically.

NOTE

If the MER parameter (bit 6 of parameter No.3203) is 1, executing the last block provides a choice of whether to automatically erase a created program.

	#7	#6	#5	#4	#3	#2	#1	#0
3205	MCK		BGC	OSC	PNS	CMO	CHG	COL

- [Data type] Bit
- COL When a program is displayed or output, any colons (:) in the comments of the program are:
 0 : Converted to letter O
 1 : Displayed or output as is
- CHG When the change function of the extended edit function is used:
 0 : Once the user has decided whether to make a change, the cursor is moved to the target position.
 1 : The cursor is moved to the change source, after which the user can choose whether to make a change.
- CMO In extended tape editing, the copy or move operation:
 0 : Is performed in the usual way.
 1 : Can also copy or move data from a program to a key-in buffer in units of words.
- PNS On the program screen, a search by a cursor key is:
 0 : Performed.
 1 : Not performed.
- OSC On the offset screen, offset value erasure by a soft key is:
 0 : Enabled.
 1 : Disabled.
- BGC When background editing starts:
 0 : The edit program is initialized (no program is selected).
 1 : The previous edit program is edited continuously.
 (Continuous editing is allowed only when neither editing nor operation is being performed in the foreground (that is, when continuation is possible).)
- MCK The system tape memory check function is:
 0 : Not used.
 1 : Used. (This setting is inhibited.)

	#7	#6	#5	#4	#3	#2	#1	#0
3206	NS2			PHS			MIF	

- [Data type] Bit
- MIF Editing of the maintenance information screen is:
 0 : Not prohibited.
 1 : Prohibited.
- PHS The selection of an operation history signal and parameters (No. 12801 to No. 128900) are:
 0 : Not linked.
 1 : Linked.
- NS2 The CNC screen display function dual display is:
 0 : Not used.

1 : Used.

	#7	#6	#5	#4	#3	#2	#1	#0
3207								OM4

NOTE
When this parameter has been set, the power must be turned off before operation is continued.

[Data type] Bit
OM4 A message displayed on the external operator message screen can have:
0 : Up to 256 characters, and just a single message can be displayed.
1 : Up to 64 characters, and up to four messages can be displayed.

	#7	#6	#5	#4	#3	#2	#1	#0
3208							COK	SKY

[Data type] Bit
SKY The function key [SYSTEM] on the MDI panel is:
0 : Enabled.
1 : Disabled.
COK The automatic screen erase function is:
0 : Enabled.
1 : Disabled.

NOTE
If this parameter is set to 1, manual screen erasure by the CAN + FUNCTION key is enabled, irrespective of the setting of parameter No. 3123.

	#7	#6	#5	#4	#3	#2	#1	#0
3209				UPP		NFU		MPD

[Data type] Bit
MPD When a subprogram is executed, the main program number is:
0 : Not displayed.
1 : Displayed.
NFU In the screen erase function/automatic screen erase function, when the function key is pressed to erase or display a screen, switching of screen with the function key is:
0 : Performed.
1 : Not performed.
UPP The FOCAS1/ETHERNET cnc_upload3() function:
0 : Does not upload the protected programs.
1 : Uploads the protected programs if a search is possible.

3210	Password							
------	----------	--	--	--	--	--	--	--

[Data type] 2-word axis

This parameter sets a password for protecting program Nos. 9000 to 9999. When a value other than zero is set in this parameter and this value differs from the keyword set in parameter No.3211, bit 4 (NE9) of parameter No.3202 for protecting program Nos. 9000 to 9999 is automatically set to 1. This disables the editing of program Nos. 9000 to 9999. Until the value set as the password is set as a keyword, NE9 cannot be set to 0 and the password cannot be modified.

NOTE

- 1 The state where password \neq 0 and password \neq keyword is referred to as the locked state. When an attempt is made to modify the password by MDI input operation in this state, the warning message "WRITE PROTECTED" is displayed to indicate that the password cannot be modified. When an attempt is made to modify the password with G10 (programmable parameter input), P/S alarm No.231 is issued.
- 2 When the value of the password is not 0, the parameter screen does not display the password. Care must be taken in setting a password.

3211

Keyword

[Data type]

2-word

When the value set as the password (set in parameter No.3210) is set in this parameter, the locked state is released and the user can now modify the password and the value set in bit 4 (NE9) of parameter No.3202.

NOTE

The value set in this parameter is not displayed.
When the power is turned off, this parameter is set to 0.

3216

Increment in sequence numbers inserted automatically

[Data type]
[Valid data range]

The following parameter can be set at "Setting screen".

Word

0 to 9999

Set the increment for sequence numbers for automatic sequence number insertion (when SEQ, #5 of parameter 0000, is set to 1.)

	#7	#6	#5	#4	#3	#2	#1	#0
3232							ND9	ND8

[Data type] Bit

ND8 While program No. 8000 to 8999 is being executed as a subprogram or macro program, display on the program screen is:
 0 : Not disabled.
 1 : Disabled.

ND9 While program No. 9000 to 9999 is being executed as a subprogram or macro program, display on the program screen is:
 0 : Not disabled.
 1 : Disabled.

3241	Character blinking in the AI advanced preview control mode or AI contour control mode (first character)
------	---

3242	Character blinking in the AI advanced preview control mode or AI contour control mode (second character)
------	--

3243	Character blinking in the AI advanced preview control mode or AI contour control mode (third character)
------	---

3244	Character blinking in the AI advanced preview control mode or AI contour control mode (fourth character)
------	--

3245	Character blinking in the AI advanced preview control mode or AI contour control mode (fifth character)
------	---

3246	Character blinking in the AI advanced preview control mode or AI contour control mode (sixth character)
------	---

3247	Character blinking in the AI advanced preview control mode or AI contour control mode (seventh character)
------	---

[Data type] Byte

[Valid data range] 0 to 255

Set the character codes of characters blinking in the AI advanced preview control mode or AI contour control mode.

NOTE

- 1 Set character codes according to the character code list in Appendix A.
- 2 If 0 is set, "AICC" blinks when the AI contour control option is provided, and when the option is not provided, "AIAPC" blinks.

	#7	#6	#5	#4	#3	#2	#1	#0
3290	KEY	MCM		IWZ	WZO	MCV	GOF	WOF

- [Data type] Bit
- WOF Setting the tool offset value by MDI key input is:
 0 : Not disabled
 1 : Disabled (With parameter No.3294 and No.3295, set the offset number range in which updating the setting is to be disabled.)
- GOF Setting the tool offset value by MDI key input is:
 0 : Not disabled
 1 : Disabled (With parameter No.3294 and No.3295, set the offset number range in which updating the setting is to be disabled.)
- MCV Macro variable setting by MDI key input is:
 0 : Not disabled
 1 : Disabled

NOTE

If this parameter is set to 1, input of tool life management data by MDI is also disabled.

- WZO Setting a workpiece zero point offset value by MDI key input is:
 0 : Not disabled
 1 : Disabled
- IWZ Setting a workpiece zero point offset value or workpiece shift value (T-series) by MDI key input in the automatic operation activation or halt state is:
 0 : Not disabled
 1 : Disabled
- MCM The setting of custom macros by MDI key operation is:
 0 : Enabled regardless of the mode.
 1 : Enabled only in the MDI mode.
- KEY For memory protection keys:
 0 : The KEY1, KEY2, KEY3, and KEY4 signals are used.
 1 : Only the KEY1 signal is used.

NOTE

The functions of the signals depend on whether KEY=0 or KEY=1.

When KEY = 0:

- KEY1: Enables a tool offset value and a workpiece zero point offset value to be input.
- KEY2: Enables setting data and macro variables to be input.
- KEY3: Enables program registration and editing.
- KEY4: Enables PMC data (counter and data table) to be input.

When KEY = 1:

- KEY1: Enables program registration and editing, and enables PMC parameter input.
- KEY2 to KEY4: Not used

	#7	#6	#5	#4	#3	#2	#1	#0
3291								WPT

[Data type] Bit
 WPT The input of the tool wear compensation amount is:
 0 : Enabled according to memory protection key signal KEY1.
 1 : Always enabled.

	#7	#6	#5	#4	#3	#2	#1	#0
3292	PK5							

[Data type] Bit
 PK5 The KEYPRM signal (memory protection signal, parameter write setting) is:
 0 : Disabled.
 1 : Enabled.
 If this parameter is set to 1, PWE on the setting screen becomes invalid, and the KEYPRM signal <G046#0> is used to make memory protection and parameter write settings.

3294	Start number of tool offset values whose input by MDI is disabled
3295	Number of tool offset values (from the start number) whose input by MDI is disabled

[Data type] Word

To prevent tool offset values from being changed by MDI key input operation using bit 0 (WOF) of parameter No. 3290 and bit 1 (GOF) of parameter No. 3290, set the inhibited range in this parameter. Set the start offset number of the tool offset values to be protected in parameter No. 3294 and the number of tool offset values from the start in parameter No. 3295.

When 0 or a negative value is set in parameter No.3294 or parameter No.3295, no modification of the tool offset values is allowed.

When the value set with parameter No.3294 is greater than the maximum tool offset count, no modification is allowed.

[Example]

The following setting disables the modification of both the tool geometry compensation values and tool wear compensation values corresponding to offset numbers 51 to 60:

Bit 1 (GOF) of parameter No.3290=1 (Disables tool offset value modification.)

Bit 0 (WOF) of parameter No.3290=1 (Disables tool wear compensation value modification.)

Parameter No.3294 = 51

Parameter No.3295 = 10

If bit 0 (WOF) of parameter No.3290 is set to 0, the modification of the tool offset values alone is disabled. The tool wear compensation values may be modified.

	#7	#6	#5	#4	#3	#2	#1	#0
3301	HDC				HCG	HCA		HCC

[Data type] Bit

HCC In the VGA-compatible mode display,
 0 : A 256-color bit map data of the screen hard copy is created.
 1 : A 16-color bit map data of the screen hard copy is created.

HCA An alarm message related to hard copy is:
 0 : Not displayed.
 1 : Displayed.

HCG In a monochrome bit map,
 0 : Black and white are not inverted. (same as the screen image)
 1 : Black and white are inverted.

HDC A screen hard copy is:
 0 : Not provided.
 1 : Provided.

4.18 PARAMETERS OF PROGRAMS

3401	#7	#6	#5	#4	#3	#2	#1	#0
	GSC	GSB					FCD	DPI
			ABS	MAB				DPI

- [Data type] Bit
- DPI When a decimal point is omitted in an address that can include a decimal point
- 0 : The least input increment is assumed.
 - 1 : The unit of mm, inches, or second is assumed. (Pocket calculator type decimal point input)
- FCD When an F command and a G command (G98, G99) for feed per minute or feed per rotation are specified in the same block, and the G command (G98, G99) is specified after the F command, the F command is:
- 0 : Assumed to be specified in the mode (G98 or G99) when the F command is specified
 - 1 : Assumed to be specified in the mode of the G command (G98 or G99) of the same block

NOTE

1 When FCD = 1:
 If the block containing a G command (G98, G99) does not include an F command, the last F command specified is assumed to be specified in the G command mode of the block.

Example

N1 G99 ;

N2 Faaaa G98 ; - Faaaa is assumed to be specified in the G98 mode.

N3 Fbbbb ; - Fbbbb is assumed to be specified in the G98 mode.

N4 G99 ; - Fbbbb is assumed to be specified in G99 mode.

2 In G code system B or C, G98 and G99 function are specified in G94 and G95.

- MAB Switching between the absolute and incremental commands in MDI operation
- 0 : Performed by G90 or G91
 - 1 : Depending on the setting of ABS, #5 of parameter No.3401
- ABS Program command in MDI operation
- 0 : Assumed as an incremental command
 - 1 : Assumed as an absolute command

NOTE

ABS is valid when MAB, #4 of parameter No.3401, is set to 1.

GSB, GSC The G code system is set.

GSC	GSB	G code
0	0	G code system A
0	1	G code system B
1	0	G code system C

	#7	#6	#5	#4	#3	#2	#1	#0
3402	G23	CLR		FPM	G91			G01
	G23	CLR			G91	G19	G18	G01

[Data type] Bit

G01 Mode entered when the power is turned on or when the control is cleared

- 0 : G00 mode (positioning)
- 1 : G01 mode (linear interpolation)

G18 and G19 Plane selected when power is turned on or when the control is cleared

G19	G18	G17, G18 or G19 mode
0	0	G17 mode (plane XY)
0	1	G18 mode (plane ZX)
1	0	G19 mode (plane YZ)

G91 When the power is turned on or when the control is cleared

- 0 : G90 mode (absolute command)
- 1 : G91 mode (incremental command)

FPM When the power is turned on

- 0 : Feed per revolution on
- 1 : Feed per minute mode

CLR Reset button on the MDI panel, external reset signal, reset and rewind signal, and emergency stop signal

- 0 : Cause reset state.
- 1 : Cause clear state.

For the reset and clear states, refer to Appendix in the Operator's Manual.

G23 When the power is turned on

- 0 : G22 mode (stored stroke check on)
- 1 : G23 mode (stored stroke check off)

	#7	#6	#5	#4	#3	#2	#1	#0
3403		AD2	CIR					

[Data type] Bit

CIR When neither the distance (I, J, K) from a start point to the center nor an arc radius (R) is specified in circular interpolation (G02, G03):

- 0 : The tool moves to an end point by linear interpolation.
- 1 : P/S alarm No.022 is issued.

AD2 Specification of the same address two or more times in a block is:

- 0 : Enabled (Next specification is enabled.)
- 1 : Disabled (P/S alarm No.5074)

NOTE

- 1 When 1 is set, specifying two or more G codes of the same group in a block will also result in an alarm being issued.
- 2 Up to three M codes can be specified in a single block, when bit 7 (M3B) of parameter No.3404 is set to 1.

	#7	#6	#5	#4	#3	#2	#1	#0
3404	M3B	EOR	M02	M30		SBP	POL	
	M3B	EOR	M02	M30		SBP	POL	NOP

- [Data type] Bit
- NOP When a program is executed, a block consisting of an O number, EOB, or N number is:
 0 : Not ignored, but regarded as being one block.
 1 : Ignored.
 - POL For a command address allowing a decimal point, omission of the decimal point is:
 0 : Enabled
 1 : Disabled (P/S alarm No.5073)
 - SBP Address P of the block including M198 in the subprogram call function
 0 : Indicating a file number
 1 : Indicating a program number
 - M30 When M30 is specified in a memory operation:
 0 : M30 is sent to the machine, and the head of the program is automatically searched for. So, when the ready signal FIN is returned and a reset or reset and rewind operation is not performed, the program is executed, starting from the beginning.
 1 : M30 is sent to the machine, but the head of the program is not searched for. (The head of the program is searched for by the reset and rewind signal.)
 - M02 When M02 is specified in memory operation
 0 : M02 is sent to the machine, and the head of the program is automatically searched for. So, when the end signal FIN is returned and a reset or reset and rewind operation is not performed, the program is executed, starting from the beginning.
 1 : M02 is sent to the machine, but the head of the program is not searched for.
 - EOR When the end-of-record mark (%) is read during program execution:
 0 : P/S alarm No.5010 occurs. (Automatic operation is stopped, and the system enters the alarm state.)
 1 : No alarm occurs. (Automatic operation is stopped, and the system is reset.)
 - M3B The number of M codes that can be specified in one block
 0 : One
 1 : Up to three

	#7	#6	#5	#4	#3	#2	#1	#0
3405	QAB	QLG	DDP	CCR	G36	PPS	DWL	AUX

								DWL	AUX
--	--	--	--	--	--	--	--	-----	-----

[Data type]	Bit
AUX	The least increment of the command of the second miscellaneous function specified with a decimal point 0 : Assumed to be 0.001 1 : Depending on the input increment. (For input in mm, 0.001 is assumed, or for input in inches, 0.0001 is assumed.)
DWL	The dwell time (G04) is: 0 : Always dwell per second. 1 : Dwell per second in the feed per minute mode, or dwell per rotation in the feed per rotation mode.
PPS	The passing-point signal output function is: 0 : Not used 1 : Used
CCR	Addresses used for chamfering and corner rounding 0 : Address used for chamfering and corner rounding is "I" or "K", not "C". In direct drawing dimension programming, addresses ",C", ",R", and ",A" (with comma) are used in stead of "C", "R", and "A". 1 : Addresses used for chamfering, corner rounding, and direct drawing dimension programming are "C", "R", and "A" without comma. Thus, addresses A and C cannot be used as the names of axes.
DDP	Angle commands by direct drawing dimension programming 0 : Normal specification 1 : A supplementary angle is given.
QLG	When the passing-point signal output function is used, the remaining distance to be traveled specified in address ",Q" is: 0 : The combined distance of all axes 1 : The distance of the longest axis

NOTE

This parameter is valid when bit 7 (QAB) of parameter No.3405 = 0.

QAB	When the passing-point signal output function is used, address ",Q" specifies: 0 : Remaining distance to be traveled 1 : Coordinate value of the longest axis
-----	---

3406	#7	#6	#5	#4	#3	#2	#1	#0
	C07		C05	C04	C03	C02	C01	
	C07		C05	C04	C03	C02	C01	

3407	#7	#6	#5	#4	#3	#2	#1	#0
		C14			C11	C10		C08
	C15	C14	C13		C11	C10	C09	C08

3408	#7	#6	#5	#4	#3	#2	#1	#0
								C16
				C20	C19	C18	C17	C16

3409	#7	#6	#5	#4	#3	#2	#1	#0
	CFH							

[Data type] Bit
 Cxx (xx: 01 to 20) When bit 6 (CLR) of parameter No.3402 is 1, the reset button on the MDI panel, the external reset signal, the reset and rewind signal, or emergency stop will,
 0 : Clear the G code with group number xx.
 1 : Not clear the G code with group number xx.

CFH When bit 6 (CLR) of parameter No.3402 is 1, the reset button on the MDI panel, the external reset signal, the reset and rewind signal, or emergency stop will,
 0 : Clear F codes, H codes (for the M series), D codes (for the M series), and T codes (for the T series).
 1 : Not clear F codes, H codes (for the M series), D codes (for the M series), and T codes (for the T series).

3410	Tolerance of arc radius
------	-------------------------

[Data type] 2-word
 [Unit of data]

Input increment	IS-A	IS-B	IS-C	Unit
Millimeter input	0.01	0.001	0.0001	mm
Inch input	0.001	0.0001	0.00001	inch

[Valid data range] 1 to 99999999
 When a circular interpolation command (G02, G03) is executed, the tolerance for the radius between the start point and the end point is set. If the difference of radii between the start point and the end point exceeds the tolerance set here, a P/S alarm No.20 is informed.

NOTE
 When the set value is 0, the difference of radii is not checked.

3411	M code preventing buffering 1
3412	M code preventing buffering 2
3413	M code preventing buffering 3
:	:
3420	M code preventing buffering 10

[Data type] Byte
 [Valid data range] 0 to 255
 Set M codes that prevent buffering the following blocks. If processing directed by an M code must be performed by the machine without buffering the following block, specify the M code. M00, M01, M02, and M30 always prevent buffering even when they are not specified in these parameters.

3421	Minimum value 1 of M code preventing buffering
3422	Maximum value 1 of M code preventing buffering
3423	Minimum value 2 of M code preventing buffering
3424	Maximum value 2 of M code preventing buffering
3425	Minimum value 3 of M code preventing buffering
3426	Maximum value 3 of M code preventing buffering
3427	Minimum value 4 of M code preventing buffering
3428	Maximum value 4 of M code preventing buffering
3429	Minimum value 5 of M code preventing buffering
3430	Maximum value 5 of M code preventing buffering
3431	Minimum value 6 of M code preventing buffering
3432	Maximum value 6 of M code preventing buffering

[Data type] Word
 [Valid data range] 0 to 65535
 When a specified M code is within the range specified with parameter Nos. 3421 and 3422, 3423 and 3424, 3425 and 3426, 3427 and 3428, 3429 and 3430, or 3431 and 3432, buffering for the next block is not performed until the execution of the block is completed.

NOTE

- 1 The specification of a minimum value that exceeds the specified maximum value is invalid.
- 2 When there is only one data item, set the following:
 minimum value = maximum value.

3435	
	Central angle limit of circular with R specification

[Data type] Byte
 [Unit of data] 1°
 [Valid data range] 0 to 180

Set a central angle limit that can be permitted in commands for circular interpolation with R specification (G02 and G03). If circular interpolation of which central angle exceeds the limit is specified, P/S alarm No.23 is issued.

If this parameter is set to 0, the radius R specification alarm function is disabled.

3450	#7	#6	#5	#4	#3	#2	#1	#0
				NPS	CQD			
	BDX				CQD			AUP

[Data type] Bit
 AUP When a command for the second miscellaneous function contains a decimal point or negative sign:
 0 : The command is invalid.
 1 : The command is valid.

NOTE

For the T series, a decimal point and negative sign are supported for commands for the second miscellaneous function, regardless of the setting made with this parameter.

- CQD** The method used for determining the amount of travel in circular interpolation is:
 0 : Series 16 type.
 1 : Series 15 type.
- NPS** A block that contains M98 Pxxx or M99, and which contains no addresses other than O and N functions:
 0 : As a one-block NC statement involving no movement.
 (A single-block stop is caused.)
 1 : As a macro statement.
 (A single-block stop is not caused. Moreover, the block is not regarded as a block involving no movement in tool-tip radius compensation mode.)
- BDX** A decimal point specified with address B is handled:
 0 : In the conventional way.
 1 : In the same way as in a system equipped with the second auxiliary function.
- In a system without second auxiliary function, the decimal point specified with address B can be handled as in a system equipped with the second auxiliary function. The following parameters can be used:
- Bit 0 (AUP) of parameter No. 3450
 - Bit 0 (AUX) of parameter No. 3405

	#7	#6	#5	#4	#3	#2	#1	#0
3451								
				NBN	CCK	SDP		GQS

- [Data type] Bit
- GQS When G33 is specified, the threading start angle shift function (Q) is:
 0 : Disabled.
 1 : Enabled.
- SDP The function to specify an S command with decimal point is:
 0 : Not used.
 1 : Used.
 An S command with one decimal place can be specified. However, the S command value is rounded off to the nearest whole number.
 Example:
 Relationships between specified value and S code output/alarm
 S200.5 -> S code output value = 201
 S200.2 -> S code output value = 200
 S200.12 -> P/S007 alarm is raised.
- CCK If chamfering or corner R is enabled and if the end point specified in an arc command is not complete,
 0 : No alarm is raised.
 1 : An alarm (P/S058 alarm) is raised.
 This parameter specifies whether an alarm is raised if chamfering or corner R is enabled, if the end point specified in an arc command is not complete, and if an address is omitted.
 If the end point is omitted in an arc command, chamfering or corner R may affect the omitted point, and the operation may not be performed as intended by the programmer. If this parameter is specified, an alarm can be raised for that type of program execution.
- NBN If bit 0 (NOP) of parameter No. 3404 is set to 1, a block including just N (sequence number) is:
 0 : Ignored.
 1 : Not ignored but handled as a single block.

	#7	#6	#5	#4	#3	#2	#1	#0
3453								CRD

- [Data type] Bit
- CRD If the functions of chamfering or corner R and direct drawing dimension programming are both enabled,
 0 : Chamfering or corner R is enabled.
 1 : Direct drawing dimension programming is enabled.
 If the functions of chamfering or corner R and direct drawing dimension programming are both specified, this parameter specifies which function is used.
 This parameter is displayed also on the setting screen. ("CHAMFERING/DIRECT DRAWING DIMENSION PROGRAMMING") The function to be enabled can be changed from the setting screen or parameter screen.

	#7	#6	#5	#4	#3	#2	#1	#0
3454								RF2

[Data type] Bit
 RF2 Reference position return commands G28.2 and G30.2, which suppress in-position checks during reference position return, are:
 0 : Invalid.
 1 : Valid.

	#7	#6	#5	#4	#3	#2	#1	#0
3455								
								AXDx

[Data type] Bit axis
 AXDx If a decimal point is omitted for an address with which a decimal point can be used, the value is determined:
 0 : In accordance with the least input increment.
 1 : In millimeters, inches, or seconds. (calculator-type decimal point input)

NOTE

- 1 This parameter is valid if bit 0 (DPI) of parameter No. 3401 is set to 0.
- 2 Because some addresses (such as R and K) are not related to an axis, setting this parameter for all axes is not equivalent to setting bit 0 (DPI) of parameter No. 3401 to 1.
- 3 This parameter cannot be used together with:
 - Macro executor
 - Basic operation package
 - Macro call argument

3460	
	Address for second miscellaneous function

[Data type] Byte
 This parameter specifies the address used for the second miscellaneous function, as follows:

Address	A	B	C	U	V	W
Set value	65	66	67	85	86	87

Address B is assumed when a value other than the above is set.
 Axes names cannot be used to specify the address.

4.19 PARAMETERS OF PITCH ERROR COMPENSATION

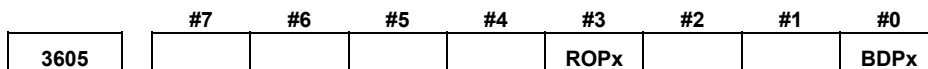

NOTE
When this parameter has been set, the power must be turned off before operation is continued.

[Data type] Bit
BDPx Both-direction pitch error compensation is:
0 : Not used.
1 : Used.

NOTE
The function of both-direction pitch error compensation is required.

ROPx The interval of pitch error compensation for a rotation axis (type A) is:
0 : Restricted by the following equation:
Minimum value = maximum feedrate (rapid traverse rate)/7500.
1 : Not restricted by the following equation:
Minimum value = maximum feedrate (rapid traverse rate)/7500.

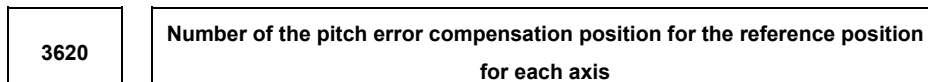

NOTE
When this parameter is set, the power must be turned off before operation is continued.

[Data type] Word axis
[Unit of data] Number
[Valid data range] 0 to 1023
Set the number of the pitch error compensation position for the reference position for each axis.

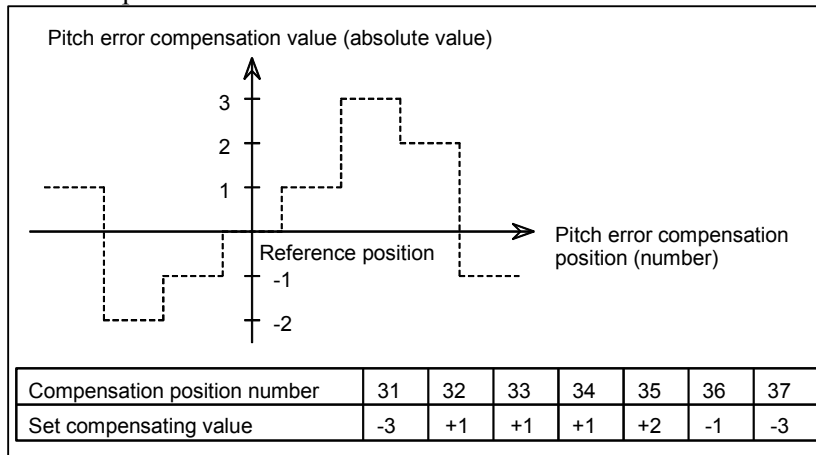

**Fig.4.19 Pitch error compensation position number and value
(example)**

In the above example, set 33 as the number of the pitch error compensation position for the reference position.

3621

**Number of the pitch error compensation position at extremely negative
position for each axis**

NOTE

When this parameter is set, the power must be turned off before operation is continued.

[Data type]
[Unit of data]
[Valid data range]

Word axis

Number

0 to 1023

Set the number of the pitch error compensation position at the extremely negative position for each axis.

3622

**Number of the pitch error compensation position at extremely positive
position for each axis**

NOTE

When this parameter is set, the power must be turned off before operation is continued.

[Data type]
[Unit of data]
[Valid data range]

Word axis

Number

0 to 1023

Set the number of the pitch error compensation position at the extremely positive position for each axis.

This value must be larger than set value of parameter (No.3620).

3623 Magnification for pitch error compensation for each axis

NOTE
When this parameter is set, the power must be turned off before operation is continued.

[Data type] Byte axis
 [Unit of data] 1
 [Valid data range] 0 to 100
 Set the magnification for pitch error compensation for each axis. If the magnification is set to 1, the same unit as the detection unit is used for the compensation data. If 0 is set, the same magnification selected by setting 1 is selected.

3624 Interval between pitch error compensation positions for each axis

NOTE
When this parameter is set, the power must be turned off before operation is continued.

[Data type] 2-word axis
 [Unit of data]

Input increment	IS-A	IS-B	IS-C	Unit
Millimeter machine	0.01	0.001	0.0001	mm
Inch machine	0.001	0.0001	0.00001	inch
Rotation axis	0.01	0.001	0.0001	deg

[Valid data range] 0 to 99999999
 The pitch error compensation positions are arranged with equal spacing. The space between two adjacent positions is set for each axis. The minimum interval between pitch error compensation positions is limited and obtained from the following equation:
 Minimum interval between pitch error compensation positions = maximum feedrate (rapid traverse rate)/7500
 Units:

Minimum interval between pitch error compensation positions:
 mm, inch, deg
 Maximum feedrate: mm/min, inch/min, deg/min

Example:
 When the maximum feedrate is 15000 mm/min, the minimum interval between pitch error compensation positions is 2 mm. If setting a magnification causes the absolute value of the compensation amount at a compensation position to exceed 100, enlarge the interval between the compensation positions by using a multiple calculated as follows:

$$\text{Multiple} = \frac{\text{maximum compensation amount (absolute value)}}{128}$$

(Round the remainder up to the nearest integer.)

$$\text{Minimum interval between pitch error compensation positions} = \text{Value obtained from the above maximum feedrate} \times \text{multiple}$$

[Example 1] For linear axis
 • Machine stroke: -400 mm to + 800 mm

- Interval between the pitch error compensation positions: 50 mm
 - No. of the compensation position of the reference position: 40
- If the above is specified, the No. of the farthest compensation point in the negative direction is as follows:

$$\begin{aligned} &\text{No. of the compensation position of the reference position -} \\ &(\text{Machine stroke length in the negative direction/Interval between the} \\ &\text{compensation points}) + 1 \\ &= 40 - 400/50 + 1 \\ &= 33 \end{aligned}$$

No. of the farthest compensation position in the positive direction is as follows:

$$\begin{aligned} &\text{No. of the compensation position of the reference position +} \\ &(\text{Machine stroke length in the positive direction/Interval between the} \\ &\text{compensation positions}) \\ &= 40 + 800/50 \\ &= 56 \end{aligned}$$

The correspondence between the machine coordinate and the compensation position No. is as follows:

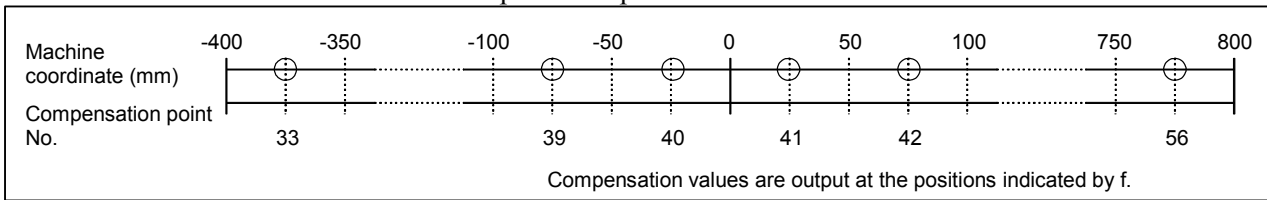

Therefore, set the parameters as follows:

Parameter	Setting
No. 3620: Compensation point number for reference position	40
No. 3621: Compensation point number for farthest point in the negative direction	33
No. 3622: Compensation point number for farthest point in the positive direction	56
No. 3623: Compensation magnification	1
No. 3624: Compensation point interval	50000

The compensation value is output at the compensation position No. corresponding to each section between the coordinates.

The following is an example of the compensation values.

No.	33	34	35	36	37	38	39	40	41	42	43	44	45	46	47	48	49
Compensation values	+2	+1	+1	-2	0	-1	0	-1	+2	+1	0	-1	-1	-2	0	+1	+2

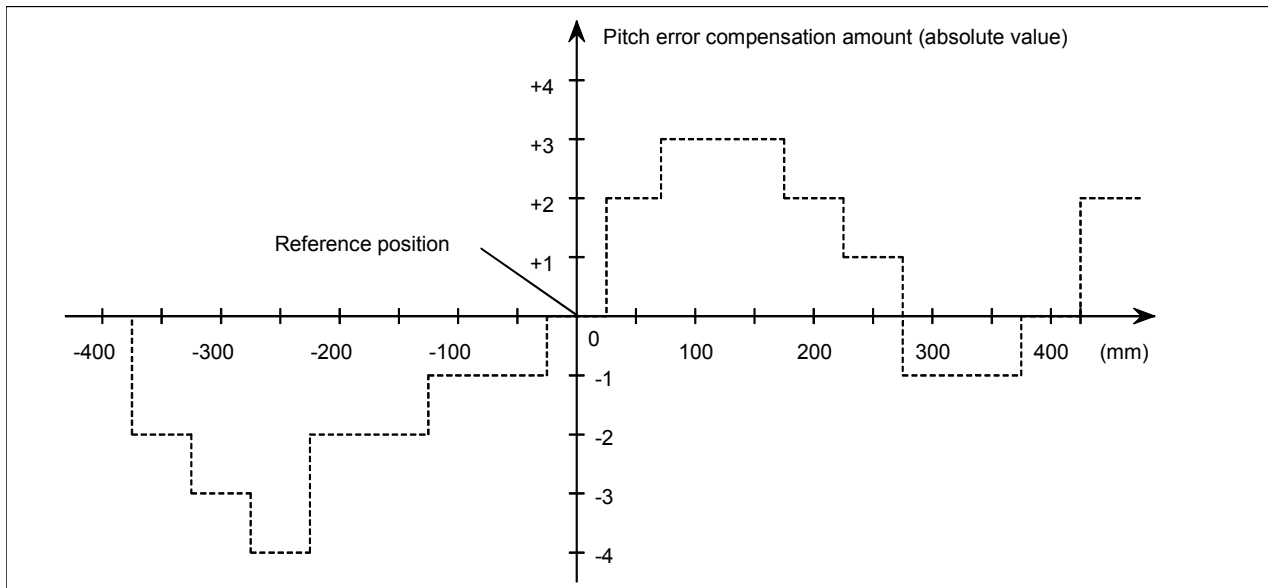

[Example 2] For the rotation axis

- Amount of movement per rotation: 360°
- Interval between pitch error compensation position: 45°
- No. of the compensation position of the reference position: 60

If the above is specified, the No. of the farthest compensation position in the negative direction for the rotation axis is always equal to the compensation position No. of the reference position.

The No. of the farthest compensation position in the positive direction is as follows:

$$\begin{aligned} &\text{No. of the compensation position of the reference position} + \\ &(\text{Move amount per rotation} / \text{Interval between the compensation position}) \\ &= 60 + 360 / 45 \\ &= 68 \end{aligned}$$

The correspondence between the machine coordinate and the compensation position No. is as follows:

The compensation value is output at the circled position.

If the sum of the compensation value from 61 to 68 is not zero, the pitch error per rotation accumulates, resulting in a positional shift.

For compensation position 60, set the same compensation value as for 68.

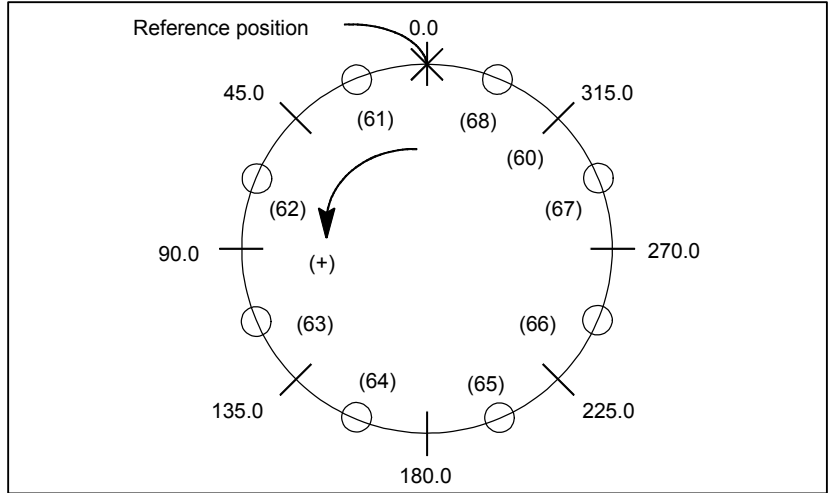

Set the parameters as follows:

Parameter	Setting
No. 3620: Compensation point number for reference position	60
No. 3621: Compensation point number for farthest point in the negative direction	60
No. 3622: Compensation point number for farthest point in the positive direction	68
No. 3623: Compensation magnification	1
No. 3624: Compensation point interval	45000

The following is an example of compensation values.

No. of the compensation position	60	61	62	63	64	65	66	67	68
Compensation value	+1	-2	+1	+3	-1	-1	-3	+2	+1

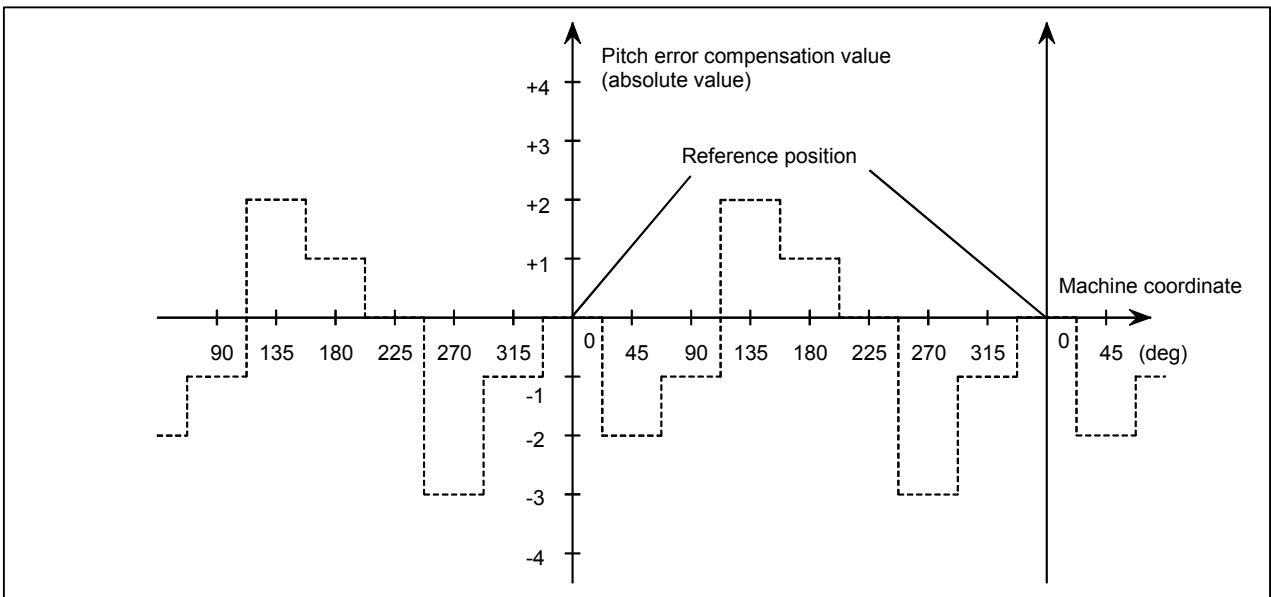

3625

Travel distance per revolution in pitch error compensation of rotation axis type

NOTE

When this parameter has been set, the power must be turned off before operation is continued.

[Data type]
[Valid data range]

2-word axis

0 to 99999999

If the pitch error compensation of rotation axis type is performed (bit 1 (ROSx) of parameter No. 1006 is set to 0 and bit 0 (ROTx) of parameter No. 1006 is set to 1), set the travel distance per revolution. The travel distance per revolution does not have to be 360 degrees, and a cycle of pitch error compensation of rotation axis type can be set.

However, the travel distance per revolution, compensation interval, and number of compensation points must satisfy the following condition:

$$(\text{Travel distance per revolution}) = (\text{Compensation interval}) \times (\text{Number of compensation points})$$

The compensation at each compensation point must be set so that the total compensation per revolution equals 0.

NOTE

- 1 If 0 is set, the travel distance per revolution becomes 360 degrees.
- 2 When setting a value other than 360 (and 0) degrees, set the same value as the value set in parameter No. 1260.

3626

Number of pitch error compensation point at the farthest end in the negative direction (for movement in the negative direction)

NOTE

When this parameter has been set, the power must be turned off before operation is continued.

[Data type]
[Unit of data]
[Valid data range]

Word axis

Number

0 to 1023, 3000 to 4023

When using both-direction pitch error compensation, set the number of pitch error compensation point at the farthest end in the negative direction for a movement in the negative direction.

NOTE

- 1 For a movement in the positive direction, set the compensation point number at the farthest end in the negative direction in parameter No. 3621.
- 2 A set of compensation data items for a single axis should not be set to lie astride 1023 and 3000.

3627

Pitch error compensation (absolute value) at reference position when a movement to the reference position is made from the direction opposite to the direction of reference position return

NOTE

When this parameter has been set, the power must be turned off before operation is continued.

[Data type]
[Unit of data]
[Valid data range]

Word axis

Detection unit

-32768 to 32767

Set the absolute value of pitch error compensation at reference position when a movement to the reference position is made from the negative direction if the direction of reference position return (bit 5 (ZMI) of parameter No. 1006) is positive or from the positive direction if the direction of reference position return is negative.

4.20 PARAMETERS OF SPINDLE CONTROL

	#7	#6	#5	#4	#3	#2	#1	#0
3700	ESP		ESV	MSE			NRF	

[Data type] Bit
 NRF The first move command (such as G00 and G01) after the serial spindle is switched to Cs axis contouring control performs:
 0 : Positioning after returning to the reference position.
 1 : Normal positioning.

NOTE
 When using the Cs axis establishment function, this parameter is recommended to be set to 1.

MSE Rigid tapping synchronization error data output when bit 5 (ESV) of parameter No. 3700 is set to 1 or when bit 7 (ESP) of parameter No. 3700 is set to 1 is:
 0 : A synchronization error in the positional deviation. (equivalent to DGN No. 456)
 1 : A synchronization error in the machine position. (equivalent to DGN No. 459)

ESV When bit 7 (ESP) of parameter No. 3700 is set to 1, rigid tapping synchronization error data is:
 0 : Not output to the servo system.
 1 : Output to the servo system.

NOTE
 Set this parameter as necessary when making servo and spindle adjustments by using a servo guide and so forth. After completing adjustments, reset this parameter to 0.

ESP Rigid tapping synchronization error data is:
 0 : Not output to the spindle.
 1 : Output to the spindle.

NOTE
 Set this parameter as necessary when making servo and spindle adjustments by using a servo guide and so forth. After completing adjustments, reset this parameter to 0.

	#7	#6	#5	#4	#3	#2	#1	#0
3701				SS2			ISI	

NOTE

When this parameter is set, the power must be turned off before operation is continued.

[Data type] Bit

ISI The serial interface for the first and second spindles are:
 0 : Used.
 1 : Not used.

NOTE

- 1 This parameter is valid when the spindle serial output option is provided.
- 2 It is used when the CNC is started with serial interface control for the first and second serial spindles disabled temporarily (for example, for CNC startup adjustment).
- 3 Usually, it should be set to 0.
- 4 If this parameter is set to 1 when using the serial spindle and analog spindle at the same time, the analog spindle is set the first axis.

SS2 In serial spindle control, the second spindle is:
 0 : Not used.
 1 : Used.

NOTE

- 1 This parameter is valid, when the spindle serial output option is provided and parameter ISI(bit 1 of parameter No.3701)is 0.
- 2 (a) Confirmation of connection of the second serial spindle amplifier, and communication with it
 (b) Control of the second spindle during asynchronous control (SIND2)
 When this parameter is set, it is also necessary to set the serial spindle parameter for the second spindle.

	#7	#6	#5	#4	#3	#2	#1	#0
3702					OR2	OR1		

NOTE
When this parameter is set, the power must be turned off before operation is continued.

- [Data type] Bit
- OR1 Whether the stop-position external-setting type orientation function is used by the first spindle motor
0 : Not used
1 : Used
 - OR2 Whether the stop-position external-setting type orientation function is used by the second spindle motor
0 : Not used
1 : Used

	#7	#6	#5	#4	#3	#2	#1	#0
3703					MPP			

NOTE
When this parameter is set, the power must be turned off before operation is continued.

- [Data type] Bit
- MPP Under multi-spindle control, the spindle is not selected by a spindle signal (SWS1 to SWS3 <G027 bits 0 to 2>), and a programmed command (address P) is:
0 : Not used.
1 : Used.

NOTE
If this parameter is set to 1, set parameters No. 3781 to No. 3783 as well.

	#7	#6	#5	#4	#3	#2	#1	#0
3704	CSS			SSS				

NOTE
 When this parameter has been set, the power must be turned off before operation is continued.

[Data type] Bit

- SSS** Synchronous spindle control by each spindle is:
 0 : Not performed.
 1 : Performed.
 The master axis and slave axis of synchronous spindle control can be selected from the first to second spindles.
 The target spindle of synchronous spindle control is specified in parameters No. 4831 to 4832.
 In addition, the following signals affect the control.
 Synchronous spindle signal of each spindle
 SPSYC1 to SPSYC2 <G288 bits 0 to 1>
 Signal of synchronous control of the spindle phase for each spindle
 SPPHS1 to SPPHS2 <G289 bits 0 to 1>
- CSS** On the second spindle, Cs contour control is:
 0 : Not performed.
 1 : Performed.
 If Cs contour control is performed on each spindle as specified by this parameter, set parameter No. 1023 as indicated below.
 Setting
 -1 = Axis of Cs contour control by the first spindle
 -2 = Axis of Cs contour control by the second spindle

NOTE
 1 A single spindle cannot be specified as multiple axes of Cs contour control.
 2 This parameter cannot be used with the spindle positioning function. When using the spindle positioning function, set bit 7 (CSS) of parameter No. 3704 to 0.

	#7	#6	#5	#4	#3	#2	#1	#0
3705				EVS				ESF
		SFA	NSF		SGT	SGB	GST	ESF

[Data type] Bit

- ESF** When the spindle control function (Spindle analog output or Spindle serial output) is used, and the constant surface speed control function is used or bit 4 (GTT) of parameter No.3705 is set to 1:
 0 : S codes and SF are output for all S commands.
 1 : S codes and SF are not output for an S command in constant surface speed control mode (G96 mode) or for an S command used to specify maximum spindle speed clamping (G50S---;)

NOTE

For the T series, this parameter is enabled when bit 4 (EVS) of parameter No.3705 is set to 1.

For the M series, SF is not output:

- (1) For an S command used to specify maximum spindle speed clamping (G92S---;) in constant surface speed control mode
- (2) When bit 5 (NSF) of parameter No.3705 is set to 1

- GST The SOR signal is used for:
 0 : Spindle orientation
 1 : Gear shift

NOTE

If the function of constant surface speed control or bit 4 (GTT) of parameter No. 3706 is specified, this parameter is invalid.

- SGB Gear switching method
 0 : Method A (Parameters 3741 to 3743 for the maximum spindle speed at each gear are used for gear selection.)
 1 : Method B (Parameters 3751 and 3752 for the spindle speed at the gear switching point are used for gear selection.)
- SGT Gear switching method during tapping cycle (G84 and G74)
 0 : Method A (Same as the normal gear switching method)
 1 : Method B (Gears are switched during tapping cycle according to the spindle speed set in parameters 3761 and 3762).
- EVS When the spindle control function (Spindle analog output or Spindle serial output) is used, S codes and SF are:
 0 : Not output for an S command.
 1 : Output for an S command.

NOTE

The output of S codes and SF for an S command in constant surface speed control mode (G96), or for an S command used to specify maximum spindle speed clamping (G50S---;) depends on the setting of bit 0 (ESF) of parameter No.3705.

- NSF If the function of constant surface speed control is specified or if bit 4 (GTT) of parameter No. 3706 is set to 1 and when an S code is specified,
 0 : SF is output.
 1 : SF is not output.
- SFA The SF signal is output:
 0 : When gears are switched.
 1 : Irrespective of whether gears are switched.

3706	#7	#6	#5	#4	#3	#2	#1	#0
	TCW	CWM	ORM				PG2	PG1
	TCW	CWM	ORM	GTT			PG2	PG1

[Data type]
PG2 and PG1

Bit
Gear ratio of spindle to position coder

Magnification	PG2	PG1
×1	0	0
×2	0	1
×4	1	0
×8	1	1

$$\text{Magnification} = \frac{\text{Number of spindle revolutions}}{\text{Number of position coder revolutions}}$$

GTT Selection of a spindle gear selection method
 0: Type M.
 1: Type T.

NOTE

- 1 The gear selection method differs as described below. For details, refer to the description of spindle control in the connection manual (function part).
 Type M:
 The CNC determines a proper gear from the parameter setting and S command value, and requests the PMC to specify the gear and its switching.
 In addition, spindle control is exercised according to a gear selected by the CNC.
 Type T:
 The CNC exercises spindle control according to a gear selected by the PMC.
- 2 When the constant surface speed control option is selected, type T is selected, regardless of whether this parameter is specified.
- 3 When type T spindle gear switching is selected, the following parameters have no effect:
 No.3705#2 SGB, No.3751, No.3752, No.3705#3 SGT,
 No.3761, No.3762, No.3705#6 SFA, No.3735, No.3736
 On the other hand, parameter No. 3744 becomes usable for ordinary spindle control.

ORM Voltage polarity during spindle orientation
 0: Positive
 1: Negative

TCW, CWM Voltage polarity when the spindle speed voltage is output

TCW	CWM	Voltage polarity
0	0	Both M03 and M04 positive
0	1	Both M03 and M04 negative

1	0	M03 positive, M04 negative
1	1	M03 negative, M04 positive

	#7	#6	#5	#4	#3	#2	#1	#0
3707							P22	P21

[Data type] Bit
P22 and P21 Gear ratio of spindle to second position coder

Magnification	P22	P21
×1	0	0
×2	0	1
×4	1	0
×8	1	1

$$\text{Magnification} = \frac{\text{Number of spindle revolutions}}{\text{Number of position coder revolutions}}$$

NOTE
This parameter is valid when the multi-spindle control option is selected.

	#7	#6	#5	#4	#3	#2	#1	#0
3708		TSO	SOC	SVD			SAT	SAR
		TSO	SOC	SVD				SAR

[Data type] Bit
SAR The spindle speed arrival signal is:
0 : Not checked
1 : Checked
SAT Check of the spindle speed arrival signal at the start of executing the thread cutting block
0 : The signal is checked only when SAR, #0 of parameter 3708, is set.
1 : The signal is always checked irrespective of whether SAR is set.

NOTE
When thread cutting blocks are consecutive, the spindle speed arrival signal is not checked for the second and subsequent thread cutting blocks.

SVD When the SIND signal is on, the detection of spindle speed fluctuation is:
0 : Disabled
1 : Enabled
SOC During constant surface speed control (G96 mode), the speed clamp by the maximum spindle speed clamp command (M series: G92 S_; T series: G50 S_) is carried out:
0 : Before spindle speed override.
1 : After spindle speed override.
If this parameter is set to 0, the spindle speed may exceed the maximum spindle speed (numeric value following S in G92 S_; (M series) or G50 S_; (T series)).
If this parameter is set to 1, the spindle speed is limited to the maximum spindle speed.

The spindle speed is limited to the upper limit of spindle speed specified in parameter No. 3772, irrespective of the setting of this parameter.

TSO During a threading or tapping cycle, the spindle override is:
 0 : Disabled (tied to 100%).
 1 : Enabled.

NOTE
 During rigid tapping, the override is tied to 100%, irrespective of the setting of this parameter.

	#7	#6	#5	#4	#3	#2	#1	#0
3709	THB				MRS	MSI	RSC	SAM
				SMC			RSC	

- [Data type] Bit
- SAM The sampling frequency to obtain the average spindle speed
 0 : 4 (Normally, set to 0.)
 1 : 1
- RSC In the constant surface speed control mode, the surface speed of a rapid traverse block is calculated:
 0 : In accordance with the coordinates of the end point.
 1 : In accordance with the current value, as in cutting feed.
- MSI In multi-spindle control, the SIND signal is valid
 0 : Only when the first spindle is valid (SIND signal for the 2nd, 3rd spindle becomes ineffective)
 1 : For each spindle irrespective of whether the spindle is selected (Each spindle has its own SIND signal).
- MRS When the S 12-bit code signals and actual spindle speed signals are output in multi-spindle control:
 0: Signals common to the first through second spindles are used. In this case, information about a spindle selected by the spindle selection signal (SWS1-SWS2<G027#0-#1>) is output.
 1: Information about each of the first through third spindles is output on individual signals.

Signal	When MRS is set to 0	When MRS is set to 1
S 12-bit code signals R010-R120<F036,F037> Actual spindle speed signals AR0-AR15<F040,F041>	First spindle (SWS1 = 1) Second spindle (SWS1 = 0, SWS2 = 1)	First spindle
S 12-bit code signals 2 R0103-R1202<F200,F201> Actual spindle speed signals 2 AR200-AR215<F202,F203>	-	Second spindle

NOTE
 To use this parameter, the multi-spindle control option and spindle serial output are required.

SMC The function to check a large S command is:

0 : Not used.
 1 : Used.

If a spindle gear of M type is selected, this function compares the specified S value and the settings of parameters No. 3741 to No. 3743 and raises an alarm if the S value is greater.

If this function is used, specifying an S value larger than the settings of parameters No. 3741 to No. 3743 causes P/S alarm 5310 to be raised.

NOTE
 This function cannot be used together with any of bit 4 (GTT) of parameter No. 3706, constant surface speed control, or multi-spindle control.

THB The threading start type is:
 0 : Type A.
 1 : Type B.

NOTE
 When using PMC axis control, set this parameter to 1.

	#7	#6	#5	#4	#3	#2	#1	#0
3710		CSL						
		CSL			SGR			

[Data type] Bit

SGR When method B is selected as the spindle gear switching method for a tapping cycle (G84 or G74) (bit 3 (SGT) of parameter No. 3705 = 1), gear switching method B is used for:
 0 : Both tapping and rigid tapping.
 1 : Rigid tapping only.

CSL In Cs contour control mode, fine acceleration/deceleration is disabled for:
 0 : An axis selected by the signal (CDFn <G0127>) issued from the PMC. (n = 1 to 4)
 1 : An axis for which interpolation is performed with the Cs contour controlled axis (parameter No. 39n0). (n = 0 to 2)

	#7	#6	#5	#4	#3	#2	#1	#0
3712						CSF		

[Data type] Bit

CSF The Cs axis coordinate setup function is:
 0 : Disabled.
 1 : Enabled.

NOTE
 When setting this parameter to 1, also set bit 5 of parameter No. 4353 to 1.

	#7	#6	#5	#4	#3	#2	#1	#0
3713								SIM

NOTE
When this parameter has been set, the power must be turned off before operation is continued.

[Data type] Bit
SIM In multi-spindle control, when address P is used for spindle selection (bit 3 of parameter No. 3703 = 1), and an axis move command and S command are specified in the same block:
0 : The S command becomes valid after an axis movement is completed.
1 : The S command becomes valid at the same time when an axis movement is made.

	#7	#6	#5	#4	#3	#2	#1	#0
3715								NSAx

[Data type] Bit axis
NSAx This parameter specifies an axis for which confirmation of the spindle speed reached signal (SAR) is unnecessary when a move command is executed for the axis. When a move command is issued only for an axis for which 1 is set in this parameter, the spindle speed reached signal (SAR) is not checked.
0 : Confirmation of SAR is necessary.
1 : Confirmation of SAR is unnecessary.

3730	Data used for adjusting the gain of the analog output of spindle speed
------	--

[Data type] Word
[Unit of data] 0.1 %
[Valid data range] 700 to 1250
Set data used for adjusting the gain of the analog output of spindle speed.
[Adjustment method]
(1) Assign standard value 1000 to the parameter.
(2) Specify the spindle speed so that the analog output of the spindle speed is the maximum voltage (10 V).
(3) Measure the output voltage.
(4) Assign the value obtained by the following equation to parameter No.3730.
$$\text{Set value} = \frac{10 \text{ (V)}}{\text{Measured data (V)}} \times 1000$$

(5) After setting the parameter, specify the spindle speed so that the analog output of the spindle speed is the maximum voltage. Confirm that the output voltage is 10V.

NOTE

This parameter needs not to be set for serial spindles.

3731

Compensation value for the offset voltage of the analog output of the spindle speed

[Data type] Word

[Unit of data] Velo

[Valid data range] -1024 to+1024

Set compensation value for the offset voltage of the analog output of the spindle speed.

$$\text{Set value} = \frac{-8191 \times \text{Offset voltage (V)}}{12.5}$$

[Adjustment method]

- (1) Assign standard value 0 to the parameter.
- (2) Specify the spindle speed so that the analog output of the spindle speed is 0.
- (3) Measure the output voltage.
- (4) Assign the value obtained by the following equation to parameter No.3731.

$$\text{Set value} = \frac{-8191 \times \text{Offset voltage (V)}}{12.5}$$

- (5) After setting the parameter, specify the spindle speed so that the analog output of the spindle speed is 0. Confirm that the output voltage is 0V.

NOTE

This parameter usually need not to be set for serial spindles (Set to 0).

3732	The spindle speed during spindle orientation or the spindle motor speed during spindle gear shift
-------------	--

[Data type]
[Valid data range]

Word
0 to 20000
Set the spindle speed during spindle orientation or the spindle motor speed during gear shift.
When GST, #1 of parameter 3705, is set to 0, set the spindle speed during spindle orientation in rpm.
When GST, #1 of parameter 3705, is set to 1, set the spindle motor speed during spindle gear shift calculated from the following formula.

For a serial spindle

$$\text{Set value} = \frac{\text{Spindle motor speed during spindle gear shift}}{\text{Maximum spindle motor speed}} \times 16383$$

For an analog spindle

$$\text{Set value} = \frac{\text{Spindle motor speed during spindle gear shift}}{\text{Maximum spindle motor speed}} \times 4095$$

3735	Minimum clamp speed of the spindle motor
-------------	---

[Data type]
[Valid data range]

Word
0 to 4095
Set the minimum clamp speed of the spindle motor.
Set value= $\frac{\text{Minimum clamp speed of the spindle motor}}{\text{Maximum spindle motor speed}} \times 4095$

NOTE
If the function of constant surface speed control or bit 4 (GTT) of parameter No. 3706 is specified, this parameter is invalid.

3736	Maximum clamp speed of the spindle motor
-------------	---

[Data type]
[Valid data range]

Word
0 to 4095
Set the maximum clamp speed of the spindle motor.
Set value= $\frac{\text{Maximum clamp speed of the spindle motor}}{\text{Maximum spindle motor speed}} \times 4095$

NOTE
If the function of constant surface speed control or bit 4 (GTT) of parameter No. 3706 is specified, this parameter is invalid.
In this case, the maximum clamp speed of spindle motor cannot be specified. However, the maximum spindle speed can be specified by the following parameters.
Parameter No.3772 (for the first axis)
Parameter No.3802 (for the second axis)
Parameter No.3882 (for the third axis)

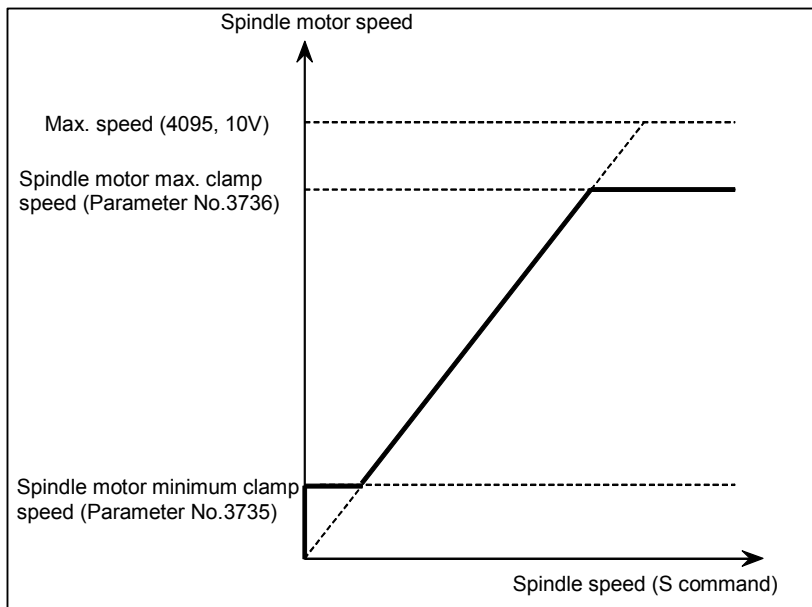

Fig.4.20 (a) Maximum Clamp Speed of Spindle Motor

3740	Time elapsed prior to checking the spindle speed arrival signal
-------------	--

[Data type]
[Unit of data]
[Valid data range]

Byte
msec
0 to 225
Set the time elapsed from the execution of the S function up to the checking of the spindle speed arrival signal.

3741	Maximum spindle speed for gear 1
3742	Maximum spindle speed for gear 2
3743	Maximum spindle speed for gear 3
3744	Maximum spindle speed for gear 4
	(Note)

[Data type] Two-word
 [Unit of data] min⁻¹
 [Valid data range] 0 to 32767

Set the maximum spindle speed corresponding to each gear.

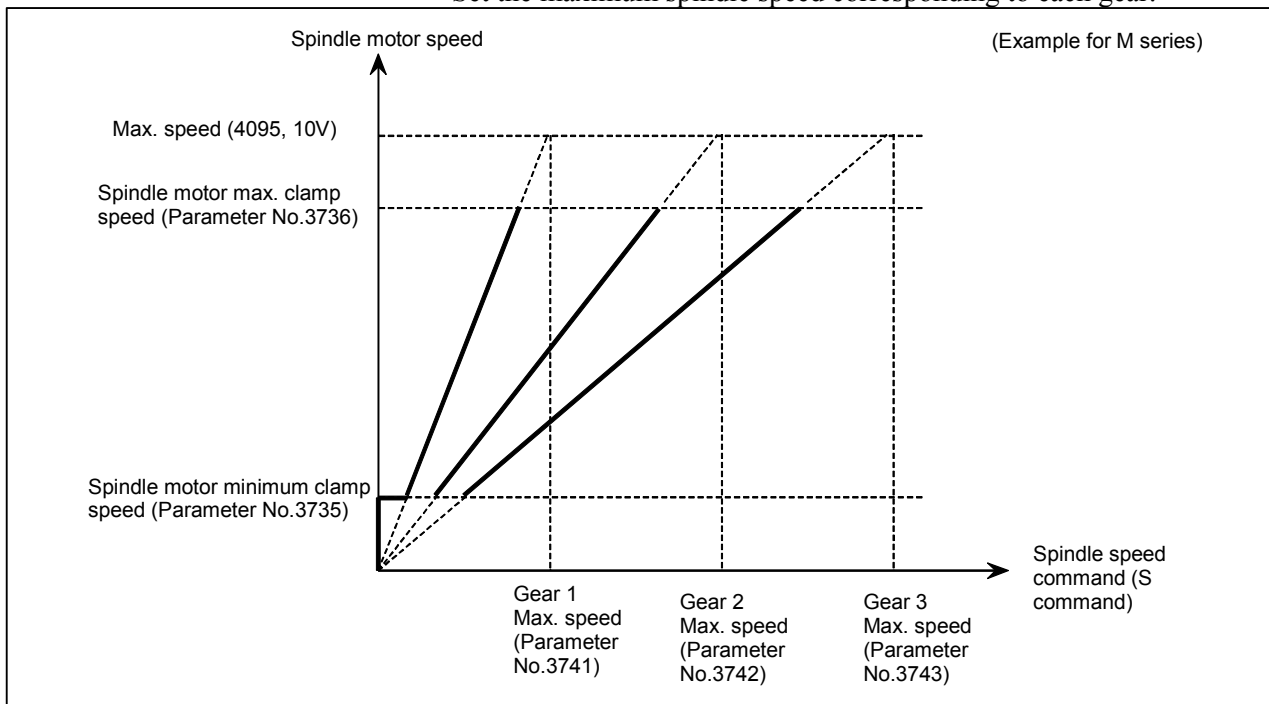

Fig.4.20 (b) Maximum Spindle Speed Corresponding to Gear 1/2/3

NOTE

If a type-T gear shift scheme is selected for the M series (with the constant surface speed control option installed or parameter GTT (bit 4 of parameter No. 3706) = 1), parameter No. 3744 is usable also in the M series.

Note, however, that, even in this case, only up to three main gear stages are usable for rigid tapping.

3751	Spindle motor speed when switching from gear 1 to gear 2
3752	Spindle motor speed when switching from gear 2 to gear 3

[Data type] Word
 [Valid data range] 0 to 4095

For gear switching method B, set the spindle motor speed when the gears are switched.

$$\text{Set value} = \frac{\text{Spindle motor speed when the gears are switched}}{\text{Maximum spindle motor speed}} \times 4095$$

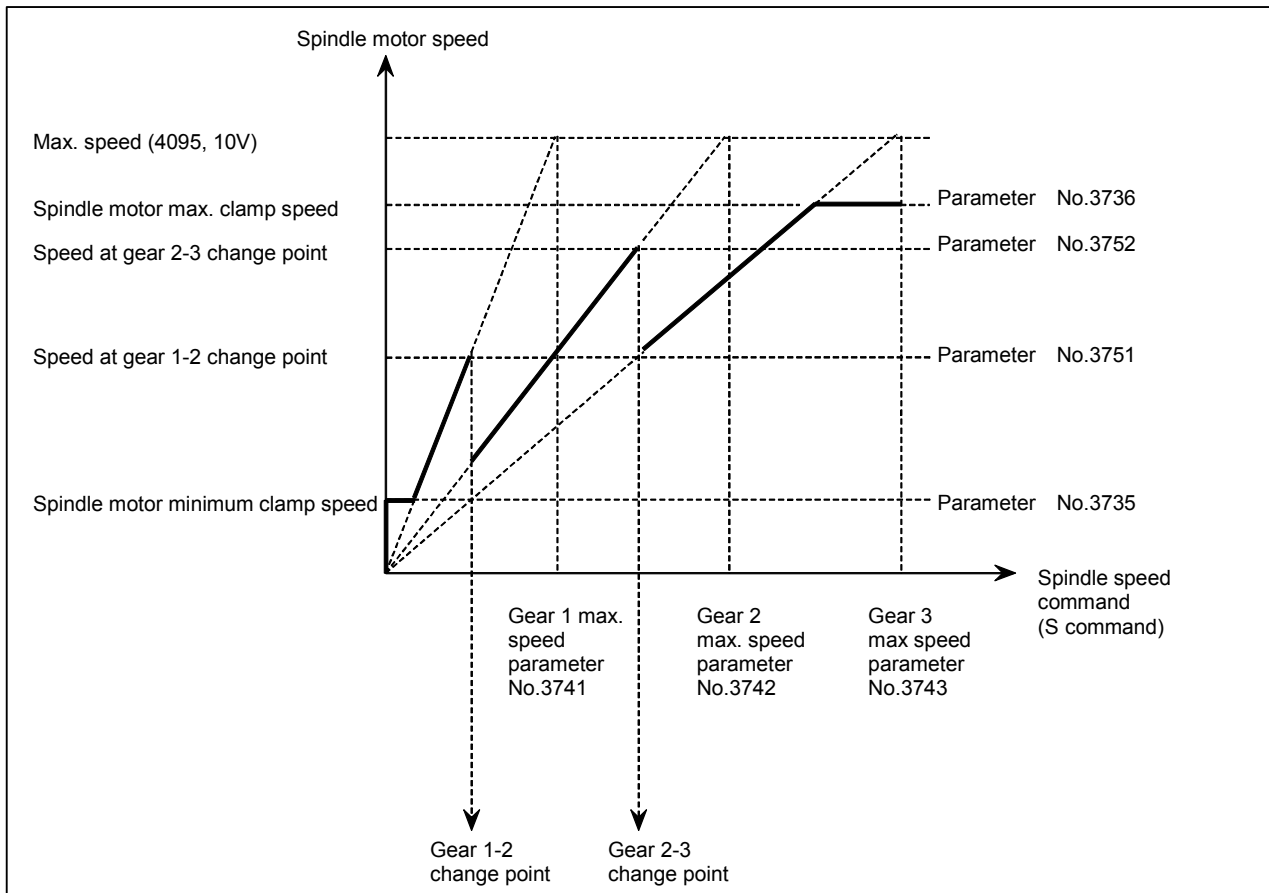

Fig.4.20 (c) Spindle Motor Speed at Gear 1-2/2-3 Change Point

3761	Spindle speed when switching from gear 1 to gear 2 during tapping
3762	Spindle speed when switching from gear 2 to gear 3 during tapping

[Data type] 2-word
 [Unit of data] min⁻¹
 [Valid data range] 0 to 32767

When method B is selected (SGT,#3 of parameter 3705, is set to 1) for the tapping cycle gear switching method, set the spindle speed when the gears are switched.

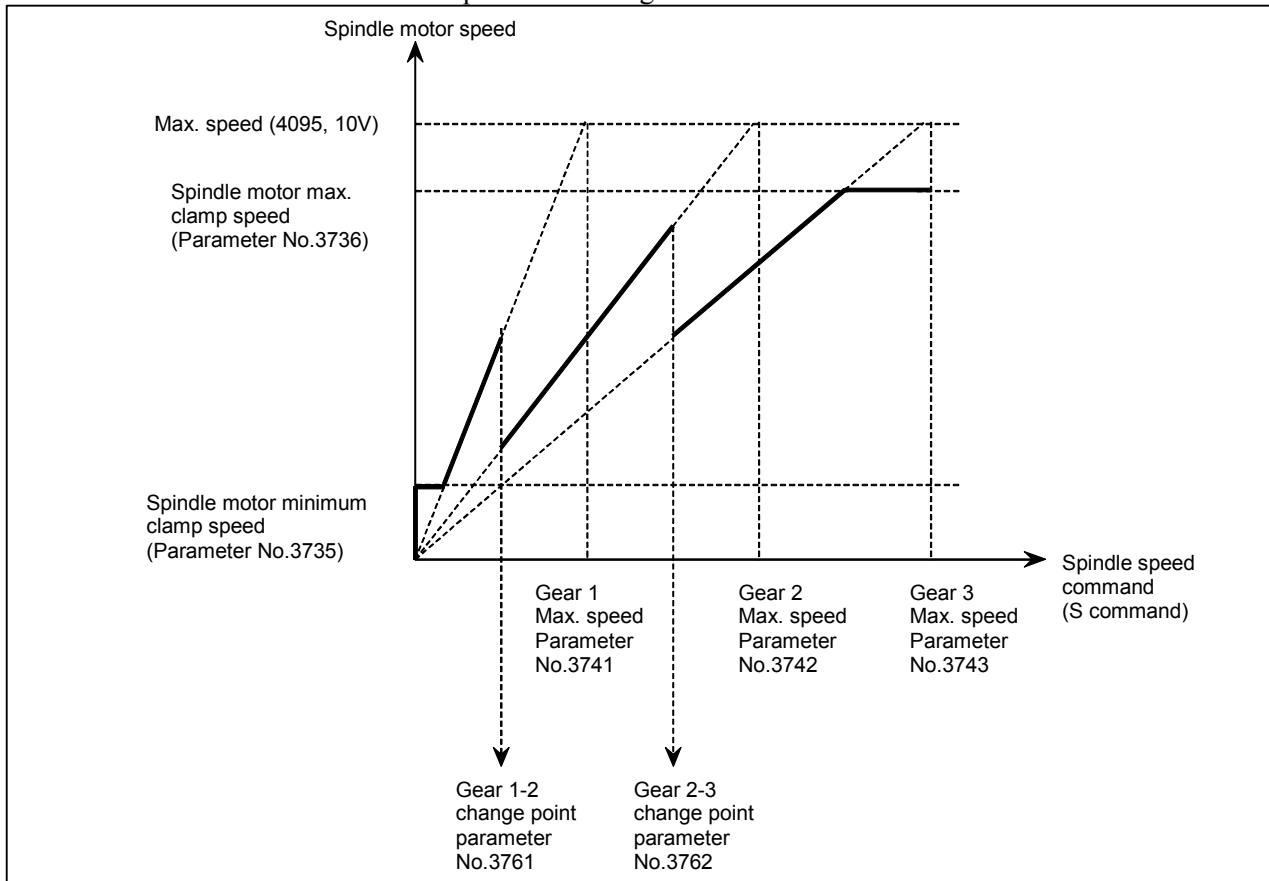

Fig.4.20 (d) Spindle Motor Speed at Gear 1-2/2-3 Change Point during Tapping

3770	Axis as the calculation reference in constant surface speed control
-------------	--

[Data type] Byte
 [Valid data range] 0, 1, ..., number of control axes
 Set the axis as the calculation reference in constant surface speed control.

NOTE
 When 0 is set, constant surface speed control is always applied to the X-axis. In this case, specifying P in a G96 block has no effect on the constant surface speed control.

3771	Minimum spindle speed in constant surface speed control mode (G96)
-------------	---

[Data type] 2-word
 [Unit of data] min⁻¹
 [Valid data range] 0 to 32767
 Set the minimum spindle speed in the constant surface speed control mode (G96).
 The spindle speed in constant surface speed control is clamped to the speed given by parameter 3771.

3772

Maximum spindle speed

[Data type] 2-word
 [Unit of data] min^{-1}
 [Valid data range] 0 to 32767

This parameter sets the maximum spindle speed.

When a command specifying a speed exceeding the maximum speed of the spindle is specified, or the speed of the spindle exceeds the maximum speed because of the spindle speed override function, the spindle speed is clamped at the maximum speed set in the parameter.

NOTE

- 1 For M series, this parameter is valid if the function of constant surface speed control is provided or parameter GTT (bit 4 of No. 3706) is set to 1.
- 2 When the constant surface speed control is selected, the spindle speed is clamped at the maximum speed, regardless of whether the G96 mode or G97 mode is specified.
- 3 When 0 is set in this parameter, the speed of the spindle is not clamped.
- 4 When spindle speed command control is applied using the PMC, this parameter has no effect, and the spindle speed is not clamped.
- 5 When the multi-spindle control is selected (T series), set the maximum speed for each spindle in the following parameters:
 Parameter No.3772:
 Sets the maximum speed for the first spindle.
 Parameter No.3802:
 Sets the maximum speed for the second spindle.
 Parameter No.3822:
 Sets the maximum speed for the third spindle.

3781	P code for selecting the first spindle in multi-spindle control
3782	P code for selecting the second spindle in multi-spindle control
3783	P code for selecting the third spindle in multi-spindle control

NOTE

When this parameter has been set, the power must be turned off before operation is continued.

[Data type]
[Valid data range]

Word

0, 1 to 32767

If bit 3 (MPP) of parameter No. 3703 is set to 1, set the P code to select each spindle under multi-spindle control. Specify the P code in a block containing the S command.

Example)

If the P code value for selecting the second spindle is set to 3,
S1000 P3;
causes the second spindle to rotate at S1000.

NOTE

- 1 This parameter is valid if bit 3 (MPP) of parameter No. 3703 is set to 1.
- 2 If this parameter is set to 0, the corresponding spindle cannot be selected by a P code.
- 3 Identical P code values cannot be used for different spindles.
- 4 If this parameter is used (bit 3 (MPP) of parameter No. 3703 is set to 1), signals SWS1 to SWS3 <G027 bits 0 to 2> become invalid.
- 5 To use this parameter, the multi-spindle control function is needed.

3802	Maximum speed of the second spindle
[Data type]	2-word
[Unit of data]	min ⁻¹
[Valid data range]	0 to 32767
	Parameter sets the maximum speed for the second spindle. When a command specifying a speed exceeding the maximum speed of the spindle is specified, or the speed of the spindle exceeds the maximum speed because of the spindle speed override function, the spindle speed is clamped at the maximum speed set in the parameter.
	<p>NOTE</p> <ol style="list-style-type: none"> 1 This parameter is valid when the multi-spindle control is selected. 2 When the constant surface speed control is selected, the spindle speed is clamped to a maximum speed, regardless of whether the G96 mode or G87 mode is set. 3 When this parameter is set to 0, parameter No. 3772 (maximum speed of the first spindle) is valid. The spindle speed is not clamped when parameter No. 3772 is set to 0. 4 When spindle speed command control is applied using the PMC, this parameter has no effect, and the spindle speed is not clamped.
3811	Maximum spindle speed for gear 1 of the second spindle
3812	Maximum spindle speed for gear 2 of the second spindle
[Data type]	2-word
[Unit of data]	min ⁻¹
[Valid data range]	0 to 32767
	Set the maximum spindle speed for each gear of the second spindle.
	<p>NOTE</p> <p>These parameters are used for the multi-spindle control.</p>

3820

Data for adjusting the gain of the analog output of the third-spindle speed

[Data type] Word
 [Unit of data] 0.1%
 [Valid data range] 700 to 1250
 Set the data used for adjusting the gain of the analog output of the third spindle speed.

NOTE

This parameter is used for controlling the multi-spindles.

3821

Offset-voltage compensation value of the analog output of the third-spindle speed

[Data type] Word
 [Unit of data] Velo
 [Valid data range] -1024 to 1024
 Set the offset-voltage compensation value of the analog output of the third-spindle speed.
 (See the description of parameter No. 3731.)

NOTE

This parameter is used for controlling the multi-spindles.

3822

Maximum speed of the third spindle

[Data type] Word
 [Unit of data] min^{-1}
 [Valid data range] 0 to 32767
 This parameter sets the maximum speed for the third spindle.
 When a command specifying a speed exceeding the maximum spindle speed is specified, or the spindle speed exceeds the maximum speed because of the spindle speed override function, the spindle speed is clamped at the maximum speed set in the parameter.

NOTE

- 1 This parameter is valid when the multi-spindle control is selected.
- 2 When the constant surface speed control option is selected, the spindle speed is clamped to a maximum speed, regardless of whether the G96 mode or G97 mode is set.
- 3 When this parameter is set to 0, parameter No. 3772 (maximum speed of the first spindle) is valid. The spindle speed is not clamped when parameter No. 3772 is set to 0.
- 4 When spindle speed command control is applied using the PMC, this parameter has no effect, and the speed of the spindle is not clamped.

3831	Maximum spindle speed for gear 1 of the third spindle
3832	Maximum spindle speed for gear 2 of the third spindle

[Data type] Word
 [Unit of data] min⁻¹
 [Valid data range] 0 to 32767
 Set the maximum spindle speed for each gear of the third spindle.

NOTE

These parameters are used for the multi-spindle control.

List of parameters for control of serial interface spindle Cs contouring control axis

No.	Data type	Description	
3900	Byte	First group	Number of the servo axis whose loop gain is to be changed according to the set values of parameters 3901 to 3904 when the Cs contouring axis is controlled (set values 0 to 8)
3901	Word		Loop gain for the servo axis when the Cs contouring axis is controlled for spindle gear 1 selection
3902	Word		Loop gain for the servo axis when the Cs contouring axis is controlled for spindle gear 2 selection
3903	Word		Loop gain for the servo axis when the Cs contouring axis is controlled for spindle gear 3 selection
3904	Word		Loop gain for the servo axis when the Cs contouring axis is controlled for spindle gear 4 selection
3910	Byte	Second group	Number of the servo axis whose loop gain is to be changed according to the set values of parameters 3911 to 3914 when the Cs contouring axis is controlled (set values 0 to 8)
3911	Word		Loop gain for the servo axis when the Cs contouring axis is controlled for spindle gear 1 selection
3912	Word		Loop gain for the servo axis when the Cs contouring axis is controlled for spindle gear 2 selection
3913	Word		Loop gain for the servo axis when the Cs contouring axis is controlled for spindle gear 3 selection
3914	Word		Loop gain for the servo axis when the Cs contouring axis is controlled for spindle gear 4 selection

List of parameters for control of serial interface spindle Cs contouring control axis

No.	Data type	Description	
3920	Byte	Third group	Number of the servo axis whose loop gain is to be changed according to the set values of parameters 3921 to 3924 when the Cs contouring axis is controlled (set values 0 to 8)
3921	Word		Loop gain for the servo axis when the Cs contouring axis is controlled for spindle gear 1 selection
3922	Word		Loop gain for the servo axis when the Cs contouring axis is controlled for spindle gear 2 selection
3923	Word		Loop gain for the servo axis when the Cs contouring axis is controlled for spindle gear 3 selection
3924	Word		Loop gain for the servo axis when the Cs contouring axis is controlled for spindle gear 4 selection

<Setting method>

First, select servo axes which perform interpolation with the Cs contouring axis. (Up to three axes can be selected.)

When there is no servo axis for interpolation with the Cs contouring axis, set the parameters 3900, 3910, and 3920 to 0 to terminate parameter setting.

When there are servo axes for interpolation with the Cs contouring axis, the parameters must be set according to the procedure below for each axis.

- (1) Set the number of a servo axis (1 to 4) for interpolation with the Cs contouring axis in parameters 39n0 (n = 0, 1, and 2).
- (2) Set loop gain values of the servo axis specified in (1) above which is used when the Cs contouring axis is controlled in parameters 39n1, 39n2, 39n3, and 39n4. (There are four stages for main gears used.)
- (3) When the number of specified servo axes is less than 3, set the remaining parameters (39n0) to 0 to terminate parameter setting.

When the number of a Cs contouring axis is set to parameter 39n0, the parameter is assumed to be set to 0.

NOTE

- 1 In general, it is difficult to set a high loop gain for a spindle motor axis when compared with a servo axis. These parameters are provided so that, by changing the loop gain of a servo axis that requires interpolation with the Cs contour axis, interpolation control can be exercised correctly between the Cs axis and servo axis while the spindle exercises Cs contour control.
- 2 The loop gain of the servo axis is changed using the parameter settings made for a spindle gear selected at the time of conversion from the spindle mode to the Cs contour control mode.
In normal use, it is unlikely that the gear of the spindle is switched during Cs contour control. However, note that if the gear of the spindle is changed during Cs contour control, the loop gain of the servo axis is not changed.
- 3 Even when multiple Cs axes are used (bit 7 (CSS) of parameter No. 3704 = 1), these parameters are shared.

Parameters for Serial interface spindle or spindle

Parameters Nos. 4000 to 4539 below are basically used with the serial spindle amplifier (SPM). For details of these parameters, refer to either of the following manuals and other related documents, depending on the spindle that is actually connected.

- FANUC AC SPINDLE MOTOR α i series Parameter Manual (B-65280EN)
- FANUC AC SPINDLE MOTOR α series Parameter Manual (B-65160E)

	#7	#6	#5	#4	#3	#2	#1	#0
4000								
:	:							
4015	(No user setting allowed = Note 1)							

	#7	#6	#5	#4	#3	#2	#1	#0
4019	(Note 2)							

[Data type] Bit axis (spindle)

4020	
:	:
4133	

[Data type] Word axis (spindle)

4134	
4135	

[Data type] 2-word axis (spindle)

4136	
:	:
4175	

[Data type] Word axis (spindle)

	#7	#6	#5	#4	#3	#2	#1	#0
4176								
:	:							
4191	(No user setting allowed = Note 1)							

	#7	#6	#5	#4	#3	#2	#1	#0
4195	(Note 2)							

[Data type] Bit axis (spindle)

4196	
:	:
4309	

[Data type] Word axis (spindle)

4310	
4311	

[Data type] 2-word axis (spindle)

4312	
:	:
4351	

[Data type] Word axis (spindle)

	#7	#6	#5	#4	#3	#2	#1	#0
4352								
	#7	#6	#5	#4	#3	#2	#1	#0
4353								

[Data type] Bit axis (spindle)

4354	
:	:
4372	

[Data type] Word axis (spindle)

	#7	#6	#5	#4	#3	#2	#1	#0
4373								
	#7	#6	#5	#4	#3	#2	#1	#0
4374								

[Data type] Bit axis (spindle)

4375	
:	:
4393	

[Data type] Word axis (spindle)

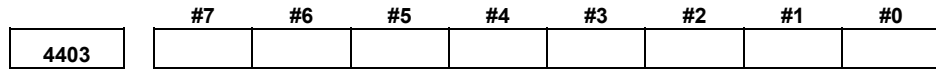
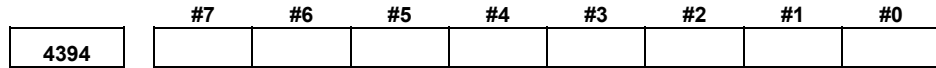

[Data type] Bit axis (spindle)

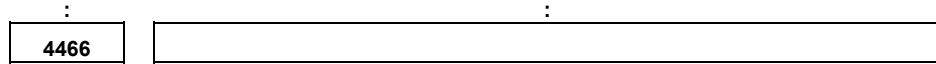

[Data type] Word axis (spindle)

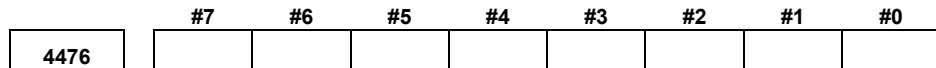
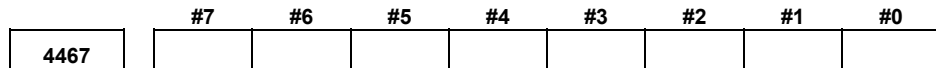

[Data type] Bit axis (spindle)

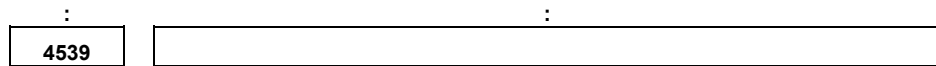

[Data type] Word axis (spindle)

Notes on parameters of the spindle amplifier with the serial interface

NOTE

- 1 Among the parameters of the spindle amplifier with the serial interface, parameters Nos. 4015 and 4191 cannot be changed by the users.
These parameters require to assign optional software to the CNC and are automatically set depending on the type of the software.
- 2 To set the parameters of the spindle amplifier with the serial interface automatically, set #7 of parameter No.4019 (if the sub spindle is set in the CNC with the spindle switching function, use parameter No.4195) to 1, assign the model code of the motor to be used to parameter No.4133 (if the sub spindle is set in the CNC with the spindle switching function, use parameter No.4309), turn off the power of the CNC and spindle amplifier, and restart the CNC and spindle amplifier.
- 3 Parameters No.4000 to No.4539 are used in the processing on the spindle amplifier. For details of these parameters, refer to either of the following manuals, depending on the serial spindle that is actually used.
 - FANUC AC SPINDLE MOTOR α i series Parameter Manual B-65280EN)
 - FANUC AC SPINDLE MOTOR α series Parameter Manual B-65160E)
- 4 The CNC can control up to two spindle amplifiers with the serial interface. When the spindle amplifier provides the spindle switching function, one spindle amplifier can control two spindle motors using the switching function. The output switching function can be used in spindle motors to be connected. Up to four spindles, or eight types, can be used by switching the spindle motors. (The number of spindles that can controlled simultaneously is the same as the number of spindle amplifiers, that is two spindles.) Parameters of the spindle amplifier with the serial interface correspond to the above functions as follows:
 - (1) Parameter No.4000 to No.4539 "S1": First spindle amplifier
Parameter No.4000 to No.4539 "S2": Second spindle amplifier
 - (2) Parameter No.4000 to No.4175 "S1"/"S2": When the spindle switching function is not provided, or for the main spindle in the spindle amplifier when the function is provided.
Parameter No.4176 to No.4351 "S1"/"S2": For the sub spindle in the spindle amplifier when the spindle switching function is provided.
 - (3) Parameters at low speed when the output switching function is provided.
Parameters No.4136 to No.4175 "S1"/"S2": When the spindle switching function is not provided, or for the main spindle when the function is provided.
Parameters No.4284 to No.4351 "S1"/"S2": For the sub spindle when the spindle switching function is provided.

NOTE

5 The CNC stores the parameters of the spindle amplifier with the serial interface. The CNC sends them to the spindle amplifier at the system power on and they are used in the unit.

These parameters are sent from the CNC to the spindle amplifier in a batch when:

- The CNC is switched on.
- The serial spindle is restarted by a reset that is carried out after spindle communication alarm 749 occurs (because the spindle control unit is switched off or because of noise).

If these parameters are rewritten, they are sent from the CNC to the spindle amplifier sequentially when:

- The parameters have been entered from the MDI.
- The parameters have been entered as programmable (G10).
- The parameters have been entered via the reader/punch interface.

If bit 4 (WSP) of parameter No. 8703 is set to 0, the CNC does not immediately perform data transfer to the spindle amplifier even when data has been written to a parameter by using the PMC window function. So, the new parameter value set by rewriting does not become valid automatically. To perform data transfer immediately, set bit 4 (WSP) of parameter No. 8703 to 1.

If you want to change such parameter settings during automatic operation, use programmable parameter input (G10).

To set parameters automatically, upload parameters corresponding to the motor model from the spindle amplifier to the CNC prior to the procedure specified above. The parameters of the spindle amplifier with serial interface can be changed after the system starts. Changing the parameters (No.4000 to No.4539 "S1", "S2") in the CNC sends them to the spindle amplifier at an appropriate time and the parameters in the unit are updated. Be careful not to change parameters incorrectly.

	#7	#6	#5	#4	#3	#2	#1	#0
4800				SYM			ND2	ND1
							ND2	ND1

NOTE
 When this parameter is set, the power must be turned off before operation is continued.

- [Data type] Bit
- ND1 In controlling the spindle synchronization, the direction of the first spindle motor rotation is:
 0 : The direction indicated by the command sign
 1 : The opposite direction to that indicated by the command sign
- ND2 In controlling the spindle synchronization, the direction of the 2nd spindle motor rotation is:
 0 : The direction indicated by the command sign
 1 : The opposite direction to that indicated by the command sign
- SYM As the maximum spindle speed in spindle synchronization control:
 0 : The maximum spindle speed of the master spindle is used.
 1 : The maximum spindle speed of the master spindle or slave spindle, whichever lower, is used.

4810 Error pulse between two spindles when synchronizing phases in the serial spindle synchronization control mode

- [Data type] Byte
 - [Unit of data] Pulse
 - [Valid data range] 0 to 255
- Set the difference in error pulses between two spindles when synchronizing phases in the serial spindle synchronization control mode.
 When the difference in error pulse between two spindles is within the value set in this parameter, the spindle phase synchronization completion signal FSPPH becomes "1".
 This parameter is used to check the difference in phase in synchronization control and to confirm the completion of synchronization in the serial spindle synchronization control mode.
 For spindle synchronization, serial spindle parameters such as parameter No. 4032 must be set.

4811 Allowable error count for the error pulses between two spindles in the serial spindle synchronization control mode or simple synchronous control mode

- [Data type] Word
 - [Unit of data] Pulse
 - [Valid data range] 0 to 32767
- Set the allowable error count for the error pulses between two spindles in the serial spindle synchronization control mode or simple synchronous control mode.

NOTE

This parameter is used to output the inter-spindle phase error detection signal SYCAL in the serial spindle synchronization control mode. The SYCAL <F044#4> signal becomes "1" when a phase error exceeding the value set in this parameter is found.

4812	Master spindle under synchronous spindle control
------	--

4813	Slave spindle under synchronous spindle control
------	---

[Data type] Byte
 [Valid data range] 0, 1, 2
 Set the master spindle and slave spindle in spindle synchronization control.
 Setting value : 1 to 2, First to second spindles

NOTE

These parameters are valid only in spindle synchronization control specified by programming. If 0 is set, turning on spindle synchronization control by programming (G51.8) results in an alarm.

4831	Master axis of first spindle under synchronous spindle control
------	--

4832	Master axis of second spindle under synchronous spindle control
------	---

NOTE

When these parameters have been set, the power must be turned off before operation is continued.

[Data type] Byte
 [Valid data range] 1 to Number of spindles
 Set the slave axis and master axis of synchronous spindle control by spindles. Set the axis number of the master axis for the axis to be handled as the slave axis.

NOTE

This parameter is valid if bit 4 (SSS) of parameter No. 3704 is set to 1.

	#7	#6	#5	#4	#3	#2	#1	#0
4900								FLR

[Data type] Bit
 FLR When the spindle speed fluctuation detection function is used, the rates of allowance (q) and fluctuation (r) those are set in parameter No.4911 and No.4912, respectively are set in steps of:
 0 : 1%
 1 : 0.1%

4911	Rapid (q) of the fluctuation of spindle speed which is assumed to be the specified spindle speed

[Data type] Word
 [Unit of data, valid data range]

Unit of data	1%	0. 1% (T series)
Valid data range	1 to 100	1 to 1000

NOTE
 Unit of data depends on parameter No.4900#0 FLR (T series only)

Set the ratio (q) of the spindle speed which is assumed to be the specified spindle speed in the spindle speed fluctuation detection function.

Let the commanded speed be Sc. When the actual spindle speed reaches between (Sc-Sq) and (Sc + Sq), it is assumed to be the commanded speed.

The spindle speed fluctuation detection starts. where,

$$Sq = Sc \times \frac{q}{100}$$

4912	Spindle speed fluctuation ratio (r) for which no alarm is activated in the spindle speed fluctuation detection function

[Data type] Word
 [Unit of data, valid data range]

Unit of data	1%	0. 1% (T series)
Valid data range	1 to 100	1 to 1000

NOTE
 Unit of data depends on parameter No.4900#0 FLR (T series only).

Set the spindle speed fluctuation ratio (r) for which no alarm is activated in the spindle speed fluctuation detection function (see Fig.4.20 (e)).

4913	Spindle speed fluctuation value (d) for which no alarm is activated in the spindle speed fluctuation detection function
-------------	--

[Data type] Word
 [Unit of data] min⁻¹
 [Valid data range] 0 to 32767

Set the allowable fluctuation speed (Sd) for which no alarm is activated in the spindle speed fluctuation detection function.
 The function for detecting spindle speed fluctuation checks whether the actual speed varies for the specified speed or not. Sd or Sr, whichever is greater, is taken as the allowable fluctuation speed (Sm). An alarm is activated when the actual spindle speed varies for the commanded speed (Sc) under the condition that the variation width exceeds the allowable variation width (Sm).
 Sd: The allowable constant variation width which is independent of the specified spindle speed (Sd is set with parameter 4913.)
 Sr: The allowable variation width which is obtained by multiplying Sc (commanded spindle speed) by r (constant ratio). (r is set with parameter 4912.)
 Sm: Sd or Sr, whichever is greater

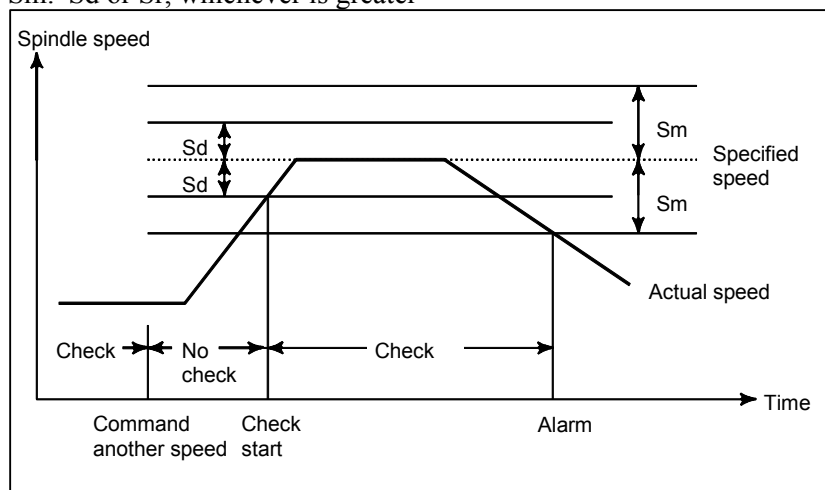

Fig.4.20 (e) Sd and Sm

4914	Time (p) elapsed from when the commanded spindle speed is changed to the start of spindle speed fluctuation detection
-------------	--

[Data type] 2-word
 [Unit of data] ms
 [Valid data range] 0 to 999999

Set the time elapsed from when the specified spindle speed is changed to the start of spindle speed fluctuation detection in the spindle speed fluctuation detection function. That is, the fluctuation in the spindle speed is not detected until the specified time elapses from when the specified spindle speed is changed.

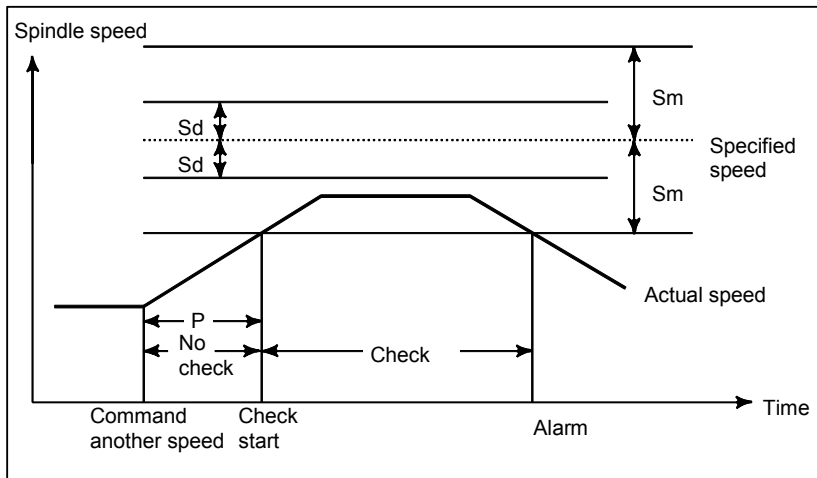

Fig.4.20 (f) Sd and Sm

	#7	#6	#5	#4	#3	#2	#1	#0
4950	IMB	ESI	TRV			ISZ	IDM	IOR

- [Data type] Bit
- IOR Resetting the system in the spindle positioning mode
 0 : Does not releases the mode.
 1 : Releases the mode
 - IDM The positioning direction for the spindle using a M code is
 0 : The positive direction
 1 : The negative direction
 - ISZ When an M code for spindle orientation is specified in spindle positioning:
 0 : The spindle rotation mode is cleared and the mode is switched to the spindle positioning mode, and spindle orientation operation is performed.
 1 : The spindle rotation mode is cleared and the mode is switched to the spindle positioning mode but spindle orientation operation is not performed.
 - TRV Rotation direction of spindle positioning is set to:
 0 : The positive direction
 1 : The reverse direction
 - ESI Selection of a spindle positioning specification
 0 : The conventional specification is used.
 1 : The extended specification is used.

NOTE

The extended specification includes the following two extensions:

- (1) With the conventional specification, the number of M codes for specifying a spindle positioning angle is always 6. With the extended specification, an arbitrary number of such M codes from 1 to 255 can be selected by parameter setting (See parameter No.4964.)
- (2) The maximum feedrate for spindle positioning (setting of parameter No.1420) can be extended from 240000 to 269000 (in increments of 10 deg/min).

IMB When the spindle positioning function is used, half-fixed angle positioning based on M codes uses:

- 0 : Specification A
- 1 : Specification B

NOTE

In the case of half-fixed angle positioning based on M codes, three types of spindle positioning operations can occur:

- (1) The spindle rotation mode is cleared, then the mode is switched to the spindle positioning mode.
- (2) Spindle positioning is performed in the spindle positioning mode.
- (3) The spindle positioning mode is cleared, then the mode is switched to the spindle rotation mode.

In the case of specification A:

Operations (1) to (3) are specified using separate M codes.

- (1) Specified using M codes for performing spindle orientation. (See parameter No.4960)
- (2) Specified using M codes for specifying a spindle positioning angle. (See parameter No.4962)
- (3) Specified using M codes for clearing spindle positioning operation. (See parameter No.4961.)

In the case of specification B:

When M codes for specifying a spindle positioning angle are specified, operations

- (1) to (3) are performed successively. (See parameter No.4962.)

4960	M code specifying the spindle orientation

[Data type] Word
 [Unit of data] Integer
 [Valid data range] 6 to 97
 Set an M code to change the spindle rotating mode to the spindle positioning mode. Setting the M code performs the spindle orientation. Spindle positioning can be specified from the next block.

4961	M code releasing the spindle positioning mode

[Data type] Word
 [Unit of data] Integer
 [Valid data range] 6 to 97
 Set the M code to release the spindle positioning mode and to change the mode to the spindle rotating mode.

4962	M code for specifying a spindle positioning angle

[Data type] Word
 [Unit of data] Integer
 [Valid data range] 6 to 92
 Two methods are available for specifying spindle positioning. One method uses address C for arbitrary-angle positioning. The other use an M code for half-fixed angle positioning. This parameter sets an M code for the latter method.

- When bit 6 (ESI) of parameter No.4950=0
Six M code from M_{α} to $M_{(\alpha+5)}$ are used for half-fixed angle positioning, when α is the value of this parameter.
- When bit 6(ESI) of parameter No.4950=1
Set the start M code in this parameter, and set the number of M codes in parameter No.4964. Suppose that the setting of parameter No. 4962 is α and the setting of parameter No. 4964 is β . Then β M codes from M_{α} to $M_{(\alpha+\beta-1)}$ are used for half fixed angle positioning.

The table below indicates the relationship between the M codes and positioning angles.

M code	Positioning angle	Example: Positioning angle when $\theta = 30^{\circ}$
M_{α}	θ	30°
$M_{(\alpha+1)}$	2θ	60°
$M_{(\alpha+2)}$	3θ	90°
$M_{(\alpha+3)}$	4θ	120°
$M_{(\alpha+4)}$	5θ	150°
$M_{(\alpha+5)}$	6θ	180°
:	:	:
$M_{(\alpha+n)}$	$(n+1)\theta$	

NOTE

θ represents the basic angular displacement set in parameter No.4963.

4963

Basic angular displacement used for spindle positioning using M code

[Data type] Word
 [Unit of data] deg
 [Valid data range] 1 to 60

This parameter sets a basic angular displacement used for half-fixed angle positioning using M codes.

4964

Number of M codes for specifying a spindle positioning angle

[Data type] Byte
 [Unit of data] Integer
 [Valid data range] 0, 1 to 255

This parameter sets the number of M codes used for Half-fixed angle positioning using M codes.

As many M codes as the number specified in this parameter, starting with the M code specified in parameter No.4962, are used to specify half-fixed angle positioning.

Let α be the value of parameter No.4962, and let β be the value of parameter No.4964. That is, M codes from $M\alpha$ to $M(\alpha+\beta-1)$ are used for half-fixed angle positioning.

NOTE

- 1 This parameter is valid when bit 6 (ESI) of parameter No.4950=1.
- 2 Make sure that M codes from $M\alpha$ to $M(\alpha+\beta-1)$ do not duplicate other M codes.
- 3 Setting this parameter to 0 has the same effect as setting 6. That is, M code from $M\alpha$ to $M(\alpha+5)$ are used for half-fixed angle positioning.

4970

Servo loop gain of the spindle

[Data type] Word
 [Unit of data] 0.01 s^{-1}
 [Valid data range] 1 to 9999

Set the servo loop gain of the spindle in the spindle positioning mode.

4971	Servo loop gain multiplier of the spindle for gear 1
4972	Servo loop gain multiplier of the spindle for gear 2
4973	Servo loop gain multiplier of the spindle for gear 3
4974	Servo loop gain multiplier of the spindle for gear 4

[Data type]

Word

Set the servo loop gain multipliers of the spindle for gears 1 to 4. The multipliers are used to convert the amount of the position deviation to the voltage used in the velocity command. Assign the data obtained from the following equation to the parameters.

$$\text{Loop gain multiplier} = 2048000 \times E \times A/L$$

where;

E : Voltage required to rotate the spindle motor at 1000 min^{-1} in the velocity command

L : Rotation angle of the spindle per one motor rotation (normally 360)

A : Unit used for the detection (degree)

[Example]

Let E be 2.2 V, L be 360 degrees, and A be 0.088 degrees/pulse.

$$\text{Loop gain multiplier} = 2048000 \times 2.2 \times 0.088/360 = 1101$$

* When the voltage specified for the spindle motor is 10 V at a spindle speed of 4500 min^{-1} , E is regarded as 2.2 V.

NOTE

The above parameters No.4971 to No.4974 are for analog spindles.

4.21 PARAMETERS OF TOOL COMPENSATION

	#7	#6	#5	#4	#3	#2	#1	#0
5001		EVO		EVR	TAL		TLB	TLC
		EVO	TPH	EVR	TAL	OFH	TLB	TLC

[Data type]	Bit
TLC	Tool length compensation 0 : Tool length compensation A or B (Conforms to TLB in parameter No.5001) 1 : Tool length compensation C
TLB	Tool length compensation axis 0 : Always Z axis irrespective of plane specification (Tool length compensation A) 1 : Axis perpendicular to plane specification (G17, G18, and G19) (Tool length compensation B)
OFH	Offset number of tool length compensation, cutter compensation and tool offset 0 : Specifies the tool length compensation using an H code, and cutter compensation C using a D code Tool offset conforms to TPH in parameter No.5001#5. 1 : Specifies the tool length compensation, cutter compensation and tool offset using H codes
TAL	Tool length compensation C 0 : Generates an alarm when two or more axes are offset 1 : Not generate an alarm even if two or more axes are offset
EVR	When a tool compensation value is changed in cutter compensation C mode: 0 : Enables the change, starting from that block where the next D or H code is specified. 1 : Enables the change, starting from that block where buffering is next performed.
TPH	Specifies whether address D or H is used as the address of tool offset number (G45 to G48). 0 : D code 1 : H code TPH is valid when OFH in parameter No.5001#2 is 0.
EVO	When in tool length compensation A or tool length compensation B, the tool compensation amount is changed in offset mode (G43 or G44) (for the M series) or when in tool position compensation, the compensation amount is changed (for the T series): 0 : A block specifying the next G43, G44, or an H code and subsequent blocks become valid. (M series) A block specifying the next T code and subsequent blocks become valid. (T series) 1 : A block to be buffered next and subsequent blocks become valid.

	#7	#6	#5	#4	#3	#2	#1	#0
5002	WNP	LWM	LGC	LGT		LWT	LGN	LD1

- [Data type] Bit
- LD1 Offset number of tool offset
 0 : Specified using the lower two digits of a T code
 1 : Specified using the lower one digit of a T code
- LGN Geometry offset number of tool offset
 0 : Is the same as wear offset number
 1 : Specifies the geometry offset number by the tool selection number
- LWT Tool wear compensation is performed by:
 0 : Moving the tool.
 1 : Shifting the coordinate system.
 (Only when the LGT parameter (bit 4 of No.5002) is set to 0)
- LGT Tool geometry compensation
 0 : Compensated by the shift of the coordinate system
 (Compensation is made in the block of T code regardless of LWM at this time.)
 1 : Compensated by the tool movement
- LGC Tool geometry compensation (It is effective when LGT = 0. When LGT is 1, it is always canceled.)
 0 : Not canceled by offset number 0
 1 : Canceled by offset number 0
- LWM Tool offset (Geometry and wear compensation when LGT = 1.)
 0 : Is done in the T code block
 1 : Is done together with the axis movement

NOTE

When LGT = 0, the offset is done in a T code block regardless of this parameter.

- WNP Imaginary tool tip direction used for tool nose radius compensation, is the direction specified by:
 0 : Geometry offset number
 1 : Wear offset number

	#7	#6	#5	#4	#3	#2	#1	#0
5003	TGC	LVC				CCN		
		LVK				CCN	SUV	SUP

- [Data type] Bit
- SUP Start up or cancel in cutter compensation C or cutter compensation for 5-axis machining
 0 : Type A
 1 : Type B
- SUV Startup or cancellation of cutter compensation C is:
 0 : Type A or type B. (The setting of bit 0 (SUP) of parameter No. 5003 is followed.)
 1 : Perpendicular to the next movement.

- CCN When automatic reference position return (G28) is specified in the cutter compensation C mode (M series) or in tool nose radius compensation (T series):
 - 0 : The cutter compensation or tool nose radius compensation vector is cancelled in movement to an intermediate position.
 - 1 : The cutter compensation or tool nose radius compensation vector is not cancelled in movement to an intermediate position, but is cancelled in movement to the reference position.
- LVC Offset value of tool offset
 - 0 : Not cleared, but held by reset
 - 1 : Cleared by reset
- LVK Tool length offset value
 - 0 : Cleared by reset
 - 1 : Not cleared, but held by reset
- TGC Tool geometry compensation value
 - 0 : Not canceled by reset
 - 1 : Canceled by reset

(Valid when LVC, #6 of parameter No.5003, is "1")

	#7	#6	#5	#4	#3	#2	#1	#0
5004	Y03				TS1		ORC	
						ODI		

NOTE
When this parameter is set, the power must be turned off before operation is continued.

- [Data type] Bit
- ORC Tool offset value
 - 0 : Set by the diameter specification
(Can be set in only the axis under diameter programming)
 - 1 : Set by the radius specification
- ODI A cutter compensation amount is set using:
 - 0 : A radius.
 - 1 : A diameter.
- TS1 When the tool offset measurement value direct input B function is used, touch sensor contact detection is based on:
 - 0 : Four-contact input.
 - 1 : One-contact input.
- Y03 Y axis offset is :
 - 0 : Used for 4th axis.
 - 1 : Used for 3rd axis.

	#7	#6	#5	#4	#3	#2	#1	#0
5005		TLE	QNI			PRC		CNI

- [Data type] Bit
- CNI On the offset screen, Y-axis offset screen, and macro screen, the [INP.C] soft key is:
0: Used.
1: Not used. (The [INP.C] soft key is not displayed.)
- PRC Direct input of tool offset value and workpiece coordinate-system shift value
0: Not use a PRC signal
1: Uses a PRC signal
- QNI In the function of input of offset value measured B
0: Not automatically select the tool offset number
1: Automatically selects a tool offset number
- TLE When the tool offset measurement value direct input B function is used, a tool offset value, set by the offset write signal, is:
0: Always received in offset write mode.
1: Received only in offset write mode and during movement along an axis (where "during movement along an axis" means that the positional deviation value is other than 0).

	#7	#6	#5	#4	#3	#2	#1	#0
5006							TGC	OIM
		TOS		TCE				OIM

- [Data type] Bit
- OIM When the unit is switched between the inch and metric systems, automatic tool offset value conversion is:
0: Not performed
1: Performed

NOTE

If this parameter setting is changed, reset the tool offset data.

- TGC When a T code is specified in a block containing G50, G04, or G10:
0: No alarm occurs.
1: P/S alarm No.245 occurs.
- TCE When a tool length offset is specified in a rigid tapping or drilling canned cycle, the axis to which the tool length offset applies is:
0: Determined according to the specifications of tool length offset C.
1: The drilling axis.

NOTE

This parameter is valid when tool length offset C is selected (bit 0 (TLC) of parameter No. 5001 = 1).

- TOS The operation of tool length compensation is set as follows:
 0 : Tool length compensation is performed by axis movement.
 1 : Tool length compensation is performed by shifting the coordinate system.

	#7	#6	#5	#4	#3	#2	#1	#0
5008			QCR	MCR	CNV		CNC	CNI
		GCS	QCR	MCR	CNV	G39	CNC	CNI

- [Data type] Bit
- CNI Interference check for cutter compensation C (M series) or tool nose radius compensation (T series) is:
 0 : Performed
 1 : Not performed
- CNC During interference check for cutter compensation C (M series) or tool nose radius compensation (T series), when the direction of movement after application of the offset differs from the programmed direction by between 90° and 270°:
 0 : An alarm is issued.
 1 : No alarm is issued.
- G39 The corner rounding function (G39) in cutter compensation C mode is:
 0 : Disabled.
 1 : Enabled.
- CNV The interference check and vector erasure of cutter compensation C (M series) or tool nose radius compensation (T series) are:
 0 : Performed.
 1 : Not performed.
- MCR If G41/G42 (cutter compensation C (M series) or tool nose radius compensation (T series)) is specified in the MDI mode, an alarm is:
 0 : Not raised.
 1 : Raised. (P/S5257)

NOTE

In the MDI mode, cutter compensation C (M series) or tool nose radius compensation (T series) is not performed, irrespective of the setting of this parameter.

- QCR The travel distance of circular interpolation in cutter compensation C (M series) or tool nose radius compensation (T series) is judged:
 0 : In the FS0(FS16) format.
 1 : In the FS15 format.
 FS0(FS16) and FS15 determine the travel distance in different ways if the radius of arc at the start point of circular interpolation is different from that at the end point (if the end point is not on the arc). By this parameter, the method of determining the travel distance of circular interpolation can be selected.

[FS0(FS16) format]

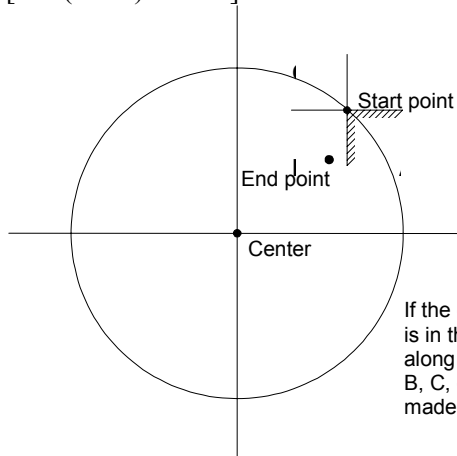

If the end point viewed from the start point is in the A region, the movement is made along the shortcut. If the end point is in the B, C, or D region, almost a single turn is made.

[FS15 format]

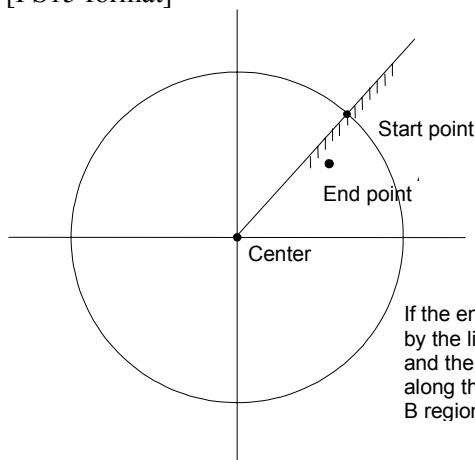

If the end point is in the A region separated by the line L drawn between the start point and the center, the movement is made along the shortcut. If the end point is in the B region, almost a single turn is made.

NOTE

The setting of this parameter determines the travel distance determination method for circular interpolation not during cutter compensation C (M series) or tool nose radius compensation (T series) as well. Accordingly, if this parameter is set, the setting of bit 3 (CQD) of parameter No. 3450 is invalid.

- GCS If G49 (G code for canceling tool length compensation) and G40 (G code for canceling cutter compensation) are specified in a single block, the tool length compensation is cancelled:
- 0 : In the next block.
 - 1 : In the specified block.

	#7	#6	#5	#4	#3	#2	#1	#0
5009	NTT			TSD	QSA			GSG

NOTE
When this parameter has been set, the power must be turned off before operation is continued.

- [Data type] Bit
- GSG In the mode of tool compensation direct input B, the offset write input signal is input:
 0 : From the machine side. <G004 bits 2 to 5>
 1 : From the PMC side. <G132 bits 0 and 1, G134 bits 0 and 1>
- QSA The angular axis control function is:
 0 : Not supported by the tool compensation direct input B function.
 1 : Supported by the tool compensation direct input B function.
- TSD In the tool compensation direct input B function, the error prevention function is:
 0 : Disabled.
 1 : Enabled.
- NTT When a shift type tool offset is applied during simplified synchronization control, and the master spindle and slave spindle are not related to the tool offset:
 0 : An alarm is issued. (P/S alarm 214)
 1 : No alarm is issued.

5010	Limit value that ignores the vector when a tool moves on the outside of a corner during tool nose radius compensation
	Limit value that ignores the vector when a tool moves on the outside of a corner during cutter compensation C

- [Data type] Word
- [Unit of data]

Input increment	IS-A	IS-B	IS-C	Unit
Millimeter input	0.01	0.001	0.0001	mm
Inch input	0.001	0.0001	0.00001	inch

- [Valid data range] 0 to 16383
- This parameter sets the limit value that ignores a slight movement occurring when a tool moves on the outside of the corner during tool nose radius compensation (T series) or cutter compensation C (M series).

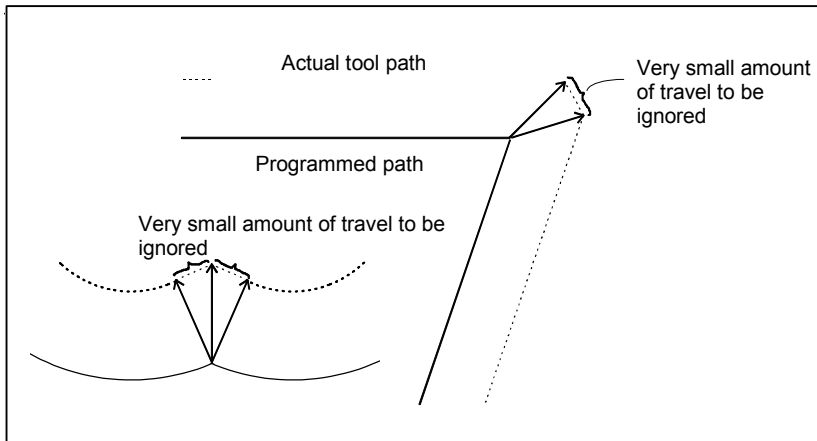

5013 Maximum value of tool wear compensation

[Data type] 2-word
 [Unit of data]

Input increment	IS-A	IS-B	IS-C	Unit
Millimeter input	0.01	0.001	0.0001	mm
Inch input	0.001	0.0001	0.00001	inch

[Valid data range]

Input increment	IS-A	IS-B	IS-C
Millimeter input	0 to 99999	0 to 999999	0 to 9999999
Inch input	0 to 99999	0 to 999999	0 to 9999999

This parameter sets the maximum allowable tool wear compensation value. If an attempt is made to set a tool wear compensation value, the absolute value of which exceeds the value set in this parameter, the following alarm or warning is output:

Input from MDI
 Warning: Too many digits
 Input by G10
 P/S alarm No.032: Offset value is out of range by G10.

5014 Maximum value of incremental input for tool wear compensation

[Data type] 2-word
 [Unit of data]

Input increment	IS-A	IS-B	IS-C	Unit
Millimeter input	0.01	0.001	0.0001	mm
Inch input	0.001	0.0001	0.00001	inch

[Valid data range]

Input increment	IS-A	IS-B	IS-C
Millimeter input	0 to 99999	0 to 999999	0 to 9999999
Inch input	0 to 99999	0 to 999999	0 to 9999999

Set the maximum allowable value for the tool wear compensation value, input as an incremental value. If the incremental input value (absolute value) exceeds the set value, the following alarm or warning message is output:

Input from MDI

Warning: Setting value out of range.

Input using G10

P/S alarm No.032: Offset value is out of range by G10.

5015	<p>Distance (XP) between reference position and X axis + contact surface Distance (X1P) between reference position and X axis + contact surface of touch sensor 1</p>
5016	<p>Distance (XM) between reference position and X axis - contact surface Distance (X1M) between reference position and X axis - contact surface of touch sensor 1</p>
5017	<p>Distance (ZP) between reference position and Z axis + contact surface Distance (Z1P) between reference position and Z axis + contact surface of touch sensor 1</p>
5018	<p>Distance (ZM) between reference position and Z axis - contact surface Distance (Z1M) between reference position and Z axis - contact surface of touch sensor 1</p>

[Data type] 2-word
 [Unit of data]

Input increment	IS-B	IS-C	Unit
Millimeter input	0.001	0.0001	mm
Inch input	0.0001	0.00001	inch

[Valid data range] -99999999 to 99999999
 These parameters are related to the function of input of tool offset value measured B.
 They set the distance (with sign) between the measurement reference position and sensor contact surface. For an axis under diameter programming, set it by a diameter value.

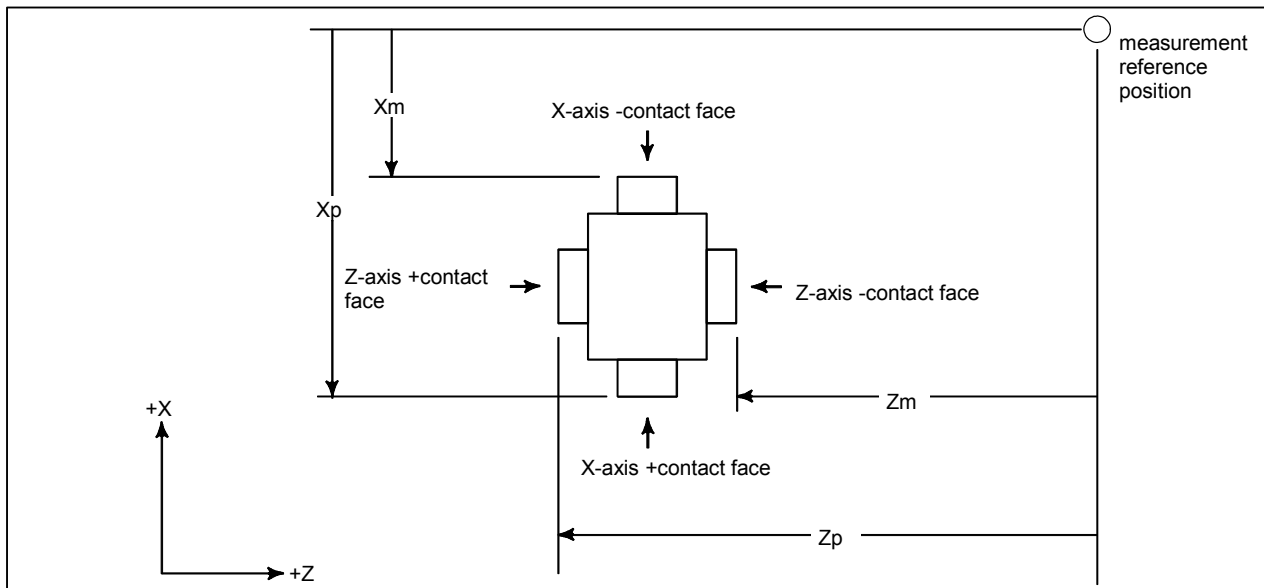

Fig.4.21 Distance along X and Z Axes from the Reference Position to +/- Contact Surfaces

5020	Tool offset number used for the input of tool offset value measured B
-------------	--

[Data type] Byte
 [Valid data range] 1 to the maximum number of tool compensation sets
 Set a tool offset number to be used for setting the amount by which the workpiece coordinate system is shifted by the tool compensation direct input B function. This parameter is valid when the tool offset number is not selected automatically (QNI, #5 of parameter 5005, is zero).

5021	Number of pulse interpolation cycles memorized prior to contacting the touch sensor
-------------	--

[Data type] Byte
 [Unit of data] Interpolation cycle
 [Valid data range] 0 to 8
 When the error prevention function in the tool compensation direct input B function is used, or when a touch sensor with single-contact signal input is used, this parameter sets the number of interpolation cycles of pulses stored immediately before the tool is brought into contact with the touch sensor by manual operation. If 0 is set for this parameter, the specification of 8 (maximum allowable value) is assumed.

NOTE
 This parameter is enabled when the TS1 parameter (bit 3 of parameter No.5004) is set to 1.

5030	Minimum grinding wheel diameter in minimum grinding wheel diameter check

[Data type] 2-word
 [Unit of data]

Input increment	IS-A	IS-B	IS-C	Unit
Millimeter input	0.01	0.001	0.0001	mm
Inch input	0.001	0.0001	0.00001	inch

[Valid data range]

Input increment	IS-A, IS-B	IS-C
Millimeter input	-999999 to 999999	-9999999 to 9999999
Inch input	-999999 to 999999	-9999999 to 9999999

If the compensation value corresponding to an offset number specified by an H code is smaller than the minimum grinding wheel diameter specified in this parameter during compensation with G43 or G44, the signal F0065#3 GWLF is output to the PMC.

NOTE
 This is a parameter for cylindrical grinding machines.

	#7	#6	#5	#4	#3	#2	#1	#0
5040								OWD

NOTE
 When this parameter has been set, the power must be turned off before operation is continued.

[Data type] Bit
 OWD In radius programming (bit 1 (ORC) of parameter No. 5004 is set to 1),
 0 : Tool offset values of both geometry compensation and wear compensation are specified by radius.
 1 : Tool offset value of geometry compensation is specified by radius and tool offset value of wear compensation is specified by diameter, for an axis of diameter programming.

	#7	#6	#5	#4	#3	#2	#1	#0
5041					CRS			
	NM2					UMD		

[Data type] Bit
 UMD If a program contains no D command in cutter compensation C:
 0 : Compensation data is not updated.
 1 : If G41 or G42 command is present, the value of modal D is used as a compensation number to update compensation data.

CRS If a startup with a travel distance of 0 is performed after a reference position return operation when a T code specifying a virtual tool tip number other than 0 and 9 is specified, the startup block operation is as follows:

0 : The block does not make any movement.

1 : The block makes a movement so that the tool tip center is placed at the current coordinates.

NOTE

If the virtual tool tip number is 0 or 9, a movement is made so that the tool tip center is placed at the current coordinates, regardless of the setting of this parameter.

NM2 When two or more blocks that specify no movement are specified successively, or when an M code not buffered is specified in one block:

0 : No alarm is issued.

1 : An alarm is issued. (P/S 041 alarm)

4.22 PARAMETERS OF CANNED CYCLES

4.22.1 Parameter of canned Cycle for Drilling

	#7	#6	#5	#4	#3	#2	#1	#0
5101		M5T			ILV	RTR		FXY
	M5B	M5T	RD2	RD1			EXC	FXY

- [Data type] Bit
 FXY The drilling axis in the drilling canned cycle is:
 0 : Always the Z-axis
 1 : The axis selected by the program

NOTE
 In the case of the T series, this parameter is valid only for the drilling canned cycle in the FS10/11 format.

- EXC G81
 0 : Specifies a drilling canned cycle
 1 : Specifies an external operation command
- RTR G83 and G87
 0 : Specify a high-speed peck drilling cycle
 1 : Specify a peck drilling cycle
- ILV Initial point position in drilling canned cycle
 0 : Not updated by reset
 1 : Updated by reset
- RD2, RD1 Set the axis and direction in which the tool in drilling canned cycle G76 or G87 is got free. RD2 and RD1 are set as shown below by plane selection.

RD2	RD1	G17	G18	G19
0	0	+X	+Z	+Y
0	1	-X	-Z	-Y
1	0	+Y	+X	+Z
1	1	-Y	-X	-Z

- M5T When a spindle rotates from the forward to the reverse direction and vice versa in tapping cycles G84 and G74 for M series (G84 and G88 for T series), before M04 or M03 is output:
 For T series
 0 : Not output M05
 1 : Outputs M05
 For M series
 0 : Outputs M05
 1 : Not output M05
- M5B In drilling canned cycles G76 and G87:
 0 : Outputs M05 before an oriented spindle stops
 1 : Not output M05 before an oriented spindle stops

	#7	#6	#5	#4	#3	#2	#1	#0
5102	RDI	RAB	K0E	RFC	F16	QSR	MRC	

[Data type] Bit

MRC When a target figure other than a monotonically increasing or monotonically decreasing figure is specified in a multiple repetitive turning canned cycle (G71, G72):
 0 : No alarm occurs.
 1 : P/S alarm No.064 is occurs.

NOTE

This parameter is valid for multiple repetitive turning canned cycle type I.

- QSR Before a multiple repetitive canned cycle (G70 to G73) is started, a check to see if the program contains a block that has the sequence number specified in address Q is:
 0 : Not made.
 1 : Made. (If the sequence number specified in address Q cannot be found, an alarm occurs and the canned cycle is not executed.)
- F16 When the FS10/11 format is used (with bit 1 (FCV) of parameter No.0001 set to 1), a canned drilling cycle is specified using :
 0 : FS10/11 format
 1 : FS0 format. (However, the number of repetitions is specified using address L.)
- RFC For the semifinish figure of G71 or G72 and for a cutting pattern of G73, tool-nose radius compensation is:
 0 : Not performed.
 1 : Performed.
- K0E When K0 is specified in a hole machining canned cycle (G80 to G89):
 0 : Hole machining is performed once.
 1 : Hole machining is not performed. Instead, the hole machining data is merely memorized.
- RAB The R command for the drilling canned cycle in the Series 15 format is:
 0 : Regarded as an incremental command
 1 : Regarded as:
 An absolute command in the case of G code system A
 An absolute command in the case of G code system B or C when the G90 mode is specified.
 An incremental command in the case of G code system B or C when the G91 mode is specified.
- RDI The R command for the drilling canned cycle in the FS10/11 format:
 0 : Is regarded as the specification of a radius
 1 : Follows the specification of a diameter/radius for the drilling axis

	#7	#6	#5	#4	#3	#2	#1	#0
5103		TCZ	CID	COD	PNA	P15	TFD	
		TCZ				DCP	QZA	SIJ

[Data type]	Bit
SIJ	When the FS10/11 command format is used, a tool shift value for the drilling canned cycle G76 or G87 is specified by: 0 : Address Q 1 : Address I, J, or K
TFD	During a threading cycle, feed forward is: 0 : Enabled. 1 : Disabled.
QZA	When the specification of the depth of cut (Q) for each time is omitted, or if Q0 is specified in a high-speed peck drilling canned cycle (G73) or peck drilling canned cycle (G83): 0 : No alarm is issued. 1 : An alarm (No.045) is issued.
P15	When the FS10/11 command format is used, the machining sequence for pocketing using multiple repetitive canned cycle G71 or G72 follows: 0 : FS0(FS16) specification 1 : FS10/11 specification
DCP	When an axis perpendicular to or an axis parallel to a specified plane is specified in a canned cycle for drilling: 0 : The specified axis is regarded as the drilling axis. 1 : The specified axis is regarded as the positioning axis.
PNA	If the FS10/11 tape format is used and if a plane without an axis is specified in the canned cycle mode of drilling, an alarm is: 0 : Raised. (P/S 028) 1 : Not raised.
COD	In pocketing, the sequence of axis movements made to return the tool to the start point at the end of machining is as follows: 0 : X-axis to Z-axis 1 : Z-axis to X-axis

NOTE

If this parameter is set to 1, specifying G71 causes the tool to return to the start point in the sequence from Z-axis to X-axis. Therefore, when the tool returns to the start point after end facing, interference between the tool and workpiece surface can be prevented.

CID	When the FS10/11 command format is used, application of the setting of bit 7 (IPR) of parameter No. 1004 to the depth of cut in a multiple repetitive turning canned cycle is: 0 : Disabled. 1 : Enabled.
TCZ	In a tapping cycle (excluding rigid tapping), an accumulated zero check in the tapping step (forward, backward) is: 0 : Not performed. 1 : Performed. Execute a tapping cycle (excluding rigid tapping) with the servo feed forward (bit 1 of parameter No. 2005). If an impact is detected, set this parameter to 1.

	#7	#6	#5	#4	#3	#2	#1	#0
5104		PCT	MCC	SPE		FCK	BCR	
								RDC

- [Data type] Bit
- RDC A canned cycle for high-speed positioning and drilling is:
 0 : Disabled.
 1 : Enabled.
- BCR In a boring cycle, retraction is made:
 0 : At a cutting feedrate.
 1 : At a rapid traverse rate.
- FCK In a multiple repetitive canned cycle (G71/G72), the machining profile is:
 0 : Not checked.
 1 : Checked.
- If this parameter is specified, the machining profile specified in the multiple repetitive canned cycle for lathe (G71/G72) and the machining start point are checked. If the relationship is incorrect, the P/S 062 alarm is raised.
- An incorrect relationship between the machining profile and machining start point indicates either of the following cases.
- Although the finishing allowance is specified with a positive sign, the start point of the canned cycle is smaller than the maximum value of the machining profile.
 - Although the finishing allowance is specified with a negative sign, the start point of the canned cycle is larger than the minimum value of the machining profile.

NOTE

- 1 The machining profile is checked before the operation of the canned cycle (not during machining).
- 2 The machining profile to be checked is a programmed profile. The path of retraction or return is not checked.
- 3 This parameter is not valid for G71 or G72 of the canned cycle for grinder.

- SPE In a multiple repetitive threading cycle in the FS10/11 tape format, single-edge thread cutting and both-edge zigzag thread cutting with the depth of cut kept constant:
 0 : Cannot be specified.
 1 : Can be specified.
- MCC In a multiple repetitive turning canned cycle (G71 or G72), whether an illegal arc is specified or not is:
 0 : Not checked immediately before the start of a movement.
 1 : Checked immediately before the start of a movement.

NOTE

- 1 This parameter is valid when bit 1 (MRC) of parameter No. 5102 is set to 1.
- 2 Regardless of the setting of this parameter, the shape is checked during a movement made by an arc command.

PCT A Q command in a tapping cycle (G84 or G88) is:

0 : Invalid.

1 : Valid. (A peck tapping cycle is performed.)

When this parameter is set, and the depth of cut for each time is specified with address Q in G84 or G88, a peck tapping cycle is performed.

As a peck tapping cycle operation, high-speed peck tapping or peck tapping can be selected by bit 5 (PCP) of parameter No. 5200. This function can be used for both tapping and rigid tapping. Even when this parameter is set, ordinary tapping or rigid tapping is performed if Q is not specified or if Q0 is specified.

5110	C-axis clamp M code in drilling canned cycle
-------------	---

[Data type] 2-word

[Valid data range] 0 to 99

This parameter sets the C-axis clamp M code in a drilling canned cycle.

5111	Dwell time when C-axis unclamping is specified in drilling canned cycle
-------------	--

[Data type] Word

[Unit of data] ms

[Valid data range] 0 to 32767

This parameter sets the dwell time when C-axis unclamping is specified in a drilling canned cycle.

5112	Spindle forward-rotation M code in drilling canned cycle

[Data type] 2-word
 [Valid data range] 0 to 255
 This parameter sets the spindle forward-rotation M code in a drilling canned cycle.

NOTE
 M03 is output when "0" is set.

5113	Spindle reverse-rotation M code in drilling canned cycle

[Data type] 2-word
 [Valid data range] 0 to 255
 This parameter sets the spindle reverse-rotation M code in a drilling canned cycle.

NOTE
 M04 is output when "0" is set.

5114	Return or clearance value of drilling canned cycle G83
	Return value of high-speed peck drilling cycle G73

[Data type] Word
 [Unit of data]

Input increment	IS-A	IS-B	IS-C	Unit
Millimeter input	0.01	0.001	0.001	mm
Inch input	0.001	0.0001	0.0001	inch

[Valid data range] 0 to 32767
 For M series this parameter sets the return value in high-speed peck drilling cycle G73 (G83 for T series).

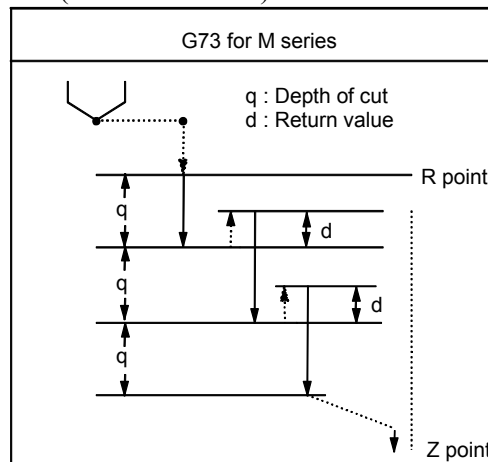

Fig.4.22.1 (a) High-speed Peck Drilling Cycle G73

For T series this parameter sets the return or clearance value in drilling canned cycle G83.

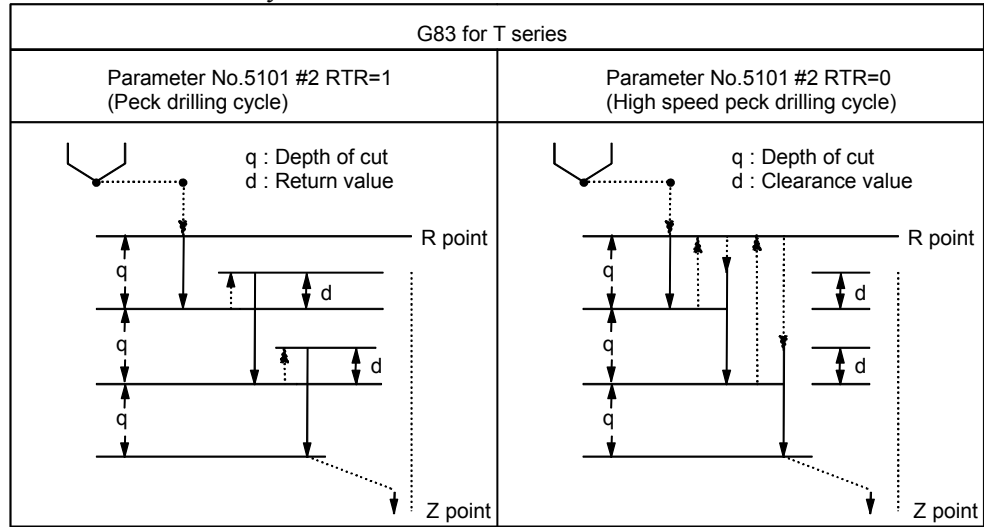

Fig.4.22.1 (b) Drilling Canned Cycle G83

5115	
	Clearance of canned cycle G83

[Data type] Word
 [Unit of data]

Input increment	IS-A	IS-B	IS-C	Unit
Millimeter input	0.01	0.001	0.001	mm
Inch input	0.001	0.0001	0.0001	inch

[Valid data range] 0 to 32767

This parameter sets the clearance of peck drilling cycle G83.

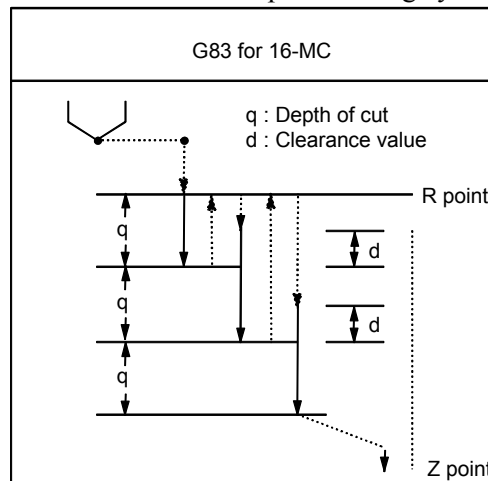

Fig.4.22.1 (c) Peck drilling cycle G83

5121	Override value for retraction in boring cycle (G85, G89)

[Data type] Byte
 [Unit of data] 100%
 [Valid data range] 0.1 to 20
 Set the override value of retraction in a boring cycle.
 If 20 or a greater value is specified in this parameter, the override is set to 2000%. If 0 is specified, this parameter becomes invalid, and the retraction speed becomes two times the cutting speed.

4.22.2 Parameter of Thread Cutting Cycle

5130	Chamfering distance in the thread cutting cycles G76 and G92

[Data type] Byte
 [Unit of data] 0.1 pitch
 [Valid data range] 0 to 127
 This parameter sets the chamfering in the thread cutting cycles G76 and G92.

5131	Chamfering angle in threading cycle

[Data type] Byte
 [Unit of data] 1 deg
 [Valid data range] 1 to 89
 Set a chamfering angle in a threading cycle.

4.22.3 Parameter of Multiple Repetitive Canned Cycle

5132	Depth of cut in multiple repetitive canned cycles G71 and G72

[Data type] 2-word
 [Unit of data]

Input increment	IS-B	IS-C	Unit
Millimeter input	0.001	0.001	mm
Inch input	0.0001	0.0001	inch

[Valid data range] 0 to 99999999
 This parameter sets the depth of cut in multiple repetitive canned cycles G71 and G72.

5133	Escape in multiple repetitive canned cycles G71 and G72.

[Data type] 2-word
 [Unit of data]

Input increment	IS-B	IS-C	Unit
Millimeter input	0.001	0.001	mm
Inch input	0.0001	0.0001	inch

[Valid data range] 0 to 99999999
 This parameter sets the escape in multiple repetitive canned cycle G71 and G72.

5135	Escape in multiple repetitive canned cycle G73 in X-axis direction

5136	Escape in multiple repetitive canned cycle G73 in Z-axis direction

[Data type] 2-word
 [Unit of data]

Input increment	IS-B	IS-C	Unit
Millimeter input	0.001	0.001	mm
Inch input	0.0001	0.0001	inch

[Valid data range] -99999999 to 99999999
 This parameter sets the escape in multiple repetitive canned cycle G73 of an X, then Z axis.

5137	Division count in multiple repetitive canned cycle G73

[Data type] 2-word
 [Unit of data] Cycle
 [Valid data range] 1 to 99999999
 This parameter sets the division count in multiple repetitive canned cycle G73.

5139	Return in multiple canned cycles G74 and G75

[Data type] 2-word
 [Unit of data]

Input increment	IS-B	IS-C	Unit
Millimeter input	0.001	0.001	mm
Inch input	0.0001	0.0001	inch

[Valid data range] 0 to 99999999
 This parameter sets the return in multiple repetitive canned cycles G74 and G75.

5140	Minimum depth of cut in the multiple repetitive canned cycle G76

[Data type] 2-word
 [Unit of data]

Input increment	IS-B	IS-C	Unit
Millimeter input	0.001	0.0001	mm
Inch input	0.0001	0.00001	inch

[Valid data range] 0 to 99999999
 This parameter sets the minimum depth of cut in the multiple repetitive canned cycle G76.

5141	Finishing allowance in the multiple repetitive canned cycle G76

[Data type] 2-word
 [Unit of data]

Input increment	IS-B	IS-C	Unit
Millimeter input	0.001	0.0001	mm
Inch input	0.0001	0.00001	inch

[Valid data range] 1 to 99999999
 This parameter sets the finishing allowance in multiple repetitive canned cycle G76.

5142	Repetition count of final finishing in multiple repetitive canned cycle G76

[Data type] 2-word
 [Unit of data] Cycle
 [Valid data range] 1 to 99999999
 This parameter sets the repetition count in multiple repetitive canned cycle G76.

5143	Tool nose angle in multiple repetitive canned cycle G76

[Data type] 2-word
 [Unit of data] Degree
 [Valid data range] When FS10/11 format is used: 0 to 120
 When FS10/11 format is not used: 0, 29, 30, 55, 60, 80
 This parameter sets the tool nose angle in multiple repetitive canned cycle G76.

5144	The amount of retraction from the crest of a pocket of type II in roughing cycle (G71, G72)

[Data type] 2-word
[Unit of data]

Input increment	IS-B	IS-C	Unit
Linear axis (input in mm)	0.001	0.0001	mm
Linear axis (input in inches)	0.0001	0.00001	inch

[Valid data range] 0 to 99999999

This parameter sets the amount of retraction from a crest to be crossed to move to the next pocket to be roughed after roughing of a pocket of type II in roughing cycle (G71 or G72) ends.

If this parameter is set to 0, 2000 (IS-B) or 20000 (IS-C) is assumed by default. When 0 is set for IS-B metric input, for example, the amount of retraction is assumed to be 1.0 mm if a radius is specified (bit 3 (DIA) of parameter No. 1006 = 0) or 2.0 mm if a diameter is specified (bit 3 (DIA) of parameter No. 1006 = 1).

5150	
	Inertial running distance in a canned cycle for high-speed positioning and drilling

[Data type] 2-word
[Unit of data]

Input increment	IS-A	IS-B	IS-C	Unit
Millimeter input	0.01	0.001	0.0001	mm
Inch input	0.001	0.0001	0.00001	inch

[Valid data range] 0 to 99999999

This parameter sets the distance of inertial running in a canned cycle for high-speed positioning and drilling.

5151	
	Rapid traverse deceleration ratio for overlap between rapid traverse blocks in a canned cycle for high-speed positioning and drilling

[Data type] Byte
[Unit of data] %
[Valid data range] 0 to 100

This parameter sets the rapid traverse deceleration ratio for an overlap between rapid traverse blocks in a canned cycle for high-speed positioning and drilling. In the cycle, the setting of this parameter is valid for all axes.

NOTE

In a canned cycle for high-speed positioning and drilling, a rapid traverse overlap is applied even when bit 4 (RTO) of parameter No. 1601 is set to 0. To disable the rapid traverse overlap, set this parameter to 0.

4.22.4 Parameters of Peck Drilling Cycle of a Small Diameter

	#7	#6	#5	#4	#3	#2	#1	#0
5160					CYM			
					CYM	NOL	OLS	

- [Data type] Bit
- OLS When an overload torque signal is received in a peck drilling cycle of a small diameter, the feed and spindle speed are
0 : Not changed.
1 : Changed.
 - NOL When the depth of cut per action is satisfied although no overload torque signal is received in a peck drilling cycle of a small diameter, the feed and spindle speed are:
0 : Not changed.
1 : Changed.
 - CYM When a subprogram call (M98) and another NC command are specified in the same block in a canned cycle mode:
0 : No alarm is issued.
1 : AN alarm is issued. (P/S alarm 5329)

	#7	#6	#5	#4	#3	#2	#1	#0
5161							RLV	PKG

- [Data type] Bit
- PKG Method for specifying a high-speed peck drilling cycle and a peck drilling cycle
0 : G83 or G87 is used, and a high-speed peck drilling or peck drilling cycle is selected by bit 2 (RTR) of parameter No. 5101.
1 : A specification is added to the G83 or G87 command so that a high-speed peck drilling cycle can be specified using G83.5 or G87.5 and that a peck drilling cycle can be specified using G83.6 or G87.6.

NOTE
When the FS10/11 format is used (when bit 1 (FCV) of parameter No. 0001 is set to 1), this parameter is invalid.

- RLV For G code system A, the return operation in a drilling canned cycle performs:
0 : A return to the initial level.
1 : A return to the level of the R point.

NOTE
For G code systems B and C, a selection is made using G codes.
G98: Return to the initial level
G99: Return to the level of the R point

5163	
	M code that specifies the peck drilling cycle mode of a small diameter

[Data type] 2-word
 [Valid data range] 1 to 99999999
 This parameter sets an M code that specifies the peck drilling cycle mode of a small diameter.

5164	
	Percentage of the spindle speed to be changed when the tool is retracted after an overload torque signal is received

[Data type] Byte
 [Unit of data] %
 [Valid data range] 1 to 255
 This parameter sets the percentage of the spindle speed to be changed when the tool is retracted because the overload torque signal is received in a peck drilling cycle of a small diameter.
 $S2 = S1 \times d1 \div 100$
 S1: Spindle speed to be changed
 S2: Spindle speed changed
 d1 is set as a percentage.

5165	
	Percentage of the spindle speed to be changed when the tool is retracted without an overload torque signal received

[Data type] Byte
 [Unit of data] %
 [Valid data range] 1 to 255
 This parameter sets the percentage of the spindle speed to be changed when the tool is retracted without the overload torque signal received in a peck drilling cycle of a small diameter.
 $S2 = S1 \times d2 \div 100$
 S1: Spindle speed to be changed
 S2: Spindle speed changed
 d2 is set as a percentage.

5166	Percentage of cutting feedrate to be changed when the tool is retracted after an overload torque signal is received
-------------	--

[Data type]	Byte
[Unit of data]	%
[Valid data range]	1 to 255
	This parameter sets the percentage of the cutting feedrate to be changed when the tool is retracted because the overload torque signal is received in a peck drilling cycle of a small diameter.
	$F2 = F1 \times b1 \div 100$
	F1: Cutting feedrate to be changed
	F2: Changed cutting feedrate
	b1 is set as a percentage.

5167	Percentage of the cutting feedrate to be changed when the tool is retracted without an overload torque signal received
-------------	---

[Data type]	Byte
[Unit of data]	%
[Valid data range]	1 to 255
	This parameter sets the percentage of the cutting feedrate to be changed when the tool is retracted without the overload torque signal received in a peck drilling cycle of a small diameter.
	$F2 = F1 \times b2 \div 100$
	F1: Cutting feedrate to be changed
	F2: Changed cutting feedrate
	b2 is set as a percentage.

5168	Lower limit of the percentage of the cutting feedrate in a peck drilling cycle of a small diameter
-------------	---

[Data type]	Byte
[Unit of data]	%
[Valid data range]	0 to 255
	This parameter sets the lower limit of the percentage of the cutting feedrate changed repeatedly in a peck drilling cycle of a small diameter to the specified cutting feedrate.
	$FL = F \times b3 \div 100$
	F: Specified cutting feedrate
	FL: Changed cutting feedrate
	Set b3 as a percentage.

5170	Number of the macro variable to which the total number of retractions during cutting is output
-------------	---

[Data type] Word
 [Valid data range] 100 to 149

This parameter sets the number of the macro variable to which the total number of times the tool is retracted during cutting in a peck drilling cycle mode of a small diameter is output.

NOTE

The total number cannot be output to common variables 500 to 531.

5171	Number of the macro variable to which the total umber of retractions because of an overload signal is output
-------------	---

[Data type] Word
 [Valid data range] 100 to 149

This parameter sets the common variable number of the custom macro to which the number of times the tool is retracted after the overload signal is received during cutting in a peck drilling cycle mode of a small diameter is output.

NOTE

The total number cannot be output to common variables 500 to 531.

5172	Speed of retraction to point R when no address I is issued
-------------	---

[Data type] Word
 [Unit of data] mm/min
 [Valid data range] 0 to 400

This parameter sets the speed of retraction to point R when no address I is issued in a peck drilling cycle of a small diameter.

5173	Speed of advancing to the position just before the bottom of a hole when no address I is issued
-------------	--

[Data type] Word
 [Unit of data] mm/min
 [Valid data range] 0 to 400

This parameter sets the speed of advancing to the position just before the bottom of a previously machined hole when no address I is issued in a peck drilling cycle of a small diameter.

5174	
	Clearance in a peck drilling cycle of a small diameter

[Data type] Word
 [Unit of data]

Input increment	IS-A	IS-B	IS-C	Unit
Linear axis (input in mm)	0.01	0.001	0.0001	mm
Linear axis (input in inches)	0.001	0.0001	0.00001	inch

[Valid data range] 0 to 32767
 This parameter sets the clearling cycle in a peck drilling cycle of a small diameter.

4.23 PARAMETERS OF RIGID TAPPING

5200	#7	#6	#5	#4	#3	#2	#1	#0
	SRS	FHD		DOV	SIG	CRG	VGR	G84
	FHD	PCP	DOV	SIG	CRG	VGR	G84	

[Data type] Bit

G84 Method for specifying rigid tapping

0 : An M code specifying the rigid tapping mode is specified prior to the issue of the G84 (or G74) command. (See parameter No.5210).

1 : An M code specifying the rigid tapping mode is not used. (G84 cannot be used as a G code for the tapping cycle; G74 cannot be used for the reverse tapping cycle.)

VGR Any gear ratio between spindle and position coder in rigid tapping

0 : Not used (The gear ratio is set in parameter No.3706.)

1 : Used (The gear ratio is set by parameters Nos. 5221 through 5224 and 5231 through 5234.)

NOTE

For serial spindles, set this parameter to 0 when using the DMR function for position coder signals on the spindle side.

CRG Rigid mode when a rigid mode cancel command is specified (G80, G01 group G code, reset, etc.)

0 : Canceled after rigid tapping signal RGTAP <G061#0> is set to "0".

1 : Canceled before rigid tapping signal RGTAP <G061#0> is set to "0".

SIG When gears are changed for rigid tapping, the use of SIND <G032 and G033> is

0 : Not permitted.

1 : Permitted.

DOV Override during extraction in rigid tapping

0 : Invalidated

1 : Validated (The override value is set in parameter No.5211 (M/T) or No.5381(M).)

PCP Tapping or rigid tapping

0 : Used as a high-speed peck tapping cycle

1 : Not used as a high-speed peck tapping cycle

For the T series, this parameter is valid when bit 6 (PCT) of parameter No. 5104 is set to 1.

According to the setting of this parameter, also set parameter No. 5213.

FHD Feed hold and single block in rigid tapping

0 : Invalidated

1 : Validated

SRS To select a spindle used for rigid tapping in multi-spindle control:

- 0 : The spindle selection signals SWS1 and SWS2 (bits 0 and 1 of G027) are used. (These signals are used also for multi-spindle control.)
- 1 : The rigid tapping spindle selection signals RGTSP1 and RGTSP2 (bits 4 and 5 of G061) are used. (These signals are provided expressly for rigid tapping.)

	#7	#6	#5	#4	#3	#2	#1	#0
5201				OV3	OVU	TDR		
				OV3	OVU	TDR		NIZ

- [Data type] Bit
- NIZ Smoothing in rigid tapping is:
 0 : Not performed.
 1 : Performed.
- TDR Cutting time constant in rigid tapping
 0 : Uses a same parameter during cutting and extraction (Parameter Nos. 5261 through 5264)
 1 : Not use a same parameter during cutting and extraction
 Parameter Nos. 5261 to 5264: Time constant during cutting
 Parameter Nos. 5271 to 5274: Time constant during extraction
- OVU The increment unit of the override parameter (No.5211 (M/T) or No.5381 (M)) for tool rigid tapping extraction is:
 0 : 1%
 1 : 10%
- OV3 The spindle speed for tool extraction is specified by program. The tool extraction function based on this spindle speed is:
 0 : Disabled.
 1 : Enabled.

	#7	#6	#5	#4	#3	#2	#1	#0
5202								ORI
							RG3	ORI

NOTE
 When this parameter is set, the power must be turned off before operation is continued.

- [Data type] Bit
- ORI When rigid tapping is started:
 0 : Spindle orientation is not performed.
 1 : Spindle orientation is performed.

NOTE
 This parameter can be used only for a serial spindle.

- RG3 A rigid tapping return operation is specified:
 0 : With input signal RTNT <G062#6>.
 1 : With one-shot G code G30.

	#7	#6	#5	#4	#3	#2	#1	#0
5203				OVS	RGS			
			RBL	OVS		RFF		

[Data type] Bit

REF Feed forward during movement from the initial point to point R in rigid tapping is:

0 : Disabled.

1 : Enabled.

When this parameter is set, the following function is also enabled:

- When rigid tapping is specified in advanced preview control mode, the system automatically exits from advanced preview control mode and executes rigid tapping. After termination of rigid tapping, the system automatically returns to look-ahead control mode.

RGS When bit 0 (MIF) of parameter No. 1403 is set to 1 and rigid tapping is specified in feed-per-minute mode, the spindle speed becomes:

0 : 1/1000 of the specified speed.

1 : 1/1 of the specified speed.

OVS In rigid tapping, override by the feedrate override signal and invalidation of override by the override cancel signal is:

0 : Disabled.

1 : Enabled.

Setting this parameter enables override by the feedrate override signal <G012> to be applied for rigid tapping operation (cutting and extraction) in rigid tapping.

The spindle speed override is fixed to 100%, but override is also applied to the spindle speed in synchronization with the feedrate along the tapping axis by feedrate override.

The override cancel signal OVC <bit 4 of G006> also becomes available.

NOTE

- 1 When this parameter is set to override the feedrate, override by parameters (see parameters Nos. 5211 (T/M) and 5381 (M)) is disabled.
- 2 Regardless of whether this parameter is set, when feedrate override is disabled by the override cancel signal OVC <bit 4 of G006>, override by parameters (see parameters Nos. 5211 (T/M) and 5381 (M)) is enabled.

RBL As acceleration/deceleration for rigid tapping cutting feed:

0 : Linear acceleration/deceleration is used.

1 : Bell-shaped acceleration/deceleration is used.

NOTE

The bell-shaped acceleration/deceleration option for rigid tapping is required.

5204	#7	#6	#5	#4	#3	#2	#1	#0
							SPR	DGN
								DGN

NOTE

When this parameter is set, the power must be turned off before operation is continued.

- [Data type] Bit
 DGN On the diagnosis screen:
 0 : A rigid tapping synchronization error is displayed. (Nos. 455 to 457)
 1 : An error difference between the spindle and tapping axis is displayed. (Nos. 452 and 453)
 SPR In rigid tapping, the parameters are:
 0 : Not changed on a spindle-by-spindle basis.
 1 : Changed on a spindle-by-spindle basis.

NOTE

- 1 When switching between the rigid tapping parameters on a spindle-by-spindle basis in rigid tapping using the second serial spindle, set this parameter to 1. The following parameters are supported for each spindle:

First spindle	Second spindle (2-stage gear)
No.5214	No.5215
No.5221 to No.5224	No.5225, No.5226
No.5231 to No.5234	No.5235, No.5236
No.5241 to No.5244	No.5245, No.5246
No.5261 to No.5264	No.5265, No.5266
No.5271 to No.5274	No.5335, No.5336
No.5280	No.5341
No.5281 to No.5284	No.5342, No.5343
No.5300, No.5301	No.5302, No.5303
No.5310 to No.5314	No.5350 to No.5353
No.5321 to No.5324	No.5325, No.5326

- 2 For rigid tapping using the second serial spindle, the multispindle control option is required.

	#7	#6	#5	#4	#3	#2	#1	#0
5205	REF	PKD						RCK
	REF					NRV		RCK

- [Data type] Bit
- RCK In rigid tapping, an excessive error during movement/at stop is:
 0 : Checked regardless of whether mode is cutting (tapping) or rapid traverse.
 1 : Checked only in cutting (tapping) mode.
- NRV For the rigid tapping function, the spindle returns back from the bottom of a hole with:
 0 : Rotating opposite to the drilling direction
 1 : Rotating in the drilling direction (special purpose)

CAUTION
 This parameter is intended for special uses only. When rigid tapping is performed, therefore, this parameter must not be set. If rigid tapping is performed with this parameter set, a tapping tool, workpiece, or machine may be damaged.

- PKD For rigid peck tapping, diagnostic number 457 (maximum rigid tapping synchronization error) indicates:
 0 : A value per tap operation.
 1 : A total value until the hole bottom is reached.
- REF Fine acceleration/deceleration during rigid tapping is:
 0 : Disabled.
 1 : Enabled.
 To use the spindle fine acceleration/deceleration (FAD) function, set 1.

NOTE
 When fine acceleration/deceleration is used, fine acceleration/deceleration settings for the spindle and servo system must be made in addition to the setting of this parameter.

5210	Rigid tapping mode specification M code
-------------	--

- [Data type] Byte
- [Valid data range] 0 to 255
- This parameter sets an M code that specifies the rigid tapping mode.

NOTE
 1 A setting value of 0 is assumed to be 29 (M29).
 2 To use an M code whose number is greater than 256, Specify the code number with parameter No.5212.

5211	Override value during rigid tapping extraction
-------------	---

[Data type] Byte
 [Unit of data] 1 % or 10 %
 [Valid data range] 0 to 200
 The parameter sets the override value during rigid tapping extraction.

NOTE
 The override value is valid when DOV in parameter No.5200 #4 is "1".
 When OVU (bit 3 of parameter No.5201) is 1, the unit of set data is 10%. An override of up to 200% can be applied to extraction.

5212	M code that specifies a rigid tapping mode
-------------	---

[Data type] 2-word
 [Unit of data] Integer
 [Valid data range] 0 to 65535
 This parameter sets the M code that specifies the rigid tapping mode. The M code that specifies the rigid tapping mode is usually set by parameter 5210. To use an M code whose number is greater than 256, specify the code number with parameter 5212.

NOTE
 If the setting of this parameter is 0, the M code specifying the rigid tapping mode is determined by the setting of parameter 5210. Otherwise, it is determined by the setting of parameter 5212. The setting of parameter 5212 must always be within the above valid range.

5213	Return or clearance in peck tapping cycle
-------------	--

[Data type] Word
 [Unit of data]

Input increment	IS-A	IS-B	IS-C	Unit
Millimeter input	0.01	0.001	0.001	mm
Inch input	0.001	0.0001	0.0001	inch

[Valid data range] 0 to 32767
 This parameter sets the return or clearance in the peck tapping cycle.

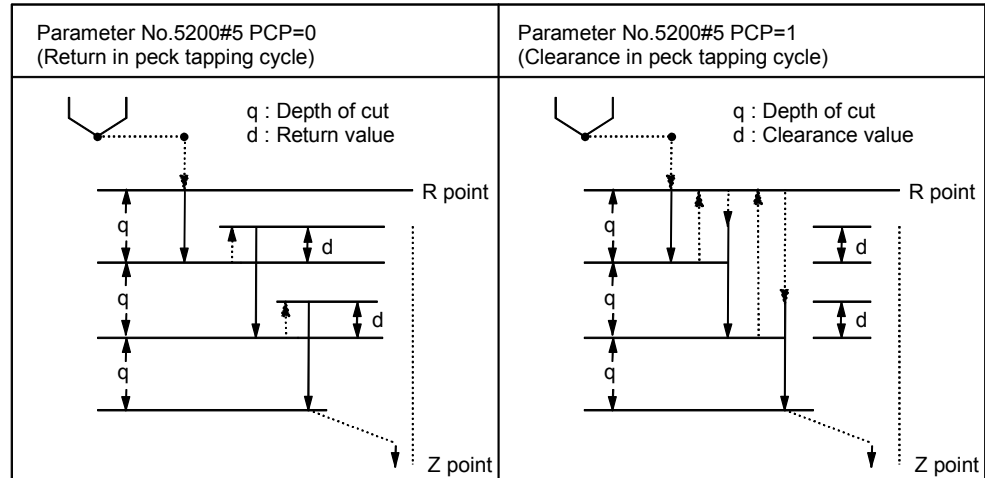

Fig.4.23 (a) High-speed Peck Drilling and Peck Drilling Cycles

5214	Setting of an allowable rigid tapping synchronization error range
5215	Setting of an allowable rigid tapping synchronization error range for the second spindle

[Data type]
 [Unit of data]
 [Valid data range]

Word
 Detection unit (1/4096rev)
 0 to 32767
 Each of these parameters is used to set an allowable synchronization error range between a spindle used for rigid tapping and the tapping axis.
 If the value set with each parameter is exceeded, rigid tapping alarm No.741 (excessive error during movement) is issued. When 0 is set, a synchronization error check is not made.

NOTE
 When rigid tapping is performed using the second spindle

- When the SPR parameter (bit 1 of parameter No.5204) is set to 0, the setting of parameter No.5214 is applied to the second spindle, as well as to the first spindle.
- When the SPR parameter (bit 1 of parameter No.5204) is set to 1, the settings of parameter No.5215 is applied to the second spindle.

5221	Number of spindle gear teeth (first-stage gear)
5222	Number of spindle gear teeth (second-stage gear)
5223	Number of spindle gear teeth (third-stage gear)
5224	Number of spindle gear teeth (fourth-stage gear)
5225	Number of second spindle gear teeth (first-stage gear)
5226	Number of second spindle gear teeth (second-stage gear)

[Data type]
[Valid data range]

Word

1 to 32767

When an arbitrary gear ratio is used in rigid tapping, each of these parameters sets the number of teeth of each spindle gear.

NOTE

- 1 These parameters are enabled when the VGR parameter (bit 1 of parameter No.5200) is set to 1.
- 2 When a position coder is attached to the spindle, set the same value for all of parameters No.5221 through No.5224.
- 3 When the DMR function of the position coder signal is used with a serial spindle, set the VGR parameter (bit 1 of parameter No.5200) to 0, and set these parameters to 0.
- 4 When rigid tapping is performed using the second spindle
 - When the SPR parameter (bit 1 of parameter No.5204) is set to 0, the settings of parameters No.5221 and No.5222 are applied to the second spindle, as well as to the first spindle.
 - When the SPR parameter (bit 1 of parameter No.5204) is set to 1, the settings of parameters No.5225 and No.5226 are applied to the second spindle.

5231	Number of position coder gear teeth (first-stage gear)
5232	Number of position coder gear teeth (second-stage gear)
5233	Number of position coder gear teeth (third-stage gear)
5234	Number of position coder gear teeth (fourth-stage gear)
5235	Number of position coder gear teeth for the second spindle (first-stage gear)
5236	Number of position coder gear teeth for the second spindle (second-stage gear)

[Data type] Word
 [Valid data range] 1 to 32767

When an arbitrary gear ratio is used in rigid tapping, each of these parameters sets the number of teeth of each position coder gear.

NOTE

- 1 These parameters are enabled when the VGR parameter (bit 1 of parameter No.5200) is set to 1. When a position coder is attached to the spindle, set the same value for all of parameters No.5231 through No.5234.
 When a spindle motor with a built-in position coder is used, a position coder with a resolution of 2048 pulses/rev may be used. In such a case, set the actual number of teeth, multiplied by 2 (for conversion to 4096 pulses/rev).
- 2 When the DMR function of the position coder signal is used with a serial spindle, set the VGR parameter (bit 1 of parameter No.5200) to 0, and set these parameters to 0.
- 3 When rigid tapping is performed using the second spindle
 - When the SPR parameter (bit 1 of parameter No.5204) is set to 0, the settings of parameters No.5231 and No.5232 are applied to the second spindle, as well as to the first spindle.
 - When the SPR parameter (bit 1 of parameter No.5204) is set to 1, the settings of parameters No.5235 and No.5236 are applied to the second spindle.

5241	Maximum spindle speed in rigid tapping (first-stage gear)
5242	Maximum spindle speed in rigid tapping (second-stage gear)
5243	Maximum spindle speed in rigid tapping (third-stage gear)
5244	Maximum spindle speed in rigid tapping (fourth-stage gear)
5245	Maximum spindle speed in rigid tapping using the second spindle (first-stage gear)
5246	Maximum spindle speed in rigid tapping using the second spindle (second-stage gear)

[Data type]
[Unit of data]
[Valid data range]

2-word
min⁻¹

The setting range is determined according to the spindle to position coder gear ratio as follows:

Spindle : Position coder	Setting range
1 : 1	0 to 7400
1 : 2	0 to 9999
1 : 4	0 to 9999
1 : 8	0 to 9999

Each of these parameters is used to set a maximum spindle speed for each gear in rigid tapping.

NOTE

- 1 For the M series, set the same value for both parameter No.5241 and parameter No.5243 for a one-stage gear system. For a two-stage gear system, set the value specified for parameter No. 5241 or 5242, whichever is greater, for parameter No. 5243. Otherwise, P/S alarm No.200 will be issued.
- 2 When rigid tapping is performed using the second spindle
 - When the SPR parameter (bit 1 of parameter No.5204) is set to 0, the settings of parameters No.5241 and No.5242 are applied to the second spindle, as well as to the first spindle.
 - When the SPR parameter (bit 1 of parameter No.5204) is set to 1, the settings of parameters No.5245 and No.5246 are applied to the second spindle.

5261	Linear acceleration/deceleration time constant for the spindle and tapping axis (first-stage gear)
5262	Linear acceleration/deceleration time constant for the spindle and tapping axis (second-stage gear)
5263	Linear acceleration/deceleration time constant for the spindle and tapping axis (third-stage gear)
5264	Linear acceleration/deceleration time constant for the spindle and tapping axis (fourth-stage gear)
5265	Linear acceleration/deceleration time constant for the second spindle and tapping axis (first-stage gear)
5266	Linear acceleration/deceleration time constant for the second spindle and tapping axis (second-stage gear)

[Data type] Word
 [Unit of data] ms
 [Valid data range] 0 to 4000

Each of these parameters is used to set a linear acceleration/deceleration time constant for the spindle of each gear and the tapping axis in rigid tapping.

Set the period required to reach each maximum spindle speed (parameters No.5241 through No.5248). The set time constant, multiplied by the ratio of a specified S value to a maximum spindle speed, is actually used as a time constant.

NOTE

When rigid tapping is performed using the second spindle

- When the SPR parameter (bit 1 of parameter No.5204) is set to 0, the settings of parameters No.5261 and No.5262 are applied to the second spindle, as well as to the first spindle.
- When the SPR parameter (bit 1 of parameter No.5204) is set to 1, the settings of parameters No.5265 and No.5266 are applied to the second spindle.

5271	Time constant for the spindle and tapping axis in extraction operation (first-stage gear)
5272	Time constant for the spindle and tapping axis in extraction operation (second-stage gear)
5273	Time constant for the spindle and tapping axis in extraction operation (third-stage gear)
5274	Time constant for the spindle and tapping axis in extraction operation (fourth-stage gear)

[Data type] Word
 [Unit of data] ms
 [Valid data range] 0 to 4000

Each of these parameters is used to set a linear acceleration/deceleration time constant for the spindle of each gear and tapping axis in extraction operation during rigid tapping.

NOTE

- 1 These parameters are enabled when the TDR parameter (bit 2 of parameter No.5201) is set to 1.
- 2 When rigid tapping is performed using the second spindle
 - When the SPR parameter (bit 1 of parameter No.5204) is set to 0, the settings of parameters No.5271 and No.5272 are applied to the second spindle, as well as to the first spindle.
 - When the SPR parameter (bit 1 of parameter No.5204) is set to 1, the settings of parameters No.5335 and No.5336 are applied to the second spindle.

5280	Position control loop gain for the spindle and tapping axis in rigid tapping (common to all gears)
5281	Position control loop gain for the spindle and tapping axis in rigid tapping (first-stage gear)
5282	Position control loop gain for the spindle and tapping axis in rigid tapping (second-stage gear)
5283	Position control loop gain for the spindle and tapping axis in rigid tapping (third-stage gear)
5284	Position control loop gain for the spindle and tapping axis in rigid tapping (fourth-stage gear)

NOTE

Once these parameters have been set, the power must be turned off then back on for the settings to become effective.

[Data type]
[Unit of data]
[Valid data range]

Word

0.01 s⁻¹

1 to 9999

Each of these parameters is used to set a position control loop gain for the spindle and tapping axis in rigid tapping. These parameters significantly affect the precision of threading. Conduct cutting tests, and make adjustments to obtain an optimum value.

When performing threading with an analog spindle, also adjust the loop gain multipliers (parameter Nos. 5291 to 5294).

NOTE

- 1 To use a varied loop gain on a gear-by-gear basis, set parameter No.5280 to 0, and set a loop gain for each gear in parameters No.5281 through No.5284. The specification of a loop gain on a gear-by-gear basis is disabled if parameter No.5280 is set to a value other than 0. In such a case, the value set in parameter No.5280 is used as a loop gain that is common to all the gears.
- 2 When rigid tapping is performed using the second spindle
 - When the SPR parameter (bit 1 of parameter No.5204) is set to 0, the setting of parameter No.5280 or the settings of parameters No.5281 and No.5282 are applied to the second spindle, as well as to the first spindle.
 - When the SPR parameter (bit 1 of parameter No.5204) is set to 1, the settings of parameters No.5341 through No.5343 are applied to the second spindle.

5291	Spindle loop gain multiplier in the rigid tapping mode (for gear 1)
5292	Spindle loop gain multiplier in the rigid tapping mode (for gear 2)
5293	Spindle loop gain multiplier in the rigid tapping mode (for gear 3)
5294	Spindle loop gain multiplier in the rigid tapping mode (for gear4)

[Data type]
[Valid data range]

Word type
0 to 32767

Set the spindle loop gain multipliers for gears 1 to 4 in the rigid tapping mode. The thread precision depends on the multipliers. Conduct cutting tests, and make fine adjustments to obtain an optimum value.

NOTE
These parameters are used for analog spindles.

$$\text{Loop gain multiplier} = 2048 \times E/L \times \alpha \times 1000$$

where;

E : Voltage in the velocity command at 1000 min⁻¹

L : Rotation angle of the spindle per one rotation of the spindle motor

α : Unit used for the detection

Examples

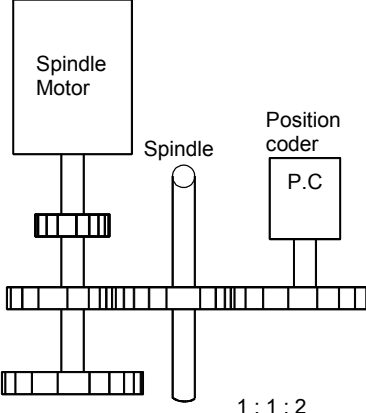

When the spindle motor, spindle, and position coder are connected as shown left, let the variables be as follows:
 E = 1.667 (V) (A motor speed of 6000 min⁻¹ corresponds to 10 V.)
 L = 360° (One rotation of the spindle corresponds to one rotation of the spindle motor.)

a = La/4096
 = 720°/4096
 = 0.17578

La = 720° (= 360° × 2. One rotation of the position coder corresponds to two rotations of the spindle.)

4096 = The number of detected pulses per rotation of the position coder

Gear ratio between the spindle and the position coder

1:1	0.08789 degrees
1:2	0.17578 degrees
1:4	0.35156 degrees
1:8	0.70313 degrees

According to above ratio the loop gain multiplier is calculated as
2048 × 1.667/360 × 0.17578 × 1000 = 1667

* When the position coder which is built in a spindle motor sends 512 pulses per rotation, the unit used for the detection, a, is La/2048.

Fig.4.23 (b) Connection among the spindle motor, spindle, and position coder

5300	Tapping axis in-position width in rigid tapping
-------------	--

5301	Spindle in-position width in rigid tapping
-------------	---

[Data type] Word
 [Unit of data] Detection unit
 [Valid data range] 0 to 32767

These parameters are used to set tapping axis and spindle in-position widths in rigid tapping.

NOTE

- 1 If an excessively large value is specified, the threading precision will deteriorate.
- 2 When rigid tapping is performed using the second spindle
 - When the SPR parameter (bit 1 of parameter No.5204) is set to 0, the settings of parameter No.5300 and No.5301 are applied to the second spindle, as well as to the first spindle.
 - When the SPR parameter (bit 1 of parameter No.5204) is set to 1, the settings of parameters No.5302 and No.5303 are applied to the second spindle.

5302	Tapping axis in-position width in rigid tapping using the second spindle
-------------	---

5303	Spindle in-position width in rigid tapping using the second spindle
-------------	--

[Data type] Word
 [Unit of data] Detection unit
 [Valid data range] 0 to 32767

These parameters are used to set spindle and tapping axis in-position widths in rigid tapping using the second spindle.

NOTE

These parameters are enabled when the SPR parameter (bit 1 of parameter No.5204) is set to 1.

5308	In-position width at point R in rigid tapping (tapping axis)
-------------	---

[Data type] Word
 [Unit of data] Detection unit
 [Valid data range] 0 to 32767

This parameter is used to set the tapping axis in-position width at point R in rigid tapping.

5310

Positional deviation limit imposed during tapping axis movement in rigid tapping

[Data type] Word
 [Unit of data] Detection unit
 [Valid data range] 1 to 32767

This parameter is used to set a positional deviation limit during tapping axis movement in rigid tapping. A value that falls outside the valid data range, described above, can be specified in parameter No.5314.

NOTE

- 1 When a high-resolution detector is used, the unit must be multiplied by 10.
- 2 When rigid tapping is performed using the second spindle
 - When the SPR parameter (bit 1 of parameter No.5204) is set to 0, the setting of parameter No.5310 (or No.5314) is applied to the second spindle, as well as to the first spindle.
 - When the SPR parameter (bit 1 of parameter No.5204) is set to 1, the setting of parameter No.5350 is applied to the second spindle, respectively.

5311

Limit value of spindle positioning deviation during movement in rigid tapping.

[Data type] Word
 [Unit of data] Detection unit
 [Valid data range] 1 to 32767

This parameter sets the limit value of a spindle positioning deviation during movement in rigid tapping.

$$\text{Limit value} = \frac{S \times 360 \times 100 \times 1.5}{60 \times G \times \alpha}$$

where

- S : Maximum spindle speed in rigid tapping
 (Setting value of parameter Nos. 5241 and greater)
 G : Loop gain of rigid tapping axis
 (Setting value of parameter Nos. 5280 and greater)
 α : Detection unit

Calculation example

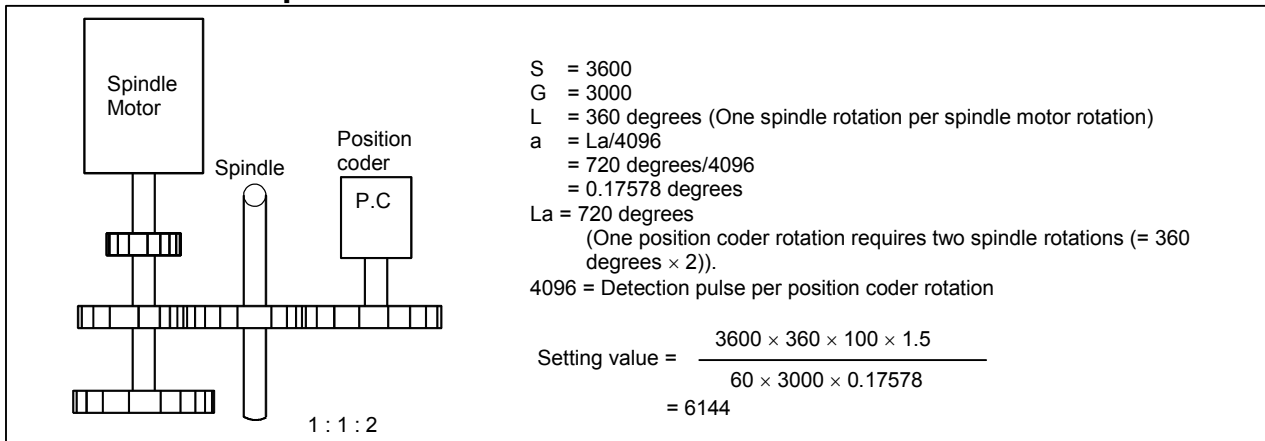

Fig.4.23 (c) Connection Among Spindle Motor, Spindle and Position Coder

NOTE

- 1 The detection unit is $a = La/2048$ when the position coder built-in spindle motor uses a position coder of 512 pulses per revolution.
- 2 When rigid tapping is performed using the second spindle
 - When the SPR parameter (bit 1 of parameter No.5204) is set to 0, the setting of parameter No.5311 is applied to the second spindle, as well as to the first spindle.
 - When the SPR parameter (bit 1 of parameter No.5204) is set to 1, the setting of parameter No.5351 is applied to the second spindle, respectively.

5312

Positional deviation limit imposed while the tapping axis is stopped in rigid tapping

[Data type] Word

[Unit of data] Detection unit

[Valid data range] 1 to 32767

This parameter is used to set a positional deviation limit imposed while the tapping axis is stopped in rigid tapping.

NOTE
 When rigid tapping is performed using the second spindle

- When the SPR parameter (bit 1 of parameter No.5204) is set to 0, the setting of parameter No.5312 is applied to the second spindle, as well as to the first spindle.
- When the SPR parameter (bit 1 of parameter No.5204) is set to 1, the setting of parameter No.5352 is applied to the second spindle, respectively.

5313

Positional deviation limit imposed while the spindle is stopped in rigid tapping

[Data type] Word
 [Unit of data] Detection unit
 [Valid data range] 1 to 32767
 This parameter is used to set a positional deviation limit imposed while the spindle is stopped in rigid tapping.

NOTE
 When rigid tapping is performed using the second spindle

- When the SPR parameter (bit 1 of parameter No.5204) is set to 0, the setting of parameter No.5313 is applied to the second spindle, as well as to the first spindle.
- When the SPR parameter (bit 1 of parameter No.5204) is set to 1, the setting of parameter No.5353 is applied to the second spindle, respectively.

5314

Positional deviation limit imposed during tapping axis movement in rigid tapping

[Data type] 2-word
 [Unit of data] Detection unit
 [Valid data range] 0 to 99999999
 Usually, parameter No.5310 is used to set a positional deviation limit imposed during tapping axis movement in rigid tapping. However, parameter No.5314 can be used to set a value greater than the valid data range of parameter No.5310 because of the resolution of the detector being used.

NOTE

- 1 When parameter No.5314 is set to 0, the setting of parameter No.5310 is used. When parameter No.5314 is set to a value other than 0, parameter No.5310 is disabled; in this case, the setting of parameter No.5314 is used.
- 2 When rigid tapping is performed using the second spindle
 - When the SPR parameter (bit 1 of parameter No.5204) is set to 0, the setting of parameter No.5314 (or No.5310) is applied to the second spindle, as well as to the first spindle.
 - When the SPR parameter (bit 1 of parameter No.5204) is set to 1, the setting of parameter No.5350 is applied to the second spindle, respectively.

5321	Spindle backlash in rigid tapping (first-stage gear)
	Spindle backlash in rigid tapping
5322	Spindle backlash in rigid tapping (second-stage gear)
5323	Spindle backlash in rigid tapping (third-stage gear)
5324	Spindle backlash in rigid tapping (fourth-stage gear)
5325	Spindle backlash in rigid tapping using the second spindle (first-stage gear)
5326	Spindle backlash in rigid tapping using the second spindle (second-stage gear)

[Data type] Byte
 [Unit of data] Detection unit
 [Valid data range] 0 to 127
 Each of these parameters is used to set a spindle backlash.

NOTE

When rigid tapping is performed using the second spindle

- When the SPR parameter (bit 1 of parameter No.5204) is set to 1, the settings of parameters No.5325 and No.5326 are applied to the second spindle.
- When the SPR parameter (bit 1 of parameter No.5204) is set to 0, the settings of parameters No.5321 and No.5322 are applied to the second spindle, as well as to the first spindle.

5335	Time constant for the spindle and tapping axis in second spindle extraction operation (first-stage gear)
5336	Time constant for the spindle and tapping axis in second spindle extraction operation (second-stage gear)

[Data type] Word
 [Unit of data] ms
 [Valid data range] 0 to 4000

Each of these parameters is used to set a linear acceleration/deceleration time constant for the spindle and tapping axis in extraction operation during rigid tapping on a gear-by-gear basis.

NOTE

This parameter is enabled when both the TDR parameter (bit 2 of parameter No.5201) and the SPR parameter (bit 1 of parameter No.5204) are set to 1.

5341	Position control loop gain for the spindle and tapping axis in rigid tapping using the second spindle (common to all the gears)
5342	Position control loop gain for the spindle and tapping axis in rigid tapping using the second spindle (first-stage gear)
5343	Position control loop gain for the spindle and tapping axis in rigid tapping using the second spindle (second-stage gear)

NOTE

After these parameters have been set, the power must be turned off then back on for the settings to become effective.

[Data type] Word
 [Unit of data] 0.01 s^{-1}
 [Valid data range] 1 to 9999

Each of these parameters is used to set a position control loop gain for the spindle and tapping axis in rigid tapping using the second spindle.

NOTE

- 1 To use a varied loop gain on a gear-by-gear basis, set parameter No.5341 to 0, and set a loop gain for each gear in parameters No.5342 and No.5343.
- 2 This parameter is enabled when the SPR parameter (bit 1 of parameter No.5204) is set to 1.

5350	Positional deviation limit imposed during tapping axis movement in rigid tapping using the second spindle
------	---

[Data type] 2-word
 [Unit of data] Detection unit
 [Valid data range] 1 to 99999999

This parameter sets a positional deviation limit imposed during tapping axis movement in rigid tapping using the second spindle.

NOTE

This parameter is enabled when the SPR parameter (bit 1 of parameter No.5204) is set to 1.

5351	Positional deviation limit imposed during spindle movement in rigid tapping using the second spindle

[Data type] Word
 [Unit of data] Detection unit
 [Valid data range] 1 to 32767
 This parameter is used to set a positional deviation limit imposed during spindle movement in rigid tapping using the second spindle.

NOTE
 This parameter is enabled when the SPR parameter (bit 1 of parameter No.5204) is set to 1.

5352	Positional deviation limit imposed while the tapping axis is stopped in rigid tapping using the second spindle

[Data type] Word
 [Unit of data] Detection unit
 [Valid data range] 1 to 32767
 This parameter is used to set a positional deviation limit imposed while the tapping axis is stopped in rigid tapping using the second spindle.

NOTE
 This parameter is enabled when the SPR parameter (bit 1 of parameter No.5204) is set to 1.

5353	Positional deviation limit imposed while the spindle is stopped in rigid tapping using the second spindle

[Data type] Word
 [Unit of data] Detection unit
 [Valid data range] 1 to 32767
 This parameter is used to set a positional deviation limit imposed while the spindle is stopped in rigid tapping using the second spindle.

NOTE
 This parameter is enabled when the SPR parameter (bit 1 of parameter No.5204) is set to 1.

5365	Bell-shaped acceleration/deceleration time constant for the first spindle in rigid tapping (first-stage gear)
5366	Bell-shaped acceleration/deceleration time constant for the first spindle in rigid tapping (second-stage gear)
5367	Bell-shaped acceleration/deceleration time constant for the first spindle in rigid tapping (third-stage gear)

[Data type] Word
 [Unit of data] msec
 [Valid data range] 0 to 512
 These parameters are used to set bell-shaped acceleration/deceleration time constants for the first spindle in rigid tapping.

5369	Bell-shaped acceleration/deceleration time constant for the second spindle in rigid tapping (first-stage gear)
5370	Bell-shaped acceleration/deceleration time constant for the second spindle in rigid tapping (second-stage gear)

[Data type] Word
 [Unit of data] msec
 [Valid data range] 0 to 512
 These parameters are used to set bell-shaped acceleration/deceleration time constants for the second spindle in rigid tapping.

5381	Override value during rigid tapping return
-------------	---

[Data type] Byte
 [Unit of data] 1% or 10%
 [Valid data range] 0 to 200
 This parameter is used to set the override value during rigid tapping return.
 If the setting is 0, no override is applied.

NOTE
 This parameter is valid when bit 4 (DOV) of parameter No. 5200 is set to 1.
 If bit 3 (OVU) of parameter No.5201 is set to 1, 10% is set as the units of data. Thus, an override of up to 2000% can be applied during extraction.

5382	
	Amount of return for rigid tapping return

[Data type] 2-word
 [Unit of data] Input increments
 [Valid data range] 0 to 99999999

During rigid tapping return, the tool can be pulled out, along the tapping axis, going beyond the stored rigid tapping start position by the amount specified with this parameter.

If the tool has already been retracted from rigid tapping, it will be retracted further only by the distance specified in this parameter.

4.24 PARAMETERS OF SCALING/COORDINATE ROTATION

	#7	#6	#5	#4	#3	#2	#1	#0
5400								
	SCR	XSC		RCW				RIN

[Data type] Bit
 RIN Coordinate rotation angle command (R)
 0 : Specified by an absolute method
 1 : Specified by G90 or G91

NOTE

For the G code system A (T series), this parameter is invalid.

RCW When a workpiece or local coordinate system command is issued in coordinate system rotation mode:
 0 : No alarm is issued.
 1 : An alarm (P/S alarm No. 5302) is issued.

XSC Scaling mirror image for each axis in scaling is:
 0 : Disabled. (The scaling magnification common to all axes is specified with P.)
 1 : Enabled. (The scaling magnification for each axis is specified with I, J, and K.)

SCR Scaling magnification unit
 0 : 0.00001 times (1/100,000)
 1 : 0.001 times

	#7	#6	#5	#4	#3	#2	#1	#0
5401								
								SCLx

[Data type] Bit axis
 SCLx Scaling
 0 : Invalidated
 1 : Validated

	#7	#6	#5	#4	#3	#2	#1	#0
5402								
								S8D

[Data type] Bit axis
 S8D The unit of scaling magnification is:
 0 : Dependent on the setting of bit 7 (SCR) of parameter No. 5400.
 1 : 0.0000001 (1/10,000,000).

5410	
	Angular displacement used when no angular displacement is specified for coordinate system rotation

The following parameter can be set at "Setting screen".

[Data type] 2-word
 [Unit of data] 0.001 degrees
 [Valid data range] -360000 to 360000

This parameter sets the angular displacement for coordinate system rotation. When the angular displacement for coordinate system rotation is not specified with address R in the block where G68 is specified, the setting of this parameter is used as the angular displacement for coordinate system rotation.

5411	
	Magnification used when scaling magnification is not specified

The following parameter can be set at "Setting screen".

[Data type] 2-word
 [Unit of data] 0.001, 0.00001, or 0.0000001 times (selected by bit 7 (SCR) of parameter No. 5400) or bit 0 (S8D) of parameter No. 5402 (M series))
 [Valid data range] 1 to 999999 (when 0.001 or 0.00001 times is selected)
 1 to 99999999 (when 0.0000001 times is selected) (M series)

This parameter sets the scaling magnification. This setting value is used when a scaling magnification (P) is not specified in the program.

NOTE

Parameter No.5421 becomes valid when scaling for every axis is valid. (XSC, #6 of parameter No.5400 is "1".)

5421	
	Scaling magnification for every axis

The following parameter can be set at "Setting screen".

[Data type] 2-word axis
 [Unit of data] 0.001, 0.00001, or 0.0000001 times (selected by bit 7 (SCR) of parameter No. 5400) or bit 0 (S8D) of parameter No. 5402 (M series))
 [Valid data range] -999999 to -1, 1 to 999999 (when 0.001 or 0.00001 times is selected)
 -99999999 to -1, 1 to 99999999 (when 0.0000001 times is selected) (M series)

This parameter sets the scaling magnification for every axis.

4.25 PARAMETERS OF UNI-DIRECTIONAL POSITIONING

	#7	#6	#5	#4	#3	#2	#1	#0
5431								
							PDI	MDL

[Data type] Bit

MDL Specifies whether the G code for single direction positioning (G60) is included in one-shot G codes (00 group) or modal G codes (01 group)
 0: One-shot G codes (00 group)
 1: Modal G codes (01 group)

PDI When the tool is stopped before or after a specified end point with the unidirectional positioning function:
 0: No in-position check is performed.
 1: An in-position check is performed.

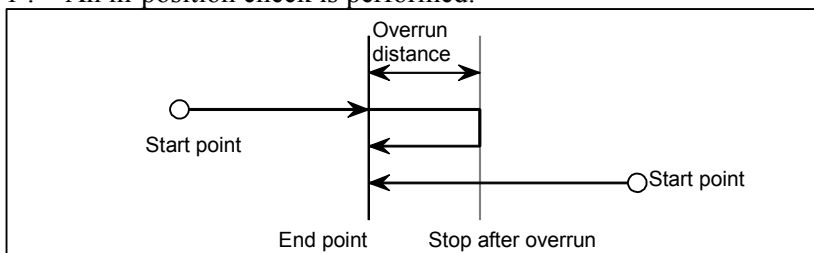

5440	
	Positioning direction and overrun distance in uni-directional positioning for each axis

[Data type] Word axis
 [Unit of data]

Input increment	IS-A	IS-B	IS-C	Unit
Millimeter machine	0.01	0.001	0.0001	mm
Inch machine	0.001	0.0001	0.00001	inch
Rotation axis	0.01	0.001	0.0001	deg

[Valid data range] -16383 to +16383

This parameter sets the positioning direction and overrun distance in uni-directional positioning (G60) for each axis. The positioning direction is specified using a setting data sign, and the overrun distance using a value set here.

Overrun distance > 0: The positioning direction is positive (+).
 Overrun distance < 0: The positioning direction is negative (-).
 Overrun distance = 0: Uni-directional positioning is not performed.

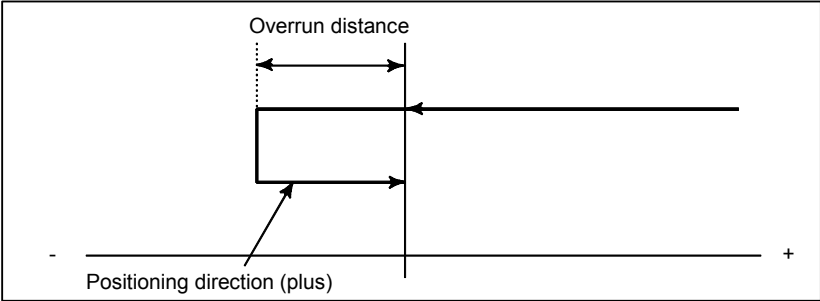

Fig.4.25 Positioning Direction and Overrun distance

4.26 PARAMETERS OF POLAR COORDINATE INTERPOLATION

	#7	#6	#5	#4	#3	#2	#1	#0
5450							AFC	

[Data type] Bit

AFC In polar coordinate interpolation mode, automatic override operation and automatic feedrate clamp operation are:

0 : Not performed.

1 : Performed.

NOTE

In polar coordinate interpolation mode, the feedrate component for a rotational axis increases as the tool moves closer to the center of a workpiece. Near the center of a workpiece, the maximum cutting feedrate (parameter No.5462) may be exceeded, causing servo alarm No.411 to be issued. The automatic feedrate override function and automatic feedrate clamp function automatically control the feedrate to prevent the feedrate component on a rotation axis from exceeding a specified maximum cutting feedrate.

5460	Axis (linear axis) specification for polar coordinate interpolation
5461	Axis (rotary axis) specification for polar coordinate interpolation

[Data type] Byte

[Valid data range] 1, 2, 3, ... control axes count

These parameters set control axis numbers of linear and rotary axes to execute polar interpolation.

5462	Maximum cutting feedrate during polar coordinate interpolation

[Data type] 2-word

[Unit of data, valid data range]

Increment system	Units of data	Valid data range	
		IS-A, IS-B	IS-C
Millimeter machine	1 mm/min	0, 6 to 240000	0, 6 to 100000
Inch machine	0.1 inch/min	0, 6 to 96000	0, 6 to 48000
Rotation axis	1 deg/min	0, 6 to 240000	0, 6 to 100000

This parameter sets the upper limit of the cutting feedrate that is effective during polar coordinate interpolation. If a feedrate greater than the maximum feedrate is specified during polar coordinate interpolation, it is clamped to the feedrate specified by the parameter. When the setting is 0, the feedrate during polar coordinate interpolation is clamped to the maximum cutting feedrate usually specified with parameter 1422.

5463	Allowable automatic override percentage in polar coordinate interpolation
------	--

[Data type] Byte
 [Unit of data] %
 [Valid data range] 0 to 100

This parameter sets an allowable percentage to find an allowable feedrate on a rotation axis in polar coordinate interpolation mode. A maximum cutting feedrate (parameter No.5462), multiplied by the allowable percentage set with this parameter represents an allowable feedrate.

$$\text{Allowable feedrate on rotation axis} = \frac{\text{maximum cutting feedrate}}{\text{feedrate}} \times \text{allowable percentage}$$

In polar coordinate interpolation mode, the feedrate component on a rotation axis increases as the tool moves closer to the center of a workpiece. Near the center of a workpiece, the maximum allowable feedrate (parameter No.5462) may be exceeded. To prevent the feedrate component on a rotation axis from exceeding the maximum allowable feedrate in polar coordinate interpolation mode, the following override is automatically applied to the feedrate (automatic override):

$$\text{Override} = \frac{\text{Allowable feedrate on rotation axis}}{\text{Feedrate component on rotation axis}} \times 100 (\%)$$

If the overridden feedrate component for a rotation axis still exceeds the allowable feedrate, the feedrate is clamped to prevent the feedrate component on a rotation axis from exceeding a maximum cutting feedrate (automatic feedrate clamp).

NOTE
 When 0 is set in this parameter, a specification of 90% is assumed. When a value of 100 or greater is set with this parameter, a specification of 100% is assumed. Before the automatic override function and automatic feedrate clamp function can be used, bit 1 (AFC) of parameter No.5450 must be set to

4.27 PARAMETERS OF NORMAL DIRECTION CONTROL

5480	
	Number of the axis for controlling the normal direction

[Data type] Byte
 [Valid data range] 1 to the maximum control axis number
 This parameter sets the control axis number of the axis for controlling the normal direction.

5481	
	Rotation feedrate of normal direction control axis

[Data type] Word
 [Unit of data] deg/min
 [Valid data range] 1 to 15000
 This parameter sets the feedrate of a normal direction control axis that is inserted at the start point of a block during normal direction control.

5482	
	Limit value that ignores the rotation insertion of normal direction control axis

[Data type] 2-word
 [Unit of data]

Input increment	IS-A	IS-B	IS-C	Unit
Rotation axis	0.01	0.001	0.0001	deg

[Valid data range] 1 to 99999999
 The rotation block of a normal direction control axis is not inserted when the rotation insertion angle calculated during normal direction control does not exceed this setting value. The ignored rotation angle is added to the next rotation insertion angle. The block insertion is then judged.

NOTE

- 1 No rotation block is inserted when 360 or more degrees are set.
- 2 If 180 or more degrees are set, a rotation block is inserted only when the circular interpolation is 180 or more degrees.

5483	Limit value of movement that is executed at the normal direction angle of a preceding block
	preceding block

[Data type] 2-word
 [Unit of data]

Input increment	IS-A	IS-B	IS-C	Unit
Millimeter input	0.01	0.001	0.0001	mm
Inch input	0.001	0.0001	0.00001	inch

[Valid data range] 1 to 99999999
 This parameter sets the limit value of movement at the normal direction angle of a preceding block.

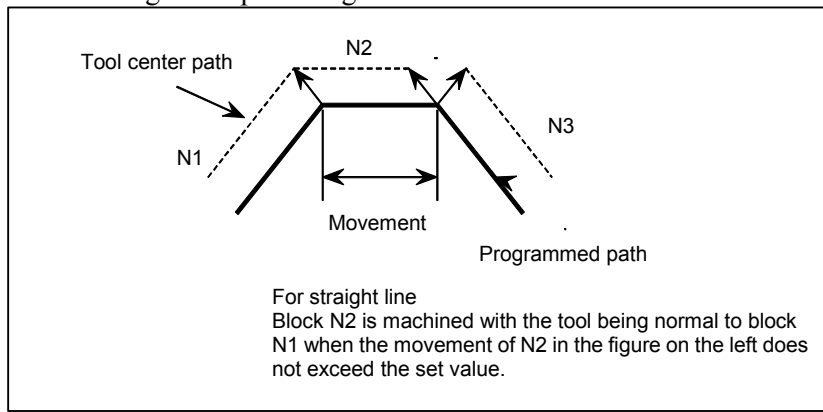

Fig.4.27 (a) When the Block Moves Along a Straight Line

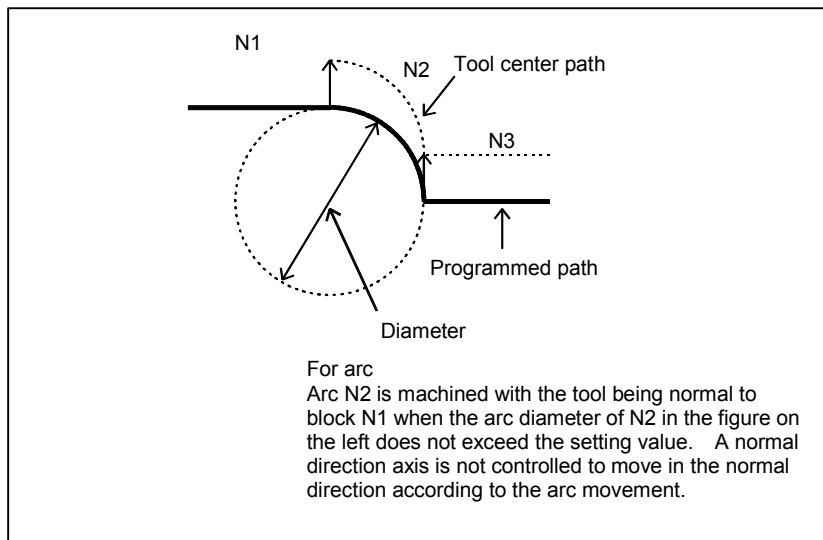

Fig.4.27 (b) When the Block Moves Along on Arc

	#7	#6	#5	#4	#3	#2	#1	#0
5484								
						ANM	CTI	SDC

[Data type] Bit

SDC In normal direction control:

0 : A C-axis movement is automatically inserted between blocks so that the C-axis is directed at right angles to the direction of motion at the start point of each block. (After movement on the C-axis, movement (along the X-axis and Y-axis) specified by the block is performed.)

1 : If the amount of C-axis movement is smaller than the value set in parameter

No.5485, a C-axis movement is not inserted before a block. Instead, it is performed together with movement along the X-axis and Y-axis.

CTI If such an arc that the vector from the center of the arc to a start point rotates in the reverse direction after cutter compensation is specified during normal direction control in the cutter compensation C mode:

0 : P/S 041 alarm is issued.

1 : The command is executed.

If this parameter is set to 1, and such an arc that the vector from the center of the arc to a start point rotates in the reverse direction after cutter compensation is specified during normal direction control in the cutter compensation C mode (see the tool path from (4) to (5) in the figure below), the tool is controlled so that the tool faces in the direction at right angles to the move direction (programmed path) before cutter compensation (see the tool path from (2) to (3) in the figure below).

Thus, as shown by the programmed path from (4) to (5) in the figure below, the inside of an arc where the radius of the workpiece is smaller than the compensation value of the tool can be cut.

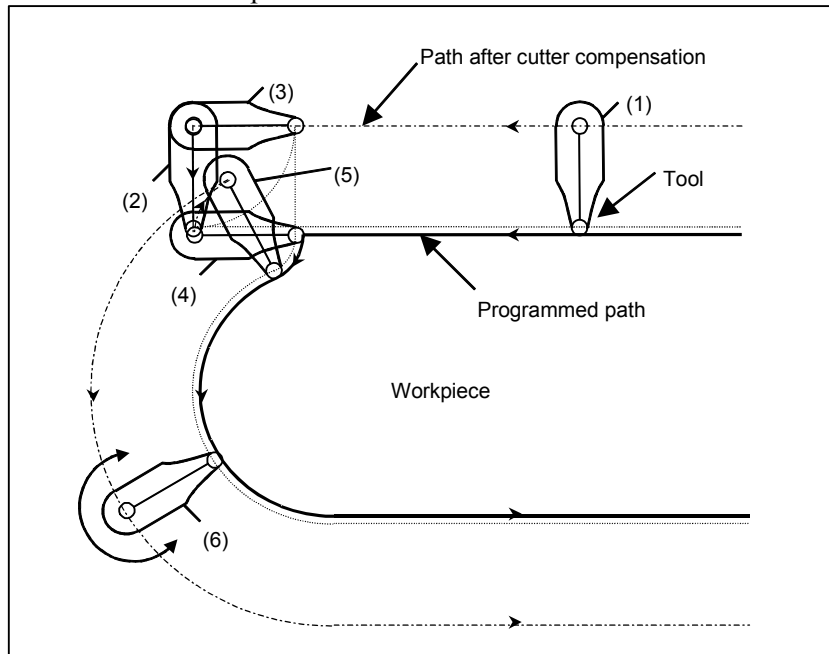

NOTE
 When this parameter is set to 1, no interference check is made in cutter compensation C.

ANM In AI contour control mode, the normal direction control function is:
 0 : Disabled.
 1 : Enabled.

5485	Limit imposed on the insertion of a single block for rotation about the normal direction control axis
-------------	--

[Data type] 2-word
 [Unit of data]

Input increment	IS-A	IS-B	IS-C	Unit
Rotation axis	0.01	0.001	0.0001	deg

[Valid data range] 1 to 99999999
 When normal direction control is applied, the amount of movement (rotation angle) on the normal direction control axis (C-axis), calculated so that the C-axis is directed at right angles to the direction of motion at the start point of a block, may be smaller than the value specified in this parameter. In such a case, the C-axis movement is not inserted before the movement (along the X-axis and Y-axis) specified by the block. Instead, the C-axis movement is performed together with the movement specified by the block. If the amount of movement (rotation angle) on the C-axis is greater than or equal to the value specified with this parameter, the C-axis movement is inserted, and the movement specified by the block is made after the completion of the C-axis movement.

NOTE
 This parameter is enabled when the SDC parameter (bit 0 of parameter No.5484) is set to 1. If a value equal to or greater than 180 degrees is specified, a C-axis movement is inserted only when circular interpolation involving a C-axis rotation of 180 degrees or more is performed.

4.28 PARAMETERS OF INDEXING INDEX TABLE

	#7	#6	#5	#4	#3	#2	#1	#0
5500								
	IDX	SIM		G90	INC	ABS	REL	DDP

- [Data type] Bit
- DDP Selection of decimal-point input method of index table indexing axis
 0 : Conventional method (Example IS-B: B1; = 0.001 deg)
 1 : Pocket calculator method (Example IS-B: B1; = 1.000 deg)
- REL Relative position display of index table indexing axis
 0 : Not rounded by 360 degrees
 1 : Rounded by 360 degrees
- ABS Displaying absolute coordinate value of index table indexing axis
 0 : Not rounded by 360 degrees
 The index table indexing axis rotates 720 degrees (two rotations) when G90 B720.0; is specified from the 0-degree position. It rotates in reverse direction 720 degrees (two rotations) when G90 B0.; is specified. The absolute coordinate value then becomes 0 degree.
 1 : Rounded by 360 degrees
 The index table indexing axis is positioned in 40 degrees when G90 B400.0; is specified from the 0-degree position. The index table indexing axis does not rotate by two or more turns when this parameter is set to 1. It also does not move when G90 B720.0; is specified from the 0-degree position.
- INC Rotation in the G90 mode when negative-direction rotation command M code (parameter No.5511) is not set
 0 : Not set to the shorter way around the circumference
 1 : Set to the shorter way around the circumference (Set ABS, #2 of parameter No.5500, to 1.)
- G90 Index table indexing command
 0 : Judged to be an absolute/increment command according to the G90/G91 mode
 1 : Judged to be an absolute command
- SIM When the same block includes a command for an index table indexing axis and a command for another controlled axis:
 0 : A P/S alarm (No.136) is issued.
 1 : The commands are executed. (In a block other than G00, G28, and G30, however, a P/S alarm (No.136) is issued.)
- IDX Index table indexing sequence
 0 : Type A
 1 : Type B

	#7	#6	#5	#4	#3	#2	#1	#0
5501								
							ISP	ITI

[Data type] Bit

ITI The index table index function is:
 0 : Enabled.
 1 : Disabled.

ISP For the index table axis, an automatic servo-off operation when clamping is completed and an automatic servo-on operation when unclamping is completed are:
 0 : Performed.
 1 : Not performed.

5511	
	Negative-direction rotation command M code

[Data type] 2-word

[Valid data range] 0 to 255

0 : Not use an M code that sets the index table rotation to the negative direction. The rotation direction is specified using a command and parameter (INC, #3 of parameter No.5500).

1 to 255:
 Sets an M code that sets the index table rotation to the negative direction. The rotation is set to the negative direction only when an M code set here is specified in the same block as an index table indexing command. If the M code is not specified in the same block, the rotation is always set to the positive direction.

NOTE
 Set ABS, #2 of parameter No.5500, to 1.

5512	
	Unit of index table indexing angle

[Data type] 2-word

[Unit of data]

Input increment	IS-A	IS-B	IS-C	Unit
Rotation axis	0.01	0.001	0.0001	deg

[Valid data range] 0 to 360000

This parameter sets the unit of index table indexing angle. A P/S alarm (No.135) generated when movement other than integer multiple of the setting value is specified.

NOTE
 If zero is specified as the setting value, any command can be specified irrespective of the unit of angle.

4.29 PARAMETERS OF CUSTOM MACROS

	#7	#6	#5	#4	#3	#2	#1	#0
6000	SBV		SBM	HGO		HMC		G67
	SBV		SBM	HGO	V15	HMC		G67

- [Data type] Bit
- G67 If the macro continuous-state call cancel command (G67) is specified when the macro continuous-state call mode (G66) is not set:
 0 : P/S alarm No.122 is issued.
 1 : The specification of G67 is ignored.
- HMC A custom macro is executed:
 0 : At a normal speed.
 1 : At a high speed.

NOTE

When this parameter is set, the CNC executes a custom macro first. For this reason, when this parameter is set, performance of the following functions may be degraded:

- Screen display of CNC
- Macro executor (excluding execution macros)
- Embedded Ethernet

- V15 As system variable numbers for tool offset:
 0 : The standard system variable numbers for the Series 16 are used.
 1 : The same system variable numbers as those used for the Series 15 are used.

The tables below indicate the system variables for tool offset numbers 1 to 999. The values for tool offset numbers 1 to 200 can be read from or assigned to the system variables in parentheses.

		System parameter number	
		V15 = 0	V15 = 1
H-Code	Geometry offset value	#11001 to #11999 (#2201 to #2400)	#10001 to #10999 (#2001 to #2200)
	Wear offset value	#10001 to #10999 (#2001 to #2200)	#11001 to #11999 (#2201 to #2400)
D-Code	Geometry offset value	#13001 to #13999	#12001 to #12999
	Wear offset value	#12001 to #12999	#13001 to #13999

- HGO When a GOTO statement for specifying custom macro control is executed:
 0 : A high-speed branch is not caused to 30 sequence numbers, immediately following the point of execution.
 1 : A high-speed branch is caused to 30 sequence numbers, immediately before the point of execution.

SBM Custom macro statement
 0: Not stop the single block
 1: Stops the single block
 If you want to disable the single blocks in custom macro statements using system variable #3003, set this parameter to 0. If this parameter is set to 1, the single blocks in custom macro statements cannot be disabled using system variable #3003. To control single blocks in custom macro statements using system variable #3003, use bit 7 (SBV) of parameter No. 6000.

NOTE

- 1 This bit is invalid when bit 0 (NOP) of parameter No. 3404 is set to 1. (M series)
- 2 When the block look-ahead operation is enabled, a block look-ahead operation is performed also in single block operation, so macro statements are executed when they are read by the look-ahead operation.
- 3 In cutter offset C mode, an intersection on the path resulting from offsetting is calculated. So, a block look-ahead operation is performed also in single block operation. To stop a macro statement in single block mode, cancel cutter offset C mode in advance.

SBV Custom macro statement
 0 : Not stop the single block
 1 : Stops the single block
 To control single blocks in custom macro statements using system variable #3003, use this parameter to enable or disable single blocks in custom macro statements.
 This bit is valid when bit 5 (SBM) of parameter No. 6000 is set to 0.

	#7	#6	#5	#4	#3	#2	#1	#0
6001	CLV	CCV	TCS	CRO	PV5		PRT	MIF

[Data type] Bit

MIF The system variable numbers of custom macro interface signals are:
 0 : Not expanded.
 1 : Expanded.

PRT Reading zero when data is output using a DPRINT command
 0 : Outputs a space
 1 : Outputs no data

PV5 Custom macro common variables:
 0 : Nos. 500 to 599 are output.
 1 : Nos. 100 to 199 and Nos. 500 to 599 are output.

CRO ISO code in BPRWT or DPRNT command
 0 : Outputs only LF after data is output
 1 : Outputs LF and CR after data is output

TCS Subprogram
 0 : Not called using a T code

- 1 : Called using a T code
- CCV Custom macro's common variables Nos. 100 to 199
 - 0: Cleared to "vacant" by reset
 - 1: Not cleared by reset
- CLV Custom macro's local variables Nos. 1 to 33
 - 0: Cleared to "vacant" by reset
 - 1: Not cleared by reset

	#7	#6	#5	#4	#3	#2	#1	#0
6003	MUS	MCY	MSB	MPR	TSE	MIN	MSK	

NOTE
 When this parameter is set, the power must be turned off before operation is continued.

- [Data type] Bit
- MSK Absolute coordinates at that time during custom macro interrupt
 - 0 : Not set to the skip coordinates (system variables #5061 and later)
 - 1 : Set to the skip coordinates (system variables #5061 and later)
 - MIN Custom macro interrupt
 - 0 : Performed by interrupting an in-execution block (Custom macro interrupt type I)
 - 1 : Performed after an in-execution block is completed (Custom macro interrupt type II)
 - TSE Custom macro interrupt signal UINT <G053#3>
 - 0 : Edge trigger method (Rising edge)
 - 1 : Status trigger method
 - MPR Custom macro interrupt valid/invalid M code
 - 0 : M96/M97
 - 1 : M code set using parameters (Nos. 6033 and 6034)
 - MSB Interrupt program
 - 0 : Uses a dedicated local variable (Macro-type interrupt)
 - 1 : Uses the same local variable as in the main program (Subprogram- type interrupt)
 - MCY Custom macro interrupt
 - 0 : Not performed during cycle operation
 - 1 : Performed during cycle operation
 - MUS Interrupt-type custom macro
 - 0 : Not used
 - 1 : Used

	#7	#6	#5	#4	#3	#2	#1	#0
6004						VHD	MFZ	NAT
			D15				MFZ	NAT

- [Data type] Bit
- NAT Specification of the results of custom macro functions ATAN
 0 : The result of ATAN is 0 to 360.0.
 1 : The result of ATAN is -180 to 0 to 180.0.
 - MFZ If the angle of a custom macro operation command SIN, COS, or TAN is 1.0×10^{-8} or below or if the result of operation is not accurately 0, the operation result is:
 0: Handled as underflow.
 1: Normalized to 0.
 - VHD With system variables #5121 through #5128
 0 : Tool position offset values (geometry offset values) are read.
 1 : The amount of interrupt shift caused by a manual handle interrupt is read.
 - D15 When tool compensation memory C is used, for reading or writing tool offset values (for up to offset number 200) for D code (tool radius), the same system variables, #2401 through #2800, as Series 15 are:
 0 : Not used.
 1 : Used.

D code		
Offset number	Geometry offset value	Tool wear compensation value
1	#2401	#2601
2	#2402	#2602
:	:	:
200	#2600	#2800

NOTE
 When the D15 parameter is set to 1, system variables #2500 through #2806, for workpiece reference point offset values, cannot be used. Instead, use system variables #5201 through #5324.

	#7	#6	#5	#4	#3	#2	#1	#0
6005								SQC
							ADR	SQC

NOTE
 When this parameter has been set, the power must be turned off before operation is continued.

- [Data type] Bit
- SQC Calling a subprogram with its sequence number by the subprogram call function is:
 0 : Disabled.
 1 : Enabled.
- ADR Calling a subprogram with address E by the subprogram call function using a custom macro and macro executor special code is:
 0 : Disabled.
 1 : Enabled.
 Address E can be set for parameters Nos. 6090 and 6091.

	#7	#6	#5	#4	#3	#2	#1	#0
6006								MLG
							MMG	MLG

- [Data type] Bit
- MLG In conditional decision statements in custom macros, logical operations:
 0 : Cannot be used.
 1 : Can be used.
- MMG With system variables (#4001 to #4022) for reading modal information:
 0 : Modal information specified in the previous blocks up to the immediately preceding one can be read.
 1 : Modal information of the currently executed block can be read.

6010	#7	#6	#5	#4	#3	#2	#1	#0
	*7	*6	*5	*4	*3	*2	*1	*0
6011	#7	#6	#5	#4	#3	#2	#1	#0
	=7	=6	=5	=4	=3	=2	=1	=0
6012	#7	#6	#5	#4	#3	#2	#1	#0
	#7	#6	#5	#4	#3	#2	#1	#0
6013	#7	#6	#5	#4	#3	#2	#1	#0
	[7	[6	[5	[4	[3	[2	[1	[0
6014	#7	#6	#5	#4	#3	#2	#1	#0
]7]6]5]4]3]2]1]0

[Data type] Bit
 These parameters are used for input/output with EIA codes.
 The numeral of a suffix indicates the bit position in a code.
 *0 to *7 : Set the hole pattern of an EIA code indicating *.
 =0 to =7 : Set the hole pattern of an EIA code indicating =.
 #0 to #7 : Set the hole pattern of an EIA code indicating #.
 [0 to [7 : Set the hole pattern of an EIA code indicating [.
] 0 to] 7 : Set the hole pattern of an EIA code indicating].
 0 : Corresponding bit is 0
 1 : Corresponding bit is 1.

6030	M code that calls the program entered in file
------	---

[Data type] 2-word
 [Valid data range] 0, and 1 to 255
 This parameter sets an M code that calls the program entered in a file.

NOTE
 The M code is judged to be M198 when zero is specified as the setting value.

6033	M code that validates a custom macro interrupt
------	--

6034	M code that invalidates a custom macro interrupt
------	--

[Data type] 2-word
 [Valid data range] 0 to 255

These parameters set the custom macro interrupt valid/invalid M codes.

NOTE

These parameters can be used when MPR, #4 of parameter No.6003, is 1. M96 is used as a valid M code and M97 is used as an invalid M code when MPR is 0, irrespective of the state of this parameter.

6050	G code that calls the custom macro of program number 9010
------	---

6051	G code that calls the custom macro of program number 9011
------	---

6052	G code that calls the custom macro of program number 9012
------	---

6053	G code that calls the custom macro of program number 9013
------	---

6054	G code that calls the custom macro of program number 9014
------	---

6055	G code that calls the custom macro of program number 9015
------	---

6056	G code that calls the custom macro of program number 9016
------	---

6057	G code that calls the custom macro of program number 9017
------	---

6058	G code that calls the custom macro of program number 9018
------	---

6059	G code that calls the custom macro of program number 9019
------	---

[Data type] Word
 [Valid data range] 1 to 9999

These parameters set the G codes that call the custom macros of program numbers 9010 through 9019.

NOTE

Setting value 0 is invalid. No custom macro can be called by G00.

6071	M code that calls the subprogram of program number 9001
6072	M code that calls the subprogram of program number 9002
6073	M code that calls the subprogram of program number 9003
6074	M code that calls the subprogram of program number 9004
6075	M code that calls the subprogram of program number 9005
6076	M code that calls the subprogram of program number 9006
6077	M code that calls the subprogram of program number 9007
6078	M code that calls the subprogram of program number 9008
6079	M code that calls the subprogram of program number 9009

[Data type] 2-word

[Valid data range] 1 to 99999999

These parameters set the M codes that call the subprograms of program numbers 9001 through 9009.

NOTE

Setting value 0 is invalid. No subprogram can be called by M00.

6080	M code that calls the custom macro of program number 9020
6081	M code that calls the custom macro of program number 9021
6082	M code that calls the custom macro of program number 9022
6083	M code that calls the custom macro of program number 9023
6084	M code that calls the custom macro of program number 9024
6085	M code that calls the custom macro of program number 9025
6086	M code that calls the custom macro of program number 9026
6087	M code that calls the custom macro of program number 9027
6088	M code that calls the custom macro of program number 9028
6089	M code that calls the custom macro of program number 9029

[Data type]
[Valid data range]

2-word
1 to 99999999

These parameters set the M codes that call the custom macros of program numbers 9020 through 9029.

NOTE

Setting value 0 is invalid. No custom macro can be called by M00.

6090	ASCII code that calls the subprogram of program number 9004
6091	ASCII code that calls the subprogram of program number 9005

NOTE

When this parameter is set, the power must be turned off before operation is continued.

[Data type]
[Valid data range]

Byte
65 (A:41H) to 90 (Z:5AH)

These parameters set the ASCII codes that call subprograms in decimal.

Addresses that can be used are as follows:

T series : A, B, F, H, I, K, M, P, Q, R, S, T

M series: A, B, D, F, H, I, J, K, L, M, P, Q, R, S, T, X, Y, Z

NOTE

Set 0 when no subprogram is called

4.30 PARAMETERS OF PATTERN DATA INPUT

6101	First variable number displayed on pattern data screen 1
6102	First variable number displayed on pattern data screen 2
6103	First variable number displayed on pattern data screen 3
6104	First variable number displayed on pattern data screen 4
6105	First variable number displayed on pattern data screen 5
6106	First variable number displayed on pattern data screen 6
6107	First variable number displayed on pattern data screen 7
6108	First variable number displayed on pattern data screen 8
6109	First variable number displayed on pattern data screen 9
6110	First variable number displayed on pattern data screen 10

[Data type] Word
 [Valid data range] 0, 100 to 199, 500 to 999
 These parameters specify the first variable number displayed on the pattern data screen selected from the pattern menu screen. When 0 is set, 500 is assumed.

4.31 PARAMETERS OF SKIP FUNCTION

	#7	#6	#5	#4	#3	#2	#1	#0
6200	SKF	SRE	SLS	HSS	MIT		SK0	GSK
	SKF	SRE	SLS	HSS			SK0	

- [Data type] Bit
- GSK In skip cutting (G31), the skip signal SKIPP <G006#6> is:
 0 : Not used as a skip signal.
 1 : Used as a skip signal.
 - SK0 This parameter specifies whether the skip signal is made valid under the state of the skip signal SKIP <X004#7> and the multistage skip signals <X004#0-7> (for the T series only).
 0 : Skip signal is valid when these signals are 1.
 1 : Skip signal is valid when these signals are 0.
 - MIT In skip cutting (G31), the tool compensation measurement value direct input B signals +MIT1, -MIT1, +MIT2, and -MIT2 <X004#2-5> are :
 0 : Not used as skip signals.
 1 : Used as skip signals.
 - HSS 0 : The skip function does not use high-speed skip signals.
 1 : The skip function uses high-speed skip signals.
 - SLS 0 The multi-step skip function does not use high-speed skip signals while skip signals are input.
 1 : The multi-step skip function uses high-speed skip signals while skip signals are input.
 - SRE When a high-speed skip signal is used:
 0 : The signal is considered to be input at the rising edge (0#1).
 1 : The signal is considered to be input at the falling edge (1#0).
 - SKF Dry run, override, and automatic acceleration/deceleration for G31 skip command
 0 : Disabled
 1 : Enabled

	#7	#6	#5	#4	#3	#2	#1	#0
6201	SPE			IGX	TSA	TSE	SEB	SEA

- [Data type] Bit
- SEA When a high speed skip signal goes on while the skip function is used, acceleration/deceleration and servo delay are:
 0 : Ignored.
 1 : Considered and compensated (type A).
 - SEB When a high speed skip signal goes on while the skip function is used, acceleration/deceleration and servo delay are:
 0 : Ignored.
 1 : Considered and compensated (type B).

NOTE

There are two types of compensation: Types A and B. With the skip function, the current position is stored in the CNC according to the skip signal. However, the current position stored in the CNC contains servo delay. The machine position is therefore deviated by the servo delay. The deviation can be obtained from the position deviation of the servo and the error generated due to feedrate acceleration/deceleration performed by the CNC. If the deviation can be compensated, it is not necessary to include the servo delay in measurement errors. The deviation can be compensated with the following two types by the parameter as follows:

- (1) Type A: The deviation is the value calculated from the cutting time constant and servo time constant (loop gain).
- (2) Type B: The deviation is the error due to acceleration/deceleration and the position deviation when the skip signal goes on.

TSE When the torque limit skip function (G31 P99/98) is used, the skip position held in a system variable is:

- 0 : Position that is offset considering the delay (positional deviation) incurred by the servo system.
- 1 : Position that does not reflect the delay incurred by the servo system.

NOTE

The torque limit skip function stores the current position in the CNC when the torque limit arrival signal is turned on. However, the current position in the CNC includes a servo system delay, so that the position is shifted from the machine position by an amount corresponding to the servo system delay. The value of this shift can be determined from the servo system positional deviation. When TSE is set to 0, a skip position is determined by subtracting the positional deviation from the current position. When TSE is set to 1, the current position (including the servo system delay) is used as the skip position, without considering any shift or position deviation.

- TSA When the torque limit skip function (G31 P99/98) is used, torque limit arrival monitoring is performed for:
 0 : All axes.
 1 : Only those axes that are specified in the block containing the G31 command.
- IGX When the high-speed skip function is used, SKIP <X004#7>, SKIPP <G006#6>, and +MIT1 to -MIT2 <X004#2-5> are:
 0 : Enabled as skip signals.
 1 : Disabled as skip signals.

NOTE

- 1 SKIPP <G006#6> and +MIT1 to -MIT2 <X004#2-5> are enabled only when bit 0 (GSK) of parameter No.6200 is set to 1 and bit 3 (MIT) of parameter No.6200 is set to 1. Note also that these signals are enabled only for the T series.
- 2 The skip signals for the multistage skip function (SKIP, SKIP2 to SKIP8) can also be disabled.

- SPE For the skip function (G31), the skip signal <X004#7> is:
 0 : Disabled.
 1 : Enabled.

	#7	#6	#5	#4	#3	#2	#1	#0
6202	1S8	1S7	1S6	1S5	1S4	1S3	1S2	1S1
6203	2S8	2S7	2S6	2S5	2S4	2S3	2S2	2S1
6204	3S8	3S7	3S6	3S5	3S4	3S3	3S2	3S1
6205	4S8	4S7	4S6	4S5	4S4	4S3	4S2	4S1
6206	DS8	DS7	DS6	DS5	DS4	DS3	DS2	DS1

[Data type] Bit
 1S1 to 1S8 Specify which high-speed skip signal is enabled when the G31 skip command is issued. The bits correspond to the following signals:
 1S1 HDI0
 1S2 HDI1
 1S3 HDI2
 1S4 HDI3

1S1 to 1S8, 2S1 to 2S8, 3S1 to 3S8, 4S1 to 4S8, DS1 to DS8
 Specify which skip signal is enabled when the skip command (G31, or G31P1 to G31P4) and the dwell command (G04, G04Q1 to G04Q4) are issued with the multi-step skip function.

The following table shows the correspondence between the bits, input signals, and commands.

The setting of the bits have the following meaning :

0 : The skip signal corresponding to the bit is disabled.

1 : The skip signal corresponding to the bit is enabled.

High-speed skip function	
Input signal	Command G31
HDI0	1S1
HDI1	1S2
HDI2	1S3
HDI3	1S4

Multi-step skip function					
Input signal	Command G31 G31P1 G04Q1	G31P2 G04Q2	G31P2 G04Q2	G31P4 G04Q4	G04
SKIP/HDI0	1S1	2S1	3S1	4S1	DS1
SKIP2/HDI1	1S2	2S2	3S2	4S2	DS2
SKIP3/HDI2	1S3	2S3	3S3	4S3	DS3
SKIP4/HDI3	1S4	2S4	3S4	4S4	DS4
SKIP5	1S5	2S5	3S5	4S5	DS5
SKIP6	1S6	2S6	3S6	4S6	DS6
SKIP7	1S7	2S7	3S7	4S7	DS7
SKIP8	1S8	2S8	3S8	4S8	DS8

NOTE
HDI0 to HDI3 are high-speed skip signals.

6210	#7	#6	#5	#4	#3	#2	#1	#0
				ASB	ASL		ROS	

[Data type] Bit
ROS When the skip position goes beyond the roll-over range, the values of system variables #5061 through #5068 indicating the skip signal position:

0 : Are not rolled over.

1 : Are rolled over similar to the absolute coordinates.

ASB, ASL Set the type and time constant of acceleration/deceleration after interpolation for the skip function in advanced preview control, AI advanced preview control, or AI contour control mode as listed below.

ASB	ASL	Acceleration/ deceleration type	Parameter No. of time constant
0	1	Linear	Parameter No. 6280
1	-	Bell-shaped	(If 0 is set, the value in parameter No. 1769 (1768) is used.)
0	0	This function is disabled. (See NOTE.)	

When bell-shaped acceleration/deceleration is specified, the following equations hold as with ordinary bell-shaped acceleration/deceleration after cutting feed interpolation, where T denotes the time constant: $T1=T/2$, $T2=T/2$. Therefore, an acceleration/deceleration type containing no linear part is set.

NOTE
 If ASB is set to 0, and ASL is set to 0, the acceleration/deceleration type is set by bit 3 (BS2) of parameter No.1602 and bit 6 (LS2) of parameter No. 1602, and the time constant set in parameter No. 1762, 768, or 1769 is used.

	#7	#6	#5	#4	#3	#2	#1	#0
6215								CSTx

[Data type] Bit axis
 CSTx For the Cs contour controlled axis, the torque limit skip function is:
 0 : Disabled.
 1 : Enabled.
 Torque limit skip operation is performed for the Cs counter controlled axis by using the serial spindle torque limit command signal TLMH<G070,G074> and the load detection signal LDT1<F045,F049>.

NOTE
 When this parameter is set to perform torque limit skip operation for a Cs counter controlled axis, note the following:

- 1 For the Cs contour controlled axis (spindle) that uses the torque limit skip function, set bit 4 of serial spindle parameter No. 4009 to 1 so that load detection signals are output even during acceleration/deceleration.
- 2 If the load detection state (LDT1 = 1) is set when the torque limit command is specified (TLMH1 = 1) in the Cs mode, no excessive error check at stop is performed for the axis.
- 3 If the load detection state (LDT1 = 1) is set in the Cs mode, no in-position check is made for the axis.

6221

Time from the specification of a torque limit skip until the skip operation is enabled

[Data type]	Word
[Unit of data]	ms
[Valid data range]	0 to 65535
	Set a time from the specification of a torque limit skip until the skip operation is enabled. Within the set time, the skip operation is not performed.

4.32 PARAMETERS OF AUTOMATIC TOOL COMPENSATION (T SERIES) AND AUTOMATIC TOOL LENGTH COMPENSATION (M SERIES)

	#7	#6	#5	#4	#3	#2	#1	#0
6240								AE0

[Data type] Bit

AE0 Measurement position arrival is assumed when the automatic tool compensation signals XAE and ZAE <X004#0,1> (T series) or the automatic tool length measurement signals XAE, YAE, and ZAE <X004#0-2> (M series) are:

0 : 1
1 : 0

6241	Feedrate during measurement of automatic tool compensation
	Feedrate during measurement of automatic tool length compensation

[Data type] Word

[Unit of data, valid data range]

Increment system	Units of data	Valid data range	
		IS-A, IS-B	IS-C
Millimeter machine	1 mm/min	6 to 15000	6 to 12000
Inch machine	0.1 inch/min	6 to 6000	6 to 4800

This parameter sets the feedrate during measurement of automatic tool compensation (T series) and automatic tool length compensation (M series).

6251	γ value on X axis during automatic tool compensation
	γ value during automatic tool length automatic compensation

6252	γ value on Z axis during automatic tool compensation

[Data type] 2-word

[Unit of data]

Input increment	IS-A	IS-B	IS-C	Unit
Millimeter input	0.01	0.001	0.0001	mm
Inch input	0.001	0.0001	0.00001	inch

[Valid data range] 1 to 99999999

These parameters set the γ value during automatic tool compensation (T series) or tool length automatic compensation (M series).

NOTE
Set a radius value irrespective of whether the diameter programming or the radius programming is specified.

6254	ϵ value on X axis during automatic tool compensation
	ϵ value during automatic tool length automatic compensation
6255	ϵ value on Z axis during automatic tool compensation

[Data type] 2-word
[Unit of data]

Input increment	IS-A	IS-B	IS-C	Unit
Millimeter input	0.01	0.001	0.0001	mm
Inch input	0.001	0.0001	0.00001	inch

[Valid data range] 1 to 99999999
These parameters set the ϵ value during automatic tool compensation (T series) or automatic tool length offset (M series).

NOTE
Set a radius value irrespective of whether the diameter programming or the radius programming is specified.

6280	
	Time constant of acceleration/deceleration after interpolation in the skip function in advanced preview control, AI advanced preview control, or AI contour control mode for each axis

[Data type] Word axis
[Unit of data] msec
[Valid data range] 0 to 512
This parameter sets the time constant of acceleration/deceleration after interpolation in the skip function in advanced preview control, AI advanced preview control, or AI contour control mode for each axis. This parameter is valid when bit 3 (ASL) of parameter No. 6210 is set to 1. (See the description of bit 3 (ASL) of parameter No. 6210.) If this parameter is set to 0, the value set in parameter No. 1769 is used. If parameter No. 1769 is set also to 0, the value in parameter No. 1768 is used.

4.33 PARAMETERS OF EXTERNAL DATA INPUT/OUTPUT

	#7	#6	#5	#4	#3	#2	#1	#0
6300	EEX			ESR	ESC			

- [Data type] Bit
- ESC When a reset is input between input of the external data input read signal ESTB <G002#7> and execution of a search, the external program number search function:
 0 : Performs a search.
 1 : Does not perform a search.
- ESR External program number search
 0 : Disabled
 1 : Enabled
- EEX PMC EXIN function
 0 : Conventional specifications
 1 : Extended specifications
- If you want to handle data unavailable with the PMC/EXIN command according to the conventional specifications, such as an 8-digit program number, in an external program number search, set this bit to 1.
- To use this function for multipath control, the setting for the first path (main) is used. The EXIN specifications cannot be changed for each path. For details of EXIN and how to change ladder software, refer to the PMC specifications and other manuals.

6310	Number of added message numbers of external operator messages
------	---

NOTE

When this parameter is set, the power must be turned off before operation is continued.

- [Data type] Word
- [Valid data range] 0, 1 to 1000
- For external operator messages within the range set in this parameter, message numbers each obtained by adding 2000 to the relevant message number are indicated.

NOTE

If 0 or a value beyond the valid data range is set in this parameter, this parameter becomes invalid.

4.34 PARAMETERS OF GRAPHIC DISPLAY

4.34.1 Parameters of Graphic Display/Dynamic Graphic Display

	#7	#6	#5	#4	#3	#2	#1	#0
6500		NZM			DPA			
			DPO					

- [Data type] Bit
- DPA Current position display on the graphic display screen
 0 : Displays the actual position to ensure tool nose radius compensation
 1 : Displays the programmed position
- DPO Current position on the solid drawing (machining profile drawing) or tool path drawing screen
 0 : Not appear
 1 : Appears
- NZM 0 : The screen image is not enlarged by specifying the center of the screen and magnification. (Screen image enlargement by a conventional method is enabled.)
 1 : The screen image is enlarged by specifying the center of the screen and magnification.

	#7	#6	#5	#4	#3	#2	#1	#0
6501			CSR					
			CSR	FIM	RID	3PL	TLC	ORG

- [Data type] Bit
- ORG Movement when coordinate system is altered during drawing
 0 : Draws in the same coordinate system
 1 : Draws in the new coordinate system (only for the tool path drawing)
- TLC In solid drawing
 0 : Not compensate the tool length
 1 : Compensates the tool length
- 3PL Tri-plane drawing in solid drawing
 0 : Drawn by the third angle projection
 1 : Drawn by the first angle projection
- RID In solid drawing
 0 : Draws a plane without edges.
 1 : Draws a plane with edges.
- FIM Machining profile drawing in solid drawing
 0 : Displayed in the coarse mode
 1 : Displayed in the fine mode
- CSR While the screen image is enlarged, the shape of the graphic cursor is:
 0 : A square. (■)
 1 : An X. (X)

	#7	#6	#5	#4	#3	#2	#1	#0
6503							MST	

[Data type] Bit
 MST In check drawing (animated simulation) using the dynamic graphic display function, the M, S, and T code commands in the program are:
 0 : Ignored.
 1 : Output to the machine in the same way as in normal operation.

6510	Drawing coordinate system

[Data type] Byte
 [Valid data range] 0 to 7
 This parameter specifies the drawing coordinate system for the graphic function.
 The following show the relationship between the set values and the drawing coordinate systems.

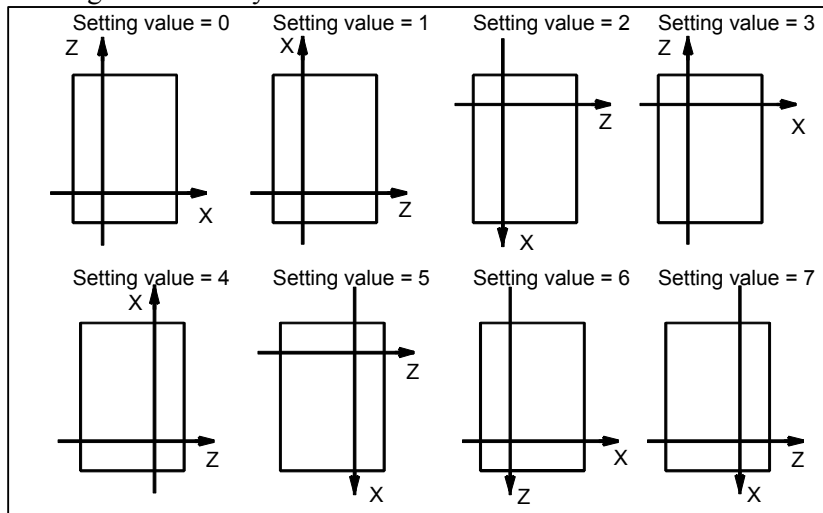

6511	Right margin in solid drawing

6512	Left margin in solid drawing

6513	Upper margin in solid drawing

6514	Lower margin in solid drawing

[Data type] Word
 [Unit of data] Dot

These parameters set the machining profile drawing position in margins. The unit is a dot.

Parameter No.	Margin area	Standard set value	
		DPO = 0	DPO = 1
6511	Right	0	200
6512	Left	0	0
6513	Upper	25	25
6514	Lower	0	0

DPO is set in bit 5 (DPO) of parameter No. 6500.

6515	Change in cross-section position in tri-plane drawing
-------------	--

[Data type] Byte
 [Unit of data] Dot
 [Valid data range] 0 to 10

This parameter sets the change in the cross-section position when a soft key is continuously pressed in tri-plane drawing. When zero is specified, it is set to 1.

6520	C-axis number for dynamic graphic display
-------------	--

[Data type] Byte
 [Valid data range] 0, 1 to number of controlled axes

This parameter sets a C-axis number for dynamic graphic display. When 0 or a value greater than the number of controlled axes is specified with this parameter, the third axis is assumed.

4.34.2 Parameters of Graphic Color

6561	Standard color data for graphic color number 1
6562	Standard color data for graphic color number 2
6563	Standard color data for graphic color number 3
6564	Standard color data for graphic color number 4
6565	Standard color data for graphic color number 5
6566	Standard color data for graphic color number 6
6567	Standard color data for graphic color number 7
6568	Standard color data for graphic color number 8
6569	Standard color data for graphic color number 9

6570	Standard color data for graphic color number 10
6571	Standard color data for graphic color number 11
6572	Standard color data for graphic color number 12
6573	Standard color data for graphic color number 13
6574	Standard color data for graphic color number 14
6575	Standard color data for graphic color number 15
6581	Standard color data for character color number 1
6582	Standard color data for character color number 2
6583	Standard color data for character color number 3
6584	Standard color data for character color number 4
6585	Standard color data for character color number 5
6586	Standard color data for character color number 6
6587	Standard color data for character color number 7
6588	Standard color data for character color number 8
6589	Standard color data for character color number 9
6590	Standard color data for character color number 10
6591	Standard color data for character color number 11
6592	Standard color data for character color number 12
6593	Standard color data for character color number 13
6594	Standard color data for character color number 14
6595	Standard color data for character color number 15

[Data type] 2-word
 [Unit of data] rr gg bb: 6-digit number (rr: Red gg: Green bb: Blue)
 When a number of less than six digits is set, the system assumes that 0 has been specified for the unspecified higher digit(s).

[Valid data range] Data of each color: 00 to 15 (same value as the tone level data on the color setting screen)
When a value of more than 16 is set, the system assumes that 15 has been specified.

Example:

Set 10203 in this parameter when the color tone levels are as follows:

Red: 1 Green: 2 Blue: 3

NOTE

To set the color of the VGA display, use the color setting screen. Note that the color changes when the settings of parameters No.6561 through No.6595 are modified.

4.35 PARAMETERS OF DISPLAYING OPERATION TIME AND NUMBER OF PARTS

	#7	#6	#5	#4	#3	#2	#1	#0
6700							PRT	PCM

- [Data type] Bit
- PCM M code that counts the total number of machined parts and the number of machined parts
 0 : M02, or M30, or an M code specified by parameter No.6710
 1 : Only M code specified by parameter No.6710
- PRT Upon reset, signal PRTSF <F062#7>, which indicates that a required number of parts has been reached, is:
 0 : Turned off.
 1 : Not turned off.

6710	M code that counts the total number of machined parts and the number of machined parts
------	--

- [Data type] 2-word
- [Valid data range] 0 to 255 except 98 and 99
 The total number of machined parts and the number of machined parts are counted (+1) when the M code set is executed.

NOTE

Set value 0 is invalid (the number of parts is not counted for M00). Data 98 and 99 cannot be set.

6711	Number of machined parts
------	--------------------------

- The following parameter can be set at "Setting screen".
- [Data type] 2-word
- [Unit of data] One piece
- [Valid data range] 0 to 99999999
 The number of machined parts is counted (+1) together with the total number of machined parts when the M02, M30, or a M code specified by parameter No.6710 is executed.

NOTE

The number of parts is not counted for M02, M03, when bit 0 (PCM) of parameter No. 6700 is set to 1.

6712	Total number of machined parts	
	The following parameter can be set at "Setting screen".	
[Data type]	2-word	
[Unit of data]	One piece	
[Valid data range]	0 to 99999999	
	This parameter sets the total number of machined parts. The total number of machined parts is counted (+1) when M02, M30, or an M code specified by parameter No.6710 is executed.	
<table border="1"> <tr> <td> <p>NOTE</p> <p>The number of parts is not counted for M02, M03, when bit 0 (PCM) of parameter No. 6700 is set to 1.</p> </td> </tr> </table>		<p>NOTE</p> <p>The number of parts is not counted for M02, M03, when bit 0 (PCM) of parameter No. 6700 is set to 1.</p>
<p>NOTE</p> <p>The number of parts is not counted for M02, M03, when bit 0 (PCM) of parameter No. 6700 is set to 1.</p>		
6713	Number of required parts	
	The following parameter can be set at "Setting screen".	
[Data type]	Word	
[Unit of data]	One piece	
[Valid data range]	0 to 9999	
	This parameter sets the number of required machined parts. Required parts finish signal PRTSF <F062#7> is output to PMC when the number of machined parts reaches the number of required parts. The number of parts is regarded as infinity when the number of required parts is zero. The PRTSF <F062#7> signal is then not output.	
6750	Integrated value of power-on period	
	The following parameter can be set at "Setting screen".	
[Data type]	2-word	
[Unit of data]	min	
[Valid data range]	0 to 99999999	
	This parameter displays the integrated value of power-on period.	
6751	Operation time (integrated value of time during automatic operation) I	
	The following parameter can be set at "Setting screen".	
[Data type]	2-word	
[Unit of data]	msec	
[Valid data range]	0 to 60000	

6752	Operation time (integrated value of time during automatic operation) II
[Data type]	The following parameter can be set at "Setting screen". 2-word
[Unit of data]	min
[Valid data range]	0 to 99999999
	This parameter displays the integrated value of time during automatic operation (neither stop nor hold time included). The actual time accumulated during operation is the sum of this parameter No. 6751 and parameter No. 6752.
6753	Integrated value of cutting time I
[Data type]	The following parameter can be set at "Setting screen". 2-word
[Unit of data]	msec
[Valid data range]	1 to 60000
6754	Integrated value of cutting time II
[Data type]	The following parameter can be set at "Setting screen". 2-word
[Unit of data]	min
[Valid data range]	0 to 99999999
	This parameter displays the integrated value of a cutting time that is performed in cutting feed such as linear interpolation (G01) and circular interpolation (G02 or G03). The actual time accumulated during cutting is the sum of this parameter No. 6753 and parameter No. 6754.
6755	Integrated value of general-purpose integrating meter drive signal (TMRON) ON time I
[Data type]	The following parameter can be set at "Setting screen". 2-word
[Unit of data]	msec
[Valid data range]	0 to 60000
6756	Integrated value of general-purpose integrating meter drive signal (TMRON) ON time II
[Data type]	The following parameter can be set at "Setting screen". 2-word
[Unit of data]	min
[Valid data range]	0 to 99999999
	This parameter displays the integrated value of a time while input signal TMRON <G053#0> from PMC is on. The actual integrated time is the sum of this parameter No. 6755 and parameter No. 6756.
6757	Operation time (integrated value of one automatic operation time) I

The following parameter can be set at "Setting screen".
 [Data type] 2-word
 [Unit of data] msec
 [Valid data range] 0 to 60000

6758	Operation time (integrated value of one automatic operation time) II
-------------	---

The following parameter can be set at "Setting screen".
 [Data type] 2-word
 [Unit of data] min
 [Valid data range] 0 to 99999999

This parameter displays the one automatic operation drive time (neither stop nor hold state included). The actual time accumulated during operating is the sum of this parameter No. 6757 and parameter No. 6758. The operation time is automatically preset to 0 during the power-on sequence and the cycle start from the reset state.

4.36 PARAMETERS OF TOOL LIFE MANAGEMENT

6800	#7	#6	#5	#4	#3	#2	#1	#0
	M6T	IGI	SNG	GRS	SIG	LTM	GS2	GS1

[Data type] Bit

GS1, GS2

This parameter sets the combination of the number of tool life groups which can be entered, and the number of tools which can be entered per group as shown in the table below.

GS2	GS1	M series		T series	
		Group count	Tool count	Group count	Tool count
0	0	1 to 16	1 to 16	1 to 16	1 to 16
0	1	1 to 32	1 to 8	1 to 32	1 to 8
1	0	1 to 64	1 to 4	1 to 64	1 to 4
1	1	1 to 128	1 to 2	1 to 16	1 to 16

LTM Tool life

0 : Specified by the number of times

1 : Specified by time

SIG Group number is

0 : Not input using the tool group signal during tool skip (The current group is specified.)

1 : Input using the tool group signal during tool skip

GRS Tool exchange reset signal TLRST<G048#7>

0 : Clears only the execution data of a specified group

1 : Clears the execution data of all entered groups

SNG Input of the tool skip signal TLSKP <G048#5> when a tool that is not considered tool life management is selected.

0 : Skips the tool of the group used last or of the specified group (using SIG , #3 of parameter No.6800).

1 : Ignores a tool skip signal

IGI Tool back number

0 : Not ignored

1 : Ignored

M6T T code in the same block as M06

0 : Judged as a back number

1 : Judged as a next tool group command

6801	#7	#6	#5	#4	#3	#2	#1	#0
	M6E	EXG	E1S					TSM

[Data type] Bit

TSM

When a tool takes several tool numbers, life is counted in tool life management:

0 : For each of the same tool numbers.

1 : For each tool.

- LFV The life count override in the extended tool life management function is:
 0 : Disabled.
 1 : Enabled.
- EMD An asterisk (*) indicating that a tool has been expired is displayed,
 0 : When the next tool is selected
 1 : When the tool life is expired
- E1S When the life of a tool is measured in time-based units:
 0 : The life is counted every four seconds.
 1 : The life is counted every second. (The maximum life is 1075 (minutes).)

NOTE
 This parameter is valid when bit 2 (LTM) of parameter No.6800 is set to 1.

- EXT Specifies whether the extended tool life management function (M series) is used.
 0 : Not used
 1 : Used
- EXG Tool life management data registration by G10 (T series) is:
 0 : Performed after the data for all tool groups has been cleared.
 1 : Performed by adding/changing or deleting the data for a specified group.

NOTE
 When EXG = 1, address P in the block including G10 can be used to specify whether data is to be added/changed or deleted (P1: add/change, P2: delete). When P is not specified, the data for all tool groups is cleared before the tool life management data is registered.

- M6E When a T code is specified in the same block as M06
 0 : The T code is processed as a return number or as a group number selected next. Either is set by parameter M6T (No.6800#7).
 1 : The tool group life is counted immediately.

	#7	#6	#5	#4	#3	#2	#1	#0
6802								T99
	RMT	TSK				E17	TCO	T99

- [Data type] Bit
- T99 If a tool group whose life has expired is found to exist when M99 is executed in the main program:
 0 : The tool change signal is not output.
 1 : The tool change signal is output.
- TCO When function code 171 or 172 (tool life management data write) of the PMC window function is specified, tool data of a tool in the currently selected group that is currently not in use:

- 0 : Cannot be cleared.
- 1 : Can be cleared.
- E17 When function code 171 or 172 (tool life management data write) of the PMC window function is specified to clear tool life management data of the tool currently in use in the currently selected group:
 - 0 : The tool data is not cleared and operation terminates normally.
 - 1 : The tool data is not cleared and completion code 13 is output.
- TSK When the life is specified by time and the last tool in a group is skipped in tool life management:
 - 0 : The count for the last tool indicates the life value.
 - 1 : The count for the last tool is not changed.
- RMT Specifies when to turn off the tool life arrival signal TLCHB, as follows:
 - 0 : The actual remaining life is longer than that specified in a parameter ("less than" type).
 - 1 : The actual remaining life is not equal to that specified in a parameter ("equal" type).

	#7	#6	#5	#4	#3	#2	#1	#0
6803							LFE	LGR
							LFE	

NOTE
 After this parameter has been set, the power must be turned off then on again for the setting to become effective.

[Data type] Bit
 LGR When the tool life management function is used, a tool life type is:
 0 : Chosen based on the LTM parameter (bit 2 of parameter No.6800) for all groups.
 1 : Set to either count or duration on a group-by-group basis.
 When LGR is set to 1, the specification of address Q is added to the G10 (tool life management data setting) command format. As shown in the example below, specify the tool life of each group as either a count (Q1) or a duration (Q2). If address Q is omitted for a group, the specification of the LTM parameter (bit 2 of parameter No.6800) applies to the group.

Example:
 When the LTM parameter (bit 2 of parameter No.6800) is set to 0
 G10 L3 ;
 P1 L10 Q1 ; (Q1: The life of group 1 is specified as a count.)
 :
 P2 L20 Q2 ; (Q2: The life of group 2 is specified as a duration.)
 :
 P3 L20 ;
 (Omission of Q: The life of group 3 is specified as a count.)
 :
 G11 ;
 M30 ;

%

LFE When a tool life is specified by count:
 0 : A count value from 0 to 9999 can be specified.
 1 : A count value from 0 to 65535 can be specified.

	#7	#6	#5	#4	#3	#2	#1	#0
6804							TC1	
						ETE	TC1	E10

[Data type] Bit
 E10 When the tool life is specified by time:
 0 : The tool life is counted at intervals of 4 seconds.
 1 : The tool life is counted at intervals of 10 seconds.

NOTE
 This parameter is valid when bit 2 (LTM) of parameter No. 6800 is set to 1.

TC1 During automatic operation, preset of the tool life counter is:
 0 : Disabled.
 1 : Enabled.

ETE In extended tool life management, as the mark indicating that the life of the last tool in a group has expired:
 0 : "@" is also used.
 1 : "*" is used.

6810	
	Tool life management ignored number

[Data type] Word
 [Valid data range] 0 to 9999
 This parameter sets the tool life management ignored number.
 When the set value is subtracted from a T code, a remainder is used as the tool group number of tool life management when a value exceeding the set value is specified in the T code.

6811	Tool life count restart M code

- [Data type] 2-word
 [Valid data range] 0 to 255 (not including 01, 02, 30, 98, and 99)
 When zero is specified, it is ignored.
 When the life is specified by the number of times, the tool exchange signal is output when a tool life count restart M code is specified if tool life of at least one tool group is expired. A tool in life is selected in the specified group when a T code command (tool group command) is specified after the tool life count restart M code is specified. A tool life counter is then incremented by one.
 When the life is specified by time, a tool in life is selected in the specified group when a T code command (tool group command) is specified after the tool life count restart M code is specified.

6844	
	Remaining tool life (use count)

- [Data type] Word
 [Unit of data] Count
 [Valid data range] 0 to 9999
 This parameter sets a remaining tool life (use count) used to output the tool life arrival notice signal TLCHB <F064#3> when the tool life is specified as a use count.

NOTE

- 1 When the remaining life (use count) of a selected tool reaches the value specified with this parameter, tool life arrival notice signal TLCHB is output to the PMC.
- 2 If a value greater than the life of a tool is specified with this parameter, the tool life arrival notice signal TLCHB is not output.

6845	
	Remaining tool life (use duration)

- [Data type] 2-word
 [Unit of data] min
 [Valid data range] 0 to 4300
 This parameter sets the remaining tool life (use duration), used to output the tool life arrival notice signal TLCHB <F064#3> when the tool life is specified as a use duration.

NOTE

- 1 When the remaining life (use duration) of a selected tool reaches the value specified in this parameter, tool life arrival notice signal TLCHB is output to the PMC. The tool life management function allows the user to specify a tool life either as a use duration or use count for each tool group. For a group whose life is specified as a use count, parameter No.6844 is used. For a group whose life is specified as a use time, this parameter is used.
- 2 If a value greater than the life of a tool is specified with parameter No.6845, the tool life arrival notice signal TLCHB is not output.

6846

Number of remaining tools in a group

[Data type]
[Valid data range]

Byte
0 to 127
This parameter sets the number of remaining tools in a group. If the number of remaining tools in the currently used group is equal to or smaller than the number set in this parameter, signal TLAL <F154#0> is output. If this parameter is set to 0, the signal is not output.

4.37 PARAMETERS OF POSITION SWITCH FUNCTIONS

	#7	#6	#5	#4	#3	#2	#1	#0
6901						PCM	EPS	IGP
					PSF	PCM	EPS	IGP

[Data type] Bit

IGP During follow-up for the absolute position detector, position switch signals are:

0 : Output

1 : Not output

EPS The number of position switches is:

0 : Up to 10.

1 : Up to 16.

PCM Position switch signals are output:

0 : Without considering acceleration/deceleration and servo delay.

1 : With considering acceleration/deceleration and servo delay.

PSF In advanced preview control mode, AI advanced preview control mode, or AI contour control mode, position switches are:

0 : Not used.

1 : Used.

NOTE

The position switch signals are output considering acceleration/deceleration after interpolation and servo delay. Acceleration/deceleration after interpolation and servo delay are considered even for position switch signal output in a mode other than advanced preview control mode, AI advanced preview control mode, and AI contour control mode. When this parameter is set to 1, however, signals are output from the position switches at different times from the specified ones.

6910	Axis corresponding to the first position switch
6911	Axis corresponding to the second position switch
6912	Axis corresponding to the third position switch
6913	Axis corresponding to the fourth position switch
6914	Axis corresponding to the fifth position switch
6915	Axis corresponding to the sixth position switch
6916	Axis corresponding to the seventh position switch
6917	Axis corresponding to the eighth position switch
6918	Axis corresponding to the ninth position switch
6919	Axis corresponding to the tenth position switch
6920	Axis corresponding to the eleventh position switch
6921	Axis corresponding to the twelveth position switch
6922	Axis corresponding to the thirteenth position switch
6923	Axis corresponding to the fourteenth position switch
6924	Axis corresponding to the fifteenth position switch
6925	Axis corresponding to the sixteenth position switch

[Data type]
[Valid data range]

Byte

0 to Number of controlled axes

These parameters sequentially specify the numbers of the controlled axes corresponding to the 1st through 16th position switch functions. The corresponding position switch signal is output to the PMC when the machine coordinate of the corresponding axis is within the range set in parameters.

NOTE

Set 0 for the number corresponding to a position switch which is not to be used.

6930	Maximum operation range of the first position switch
6931	Maximum operation range of the second position switch
6932	Maximum operation range of the third position switch
6933	Maximum operation range of the fourth position switch
6934	Maximum operation range of the fifth position switch
6935	Maximum operation range of the sixth position switch
6936	Maximum operation range of the seventh position switch
6937	Maximum operation range of the eighth position switch
6938	Maximum operation range of the ninth position switch
6939	Maximum operation range of the tenth position switch
6940	Maximum operation range of the eleventh position switch
6941	Maximum operation range of the twelveth position switch
6942	Maximum operation range of the thirteenth position switch
6943	Maximum operation range of the fourteenth position switch
6944	Maximum operation range of the fifteenth position switch
6945	Maximum operation range of the sixteenth position switch

[Data type] 2-word
 [Unit of data]

Input increment	IS-A	IS-B	IS-C	Unit
Metric machine	0.01	0.001	0.0001	mm
Inch machine	0.001	0.0001	0.00001	inch
Rotation axis	0.01	0.001	0.0001	deg

[Valid data range] -99999999 to 99999999
 These parameters sequentially set the maximum operation ranges of the 1st through 16th position switches.

6950	Minimum operation range of the first position switch
6951	Minimum operation range of the second position switch
6952	Minimum operation range of the third position switch
6953	Minimum operation range of the fourth position switch
6954	Minimum operation range of the fifth position switch
6955	Minimum operation range of the sixth position switch
6956	Minimum operation range of the seventh position switch
6957	Minimum operation range of the eighth position switch
6958	Minimum operation range of the ninth position switch
6959	Minimum operation range of the tenth position switch
6960	Minimum operation range of the eleventh position switch
6961	Minimum operation range of the twelveth position switch
6962	Minimum operation range of the thirteenth position switch
6963	Minimum operation range of the fourteenth position switch
6964	Minimum operation range of the fifteenth position switch
6965	Minimum operation range of the sixteenth position switch

[Data type] 2-word
 [Unit of data]

Input increment	IS-A	IS-B	IS-C	Unit
Metric machine	0.01	0.001	0.0001	mm
Inch machine	0.001	0.0001	0.00001	inch
Rotation axis	0.01	0.001	0.0001	deg

[Valid data range] -99999999 to 99999999
 These parameters sequentially set the minimum operation ranges of the 1st through 16th position switches.

4.38 PARAMETERS OF MANUAL OPERATION AND AUTOMATIC OPERATION

	#7	#6	#5	#4	#3	#2	#1	#0
7001								MIN

[Data type] Bit
 MIN The manual intervention and return function is:
 0 : Disabled.
 1 : Enabled.

7015	Least command increment setting for jog feed
------	--

[Data type] Word
 [Unit of data]

Input increment	IS-A	IS-B	IS-C	Unit
Metric machine	0.01	0.001	0.0001	mm
Inch machine	0.001	0.0001	0.00001	inch
Rotation axis	0.01	0.001	0.0001	deg

[Valid data range] 0 to 10000
 This parameter sets the least command increment for jog feed when PMC signal JGUNIT <G0023#0> is set to 1. If the setting of this parameter is 0, a value of 1 is recognized.

	#7	#6	#5	#4	#3	#2	#1	#0
7050								
		MI1	MI0					

NOTE
 After setting this parameter, turn off the power.
 Then, turn the power back on to enable the setting.

[Data type] Bit
 MI0, MI1 Set this parameter as indicated below.

	MI1	MI0
When the servo FAD function is not used in AI advanced preview control or AI contour control	0	1
When the servo FAD function is used in AI advanced preview control or AI contour control	0	0

	#7	#6	#5	#4	#3	#2	#1	#0
7051					ACR			

[Data type] Bit
 ACR When rigid tapping is specified in AI advanced preview control mode or AI contour control mode, the mode is:
 0 : Not turned off.
 1 : Turned off.
 When the serial spindle does not support advanced preview control of rigid tapping, AI advanced preview control mode or AI contour control mode must be turned off in rigid tapping.
 Setting this parameter and satisfying the following conditions can automatically turn AI advanced preview control mode or AI contour control mode off only during execution of rigid tapping when rigid tapping is specified in AI advanced preview control mode or AI contour control mode.
 Conditions

- To specify rigid mode, use "the method for specifying M29 S**** prior to the tapping command."
 If a method other than the above is used, P/S alarm No. 5110 is issued.
- The interval between M29 (rigid mode specification M code) and the completion signal (FIN) must be at least 32 msec.
- The rigid mode cancel command and cutting feed move command cannot be specified simultaneously. If they are specified simultaneously, P/S alarm No. 5110 is issued.
 (Additional information: The rigid mode cancel command and rapid traverse move command can be specified in the same block.)
- Set bit 2 (CRG) of parameter No. 5200 to 0.
 (This setting specifies that rigid tapping mode is canceled when the rigid tapping signal RGTAP is set to "0".)

	#7	#6	#5	#4	#3	#2	#1	#0
7052								NMI

NOTE
 After this parameter has been set, the power must be turned off.

[Data type] Bit axis
 NMI Set this parameter as indicated below.

	NMI
Axes used for the function below when the servo FAD function is not used: <ul style="list-style-type: none"> • PMC axis • Cs axis • Index table indexing axis set for follow-up (fourth axis) 	1
When the servo FAD function is used	0

	#7	#6	#5	#4	#3	#2	#1	#0
7053								
							AIP	

NOTE
When this parameter has been set, the power must be turned off before operation is continued.

[Data type] Bit
AIP In AI contour control, a stroke limit check before movement is:
0 : Disabled.
1 : Enabled.

NOTE
The stroke limit check before movement must be enabled (by setting bit 7 (PLC) of parameter No. 1301 to 1).

	#7	#6	#5	#4	#3	#2	#1	#0
7054								
			AIL		AZR	FNS	AIR	

[Data type] Bit
AIR In AI advanced preview control mode or AI contour control mode, the rapid traverse type is:
0 : Linear interpolation type positioning (acceleration/deceleration before interpolation is performed).
1 : According to the setting of bit 1 (LRP) of parameter No. 1401.
FNS When an S code is specified in AI advanced preview control or AI contour control mode, execution of a move command in the same block as the block specifying the S code is:
0 : Decelerated to stop once.
1 : Not decelerated to stop.
AZR In AI advanced preview control mode or AI contour control mode, the G27, G28, G30, G30.1, and G53 commands are executed:
0 : In normal mode. (advanced preview feed forward is valid.)
1 : In AI contour control mode.
AIL When non-linear type positioning is specified in AI advanced preview control mode or AI contour control mode and an axis-by-axis interlock signal is input:
0 : The tool stops along all axes.
1 : The setting of bit 4 (XIK) of parameter No. 1002 is used.

	#7	#6	#5	#4	#3	#2	#1	#0
7055			ODA	ADP	BCG	ALZ	AF1	ACO

[Data type] Bit

- ACO In AI advanced preview control mode or AI contour control mode:
0 : Automatic corner override and changing both internal and external circular feedrates are disabled.
1 : Automatic corner override and changing the internal circular feedrate are enabled, and whether to enable changing the external circular feedrate depends on the setting of bit 2 (COV) of parameter No. 1602.
- AF1 During one-digit F code feed in AI advanced preview control mode or AI contour control mode, changing the feedrate by the manual handle is:
0 : Disabled.
1 : Enabled.
- ALZ If no reference position has been established and G28 is specified in AI contour control mode:
0 : P/S alarm No. 090 is issued.
1 : AI advanced preview control mode or AI contour control mode is turned off and the command is executed.
- BCG The bell-shaped acceleration/deceleration time constant change function in AI contour control mode is:
0 : Disabled.
1 : Enabled.
See also the description of parameter No. 7066.
- ADP In AI advanced preview control or AI contour control mode, positioning in a single direction is:
0 : Performed in normal mode.
1 : Performed in AI contour control or AI nano contour control mode.
- ODA In advanced preview control, AI advanced preview control, or AI contour control mode, the distance to a stored stroke limit is determined for:
0 : The axes specified by the current block and next block.
1 : The axes specified by the current block.

7066	Acceleration/deceleration reference speed for the bell-shaped acceleration/deceleration time constant change function in AI contour control mode
-------------	---

[Data type] 2 word
 [Unit of data, valid data range]

Increment system	Units of data	Valid data range	
		IS-B	IS-C
Millimeter input	1 mm/min	0 - 600000	0 - 60000
Inch machine	0.1 inch/min	0 - 600000	0 - 60000

Set the acceleration/deceleration reference speed for the function for changing the time constant of bell-shaped acceleration/deceleration before interpolation (bit 3 (BCG) of parameter No. 7055 = 1) in AI contour control.

Since this parameter is set in the input unit, when the input unit has been changed, the setting of the parameter must be changed.

4.39 PARAMETERS OF MANUAL HANDLE FEED, MANUAL HANDLE INTERRUPTION AND TOOL DIRECTION HANDLE FEED

	#7	#6	#5	#4	#3	#2	#1	#0
7100				HPF	HCL	IHD	THD	JHD

[Data type] Bit
 JHD Manual handle feed in JOG feed mode or incremental feed in the manual handle feed
 0 : Invalid
 1 : Valid

	When JHD:=0		When JHD:=1	
	JOG feed mode	Manual handle feed mode	JOG feed mode	Manual handle feed mode
JOG feed	○	X	○	X
Manual handle feed	X	○	○	○
Incremental feed	X	X	X	○

THD Manual pulse generator in TEACH IN JOG mode
 0 : Invalid
 1 : Valid

IHD The travel increment for manual handle interrupt is:
 0 : Output unit, and acceleration/deceleration after interpolation is disabled.
 1 : Input unit, and acceleration/deceleration after interpolation is enabled.

HCL The clearing of handle interruption amount display by soft key [CAN] operation is:
 0 : Disabled.
 1 : Enabled.

HPF When a manual handle feed exceeding the rapid traverse rate is issued,
 0 : The rate is clamped at the rapid traverse rate, and the handle pulses corresponding to the excess are ignored. (The graduations of the manual pulse generator may not agree with the distance the machine has traveled.)
 1 : The rate is clamped at the rapid traverse rate, and the handle pulses corresponding to the excess are not ignored, but stored in the CNC. (If the rotation of the manual pulse generator is stopped, the machine moves by the distance corresponding to the pulses preserved in the CNC, then stops.)

	#7	#6	#5	#4	#3	#2	#1	#0
7102								HNGx

- [Data type] Bit axis
 HNGx Axis movement direction for rotation direction of manual pulse generator
 0 : Same in direction
 1 : Reverse in direction

	#7	#6	#5	#4	#3	#2	#1	#0
7103			HIE	IBH	HIT	HNT	RHD	

- [Data type] Bit
 RHD By a reset, the amount of manual handle interruption is:
 0 : Not canceled.
 1 : Canceled.

NOTE

This parameter is valid when bit 2 (IHD) of parameter No. 7100 is set to 1.

- HNT The manual handle feed/incremental feed magnification is:
 0 : Multiplied by 1.
 1 : Multiplied by 10.
- HIT The manual handle interruption magnification is:
 0 : Multiplied by 1.
 1 : Multiplied by 10.
- IBH Manual handle feed for the β servo unit using an I/O link manual pulse generator is:
 0 : Disabled.
 1 : Enabled.
- HIE As the acceleration/deceleration type and time constant for manual handle interruption:
 0 : Those used in automatic operation are used.
 1 : Those used in manual feed are used.
 (The acceleration/deceleration type is determined by bit 0 (CTL) and bit 4 (JGL) of parameter No. 1610. As the time constant, the value set in parameter No. 1624 is used, and as the FL feedrate, the value set in parameter No. 1625 is used.)

NOTE

This parameter is valid when bit 2 (IHD) of parameter No. 7100 is set to 1.

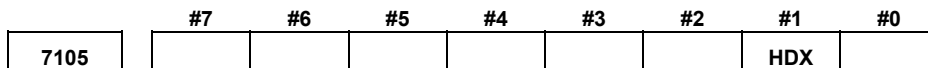

[Data type] Bit
 HDX I/O Link manual handles are:
 0 : Assigned automatically in the order of connection to the I/O Link.
 1 : Assigned to the addresses of the X signals set in parameter Nos. 12305 to 12307.

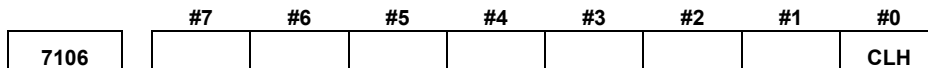

[Data type] Bit
 CLH When a high-speed type manual reference position return, reference position setting without dogs after the establishment of the reference position, reference position setting by pressing an axis against the stopper, or workpiece coordinate system presetting is performed, the indication of the manual handle interruption amount is:
 0 : Not cleared.
 1 : Cleared.

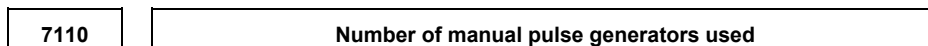

[Data type] Byte
 [Valid data range] 1 or 2 (T series), 3 (M series)
 This parameter sets the number of manual pulse generators.

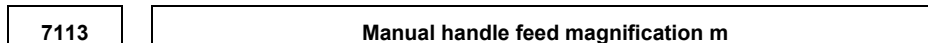

[Data type] Word
 [Unit of data] One time
 [Valid data range] 1 to 127
 This parameter sets the magnification when manual handle feed movement selection signals MP1 and MP2 are set to 0 and 1.

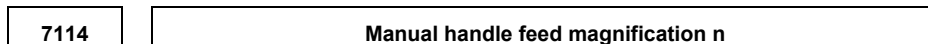

[Data type] Word
 [Unit of data] One time
 [Valid data range] 1 to 1000
 This parameter sets the magnification when manual handle feed movement selection signals MP1 and MP2 are set to 1.

Movement selection signal		Movement (Manual handle feed)
MP2	MP1	
0	0	Least input increment 1
0	1	Least input increment 10
1	0	Least input increment m
1	1	Least input increment n

7117

Allowable number of pulses that can be accumulated during manual handle
feed

[Data type] 2-Word
 [Unit of data] Pulses
 [Valid data range] 0 to 99999999

If manual handle feed is specified such that the rapid traverse rate will be exceeded momentarily, those pulses received from the manual pulse generator that exceed the rapid traverse rate are accumulated rather than canceled.

This parameter sets the maximum number of pulses which can be accumulated in such a case.

NOTE

If the specification of manual handle feed is such that the rapid traverse rate will be exceeded, for example, when the manual pulse generator is rotated at high speed with a large magnification such as 100, the axial feedrate is clamped at the rapid traverse rate and those pulses received from the manual pulse generator that exceed the rapid traverse rate are ignored. In such a case, therefore, the scale on the manual pulse generator may differ from the actual amount of travel. If such a difference is not acceptable, this parameter can be set to temporarily accumulate the excess pulses in the CNC, rather than ignoring them, up to the specified maximum (pulses in excess of the set maximum are ignored). The accumulated pulses are output and converted to a move command once the feedrate falls below the rapid traverse rate by reducing the rotational speed of the manual pulse generator or stopping its rotation altogether. Note, however, that if the maximum number of pulses to be accumulated is too large, stopping the rotation of the manual pulse generator does not stop feeding until the tool moves by an amount corresponding to the pulses accumulated in the CNC.

4.40 PARAMETERS OF BUTT-TYPE REFERENCE POSITION SETTING

7181 First withdrawal distance in butt-type reference position setting

[Data type] 2-word axis
 [Unit of data]

Input increment	IS-A	IS-B	IS-C	Unit
Millimeter input	0.01	0.001	0.0001	mm
Inch input	0.001	0.0001	0.00001	inch

[Valid data range] -99999999 to 99999999
 When the butt-type reference position setting is used, this parameter sets a distance an axis, along which withdrawal is performed after the mechanical stopper is hit (distance from the mechanical stopper to the withdrawal point).

NOTE
 Set the same direction as that set in bit 5 (ZMIx) of parameter No. 1006. Cycle operation cannot be started if the opposite direction is set.

7182 Second withdrawal distance in butt-type reference position setting

[Data type] 2-word axis
 [Unit of data]

Input increment	IS-A	IS-B	IS-C	Unit
Millimeter input	0.01	0.001	0.0001	mm
Inch input	0.001	0.0001	0.00001	inch

[Valid data range] -99999999 to 99999999
 When the butt-type reference position setting is used, this parameter sets a distance an axis, along which withdrawal is performed after the mechanical stopper is hit (distance from the mechanical stopper to the withdrawal point).

NOTE
 Set the same direction as that set in bit 5 (ZMIx) of parameter No. 1006. Cycle operation cannot be started if the opposite direction is set.

7183

First butting feedrate in butt-type reference position setting

[Data type]
[Unit of data, valid data range]

Word axis

Increment system	Units of data	Valid data range	
		IS-A, IS-B	IS-C
Millimeter machine	1 mm/min	30 to 15000	30 to 12000
Inch machine	0.1 inch/min	30 to 6000	30 to 4800

When the butt-type reference position setting is used, this parameter sets the feedrate first used to hit the stopper on an axis.

7184

Second butting feedrate in butt-type reference position setting

[Data type]
[Unit of data, valid data range]

Word axis

Increment system	Units of data	Valid data range	
		IS-A, IS-B	IS-C
Millimeter machine	1 mm/min	30 to 15000	30 to 12000
Inch machine	0.1 inch/min	30 to 6000	30 to 4800

When the butt-type reference position setting is used, this parameter sets the feedrate used to hit the stopper on an axis for a second time.

7185

Withdrawal feedrate (common to the first and second butting operations) in butt-type reference position setting

[Data type]
[Unit of data, valid data range]

Word axis

Increment system	Units of data	Valid data range	
		IS-A, IS-B	IS-C
Millimeter machine	1 mm/min	30 to 15000	30 to 12000
Inch machine	0.1 inch/min	30 to 6000	30 to 4800

When the butt-type reference position setting is used, this parameter sets the feedrate used for withdrawal along an axis after the mechanical stopper has been hit.

7186

Torque limit value in butt-type reference position setting

[Data type]
[Unit of data]
[Valid data range]

Byte axes

%

0 to 100

This parameter sets a torque limit value in butt-type reference position setting.

NOTE

When 0 is set in this parameter, 100% is assumed.

4.41 PARAMETERS OF SOFTWARE OPERATOR'S PANEL

	#7	#6	#5	#4	#3	#2	#1	#0
7200		OP7	OP6	OP5	OP4	OP3	OP2	OP1

- [Data type] Bit
- OP1 Mode selection on software operator's panel
0 : Not performed
1 : Performed
 - OP2 JOG feed axis select and JOG rapid traverse buttons on software operator's panel
0 : Not performed
1 : Performed
 - OP3 Manual pulse generator's axis select and manual pulse generator's magnification switches on software operator's panel
0 : Not performed
1 : Performed
 - OP4 JOG speed override and rapid traverse override switches on software operator's panel
0 : Not performed
1 : Performed
 - OP5 Optional block skip, single block, machine lock, and dry run switches on software operator's panel
0 : Not performed
1 : Performed
 - OP6 Protect key on software operator's panel
0 : Not performed
1 : Performed
 - OP7 Feed hold on software operator's panel
0 : Not performed
1 : Performed









	#7	#6	#5	#4	#3	#2	#1	#0
7201								JPC

- [Data type] Bit
- JPC For the name of a general-purpose switch function on the software operator's panel, the use of full-size characters is:
0 : Not allowed.
1 : Allowed.

7210	Job-movement axis and its direction on software operator's panel "↑"
7211	Job-movement axis and its direction on software operator's panel "↓"
7212	Job-movement axis and its direction on software operator's panel "→"
7213	Job-movement axis and its direction on software operator's panel "←"
7214	Job-movement axis and its direction on software operator's panel "↖"
7215	Job-movement axis and its direction on software operator's panel "↗"
7216	Job-movement axis and its direction on software operator's panel "↘"
7217	Job-movement axis and its direction on software operator's panel "↙"

[Data type] Byte
 [Valid data range] 0 to 8

On software operator's panel, set a feed axis corresponding to an arrow key on the MDI panel when jog feed is performed.

Set value	Feed axis and direction	Arrow keys on the MDI panel
0	Not moved	
1	First axis, positive direction	
2	First axis, negative direction	
3	Second axis, positive direction	
4	Second axis, negative direction	
5	Third axis, positive direction	
6	Third axis, negative direction	
7	Fourth axis, positive direction	
8	Fourth axis, negative direction	
		

[Example]

Under X, Y, and Z axis configuration, to set arrow keys to feed the axes in the direction specified as follows, set the parameters to the values given below. [8 ↑] to the positive direction of the Z axis, [2 ↓] to the negative direction of the Z axis, [6 →] to the positive direction of the X axis [4 ←] to the negative direction of the X axis, [1 ↖] to the positive direction of the Y axis, [9 ↗] to the negative direction of the Y axis

- Parameter No.7210 = 5 (Z axis, positive direction)
- Parameter No.7211 = 6 (Z axis, negative direction)
- Parameter No.7212 = 1 (X axis, positive direction)
- Parameter No.7213 = 2 (X axis, negative direction)
- Parameter No.7214 = 3 (Y axis, positive direction)
- Parameter No.7215 = 4 (Y axis, negative direction)
- Parameter No.7216 = 0 (Not used)
- Parameter No.7217 = 0 (Not used)

7220	Name of general-purpose switch on software operator's panel
:	:
7283	Name of general-purpose switch on software operator's panel

[Data type] Byte
 [Example] These parameters set the names of the general-purpose switches (SIGNAL 1 through SIGNAL 8) on the software operator's panel as described below.

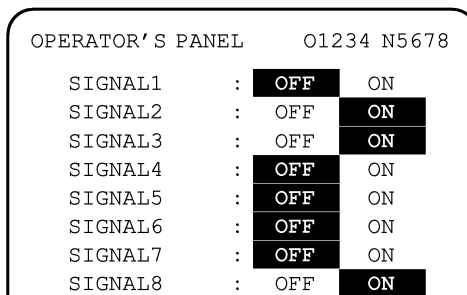

These names are set using character codes that are displayed in parameter Nos. 7220 to 7283.

Parameter No.7220:

Sets the character code (083) corresponding to S of SIGNAL 1.

Parameter No.7221:

Sets the character code (073) corresponding to I of SIGNAL 1.

Parameter No.7222:

Sets the character code (071) corresponding to G of SIGNAL 1.

Parameter No.7223:

Sets the character code (078) corresponding to N of SIGNAL 1.

Parameter No.7224:

Sets the character code (065) corresponding to A of SIGNAL 1.

Parameter No.7225:

Sets the character code (076) corresponding to L of SIGNAL 1.

Parameter No.7226:

Sets the character code (032) corresponding to (space) of SIGNAL 1.

Parameter No.7227:

Sets the character code (049) corresponding to 1 of SIGNAL 1.

Parameter Nos. 7228 to 7235:

Set the character codes of SIGNAL 2 shown in the figure above.

Parameter Nos. 7236 to 7243:

Set the character codes of SIGNAL 3 shown in the figure above.

Parameter Nos. 7244 to 7251:

Set the character codes of SIGNAL 4 shown in the figure above.

Parameter Nos. 7252 to 7259:

Set the character codes of SIGNAL 5 shown in the figure above.

Parameter Nos. 7260 to 7267:

Set the character codes of SIGNAL 6 shown in the figure above.

Parameter Nos. 7268 to 7275:

Set the character codes of SIGNAL 7 shown in the figure above.

Parameter Nos. 7276 to 7283:

Set the character codes of SIGNAL 8 shown in the figure above.

The character codes are shown in Appendix A CHARACTER CODE LIST.

4.42 PARAMETERS OF PROGRAM RESTART

	#7	#6	#5	#4	#3	#2	#1	#0
7300	MOU	MOA						
	MOU	MOA			SJG			

[Data type] Bit

SJG Return feedrate in program restart operation
 0 : Dry run feedrate
 1 : Jog feedrate

MOA In program restart operation, before movement to a machining restart point after restart block search:
 0 : The last M, S, T, and B codes are output.
 1 : All M codes and the last S, T, and B codes are output.

NOTE
 This parameter is enabled when the MOU parameter is set to 1.

MOU In program restart operation, before movement to a machining restart point after restart block search:
 0 : The M, S, T, and B codes are not output.
 1 : The last M, S, T, and B codes are output.

7310	Movement sequence to program restart position
------	---

The following parameter can be set at "Setting screen".

[Data type] Byte axis
 [Valid data range] 1 to No. of controlled axes

This parameter sets the axis sequence when the machine moves to the restart point by dry run after a program is restarted.

[Example]

The machine moves to the restart point in the order of the fourth, first, second, and third axes one at a time when the first axis = 2, the second axis = 3, the third axis = 4, and the fourth axis = 1 are set.

4.43 PARAMETERS OF POLYGON TURNING

7600	#7	#6	#5	#4	#3	#2	#1	#0
	PLZ						PQE	

[Data type] Bit

PQE The specification range of the rotation ratio for polygon turning
 0 : P=1 to 9, Q=-9 to -1, 1 to 9
 1 : P=1 to 999, Q=-999 to -1, 1 to 999

PLZ Synchronous axis using G28 command
 0: Returns to the reference position in the same sequence as the manual reference position return.
 1: Returns to the reference position by positioning at a rapid traverse.
 The synchronous axis returns to the reference position in the same sequence as the manual reference position return when no return-to-reference position is performed after the power is turned on.

7603	#7	#6	#5	#4	#3	#2	#1	#0
					PLR	SBR		

[Data type] Bit

SBR For spindle synchronization, speed ratio control is:
 0 : Disabled.
 1 : Enabled.

NOTE

- 1 This parameter is used to set the slave spindle speed to a multiple of the master spindle speed when the spindle synchronization function is used.
- 2 This parameter is not related to the polygon turning function.
- 3 The spindle synchronization option is needed.
- 4 Parameter Nos. 7635 and 7636 also need be set up.

PLR The machine coordinates of a tool axis for polygon turning are:
 0 : Rounded by the setting in parameter 7620.
 1 : Rounded by 360° (or the setting in parameter No. 1260 when bit 0 (ROA) of parameter No. 1008 is set to 1).

7610	Control axis number of tool rotation axis for polygon turning

[Data type] Byte
 [Valid data range] 1, 2, 3, . . . number of control axes
 This parameter sets the control axis number of a rotation tool axis used for polygon turning.

7620	Movement of tool rotation axis per revolution

[Data type] 2-word

Input increment	IS-A	IS-B	IS-C	Unit
Rotation axis	0.01	0.001	0.0001	deg

[Valid data range] 1 to 9999999
 This parameter sets the movement of a tool rotation axis per revolution.

7621	Maximum allowable speed for the tool rotation axis (polygon synchronization axis)

[Data type] Word
 [Unit of data] min^{-1}
 [Valid data range] 0 to 1.2×10^8 / Set value of the parameter No.7620
 This parameter sets the maximum allowable speed of the tool rotation axis (polygon synchronization axis).
 If the speed of the tool rotation axis (polygon synchronization axis) exceeds the specified maximum allowable speed during polygon turning, the speed is clamped at the maximum allowable speed. When the speed is clamped at a maximum allowable speed, however, synchronization between the spindle and tool rotation axis (polygon synchronization axis) is lost. And, when the speed is clamped, P/S alarm No.5018 is issued.

7635	Multiplier influencing the slave spindle speed

[Data type] Byte
 [Unit of data] Slave spindle (min^{-1})/master spindle (min^{-1})
 [Valid data range] 1 to 9
 Set up a multiplier that will act on the distance through which the slave spindle is to move.
 In speed ratio control, the relationship between the speeds of the spindles is:

$$\text{Slave spindle speed} = \text{master spindle speed} \times \begin{matrix} \text{setting of parameter} \\ \text{No. 7635} \end{matrix}$$

NOTE

- 1 This parameter is used to set the slave spindle speed to a multiple of the master spindle speed when the spindle synchronization function is used.
- 2 This parameter is not related to the polygon turning function.
- 3 The spindle synchronization control is needed.
- 4 Bit 2 (SBR) of parameter No. 7603 and parameter No. 7636 must be set as well.

7636

Upper limit of the slave spindle speed

[Data type]
[Unit of data]
[Valid data range]

Word

min⁻¹

1 to 19999

Specify a clamp speed for the slave spindle. If the slave spindle speed calculated from the master spindle speed exceeds the specified slave spindle clamp speed, the actual slave spindle speed is clamped at this clamp speed. At the same time, the master spindle speed is decreased to maintain a constant spindle rotation ratio.

NOTE

- 1 This parameter is used to set the slave spindle speed to a multiple of the master spindle speed when the spindle synchronization function is used.
- 2 This parameter is not related to the polygon turning function.
- 3 The spindle synchronization control is needed.
- 4 Bit 2 (SBR) of parameter No. 7603 and parameter No. 7635 must be set as well.

4.44 PARAMETERS OF GENERAL-PURPOSE RETRACTION

	#7	#6	#5	#4	#3	#2	#1	#0
7704								
								ACR

[Data type] Bit
 ACR In advanced preview control, AI advanced preview control, or AI contour control mode, the general-purpose retraction function is:
 0 : Not used.
 1 : Used.
 (See the description of parameter No. 7745.)

	#7	#6	#5	#4	#3	#2	#1	#0
7730								
								RTRx

[Data type] Bit axis
 RTRx Retraction function is:
 0 : Disabled for each axis.
 1 : Enabled for each axis.

7740	Feedrate during retraction for each axis
------	---

[Data type] 2-word axis
 [Unit of data, valid data range]

Increment system	Units of data	Valid data range	
		IS-B	IS-C
Millimeter machine	1 mm/min	30 to 240000	6 to 100000
Inch machine	0.1 inch/min	30 to 96000	6 to 48000

This parameter sets the feedrate during retraction for each axis.

7741	Retracted distance for each axis
------	---

[Data type] 2-word axis

Increment system	Unit of data	
	IS-B	IS-C
Millimeter input	0.001 mm	0.0001 mm
Inch input	0.0001 inch	0.00001 inch

[Valid range] -99999999 to 99999999
 This parameter sets the retracted distance for each axis.

7745	Time constant of linear acceleration/deceleration during retraction
------	--

[Data type] Word axis
 [Unit of data] msec
 [Valid range] 0 to 4000

This parameter is used to set the acceleration rate of linear acceleration/deceleration performed during retraction by the general-purpose retraction function. For each axis, set a time (time constant) required to achieve the feedrate set in parameter No. 7740.

NOTE
 This parameter is valid when bit 0 (ACR) of parameter No. 7704 is set to 1.

4.45 PARAMETERS OF AXIS CONTROL BY PMC

	#7	#6	#5	#4	#3	#2	#1	#0
8001	SKE	AUX	NCC		RDE	OVE		MLE

[Data type] Bit
 MLE Whether all axis machine lock signal MLK <G044#1> is valid for PMC-controlled axes
 0 : Valid
 1 : Invalid

NOTE

Each-axis machine lock signals MLK1 to MLK8 <G108#0 to #7> are always valid, regardless of the setting of this parameter.

OVE Signals related to dry run and override used in PMC axis control
 0: Same signals as those used for the CNC
 (1) Feedrate override signals *FV0 to *FV7 <G012#0 to #7>
 (2) Override cancellation signal OVC <G006#4>
 (3) Rapid traverse override signals ROV1 and ROV2 <G014#0,#1>
 (4) Dry run signal DRN <G046#7>
 (5) Rapid traverse selection signal RT <G019#7>
 1: Signals specific to the PMC
 (1) Feedrate override signals *FV0E to *FV7E <G151#0 to #7>
 (2) Override cancellation signal OVCE <G150#5>
 (3) Rapid traverse override signals ROV1E and ROV2E <G150#0,#1>
 (4) Dry run signal DRNE <G150#7>
 (5) Rapid traverse selection signal RTE <G150#6>

RDE Whether dry run is valid for rapid traverse in PMC axis control
 0 : Invalid
 1 : Valid

NCC When a travel command is issued for a PMC-controlled axis (selected by a controlled-axis selection signal) according to the program:
 0 : P/S alarm 139 is issued while the PMC controls the axis with an axis control command. While the PMC does not control the axis, a CNC command is enabled.
 1 : P/S alarm 139 is issued unconditionally.

AUX The number of bytes for the code of an auxiliary function (12H) command to be output is
 0 : 1 (0 to 255)
 1 : 2 (0 to 65535)

SKE Skip signal during axis control by the PMC
 0 : Uses the same signal SKIP <X004#7> as CNC.
 1 : Uses dedicated axis control signal ESKIP <X004#6> used by the PMC.

	#7	#6	#5	#4	#3	#2	#1	#0
8002	FR2	FR1	PF2	PF1	F10	SUE	DWE	RPD

- [Data type] Bit
- RPD Rapid traverse rate for PMC-controlled axes
 0 : Feedrate specified with parameter No.1420
 1 : Feedrate specified with the feedrate data in an axis control command
- DWE Minimum time which can be specified in a dwell command in PMC axis control when the increment system is IS-C
 0 : 1 ms
 1 : 0.1 ms
- SUE Whether acceleration/deceleration is performed for an axis that is synchronized with external pulses, for external pulse synchronization commands in PMC axis control
 0 : Performed (exponential acceleration/deceleration)
 1 : Not performed
- F10 Least increment for the feedrate for cutting feed (per minute) in PMC axis control

F10	Millimeter input	Inch input
0	1 mm/min	0.01 inch/min
1	10 mm/min	0.1 inch/min

PF1, PF2 Set the feedrate unit of feed per minute in PMC axis control

PF2	PF1	Feedrate unit
0	0	1/1
0	1	1/10
1	0	1/100
1	1	1/1000

FR1, FR2 Set the feedrate unit for feed per rotation for an axis controlled by the PMC.

FR2	FR1	Millimeter input	Inch input
0	0	0.0001 mm/rev	0.000001 inch/rev
1	1		
0	1	0.001 mm/rev	0.00001 inch/rev
1	1	0.01 mm/rev	0.0001 inch/rev

	#7	#6	#5	#4	#3	#2	#1	#0
8003							PAX	PIM

NOTE
 When this parameter is set, the power must be turned off before operation is continued.

- [Data type] Bit
- PIM Specifies whether to cause an inch/metric input to affect the linear axis that is subjected only to PMC axis control (see the parameter No.1010), as follows:
 0: To affect.
 1: Not to affect.

- PAX When the number of CNC-controlled axes (parameter No. 1010) is set to 0:
 0 : All axes are assumed to be CNC axes.
 1 : All axes are assumed to be PMC axes.

	#7	#6	#5	#4	#3	#2	#1	#0
8004	NDI	NCI	DSL				NMT	CMV
	NDI	NCI	DSL	G8R	G8C		NMT	CMV

- [Data type] Bit
- CMV When a move command and auxiliary function are specified from the CNC, and the system is awaiting the auxiliary function completion signal after completion of the specified axis movement:
 0 : An alarm (No.130) is issued when an axis control command is issued from the PMC for the same axis.
 1 : An axis control command, when issued from the PMC for the same axis, is executed.
- NMT When a command is specified from the CNC for the axis on which the tool is moving according to axis control specification from the PMC:
 0 : P/S alarm No.130 is issued.
 1 : The command is executed without issuing an alarm, provided the command does not involve a movement on the axis.
- G8C Advanced preview control for the axes controlled by the PMC is:
 0 : Disabled.
 1 : Enabled.

NOTE

This parameter is valid for an axis for which bit 7 (NAHx) of parameter No.1819 is set to 0.

- G8R Advanced preview control over axes controlled by the PMC is:
 0 : Enabled for cutting feed (disabled for rapid traverse).
 1 : Enabled for both cutting feed and rapid traverse.

NOTE

This parameter is valid for an axis for which bit 7 (NAHx) of parameter No.1819 is set to 0.

- DSL If the selection of an axis is changed when PMC axis selection is disabled:
 0 : P/S alarm No.139 is issued.
 1 : The change is valid, and no alarm is issued for an unspecified system.
- NCI In axis control by the PMC, a position check at the time of deceleration is:
 0 : Performed.
 1 : Not performed.
- NDI For PMC axis control, when diameter programming is specified for a PMC-controlled axis:
 0 : The amount of travel and feedrate are each specified with a radius.

1: The amount of travel and feedrate are each specified with a diameter.

NOTE
 NDI is valid for an axis for which diameter programming is specified (bit 3 (DIAx) of parameter No. 1006 is set to 1) when bit 1 (CDI) of parameter No. 8005 is set to 0.

	#7	#6	#5	#4	#3	#2	#1	#0
8005	MFD		IFV	PVP	DRR	R10	CDI	EDC

- [Data type] Bit
- EDC In PMC-based axis control, an external deceleration signal is:
 0: Disabled.
 1: Enabled.
- CDI For PMC axis control, when diameter programming is specified for a PMC-controlled axis:
 0: The amount of travel and feedrate are each specified with a radius.
 1: The amount of travel is specified with a diameter while the feedrate is specified with a radius.

NOTE
 1 This parameter is valid when bit 3 (DIA) of parameter No.1006 is set to 1.
 2 When CDI is set to 1, bit 7 (NDI) of parameter No.8004 is disabled.

- R10 When the RPD parameter (bit 0 of parameter No.8002) is set to 1, the unit for specifying a rapid traverse rate for the PMC axis is:
 0: 1 mm/min.
 1: 10 mm/min.
- DRR For cutting feed per rotation in PMC axis control, the dry run function is:
 0: Disabled.
 1: Enabled.
- PVP For velocity command in PMC axis control, position control is:
 0: Not performed.
 1: Performed.
- IFV Override for each group in PMC axis control is:
 0: Disabled.
 1: Enabled.
- MFD Output by each auxiliary function of the PMC axis control function is:
 0: Disabled.
 1: Enabled.

	#7	#6	#5	#4	#3	#2	#1	#0
8006	EAL	EZR	ESI			IPA	EML	

- [Data type] Bit
- EML When bit 0 (MLE) of parameter No. 8001 is set to 1, for PMC axes:
 0 : The all axis machine lock signal and axis-by-axis machine lock signals are disabled.
 1 : The all axis machine lock signal is disabled and the axis-by-axis machine lock signals are enabled.
 - IPA For controlled axis at PMC axis control only (see the parameter No.1010) :
 0 : The in-position check is performed when no move command is issued for the PMC axis.
 1 : No in-position check is always performed.
 - EZR For PMC axes, the setting of bit 0 (ZRN) of parameter No. 1005 is:
 0 : Not followed. (Constant checking of the reference position return status is not made.)
 1 : Followed. (The reference position return status is checked according to the setting of bit 0 (ZRN) of parameter No. 1005.)
 - EAL In axis control by the PMC, the function that allows the alarm signal (EIALg) to be reset by a CNC reset operation is:
 0 : Disabled.
 1 : Enabled.

	#7	#6	#5	#4	#3	#2	#1	#0
8007								NIS

- [Data type] Bit
- NIS In the in-position check of PMC axes, in-position check disable signal NOINPS <G023#5> and in-position check disable signals for individual axes NOINP1 to NOINP8 <G359> are:
 0 : Invalid.
 1 : Valid.

NOTE

Although in-position checks of ordinary blocks can be disabled by using in-position check disable signal NOINPS <G023#5> and in-position check disable signals for individual axes NOINP1 to NOINP8 <G359>, the in-position check at the reference position obtained by a reference position return operation (G28 or G30) is always performed. The in-position check at an intermediate point, however, can be disabled. To disable the in-position check at the reference position as well, set bit 0 (RF2) of parameter No. 3454 to 1, and specify a reference position return by using G28.2 or G30.2.

	#7	#6	#5	#4	#3	#2	#1	#0
8008								MIRx

- [Data type] Bit axis

MIRx When a PMC axis control command is issued in mirror image mode, the mirror image is:
 0 : Not considered.
 1 : Considered.
 This parameter is valid when PMC signals MI1 to MI4 <G106#0-3> are set to "1" or bit 0 (MIRx) of parameter No. 0012 is set to "1".

8010

Selection of the DI/DO group for each axis controlled by the PMC

[Data type]
 [Valid data range]

Byte axis

1 to 4

Specify the DI/DO group to be used to specify a command for each PMC-controlled axis.

Value	Description
1	DI/DO group A (G142 to G153) is used.
2	DI/DO group B (G154 to G165) is used.
3	DI/DO group C (G166 to G177) is used.
4	DI/DO group D (G178 to G189) is used.

8020

Low-speed feedrate at reference position return in axis control by PMC (FL)

[Data type]
 [Unit of data, valid data range]

Word axis

Increment system	Units of data	Valid data range	
		IS-B	IS-C
Millimeter machine	1 mm/min	6 to 15000	6 to 12000
Inch machine	0.1 inch/min	6 to 6000	6 to 4800
Rotation axis	1 deg/min	6 to 15000	6 to 12000

This parameter specifies the low-speed feedrate at a reference position return on a PMC-controlled axis (FL).

NOTE

If 0 is specified, the value of parameter No. 1425 is used.

8021

Minimum speed of rapid traverse override in axis control by PMC (Fo)

[Data type]

Word axis

[Unit of data, valid data range]

Increment system	Units of data	Valid data range	
		IS-B	IS-C
Millimeter machine	1 mm/min	6 to 15000	6 to 12000
Inch machine	0.1 inch/min	6 to 6000	6 to 4800
Rotation axis	1 deg/min	6 to 15000	6 to 12000

This parameter specifies the minimum speed of rapid traverse override on a PMC-controlled axis (Fo).

8022

Upper-limit rate of feed per revolution during PMC axis control

[Data type]

Word

[Unit of data, valid data range]

Increment system	Units of data	Valid data range	
		IS-B	IS-C
Millimeter machine	1 mm/min	6 to 15000	6 to 12000
Inch machine	0.1 inch/min	6 to 6000	6 to 4800
Rotation axis	1 deg/min	6 to 15000	6 to 12000

This parameter sets the upper limit rate of feed per revolution during PMC axis control.

NOTE

The upper limit specified for the first axis is valid for all axes. The specifications for the second and subsequent axes are ignored.

8028

Linear acceleration/deceleration time constant for speed commands for PMC axis control

[Data type]

Word axis

[Unit of data]

ms/1000 min⁻¹

[Valid data range]

0 to 32767

This parameter sets the time required for the servo motor rotation speed to increase or decrease by 1000 min⁻¹, for each axis, as a linear acceleration/deceleration time constant for speed commands for PMC axis control. (See also the description of bit 6 (JVB) of parameter No. 8003.)

NOTE

If this parameter is set to 0, acceleration/deceleration control is not applied.

4.46 PARAMETERS OF FS0i BASIC FUNCTIONS

8130	Total number of controlled axes
------	---------------------------------

NOTE
When this parameter has been set, the power must be turned off before operation is continued.

[Data type] Byte
 [Valid data range] 2 to 4
 This parameter sets the total number of axes controlled by the CNC.

8131	#7	#6	#5	#4	#3	#2	#1	#0
					AOV	EDC	F1D	HPG

NOTE
When this parameter has been set, the power must be turned off before operation is continued.

[Data type] Bit

HPG Manual handle feed is:
 0 : Not Used.
 1 : Used.

F1D One-digit F code feed is:
 0 : Not Used.
 1 : Used.

EDC External deceleration is:
 0 : Not Used.
 1 : Used.

AOV Automatic corner override is:
 0 : Not Used.
 1 : Used.

8132	#7	#6	#5	#4	#3	#2	#1	#0
			SCL	SPK	IXC	BCD	YOF	TLF

NOTE
When this parameter has been set, the power must be turned off before operation is continued.

[Data type] Bit

TFL Tool life management is:
 0 : Not Used.
 1 : Used.

NOTE
 When TLF is changed, the data listed below is erased.
 Therefore, before changing TLF, save the following data:
 - Additional custom macro common variable data
 - Tool offset data
 - Tool life management data
 - Additional workpiece coordinate system data
 (0i-MC / 0i Mate-MC only)

- YOF Y-axis offset is:
 0 : Not Used.
 1 : Used.
- BCD Second auxiliary function is:
 0 : Not Used.
 1 : Used.
- IXC Index table indexing is:
 0 : Not Used.
 1 : Used.
- SPK Small diameter peck drilling cycle is:
 0 : Not Used.
 1 : Used.
- SCL Scaling is:
 0 : Not Used.
 1 : Used.

	#7	#6	#5	#4	#3	#2	#1	#0
8133			SSN	SYC	MSP	SCS	AXC	SSC
			SSN	SYC		SCS		SSC

NOTE
 1 When this parameter has been set, the power must be turned off before operation is continued.
 2 A small diameter peck drilling cycle and scaling cannot be used at the same time.

- [Data type] Bit
- SSC Constant surface speed control is:
 0 : Not Used.
 1 : Used.
- AXC Spindle positioning is:
 0 : Not Used.
 1 : Used.
- SCS Cs cotour control is:
 0 : Not Used.
 1 : Used.
- MSP Multi-spindle is:
 0 : Not Used.
 1 : Used.

- SYC Spindle synchronization is:
 0 : Not Used.
 1 : Used.
- SSN Serial spindle function is:
 0: Used. (The analog spindle function is not used.)
 1: Not Used. (The analog spindle function is used.)

NOTE
 Spindle positioning and Cs contour control by the serial spindle cannot be used at the same time.

8134	#7	#6	#5	#4	#3	#2	#1	#0
						CCR	BAR	IAP
								IAP

NOTE
 When this parameter has been set, the power must be turned off before operation is continued.

- [Data type] Bit
- IAP Conversational programming with graphic function is:
 0 : Not Used.
 1 : Used.
 - BAR Chuck and tail stock barrier function is:
 0 : Not Used.
 1 : Used.
 - CCR Chamfering / corner R is:
 0 : Not Used.
 1 : Used.

NOTE
 When the chuck and tail stock barrier function is selected, stored stroke limits 2 and 3 cannot be used.

4.47 PARAMETERS OF ANGULAR AXIS CONTROL

	#7	#6	#5	#4	#3	#2	#1	#0
8200					AZP	AZR		AAC

NOTE
When this parameter is set, the power must be turned off before operation is continued.

- [Data type] Bit
- AAC
0 : Does not perform angular axis control.
1 : Performs inclined axis control.
- AZR
0 : The machine tool is moved along the Cartesian axis during manual reference position return along the slanted axis under angular axis control.
1 : The machine tool is not moved along the Cartesian axis during manual reference position return along the slanted axis under angular axis control.
- AZP When an angular axis moves, the reference position return completion signal for the Cartesian axis, ZPx <F094, F096, F098, or F100>, is:
0 : Not cleared.
1 : Cleared.

	#7	#6	#5	#4	#3	#2	#1	#0
8201	ADG	A53	ACL	ALN		AO3	AO2	AOT
	ADG	A53	ACL	ALN			AO2	AOT

- [Data type] Bit
- AOT When angular axis control is enabled, the values indicating the area for stored stroke check 1 (parameters Nos. 1320, 1321, 1326, and 1327) are treated as:
0 : Coordinates in the angular coordinate system.
1 : Coordinates in the Cartesian coordinate system.
- AO2 When angular axis control is enabled, the values indicating the area for stored stroke check 2 (parameters Nos. 1322 and 1323) are treated as:
0 : Coordinates in the angular coordinate system.
1 : Coordinates in the Cartesian coordinate system.
- AO3 When angular axis control is enabled, the values indicating the area for stored stroke check 3 (parameters Nos. 1324 and 1325) are treated as:
0 : Coordinates in the angular coordinate system.
1 : Coordinates in the Cartesian coordinate system.

- ALN When manual rapid traverse or reference position return without dogs is performed for an angular axis during angular axis control:
 0 : The acceleration/deceleration time for a Cartesian axis is not controlled.
 1 : The acceleration/deceleration time for a Cartesian axis is controlled so that it matches the acceleration/deceleration time for the angular axis. (A linear path is formed by the angular axis and Cartesian axis.)
- ACL In linear interpolation type rapid traverse, the feedrate clamp function for angular axis control is:
 0 : Enabled.
 1 : Disabled.

NOTE
 This parameter is valid when bit 1 (LRP) of parameter No. 1401 is set to 1.

- A53 During angular axis control, when a machine coordinate system command (G53) specifies an angular axis alone:
 0 : A movement along a Cartesian axis is also made.
 1 : A movement is made along the angular axis only.
- ADG The contents of diagnostic data Nos. 306 and 307 are:
 0 : Not swapped. The angular axis and Cartesian axis are displayed in this order.
 1 : Swapped. The Cartesian axis and angular axis are displayed in this order.

8210

Inclination angle for angular axis control

[Data type] 2-word
 [Unit of data] 0.001 degree
 [Valid data range] 20000 to 60000

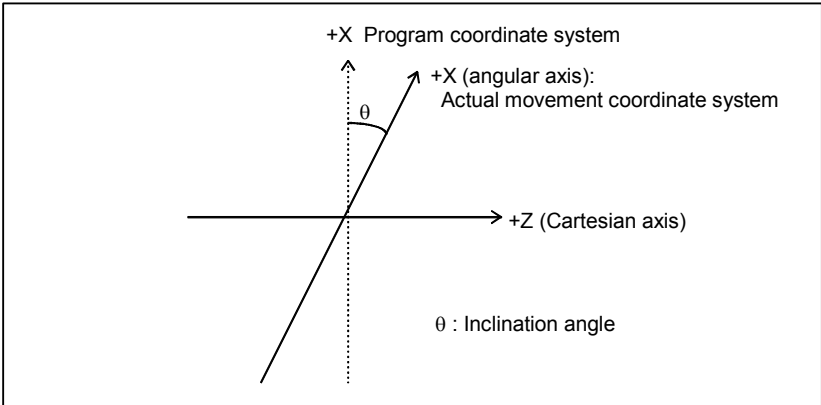

8211	Axis number of a slanted axis subject to angular axis control
8212	Axis number of a Cartesian axis subject to slanted axis control

[Data type] Byte
 [Unit of data] Axis number
 [Valid data range] 1 to number of controlled axes
 When angular axis control is to be applied to an arbitrary axis, these parameters set the axis numbers of a slanted axis and Cartesian axis.

4.48 PARAMETERS OF SIMPLE SYNCHRONOUS CONTROL

	#7	#6	#5	#4	#3	#2	#1	#0
8301								
	SOF		SYE	SYA				

- [Data type] Bit
- SYA In the servo-off state in simple synchronous control, the limit of the difference between the positioning deviation of the master axis and that of the slave axis is:
 0 : Checked.
 1 : Not checked.
- SYE During execution of synchronization, the limit of the difference between positioning deviations (parameter No. 8313 or 8323) is:
 0 : Checked.
 1 : Not checked.
- SOF The synchronization function in simple synchronous control (one pair) is:
 0 : Not used.
 1 : Used.

	#7	#6	#5	#4	#3	#2	#1	#0
8302								
	SMA				SSE		ATS	ATE

NOTE
 When this parameter is set, the power must be turned off before operation is continued.

- [Data type] Bit
- ATE Automatic setting of grid positioning for simplified synchronous control one pair is:
 0 : Disabled
 1 : Enabled
- ATS Automatic setting of grid positioning for simplified synchronous control one pair is:
 0 : Not started
 1 : Started

NOTE

- 1 When the bits are set to 1, parameter No.8316 and bit 4 (APZx) of parameter No.1815 for the master and slave axes are set to 0.
- 2 These bits are automatically set to 0 once grid positioning has been completed.

- SSE In simple synchronization control, the external machine coordinate system shift function for the slave axis is:
 0 : Not used.

1 : Used.

For axes under simple synchronization control, when the external machine coordinate system shift is performed for the master axis, it can also performed for the slave axis simultaneously.

NOTE
 The simple synchronous signal must be manipulated.
 Carefully turn the simple synchronous signal on and off because the machine may move at that time.

SMA When bit 4x (APZx) of parameter No. 1815 is turned off for one axis under simple synchronous control, APZx for the other axis under simple synchronous control is:

0 : Not turned off.
 1 : Turned off.

When an axis for which the simple synchronous axis parameter is set is under simple synchronous control, the simple synchronous signal is turned on for the axis.

	#7	#6	#5	#4	#3	#2	#1	#0
8303								
	SOFx						ATSx	ATEx

NOTE
 After this parameter has been set, the power must be turned off then on again for the setting to become effective.

[Data type] Bit axis
 ATEx In simple synchronous control, automatic setting for grid positioning is:

0 : Disabled.
 1 : Enabled.

ATSx In simple synchronous control, automatic setting for grid positioning is:

0 : Not started.
 1 : Started.

NOTE
 When starting automatic setting for grid positioning, set ATSx to 1. Upon the completion of setting, ATSx is automatically set to 0.

SOFx In simple synchronous control, the synchronization function is:

0 : Not used.
 1 : Used.

NOTE
Set this parameter on the master axis side.

8304	#7	#6	#5	#4	#3	#2	#1	#0
								USD

[Data type] Bit axis
 USD In simple synchronous control, the uni-directional synchronization function uses:
 0 : Axis of which machine coordinate is larger as the reference.
 1 : Axis of which machine coordinate is smaller as the reference.

NOTE
Set this parameter (USD) to the same value for both the master and slave axes.

8305	#7	#6	#5	#4	#3	#2	#1	#0
							USE	USC

[Data type] Bit
 USC In simple synchronous control, the uni-directional synchronization function is:
 0 : Not used.
 1 : Used.

NOTE
This parameter is valid only when bit 7 (SOF) of parameter No. 8301 or bit 7 (SOFx) of parameter No. 8303 is set to 1.

USE In simple synchronous control, after emergency stop, the uni-directional synchronization function is:
 0 : Used.
 1 : Not used.

NOTE
This parameter is valid only when bit 7 (SOF) of parameter No. 8301 or bit 7 (SOFx) of parameter No. 8303 is set to 1.

8311	Axis number of master axis in synchronous control
------	---

NOTE
When this parameter is set, the power must be turned off before operation is continued.

[Data type] Byte axis

<For the T series>

[Valid data range] 0 to (Number of controlled axes - 1)
 Select a master axis and slave axis in simple synchronous control. Set a master axis number with a slave axis. For the parameters for the first axis through the fourth axis of parameter No.8311, set the following:
 Units digit of the parameter for the first axis →
 Set the axis number of the master axis when the first axis is used as the slave axis.
 Tens digit of the parameter for the first axis →
 Set the axis number of the master axis when the second axis is used as the slave axis.
 Units digit of the parameter for the second axis →
 Set the axis number of the master axis when the third axis is used as the slave axis.
 Tens digit of the parameter for the second axis →
 Set the axis number of the master axis when the fourth axis is used as the slave axis.
 Units digit of the parameter for the third axis →
 Always set to 0.
 Tens digit of the parameter for the third axis →
 Always set to 0.
 Units digit of the parameter for the fourth axis →
 Always set to 0.
 Tens digit of the parameter for the fourth axis →
 Always set to 0.

Number	Tens digit	Units digit
No.8311 : First axis	Second axis	First axis
No.8311 : Second axis	Fourth axis	Third axis

Note that the axis number settings are as follows:
 0 -> First axis, 1 -> Second axis, 2 -> Third axis, 3 -> Fourth axis

Example:

To use the third axis as the master axis and the fourth axis as the slave axis, set the axis number (setting of 2) of the third axis (master axis) in the tens digit for the second axis in the fourth axis (slave axis) parameter, that is, parameter No. 8311.

No. 8311	First: 00
	Second: 20
	Third: 00
	Fourth: 00

NOTE
 For an axis for which 0 is set, the first axis serves as the master axis. So, when the control signal for the axis is set to 1, the first axis serves as a master axis, and synchronous control is exercised.

<For the M series>

[Valid data range]

0, 1 to Number of controlled axes

Select a master axis and slave axis in simple synchronous control. Set a master axis number with the slave axis side. The axis number settings are: 1 → First axis, 2 → Second axis, 3 → Third axis, 4 → Fourth axis. Up to four pairs can be specified.

Example1:

Simple synchronous control is exercised with one pair.

When using the first axis (X-axis) as the master axis, and the third axis (Z-axis) as the slave axis, set parameter No.8311 as follows:

Parameter No. 8311	X (first axis)	= 0
	Y (second axis)	= 0
	Z (third axis)	= 1
	A (fourth axis)	= 0

Example2:

Simple synchronous control is exercised with two pairs.

Assume that the following two pairs are to be used:

The master axis is the first axis, while a slave axis is the fourth axis.

The master axis is the second axis, while a slave axis is the third axis.

For this specification, set this parameter as follows:

Parameter No.8311	X (First axis)	= 0
	Y (Second axis)	= 0
	Z (Third axis)	= 2
	(Fourth axis)	= 1

NOTE
 The axis number of a master axis must always be smaller than the corresponding slave axis number. Multiple slave axes cannot be assigned to a master axis.

8312

Enabling/disabling mirror image in synchronous control

[Data type]
 [Valid data range]

Byte axis
 -127 to +128

This parameter sets the mirror image function. When 100 or a greater value is set with this parameter, the mirror image function is applied to synchronous control. Set this parameter to the slave axis.

[Example]

To establish reversed synchronization when using the third axis as the master axis and the fourth axis as the slave axis, set parameter

No.8311 and parameter No.8312 as follows:

- Parameter No.8311 (first axis) = 0
- Parameter No.8311 (second axis) = 20
- Parameter No.8311 (third axis) = 0
- Parameter No.8311 (fourth axis) = 0
- Parameter No.8312 (first axis) = 0
- Parameter No.8312 (second axis) = 0
- Parameter No.8312 (third axis) = 0
- Parameter No.8312 (fourth axis) = 100

8313	Limit of the difference between the amount of positioning deviation of the master and slave axes (Synchronous control one pair)
-------------	--

[Data type] Word
 [Unit of data] Detection unit
 [Valid data range] 0 to 32767
 Set the limit of the difference between the amount of positioning deviation of the master and slave axes. If the difference between them exceeds the limit assigned to the parameter, the P/S alarm (No.213) is activated.

8314	Maximum error in synchronization error check
-------------	---

[Data type] Word axis
 [Unit of data]

Input increment	IS-A	IS-B	IS-C	Unit
Millimeter machine	0.01	0.001	0.0001	mm
Inch machine	0.001	0.0001	0.00001	inch
Rotation axis	0.01	0.001	0.0001	deg

[Valid data range] 0 to 32767
 The machine coordinates on a master axis and slave axis are monitored. If a difference (synchronization error) which is greater than the value specified in this parameter is detected, a servo alarm (No.407) is generated, and the machine is stopped.
 Set this parameter with a master axis. When 0 is set in this parameter, no synchronization error check is made.

8315	Maximum compensation value for synchronization (Synchronous control one pair)
-------------	--

[Data type] Word axis
 [Unit of data] Unit used for the detection
 [Valid data range] 0 to 32767
 This parameter sets the maximum compensation value for synchronization. When a compensation value greater than the value set in this parameter is used, servo alarm No.410 of slave axis is issued.

8316	Difference between reference counters for master and slave axes (Synchronous control one pair)
-------------	---

NOTE
 When this parameter is set, the power must be turned off before operation is continued.

[Data type] 2-word
 [Data unit] Detection unit
 [Valid data range] -99999999 to 99999999
 This parameter indicates the difference between the values in the reference counter for the master axis and that for the slave axis.

NOTE
 Once grid positioning has been completed, the difference between the reference counters is automatically set in this parameter. At this time, bit 1 (ATS) of parameter No.8302 is set to 0.

8317	Torque difference alarm detection time (Synchronous control one pair)
-------------	--

[Data type] Word
 [Data unit] ms
 [Valid data range] 0 to 4000 (When 0 is set, 512 ms is assumed.)
 This parameter specifies the period between the servo preparation completion signal (SA <F000 bit 6>) being set to 1 and the check of the torque difference alarm being started, for the torque difference alarm detection function.
 The set value is rounded up to the nearest a multiple of 16 ms.
 [Example]
 When 100 is specified, 112 ms is assumed.

8318	Detection timer for the limit of the difference between the positioning deviation of the master axis and that of the slave axis
-------------	--

[Data type] Word
 [Unit of data] 8m
 [Valid data range] 0 to 1000

This parameter sets the time from the output of a compensation pulse to the slave axis to the start of the check of the limit of the difference between the positioning deviation of the master axis and that of the slave axis by the synchronization function. The setting is also used for the check of an excessive error at stop.

NOTE

If a value greater than 1000 is set, a value of 1000 is assumed.

8323	Maximum allowable difference between master axis and slave axis positional deviations
-------------	--

[Data type] Word axis
 [Unit of data] Detection unit
 [Valid data range] 0 to 32767

This parameter sets the maximum allowable difference between the master axis and slave axis position deviations. If a positional deviation difference exceeds the value specified in this parameter, an alarm (No.213) is issued.

Set this parameter with a master axis. If 0 is specified in this parameter, no position deviation difference check is made.

8325	Maximum compensation value for synchronization
-------------	---

[Data type] Word axis
 [Unit of data] Detection unit
 [Valid data range] 0 to 32767

This parameter sets the maximum compensation value for synchronization. If a compensation value exceeds the value specified with this parameter, a servo alarm (No.407) is issued.

Specify a master axis for this parameter. To enable this parameter, set the SOFx parameter (bit 7 of parameter No.8303) to 1.

8326	Difference between master axis and slave axis reference counters
-------------	---

<p>[Data type]</p> <p>[Unit of data]</p> <p>[Valid data range]</p>	<p>2-word axis</p> <p>Detection unit</p> <p>-99999999 to 99999999</p> <p>The difference between the master axis reference counter and slave axis reference counter (master axis and slave axis grid shift) is automatically set when automatic setting for grid positioning is performed. Then, the difference is transferred together with an ordinary grid shift value to the servo system when the power is turned on.</p> <p>This parameter is set with a master axis.</p>
--	--

8327	Torque difference alarm detection timer
-------------	--

<p>[Data type]</p> <p>[Unit of data]</p> <p>[Valid data range]</p>	<p>Word axis</p> <p>ms</p> <p>0 to 4000</p> <p>This parameter sets a time from the servo preparation completion signal, SA (F000#6), being set to 1 until torque difference alarm detection is started in simple synchronous control. A fraction of less than 16 msec is rounded up.</p> <p>Example:</p> <p>Setting = 100: The specification of 112 msec is assumed.</p> <p>Set this parameter with a master axis. If 0 is set in this parameter, the specification of 512 msec is assumed.</p>
--	---

4.49 PARAMETERS OF SEQUENCE NUMBER COMPARISON AND STOP

8341

Program number subject to comparison and stop

[Data type] Word
 [Valid data range] 0 to 9999

This parameter sets the program number, including a sequence number, subject to sequence number comparison and stop. Parameter No.8342 is used to set a sequence number subject to check termination.

NOTE

A program number can also be set on the setting screen. If a program number is set on the setting screen, the value of the parameter is changed accordingly.

8342

Sequence number subject to comparison and stop

[Data type] 2-word
 [Valid data range] 0 to 9999

This parameter sets the sequence number subject to sequence number comparison and stop.

If the block containing the sequence number set with this parameter is executed while the program set with parameter No.8341 is being executed, a single block stop occurs after the block is executed. At this time, the setting is automatically set to -1. Upon power-up, the setting is automatically set to 0.

NOTE

A sequence number can also be set by using the setting screen. If a sequence number is set on the setting screen, the value of the parameter is changed accordingly.

4.50 OTHER PARAMETERS

	#7	#6	#5	#4	#3	#2	#1	#0
8700					DMM			

[Data type] Bit
 DMM In DNC operation from the PMC, OPEN CNC, or C-EXE, pre-reading is:
 0 : Not performed.
 1 : Performed.

	#7	#6	#5	#4	#3	#2	#1	#0
8701						WPR		

[Data type] Bit
 WPR The function that allows parameters that are rewritten using the PMC window to be enabled during automatic operation is:
 0 : Disabled.
 1 : Enabled.

NOTE
 If this parameter is set, a move command based on manual operation is disabled (interlock state) while parameter rewriting using the PMC window is being executed.

	#7	#6	#5	#4	#3	#2	#1	#0
8702	LFM		SME					

[Data type] Bit
 SME During DNC operation or M198 call, parameter No. 8790 (timing for executing an auxiliary macro) is:
 0 : Invalid.
 1 : Valid.
 LFM At the beginning of program uploading in response to a request using the data window library:
 0 : "LF+%" is not output.
 1 : "LF+%" is output.

	#7	#6	#5	#4	#3	#2	#1	#0
8703				WSP				

[Data type] Bit
 WSP When serial spindle parameter Nos. 4000 to 4799 are rewritten with function code 18 (parameter write) of the PMC window function, the new data is:
 0 : Not transferred to the spindle amplifier immediately.
 1 : Transferred to the spindle amplifier immediately.

MOTE

- 1 When a parameter write operation with all axes specified (axis specification: -1) is performed with function code 18 of the PMC window function, this function cannot be used. (Even if the function is specified, data for all axes is not transferred to the spindle amplifier.)
- 2 When a spindle startup operation is being performed at the time of power-up and so on, or when serial spindle parameter data (parameter Nos. 4000 to 4799) is being rewritten through MDI keys, RS-232C, or programmable data input (G10), the serial spindle parameter data (parameter Nos. 4000 to 4799) must not be rewritten with the PMC window function at the same time.
- 3 When spindle orientation with the stop position set externally or incremental command type spindle orientation (both set by bit 2 (OR1) and bit 3 (OR2) of parameter No. 3702) is used, the same condition as described in NOTE 2 above applies if the status of the spindle orientation external stop position command signals (below) changes. When a change to the spindle orientation external stop position command signals and rewriting of spindle parameters (parameter Nos. 4000 to 4799) by the PMC window function are performed successively, insert a wait time of at least 50 ms between these operations.
Spindle orientation external stop position command signals
First spindle SHA00 to SHA11 <G078, G079>
Second spindle SHB00 to SHB11 <G080, G081>
- 4 When a parameter has been changed using this function, it requires 1000 ms for the new parameter data to become valid on the spindle amplifier side. To use a parameter as soon as changing it, wait for at least 1000 ms after the PMC window completion code is returned.

	#7	#6	#5	#4	#3	#2	#1	#0
8706							NWD	HSD

NOTE
When this parameter has been set, the power must be turned off before operation is continued.

[Data type] Bit
 HSD Main machining during DNC operation with FOCAS1/HSSB is:
 0 : Normal operation.
 1 : High-speed operation.
 Set this parameter according to machining during DNC operation. Usually, when binary operation and programs containing contiguous small blocks are performed during DNC operation with FOCAS1/HSSB, high-speed operation is selected.

NOTE
For details of this parameter, also refer to "FANUC Open CNC DNC Operation Management Package" and other manuals.

NWD During DNC operation with FOCAS1/HSSB, new DNC functions are:
 0 : Not executed.
 1 : Executed.
 When this parameter is set, the M198 command (subprogram call) can also be executed with FOCAS1/HSSB.

NOTE
To execute the M198 command with FOCAS1/HSSB, parameter No. 20 must be set to "15".
 For details of this parameter, also refer to "FANUC Open CNC DNC Operation Management Package" and other manuals.

8760	Program number for data registration (data input/output function using the I/O link)
------	--

[Data type] Word
 [Valid data range] 0 to 9999
 When the data input/output function using the I/O link is used, this parameter sets the program numbers of the programs to be used for registering data (parameters, macro variables, and diagnostic data) from Power Mates.
 For a Power Mate in group n, the following program numbers are used:
 For parameters: Setting + n × 10 + 0
 For macro variables: Setting + n × 10 + 1
 For diagnostic data: Setting + n × 10 + 2

Example: When 8000 is set

- 8000: Parameters of group 0 (I/O channel = 20)
- 8001: Macro variables of group 0 (I/O channel = 20)
- 8002: Diagnostic data of group 0 (I/O channel = 20)
- 8010: Parameters of group 1 (I/O channel = 21)
- 8011: Macro variables of group 1 (I/O channel = 21)
- 8012: Diagnostic data of group 1 (I/O channel = 21)
- 8020: Parameters of group 2 (I/O channel = 22)
- 8021: Macro variables of group 2 (I/O channel = 22)
- 8022: Diagnostic data of group 2 (I/O channel = 22)
- ⋮
- 8150: Parameters of group 15 (I/O channel = 35)
- 8151: Macro variables of group 15 (I/O channel = 35)
- 8152: Diagnostic data of group 15 (I/O channel = 35)

NOTE

- 1 When 0 is set, the input/output of parameters, macro variables, and diagnostic data cannot be performed, but program input/output processing is performed.
- 2 When data is input from or output to the Power Mate, setting data of I/O CHANNEL must also be set.

8790	Timing for executing an auxiliary macro
-------------	--

[Data type]
[Unit of data]

Word

This parameter sets the timing for executing a macro executor auxiliary macro while NC programs, offset data, and so forth are being read or punched out.

When as many characters as the number specified with this parameter are read or punched out, an auxiliary macro is executed once. When 0 is set in this parameter, no auxiliary macro is executed during read or punch processing.

	#7	#6	#5	#4	#3	#2	#1	#0
8801								

[Data type]

Bit
Bit parameter 1 for machine tool builder

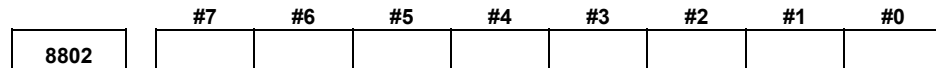

[Data type] Bit
 Bit parameter 2 for machine tool builder

NOTE
 These parameters are used only by the machine tool builder. Refer to the relevant manual supplied by the machine tool builder for details.

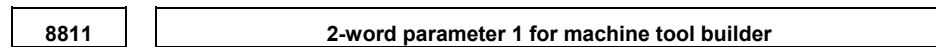

[Data type] 2-word
 -99999999 to 99999999

NOTE
 These parameters are used only by the machine tool builder. Refer to the relevant manual supplied by the machine tool builder for details.

4.51 PARAMETERS OF FAILURE DIAGNOSIS

	#7	#6	#5	#4	#3	#2	#1	#0
8850								MDG

[Data type] Bit
 MDG The failure diagnosis function is:
 0 : Enabled.
 1 : Disabled.

	#7	#6	#5	#4	#3	#2	#1	#0
8853	TS8	TS7	TS6	TS5	TS4	TS3	TS2	TS1

[Data type] Bit
 TS8 to TS1 For the thermal simulation data for each servo axis:
 0 : Failure prediction is not performed.
 1 : Failure prediction is performed. (Set a prediction level in parameter No. 8860.)

	#7	#6	#5	#4	#3	#2	#1	#0
8854	TR8	TR7	TR6	TR5	TR4	TR3	TR2	TR1

[Data type] Bit
 TR8 to TR1 For the disturbance load torque value for each servo axis:
 0 : Failure prediction is not performed.
 1 : Failure prediction is performed. (Set a prediction level in parameter No. 8861.)

8860	Failure prediction level of thermal simulation data
------	---

[Data type] Word axis
 [Unit of data] %
 [Valid data range] 0 to 100

8861	Failure prediction level of disturbance load torque
------	---

[Data type] Word axis
 [Unit of data] %
 [Valid data range] 0 to 100

4.52 PARAMETERS OF MAINTENANCE

	#7	#6	#5	#4	#3	#2	#1	#0
8901								FAN

[Data type] Bit
 FAN A fan motor error is:
 0 : Detected. (When the fan motor error is detected, an overheating alarm occurs.)
 1 : Not detected. (Use inhibited)

	#7	#6	#5	#4	#3	#2	#1	#0
8903								PRM

[Data type] Bit
 PRM A periodic maintenance expiration message is:
 0 : Not displayed.
 1 : Displayed.

8911	Ratio of the items on the periodic maintenance screen to the respective lives
-------------	--

[Data type] Byte
 [Unit of data] 1%
 [Valid data range] 0 to 100
 On the periodic maintenance screen, if the remaining time of an item falls to a value less than the percentage of the life specified in this parameter, the remaining time is displayed in red as a warning.

8940	Title character code 1
-------------	-------------------------------

8941	Title character code 2
-------------	-------------------------------

:

8949	Title character code 10
-------------	--------------------------------

[Data type] Byte
 [Valid data range] See below.
 When the CNC is turned on, up to ten characters specified in these parameters are displayed on the screen showing the series and edition of the CNC.

- The following characters can be used.
 0 to 9, A to Z, - (minus sign), . (period), and space
- The character codes to be specified are listed in the character code list in Appendix A.
- If any code other than those character codes that can be specified is specified, a space is displayed.

4.53 PARAMETERS OF SERVO SPEED CHECK

	#7	#6	#5	#4	#3	#2	#1	#0
12290							SSA	SSC

[Data type] Bit

SSC The servo speed check is:

0 : Disabled.

1 : Enabled.

SSA When the actual speed is lower than the setting of the reference speed parameter (No.12291) of the servo speed check:

0 : No alarm is issued.

1 : An alarm is issued. (Servo alarm 616)

12291	Reference speed for servo speed check
--------------	--

[Data type] Word axis

[Unit of data] min^{-1}

[Valid data range] 0 to 8000

This parameter sets the reference speed used for the servo speed check, which is conducted when bit 0 (SSC) of parameter No. 12290 is set to 1.

4.54 PARAMETERS OF MANUAL HANDLE FUNCTION

12305	Address of the X signal for first manual handle
12306	Address of the X signal for second manual handle
12307	Address of the X signal for third manual handle

[Data type] Word
 [Valid data range] 0 to 127, 200 to 327

These parameters set the address of the X signal used for each manual handle.
 These parameters are valid when bit 1 (HDX) of parameter No.7105 is set to 1.
 If the address assigned to a manual handle of an I/O module connected to the I/O Link is not set correctly, the manual handle does not function.

	#7	#6	#5	#4	#3	#2	#1	#0
12330	GR7	GR6	GR5	GR4	GR3	GR2	GR1	GR0
12331	GRF	GRE	GRD	GRC	GRB	GRA	GR9	GR8

[Data type] Bit

GR0 When group 0 (channel 1) of the PMC is a Power Mate or I/O Link β , pulses of a manual pulse generator connected via the I/O Link are:
 0 : Transferred to the target group.
 1 : Not transferred to the target group.

GR1 to GRD When group 1 (channel 1) of the PMC is a Power Mate or I/O Link β , pulses of a manual pulse generator connected via the I/O Link are:
 0 : Transferred to the target group.
 1 : Not transferred to the target group.

GRE When group 14 (channel 1) of the PMC is a Power Mate or I/O Link β , pulses of a manual pulse generator connected via the I/O Link are:
 0 : Transferred to the target group.
 1 : Not transferred to the target group.

GRF When group 15 (channel 1) of the PMC is a Power Mate or I/O Link β , pulses of a manual pulse generator connected via the I/O Link are:
 0 : Transferred to the target group.
 1 : Not transferred to the target group.

NOTE
 When a Power Mate is connected to the I/O Link, set this parameter to 1.

12350**Manual handle feed magnification m**

[Data type] Word axis
 [Unit of data] 1
 [Valid data range] 0 to 127

This parameter sets the magnification to be used for each axis when manual handle feed movement amount select signal MP1 <G019#4> is set to 0, and MP2 <G019#5> is set to 1.

If this parameter is set to 0 for a target axis for movement, the setting of parameter No. 7113 applies.

12351**Manual handle feed magnification n**

[Data type] Word axis
 [Unit of data] 1
 [Valid data range] 0 to 1000

This parameter sets the magnification to be used for each axis when manual handle feed movement amount select signal MP1 <G019#4> is set to 1, and MP2 <G019#5> is set to 1.

If this parameter is set to 0 for a target axis for movement, the setting of parameter No. 7114 applies.

Movement amount select signal		Movement amount (manual handle feed or manual handle interrupt)
MP2	MP1	
0	0	Least input increment × 1
0	1	Least input increment × 10
1	0	Least input increment × m
1	1	Least input increment × n

4.55 PARAMETERS OF ACCELERATION CONTROL

12700	Feedrate when overtravel occurs during linear acceleration/deceleration before interpolation (for stored stroke check 2)
-------	--

[Data type] Word
 [Unit of data, valid data range]

Increment system	Units of data	Valid data range	
		IS-A, IS-B	IS-C
Millimeter machine	1 mm/min	6 to 15000	6 to 12000
Inch machine	0.1 inch/min	6 to 6000	6 to 4800
Rotation axis	1 deg/min	6 to 15000	6 to 12000

When an overtravel alarm is issued during linear acceleration/deceleration before interpolation, deceleration is performed in advance so that the feedrate set in this parameter can be attained at the time of issuance of the alarm (when the limit is reached). Use of this parameter reduces the amount of overrun that occurs when the overtravel alarm is issued.

If bit 2 (DS2) of parameter No. 1604 is set to 1, set in parameter No. 12700 the feedrate to be attained when the overtravel alarm for stored stroke check 2 is issued.

NOTE
 When bit 2 (DS2) of parameter No. 1604 is set to 1, and parameter No. 12700 is set to 0, parameter No. 1784 is used.

12710	Maximum cutting feedrate for each axis in HRV3 mode
-------	---

[Data type] 2-word axis
 [Unit of data, valid data range]

Increment system	Units of data	Valid data range	
		IS-A, IS-B	IS-C
Millimeter machine	1 mm/min	0 to 240000	0 to 100000
Inch machine	0.1 inch/min	0 to 96000	0 to 48000
Rotation axis	1 deg/min	0 to 240000	0 to 100000

This parameter sets the maximum cutting feedrate applied in HRV3 mode for each axis. For a specified axis, the cutting feedrate is clamped at a maximum feedrate that does not allow the result of interpolation to exceed the maximum cutting feedrate for that axis.

NOTE

- 1 The maximum cutting feedrate for each axis is valid for linear interpolation and circular interpolation only. During polar coordinate interpolation or cylindrical interpolation, the value in parameter No. 1431, which is common to all axes, is used.
- 2 If the settings in this parameter are all 0, the maximum cutting feedrate set in parameter No. 1432 is used.

4.56 PARAMETERS OF OPERATION HISTORY

12801	Number of a signal symbol table for selecting an operation history signal (01)
12802	Number of a signal symbol table for selecting an operation history signal (02)
12803	Number of a signal symbol table for selecting an operation history signal (03)
12804	Number of a signal symbol table for selecting an operation history signal (04)
12805	Number of a signal symbol table for selecting an operation history signal (05)
12806	Number of a signal symbol table for selecting an operation history signal (06)
12807	Number of a signal symbol table for selecting an operation history signal (07)
12808	Number of a signal symbol table for selecting an operation history signal (08)
12809	Number of a signal symbol table for selecting an operation history signal (09)
12810	Number of a signal symbol table for selecting an operation history signal (10)
12811	Number of a signal symbol table for selecting an operation history signal (11)
12812	Number of a signal symbol table for selecting an operation history signal (12)
12813	Number of a signal symbol table for selecting an operation history signal (13)
12814	Number of a signal symbol table for selecting an operation history signal (14)
12815	Number of a signal symbol table for selecting an operation history signal (15)
12816	Number of a signal symbol table for selecting an operation history signal (16)
12817	Number of a signal symbol table for selecting an operation history signal (17)
12818	Number of a signal symbol table for selecting an operation history signal (18)

12819	Number of a signal symbol table for selecting an operation history signal (19)
-------	--

12820	Number of a signal symbol table for selecting an operation history signal (20)
-------	--

[Data type]
[Valid data range]

Byte

1 to 12

Set the number of a symbol table including a signal of which operation history is to be recorded for operation history channel (01) to (20) as follows:

1 : G0 to G511

3 : F0 to F511

5 : Y0 to Y127

6 : X0 to X127

10 : Y200 to Y327

10 : X200 to X327

12841	Number of a signal selected as an operation history signal (01)
-------	---

12842	Number of a signal selected as an operation history signal (02)
-------	---

12843	Number of a signal selected as an operation history signal (03)
-------	---

12844	Number of a signal selected as an operation history signal (04)
-------	---

12845	Number of a signal selected as an operation history signal (05)
-------	---

12846	Number of a signal selected as an operation history signal (06)
-------	---

12847	Number of a signal selected as an operation history signal (07)
-------	---

12848	Number of a signal selected as an operation history signal (08)
-------	---

12849	Number of a signal selected as an operation history signal (09)
-------	---

12850	Number of a signal selected as an operation history signal (10)
-------	---

12851	Number of a signal selected as an operation history signal (11)
-------	---

12852	Number of a signal selected as an operation history signal (12)
-------	---

12853	Number of a signal selected as an operation history signal (13)
-------	---

12854	Number of a signal selected as an operation history signal (14)
-------	---

12855	Number of a signal selected as an operation history signal (15)
-------	---

12856	Number of a signal selected as an operation history signal (16)
-------	---

12857	Number of a signal selected as an operation history signal (17)
12858	Number of a signal selected as an operation history signal (18)
12859	Number of a signal selected as an operation history signal (19)
12860	Number of a signal selected as an operation history signal (20)

[Data type] Word
 [Valid data range] 0 to 511
 Set the number of a signal of which operation history is to be recorded for operation history channel (01) to (20) with a value between 0 and 511.

12881	#7	#6	#5	#4	#3	#2	#1	#0
	RB7	RB6	RB5	RB4	RB3	RB2	RB1	RB0

History record bit settings for an operation history signal (01)

12882	#7	#6	#5	#4	#3	#2	#1	#0
	RB7	RB6	RB5	RB4	RB3	RB2	RB1	RB0

History record bit settings for an operation history signal (02)

12883	#7	#6	#5	#4	#3	#2	#1	#0
	RB7	RB6	RB5	RB4	RB3	RB2	RB1	RB0

History record bit settings for an operation history signal (03)

12884	#7	#6	#5	#4	#3	#2	#1	#0
	RB7	RB6	RB5	RB4	RB3	RB2	RB1	RB0

History record bit settings for an operation history signal (04)

12885	#7	#6	#5	#4	#3	#2	#1	#0
	RB7	RB6	RB5	RB4	RB3	RB2	RB1	RB0

History record bit settings for an operation history signal (05)

12886	#7	#6	#5	#4	#3	#2	#1	#0
	RB7	RB6	RB5	RB4	RB3	RB2	RB1	RB0

History record bit settings for an operation history signal (06)

	#7	#6	#5	#4	#3	#2	#1	#0
12887	RB7	RB6	RB5	RB4	RB3	RB2	RB1	RB0

History record bit settings for an operation history signal (07)

	#7	#6	#5	#4	#3	#2	#1	#0
12888	RB7	RB6	RB5	RB4	RB3	RB2	RB1	RB0

History record bit settings for an operation history signal (08)

	#7	#6	#5	#4	#3	#2	#1	#0
12889	RB7	RB6	RB5	RB4	RB3	RB2	RB1	RB0

History record bit settings for an operation history signal (09)

	#7	#6	#5	#4	#3	#2	#1	#0
12890	RB7	RB6	RB5	RB4	RB3	RB2	RB1	RB0

History record bit settings for an operation history signal (10)

	#7	#6	#5	#4	#3	#2	#1	#0
12891	RB7	RB6	RB5	RB4	RB3	RB2	RB1	RB0

History record bit settings for an operation history signal (11)

	#7	#6	#5	#4	#3	#2	#1	#0
12892	RB7	RB6	RB5	RB4	RB3	RB2	RB1	RB0

History record bit settings for an operation history signal (12)

	#7	#6	#5	#4	#3	#2	#1	#0
12893	RB7	RB6	RB5	RB4	RB3	RB2	RB1	RB0

History record bit settings for an operation history signal (13)

	#7	#6	#5	#4	#3	#2	#1	#0
12894	RB7	RB6	RB5	RB4	RB3	RB2	RB1	RB0

History record bit settings for an operation history signal (14)

	#7	#6	#5	#4	#3	#2	#1	#0
12895	RB7	RB6	RB5	RB4	RB3	RB2	RB1	RB0

History record bit settings for an operation history signal (15)

	#7	#6	#5	#4	#3	#2	#1	#0
12896	RB7	RB6	RB5	RB4	RB3	RB2	RB1	RB0

History record bit settings for an operation history signal (16)

	#7	#6	#5	#4	#3	#2	#1	#0
12897	RB7	RB6	RB5	RB4	RB3	RB2	RB1	RB0

History record bit settings for an operation history signal (17)

	#7	#6	#5	#4	#3	#2	#1	#0
12898	RB7	RB6	RB5	RB4	RB3	RB2	RB1	RB0

History record bit settings for an operation history signal (18)

	#7	#6	#5	#4	#3	#2	#1	#0
12899	RB7	RB6	RB5	RB4	RB3	RB2	RB1	RB0

History record bit settings for an operation history signal (19)

	#7	#6	#5	#4	#3	#2	#1	#0
12900	RB7	RB6	RB5	RB4	RB3	RB2	RB1	RB0

History record bit settings for an operation history signal (20)

[Data type] Bit
 RB7 to RB0 In the signals set for channels (01) to (20) (parameter Nos. 12801 to 12860), of which operation history is to be recorded, the history of each bit is:
 0 : Not recorded. (The history of this bit is not recorded.)
 1 : Recorded. (The history of this bit is recorded.)

4.57 PARAMETERS OF DISPLAY AND EDIT (2/2)

	#7	#6	#5	#4	#3	#2	#1	#0
13101	ODC	NDC						

- [Data type] Bit
- NDC The color scheme (color palette value) of VGA-compatible screens on a color LCD is:
 0 : Not changed.
 1 : Changed to FANUC standard colors 1 (new FANUC standard colors).
- ODC The color scheme (color palette value) of VGA-compatible screens on a color LCD is:
 0 : Not changed.
 1 : Changed to FANUC standard colors 2 (old FANUC standard colors).

NOTE

- 1 After bit 6 (NDC) of parameter No. 13101 is set to 1, turning the power off then back on resets the bit to 0 automatically.
- 2 After bit 7 (ODC) of parameter No. 13101 is set to 1, turning the power off then back on resets the bit to 0 automatically.
- 3 If the standard color data parameters of color scheme 1 (parameter Nos. 6561 to 6595) are all set to 0, the color scheme settings can be changed by setting parameter NDC or ODC to 1.

	#7	#6	#5	#4	#3	#2	#1	#0
13110								JPN

NOTE

When this parameter is set, the power must be turned off before operation is continued.

- [Data type] Bit
- JPN As the display language used for failure diagnosis and machine alarm diagnosis:
 0 : English has precedence.
 For machine alarm diagnosis, the GUIE_USR.MEM file has precedence.
 1 : Japanese has precedence.
 For machine alarm diagnosis, the GUIJ_USR.MEM file has precedence.

	#7	#6	#5	#4	#3	#2	#1	#0
13112						SPI	SVI	IDW

- [Data type] Bit
- IDW Editing on the servo information screen or spindle information screen is
 0 : Prohibited.
 1 : Not prohibited.
- SVI Servo information screen is
 0 : Displayed.
 1 : Not displayed.
- SPI Spindle information screen is
 0 : Displayed.
 1 : Not displayed.

13150	Number of sets of offset data displayed on the offset screen
-------	--

- [Data type] Word
- [Valid data range] 0, 1 to the maximum sets of tool offset data
 This parameter sets the number of sets of offset data to be displayed on the offset screen.

NOTE

- 1 When this parameter is set, the power must be turned off before operation is continued.
- 2 If 0 or a value beyond the data range is set in this parameter, the setting of this parameter becomes invalid, and all offset data is displayed.

4.58 PARAMETERS OF MACHINING CONDITION SELECTION

	#7	#6	#5	#4	#3	#2	#1	#0
13600								MCR

[Data type] Bit
 MCR When the permissible acceleration is adjusted with the machining condition selection function (machining parameter adjustment screen or precision level selection screen), parameter Nos. No.1730 and 1731, which are related to feedrate clamping by arc radius, are:
 0 : Changed.
 1 : Not changed.

	#7	#6	#5	#4	#3	#2	#1	#0
13601								MPR

[Data type] Bit
 MPR The machining parameter adjustment screen is:
 0 : Displayed.
 1 : Not displayed.

NOTE
 1 When this parameter has been set, the power must be turned off before operation is continued.
 2 Even when this parameter is set to 1, the precision level selection screen is displayed.

13610	Acceleration rate of acceleration/deceleration before interpolation when advanced preview control, AI advanced preview control, or AI contour control is used (precision level 1)
-------	---

13611	Acceleration rate of acceleration/deceleration before interpolation when advanced preview control, AI advanced preview control, or AI contour control is used (precision level 10)
-------	--

[Data type] 2-word
 [Unit of data] %

Increment system	Unit
Millimeter machine	0.001mm/sec ²

[Valid data range] 50000 to 99999999
 These parameters set the acceleration rate of acceleration/deceleration before interpolation in advanced preview control, AI advanced preview control, or AI contour control. Two levels including precision level 1, which places emphasis on speed, and precision level 10, which places emphasis on precision, can be set.

13612	Acceleration change time when AI contour control is used (bell-shaped) (precision level 1)
13613	Acceleration change time when AI contour control is used (bell-shaped) (precision level 10)

[Data type]
[Unit of data]
[Valid data range]

Byte
msec
1 to 100
These parameters set an acceleration change time (bell-shaped) with emphasis placed on speed (precision level 1) and an acceleration change time (bell-shaped) with emphasis placed on precision (precision level 10) in AI contour control.

13620	Permissible acceleration when advanced preview control, AI advanced preview control, or AI contour control is used (precision level 1)
13621	Permissible acceleration when advanced preview control, AI advanced preview control, or AI contour control is used (precision level 10)

[Data type]
[Unit of data]

2-word axis

Increment system	Unit
Millimeter machine	0.001mm/sec ²

[Valid data range]

0 to 99999999
These parameters set a permissible acceleration with emphasis placed on speed (precision level 1) and a permissible acceleration with emphasis placed on precision (precision level 10) in advanced preview control, AI advanced preview control, or AI contour control.

13622	Time constant of acceleration/deceleration after interpolation (precision level 1)
13623	Time constant of acceleration/deceleration after interpolation (precision level 10)

[Data type]
[Unit of data]
[Valid data range]

Word axis
msec
See the description of parameter No. 1768.
These parameters set a time constant of linear acceleration/deceleration after interpolation with emphasis placed on speed (precision level 1) and a time constant of linear acceleration/deceleration after interpolation with emphasis placed on precision (precision level 10).
The linear or bell-shaped type is selected by bit 3 (BS2) and bit 6 (LS2) of parameter No. 1602.

Parameter No.1602		Acceleration/deceleration
LS2(#6)	BS2(#3)	
1	0	Selects linear acceleration/deceleration after cutting feed interpolation.
0	1	Selects bell-shaped acceleration/deceleration after cutting feed interpolation.

NOTE

- 1 For bell-shaped acceleration/deceleration, the function for bell-shaped acceleration/deceleration after cutting feed interpolation is required.
- 2 The same parameters are used in advanced preview control, AI advanced preview control, and AI contour control.

13624

Difference in corner speed when advanced preview control, AI advanced preview control, or AI contour control is used (precision level 1)

13625

Difference in corner speed when advanced preview control, AI advanced preview control, or AI contour control is used (precision level 10)

[Data type]

Word axis

[Unit of data, valid data range]

Increment system	Units of data	Valid data range	
		IS-B	IS-C
Millimeter machine	1 mm/min	6 to 15000	6 to 12000
Rotation axis	1 deg/min	6 to 15000	6 to 12000

These parameters set a permissible speed difference with emphasis placed on speed (precision level 1) and a permissible speed difference with emphasis placed on precision (precision level 10) when the speed is determined by a corner speed difference in advanced preview control, AI advanced preview control, or AI contour control.

13626

Maximum machining speed (precision level 1)

13627

Maximum machining speed (precision level 10)

[Data type]

2-word axis

[Unit of data, valid data range]

Increment system	Units of data	Valid data range	
		IS-B	IS-C
Millimeter machine	1 mm/min	6 to 24000	6 to 100000
Rotation axis	1 deg/min	6 to 24000	6 to 100000

These parameters set the maximum machining speed for each axis.

13628	Parameter number for arbitrary item 1 when advanced preview control, AI advanced preview control, or AI contour control is used
-------	---

13629	Parameter number for arbitrary item 2 when advanced preview control, AI advanced preview control, or AI contour control is used
-------	---

[Data type] Word
 [Valid data range] 1 to 65535
 These parameters specify parameter numbers corresponding to arbitrary items 1 and 2.

NOTE

- 1 You cannot specify the numbers of the following parameters:
 - Bit parameters
 - Spindle parameters (Nos. 4000 to 4799)
 - Parameters requiring power disconnection (P/S 0 alarm is issued for these parameters.)
 - Nonexistent parameters
- 2 When such a parameter is set, the power must be turned off before operation is continued.

13630	Value of the parameter corresponding to arbitrary item 1 with emphasis placed on speed (precision level 1) when advanced preview control, AI advanced preview control, or AI contour control is used
-------	--

13631	Value of the parameter corresponding to arbitrary item 2 with emphasis placed on speed (precision level 1) when advanced preview control, AI advanced preview control, or AI contour control is used
-------	--

13632	Value of the parameter corresponding to arbitrary item 1 with emphasis placed on speed (precision level 10) when advanced preview control, AI advanced preview control, or AI contour control is used
-------	---

13633	Value of the parameter corresponding to arbitrary item 2 with emphasis placed on speed (precision level 10) when advanced preview control, AI advanced preview control, or AI contour control is used
-------	---

[Data type] 2-word axis
 [Unit of data] Depending on the type of the parameter for an item
 [Valid data range] Depending on the type of the parameter for an item

13634	Precision level currently selected when advanced preview control, AI advanced preview control, or AI contour control is used
-------	--

[Data type] Byte
 [Valid data range] 1 to 10
 The currently selected level is set.

4.59 PARAMETERS OF SERVO (2)

14010	Maximum permissible movement amount at FL feedrate when the reference position is established with an encoder with the absolute address zero point (detection circuit C)
-------	---

[Data type]	2-word axis
[Unit of data]	Detection unit
[Valid data range]	0 to 99999999

This parameter sets the amount of a movement made at the FL feedrate when the reference position is established with an encoder with the absolute address zero point (linear scale or rotary encoder) (detection circuit C). If the reference position is not established even when a movement is made by the amount set in this parameter or more, P/S alarm 5326 (Scale with the zero point: Failure in reference position establishment) is issued. When this parameter is set to 0, the maximum permissible movement amount at the FL feedrate at the time of reference position establishment becomes invalid.

NOTE

- 1 When the reference position is established under simplified synchronization control of the M series, if this parameter is set for one of the master and slave axes, the setting automatically applies also to the other axis.
- 2 In angular axis control, the setting of this parameter is invalid for a Cartesian axis with which angular axis reference position is being established.

APPENDIX

A

CHARACTER CODE LIST

Character	Code	Comment	Character	Code	Comment
A	065		6	054	
B	066		7	055	
C	067		8	056	
D	068		9	057	
E	069			032	Space
F	070		!	033	Exclamation mark
G	071		"	034	Quotation marks
H	072		#	035	Sharp
I	073		\$	036	Dollar mark
J	074		%	037	Percent
K	075		&	038	Ampersand
L	076		'	039	Apostrophe
M	077		(040	Left parenthesis
N	078)	041	Right parenthesis
O	079		*	042	Asterisk
P	080		+	043	Positive sign
Q	081		,	044	Comma
R	082		-	045	Negative sign
S	083		.	046	Period
T	084		/	047	Slash
U	085		:	058	Colon
V	086		;	059	Semicolon
W	087		<	060	Left angle bracket
X	088		=	061	Equal sign
Y	089		>	062	Right angle bracket
Z	090		?	063	Question mark
0	048		@	064	Commercial at mark
1	049		[091	Left square bracket
2	050			094	
3	051		¥	092	Yen mark
4	052]	093	Right square bracket
5	053		_	095	Underline

INDEX

<C>

CHARACTER CODE LIST 395

<D>

DESCRIPTION OF PARAMETERS 8

DISPLAYING PARAMETERS 1

</>

INPUTTING AND OUTPUTTING PARAMETERS
THROUGH THE READER/PUNCHER INTERFACE ... 5

INPUTTING PARAMETERS THROUGH THE
READER/PUNCHER INTERFACE 7

<O>

OTHER PARAMETERS 368

OUTPUTTING PARAMETERS THROUGH THE
READER/PUNCHER INTERFACE 6

<P>

Parameter of canned Cycle for Drilling 235

PARAMETER OF MEMORY CARD INTERFACE 28

Parameter of Multiple Repetitive Canned Cycle 242

Parameter of Thread Cutting Cycle 242

Parameters Common to all Channels 16

PARAMETERS OF ACCELERATION CONTROL ... 378

PARAMETERS OF

ACCELERATION/DECELERATION CONTROL 79

PARAMETERS OF ANGULAR AXIS CONTROL ... 355

PARAMETERS OF AUTOMATIC TOOL

COMPENSATION (T SERIES) AND AUTOMATIC

TOOL LENGTH COMPENSATION (M SERIES) 303

PARAMETERS OF AXIS CONTROL BY PMC 345

PARAMETERS OF AXIS CONTROL/INCREMENT
SYSTEM 32

PARAMETERS OF BUTT-TYPE REFERENCE

POSITION SETTING 334

PARAMETERS OF CANNED CYCLES 235

Parameters of Channel 1 (I/O CHANNEL=0) 17

Parameters of Channel 1 (I/O CHANNEL=1) 19

Parameters of Channel 2 (I/O CHANNEL=2) 19

PARAMETERS OF COORDINATES 44

PARAMETERS OF CUSTOM MACROS 287

PARAMETERS OF DATA SERVER 29

PARAMETERS OF DI/DO 137

PARAMETERS OF DISPLAY AND EDIT (1 OF 2)... 143

PARAMETERS OF DISPLAY AND EDIT (2/2)..... 385

PARAMETERS OF DISPLAYING OPERATION

TIME AND NUMBER OF PARTS 311

PARAMETERS OF DNC2 INTERFACE 22

PARAMETERS OF ETHERNET 30

PARAMETERS OF EXTERNAL DATA

INPUT/OUTPUT 305

PARAMETERS OF FAILURE DIAGNOSIS..... 373

PARAMETERS OF FEEDRATE 60

PARAMETERS OF FS0i BASIC FUNCTIONS 352

PARAMETERS OF GENERAL-PURPOSE

RETRACTION 343

Parameters of Graphic Color 308

PARAMETERS OF GRAPHIC DISPLAY 306

Parameters of Graphic Display/Dynamic Graphic

Display 306

PARAMETERS OF INDEXING INDEX TABLE 285

PARAMETERS OF MACHINING CONDITION

SELECTION 387

PARAMETERS OF MAINTENANCE 374

PARAMETERS OF MANUAL HANDLE FEED,
MANUAL HANDLE INTERRUPTION AND TOOL

DIRECTION HANDLE FEED 330

PARAMETERS OF MANUAL HANDLE

FUNCTION..... 376

PARAMETERS OF MANUAL OPERATION AND

AUTOMATIC OPERATION 325

PARAMETERS OF NORMAL DIRECTION

CONTROL..... 281

PARAMETERS OF OPERATION HISTORY 380

PARAMETERS OF PATTERN DATA INPUT 296

Parameters of Peck Drilling Cycle of a Small

Diameter 246

PARAMETERS OF PITCH ERROR

COMPENSATION..... 178

PARAMETERS OF POLAR COORDINATE

INTERPOLATION 279

PARAMETERS OF POLYGON TURNING 340

PARAMETERS OF POSITION SWITCH

FUNCTIONS 321

PARAMETERS OF POWER MATE CNC

MANAGER..... 31

PARAMETERS OF PROGRAM RESTART 339

PARAMETERS OF PROGRAMS..... 169

PARAMETERS OF READER/PUNCHER
INTERFACE, REMOTE BUFFER, DNC1, DNC2,
AND M-NET INTERFACE..... 15

PARAMETERS OF REMOTE DIAGNOSIS 25

PARAMETERS OF RIGID TAPPING..... 251

PARAMETERS OF SCALING/COORDINATE
ROTATION 275

PARAMETERS OF SEQUENCE NUMBER
COMPARISON AND STOP 367

PARAMETERS OF SERVO (1 OF 2)..... 102

PARAMETERS OF SERVO (2)..... 391

PARAMETERS OF SERVO SPEED CHECK..... 375

PARAMETERS OF SETTING..... 10

PARAMETERS OF SIMPLE SYNCHRONOUS
CONTROL..... 358

PARAMETERS OF SKIP FUNCTION..... 297

PARAMETERS OF SOFTWARE OPERATOR'S
PANEL..... 336

PARAMETERS OF SPINDLE CONTROL 186

PARAMETERS OF STROKE CHECK..... 50

PARAMETERS OF THE CHUCK AND TAILSTOCK
BARRIER (T SERIES) 56

PARAMETERS OF TOOL COMPENSATION..... 223

PARAMETERS OF TOOL LIFE MANAGEMENT 315

PARAMETERS OF UNI-DIRECTIONAL
POSITIONING 277

<S>

SETTING PARAMETERS FROM MDI 3

Revision Record

FANUC Series 0i-MODEL C/0i Mate-MODEL C PARAMETER MANUAL (B-64120EN)

Edition	Date	Contents	Edition	Date	Contents
01	May, 2004	_____			

- *No part of this manual may be reproduced in any form.*
- *All specifications and designs are subject to change without notice.*