

Yaesu FT-8900R

Operating Manual The W5JCK Expanded Version

Courtesy of W5JCK



Dual Band FM Transceiver

November 2006

Table of Contents

About this Manual.....	5
Introduction	6
Front Panel Controls.....	6
LCD Display Screen.....	10
MH-48A6J Microphone Overview.....	11
Common Tasks	13
Program the Microphone Buttons	13
Select the Main Operating Band.....	15
Change the Frequency Band.....	16
Change the Frequency	17
Transmit	18
Activate the Lock Feature	18
Activate the Key/Button Beeper.....	19
Select the Channel Step	19
Set the Display Brightness	20
Activate the Band Linking Feature.....	20
Select the Audio Muting Preference.....	20
Set the RF Squelch Level	21
Activate the Time-Out Timer	21
Activate Automatic Power Off.....	22
Set FM Bandwidth and MIC Gain.....	22
Program Band Limits for VFO Mode	23
Operate through Repeaters	25
Automatic Repeater Shifts.....	25
Manual Repeater Shift Activation.....	25
Tone Coded Squelch.....	27
CTCSS Tone System.....	27
DCS Tone System	28
Tone Search Scanning	29
DCS Code Inversion.....	30
Regular Memory.....	32
Overview	32
Store a Frequency in Memory	32
Create a Name Tag for a Memory Channel.....	33
Store Independent Transmit Frequencies	34
Recall a Stored Memory.....	35
Tune from a Stored Memory	35
Delete a Memory	36
Set a HOME Channel for an Operating Band	36
Activate Memory Only Mode	37
Hyper Memory	38
Overview	38
Store a Hyper Memory	40
Recall a Hyper Memory	41

Scanning	42
Overview	42
Set the Scan-Resume Preference	42
Priority Channel Scanning (Dual Watch)	42
Scan in VFO Mode	44
Scan in Memory Mode	45
Standard Memory Scan	46
How to Skip a Channel During Memory Scan	47
Preferential Memory Scan	47
Smart Search	49
ARTS	50
Overview	50
Set Up/Operate ARTS	50
Set Up the CW Identifier	51
Operating the DTMF Autodialer	53
To load DTMF Autodialer memories:	53
To transmit the memorized telephone number:	53
To set the speed:	54
To set a delay time:	54
Internet Connection Feature	55
To access a WIREST™ repeater:	55
To access other Internet Link Systems that use a DTMF string for access:	55
Operate as a Cross-Band Repeater	57
To set up Cross-Band Repeater operation:	57
Transfer Data between two FT-8900Rs	58
Reset Your FT-8900R	59
Menu (Set) Mode	60
Overview	60
Menu Quick Reference Table	61
Menu Items	63
Menu #1 APO	63
Menu #2 ARS	63
Menu #3 ARTS	64
Menu #4 BAND	64
Menu #5 BEEP	65
Menu #6 CLK.SFT	65
Menu #7 CWID	65
Menu #8 CWID W	65
Menu #9 DIMMER	66
Menu #10 DCS.COD	66
Menu #11 DCS.N/R	66
Menu #12 DSP.SUB	67
Menu #13 DTMF D	67
Menu #14 DTMF S	67
Menu #15 DTMF W	68
Menu #16 HYPER	68
Menu #17 INET	68

TABLE OF CONTENTS

Menu #18 INET C68
Menu #19 INET M69
Menu #20 KEY.MOD69
Menu #21 LOCK69
Menu #22 LOCKT69
Menu #23 MIC70
Menu #24 MUTE70
Menu b 25 NAME70
Menu h 26 PKT.SPD71
Menu h 27 PKT.RXB71
Menu #28 PG P171
Menu #29 PG P272
Menu #30 PG P372
Menu #31 PG P472
Menu #32 RF SQL72
Menu b 33 RPT.MOD73
Menu #34 SCAN73
Menu b 35 SCAN M74
Menu b 36 SHIFT74
Menu b 37 STEP74
Menu #38 SPCONT75
Menu b 39 TONE F75
Menu b 40 TONE M75
Menu #41 TOT76
Menu h 42 VFO.TR76
Menu b 43 WID.NAR76
Menu #44 X-RPT76
Menu b 45 AM77
Menu h 46 AUT. AM77

About this Manual

LATEST UPDATE: 28 November 2006

I made the following improvements to the Yaesu **FT-8800R** Operating Manual:



- Reformatted the material to make it easier to read and locate information
- Reworded some of the more difficult to understand passages and key terminology
- Greatly expanded the **Hyper Memory** section
- Clarified and expanded the **Scanning** section
- Reorganized the material into a more logical order
- Updated some of the artwork to make it more presentable
- Added cross-references

This manual is absolutely free. However, if you like, you can donate a small amount to help defray the cost of developing this (and other) HAM radio manuals. If you would like to make a donation, please goto <http://w5jck.jackswinden.com/manuals/ft-8800r/donations.html>.

If you have any questions or comments, please email me at w5jck@jackswinden.com.

Happy reading! *Jack Swinden, W5JCK*

Conventions are used in this manual

- The "**Main** band" is the side of the **FT-8800R** on which you can transmit. This band is indentified on the **FT-8800R**'s LCD screen by the  symbol.
- The "**Sub** band" is the side of the **FT-8800R** on which you can receive only.
- The " **DIAL** knob" is the **DIAL** knob on the side of the **FT-8800R** currently set as the **Main** band.
- Menu items and key terms are shown in **bold Arial text**, and menu names (functions) and menu options or shown in `monospace text`.

For example: "**Menu #21** `LOCK` can be set to `OFF` or `ON`."

- Notes are presented as below:



This is a sample note. Notes typically contain extra information designed to clarify the information presented in a topic. Sometimes they contain **CAUTIONs** or **WARNINGs**.

Introduction



The **FT-8900R** is a ruggedly-built, high quality Quad Band FM transceiver providing 50 Watts of power output on the 29/50/144 MHz Amateur band and 35 Watts on the 430 MHz band.

The high power output of the **FT-8900R** is produced by its RD70HVF1 Power MOS FET amplifier, with a direct-flow heat sink and thermostatically-controlled cooling fan maintaining a safe temperature for the transceiver's circuitry.

Featuring 809 memory channels, full duplex operation with independent **Volume** and **Squelch** controls, and built-in **CTCSS** and **DCS** encoder/decoder circuits, the **FT-8900R** includes provision for remote-head mounting, utilizing the optional **YSK-8900 Separation Kit**, which allows installation even in the most compact of cars.

We recommend that you read this manual in its entirety, so as to fully understand the many features of your new **FT-8900R** transceiver.

Front Panel Controls



(1) Left and Right *DIAL* knobs

These 20-position detented rotary switches are the tuning *DIAL*s for the left and right bands.

- Press the adjoining knob momentarily to switch the **Main** band to the side where the knob is located.
- When in the **Memory** mode, press this knob to enable rapid tuning (in 10 channel steps) using this knob.
- When in the **VFO** mode, press this knob to enable rapid tuning (in 1 MHz steps) using this knob.
- When in the **VFO** mode, press and hold in this knob for ½ second to toggle the operating band as follows:

29 MHz → 50 MHz → 144 MHz → 350 MHz → 430 MHz → 850 MHz

(2) Left and Right **VOL** Knobs

The **VOL** (Volume) control adjusts the speaker audio level for the adjoining receiver.

- Clockwise rotation increases the audio level.
- Press this knob momentarily to switch the Internet Connection feature on and off.

(3) Left and Right **SQL** Knobs

The **SQL** (Squelch) control is used to silence background noise on the adjoining receiver.

- Clockwise rotation decreases the squelch level.
- It should be advanced clockwise just to the point where the noise is silenced (and the **BUSY** indicator on the display turns off), so as to provide the best sensitivity to weak signals.

(4) Hyper Memory Buttons ...

- Press and hold in one of these buttons for 2 seconds to store the current total configuration of the radio into a special Hyper memory bank.
- Press the appropriate button momentarily to recall the desired Hyper memory.

(5) Left and Right Side Key

Left Side Keys

The left side keys function as **LOW**, **V/M**, **HM**, and **SCN**.

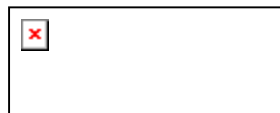

Right Side Keys

The right side keys may be set to function as **LOW**, **V/M**, **HM**, and **SCN** (default) or as **MHz**, **REV**, **TONE**, and **SUB** (**KEY2**).



Left Side Keys (always) and Right Side Keys when in Key Mode 1

Key: (Default)

- Press this key repeatedly to toggle the transmitter power output level of the adjoining band:

LOW → MID2 → MID1 → HIGH

- When the adjoining band is set to the **Memory** mode or **Home Channel**, press and hold in this key for ½ second to switch the memory channel display between the Frequency format and the Alpha-numeric Tag format.

Key: (Default)

- Press this key momentarily to switch the frequency control for the adjoining band between the **VFO** and Memory Systems.
- When the adjoining band is set to the **VFO** mode, press and hold in this for ½ second to activate the Smart Search Feature.
- When the adjoining band is set to the **Memory** mode, press and hold in this key for ½ second to activate the Memory Tuning feature.

Key: (Default)





- Press this key momentarily to recall a favorite **Home Channel** on the adjoining band.
- Press and hold in this for ½ second to activate **Priority Channel Scanning** on the adjoining band.

Key: (Default)

- Press this key momentarily to activate the **Scanner** on the adjoining band.
- When the adjoining band is set to the **Memory** mode, press and hold in this key for ½ second to set up the **Scan Skip List** or **Preferential Scan List**.

Right Side Keys when in Key Mode 2 ()

To set the right side keys to **Key Mode 2**:

1. Press the  **SET** key momentarily to enter the Set mode.
2. Rotate the  **DIAL** knob to select **Menu #20** KEY . MOD.
3. Press the  **DIAL** knob momentarily, then rotate the  **DIAL** knob to change the setting to KEY 2.
4. Press and hold in the  **DIAL** knob for ½ second to save the new setting and exit to normal operation.

When set to **Key Mode 2**, the  indicator is displayed and the keys function as follows:

MHz Key:  while in **Key Mode 2**

- Press this key momentarily to allow tuning in 1-MHz steps on the **Main** band **VFO**.
- Press and hold in this key for ½ second to allow tuning in 10-MHz steps on the **Main** band **VFO**.

REV Key:  while in **Key Mode 2**

- Press this key momentarily to reverse the transmit and receive frequencies on the **Main** band during split-frequency (i.e. Repeater) operation.
- Press and hold in this key for ½ second to change the frequency shift direction:



RPT - (minus shift) → RPT + (plus shift) → RPT OFF (simplex)

TONE Key:  while in **Key Mode 2**

- Press this key momentarily to change the **Tone Squelch** mode:

ENC (CTCSS Encoder) → ENC.DEC (CTCSS Tone Squelch) → DCS (DCS operation)

SUB Key:  while in **Key Mode 2**

- Press this key momentarily to activate the **Sub** band function (the  icon will blink on the **Sub** band). When the **Sub** band function is activated, any keys you press act on the **Sub** band.
- When the **Sub** band function is activated (the  icon is blinking on the **Sub** band), press this key momentarily to deactivate the **Sub** band function.

(6)  **SET Key**

- Press this key momentarily to enter the **Set (Menu)** mode.
- Press and hold in this key for ½ second to transfer the contents of the **Main** band **VFO** into a Memory register.

LCD Display Screen

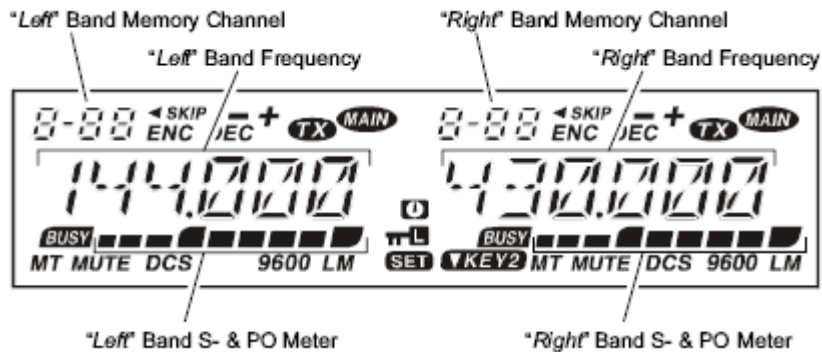

Icons

◀: Preferential Memory Channel

SKIP: Skip Memory Channel

-: Minus Shift

+: Plus Shift

- +: Odd Split

ENC: Tone Encoder

DEC: Tone Decoder

TX: Transmission in Progress

MAIN: Main Band

BUSY: Busy Channel (or Squelch Off)

MT: Memory Tune Mode

MUTE: Audio Mute Active

DCS: Digital Code Squelch (DCS)

AM: AM Reception

9600: 9600 bps Packet Mode

L: Low TX Power Selected

M: Middle TX Power Selected (No Icon indicates High TX Power)

⏻: Automatic Power-Off Active

⏻: Keypad/DIAL Lock Active

SET: Menu (Set) Mode

KEY2: Key Function Mode is set to KEY-2

MH-48A6J Microphone Overview

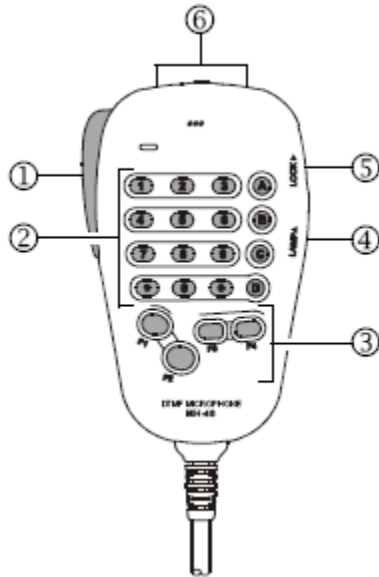

(1) PTT Switch

Press this switch to transmit, and release it to receive.

(2) Keypad

The 12 number keys generate DTMF tones during transmission.

In the receive mode, these keys can be used for direct frequency entry and/or direct numeric recall of the Memory channels.



The A, B, C, and D keys serve no function on the **FT-8900R**.

(3) Programmable Buttons

You can program any of the Programmable buttons for the following functions: BAND, HOME, LOW, MHz, PRI, REV, RPTR, SCAN, SQL.OFF, TCALL, TONE, VFO/MR.

(See *Program the Microphone Buttons* on page 13 for details.)

P1 button: default setting is BAND function

- Press this button to switch the **Main** band between the Left and Right displays on the LCD screen. This is the best and easiest way to set the **Main** band to the side you prefer.
- Press and hold this button for ½ second to move operation to the next-highest frequency band on the **Main** band.

P2 button: default setting is VFO/MR function

- Press this button momentarily to switch the frequency control for the **Main** band between the **VFO** and Memory Systems.
- When the **Main** band is set to the **VFO** mode, press and hold in this button for ½ second to activate the Smart Search Feature.
- When the **Main** band is set to the **Memory** mode, press and hold in this button for ½ second to activate the Memory Bank feature.

 button: default setting is TONE function

Press this button repeatedly to select the **CTCSS** or **DCS** mode on the **Main** band:

ENC → ENC.DEC (Tone Squelch) → DCS

 button: default setting is LOW function

- Press this button repeatedly to select the transmitter power output level on the **Main** band:
 - **LOW**: 5 watts VHF/UHF
 - **MID2**: 10 watts VHF/UHF
 - **MID1**: 20 watts VHF/UHF
 - **HIGH**: 50 watts VHF, 35 watts UHF
- When the **Main** band is set to the **Memory** mode or **Home Channel**, press and hold in this key for ½ second to switch the memory channel display between the Frequency format and Alpha-numeric Tag format.

(4) LAMP Switch

This switch illuminates the Microphone keypad.

(5) LOCK Switch

This switch locks out the Microphone buttons (except for the keypad and PTT switch).

(6)  /  buttons

Press (or hold in) either of these buttons to tune (or scan up or down) the operating frequency or through the memory channels on the **Main** band. In many ways, these buttons emulate the function of the (rotary)  **DIAL** knob.

Common Tasks

This section contains a number of common tasks you might want to perform during the normal operation of your **FT-8900R**.

Program the Microphone Buttons

Default **FT-8900R** key functions have been assigned to the **MH-48A6J** Microphone **P1**, **P2**, **P3**, and **P4** buttons at the factory. These may be changed by the user, if you wish to utilize another function on one of these keys. (See **MH-48A6J Microphone Overview** on page 11 for details.)

To program the function assigned to a key:

1. Press the **SET** key momentarily to enter the **Set** mode.
2. Rotate the **MAIN DIAL** knob to select the **Menu** Item to be configured:
 - To program the **P1** button select **Menu #28** PG P1
 - To program the **P2** button select **Menu #29** PG P2
 - To program the **P3** button select **Menu #30** PG P3
 - To program the **P4** button select **Menu #31** PG P4
3. Press the **MAIN DIAL** knob momentarily, then rotate the **MAIN DIAL** knob to select the function you wish to assign to the button you selected in the previous step.
4. Press the **SET** key to save the new setting, then rotate the **MAIN DIAL** knob to select another programmable button to modify, if desired, and repeat the above steps.
5. Press and hold in the **MAIN DIAL** knob for ½ second to exit to normal operation.

Programming Options for the Buttons

BAND function (factory default for **P1** button)

- Press the button to toggle the **Main** band of operation between the Left band and right band.
- Press and hold the button for ½ second to switch operating band on the **Main** band.

HOME (HM) function

- Press the button to switch operation to the **Home Channel** on the **Main** band.
- Press and hold the button for ½ second to activate the Priority Scanning.

LOW function (factory default for  button)

- Press the button to select the transmit power output level on the **Main** band.
- When the **Main** band is set to the **Memory** mode or **Home Channel**, press and hold in this button for ½ second to switch the memory channel display between the Frequency format and Alpha-numeric Tag format.

MHz function

- Press the button to allow tuning in 1-MHz step on the **Main** band **VFO**.
- Press and hold the button for ½ second to allow tuning in 10-MHz step on the **Main** band **VFO**.

PRI function

- Press the button to activate the **Priority** feature on the **Main** band.
- No press and hold function for this button.

REV function

- Press the button to reverse the transmit and receive frequencies during split-frequency operation.
- Press and hold the button for ½ second to select Repeater Shift direction on the **Main** band.

RPTR function

- Press the button to select Repeater Shift direction on the **Main** band.
- No press and hold function for this button.

SCAN function

- Press the button to activate the Scanner on the **Main** band.
- When the **Main** band is set to the **Memory** mode, press and hold the button for ½ second to set up the Scan Skip List or Preferential Scan List.

SQL.OFF function

- Press the button to open the Squelch on the **Main** band to allow un-muted reception.
- Press and hold the button for ½ second to open the Squelch on the **Main** band to allow un-muted reception.

TCALL function

- Press the button to activate 1750 Hz Tone Burst.
- Press and hold the button for ½ second to activate 1750 Hz Tone Burst.

TONE function (factory default for **P3 button)**

- Press the button to activate the CTCSS or DCS operation on the **Main** band.
- No press and hold function for this button.

VFO/MR function (factory default for **P2 button)**

- Press the button to switch frequency control between the **VFO** and **Memory** modes on the **Main** band.
- When the **Main** band is set to the **VFO** mode, press and hold the button for ½ second to activate the Smart Search Feature.
- When the **Main** band is set to the **Memory** mode press and hold the button for ½ second to shift to the Memory Tuning feature.

Select the Main Operating Band

In the factory default configuration, the **FT-8900R** operates in the **Dual Receive** mode.

During **Dual Receive** operation, the **Main** band frequency (on which transmission is possible) will be indicated by the **MAIN** icon.

You will observe the **MAIN** icon lighting up alternate sides of the display as you switch **Main** bands from the left side to the right side, and vice-versa. (The following illustration shows the **Main** band on the left side and the **Sub** band on the right side.)



To establish the **Main** band, momentarily press one of the following:

- The left or right **DIAL** knob
- **MH-48A6J** microphone's **P1** key

To switch the frequency band, see **Change the Frequency Band** on page 16 for details.

Change the Frequency Band

In the factory default configuration, the **FT-8900R** operates in the **Dual Receive** mode.

The following illustration shows UHF—VHF (**U-V**) mode of operation.



The **FT-8900R** can also be configured to operate in **V-U** mode (not shown), or **V-V** or **U-U** modes (shown below).

V-V mode



U-U mode



To switch the frequency band:

- When in **VFO** mode, press and hold in the left **DIAL** knob for ½ second to cycle the operating band on the left side to the next-highest frequency band.
29 MHz → 50 MHz → 144 MHz → 350 MHz → 430 MHz → 850 MHz
- When in **VFO** mode, press and hold in the right **DIAL** knob for ½ second to cycle the operating band on the right side to the next-highest frequency band.
144 MHz → 430 MHz

To switch the **Main** band, see **Select the Main Operating Band** on page 15 for details.

Change the Frequency

Navigation using the Tuning DIAL

Rotating the **DIAL** knob allows tuning in the pre-programmed steps established for the current operating band. Clockwise rotation of the **DIAL** knob causes the **FT-8900R** to be tuned toward a higher frequency, while counter-clockwise rotation will lower the operating frequency.

On the **Main** band frequency, press the **DIAL** knob momentarily, then rotate the **DIAL** knob, to change the **Main** band frequency steps to 1 MHz per step. This feature is extremely useful for making rapid frequency excursions over the wide tuning range of the **FT-8900R**.

Direct Keypad Frequency Entry using the MH-48A6J Microphone

The keypad of the **MH-48A6J** DTMF Microphone may be used for direct entry of the **Main** band operating frequency.

To enter a frequency from the **MH-48A6J** keypad, just press the numbered digits in the proper sequence. There is no decimal point key on the **MH-48A6J** keypad, so if the frequency is below 100 MHz (e.g. 29.480 MHz), any required leading zeroes must be entered.

Examples:

- To enter **146.480 MHz**, press 0 → 2 → 9 → 4 → 8 → 0
- To enter **433.000 MHz**, press 4 → 3 → 3 → 0 → 0 → 0

Scanning

From the **VFO** mode, press the  key momentarily to initiate scanning toward a higher frequency. The **FT-8900R** will stop when it receives a signal strong enough to break through the squelch threshold. The **FT-8900R** will then hold on that frequency according to the setting of the **Resume** mode (**Menu #34** SCAN).

If you wish to reverse the direction of the scan (i.e. toward a lower frequency, instead of a higher frequency), just rotate the **DIAL** knob one click in the counter-clockwise direction while the **FT-8900R** is scanning. The scanning direction will be reversed. To revert to scanning toward a higher frequency once more, rotate the **DIAL** knob one click clockwise.

Press the  key again to cancel scanning.

Transmit

To transmit, simply depress the **PTT** (Push To Talk) switch on the microphone.

The **FT-8900R** will transmit only on the **Main** band. During transmission, the  icon will appear at the upper right of the **Main** frequency field on the display.

Changing the Transmitter Power Level

You can select from among a total of four transmit power levels on your **FT-8900R**.

To change the power level, press the  key to select one of the four power settings. These power levels will be stored in memory registers at the time of memory storage.

- **LOW**: 5 watts HF/VHF/UHF
- **MID2**: 10 watts HF/VHF/UHF
- **MID1**: 20 watts HF/VHF/UHF
- **HIGH**: 50 watts HF/VHF, 35 watts UHF





During transmission, the **Bar Graph** will deflect in the display, according to the power output selected.

You may change the power level on the **Main** band using the **MH-48A6J** microphone's  key.

Activate the Lock Feature

In order to prevent accidental frequency change, the panel switches and **DIAL** knobs may be locked out.

To activate the Lock feature:





1. Press the  **SET** key momentarily to enter the **Set** mode.
2. Rotate the  **DIAL** knob to select **Menu #21** **LOCK**.
3. Press the  **DIAL** knob momentarily, then rotate the  **DIAL** knob to change the setting to **ON**.
4. Press the  **SET** key momentarily to save the new setting and exit to normal operation.

To unlock the panel switches and **DIAL** knobs, select **OFF** in step 3 above.

Activate the Key/Button Beeper

A key/button beeper provides useful audible feedback whenever a key/button is pressed.

If you want to turn the beep on:

1. Press the  **SET** key momentarily to enter the **Set** mode.
2. Rotate the  **DIAL** knob to select **Menu #5 BEEP**.
3. Press the  **DIAL** knob momentarily, then rotate the  **DIAL** knob to change the setting to **ON**.
4. Press and hold in the  **DIAL** knob for ½ second to save the new setting and exit to normal operation.





To turn the beep off, select **OFF** in step 3 above.



Menu #5 BEEP controls all **FT-8900R** beeps, including those sounded when powering on the radio and when the radio is receiving a signal.





Select the Channel Step

The **FT-8900R**'s synthesizer provides the option of utilizing channel steps of 5/10/12.5/15/20/25/50 kHz per step, any number of which may be important to your operating requirements. The **FT-8900R** is set up at the factory with different default steps on each operating band which probably are satisfactory for most operation. However, if you need to change the channel step increments, the procedure to do so is very easy; remember to get set up on the desired band before making any changes, as different steps may be programmed for each operating band.

1. Press the  **SET** key momentarily to enter the **Set** mode.
2. Rotate the  **DIAL** knob to select **Menu #37 STEP**.
3. Press the  **DIAL** knob momentarily, then rotate the  **DIAL** knob to select the new channel step size.
4. Press and hold in the  **DIAL** knob for ½ second to save the new setting and exit to normal operation.

Set the Display Brightness

The **FT-8900R** display illumination has been specially engineered to provide high visibility with minimal disruption of your night vision while you are driving. The brightness of the display is manually adjustable, using following procedure:







1. Press the  **SET** key momentarily to enter the **Set** mode.
2. Rotate the  **DIAL** knob to select **Menu #9** DIMMER.
3. Press the  **DIAL** knob momentarily, then rotate the  **DIAL** knob to select a comfortable brightness level: DIM 1, DIM 2, DIM 3, or DIM.OFF (no illumination).
4. Press and hold in the  **DIAL** knob for ½ second to save the new setting and exit to normal operation.

Activate the Band Linking Feature

For operation on Amateur satellites which use a normal (not inverted) FM transponder, the **Band Link** feature may be useful.



- (1) Both sides of the **FT-8900R** have to be in **VFO** mode.
- (2) Band Linking does not work with **AMSAT AO-51** (or similar) satellites.





1. Set both sides of the radio to the **VFO** mode by pressing the  keys, if necessary.
2. Press the  **SET** key momentarily to enter the Set mode.
3. Rotate the  **DIAL** knob to select **Menu #42** VFO.TR.
4. Press the  **DIAL** knob momentarily, then rotate the  **DIAL** knob to change the setting to ON.
5. Press and hold in the  **DIAL** knob for ½ second to save the new setting and exit to normal operation.

As you rotate the  **DIAL** knob, you will observe that the frequencies for both bands are changing together. When you are done with this operating mode, select OFF in step 3 above.

Select the Audio Muting Preference

The **Audio Mute** feature is useful in situation where it would be helpful to reduce the audio level of the **Receive Only** band whenever you receive a signal on the **Main** band or you transmit on the **Main** band during **Dual Receive** operation.





To activate the **Audio Mute** feature:

1. Press the  **SET** key momentarily to enter the **Set** mode.
2. Rotate the  **DIAL** knob to select **Menu #24** MUTE.
3. Press the  **DIAL** knob momentarily, then rotate the  **DIAL** knob to choose the desired selection.
 - **TX**: Reduces the audio level of the **Receive Only** band whenever you transmit on the **Main** band
 - **RX**: Reduces the audio level of the **Receive Only** band whenever you receive a signal on the **Main** band
 - **TX/RX**: Reduces the audio level of the **Receive Only** band whenever you receive a signal on the **Main** band or you transmit on the **Main** band
 - **OFF**: Disables the **Audio Mute** feature
4. Press and hold in the  **DIAL** knob for ½ second to save the new setting and exit to normal operation.

Set the RF Squelch Level

A special **RF Squelch** feature is provided on this radio. This feature allows you to set the squelch so that only signals exceeding a certain S-meter level will open the squelch.

When setting up the RF Squelch circuit for operation, note that you may set the **RF Squelch** independently for the left and right sides, using the following procedure:





1. Press the  **SET** key momentarily to enter the **Set** mode.
2. Rotate the  **DIAL** knob to select **Menu #32** RF SQL.
3. Press the  **DIAL** knob momentarily, then rotate the  **DIAL** knob to select the desired signal strength level for the squelch threshold (**OFF**, **S-2**, **S-5**, **S-9**, or **S-FULL**).
4. Press and hold in the  **DIAL** knob for ½ second to save the new setting and exit to normal operation.
5. Finally, rotate the **SQL** knob fully clockwise.

Activate the Time-Out Timer

The **Time-Out Timer (TOT)** feature is designed to force the transceiver into the **Receive** mode after a preset time period of continuous transmission (the default is 6 minutes). This feature prevents your transceiver from transmitting a dead carrier for a long period of time in the event that the microphone **PTT** switch is accidentally locked in the **TX** position.

The **Time-Out Timer**'s switch-to-receive time may be adjusted, in one minute increments, for any period between 1 and 30 minutes.





To change the default (6 minute) time setting, use the following procedure:

1. Press the  **SET key** momentarily to enter the **Set** mode.
2. Rotate the  **DIAL** knob to select **Menu #41** TOT.
3. Press the  **DIAL** knob momentarily, then rotate the  **DIAL** knob to select the desired interval (between 1 and 30 minutes), or OFF.
4. Press and hold in the  **DIAL** knob for ½ second to save the new setting and exit to normal operation.

Activate Automatic Power Off

The **Automatic Power-Off (APO)** feature will turn the radio completely off after a user-defined period of **PTT** switch or key/button inactivity. If you do not press any front panel keys or buttons, rotate the **DIAL** knobs or use the microphone's keys and buttons, or transmit, and so long as the transceiver is not scanning or engaged in priority monitoring, the radio will shut itself off after the specified time period. This feature is useful in minimizing battery drain in a mobile installation if you forget to turn the transceiver off when you leave your vehicle.



To activate the **APO** feature, use the following procedure:

1. Press the  **SET key** momentarily to enter the **Set** mode.
2. Rotate the  **DIAL** knob to select **Menu #1** APO.
3. Press the  **DIAL** knob momentarily, then rotate the  **DIAL** knob to set the desired switch-off time (between 1 and 12 hours in 0.5 hours increments), or OFF.
4. Press and hold in the  **DIAL** knob for ½ second to save the new setting and exit to normal operation.

Set FM Bandwidth and MIC Gain

You can reduce the microphone input level and receiver bandwidth when operating on tightly, clustered frequencies (channel spacing of 12.5 or 15 kHz). This will reduce the transmitter and receiver deviation, thus minimizing interference to other users (and improving reception).

To configure for the narrower bandwidth, use the following procedure:

1. Press the  **SET key** momentarily to enter the **Set** mode.
2. Rotate the  **DIAL** knob to select **Menu #43** WID.NAR.

3. Press the **MAIN DIAL** knob momentarily, then rotate the **MAIN DIAL** knob to change the display to **NARROW**.
4. Press and hold in the **MAIN DIAL** knob for ½ second to save the new setting and exit to normal operation.

To restore the normal (higher) microphone input level and normal (15 kHz) receiver bandwidth, select **WIDE** in step 3 above.

Program Band Limits for VFO Mode

The **FT-8900R** contains five sets of band-edge memories, also known as **Programmable Memory Scan (PMS)** channels, labeled **L1/U1** through **L5/U5**.

This feature allows you to set sub-band limits for either scanning or manual **VFO** operation. For example, you might wish to set up a limit (in North America) of 144.300 MHz to 148.000 MHz so as to prevent encroachment into the SSB/CW “Weak Signal” portion of the band below 144.300 MHz.



Here’s how to do this:

1. Set the **FT-8900R** to the **VFO** mode by pressing the **V/M** key, if necessary.
2. Tune to 144.300 MHz on the **Main** band.
3. Press and hold in the **SET** key for ½ second. A memory number will appear (blinking) on the display.
4. Within ten seconds of pressing the **SET** key, use the **MAIN DIAL** knob, or the microphone’s **UP** and **DWN** buttons, to select the **PMS** channel **L1** (the “L” designates the Lower sub-band limit).



The **PMS** channels (**L1/U1** through **L5/U5**) are located before Memory Channel 1 and after Memory Channel 799.

5. Press the **SET** key momentarily to save the entry and exit to normal operation.
6. Tune to 148.000 MHz on the **Main** band and repeat steps 3 through 5 to store 148.000 MHz into **PMS** channel **U1** (the “U” designates the Upper sub-band limit).

7. Switch to the **Memory** mode by pressing the  key momentarily, then rotate the **DIAL** knob to select Memory Channel $L1$.
8. Press and hold in the  key for $\frac{1}{2}$ second to start **PMS** operation; the **MT** icon will appear on the display. Tuning and scanning (engaged by pressing the  key momentarily) will now be limited within the just-programmed range.

Operate through Repeaters

Repeater stations, usually located on mountaintops or other high locations, provide a dramatic extension of the communication range for low-powered hand-held or mobile transceivers. The **FT-8900R** includes a number of features which make repeater operation simple and enjoyable.

Repeater Shifts

Your **FT-8900R** has been configured at the factory for the repeater shifts customary in your country. For the 50 MHz band, this usually will be 1 MHz, while the 144 MHz shift will be 600 kHz; on 70 cm, the shift may be 1.6 MHz, 7.6 MHz, or 5 MHz (USA version).





Depending on the part of the band in which you are operating, the repeater shift may be either downward (–) or upward (+), and one of these icons will appear on the LCD (above the frequency) when repeater shifts have been enabled.

Automatic Repeater Shifts

The **FT-8900R** provides a convenient **Automatic Repeater Shift (ARS)** feature, which causes the appropriate repeater shift to be automatically applied whenever you tune into the designated repeater sub-bands in your country. These sub-bands are shown below.

If the **ARS** feature does not appear to be working, you may have accidentally disabled it.





To enable **ARS**:

1. Press the  **SET** key momentarily to enter the **Set** mode.
2. Rotate the  **DIAL** knob to select **Menu #2** ARS.
3. Press the  **DIAL** knob momentarily, then rotate the  **DIAL** knob to change the setting to **ON** (to enable Automatic Repeater Shift).
4. Press and hold in the  **DIAL** knob for ½ second to save the new setting and exit to normal operation.

Manual Repeater Shift Activation

If the **ARS** feature has been disabled, or if you need to set a repeater shift direction other than that established by the **ARS**, you may set the direction of the repeater shift manually.





To set repeater shift manually:

1. Press the  **SET** key momentarily to enter the **Set** mode.
2. Rotate the  **DIAL** knob to select **Menu #33** RPT. MOD.
3. Press the  **DIAL** knob momentarily, then rotate the  **DIAL** knob to select the desired shift from -, +, and OFF.
4. Press and hold in the  **DIAL** knob for ½ second to save the new setting and exit to normal operation.

Changing the Default Repeater Shifts

If you travel to a different region, you may need to change the default repeater shift so as to ensure compatibility with local operating requirements.

To do this, follow the procedure below:

1. Press the  **SET** key momentarily to enter the **Set** mode.
2. Rotate the  **DIAL** knob to select **Menu #36** SHIFT.
3. Press the  **DIAL** knob momentarily, then rotate the  **DIAL** knob to select the new repeater shift magnitude.
4. Press and hold in the  **DIAL** knob for ½ second to save the new setting and exit to normal operation.







If you just have one odd split that you need to program, don't change the default repeater shifts using this **Menu** item. Enter the transmit and receive frequencies separately, as shown in **Store Independent Transmit Frequencies** on page 34.

Tone Coded Squelch

CTCSS Tone System





Many repeater systems require that a very-low-frequency audio tone be superimposed on your FM carrier in order to activate the repeater. This helps prevent false activation of the repeater by radar or spurious signals from other transmitters. This tone system, called **CTCSS** (Continuous Tone Coded Squelch System), is included in your **FT-8900R**, and is very easy to activate.

CTCSS setup involves two actions: Setting the **Tone Mode** and then setting of the **Tone Frequency**. These actions are set up by using the **Set mode Menu #40** TONE M and **Menu #39** TONE F.

1. Press the  **SET** key momentarily to enter the **Set** mode.
2. Rotate the  **DIAL** knob to select **Menu #40** TONE M.
3. Press the  **DIAL** knob momentarily, then rotate the  **DIAL** knob so that **ENC** appears on the display; this activates the **CTCSS Encoder**, which allows repeater access.



You may notice an additional **DCS** icon appearing while you rotate the  **DIAL** knob in this step. (See **DCS Tone System** on page 28.)

4. Rotating the  **DIAL** knob one more click clockwise in step 3 above will cause **ENC.DEC** to appear. When **ENC.DEC** appears, this means that the **Tone Squelch** system is active, which mutes your **FT-8900R**'s receiver until it receives a call from another radio sending out a matching **CTCSS** tone. This can help keep your radio quiet until a specific call is received, which may be helpful while operating in congested areas.
5. When you have made your selection of the **CTCSS** tone mode, press the  **DIAL** knob momentarily, then rotate the  **DIAL** knob one click counterclockwise to select **Menu #39** TONE F. This Menu selection allows setting of the **CTCSS** tone frequency to be used.
6. Press the  **DIAL** knob momentarily to enable adjustment of the **CTCSS** frequency.

7. Rotate the **MAIN** DIAL knob until the display indicates the **Tone Frequency** you need to be using.

CTCSS TONE FREQUENCY (Hz)									
67.0	69.3	71.9	74.4	77.0	79.7	82.5	85.4	88.5	91.5
94.8	97.4	100.0	103.5	107.2	110.9	114.8	118.8	123.0	127.3
131.8	136.5	141.3	146.2	151.4	156.7	159.8	162.2	165.5	167.9
171.3	173.8	177.3	179.9	183.5	186.2	189.9	192.8	196.6	199.5
203.5	206.5	210.7	218.1	225.7	229.1	233.6	241.8	250.3	254.1

8. When you have made your selection, press and hold in the **MAIN** DIAL knob for ½ second to save the new setting and exit to normal operation.



(1) Your repeater may or may not re-transmit a **CTCSS** tone—some systems just use **CTCSS** to control access to the repeater, but don't pass it along when transmitting. If the S-Meter deflects, but the **FT-8900R** is not passing audio, repeat steps 1 through 4 above, but rotate the **MAIN** DIAL knob so that **ENC** is displayed—this will allow you to hear all traffic on the channel being received.

(2) You may select the **Tone Squelch** mode (**ENC**, **ENC . DEC**, or **DCS**) on the **Main** band using the microphone's **P4** key.

DCS Tone System

Another form of tone access control is **Digital Code Squelch (DCS)**. It is a newer, more advanced tone system which generally provides more immunity from false paging than does **CTCSS**. The **DCS Encoder/Decoder** is built into your **FT-8900R**, and operation is very similar to that just described for **CTCSS Tone System** on page 27. Your repeater system may be configured for **DCS**; if not, it is frequently quite useful in Simplex operation if your friend(s) use transceivers equipped with this advanced feature.

Just as in **CTCSS** operation, **DCS** requires that you set the **Tone Mode** to **DCS** and that you select a tone code.

1. Press the **SET** key momentarily to enter the **Set** mode.
2. Rotate the **MAIN** DIAL knob to select **Menu #40** TONE M.
3. Press the **MAIN** DIAL knob momentarily, then rotate the **MAIN** DIAL knob until **DCS** appears on the display; this activates the **DCS Encoder/Decoder**.

4. Now, press the **MAIN** DIAL knob momentarily, then rotate the **MAIN** DIAL knob to select **Menu #10** DCS .COD.
5. Press the **MAIN** DIAL knob momentarily to enable the adjustment of the **DCS** code.
6. Rotate the **MAIN** DIAL knob to select the desired **DCS Code** (a three-digit number).

DCS CODE										
023	025	026	031	032	036	043	047	051	053	054
065	071	072	073	074	114	115	116	122	125	131
132	134	143	145	152	155	156	162	165	172	174
205	212	223	225	226	243	244	245	246	251	252
255	261	263	265	266	271	274	306	311	315	325
331	332	343	346	351	356	364	365	371	411	412
413	423	431	432	445	446	452	454	455	462	464
465	466	503	506	516	523	526	532	546	565	606
612	624	627	631	632	654	662	664	703	712	723
731	732	734	743	754						

7. When you have made your selection, press and hold in the **MAIN** DIAL knob for ½ second to save the new setting and exit to normal operation.



(1) Remember that the **DCS** is an Encode/Decode system, so your receiver will remain muted until a matching **DCS** code is received on an incoming transmission. Switch the **DCS** off when you're just tuning around the band.

(2) You may select the **DCS** mode on the **Main** band using the microphone's **P4** key.







Tone Search Scanning

In operating situations where you don't know the **CTCSS** or **DCS** tone being used by another station or stations, you can command the radio to listen to the incoming signal and scan in search of the tone being used.

Two things must be remembered in this regard:

- You must be sure that your repeater uses the same tone type (**CTCSS** or **DCS**).
- Some repeaters do not pass the **CTCSS** tone; you may have to listen to the station(s) transmitting on the repeater uplink (input) frequency in order to allow **Tone Search Scanning** to work.

To scan for the tone in use:

1. Set the radio up for either **CTCSS Tone System** (see page 27) or **DCS Tone System** (see page 28) operation. In the case of **CTCSS**, **ENC DEC** will appear on the display; in the case of **DCS**, **DCS** will appear on the display.
2. Press the  **SET** key momentarily to enter the **Set** mode.
3. Rotate the  **DIAL** knob to select **Menu #39** TONE F when **CTCSS** is selected, or **Menu #10** DCS .COD during **DCS** operation.
4. Press the  **DIAL** knob to enable adjustment of the selected **Menu** Item.
5. Press the **Main** band  key momentarily to start scanning for the incoming **CTCSS** or **DCS** tone/code.
6. When the radio detects the correct tone or code, it will halt on that tone/code, and audio will be allowed to pass. Press the  **DIAL** knob momentarily to lock in that tone/code, then press and hold in the  **DIAL** knob for ½ second to save the new setting and exit to normal operation.



(1) If the **Tone Scan** feature does not detect a tone or code, it will continue to scan indefinitely. When this happens, it may be that the other station is not sending any tone. You can press the **Main** band  key to halt the scan at any time.

(2) **Tone Search Scanning** works either in the **VFO** or **Memory** modes.

DCS Code Inversion

The **DCS** system was first introduced in the commercial **LMR (Land Mobile Radio)** service, where it is now in widespread use. **DCS** is sometime referred to by its different proprietary names, such as **DPL® (Digital Private Line®)**, a registered trademark of Motorola, Inc.).

DCS uses a codeword consisting of a 23-bit frame, transmitted (subaudible) at a data rate of 134.4 bps (bit/sec). Occasionally, signal inversion can result in the complement of a code to be sent or received. This prevents the receiver squelch from opening with **DCS** enabled, as the decoded bit sequence would not match that selected for the operation.





Typical situations that might cause inversion to occur are:

- Connection of an external receiver preamplifier
- Operating through a repeater
- Connection of an external linear amplifier

Note that code inversion does not mean that any of the above listed equipment is defective.

In certain amplifier configurations, the output signal (phase) is inverted from the input. Small signal or power amplifiers having an odd number (1, 3, 5, etc.) of amplification stages may result in inversion of a transmitted or received **DCS** code.

While under most circumstances this should not occur (amplifier designs and industry standards take this into account), if you find that your receiver squelch does not open when both you and the other station are using a common **DCS** code, you or the other station (but not both) can try the following:

1. Press the  **SET** key momentarily to enter the **Set** mode.
2. Rotate the  **DIAL** knob to select **Menu #11** DCS .N/R.
3. Press the  **DIAL** knob momentarily, then rotate the  **DIAL** knob to select the mode:
 - TRX N : Encoder; Normal, Decoder; Normal
 - RX R : Encoder; Normal, Decoder; Reverse (Inverted)
 - TX R : Encoder; Reverse (Inverted), Decoder; Normal
 - TRX R : Encoder; Reverse (Inverted), Decoder; Reverse (Inverted)
4. Press and hold in the  **DIAL** knob for ½ second to save the new setting and exit to normal operation.



Remember to restore the default setting to TRX N (Encoder; Normal, Decoder; Normal) when done.

Regular Memory

Overview

The FT-8900R provides a wide variety of memory system resources. These include:

Independent **Regular Memory Channels** consisting of:



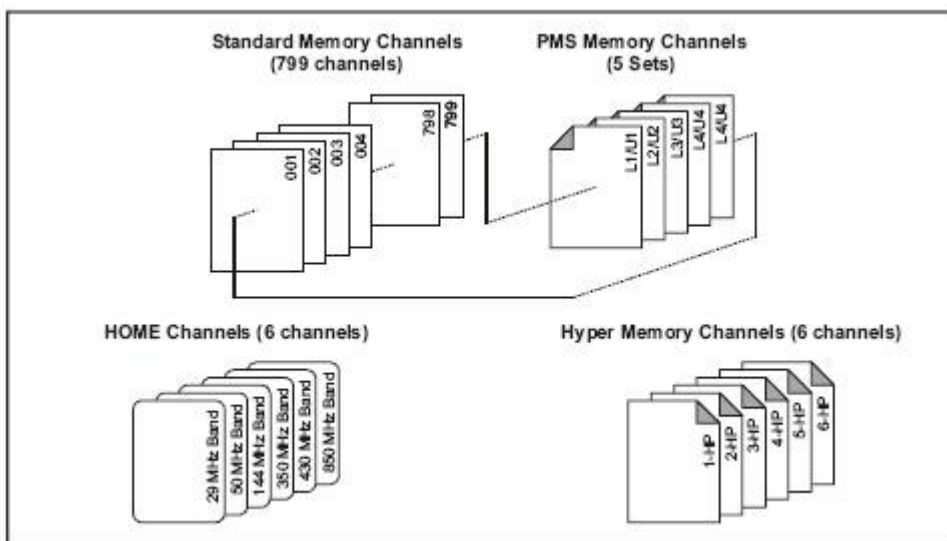

- 799 **Standard Memory** channels (see page 32), numbered 001 through 799
- Six **Home** channels (see page 36), providing storage and quick recall of one prime frequency on each operating band
- Five sets of band-edge memories also known as **Programmable Memory Scan** channels (see page 23), labeled L1/U1 through L50/U5
- Six **Hyper Memory** channels (see page 38)



Store a Frequency in Memory









To store a frequency in a memory channel:

1. Select the desired frequency while operating in the **VFO** mode on the **Main** band. Be sure set up any desired **CTCSS** or **DCS** tones, as well as any desired repeater offset. The power level may also be set at this time, if you wish to store it.
2. Press and hold in the **SET** key for ½ second. A memory number will appear (blinking) on the display.









3. Within ten seconds of pressing the  **SET** key, use the  **MAIN DIAL** knob, or the microphone's  **UP** and  **DWN** buttons, to select the desired memory channel for storage. If the channel is already occupied by data stored previously, the channel's frequency will appear on the display.
4. Press the  **SET** key momentarily to save the entry and exit to normal operation.

Create a Name Tag for a Memory Channel

To add an Alpha-numeric Name Tag to a memory:

1. Press the  **SET** key momentarily to enter the **Set** mode.
2. Rotate the  **MAIN DIAL** knob to select **Menu #25** NAME.
3. Press the  **MAIN DIAL** knob momentarily to select the first character location. The character at this location will blink.
4. Rotate the  **MAIN DIAL** knob to select the alpha-numeric character you wish to store in the blinking location, then press the  **MAIN DIAL** knob momentarily to move on to the next character.
5. Again rotate the  **MAIN DIAL** knob to select the desired letter, number, or symbol, then press the  **MAIN DIAL** knob momentarily to move on to the next character location. If you make a mistake, press the microphone's  **DWN** button to move back to the previous character slot, then re-select the correct letter, number, or symbol.
6. Repeat step 5 to program the remaining letters, numbers, or symbols of the desired **Name Tag**. A total of six characters may be used in the creation of a tag.
7. When you have completed the creation of the **Name Tag**, press and hold in the  **SET** key momentarily to save the tag and exit to normal operation.

To modify an Alpha-numeric Name Tag for a memory:

1. Press the  **SET** key momentarily to enter the **Set** mode.
2. Rotate the  **MAIN DIAL** knob to select **Menu #25** NAME.
3. Press the  **MAIN DIAL** knob momentarily to display the **Name Tag**.
4. Press the  **MAIN DIAL** knob momentarily to select the first character location. The character at this location will blink.
5. Press the microphone's  **UP** and  **DWN** buttons to move to the character location you want to modify, rotate the  **MAIN DIAL** knob to select the alpha-numeric character you wish to store in the blinking location, then press the  **MAIN DIAL** knob momentarily to move on to the next character location.







6. Repeat step 5 to modify the remaining letters, numbers, or symbols of the desired **Name Tag**.
7. When you have completed the modification of the **Name Tag**, press and hold in the  **SET key** momentarily to save the tag and exit to normal operation.

To delete/hide an Alpha-numeric Name Tag for a memory:

The only way to manually delete a **Name Tag** from a **Memory** channel is to delete the channel then re-enter it without the tag.

Store Independent Transmit Frequencies

To store independent transmit frequencies (odd splits) in a memory channel:

1. Store the receiving frequency using the instructions described in *Store a Frequency in Memory* on page 32.
2. Turn to the desired transmit frequency on the **Main** band, then press and hold in the  **SET key** for ½ second.
3. Within ten seconds of pressing the  **SET key**, use the  **MAIN DIAL knob** or microphone's  **UP** and  **DWN** buttons to select the same memory channel number as used in step 1 above.
4. Press and hold in the **PTT** switch, then press the  **SET key** momentarily while holding the **PTT** switch to save the entry and exit to normal operation. (This will not cause transmission; instead, it signals the microprocessor that a separate transmit frequency is being programmed into that memory register.)



Whenever you recall a memory which contains independently-stored transmit and receive frequencies, the  (odd split) indicator will be displayed.

Recall a Stored Memory

To recall (activate) a stored memory channel:



1. If operating in the **VFO** mode, press the  key momentarily to enter the **Memory** mode.
2. Rotate the **DIAL** knob to select the desired channel.



When the radio is already set to the Memory mode, an easy way to recall memories is enter the three-digit memory channel number from the **MH-48A6J** microphone's keypad. For example, to recall memory channel #4, press 0 → 0 → 4.

Tune from a Stored Memory

Once you have recalled a particular memory channel, you may easily tune off that channel, as though you were in the **VFO** mode.





1. With the **FT-8900R** in the **MR (Memory Recall)** mode, select the desired memory channel.
2. Now press and hold in the  key for ½ second. The **MT (Memory Tune mode)** icon will appear on the display.
3. Rotate the **DIAL** knob to tune to a new frequency. The synthesizer steps selected for **VFO** operation on the current band will be the steps used during Memory Tuning.
4. Press and hold in the  key for ½ second during **Memory Tuning**, the data will be copied to **VFO**, although the original memory contents will remain intact on the previously-stored channel.



If you wish to return to the original memory frequency, press the  key momentarily. The **MT** icon will disappear.

Delete a Memory

With 808 memories available (except memory channel #1), there are frequently situations where you may desire to delete certain memorized frequencies. The procedure for deleting a channel is quite simple:



1. If operating in the **VFO** mode, press the  key momentarily to enter the **Memory** mode.
2. Press and hold in the  **SET** key for ½ second, then rotate the  **MAIN** **DIAL** knob to select the memory channel to be deleted. (Note that memory channel #1 may not be deleted.)
3. Press the **Main** band  key momentarily. The display will revert to memory channel #1. If you rotate the  **MAIN** **DIAL** knob to the location you just **Masked**, you will observe that it is now invisible.



Once deleted, the channel data cannot be recovered.

Set a HOME Channel for an Operating Band

A special one-touch **HOME** channel is available (one for each of the six operating bands), to allow quick recall of a favorite operating frequency on each band. To store a **HOME** channel:

1. Select the desired frequency while operating in the **VFO** mode on the **Main** band. Be sure to set up any desired **CTCSS** or **DCS** tones, as well as any desired repeater offset. The power level may also be set at this time.
2. Press and hold in the  **SET** key for ½ second. A memory number will appear (blinking) on the display.
3. While the memory channel number is blinking, press the   key. The frequency and other data will now be stored in the special **HOME** channel register.



You may repeat this process on the other operating bands.

To recall the **HOME** channel, just press the  key while operating either in the **VFO** or **Memory** mode.

Activate Memory Only Mode

Once **Memory** channel programming has been completed, you may place the radio in a **Memory Only** mode, whereby **VFO** operation is impossible. This may be particularly useful during public-service events where a number of operators may be using the radio for first time, and ultimate simplicity of channel selection is desired.

To place the radio into the **Memory Only** mode:

1. Turn the radio off.
2. Press and hold in the Left  key while turning the radio on.
3. Rotate the Right **DIAL** knob to select the (F-5 M-ONLY MODE), then press the  **SET** key momentarily.

To return to normal operation, repeat the above steps.

Hyper Memory

Overview

The **FT-8900R** uses two different types of memory systems, **Regular Memory** (see page 32) and **Hyper Memory**, that store different kinds of information. The distinction between these two memory systems is one of the most difficult concepts for users to comprehend.

The **Regular Memory** is a memory system that stores information specific to a memory channel. For example, the information needed to operate on a particular repeater will be stored in a **Regular Memory** channel. The **FT-8900R** contains 799 **Regular Memory** channels. (See the table below for the types of data that are stored in a **Regular Memory** channel.)

The **Hyper Memory** is a memory system that stores information specific to the overall configuration of your **FT-8900R**. That is, a **Hyper Memory** records, or is a snapshot of, the way you have set up your **FT-8900R** to operate and meet your communication needs. For most radios, you can only have one configuration setup. However, the **FT-8900R** has six **Hyper Memory** channels thus allowing you to set up six unique configurations. (See the table below for the types of data that are stored in a **Hyper Memory** channel.)

REGULAR MEMORY Storage <i>memory channel information</i>	HYPER MEMORY Storage <i>radio configuration information</i>
<p><i>Each Regular Memory channel contains the information for one frequency on which you want to operate .</i></p> <ul style="list-style-type: none"> • Memory channel number (left/right) • Receive/Transmit frequencies • Operating mode (AM, FM, NFM) • Repeater information (shift, offset, encoding method, CTCSS tone, DCS code) • Whether to display frequency or name tag • Transmitting power • Scan/Skip preference • Hyper Memory assignments 	<p><i>Each Hyper Memory channel contains a set of information on how you operate your FT-8900R.</i></p> <ul style="list-style-type: none"> • Which Memory channels to include • ARS (activation/deactivation) • Band edge criteria • Sub band display format • Packet information (Baud rate, operating band) • Band Linking (Off, On) • Automatically tune AM for Aircraft band (Off, On) • Default Operating mode for each side (VFO, Memory, Home) • Active band (left/right) • Which Memory channel to default to (left/right) • Which is the Active side: Main band (left or right)

Some examples of using Hyper Memory

Let's say that you frequently monitor the local HAM repeaters in your area, that you belong to the RACES organization for your county, and that you like to work Amateur Radio satellites. You could set up your **Hyper Memory** channels as follows:

Hyper Memory Channel 2 Use to operate on local HAM repeaters

Left Side -- start on **Regular Memory** channel 39
-- use as **Sub** band
-- **Memory** mode (only UHF repeaters)
-- 430MHz band (when in **VFO** mode)

Right Side -- start on **Regular Memory** channel 1
-- use as **Main** band
-- **Memory** mode (only VHF repeaters)
-- 144MHz band (when in **VFO** mode)

Hyper Memory Channel 3 Use to operate on local RACES/ARES/Skywarn repeaters

Left Side -- start on **Regular Memory** channel 1
-- use as **Sub** band
-- **Memory** mode (all local, VHF/UHF HAM repeaters)
-- 430MHz band (when in **VFO** mode)

Right Side -- start on **Regular Memory** channel 501
-- use as **Main** band
-- **Memory** mode (only RACES/ARES/Skywarn repeaters)
-- 144MHz band (when in **VFO** mode)

Hyper Memory Channel 4 Use to operate on Amateur Radio satellites
(**Band Linking** feature activated)

Left Side -- start on **Regular Memory** channel 301
-- use as **Main** band
-- **Memory** mode (only Amateur Radio satellite frequencies)
-- 430MHz band (when in **VFO** mode)

Right Side -- start on **Regular Memory** channel 301
-- use as **Sub** band
-- **Memory** mode (only Amateur Radio satellite frequencies)
-- 144MHz band (when in **VFO** mode)

With this setup, you would be ready for three of your HAM radio interests at the press of a button! You now have three complete and unique radio configurations, each catered to a specific need.

- To operate on the local HAM repeaters you will press **Hyper Memory** key **2**.
- If a RACES activation occurs, you will press **Hyper Memory** key **3**.
- When you get ready to work an Amateur Radio satellite, you will press **Hyper Memory** key **4**.

Store a Hyper Memory

To store the current radio configuration into a **Hyper Memory**:

1. Set up the transceiver according to the desired configuration.
2. Press and hold in a **Hyper Memory** key (**1** through **6**) for 2 seconds. The current configuration will be stored in this **Hyper Memory** channel.

Recall a Hyper Memory





To recall (activate) a **Hyper Memory**:

Press the appropriate **Hyper Memory** key ( through ) momentarily to recall the desired **Hyper Memory** channel.

Caution

Depending on how **Menu #16** (HYPER) is configured, your current configuration might be lost when you recall a **Hyper Memory** channel. **Menu #16** (HYPER) is the **Automatic Writing** feature for **Hyper Memory**. It has two possible settings: AUTO and MANUAL.

AUTO

If set to AUTO, whenever you recall a **Hyper Memory** ( through ) the current configuration for your **FT-8900R** will be automatically stored in **Hyper Memory** channel . Any configuration already in **Hyper Memory** channel  will be overwritten.

This setting is **NOT** recommended if you want to preserve all of your **Hyper Memories**.

MANUAL

If set to MANUAL, recalling a **Hyper Memory** will **not** cause **Hyper Memory** channel  to be overwritten. The Auto feature is disabled, so you must manually store a configuration into a **Hyper Memory** channel by pressing and holding in one of the **Hyper Memory** keys for two seconds.

This setting **IS** recommended if you want to preserve all of your **Hyper Memories**.

Scanning

Overview

The **FT-8900R** allows you to scan just the Memory channels via **Memory Scan Mode** (see page 45), the entire operating band in **VFO Scan Mode** (see page 44), or a portion of that band via **Programmable Memory Scan** (see page 23). It will pause on signals encountered, so you can monitor the station(s) on that frequency.

Scanning operation is basically the same in each of the above modes. Before you begin, take a moment to select the way in which you would like the **FT-8900R** to resume scanning after it pauses on a signal.





Set the Scan-Resume Preference

Two options for the **Scan-Resume** mode are available:

TIME In this mode, scanning will pause on a signal it encounters, and will hold there for five seconds. If you do not take action to disable scanning within five seconds, scanning will resume even if the stations are still active. This is the default setting.

BUSY In this mode, scanning will pause on a signal it encounters. Two seconds after the carrier has dropped, scanning will resume.

To set the **Scan-Resume** mode:

1. Press the  **SET** key momentarily to enter the **Set** mode.
2. Rotate the  **DIAL** knob to select **Menu #34** SCAN.
3. Press the  **DIAL** knob momentarily, then rotate the  **DIAL** knob to select the desired **Scan-Resume** mode (**TIME** or **BUSY**).
4. Press and hold in the  **DIAL** knob for ½ second to save the new setting and exit to normal operation.

Priority Channel Scanning (Dual Watch)



The **FT-8900R**'s scanning features include a two-channel scanning capability which allows you to operate on a **VFO**, **Memory** channel, or **Home** channel, while periodically checking a user-defined **Priority Memory Channel** for activity. If a station is received on the **Priority Memory Channel** which is strong enough to open the Squelch, the scanning will pause on that

station. Scanning will resume according to the **Scan-Resume** mode that was selected. See **Set the Scan-Resume Preference** on page 42 for details.

You may operate individual **Priority Channel Dual Watch** features on both bands at the same time, such as having the **VFO Priority** mode engaged on the Right band and the **Memory Priority** mode engaged on the Left band.



VFO Priority

To activate **Priority Channel Dual Watch** operation:

1. Recall the memory channel you wish to use as the **Priority** frequency.
2. Now set the **FT-8900R** for operation on a **VFO** frequency.
3. Press and hold in the  key for ½ second to activate the **VFO Priority** mode. The display will remain on the **VFO** frequency, but every five seconds the **FT-8900R** will check the **Priority Memory Channel** for activity.
4. Press and hold in the  key to disable the **VFO Priority** mode.



Memory Priority

To activate **Priority Channel Dual Watch** operation:

1. Store the frequency you wish to be the **Priority Memory Channel** into **Memory** channel 1.
2. Now set the **FT-8900R** for operation on another **Memory** channel.
3. Press and hold in the  key for ½ second to activate the **Memory Priority** mode. The display will remain on the current **Memory** channel, but every five seconds the **FT-8900R** will check the **Priority Memory Channel** (**Memory** channel 1) for activity.
4. Press and hold in the  key to disable the **Memory Priority** mode.



HOME Priority

To activate **Priority Channel Dual Watch** operation:

1. Recall the **Memory** channel you wish to use as the **Priority** frequency.
2. Now set the **FT-8900R** for operation on a **HOME** channel.
3. Press and hold in the  key for ½ second to activate the **HOME Priority** mode. The display will remain on the **HOME** channel, but every five seconds the **FT-8900R** will check the **Priority Memory Channel** for activity.
4. Press and hold in the  key to disable the **HOME Priority** mode.

Scan in VFO Mode

This mode allows you to scan the entire current operating band.

1. Select the **VFO** mode by pressing the  key, if necessary.
2. Press the  key momentarily to start scanning.





If a signal strong enough to open the squelch is encountered during scanning, scanning will pause temporarily and the decimal point of the frequency will blink during the pause.

- Scanning will resume according to the **Scan-Resume** mode that was selected. See **Set the Scan-Resume Preference** on page 42 for details.
3. To cancel scanning, press the  key momentarily again, or press the microphone's **PTT** key.



(1) When you start scanning, the **FT-8900R** will scan in the upward direction. If you want to change the direction of the scan while it is underway, rotate the **DIAL** knob one click in the opposite direction (in this case, one click counterclockwise). The scanning direction will reverse and scan downward.

(2) Pressing and holding in the microphone's  or  key will cause scanning to sweep frequencies only on the current band.

(3) If you would like the scanner not to be restricted to the current band, set **Menu #4 (BAND)** to **BND.OFF** to cause the **FT-8900R** to hop to the low edge of the next-highest band when the **VFO** frequency reaches the high end of the current band (or vice-versa).

Scan in Memory Mode

In **Memory Scan** mode, you can set the type of scan to be performed and set the method in which each Memory channel will be scanned.

Set the Type of Memory Scan

You can configure the  keys on the **FT-8900R** to perform either a **Standard Memory** scan (default) or a **Preferential Memory** scan when pressed.

Types of Memory Scans	
Standard (default)	<p>All Memory channels not flagged to be skipped (SKIP) will be scanned.</p> <p>Set Menu #35 (SCAN M) to MEM for Standard Memory scan</p> <p>See</p> <p>Standard Memory Scan on page 46 for details.</p>
Preferential	<p>Only Memory channels flagged as Preferential will be scanned.</p> <p>Set Menu #35 (SCAN M) to MSM for Preferential Memory scan.</p> <p>See Preferential Memory Scan on page 47 for details.</p>

Standard Memory Scan

During **Standard Memory Scan**, scanning will pause on any signal encountered that is strong enough to open the squelch; scanning will then resume according to the **Scan-Resume** mode that was selected. See **Set the Scan-Resume Preference** on page 42 for details.

To Flag a Memory channel to be Scanned during Standard Memory Scan:



This is the default setting, so you only need to complete these steps if you previously changed this setting for this **Memory** channel.

1. Set the radio to the **Memory** mode by pressing the **V/M** key, if necessary.
2. Rotate the **MAIN DIAL** knob to select the channel which you wish to be scanned during **Standard Memory Scan**.
3. Press the **SCN** key for ½ second twice to select **OFF** (skip off) and exit to normal operation.

To configure the FT-8900R for Standard Memory Scan:



This is the default setting, so you only need to complete these steps if you previously changed this setting. This setting is stored separately for each side of each **Hyper Memory** channel (see page 38).

1. Press the **SET** key momentarily to enter the **Set** mode.
2. Rotate the **MAIN DIAL** knob to select **Menu #35** SCAN M.
3. Press the **MAIN DIAL** knob momentarily, then rotate the **DIAL** knob to **MEM**.
4. Press and hold in the **MAIN DIAL** knob for ½ second to save the new setting and exit to normal operation.



To initiate Standard Memory Scan:

1. Configure the **FT-8900R** for **Standard Memory Scan**, if necessary.
2. Press the **SCN** key momentarily to initiate **Standard Memory Scanning**.
3. To cancel the **Standard Memory Scan**, press the **SCN** key momentarily.

How to Skip a Channel During Memory Scan

Some continuous-carrier stations like a **Weather Broadcast** station will seriously impede scanning operation especially if **Menu #34** SCAN is set to **BUSY**, as the incoming signal will not pause long enough for the **FT-8900R** to resume scanning.

To skip a channel during scanning:





1. Set the radio to the **Memory** mode by pressing the  key, if necessary.
2. Rotate the  **DIAL** knob to select the **Memory Channel** to be skipped during scanning.
3. Press the  key for ½ second to select **SKIP** and exit to normal operation.

This **Memory Channel** will now be ignored during scanning. The **SKIP** indicator will appear when you manually recall this skipped memory channel.

Preferential Memory Scan

During **Preferential Memory Scan**, scanning will pause on any signal encountered that is strong enough to open the squelch; scanning will then resume according to the **Scan-Resume** mode that was selected. See **Set the Scan-Resume Preference** on page 42 for details.



To place a Memory channel on the Preferential Scan List:

1. Set the radio to the **Memory** mode by pressing the  key, if necessary.
2. Rotate the  **DIAL** knob to select the channel which you wish to add to the **Preferential Scan List**.
3. Press and hold the  key for ½ second, several times if necessary, so as to make the  icon appear by the channel designator.

To configure the FT-8900R for Preferential Memory Scan:



This setting is stored separately for each side of each **Hyper Memory** channel (see page 38).

1. Press the  **SET** key momentarily to enter the **Set** mode.
2. Rotate the  **DIAL** knob to select **Menu #35** SCAN M.
3. Press the  **DIAL** knob momentarily, then rotate the **DIAL** knob to **MSM**.

4. Press and hold in the **MAIN** **DIAL** knob for ½ second to save the new setting and exit to normal operation.

Now only the channels which have the ◀ icon displayed will be scanned.

To initiate Preferential Memory Scan:

1. Configure the **FT-8900R** for **Preferential Memory Scan**, if necessary.
2. Press the **SCN** key momentarily to initiate **Preferential Memory Scanning**. Only the channels which have the ◀ icon displayed will be scanned.

To cancel the **Preferential Memory Scan**, press the **SCN** key momentarily.



Smart Search



The **Smart Search** feature may be used to load—automatically with no operator intervention—a special bank of up to 25 memory channels (per band) on activity.

The **Smart Search** function will sweep the entire band, and will load the special memory bank with the frequency and repeater shift data pertaining to those channels on which activity is found if Automatic Repeater Shifts is activated (see page 25). The channels are loaded in the order in which they are encountered, not according to signal strength or by ascending frequency.

The **Smart Search** feature is especially useful when visiting a city for the first time, where you may be unfamiliar with the repeater frequencies; **Smart Search** discovers where the local activity is to be found, and automatically loads those frequencies for you.

To activate **Smart Search** operation :

1. Set the radio to the **VFO** mode by pressing the  key, if necessary.
2. Press and hold in the  key for ½ second to cause the radio to scan upward on the current band, loading channels on which it encounters a signal strong enough to open the squelch.
3. When 25 channels are loaded, or when the scanner reaches the band edge, the scanner will stop and the transceiver will revert to the starting frequency.

To recall the **Smart Search** memories just stored, rotate the **DIAL** knob or press the microphone's  or  keys (for the **Main** band **Smart Search** memories only).

If you find a channel which you wish to store into a Regular Memory channel, follow the procedures in **Store a Frequency in Memory** on page 32.



- (1) The **Smart Search** memories are so-called soft memories; they will lost if you exit the **Smart Search** mode or initiate a new **Smart Search** sweep.
- (2) You may activate **Smart Search** operation on the **Main** band by pressing and holding in the microphone's  key.
- (3) You may activate **Smart Search** operation on the left and right bands at the same time.

ARTS

Overview

The **ARTS** (Auto Range Transponder System) feature uses **DCS** signaling to inform both parties when you and another **ARTS** equipped station are within communications range. This may be particularly useful during Search-and-Rescue situations, where it is important to stay in contact with other members of your group.

Both stations must set up their **DCS** codes to the same code number, then activate their **ARTS** feature using the command appropriate for their radio. Alert ringers may be activated, if desired.

Whenever you push the **PTT** switch, or every 25 seconds after **ARTS** is activated, your radio will transmit a signal which includes a (subaudible) **DCS** signal for about one second. If the other radio is in range, the beeper will sound (if enabled) and the display will show **IN.RNG** as opposed to the out of range display **OUT.RNG** in which **ARTS** operation begins.





Whether you talk or not, the polling every 25 seconds will continue until you de-activate **ARTS**. Every 10 minutes, moreover, you can have your radio transmit your callsign via **CW**, so as to comply with identification requirements. When **ARTS** is de-activated, **DCS** will also be deactivated (if you were not using it previously in non-**ARTS** operation).

If you move out of range for more than one minute (four pollings), your radio will sense that no signal has been received, three beeps will sound, and the display will revert to **OUT.RNG**. If you move back into range, your radio will again beep, and the display will change back to the **IN.RNG** indication.

During **ARTS** operation, it is not possible to change the operating frequency or other settings on the **Main** band; you must terminate **ARTS** in order to resume normal operation. This is a safety feature designed to prevent accidental loss of contact due to channel change.

Set Up/Operate ARTS

To activate ARTS:

1. Set your **FT-8900R** and the other radio(s) to the same **DCS** code number. See **DCS Tone System** on page 28 for details.
2. Press the  **SET** key momentarily to enter the **Set** mode.
3. Rotate the  **DIAL** knob to select **Menu #3** **ARTS**.
4. Press the  **DIAL** knob momentarily, then rotate the  **DIAL** knob to select the desired **ARTS** beep option. The available options are:

- **IN .RNG:** The beeps are issued only when the radio first confirms that you are within range, but does not re-confirm with beeps thereafter.
 - **ALWAYS:** Every time a polling transmission is received from the other station, the alert beeps will be heard.
5. Press the **MAIN** **DIAL** knob momentarily. **OUT .RNG** is displayed on the LCD. **ARTS** operation has now commenced.

Every 25 seconds, your radio will transmit a polling call to the other station. When that station responds with its own **ARTS** polling signal, the display will change to **IN .RNG** to confirm that the other station's polling code was received in response to yours.

Press the **MAIN** **DIAL** knob momentarily to exit **ARTS** operation and resume normal operation.

Set Up the CW Identifier

The **ARTS** feature includes a **CW Identifier**. Every ten minutes during **ARTS** operation, the radio can be instructed to send **DE your-callsign K** if this feature is enabled. The callsign field may contain up to 6 characters.

To program the **CW Identifier**:















1. Press the **SET** key momentarily to enter the **Set** mode.
2. Rotate the **MAIN** **DIAL** knob to select **Menu #8** **CWID W**.
3. Press the **MAIN** **DIAL** knob momentarily.
4. Press the **MAIN** **DIAL** knob momentarily again to enable entry of your callsign.
5. Rotate the **MAIN** **DIAL** knob one click clockwise to begin entry of the letters and numbers in your callsign.
6. Press the **MAIN** **DIAL** knob momentarily to set the first letter or number in your callsign.
7. When the correct character has been selected, press the **MAIN** **DIAL** knob momentarily to move on to the next character.
8. Repeat steps 6 and 7 as many times as necessary to complete your callsign.
9. Press the **Main** **SCN** key to delete all data after the cursor that may have been previously stored (erroneously).
10. When you have entered your entire callsign, press the **MAIN** **DIAL** knob momentarily to confirm the callsign.
11. Press the **SET** key momentarily, then rotate the **MAIN** **DIAL** knob one click counter-clockwise to select the **Menu #7** **CWID**.

12. Press the **MAIN** **DIAL** knob momentarily, then rotate the **MAIN** **DIAL** knob to select TX ON (to enable the **CW Identifier**).
13. Press the **MAIN** **DIAL** knob momentarily to save the setting and exit to normal operation.





Operating the DTMF Autodialer

Sixteen **DTMF Autodialer** memories are available on the **FT-8900R**. These **DTMF Autodialer** memories can store up to 16 digits of a telephone number for repeater autopatch or other uses.

To load DTMF Autodialer memories:

1. Press the  **SET key** momentarily to enter the **Set** mode.
2. Rotate the  **DIAL knob** to select **Menu #15** DTMF W.
3. Press the  **DIAL knob** momentarily, then rotate the  **DIAL knob** to select the **DTMF Autodialer** memory channel number ($d-1$ through $d-16$) into which you wish store a telephone number.
4. Press the  **DIAL knob** momentarily, then rotate the  **DIAL knob** to select the first digit of the telephone number you wish to store.
5. When you have selected the correct digit, press the  **DIAL knob** momentarily.
6. Rotate the  **DIAL knob** to select the next number in this current **DTMF Autodialer** memory register.
7. When you have selected the correct digit, press the  **DIAL knob** momentarily.
8. Repeat this steps 6 and 7 for each remaining digit in the telephone number.
9. Press the **Main** band  **key** momentarily to delete any previously-stored data after the cursor. If you make a mistake, press the microphone's  **key** to move back to the first digit, then re-enter the correct number.
10. When entry of all digits is complete, press the  **SET key** momentarily to save the new setting.
11. If you wish to store another **DTMF** string, rotate the  **DIAL knob** to select another **DTMF** memory register, then repeat steps 4 through 10.
12. When all required **DTMF** memories are filled to your satisfaction, press and hold in the  **DIAL knob** for ½ second to exit to normal operation.

To transmit the memorized telephone number:

1. Press the  **SET key** momentarily to enter the **Set** mode.
2. Rotate the  **DIAL knob** to select **Menu #15** DTMF W.
3. Press the  **DIAL knob** momentarily, then rotate the  **DIAL knob** to select the **DTMF Autodialer** memory channel to be transmitted.

4. Press and hold in the **MAIN** DIAL knob for ½ second to exit to normal operation.
5. Press and hold in the PTT switch.
6. While still holding the PTT switch in, press the Main band **HM** key momentarily to transmit the tone string.
7. Once you have pressed the **HM** key in the above step, you can release the **PTT** switch, as the **Autodialer** will transmit the whole **DTMF** string automatically.

To set the speed:

The speed at which the **DTMF** digits are sent can be changed.

1. Press the **SET** key momentarily to enter the **Set** mode.
2. Rotate the **MAIN** DIAL knob to select **Menu #14** DTMF S.
3. Press the **MAIN** DIAL knob momentarily, then rotate the **MAIN** DIAL knob to select the desired speed.
 - 50MS: High: 20 digits per second
 - 75MS: Mid: 13 digits per second
 - 100MS: Low: 10 digits per second
4. Press and hold in the **MAIN** DIAL knob for ½ second to save the new setting and exit to normal operation.

To set a delay time:

You can also set a longer delay between the time you press the **HM** key (with **PTT** switch pressed) and when the first **DTMF** digit is sent.

1. Press the **SET** key momentarily to enter the **Set** mode.
2. Rotate the **MAIN** DIAL knob to select **Menu #13** DTMF D.
3. Press the **MAIN** DIAL knob momentarily, then rotate the **MAIN** DIAL knob to select the desired time (50MS, 250MS, 450MS, 750MS, or 1000MS).
4. Press and hold in the **MAIN** DIAL knob for ½ second to save the new setting and exit to normal operation.

Internet Connection Feature

The **FT-8900R** can be used to access a repeater which has been configured to provide access to the Vertex Standard **WIRES™** (Wide-Coverage Internet Repeater Enhancement System) or other **Internet Link Systems** that use a **DTMF** string for access.

To access a **WIRES™** repeater:

1. Press the left **VOL** knob momentarily to activate the **WIRES™** access capability. The **INT ON** message will be displayed for 2 seconds at the **Main** band. The **int** icon will appear in the memory channel field on the **Sub** band while **WIRES™** access is enabled.
2. Rotate the **MAIN DIAL** knob, while pressing and holding in the left **VOL** knob, to select the access number (ICOD 0 through ICOD 9, ICOD A through ICOD F) corresponding to the **WIRES™** repeater to which you wish to establish an Internet link. Ask the repeater owner/operator if you don't know the access numbers in the network.

With the **WIRES™** capability activated, the **FT-8900R** will generate a brief (0.1 second) **DTMF** tone according to your selection in step 2. This **DTMF** tone is sent at the beginning of every transmission to establish or maintain the link to the remote **WIRES™** repeater.

To disable the **WIRES™** access capability, press the left **VOL** knob again.

To access other Internet Link Systems that use a **DTMF** string for access:

1. Press the **SET** key momentarily to enter the **Set** mode.
2. Rotate the **MAIN DIAL** knob to select **Menu #15** **DTMF W**.
3. Press the **MAIN DIAL** knob momentarily, then load the **DTMF** tones which you wish to use to establish an Internet link (ask your repeater owner/operator if you don't know the access numbers in the network) into the desired **DTMF Memory** channel.
 - a. Rotate the **MAIN DIAL** knob to select the **DTMF Autodialer** memory channel number (d-1 through d-16).
 - b. Press the **MAIN DIAL** knob momentarily.
 - c. Rotate the **MAIN DIAL** knob to select the **DTMF** code, then press the **MAIN DIAL** knob momentarily to move the digit.
 - d. Repeat step c.
 - e. Press the **MAIN DIAL** knob momentarily to save the new setting.
4. Rotate the **MAIN DIAL** knob to select **Menu #17** **INET**.

5. Press the **MAIN** DIAL knob momentarily, then rotate the **MAIN** DIAL knob to set this Item to **INT.MEM** (to enable the alternative **Internet Link**, and disable the **WIRES™** access option).
6. Press and hold in the **MAIN** DIAL knob for ½ second to save the new setting and exit to normal operation.
7. Press the left **VOL** knob momentarily to activate the **Internet Link System**. **INT ON** will be displayed for 2 seconds in the **Main** band frequency field. The **int** icon will then be displayed in the memory channel field on the **Sub** band while the **Internet Link System** access feature is engaged.
8. Rotate the **MAIN** DIAL knob, while pressing and holding in the left **VOL** knob, to select the **DTMF** access number (**IMEM 1** through **IMEM16**) corresponding to the **Internet Link** repeater to which you wish to establish an **Internet Link**.
9. With the **Internet Link** feature activated, press the left **VOL** knob, or microphone's **P2** key, to send out the **DTMF** tones according to your selection in step 8 (to establish the link to the **Internet Link** repeater).
10. To disable the **Internet Link** feature, press the left **VOL** knob again.

To return to **WIRES™**, recall **Menu #17 INET**, then set it to **INT. COD**.

Operate as a Cross-Band Repeater

The **FT-8900R** can be set up to operate as a full-featured cross-band repeater via a simple **Menu** procedure. This feature is useful for emergency portable work in a remote area, and for cross-band linking.





However, remember these points before using the **Cross-Band Repeater** mode:

- Check the amateur radio rules and regulations for your country to ensure that this type of operation is permitted.
- Pick your frequency pair carefully, so as not to cause harmful interference to other users. The use of cross-band repeaters has the potential to cause serious disruption of communications circuits, and the creation of harmful interference to coordinated repeaters is inconsiderate and may be illegal. If you are not sure of active repeater frequencies in your area, a safe rule is to stay off of the repeater sub-bands and use the FM simplex portion of each band. Contact your area's frequency coordinator for guidance.
- Remember that the transmit duty cycle will be much higher during repeater service, so we recommend that the transmit power level be set to a Low setting to ensure cooler operation.

Transceiver **CTCSS** settings (Encode/Decode) may, of course, be selected for each band, allowing selective calling for your repeater. However, keep in mind that if the channels you use are so busy as to motivate you toward **CTCSS Decoding**, you may not have chosen a good frequency pair on which to operate, as the potential for interference to other users is high.

To set up Cross-Band Repeater operation:

Before enabling **Cross-Band Repeater** operation, configure both band settings as desired, and set the squelch such that background noise is silenced.

1. Press the  **SET** key momentarily to enter the **Set** mode.
2. Rotate the  **DIAL** knob to select **Menu #44** X-RPT.
3. Press the  **DIAL** knob momentarily, XSTART will appear on the display.
4. Press the  **DIAL** knob again to activate the **Cross-Band Repeater** mode.

To exit the **Cross-Band Repeater** mode, Press the  **SET** key again.

Transfer Data between two FT-8900Rs

You can transfer all data stored in one **FT-8900R** to another **FT-8900R** by utilizing the handy **Cloning** feature. This requires a user-constructed **Cloning** cable which connects the **DATA** jacks on the two transceivers, as shown below.

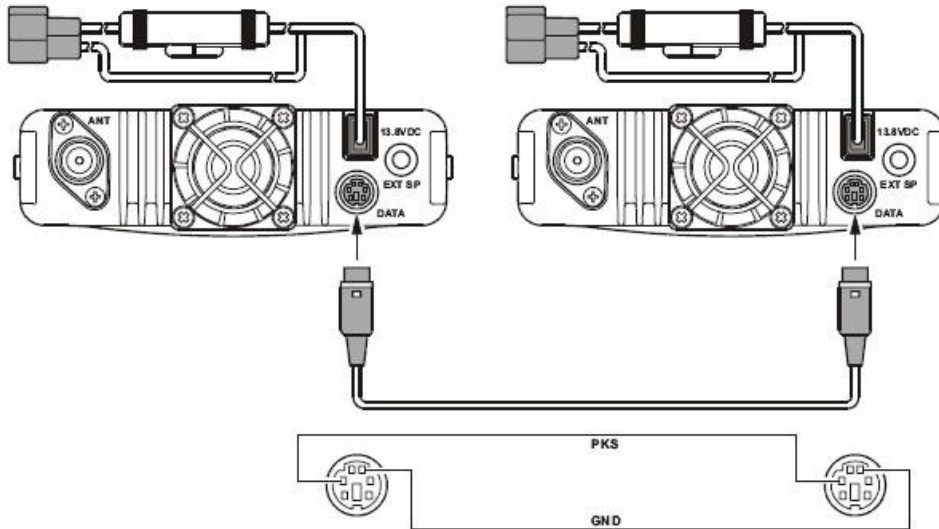



To clone from one transceiver to another:

1. Insert the **Cloning Cable** into the **DATA** jack of each transceiver.
2. Turn both transceivers off, then press and hold in the **Left** **V/M** key on each radio while turning the power on again.
3. Rotate the **Right DIAL** knob on each radio to select **CLONE START**, then press the **SET** key. The display will disappear for a moment, then the **CLONE** notation will appear on the display.
4. On the **destination radio**, press the **Left** **LOW** key. The **CLONE -RX-** indicator will appear on the display.
5. Now, on the **source radio**, press the **Left** **V/M** key. The **CLONE -TX-** indicator will appear on the display, and the cloning data transfer will immediately begin.
 - If there is a problem during the cloning process, **CLONE ERROR** will be displayed. Check your cable connections, and try again.
 - If cloning was successful, the **CLONE -RX-** and **CLONE -TX-** indicators will disappear.
6. Turn both transceivers off, then remove the **Cloning Cable**.

Channel and operating data for both radios are now identical. They both may be turned on now for normal operation.

Reset Your FT-8900R





To Reset your **FT-8900R**:

1. Turn the radio off.
2. Press and hold in the **Left**  key while turning the radio on.
3. Rotate the **Right DIAL** knob to select the **Reset** menu:
 - **SETMOD RESET**: Resets the **Menu (Set)** mode settings to their factory defaults.
 - **HYPERS RESET**: Clears the **Hyper Memory** settings to factory defaults.
 - **MEMORY RESET**: Clears the **Regular Memory** settings to factory defaults.
 - **ALL RESET**: Clears all memories and other settings to factory defaults.
4. Press the  **SET** key momentarily to complete the **Reset** procedure.

Menu (Set) Mode

Overview

The **FT-8900R Menu (Set)** mode is easy to activate and set. It may be used for configuration of a wide variety of transceiver parameters, some of which have not been detailed previously. Use the following procedure to activate the **Menu (Set)** mode:

1. Press the  **SET** key momentarily to enter the **Set** mode.
2. Turn the  **DIAL** knob to select the **Menu Item** to be adjusted.
3. Press the  **DIAL** knob momentarily to enable adjustment of the selected **Menu Item**, then rotate the  **DIAL** knob to perform the actual adjustment.
4. After completing your selection and adjustment, press and hold in the  **DIAL** knob for ½ second to exit the **Set** mode and return to normal operation.

Menu Item Prefixes

Some **Menu Items** are preceded by either the character **b** or **h**. The **b** character denotes that the value for this **Menu Item** is to be applied separately for each **Operating Band** and/or **Mode**. The **h** character denotes that the value for this **Menu Item** is to be applied separately to each **Hyper Memory Channel**.

Menu Quick Reference Table

Item #	Menu	Function	Available Values	Default
1	APO	Selects the Automatic Power Off time.	OFF, 0.5H – 12.0H	OFF
h 2	ARS	Activates/deactivates the Automatic Repeater Shift feature.	ON, OFF	varies
h 3	ARTS	Selects the ARTS beep mode.	IN RNG, ALWAYS	
h 4	BAND	Enables/disables the VFO Band edge for the current band.	BND ON, BND OFF	BND ON
5	BEEP	Enables/disables the beeper.	BEP.ON, BEP.OFF	BEP.ON
b 6	CLK.SFT	Shifts the CPU clock frequency.	SFT.ON, SFT.OFF	SFT.OFF
7	CWID	Enables/disables the CW identifier during ARTS operation.	TX ON, TX OFF	TX OFF
8	CWID W	Stores your callsign into the CW identifier.		
9	DIMMER	Sets the Display brightness level.	DIM 1, DIM 2, DIM 3, OFF	DIM 1
b 10	DCS.COD	Sets the DCS code.		023
11	DCS.N/R	Selects <i>Normal</i> or <i>Inverted</i> DCS coding.	TRX N, RX R, TX R, TRX R	TRX N
h 12	DSP.SUB	Selects the Sub Band display format.	FREQ, CWID, DC-IN, OFF	FREQ
13	DTMF D	Sets of the DTMF Autodialer Delay Time.	50MS, 250MS, 450MS, 750MS, 1000MS	450MS
14	DTMF S	Sets of the DTMF Autodialer Sending Speed.	50MS, 75MS, 100MS	50MS
15	DTMF W	Loads the DTMF Autodialer Memories.		
16	HYPER	Enables/disables the Automatic Writing feature for Hyper Memory.	MANUAL, AUTO	MANUAL
17	INET	Selects the Internet Connection mode.	INT.COD, INT.MEM	INT.COD
18	INET C	Selects the Access Number (DTMF digit) for WIRES™ operation.	CODE 0 – 9, CODE A – F	CODE 1
19	INET M	Selects the Access Number (DTMF code) for non-WIRES™ Internet Link System access.	d-1 – d-16	d-1
20	KEY.MOD	Selects the key functions for the <i>right</i> band function switches.	KEY1, KEY2	KEY1
21	LOCK	Enables/disables the Key/Button Lock feature.	ON, OFF	OFF
22	LOCKT	Enables/disables the PTT Lock feature.	OFF, BAND R, BAND L, BOTH	OFF
23	MIC	Selects the microphone type to be used.	MH-48, MH-42	MH-48

Item #	Menu	Function	Available Values	Default
24	MUTE	Selects the Audio Mute mode.	OFF, TX, RX, TX/RX	OFF
b 25	NAME	Stores an Alpha-Numeric "Tag" for a memory channel.		
h 26	PKT.S	Sets the transceiver's circuitry for the Packet baud rate to be used.	1200BPS, 9600BPS	1200BPS
h 27	PKT.B	Sets the receiving band for Packet operation.	MAIN, R-FIX, L-FIX	MAIN
28	PG P1	Programs the MH-48A6J microphone's P1 button.	BAND, VFO/MR, SCAN, SQL.OFF, TCALL, RPTR, PRI, LOW, TONE, MHz, REV, HOME	BAND
29	PG P2	Programs the MH-48A6J microphone's P2 button.		VFO/MR
30	PG P3	Programs the MH-48A6J microphone's P3 button.		TONE
31	PG P4	Programs the MH-48A6J microphone's P4 button.		LOW
32	RF SQL	Sets the RF SQL threshold level.	OFF, S-2, S-5, S-9, S-FULL	OFF
b 33	RPT.MOD	Sets the Repeater Shift Direction.	RPT.OFF, RPT. - , RPT.+	RPT.OFF
34	SCAN	Selects the Scan-Resume mode.	TIME, BUSY	TIME
b 35	SCAN M	Selects the Memory Scan mode.	MEM, MSM	MEM
b 36	SHIFT	Sets the magnitude of the Repeater Shift.	0.00 – 99.50 MHz	varies
b 37	STEP	Sets the Synthesizer steps.	5.0k, 10.0k, 12.5k, 15.0k, 20.0k, 25.0k, 50.0k	varies
38	SPCONT	Defines the audio path to an external speaker.	EXT, OFF, INT.EXT, INT	EXT
b 39	TONE F	Sets the CTCSS Tone Frequency.		100 HZ
b 40	TONE M	Selects the Tone Encoder and/or Decoder mode.	OFF, ENC, ENC.DEC, DCS	OFF
41	TOT	Sets the Time-Out Timer.	1 – 30 minutes, OFF	6MIN
h 42	VFO.TR	Enables/disables the VFO Tracking feature.	ON, OFF	OFF
b 43	WID.NAR	Sets the MIC Gain (and Deviation).	WIDE, NARROW	varies
44	X-RPT	Enables/disables the Cross-Band Repeater feature.		
b 45	AM	Enables/disables the AM mode.	ON, OFF	OFF
h 46	AUT.AM	Selects the receiving mode.	AUTO, OFF	AUTO

Menu Items

The **Menu** items are listed in numeric order.

Menu #1 APO

Function:	Selects the Automatic Power Off time (time until power is turned off). See Activate Automatic Power Off on page 22 for details.
------------------	--

Values:	OFF, 0.5 H – 12.0 H in 0.5 hour multiples
----------------	---

Default:	OFF (Disables the APO feature)
-----------------	--------------------------------

Menu h 2 ARS

Function:	Activates/deactivates the Automatic Repeater Shift feature. See Automatic Repeater Shifts on page 25 for details.
------------------	--

Values:	ON, OFF
----------------	---------

Default:	Depends on the band of operation.
-----------------	-----------------------------------



The value for this **Menu Item** is to be applied separately to each **Hyper Memory Channel**.

Menu h 3 ARTS

Function:	Selects the ARTS beep mode. See ARTS on page 50 for details.
Values:	<p>IN RNG, ALWAYS</p> <p>IN RNG Activates the ARTS feature; a high tone beep will sound when the transceiver first detects that you are within range, and a low beep will sound when the other station goes out of range.</p> <p>ALWAYS Activates the ARTS feature; a high tone beep will sound every time a polling transmission is received from the other station, and a low beep will sound once when the other station goes out of range.</p>
Default:	



The value for this **Menu Item** is to be applied separately to each **Hyper Memory Channel**.

Menu h 4 BAND

Function:	Enables/disables the VFO Band edge for the current band.
Values:	<p>BND . ON, BND . OFF</p> <p>BND . ON When the VFO frequency reaches the high band edge of the current band, the VFO frequency will jump to the low band edge of the current band (or vice versa).</p> <p>BND . OFF When the VFO frequency reaches the high edge of the current band, the VFO frequency will jump to the low band edge of the next band (or vice versa).</p>
Default:	BND . ON



The value for this **Menu Item** is to be applied separately to each **Hyper Memory Channel**.

Menu #5 BEEP

Function: Enables/disables the beeper.
See *Activate the Key/Button Beeper* on page 19 for details.

Values: BEP.ON, BEP.OFF

Default: BEP.ON

Menu b 6 CLK.SFT

Function: Shifts the **CPU** clock frequency.

Values: SFT.ON, SFT.OFF

Default: SFT.OFF



(1) This function is only used to move a spurious response birdie, should it fall on a desired frequency.

(2)The value for this **Menu Item** is to be applied separately to each **Hyper Memory Channel**.

Menu #7 CWID

Function: Enables/disables the **CW Identifier** during **ARTS** operation.

Values: TX ON, TX OFF

Default: TX OFF

Menu #8 CWID W

Function: Stores your callsign into the **CW Identifier**. Up to six characters may be stored.
See *Set Up the CW Identifier* on page 51 for details.

Values:

Default:

Menu #9 DIMMER

Function:	Sets the Display brightness level. See <i>Set the Display Brightness</i> on page 20 for details.
------------------	--

Values:	DIM 1, DIM 2, DIM 3, OFF
----------------	--------------------------

Default:	DIM 1
-----------------	-------

Menu b 10 DCS.COD

Function:	Sets the DCS code. See <i>DCS Tone System</i> on page 28 for details.
------------------	---

Values:	104 Standard DCS codes.
----------------	-------------------------

Default:	023
-----------------	-----



The value for this **Menu Item** is to be applied separately for each **Operating Band / Mode**.

Menu #11 DCS.N/R

Function:	Selects <i>Normal</i> or <i>Inverted</i> DCS coding. See DCS Code Inversion on page 30 for details.
------------------	--

Values:	TRX N, RX R, TX R, TRX R
----------------	--------------------------

Default:	TRX N
-----------------	-------

Menu h 12 DSP.SUB

Function: Selects the **Sub Band** display format.

Values: FREQ, CWID, DC-IN, OFF

FREQ	Displays the Sub band frequency (Dual band operation).
CWID	Displays the CW ID.
DC-IN	Displays the DC supply voltage.
OFF	No Display.

Default: FREQ



(1) When this **Menu Item** is set to any selection other than the FREQ the **Sub band** receiver will be disabled.

(2) The value for this **Menu Item** is to be applied separately to each **Hyper Memory Channel**.

Menu #13 DTMF D

Function: Sets the **DTMF Autodialer Delay Time**.
See *Operating the DTMF Autodialer* on page 53 for details.

Values: 50MS, 250MS, 450MS, 750MS, 1000MS

Default: 450MS

Menu #14 DTMF S

Function: Sets the **DTMF Autodialer Sending Speed**.
See *Operating the DTMF Autodialer* on page 53 for details.

Values: 50MS (high speed), 75MS (mid speed), 100MS (low speed)

Default: 50MS

Menu #15 DTMF W

Function: Loads the **DTMF Autodialer Memories**.
See *Operating the DTMF Autodialer* on page 53 for details.

Values:

Default:

Menu #16 HYPER

Function: Enables/disables the **Automatic Writing** feature for the **Hyper Memory**.
See *Hyper Memory* on page 38 for details.

Values: MANUAL, AUTO

MANUAL Disables the Automatic Writing feature.

AUTO Enables the Automatic Writing feature. The Hyper Memory data changes automatically when the radio's configuration is changed (such as Mode change, Band Change, etc.).

Default: MANUAL

Menu #17 INET

Function: Selects the **Internet Connection** mode.
See *Internet Connection Feature* on page 55 for details.

Values: INT.COD, INT.MEM

INT.COD Sets up the Internet Connection mode for WIRES™ access.

INT.MEM Sets up the Internet Connection mode for other (DTMF string) Internet Link System access.

Default: INT.COD

Menu #18 INET C

Function: Selects the Access Number (DTMF digit) for **WIRES™** operation.
See *Internet Connection Feature* on page 55 for details.

Values: CODE 0 – 9, CODE A – F

Default: CODE 1

Menu #19 INET M

Function:	Selects the Access Number (DTMF code) for non-WIRES™ Internet Link System access. See <i>Internet Connection Feature</i> on page 55 for details.
Values:	d-1 – d-16
Default:	d-1

Menu #20 KEY.MOD

Function:	Selects the key functions for the right band function switches. See <i>Front Panel Controls</i> on page 6 for details.
Values:	KEY1, KEY2 KEY1 left and right side keys function as LOW, V/M, HM, and SCN KEY2 left side keys function as LOW, V/M, HM, and SCN right side keys function as MHz, REV, TONE, and SUB
Default:	KEY1

Menu #21 LOCK

Function:	Enables/disables the Key/Button Lock feature. See <i>Activate the Lock Feature</i> on page 18 for details.
Values:	ON, OFF
Default:	OFF

Menu #22 LOCKT

Function:	Enables/disables the PTT Lock feature.
Values:	OFF, BAND R, BAND L, BOTH OFF Enables the PTT switch. BAND R Disables the PTT switch on the right band. BAND L Disables the PTT switch on the left band. BOTH Disables the PTT switch on the both band.
Default:	OFF

Menu #23 MIC

Function: Selects the microphone type to be used.

Values: MH-48, MH-42

Default: MH-48

Menu #24 MUTE

Function: Selects the **Audio Mute** mode.
See **Select the Audio Muting Preference** on page 20 for details.

Values: OFF, TX, RX, RX/TX

OFF	Disables the Audio Mute feature.
TX	Reduces the audio level of the Sub band whenever you transmit on the Main band.
RX	Reduces the audio level of the Sub band whenever you receive a signal on the Main band.
TX/RX	Reduces the audio level of the Sub band whenever you receive a signal on the Main band or you transmit on the Main band.

Default: OFF

Menu b 25 NAME

Function: Stores an **Alpha-Numeric Tag** for a memory channel.
See **Create a Name Tag for a Memory Channel** on page 33 for details.

Values:

Default:



The value for this **Menu Item** is to be applied separately for each **Operating Band / Mode**.

Menu h 26 PKT.SPD

Function: Sets the transceiver's circuitry for the **Packet** baud rate to be used.

Values: 1200BPs, 9600BPs

Default: 1200BPs



The value for this **Menu Item** is to be applied separately to each **Hyper Memory Channel**.

Menu h 27 PKT.RXB

Function: Sets the receiving band for **Packet** operation.

Values: MAIN, R-FIX, L-FIX

MAIN Packet can be operated on the Main band.

R-FIX Packet can be operated on the right band only.

L-FIX Packet can be operated on the left band only.

Default: MAIN



(1) Packet transmit band is fixed on the Main band.

(2) The value for this **Menu Item** is to be applied separately to each **Hyper Memory Channel**.

Menu #28 PG P1

Function: Programs the **MH-48A6J** microphone's **P1** button assignment.
See *Program the Microphone Buttons* on page 13 for details.

Values: BAND, VFO/MR, SCAN, SQL.OFF, TCALL, RPTR, PRI, LOW, TONE, MHz, REV, HOME

Default: BAND

Menu #29 PG P2

Function:	Programs the MH-48A6J microphone's P2 button assignment. See <i>Program the Microphone Buttons</i> on page 13 for details.
Values:	BAND, VFO/MR, SCAN, SQL.OFF, TCALL, RPTR, PRI, LOW, TONE, MHz, REV, HOME
Default:	VFO/MR

Menu #30 PG P3

Function:	Programs the MH-48A6J microphone's P3 button assignment. See <i>Program the Microphone Buttons</i> on page 13 for details.
Values:	BAND, VFO/MR, SCAN, SQL.OFF, TCALL, RPTR, PRI, LOW, TONE, MHz, REV, HOME
Default:	TONE

Menu #31 PG P4

Function:	Programs the MH-48A6J microphone's P4 button assignment. See <i>Program the Microphone Buttons</i> on page 13 for details.
Values:	BAND, VFO/MR, SCAN, SQL.OFF, TCALL, RPTR, PRI, LOW, TONE, MHz, REV, HOME
Default:	LOW

Menu #32 RF SQL

Function:	Adjustd the RF SQL threshold level. See <i>Set the RF Squelch Level</i> on page 21 for details.
Values:	OFF, S-2, S-5, S-9, S-FULL
Default:	OFF



This **Menu Item** can be set independently on both the left and right bands.

Menu b 33 RPT.MOD

Function: Sets the **Repeater Shift Direction**.

Values: RPT.OFF, RPT. -, RPT. +

Default: RPT.OFF (simplex)



The value for this **Menu Item** is to be applied separately for each **Operating Band / Mode**.

Menu #34 SCAN

Function: Selects the **Scan-Resume** mode.

See **Set the Scan-Resume Preference** on page 42 for details.

Values: TIME, BUSY

TIME Scanning will halt on a signal it encounters, and will hold five seconds. If you do not take action to disable the scanning within five seconds, scanning will resume even if the stations are still active.

BUSY Scanning will halt on a signal it encounters. Two seconds after the carrier has dropped because the other station(s) ceased transmission, scanning will resume.

Default: BUSY



This **Menu Item** can be set independently for each band.

Menu b 35 SCAN M

Function:	Selects the Memory Scan mode. See <i>Scan in Memory Mode</i> on page 45 for details.
Values:	MEM, MSM MEM Enables Memory Scanning on all memory channels. MSM Enables Memory Scanning on flagged Memory Channels only.
Default:	MEM



The value for this **Menu Item** is to be applied separately for each **Operating Band / Mode**.

Menu b 36 SHIFT

Function:	Sets the magnitude of the Repeater Shift .
Values:	0.00 – 99.95 MHz (50 kHz step)
Default:	Depends on the band of operation.



The value for this **Menu Item** is to be applied separately for each **Operating Band / Mode**.

Menu b 37 STEP

Function:	Sets the Synthesizer steps. See <i>Select the Channel Step</i> on page 19 for details.
Values:	5.0k, 10.0k, 12.5k, 15.0k, 20.0k, 25.0k, 50.0k
Default:	Depends on the band of operation.



The value for this **Menu Item** is to be applied separately for each **Operating Band / Mode**.

Menu #38 SPCONT

Function:	Defines the audio path to the external speaker (when used).
Values:	EXT, OFF, INT .EXT, INT
	EXT The audio is routed to external speaker (internal speaker is off).
	OFF The audio is not routed (internal and external speakers are both off).
	INT .EXT The audio is routed to both the internal and external speakers.
	INT The audio is routed to the internal speaker only (external speaker is off).
Default:	EXT

Menu b 39 TONE F

Function:	Sets the CTCSS Tone Frequency . See CTCSS Tone System on page 27 for details.
Values:	50 Standard CTCSS Tones
Default:	100 Hz



The value for this **Menu Item** is to be applied separately for each **Operating Band, Mode, and Memory channel**.

Menu b 40 TONE M

Function:	Selects the Tone Encoder and, or Decoder mode. See CTCSS Tone System on page 27 for details.
Values:	OFF, ENC, ENC .DEC, DCS
	OFF No Encoder, Decoder
	ENC CTCSS Encoder
	ENC .DEC CTCSS Encoder, Decoder
	DCS Digital Code Squelch Encoder, Decoder
Default:	OFF



The value for this **Menu Item** is to be applied separately for each **Operating Band / Mode**.

Menu #41 TOT

Function:	Sets the Time-Out Timer. See <i>Activate the Time-Out Timer</i> on page 21 for details.
Values:	1 – 30 minutes or OFF
Default:	6MIN

Menu h 42 VFO.TR

Function:	Enables/disables the VFO Tracking feature. See <i>Activate the Band Linking Feature</i> on page 20 for details.
Values:	ON, OFF
Default:	OFF



The value for this **Menu Item** is to be applied separately to each **Hyper Memory Channel**.

Menu b 43 WID.NAR

Function:	Reducing the MIC Gain (and Deviation). See <i>Set FM Bandwidth and MIC Gain</i> on page 22 for details.
Values:	WIDE, NARROW
Default:	varies



The value for this **Menu Item** is to be applied separately for each **Operating Band / Mode**.

Menu #44 X-RPT

Function:	Enables/disables the Cross-Band Repeater feature. See <i>Operate as a Cross-Band Repeater</i> on page 57 for details.
Values:	
Default:	

Menu b 45 AM

Function:	Enables/disables the AM mode.
------------------	-------------------------------

Values:	ON, OFF
----------------	---------

Default:	OFF
-----------------	-----



The value for this **Menu Item** is to be applied separately for each **Operating Band / Mode**.

Menu h 46 AUT. AM

Function:	Selects the receiving mode.
------------------	-----------------------------

Values:	AUTO, OFF
----------------	-----------

Default:	AUTO (AM in Aeronautical Band, FM elsewhere)
-----------------	--



The value for this **Menu Item** is to be applied separately to each **Hyper Memory Channel**.