

*Your Guide to*

**WARREN  
WILSON  
COLLEGE  
ADVISING,  
REGISTRATION  
& ACADEMIC  
SUPPORT  
WORKBOOK &  
COLORING BOOK**





# Hello.

It's time to get excited about advising and registration! We've designed this workbook to assist you. In all, there are six total activities to complete. It is important that you complete each activity by its final deadline. Here are the important dates to remember:

- |   | check once completed!    |
|---|--------------------------|
| 1. <b>Getting Connected</b> • 3–6 _____ due June 15, 2018   | <input type="checkbox"/> |
| 2. <b>Advising, and Placement Tests</b> • 7–12 _____ due June 15, 2018  | <input type="checkbox"/> |
| 3. <b>Considering Your First-Year Seminar</b> • 13–20 _____ due July 1, 2018                                      | <input type="checkbox"/> |
| 4. <b>Academic Success</b> • 21–28 _____ due July 1, 2018   | <input type="checkbox"/> |
| 5. <b>Where Are You Now?</b> • 29–32 _____ due July 1, 2018<br><i>(Freshmen only – transfers can skip to #6!)</i> | <input type="checkbox"/> |
| 6. <b>Work and Community Engagement</b> • 33–34 _____ due July 1, 2018  | <input type="checkbox"/> |
| 7. <b>Celebrate!</b> • 35–36 _____ due anytime!   | <input type="checkbox"/> |

If you were admitted after the deadlines, complete each activity in order as soon as possible. Thanks!



# But First...

**BEFORE YOU GET STARTED, THERE ARE A FEW THINGS YOU SHOULD KNOW.**

There is a lot (**A LOT!**) of important information in this packet. It will take you a while to get through it, and it will require you to think, to draw, to dream...

We recommend you work on this packet in short intervals, over a few days, to give yourself ample time to read it thoroughly, have discussions with friends and family, and consider what you want out of your academic experience at Warren Wilson College.

You will find that there are many interactive exercises, broken out into seven different activities, designed to help prepare you for academic success. We encourage you to complete each activity and to bring this workbook with you to campus, where it can assist you in speaking with your academic advisor, remind you of the services we have to offer, and much more.

CONSIDER IT YOUR FIRST OFFICIAL  
WARREN WILSON COLLEGE ASSIGNMENT.

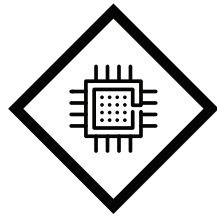

# Activity #1

Getting Connected

**30 MINUTES**

Read through pages 4–5. Set up your Warren Wilson College email, and consider the specs you need for the laptop you bring to campus.

**DEADLINE: JUNE 15, 2018**

# Getting Connected.

You have one set of credentials for accessing Warren Wilson online. Our online systems include our myWWC web portal, Google Apps for Education, and your Warren Wilson College network access. Instructions to set up your account are below.

## SETTING UP YOUR ACCOUNT & EMAIL

*This includes your Warren Wilson College email account, myWWC, your Google Drive, your Calendar, WWC wi-fi, Moodle (our online learning platform) and more.*

- GO TO: <https://reset.warren-wilson.edu>
- Click “My Account”
- Use your user name and temporary password to sign in.
- Follow the instructions to set up security questions and your permanent password.

**Now set up your Google Apps for Education account, including your Warren Wilson email.**

- GO TO: [mail.warren-wilson.edu](mailto:mail.warren-wilson.edu)
- If you are already signed in to Google, sign out or, if using Chrome, add a new profile. Search “Add a person to Chrome” for detailed instructions.
- Use your full email address (your user name @warren-wilson.edu) and new password to sign in.
- Check your email regularly. Pre-Orientation communication will be going to your new email address.

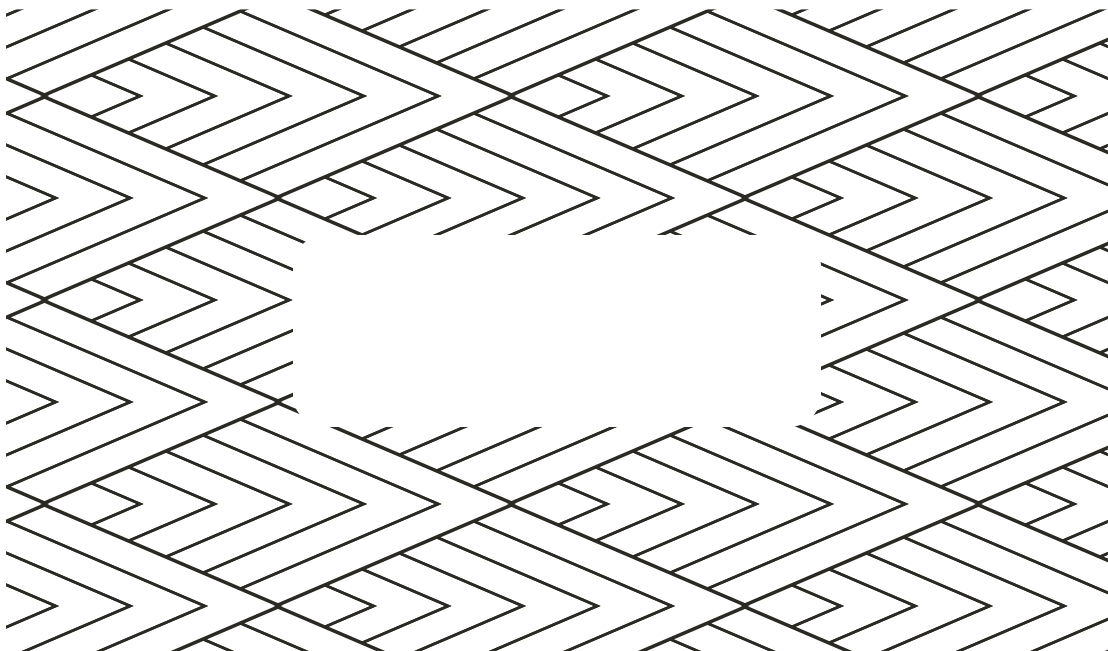

# IS MY COMPUTER READY FOR COLLEGE?

Almost all Warren Wilson students bring a computer and other technology with them to campus, which supports their academic goals and requirements. Below we've gathered suggestions straight from our IT department about what kind of technology you need to be Wilson ready. Computer labs are also available across campus if needed.

- A modern computer (less than three years old) running either Windows 10 or Mac OS El Capitan (10.11) or later. Laptop recommended.
- A power strip with surge suppression of 1100 joules or higher.
- A computer backup solution in place in case of disaster. But keep all your papers in Google Drive!
- Warren Wilson College provides access to a subscription for Microsoft Office and Google Apps for Education. You don't need to purchase Office.
- Printing: We provide an allotment of pages for printing in the labs and library that should be enough for your needs.
- WiFi: All dorm and academic spaces have WiFi coverage. Please leave your own hotspot at home.



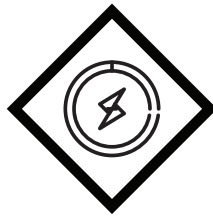

# Activity #2

Advising, and Placement Tests

**90 MINUTES**

Read through pages 8–12. Then you will have the tools to complete your Academic Survey and a sense of how summer course registration will work.

**DEADLINE: JUNE 15, 2018**



# The Center for Integrated Advising

The Center is the home of your Integrated Advising (IA) Coach, the person who will help you choose and register for courses until you declare a major. Your IA coach will continue to work with you throughout your four years as you develop your individual educational pathway to achieve your goals. This will involve thinking about your interests and career directions so that you can choose the work and community engagement experiences that will allow you to test out your ideas and enhance your academics. As you reflect on those experiences, you'll have a chance to confirm or adjust your path in order to build strong preparation for the meaningful life and career you're working towards. Your IA coach will provide guidance and resources for you in that journey.

Also within the Center you will find our Career Development programming and the Director for Internships who, along with your IA Coach, will help you find the on (or off!) campus internship that will bring together your experiences in academics, work and/or community engagement. Our Educational Access and Academic Support Services are available in the Center supporting students who may request accommodations related to disabilities and students who want to enhance academic and time management skills through individual counseling, peer subject-based tutoring and workshops and classes.

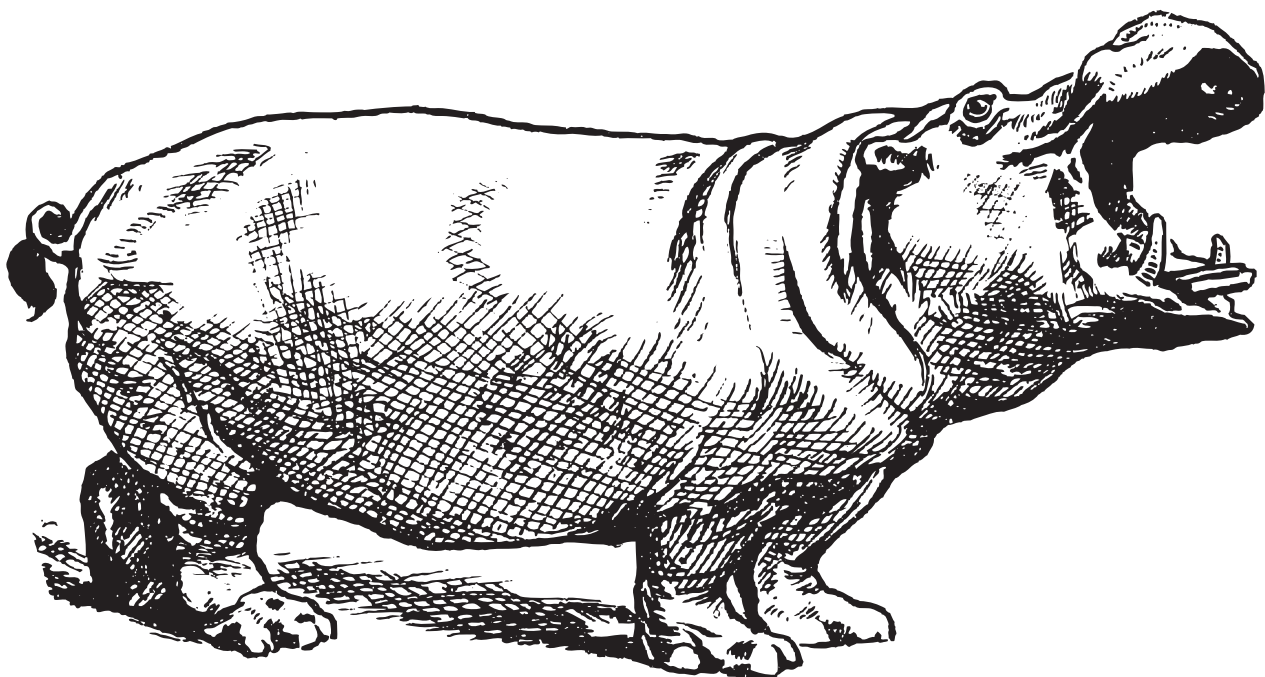

# Getting Ready To Register

## FOR YOUR FALL 2018 COURSES

With the assistance of your IA Coach, you will be registering for your Fall 2018 courses during the month of July. Your IA Coach will meet with you via phone or online. The following steps are required:

### 1) SEND US YOUR AP/IB TEST SCORES

We cannot advise you accurately if we haven't received these scores, since your performance may fulfill some of our requirements.

### 2) SEND US YOUR FINAL HIGH SCHOOL TRANSCRIPT SHOWING YOU HAVE RECEIVED YOUR DIPLOMA.

This is required by North Carolina state law.

### 3) TAKE YOUR PLACEMENT TESTS

Be sure to have them completed by June 15th.

### 4) RESPOND TO YOUR IA COACH

When you receive an email from your IA Coach (it will be sent to your Warren Wilson email in mid July, so be sure you're checking it regularly!), respond promptly and set up a time for your first meeting. Make sure to note the name of your Coach and your meeting day/time in the black box on the bottom of the page.

### 5) SUBMIT YOUR HEALTH FORMS

If your health forms are not submitted by the second week of classes, we are required by the state of North Carolina to drop your registration. Yikes!

You may send all of your documents to:

Warren Wilson College  
Office of Admissions  
CPO 6375  
PO Box 9000  
Asheville, NC 28815

My IA Coach:

Appointment date:

Appointment time:

**BUT WAIT. WHAT  
IF YOU WANT TO  
CHANGE YOUR  
SCHEDULE ONCE  
IT'S SET? OR YOU  
AREN'T ABLE TO  
CONNECT WITH  
YOUR IA COACH?**

*Don't worry! You will have the opportunity to revise your first semester registration during Orientation. And if you and your IA Coach are unable to connect during the summer, there will be plenty of opportunities to select your fall courses once you arrive on campus.*

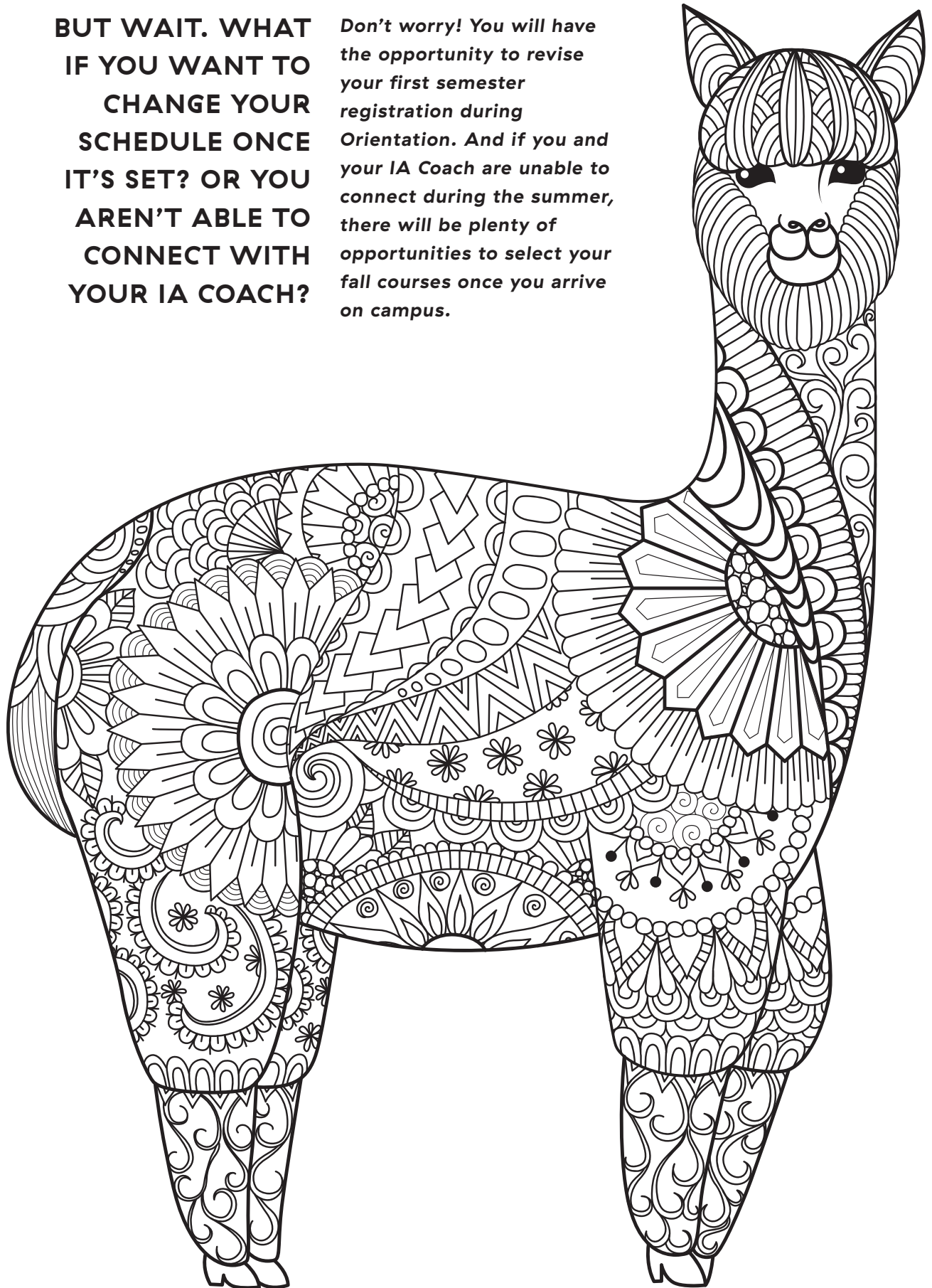

# Placement Test Instructions.

## What is a placement test?

At Warren Wilson College, we use placement tests to help determine the best level for you to begin your academic coursework. These are tests that are used to measure where you are right now. It's important you take them seriously, but don't feel pressure to study or prepare too much. Basically, we want a snapshot of where you are so we know where you should start.

We offer three placement tests, and you'll determine which ones you need to take based on what you plan to study. You do not have to take all of your Placement Tests at one time (in fact, we wouldn't recommend it), but they should all be completed by June 15, 2018.



# Placement Test Information.

The College has three placement tests.

## 1. Math Placement Test

- All incoming students are **REQUIRED** to take this test.
- **LENGTH:** 60 minutes and must be completed in one sitting.
- **NOTE:** Have pencil and paper on hand. Test should be completed without a calculator.

## 2. Chemistry Placement Test

- Do you plan to study science at Warren Wilson? This includes natural science majors (chemistry, biology, etc.) and environmental studies students, as well as students interested in medical school or other health professions. If yes, you must take this test.
- **LENGTH:** 80 minutes long and must be done in one sitting.
- **NOTE:** You may use a calculator.

## 3. Spanish Placement Test

- If you have studied Spanish in high school or speak it at home, and if you think you might take Spanish in college, you must take this test.
- **LENGTH:** untimed

### TO TAKE YOUR PLACEMENT TESTS:

GO TO: <https://warren-wilson.edu/new-students> for detailed instructions on how to access the Placement Tests.

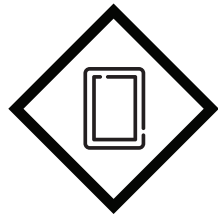

# Activity #3

Considering Your First-Year Seminar

**30 MINUTES**

Read through pages 14–19. Consider the menu of First-Year Seminar courses, and identify those that most appeal to your interests and passions. Color in stars.

**DEADLINE: JULY 1, 2018**

# Explore the First-Year Seminar Experience.

New first-year students will be registered for a First-Year Seminar. This course is a key component of Warren Wilson's first-year experience, and provides an opportunity for students to be introduced to our faculty, our academic expectations, our community engagement opportunities, and each other in small, seminar-style courses.

BY INDICATING WHICH COURSES MOST INTEREST YOU, WE WILL BE ABLE TO MATCH YOU WITH A FIRST-YEAR SEMINAR THAT ALIGNS WITH YOUR INTERESTS.

Review the First-Year Seminar descriptions below. As you go, color in the number of stars (1-5) for each seminar based on which ones are most interesting to you. At the end, list your top three choices. You will then submit your preferences in your online Academic Survey by **July 1st**.



## **WATER: THE SCIENCE AND POLITICS OF THE WORLD'S MOST VITAL RESOURCE (Honors Seminar)**

Water is the most common substance on earth, and the most important compound for all forms of life. It is what most distinguishes our planet from others. If one looks at the history of human settlement, there is one common factor about where we build communities--our proximity to water. Whether for transportation, drinking, irrigation, or power, water has been--and will always be--our most critical resource. In this course, we will look at water from an interdisciplinary perspective. In addition to scientific concepts such as hydrology, we will also try to understand the politics of water. Indeed, across the globe, the control of water leads to political power.

YOUR INSTRUCTOR: **Dr. Mark Brenner** majored in Biology in college, and specialized in water pollution ecology for his Ph. D. He loves all things wild and has a strong interest in obtaining food from gardening, fishing, hunting, and collecting wild mushrooms and berries.



## **MONUMENTS AND COUNTER-MONUMENTS (Honors Seminar)**

Recent controversies over Confederate monuments in the Southern U.S. have brought attention to deeply philosophical questions about the role of monuments in public spaces and their relation to a public (or publics) more generally. This course will take an in-depth, scholarly approach to these questions in order for us to better understand the attitudes and arguments about public monuments and to examine a variety of possible responses. Students will also gain practical awareness of these issues through service projects relating to a publicly-funded Visiting Artist Program that engages with the African-American community of Asheville.

YOUR INSTRUCTOR: **Professor Jay Miller** writes about the intersection of art and politics. He is Chair of the Philosophy Department at Warren Wilson College and is currently also Chair of the City of Asheville's Public Art and Cultural Commission.



## THE BIOLOGY OF SEX

A key question has captivated natural historians and evolutionary biologists for centuries: Why does sex exist? In many ways, asexual (clonal) reproduction could be considered the ideal strategy: no mates are required and all parental genes are passed on to the next generation. By contrast, organisms that successfully reproduce by sex must first find and secure a mate. And after all this effort, only half of each parent's genes are inherited by their offspring! In this course, we will study a variety of organisms--including microbes, plants, insects, and humans--to explore the tremendous diversity of morphologies and behaviors that are associated with sexual reproduction. Students consider the ecological and genetic conditions under which sexual reproduction and different mating strategies evolve, as well as the evolutionary outcomes of sex. We will partner with local organizations that seek to preserve environments that provide suitable habitats for a variety of living organisms and that educate the general public about science.

YOUR INSTRUCTOR: **Dr. Alisa Hove's** research focuses on identifying the ecological conditions that favor the evolution of different reproductive strategies, studying evolutionary responses to environmental stress, and investigating the conservation genetics of wild plant populations in the southeastern U.S. She also supervises the Warren Wilson College Genetics Crew, a research group that provides crew members an outlet for channeling their interests in addressing innovative questions in biological conservation, molecular biology, and natural history.



## THE MUSIC OF POETRY AND THE POETRY OF MUSIC

Ancient epic poets regarded poetry as a form of music. The nineteenth-century cultural critic Walter Pater famously wrote that "All art constantly aspires towards the condition of music." This course explores the deep kinship between poetic language and musical "language," and it also considers some of the fascinating research that connects these art forms more broadly to the human experience. Readings will include Oliver Sacks' *Musophilia: Tales of Music and The Brain* and Daniel Levitin's *This Is Your Brain on Music*.

YOUR INSTRUCTOR: **Dr. Michael Matin** teaches and writes about modern literature of Britain and the former territories of the British Empire. When not reading a novel or playing his piano, he enjoys spending time with his family and his dog, Max.



## BRAIN BASICS: HUMAN NEUROSCIENCE FOR A HEALTHY LIFE

The human brain is one of the most complex systems ever studied, and although there are still many unknowns in the field of neuroscience, there have also been many exciting discoveries that can help us understand our own thoughts, emotions, and actions. In this course, we will examine how the human nervous system supports behaviors like perception, attention, memory, problem-solving, and decision-making. We will focus on translating knowledge about neuroscience and psychology into strategies that can promote healthy habits for learning, growing, and connecting with one another. We will spend time reading and writing about the theories and applications of current research and we will also partner with local organizations who are working to enhance growth and well-being in our community.

YOUR INSTRUCTOR: **Dr. Jen Mozolic** is a psychology professor with a passion for exploring the environments and experiences that support healthy brains and behaviors. After earning her PhD in Neuroscience in 2009, she came to Warren Wilson to share this passion with students, to continue learning about learning, and to enjoy this vibrant and beautiful community.





## **LANGUAGE AND IDENTITY IN COMMUNITY: CONNECTING THROUGH CULTURE**

What are the intersections of language, identity and culture, and how do these factors shape who we are? By developing and practicing our Spanish language proficiency, we will explore questions of identity and intercultural learning. Students learn concrete linguistic information and the skills necessary to communicate with Spanish speakers in a culturally appropriate way. Through essays and reflections written in English, we will examine themes of home, places of departure and destination, layers of identity, belongingness, and bilingualism. Further, we will regularly partner with Spanish-speaking students who are newcomers to the Swannanoa Valley, seeking to understand our mutual and complex challenges of negotiating new places and communities. This seminar is ideal for any student wishing to develop Spanish language skills and to engage with Spanish-speaking students in the local public schools. Heritage speakers are encouraged to enroll.

YOUR INSTRUCTOR: **Professor Christine Swoap** focuses on Spanish language acquisition and pragmatics, critical reflection of service-learning and community engagement, and working with newcomers in the local area. She has studied and led courses in Spain, Costa Rica, and Mexico.



## **HOLDING FRUIT: CREATIVE GARDEN TRELIS**

This course will focus on art and craft and on how design and function coexist. Partnering with the Dr. John Wilson Community Garden, students will work directly in the garden to cultivate a plot of land with the end goal to install creative trellis designs. Students will gain a basic understanding of building techniques in combination with the principles and elements of design. Form and function in horticulture will be examined and explored through presentations, lectures, demonstrations, and experiential learning. Students will be required to utilize writing as a way to reflect upon working with a community partner and implementing creative, functional designs.

YOUR INSTRUCTOR: **Professor James Darr** has been creating sculpture and building functional objects for 20 years. At the root is his great curiosity to solve creative and functional problems visually. He has spent the majority of his life growing his vast knowledge of materials and processes. When he is not in the classroom, he enjoys getting out in nature and playing a round of disc golf.



## **A CIVIL RIGHT: FROM MATH ANXIETY TO MATH LITERACY**

How is math literacy a civil right? What is math anxiety and how does it prevent math literacy? In this course, students will join an intellectual discourse by exploring civil rights, math anxiety, and math literacy. Students will research, read, and discuss, then share their learning at a local middle school afternoon program. This course is designed for students who wish to learn about the civil rights movement and to learn about math anxiety in order to help those who suffer from it (even if the afflicted person is you!).

YOUR INSTRUCTOR: An insatiable reader, who loves to play in the dirt, and an eternal optimist, **Dr. Gretchen Whipple** passionately wishes to improve everyone's attitudes about, as well as understanding of, mathematics.



## **EXPLORING APPALACHIA**

This course explores the interdisciplinary field of Appalachian studies through essays, primary documents, films, book excerpts, and weekend activities. We will study the region's modern history and the development of some of its distinctive cultural traditions, while learning about environmental and socioeconomic issues that affect the southern mountains today. Through a partnership with the South Asheville Cemetery Association, students in this course will work with an organization that is preserving the oldest public African American cemetery in western North Carolina.

YOUR INSTRUCTOR: **Dr. Jeff Keith** moved to Warren Wilson College from his home state of Kentucky after earning a doctorate in history. He has written essays on topics ranging from nineteenth century US foreign policy in Japan to the textile industry in twentieth century western North Carolina, and he is currently building a digital oral history collection about documentarians of the southern mountains. When time permits, he plays guitar, jogs around the woods, tries to be a chef, and volunteers on the WWC farm crew.



## **FOOD & RELIGION IN PRACTICE: RITUALS, DIETARY LAWS, AND MOVEMENTS FOR JUSTICE**

Why does food play such a central role in so many sacred traditions? How do people use food to make sense of and connect with the world? From potluck meals to soup kitchens, rituals to dietary laws, and feasts to fasting as a spiritual practice, both religion and food have served as a central feature of the human experience. This course will explore the various components of this connection, including: myths, rules, and rituals from various traditions; ethical concerns about food, sustainability, and justice; the role that food plays in community building and passing down faith and culture; and the role food can play in interfaith work, as an entry point and as a barrier. In this course, we will have the opportunity to read, write, and engage with religious texts, faith leaders, and sacred storytellers to better understand the deep connection between religion and food. We will also partner with local organizations that are working at this important intersection to tackle the needs of people in Asheville and Buncombe County. Please note: students need not identify as religious to participate in this course.

YOUR INSTRUCTOR: **Professor Matt Hoffman**, who began teaching at Warren Wilson in 2015, has extensive work with interfaith organizing and community activism. This course will draw on his own research interests and passion, targeting the connection between food, religion, community building, and the practice of justice. In his free time, Matt is a Cajun food devotee, a community garden green thumb, and an avid board game enthusiast.



## **TOOLS AND PROCESSES OF SUCCESSFUL ACADEMIC WRITERS**

While all first year seminars involve writing assignments, this course is specifically targeted toward students who want to build their knowledge, confidence, and enjoyment of academic writing. We will practice selecting topics, reading and responding to texts, writing to document experience, adjusting our writing to meet the needs of different audiences, giving and receiving feedback on writing, and developing each student's distinctive writing voice. We will resist the notion that all academic writing should sound alike, and instead seek models of linguistically and stylistically varied writing to support each of us in succeeding academically while also being true to our identities. We will also nurture the next generation of writers by traveling into Asheville weekly to participate in a writing and social studies unit with Ms. Duffy's third grade classroom at Isaac Dickson Elementary School. We will support her students to learn how local government functions, research candidates running in the November election, form opinions on local issues, and use their opinions to write persuasive letters to people in government.

YOUR INSTRUCTOR: **Dr. Julie Wilson** directs the Warren Wilson Writing Studio, where she collaborates with peer writing assistants to demystify college writing expectations, explore new writing practices, publish undergraduate writing, and bring humor and joy to academic work. She holds a BA in English from Oberlin College and an MA and PhD in Education from UNC-Chapel Hill.



## AMERICAN ROOTS MUSIC

The multicultural spectrum of American roots music comprises such captivating sounds as the Delta blues guitar, Cajun fiddle, gospel choir, Cherokee drum, bluegrass banjo, klezmer clarinet, Tejano bajo sexto, and zydeco accordion. In this course, we will explore these genres and how American communities make them meaningful and useful in their lives, especially as reflections of class, gender, race, and other markers of identity. Such scholars as Beverly Diamond, Benjamin Filene, and Thomas Turino will shape students' thinking about regionalism, tradition, authenticity, syncretism, and other important issues as they engage such topics in various writing assignments. Through a program called "Just Press Play," the class will partner with a local neurological treatment center, helping determine therapeutic music playlists for patients according to their individual identities and preferences.

**YOUR INSTRUCTOR: Professor Kevin Kehrberg** has performed and recorded as a professional bassist for over twenty years, primarily in jazz and traditional music settings. After earning a Ph.D. in musicology and ethnomusicology, he came to Warren Wilson in 2010 where he performs frequently as a freelance musician, researches the vernacular music of the region, and enjoys living in Swannanoa with his wife and three children.



## PSYCHOLOGY OF DIVERSITY

The news is rife with examples of intergroup conflict: The U.S. and Russia, Israelis and Palestinians, Democrats and Republicans. But how do we come to view some people as being part of the "out-group," and is an "us versus them" attitude always bad or even avoidable? In this course, we will examine developmental and evolutionary bases of in-group preference; what social and community psychology have to say about diversity; and the benefits and pitfalls of methodologically addressing (or ignoring) types of diversity in research studies. We will also spend time discussing non-violent communication and other ways to respect a less obvious form of diversity: diversity of opinion. Through class discussions, reflection papers, and community engagement, students will consider what it means to be a social scientist and conscientious citizen in a diverse and often polarized world.

**YOUR INSTRUCTOR: Dr. Cristina Reitz-Krueger** fell in love with psychology as a means of answering questions about the world, including how to make it a safer, happier place. After working in non-profits for a number of years, she came back to the field and got her PhD in Community Psychology in 2014. Though her current research focuses on promoting sexual health among young people, she is also very interested in how to facilitate productive conversations between people of different backgrounds and political persuasions.



## HUMAN RIGHTS IN MOVING PICTURES

To puzzle. To educate. To explore. To challenge. To free. To heal. To transform. These are some of the powers of film. Much of what the world understands about human rights comes from cinematic depictions of injustice and violation, as well as survival, restoration, and triumph. In this course, we will view films that prompt us to consider how the field of global social work enacts principles of social justice, collective responsibility, and respect for diversities, in order to promote human rights, social change and development, social cohesion, and the empowerment and liberation of people. We will partner with a local non-profit organization to collaborate in community engagement that advances justice and inclusion. Films we will watch in the course include "War Witch," "Philomena," and "Rabbit-Proof Fence." This course is a great choice for those considering the social work or global studies majors or the pre-Peace Corps track.

YOUR INSTRUCTOR: **Dr. Lucy Lawrence** notes that as a farmer’s daughter, she always pondered the great wide world beyond the tobacco fields of North Carolina and chafed at the confines of traditional social and political expectations. Her professional career has been dedicated to international social work—Peace Corps Volunteer in Costa Rica, Oxfam America in El Salvador, graduate work in Lithuania, and research with immigrant Latinx in northeast Alabama. Her current professional interests include community engagement pedagogy, the study abroad experience in liberal arts education, and intercultural communication.



## **CAN A BABY BE DEPRESSED? EXPLORING THE SOCIAL AND EMOTIONAL WELL-BEING OF YOUNG CHILDREN**

Can a baby be depressed? Can families and schools place children at greater risk for challenges in mental health? We are understanding more about the significant role that a child’s social and emotional well-being plays in laying the foundation for life. In this seminar, we will explore how the contexts of family, school, and culture either help young children thrive or place them at increased risk for poor life outcomes. We will also look at current research and interventions that utilize developmental science to create programming and policies promoting well-being and that prevent behavioral and psychological problems. A sample of the topics we will explore: attachment relationships, Adverse Childhood Experiences (ACES), developmental screenings, strategies for challenging behaviors, the opioid epidemic’s role in foster care rates, intervention strategies, maternal depression, prenatal exposure to stress, long-term exposure to stress, resiliency, self-regulation, and spanking. If you enjoy working with young children, if you’re contemplating majoring in psychology or social work, or if think you might be a parent some day, you may want to join this course.

YOUR INSTRUCTOR: **Dr. Maura Davis** is a early childhood education professor with a background in early childhood mental health. For many years before coming to Warren Wilson, she consulted in area childcare settings to help support teachers who were confronting challenging behaviors in their classrooms. She is excited to share with you all the amazing things that babies and young children can teach us.

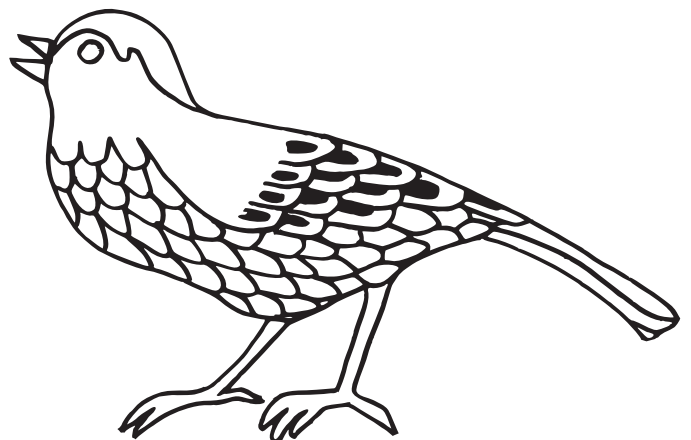

**The Three First-Year Seminars That Interest Me Most Are:**

Three empty rectangular boxes for students to write the names of their three most interesting seminars.

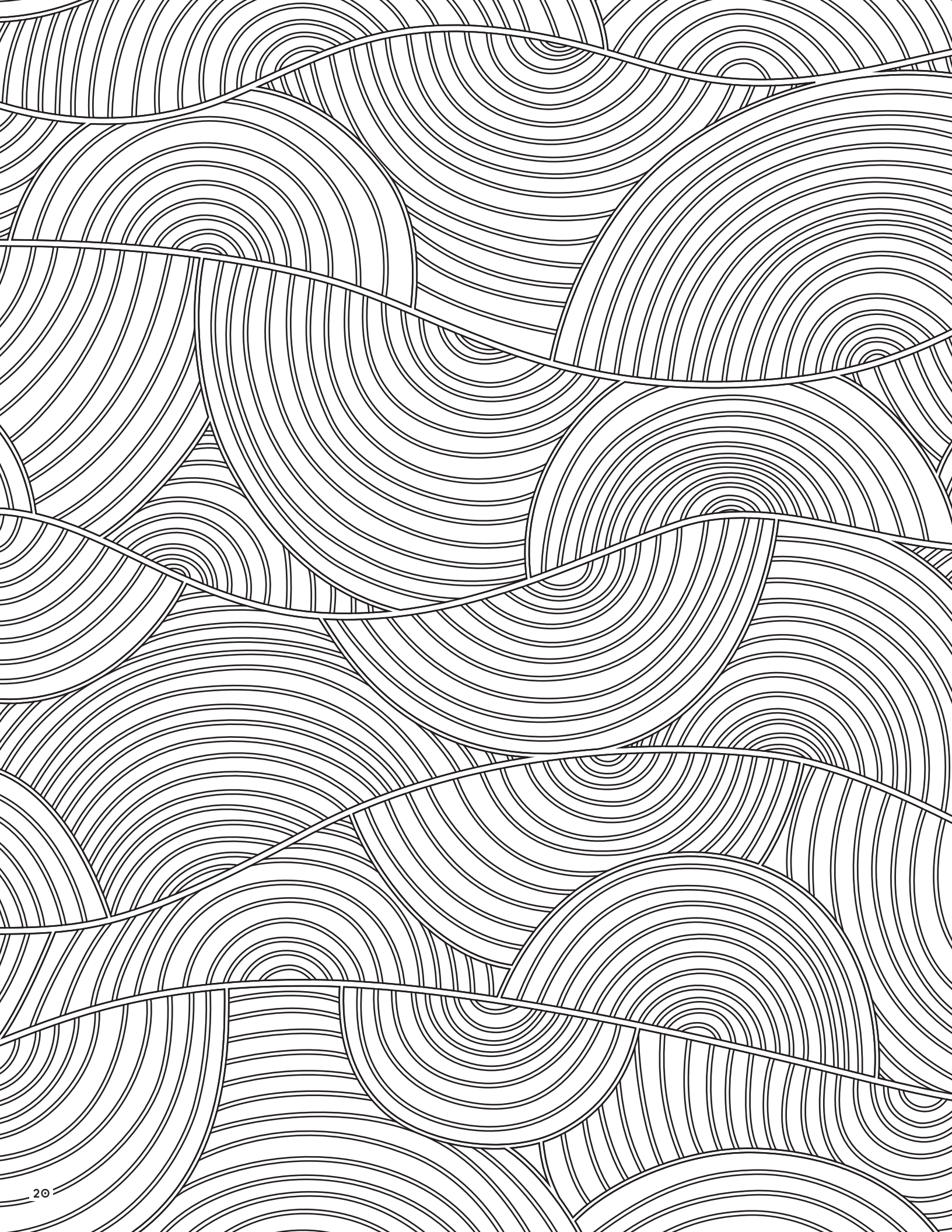

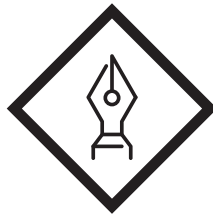

# Activity #4

Preparing for Academic Success

**20 MINUTES**

Read through pages 22–28. How will you best achieve academic success? Fill in some blanks.

Think about yourself as a writer. Write a haiku.

**DEADLINE: JULY 1, 2018**

# Academic Engagement & Support

Within Academic Support, students are offered assistance to become more effective, engaged, and intentional learners. Our services are designed to provide support for students of all academic levels and at all stages of their college careers. Check out the following two pages for a list of the services we provide.

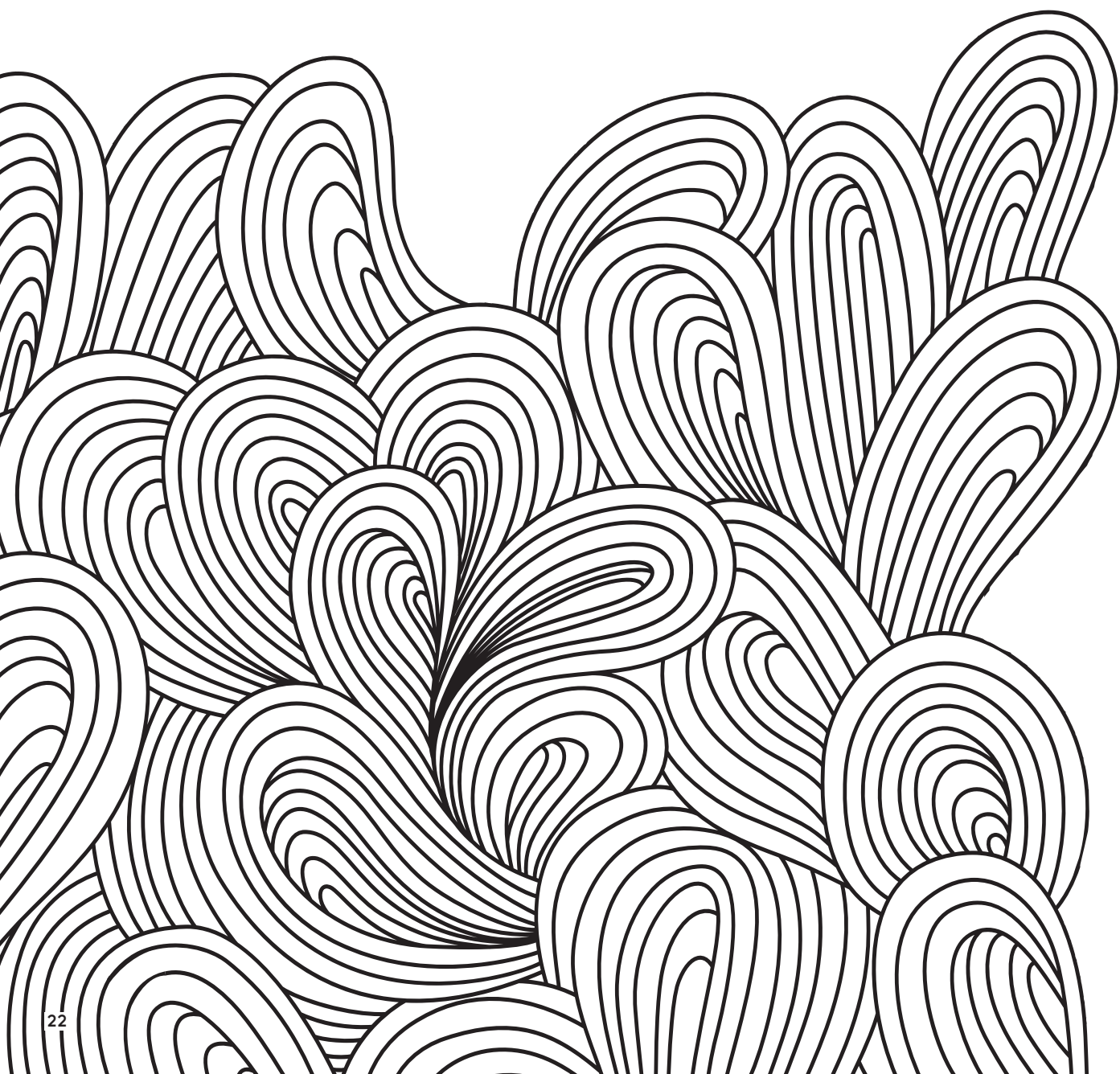

## DISABILITY ACCESS SERVICES

We assist students with documented disabilities by designing plans with reasonable, appropriate accommodations for full and equal access to their educational program and serving as a resource by providing consultation to students, faculty, and staff when implementing this plan.

For more information visit:

<https://warren-wilson.edu/academics/student-support>

You may also contact:

Deborah Braden, Assistant Director, Academic Support  
dbraden@warren-wilson.edu

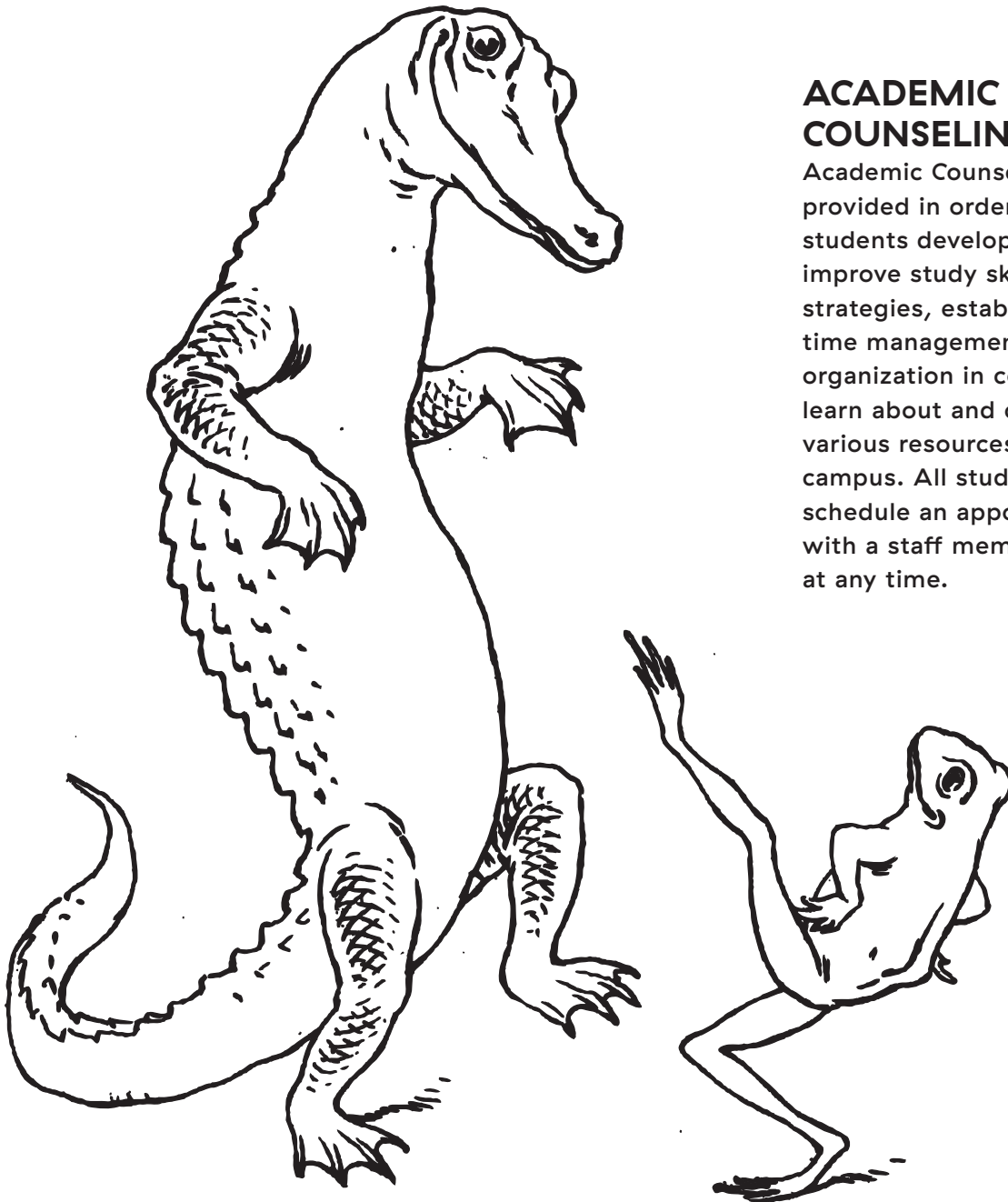

## ACADEMIC COUNSELING

Academic Counseling is provided in order to help students develop and improve study skills and strategies, establish better time management and organization in courses, and learn about and connect to various resources on campus. All students can schedule an appointment with a staff member online at any time.



## **ACADEMIC SUPPORT COURSEWORK**

We know that formal study can enhance learning, and we are pleased to offer academic support coursework. New students may be encouraged to consider taking:

### **EDU 1160: COLLEGE ACADEMIC STRATEGIES**

This pass/fail class explores the learning terrain and process. Each student is assigned to one instructor who works with the student to define and address areas of need or interest that will enhance their academic experience and performance. Topics covered may include learning and theory and general strategies, goal setting, time management, focus strategies, study skills, reading and note-taking techniques, exam preparation, and course scheduling support.

## **TUTORING SERVICES**

Individual and group tutoring are available through the math, chemistry, and biology departments, as well as Spanish language and English as a second language.



## FUTURE PLANNING

Now is the time to begin considering how you want to make the most of your Warren Wilson academic journey. Interested in pursuing an honors program within your major? Hoping to be Warren Wilson's next Fulbright recipient? Looking to complete an academic internship? Many of these academic experiences require you to get connected quickly with faculty and your academic advisor.

Take a few moments to reflect on what academic goals you'd like to set for yourself. Achieving these goals will be an important part of your academic experience.

Beginning my academic journey at Warren Wilson College feels \_\_\_\_\_  
\_\_\_\_\_. When it comes to classes, I plan to spend at least \_\_\_\_\_  
studying each week, and I am looking forward to \_\_\_\_\_  
with my professors. The idea of meeting one-on-one with a professor \_\_\_\_\_  
\_\_\_\_\_ me. I will make sure I am prepared by \_\_\_\_\_  
and \_\_\_\_\_. If I find myself needing any academic support, I plan on getting  
help by \_\_\_\_\_ and \_\_\_\_\_. I am most excited about learning  
\_\_\_\_\_  
\_\_\_\_\_.



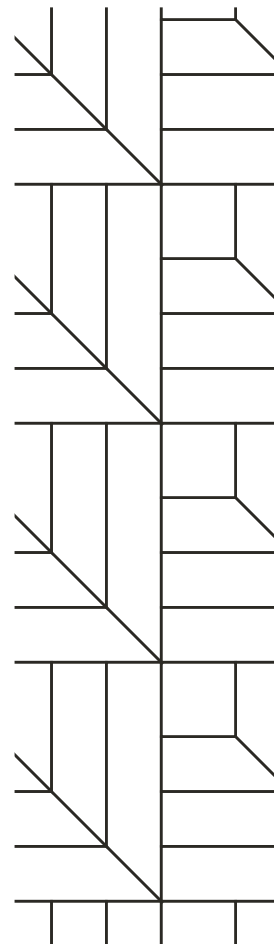
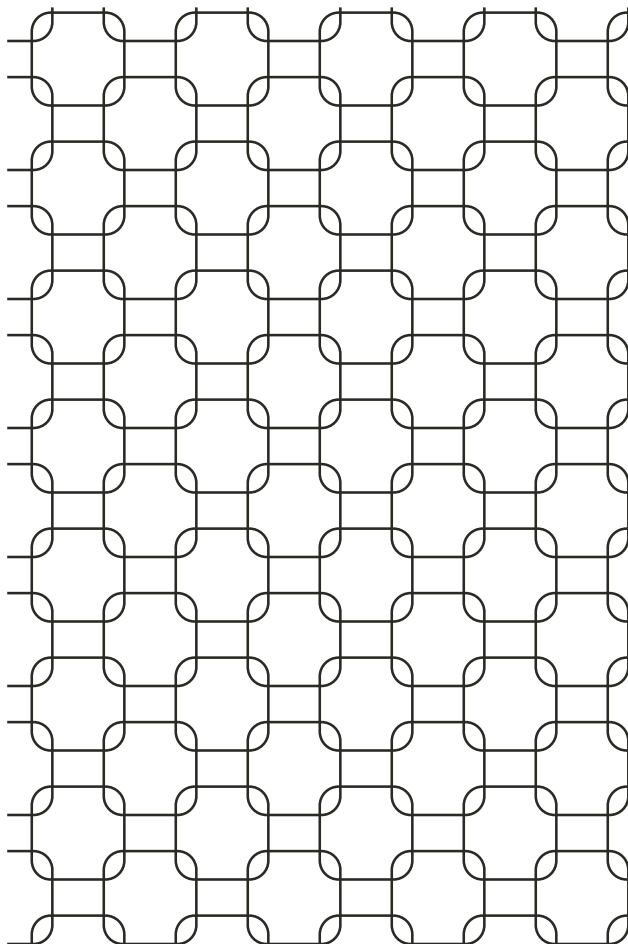
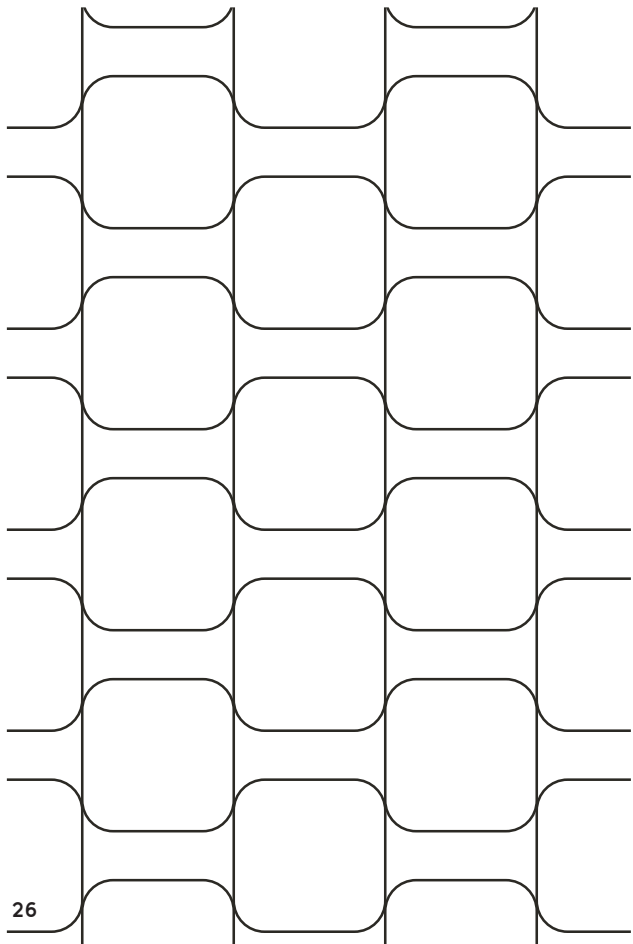
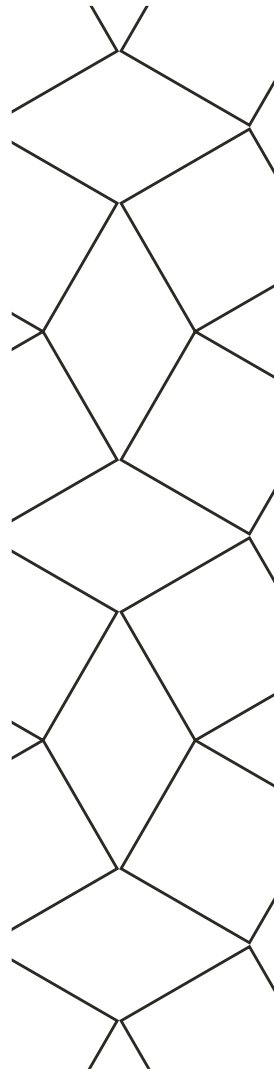
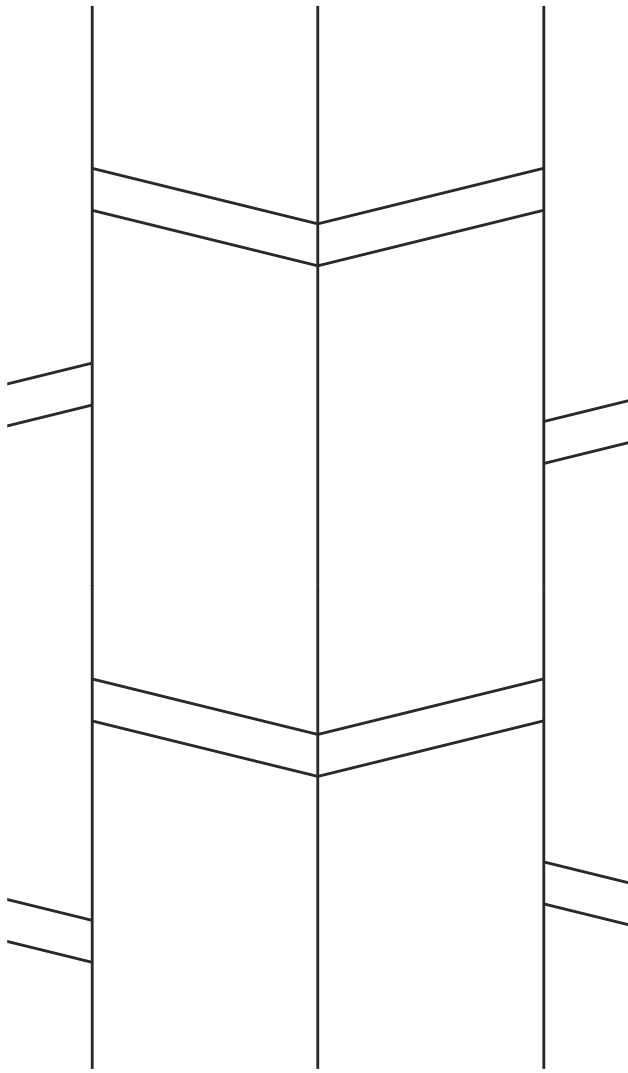
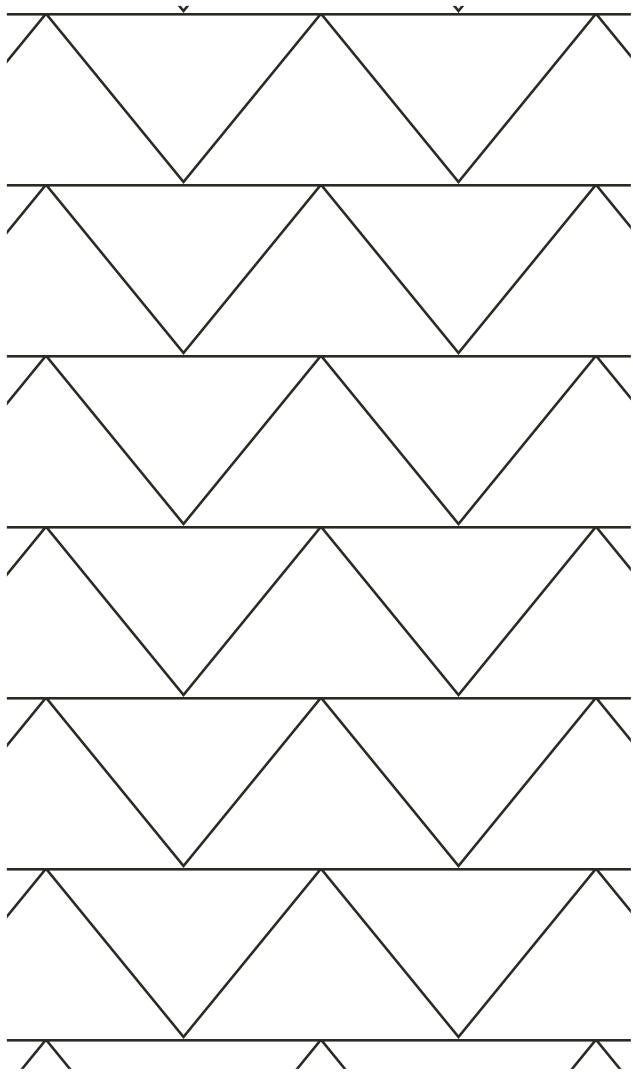

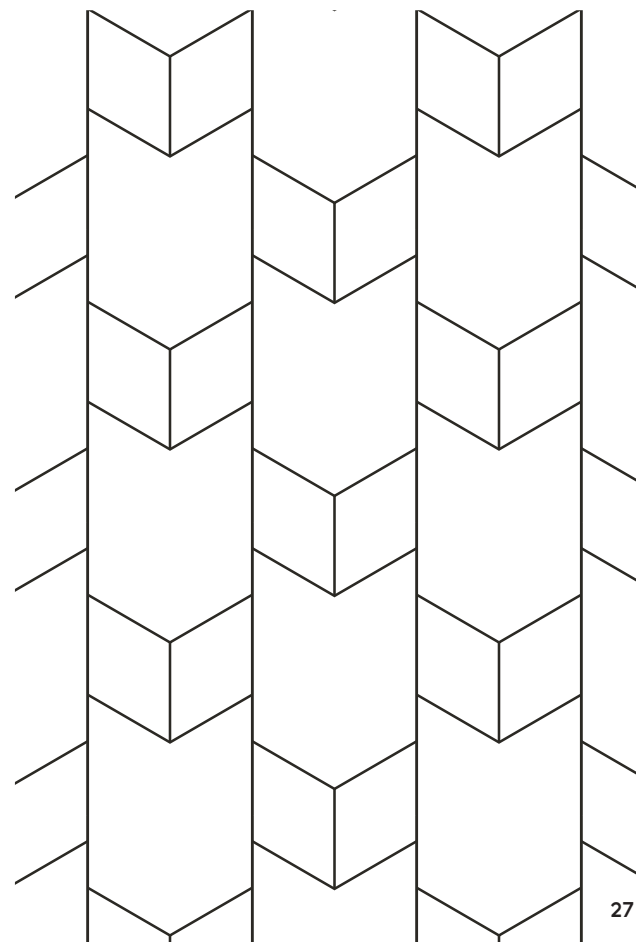
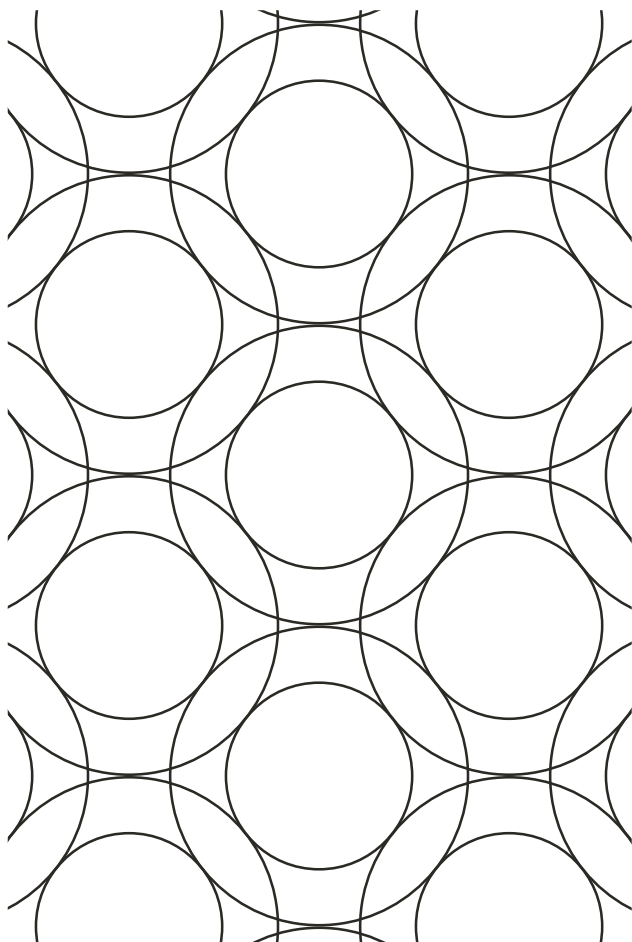
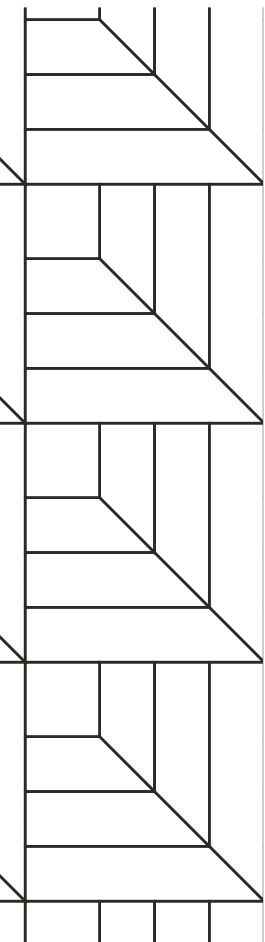
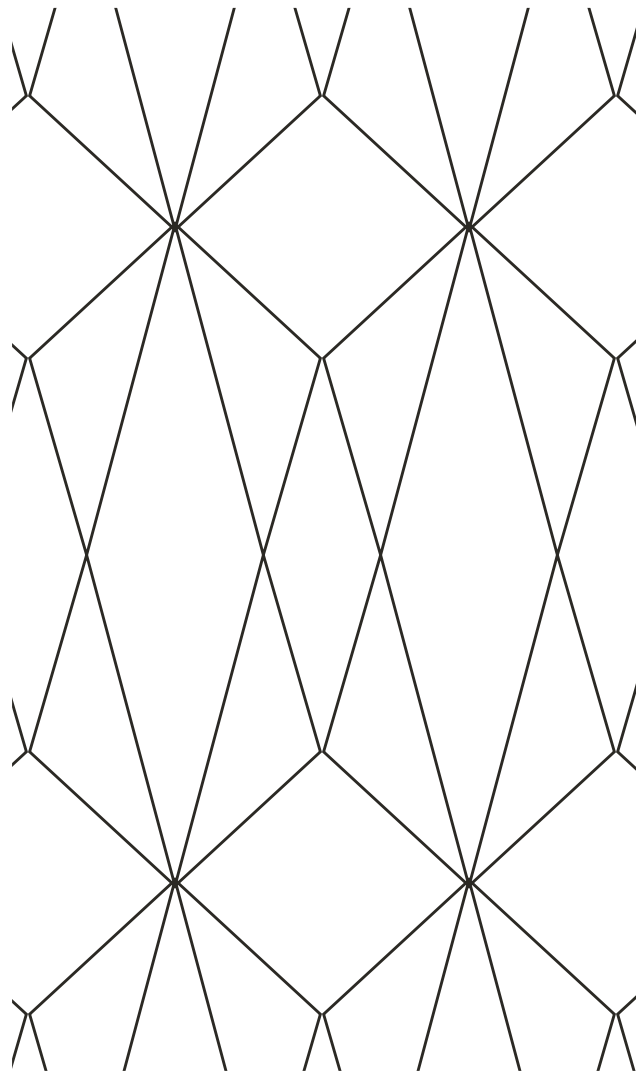
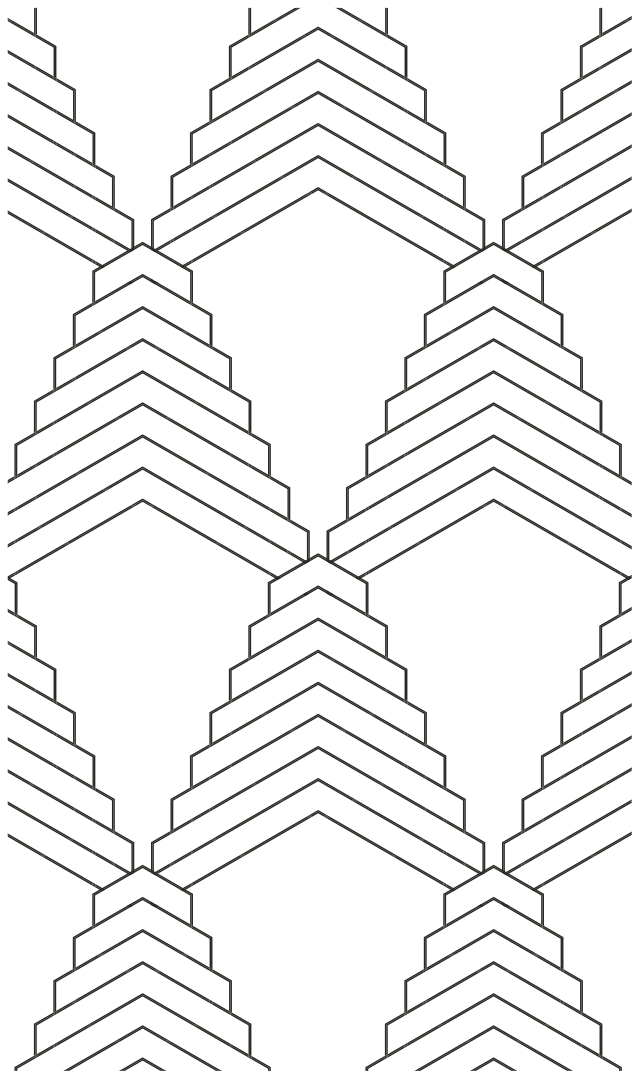
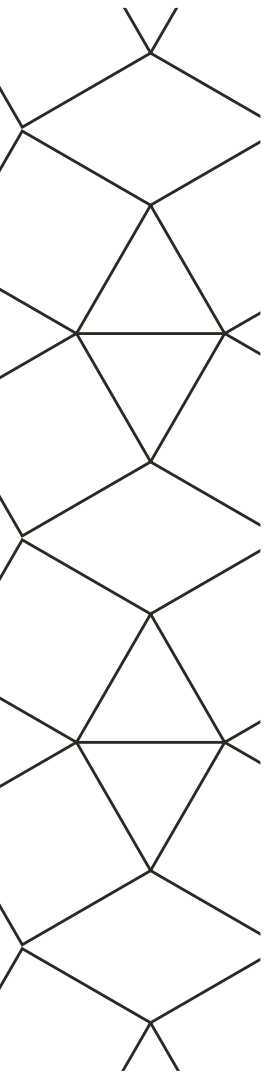

# Writing is a craft. Every craft deserves a studio.

Warren Wilson College's Writing Studio is a focused and productive place where any student may bring their assignments and projects, practice the craft of writing, and learn new writing techniques. Writing Assistants meet with you in individualized sessions to start, complete, or review work, including creative writing. The crew also produces two journals that showcase the fine creative and scholarly work of Warren Wilson students.

## WRITING STUDIO HAIKU

Put pen to paper  
(more likely finger to key)  
speak your soul with words

by Taylor Lawson  
class of 2016, Charlotte, NC  
Writing Studio Crew Member

---

---

---

---

---

How does the craft of writing feel to you? For some people, it's a need, as natural as breathing. For others, it feels foreign, confusing, difficult...Take a moment to write **your own haiku** about how it feels to you when you're writing...



# Activity #5

Where Are You Now?

**30 MINUTES**

Read through page 30–31. You'll learn about the CIRP Freshman Survey (TFS), why it's so important, and how you'll submit it. And then take a fun survey.

**DEADLINE: JULY 1, 2018**

**This activity is for freshmen only. Transfer student?  
Skip ahead to Activity #6.**

# Where are you now?

Ensuring that we are meeting your needs requires us here at Warren Wilson to occasionally ask you to participate in important survey instruments.

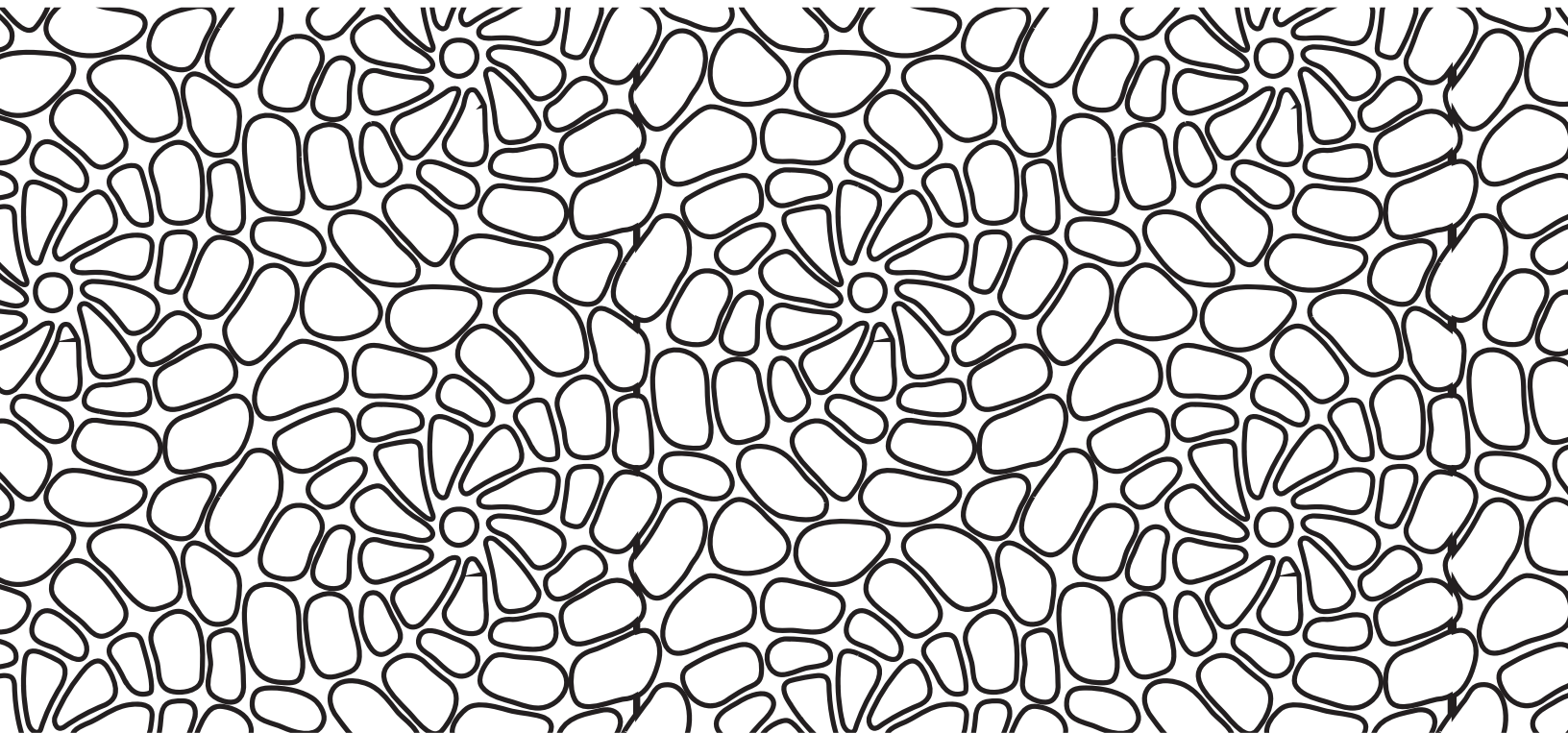

Warren Wilson College is deeply committed to assessing the needs of our students and developing support services and programming to ensure their success. One of the ways we do this for our incoming students is through a survey instrument called **TFS: THE CIRP FRESHMAN SURVEY**. Thousands of institutions across the United States and Canada have participated in TFS since its launch in 1972, and it assesses first-year students' high school experiences, their perspectives, and their expectations and concerns about college. Further, it determines what these entering students expect their institutions to provide them regarding opportunities and emphasis.

# And now, another survey, just for fun.

Let's find out how well you know Warren Wilson College, shall we?

1. How many barns are there on the Warren Wilson farm?  
a. 2    b. 6    c. Barns on barns on barns...    d. 3
2. What is the name of the Warren Wilson College special coffee blend?  
a. Dirt Worshipper    b. Night Owl    c. Mountain Morning Dew    d. Swanna-Nowhere Joe
3. What percent of the food served in our dining facilities is from local and/or on-campus sources?  
a. 18%    b. 52%    c. 9%    d. 34%
4. What are the names of our two draft horses?  
a. Salt n Pepa    b. Gold and Star    c. Doc and Dan    d. Harry and Sally
5. What species of tree is every Warren Wilson graduate given during commencement?  
a. White oak    b. Red spruce    c. Eastern hemlock    d. Pawpaw
6. Retired director of Alumni Relations, Rodney Lytle, narrowly missed out on landing a role in what classic 80's movie due to a scheduling conflict with his work on the Warren Wilson Heavy Duty crew?  
a. Back to the Future    b. The Karate Kid    c. Top Gun    d. Dirty Dancing





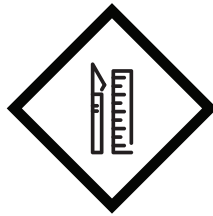

# Activity #6

Work and Community Engagement

**30 MINUTES**

Read through page 34. Think about yourself as a worker and as a community member, and follow the instructions to officially join our Work and Community Engagement programs.

**DEADLINE: JULY 1, 2018**

A decorative border of black line art illustrations of various flowers and leaves surrounds the text. The illustrations include tulips, daisies, and various leaf shapes, creating a lush, garden-like frame.

# Work & Community Engagement.

Undoubtedly a big part of why you chose Warren Wilson is our commitment to not only academic excellence, but also doing good in our communities through hard work and civic engagement. As you prepare to join our community, you will be assigned to a Work Crew. Additionally, our Center for Community Engagement will be working with you to identify the service experiences that will best fit your interests.

.....

## Work

To assist in assigning you to a Work Crew, you will need to complete your Work Crew Application here: <https://warren-wilson.edu/new-students>

## Community Engagement

In order to be a part of our Community Engagement program, all new students must:

- Log on to WWC GivePulse ([warren-wilson.givepulse.com](http://warren-wilson.givepulse.com)) with your WWC email address.
  - a) All incoming students have an account created in GivePulse. You do not need to create a new account!
  - b) First-time users must select "Forgot Password" to generate a new verification email message to create a password using your [@warren-wilson.edu](mailto:@warren-wilson.edu) email address.
  - c) Contact [engagement@warren-wilson.edu](mailto:engagement@warren-wilson.edu) should you encounter any issues.

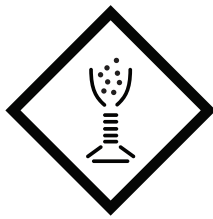

# Activity #7

Celebrate!

**60 MINUTES**

You did it! You completed the entire workbook.  
Bake a chocolate cake to celebrate!

# COWPIE CAFÉ'S Vegan Chocolate Cake

## SIFT DRY INGREDIENTS & SET ASIDE:

2 cups all-purpose flour  
2/3 cups cocoa powder  
1 1/2 tsp baking soda  
1 1/4 tsp baking powder  
1/8 tsp salt

## COMBINE & MIX:

2 cups soy milk  
1 Tbs apple cider vinegar  
1 1/4 cups sugar  
2/3 cup canola oil  
1/2 tsp vanilla extract

Add the sifted dry ingredients and mix just until all the flour is incorporated. **DO NOT OVERMIX!** Bake at 325° for 25–30 minutes or until a toothpick inserted comes out with just a few fudgy crumbs.

Enjoy!

