



ZERO SR/S™



ZERO MOTORCYCLES
2020 OWNER'S MANUAL

Motorcycle Information

For your reference, use this page to record information pertaining to your Zero SR/S. This information may be required when contacting your Zero Motorcycles Dealer so that they can be certain of its exact specification.

Dealer Information	Motorcycle Information
Name:	Model:
Address:	Vehicle Identification Number (VIN):
	Power Pack Serial Number:
	Motor Serial Number:
Telephone Number:	Key Code:
Email Address:	Date of Purchase:

Introduction	1.1	Controls and Components	3.1
Introduction	1.1	Controls and Components	3.1
An Important Message From Zero	1.1	Motorcycle Controls	3.2
California Proposition 65	1.1	Left Side View	3.4
California Perchlorate Advisory	1.1	Right Side View	3.6
About This Manual	1.2	Handlebar Controls	3.8
Useful Information For Safe Riding	1.2	Mode Button Operation	3.12
When To Charge Your Z-Force® Power Pack™	1.3	Ride Modes	3.13
Emissions Information	1.4	Cruise Control	3.16
Parts and Accessories	1.4	Heated Grips (if equipped)	3.17
Identification Number Locations	1.5	Front Brake Lever Adjuster	3.18
Vehicle Identification Number (VIN) / Chassis Number	1.5	Dash Overview	3.19
Power Pack Serial Number	1.5	Warning Indicator Lights	3.22
Motor Serial Number	1.5	Dash Quadrant Gauges	3.25
Safety Information	2.1	Dash Screens	3.27
General Safety Precautions	2.1	Preferences	3.28
General Safety Precautions	2.1	Battery	3.46
Important Operating Information	2.2	Performance	3.53
Location of Important Labels	2.3	Data	3.54
Location of Important Labels	2.3	Locking Your Helmet	3.58
High Voltage Warning Labels	2.4	Tank Storage Compartment	3.59

Starting and Operating	4.1	Maintenance	6.1
General Operation	4.1	Maintaining Your Motorcycle	6.1
Pre-ride Inspection	4.1	Owner's Responsibilities	6.1
Carrying Passengers and Cargo	4.2	Parts/Maintenance Items	6.2
Smartphone Application	4.3	Service History	6.2
Bluetooth® Pairing	4.3	Scheduled Maintenance	6.2
Keys	4.6	Component Fasteners	6.6
Key Switch/Steering Lock	4.7	Power Pack	6.9
Motorcycle Tip-Over Sensor	4.8	Power Pack	6.9
Kickstand	4.8	General Maintenance	6.10
Operating Your Motorcycle	4.9	Brakes	6.10
Vehicle Range	4.12	Suspension	6.14
Maximizing Your Range	4.13	Front Suspension Adjustment	6.15
Anti-lock Braking & Traction Control Systems	4.16	Rear Shock Adjustment	6.19
ABS (Anti-lock Braking System)	4.16	Wheels And Tires	6.23
Motorcycle Traction Control (MTC)	4.19	Drive Belt	6.24
Drag Torque Control (DTC)	4.22	Seat Removal	6.28
Charging and Power Pack Information	5.1	Headlight Alignment	6.29
Power Pack and Charging	5.1	Turn Signal Light Bulb Replacement	6.30
Power Pack	5.1	Brake/Tail LED Replacement	6.30
How to Identify your Charger	5.2	12 Volt Battery	6.31
Charging the Power Pack	5.3	12 Volt Accessory Connectors	6.33
Power Tank (if equipped)	5.5	Fuses	6.33
Charging Levels (Times)	5.5	Cleaning	6.37
Charging Cable Requirements	5.6	Parking and Long Term Storage	6.38
Add-On Electrical Equipment	5.7		

Troubleshooting	7.1	What Will Zero Do Under This Limited Warranty?	9.7
Troubleshooting	7.1	How Does This Limited Warranty Relate To State Law?	9.7
Electric Motorcycle Precautions	7.1	How Do You Obtain Service Under This Limited Warranty? ..	9.8
Troubleshooting Your Motorcycle	7.1	How Do I Transfer Ownership And The Limited Warranty? ..	9.8
System Notifications	7.2	Customer Information	9.9
Dash Error Codes	7.3	Customer Assistance	9.9
Cold and Hot Weather Considerations	7.7	Reporting Safety Defects	9.10
Safety Interlocks	7.9	 Maintenance Record	 10.1
Technical Specifications	8.1	Maintenance Record	10.1
Vehicle Identification Number	8.1	Service History	10.1
VIN Breakdown	8.1	 First Responder Information – High Voltage	
Specifications	8.2	Component Locations	
Zero SR/S (Europe)	8.2		
Zero SR/S (Rest Of The World)	8.6		
 Warranty and Customer Information	 9.1		
Limited Warranty Information	9.1		
Who Is The Warrantor?	9.1		
Who Does This Limited Warranty Cover?	9.1		
What Does This Limited Warranty Cover?	9.1		
What Is The Coverage Period Of This Limited Warranty?	9.2		
What Is Not Covered By This Limited Warranty?	9.3		
What Other Limitations Or Disclaimers Apply To This Limited			
Warranty?	9.5		
What Are Your Responsibilities As A Customer?	9.6		

An Important Message From Zero

Congratulations and thank you for purchasing the 2020 Zero SR/S electric motorcycle. We welcome you to our community of Zero Motorcycle riders.

For your best experience, we recommend that you take your time and carefully read this entire manual. This manual is designed to provide you with a better understanding of the operation, inspection, and basic maintenance requirements of your motorcycle.

Zero Motorcycles continually seeks advancements in product design and quality. Therefore, this manual contains the most current product information available at the time of printing.

Because of this, your motorcycle may differ from the information supplied in this owner's manual. No legal claims can be made on the basis of data in this manual. When it comes time to sell your Zero SR/S, please ensure that this manual stays with the motorcycle; it is, by law, an important part of the vehicle. If you have any questions concerning the operation or maintenance of your motorcycle, please contact your authorized Zero Motorcycles dealer.

For updates and additional information about your motorcycle, visit the Owner Resources section of the Zero Motorcycles website:

<http://www.zeromotorcycles.com/owner-resources/>

California Proposition 65



WARNING: Operating, servicing and maintaining a passenger vehicle or off-highway motor vehicle can expose you to chemicals including engine exhaust, carbon monoxide, phthalates, and lead, which are known to the State of California to cause cancer and birth defects or other reproductive harm. To minimize exposure, avoid breathing exhaust, do not idle the engine except as necessary, service your vehicle in a well-ventilated area and wear gloves or wash your hands frequently when servicing your vehicle. For more information go to www.P65Warnings.ca.gov/passenger-vehicle.

California Perchlorate Advisory



WARNING: Certain components of this motorcycle such as lithium batteries may contain perchlorate material. Special handling may apply for service or end of life disposal. See www.dtsc.ca.gov.

About This Manual

This manual covers the Zero SR/S motorcycle in both the standard and premium configurations. Standard equipment includes the Z-Force® ZF14.4 lithium ion Power Pack, Cypher III operating system, Z-Force ZF75-10 motor, belt drive, 17-inch cast wheels, street tires, regenerative braking, Bosch's anti-lock brake system ("ABS") and motorcycle stability control ("MSC"), and 3kW Rapid Charge Module with either a J1772 (Type 1) or Mennekes (Type 2) charge inlet. Premium equipment includes a second 3kW Rapid Charge Module, fly screen, aluminum bar ends, and heated grips.

Locating and referencing information

A good place to locate information about your motorcycle is in the index, located in the back of this manual.

The terms "right" or "left" refer to the rider's right or left while seated on the motorcycle.

Power pack and battery referencing

The Zero SR/S has equipped with high voltage battery pack, (referred to as a power pack) and a 12 volt battery.

Throughout the manual, references are made to the high voltage battery pack as a **power pack**, except for instances on the dash screens and notifications, where it is referred to as the **battery**.

Useful Information For Safe Riding

This manual contains two important words, which require extra attention while reading.

WARNING: Indicates something that could injure you or others.

CAUTION: Indicates things that could damage your motorcycle.

Please read this manual carefully and completely, before operating this motorcycle. Do not attempt to operate this motorcycle until you have attained adequate knowledge of its controls and operating features, and until you have been trained in safe and proper riding techniques. Regular inspections and proper maintenance, along with good riding skills, help you safely enjoy the capabilities and the reliability of this motorcycle. Disregarding the aforementioned, however, may invalidate the motorcycle's warranty.



This high voltage warning symbol is located in various locations on the motorcycle to inform you that exposure to high voltage can cause shock, burns, and even death.

The high voltage components on the motorcycle should only be serviced by specially trained technicians.

High voltage cables and wiring have a orange-colored insulation or covering. Do not probe, tamper with, cut, or modify high voltage cables or wiring.

When To Charge Your Z-Force® Power Pack™

Proper care of the motorcycle's power pack is essential! In order to maximize the life of your power pack(s), Zero Motorcycles has established the following guidelines for proper charging and operation.

- If the power pack is fully discharged, it must be charged within 24 hours to prevent damage to the power pack.
- If you ride regularly, but your ride doesn't require most of your power pack's capacity, your power pack will benefit from not being charged to 100% unnecessarily. In hot climates, going for a few rides before recharging will prolong your power pack's life by limiting the amount of time it spends parked at a high state of charge.
- If you ride infrequently, once per week or less, recharging the evening prior to when you need to be at full charge is much better for your power pack than charging it right after each ride and having it sit for days between rides at a high state of charge.
- If the power pack's state of charge is below 30%, we recommend you charge the power pack to at least 60% and then disconnect the charger.

CAUTION: Never store your motorcycle at a low state of charge (below 30% SoC). Leaving the power pack at a low state of charge for a prolonged period could damage it and void your warranty.

- If you ride in hot weather (>95°F / 35°C) or spend a majority of your ride at freeway speeds, the power pack will benefit from not being charged "hot". Allowing your pack a few hours to cool off prior to recharging will prolong its life. You may also benefit from off-peak electricity rates by waiting until the evening to charge.
- Once your motorcycle has been charged, we recommend that you disconnect the charger. The power pack will go into "hibernate mode" and self-discharge extremely slowly over time. So, if you haven't ridden it for a long while and need to charge it to 100% SoC, plug it in to the charger for a few hours prior to your ride. Unplugging the charger when not needed ensures the best long-term health of your power pack.
- For long term storage (>30 days) of your motorcycle, see ["Parking and Long Term Storage"](#), on page 6.38.
- To ensure best performance of your Zero motorcycle over its lifetime, please be certain that the motorcycle's firmware is up to date. If you have questions, please contact the nearest Zero Motorcycles dealer.

For other important information regarding the power pack, see ["Power Pack"](#), on page 5.1.

Emissions Information

The Zero SR/S electric motorcycle is a true freeway-capable zero-emissions vehicle under California Air Resources Board (CARB), U.S. Federal (EPA), and European Union standards. It uses no gasoline or other liquid fuel. It has no tailpipe and therefore no tailpipe emissions. It also has no exhaust or evaporative emissions. Because the Zero SR/S runs solely on electricity, it is the only kind of vehicle which actually gets cleaner in terms of air pollution each year, as the electricity grid gets cleaner and more renewable. Zero Emissions Vehicles (ZEVs) offer greater efficiency, and can help solve the serious air pollution, global warming, and energy security problems facing the country and the world.

Parts and Accessories

CAUTION: Only use Zero Motorcycles approved parts and accessories for your Zero SR/S. Parts and accessories for your Zero Motorcycle have been checked and tested for safety and suitability. Zero is unable to accept any liability whatsoever for parts and accessories which have not been approved for your Zero Motorcycle.

Zero Motorcycle accessories are designed to complement and function with other systems on your motorcycle. Your dealer can accessorize the motorcycle using genuine Zero accessories

A full line of approved parts, accessories and apparel can be found on the Zero website: www.zeromotorcycles.com/shop/

Vehicle Identification Number (VIN) / Chassis Number

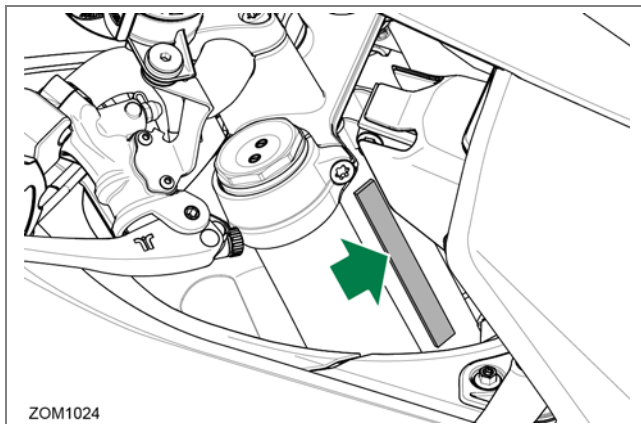

The VIN / Chassis Number is a 17-digit number stamped on the head tube of the frame. Do not alter or remove this number as it is the legal identifier for your motorcycle.

For information on the breakdown of the VIN, see [“Technical Specifications”, on page 8.1.](#)

For the location of other important labels, see [page 2.3.](#)

Power Pack Serial Number

The Power Pack serial number is located on the top and bottom surfaces of the power pack on the right hand side of the motorcycle. The serial numbers are hidden from view, when the motorcycle is fully assembled.

Motor Serial Number

The motor serial number is laser etched on the right hand side of the motor housing and is visible when the motorcycle is fully assembled.

General Safety Precautions

- This is a performance motorcycle and should be treated with extreme caution.
- Proper safety gear, including a regionally approved helmet, eye protection, riding boots, gloves, and protective clothing should be worn while riding to reduce the risk of potential injury. We highly recommend you ride with the correct protective clothing including full height riding boots. This recommendation applies even for short journeys and every season of the year.
- Read all additional warnings and product instructions in this owner's manual, as well as safety labels, before operating your electric motorcycle.
- Never permit another individual to ride your electric motorcycle without proper instruction.
- Never use alcohol or mind-altering drugs before operating your electric motorcycle.
- Persons unwilling or unable to take responsibility for their actions should not use this motorcycle. You assume all responsibility while operating your motorcycle. The seller assumes no liability for misuse or operator negligence.
- Prior to each use the rider must check everything in the "every ride" column of the maintenance schedule on [page 6.2](#), and the charge level of the power pack as indicated on the dash display charge indicator.
- Your safety depends in part on the good mechanical condition of the motorcycle. Be sure to follow the maintenance schedule and adjustment requirements contained in this manual. Be sure you understand the importance of checking all items thoroughly before riding.
- Modifications to the motorcycle may render the vehicle unsafe and may cause severe personal injury or to others. Zero cannot be held liable for non-approved modifications.
- Be very careful when loading or adding accessories to your motorcycle. Large, bulky, or heavy items may adversely affect the handling, performance, and effectiveness of safety systems of your motorcycle.

Important Operating Information

Several operating considerations are listed below:

- Always turn the key switch and motor stop switch to the OFF position when not actively riding. Due to the motorcycle's silent idle state, it is very easy to forget that the motorcycle is powered up.
- Always extend the kickstand to the down position to disable the drive system when not actively riding. An accident may occur if the motorcycle is powered up while getting on or off the motorcycle and the throttle is twisted.
- Toggle the motor stop switch to the OFF position when backing up or pushing the motorcycle while dismounted.
- Using the rear brake when you are stopped on an incline uses less energy than using partial throttle for hill-holding. Using partial throttle for hill-holding will heat up the motor and potentially limit peak power and torque until the motor cools. The more throttle required to hill-hold, the more heat will be generated in the motor.
- If you plan on riding again the next day or the power pack's state of charge is less than 30%, plug your motorcycle into an AC power source to recharge it. Always use a UL or CE-approved J1772 (Type 1) or Mennekes (Type 2) outlet adapter with your motorcycle as these have been approved for use with the Zero Motorcycles Rapid Charging System.

- While unplugged with the key switch in the OFF position, the motorcycle's electronics will consume a very small amount of power and the power pack will drain extremely slowly. If the motorcycle has been unused for more than 30 days, disconnect all chargers and turn the key switch to the ON position to exit long term storage mode and then allow it to charge for 24 hours to ensure optimal power pack balance is restored.

CAUTION: Only charge the Zero power pack with the motorcycle's on-board charger or an approved Zero accessory charger.

- The power pack does not require nor benefit from deep discharging. Leaving a power pack in a discharged state will cause damage. [“When To Charge Your Z-Force® Power Pack™”, on page 1.3.](#)
- Failure to follow power pack storage and charging instructions as described in this Owner's Manual may void the warranty of your Zero Motorcycle. These guidelines have been rigorously tested to ensure maximum power pack efficiency and life.

Location of Important Labels

The motorcycle could contain the following information for both North American and European models:

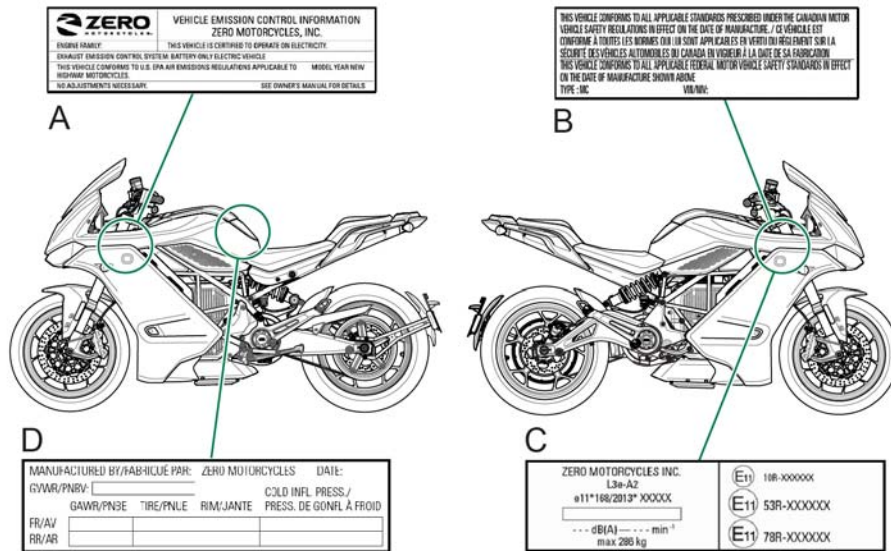

ZOM1004

- A. VECI (Vehicle Emission Control Information) label
- B. VIN label (North America) - certification label

- C. VIN label (European Union) - certification label
- D. Tire and loading information label

High Voltage Warning Labels

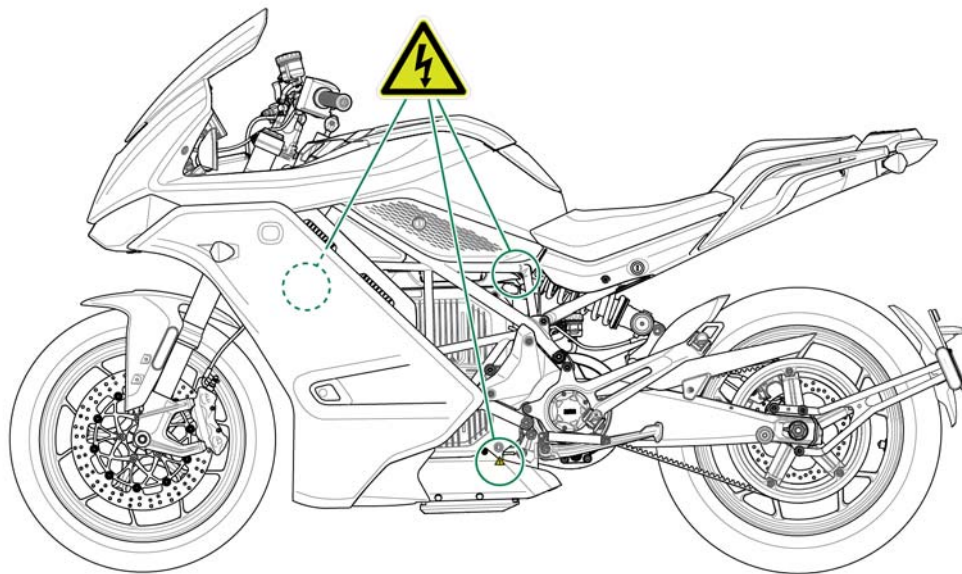

ZOM1003

WARNING: Beware of areas with high voltage warning labels. For the location of other high voltage components, see [“First Responder Information – High Voltage Component Locations”](#).

For additional information, see [“Power Pack”](#), on page 5.1.

This Page Intentionally Left Blank

Motorcycle Controls

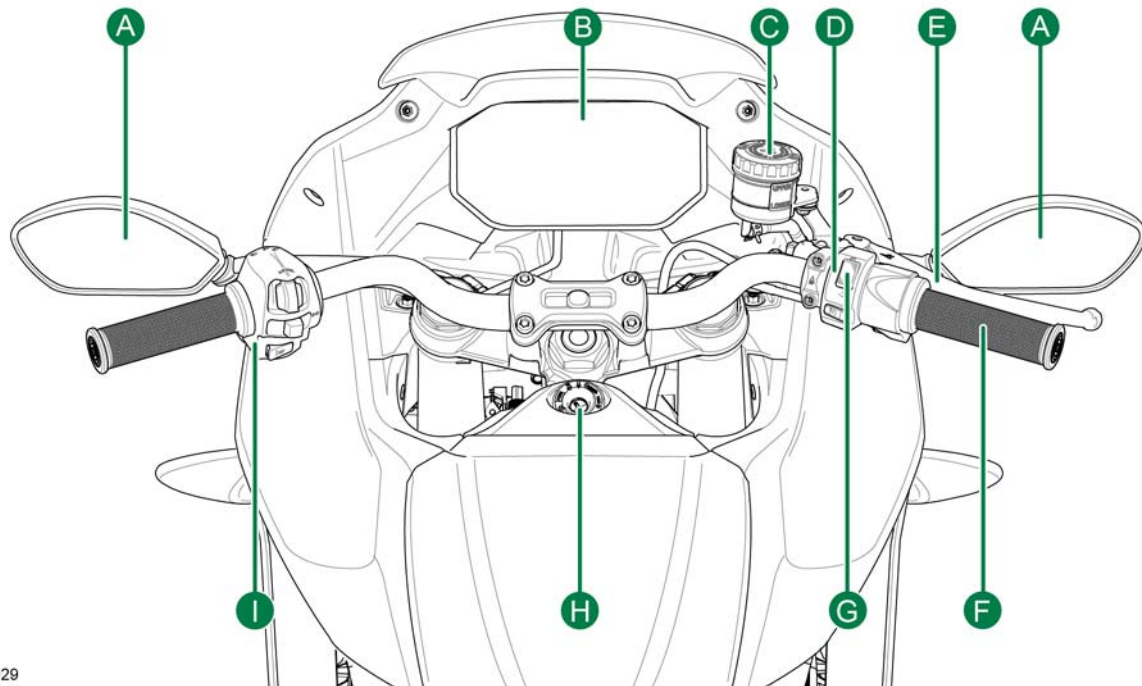

ZOM1029

A. Mirrors

This motorcycle is equipped with convex mirrors. A convex mirror has a curved surface. Convex mirrors offer a greater field of view than a similar flat mirror. However, the greater field of view makes objects seem further away than they really are. Care must be used when judging the distance of objects seen in these mirrors.

B. Dash

For description and operation, see [“Dash Overview”](#), on page 3.19.

C. Front Brake Fluid Reservoir

For description and operation, see [“Brakes”](#), on page 6.10.

D. Right Handlebar Control

For description and operation, see [“Handlebar Controls”](#), on page 3.8.

E. Front Brake Lever

For description and operation, see [“Handlebar Controls”](#), on page 3.8.

F. Throttle Control

For description and operation, see [“Handlebar Controls”](#), on page 3.8.

G. Motor Stop Switch

For description and operation, see [“Handlebar Controls”](#), on page 3.8.

H. Key Switch/Steering Lock

For description and operation, see [“Key Switch/Steering Lock”](#), on page 4.8.

I. Left Handlebar Control

For description and operation, see [“Handlebar Controls”](#), on page 3.8.

Left Side View

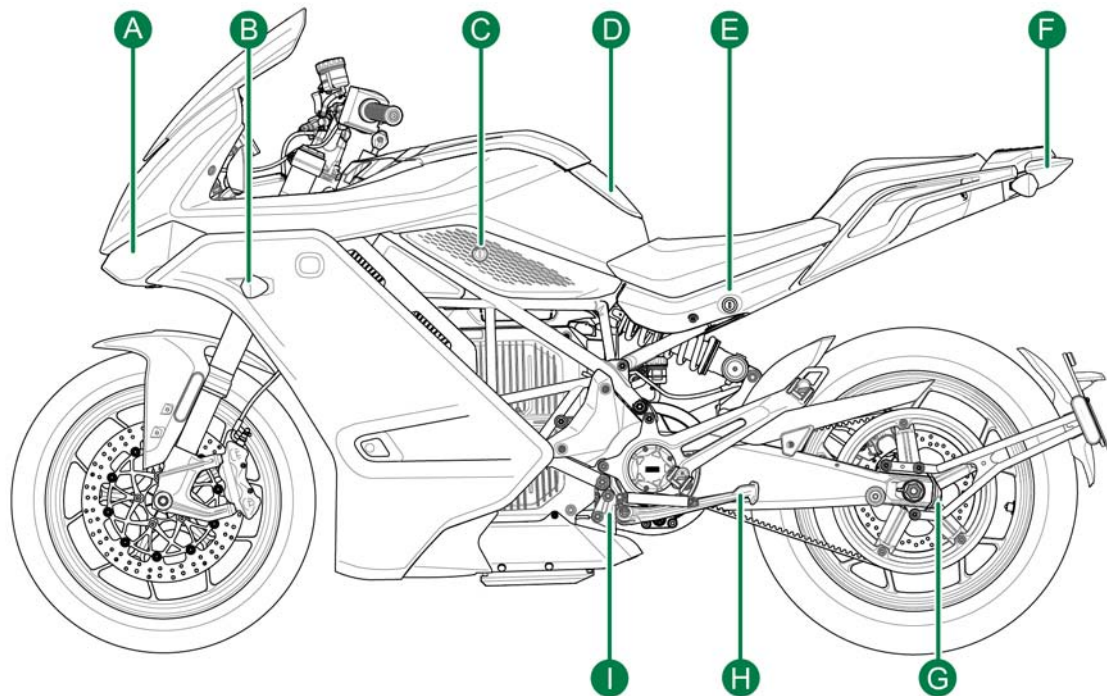

ZOM1005

A. Headlight

- For headlight operation, see [“Handlebar Controls”](#), on page 3.8.
- For headlight alignment, see [“Headlight Alignment”](#), on page 6.29.

B. Front Turn Signal

- For turn signal operation, see [“Handlebar Controls”](#), on page 3.8.
- For turn signal light bulb replacement, see [“Turn Signal Light Bulb Replacement”](#), on page 6.30.

C. Tank Storage Lock

Lock for motorcycle tank storage compartment, see [“Tank Storage Compartment”](#), on page 3.60.

D. Charger Power Connection

For description and operation, see [“Power Pack”](#), on page 5.1.

E. Passenger Seat Lock

Lock used to secure passenger seat to frame and provide access to helmet lock hooks, see [“Locking Your Helmet”](#), on page 3.59.

F. Brake/Tail Light

For brake/tail light replacement, see [“Brake/Tail LED Replacement”](#), on page 6.30.

G. Drive Belt Tension Adjuster

Located on left and right side. See [“Drive Belt Adjustment Procedure”](#), on page 6.27 for additional information.

H. Kickstand

The kickstand swings out from the side and supports the motorcycle when parked. The key switch should be in the OFF position when parked.

I. Kickstand Switch

This switch is a safety feature that prevents motor operation when the kickstand is down. If the kickstand were down when riding it could contact the ground causing you to lose control of the motorcycle and cause personal injury.

CAUTION: Park only on a flat firm surface, otherwise the motorcycle could fall over, causing damage.

Right Side View

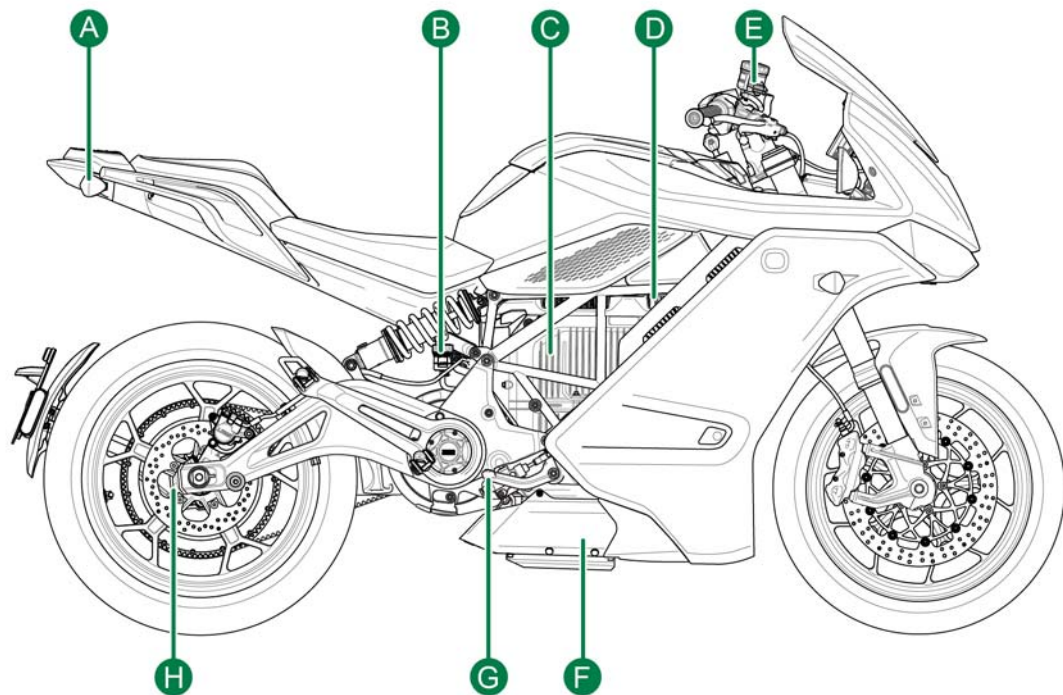

ZOM1006

A. Rear Turn Signal

- For turn signal operation, see [“Handlebar Controls”](#), on page 3.8.
- For turn signal light bulb replacement, see [“Turn Signal Light Bulb Replacement”](#), on page 6.30.

B. Rear Brake Fluid Reservoir

See [“Rear Brake Fluid Reservoir”](#), on page 6.11.

C. Power Pack

For description and operation, see [“Power Pack”](#), on page 5.1.

D. Integrated Power Pack Charger

For description and operation, see [“Power Pack”](#), on page 5.1.

E. Front Brake Fluid Reservoir

See [“Front Brake Fluid Reservoir”](#), on page 6.11.

F. 3-Phase AC Synchronous Controller

Precisely “meters” the flow of electricity from the power pack to the motor according to the action of the throttle and riding conditions.

G. Rear Brake Pedal

The rear brake pedal controls the rear brake when the pedal is pressed down. When braking, the throttle should be in the closed position. The brake light illuminates when the rear brake pedal is applied.

H. Drive Belt Tension Adjuster

Located on left and right side. See [“Drive Belt Adjustment Procedure”](#), on page 6.27 for additional information.

Handlebar Controls

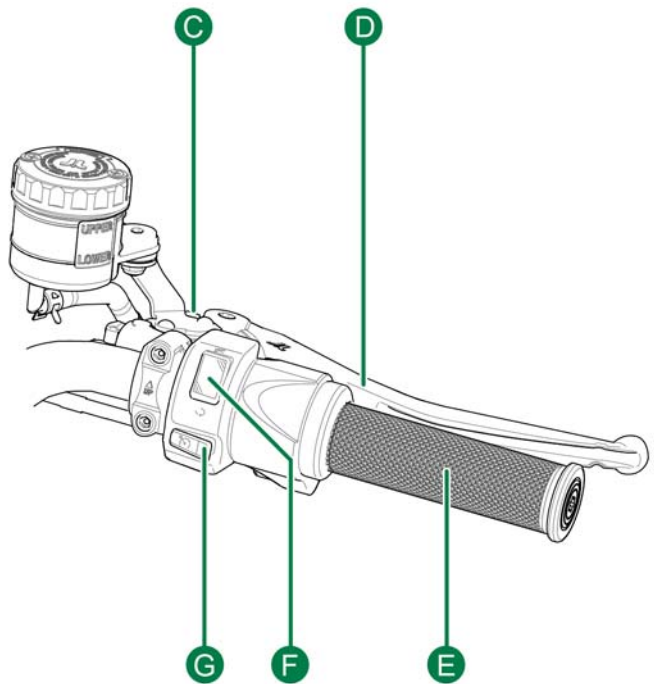
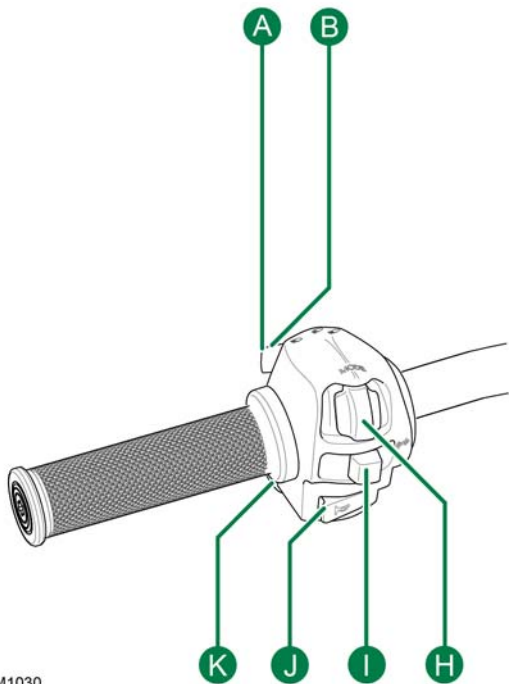

ZOM1030

A. Headlight High/Low Beam Switch

When the switch is pushed, the headlight changes from low beam to high beam. It stays in the selected position until it is switched back. When in high beam position, the high beam indicator on the left side of the dash illuminates.

B. Flash-to-Pass

When the headlight is in the low beam position, push the flash-to-pass switch and the high beam illuminates and stays illuminated until the switch is released. When released, this switch defaults back to the low beam position. The high beam indicator on the dash also illuminates.

C. Front Brake Lever Adjuster

Adjustment knob used to set front brake lever position.

D. Front Brake Lever

The front brake lever controls the front brakes when the lever is squeezed. When braking, the throttle should be in the closed position. The brake light also illuminates.

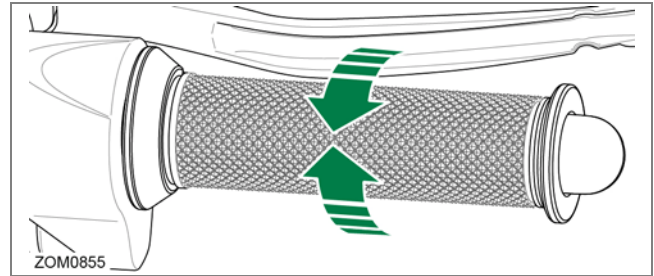
E. Throttle Control

Twist the throttle in a counter-clockwise rotation to energize the motor and start the motorcycle in a forward direction. Release the throttle and it automatically returns back to the closed position, which will engage regenerative braking while the motorcycle is in motion.

When the motorcycle is moving and the throttle control is in the fully closed position, the regenerative braking feature activates. Regenerative braking takes some of the energy from the moving motorcycle and turns it back into electrical energy. This energy is then stored in the power pack, contributing to increased energy efficiency. A slight drag is felt when the regenerative braking is activated. If you want to coast without the regenerative braking, hold the throttle at zero-torque point just, off of the fully closed position. The zero-torque point changes with speed and ride mode.

F. Motor Stop Switch

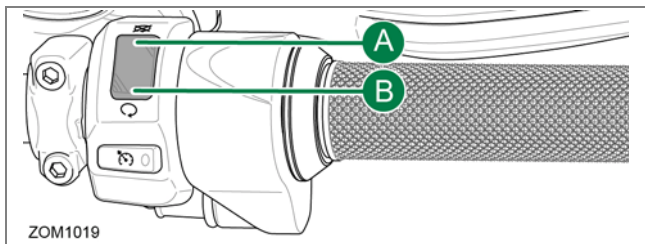

When the top of the switch (A) is pressed, it cuts off power to motor. The motor controller remains in this state until the bottom portion of the switch (B) is pressed. The switch does not turn off all electrical circuits, it only stops current flowing to the drive motor.

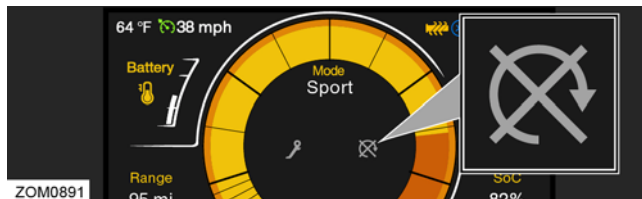

Note: The motor stop switch indicator will illuminate in the center of the dash when the kickstand is retracted.

G. Cruise Control Switch

See [“Cruise Control”](#), on page 3.16.

H. Mode Button

See [“Mode Button Operation”](#), on page 3.12.

I. Turn Signal Switch



When the turn signal switch is pushed in the left or right position, the corresponding front and rear turn signals flash. When the turn signal switch is ON, the corresponding turn signal indicator on the side of the dash also illuminates.

Canceling the turn signal function:

- The self-canceling feature will extinguish the turn signal automatically. This feature requires forward motion of the motorcycle to function.
- Manually press the turn signal switch button inward.

Always signal your turns and other maneuvers as required by law.

J. Horn Button

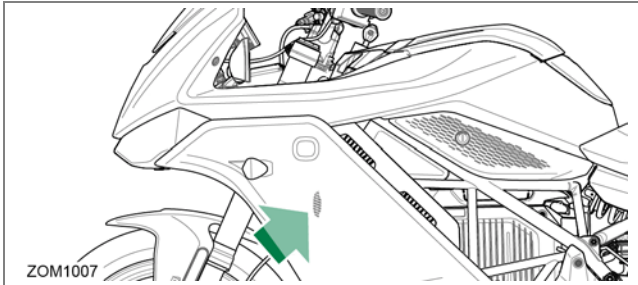

When the key switch is in the ON position, the horn sounds when the horn button is pressed. Electric vehicles run quietly; the horn can be used to warn pedestrians or other motorists of your presence.

K. Hazard Warning Flasher Switch

When the switch is pressed, the turn signals flash to warn other drivers of situations, which include needing to stop or park, under emergency conditions. When the switch is pressed again, the hazard warning lights will stop flashing.

Note: To operate the hazard warning flashers with the key switch in the OFF position, first turn the key switch to the ON position, press the hazard warning flasher switch to power the circuit, and then turn the key switch to the OFF position.

Mode Button Operation

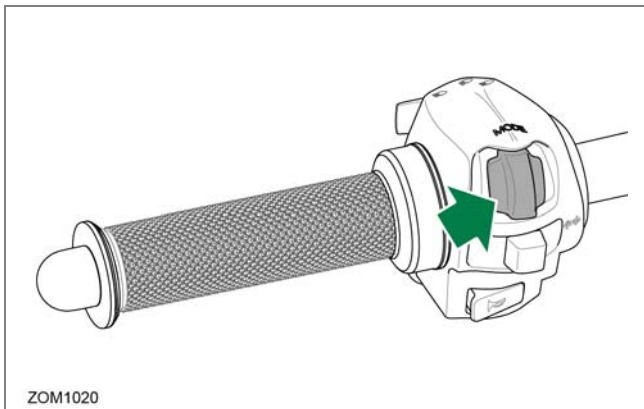

This section describes how to use the MODE button, which allows the rider to make selections from the menu and riding screens displayed on the dash.

Before explaining the functionality of the MODE button, first familiarize yourself with the following terminology of its operation. These terms will be widely used throughout this manual to explain how to navigate the dash menus and make selections.

MODE button operation terminology

- Tap (Left or Right) - A quick momentary slide of the MODE button to the left or right.
- Slide (Left or Right) - A slide of the MODE button to the left or right and hold for approximately 0.5 seconds.
- Hold (Left or Right) - A slide of the MODE button to the left or right and hold for approximately 1 second.
- Press - A press directly inward from the center resting position of the MODE button.

MODE button functions

- Tap Left - For scrolling upward through the menu options.
- Tap Right - For scrolling downward through the menu options or to make selections.
- Slide Left - For returning to the previous menu (and entering optional heated grips menu, while in Riding Screen mode).
- Slide Right - For entering Traction Control menu, while in Riding Screen mode.
- Hold Left - For returning to the Riding Screen while in any menu screen.
- Press - For engaging selected settings and menu options.

Ride Modes



Your motorcycle left the factory with the following default ride modes **ECO**, **STREET**, **SPORT**, and **RAIN**. Using your smartphone application, you can create and modify a **CUSTOM** ride mode.

To change Ride Modes

1. From the Riding Screen, with the Motor Stop switch in the ON position and the kickstand in the up (retracted) position, press the MODE button and release after approximately 1 second to access the ability to change ride modes.
2. Tap the MODE button to the left or right to toggle through the ride modes (**ECO**, **STREET**, **SPORT**, **RAIN**, and **CUSTOM**).
3. Once the ride mode is chosen, slide the MODE button to the left and hold for 1 second. Doing so, exits the current mode and the selected ride mode will take effect.

Note: You can switch between modes while riding, but if the throttle is engaged, the change will not be executed until the throttle is returned to the closed position. If the throttle is closed when switching modes, the change will take effect immediately.



The **ECO** selection reduces the acceleration and top speed of the motorcycle to 75 mph (120 km/h) but increases the amount of regeneration when the throttle is released. It is an ideal mode for when you want softer acceleration. This mode is also good for newer riders and for extending range. The **ECO** riding screen features green accented color.

Controls and Components



The **STREET** selection keeps acceleration and regenerative braking at a comfortable middle ground for everyday use. The torque and power are increased over ECO, but less than SPORT. The regenerative braking is greater than RAIN, but less than ECO and SPORT. The **STREET** riding screen features Synapse Blue accented color.

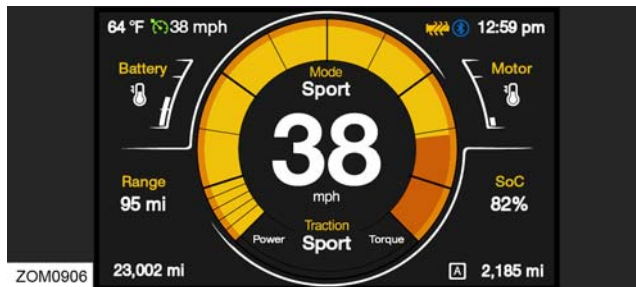

The **SPORT** selection allows the motorcycle to accelerate at a significantly faster rate than other modes. Compared to ECO, the amount of regeneration is decreased when the throttle is released. This mode is recommended for advanced riders. The **SPORT** riding screen features orange accented color.



The **RAIN** mode selection reduces the acceleration and top speed of the motorcycle to 100 mph (160 km/h) and provides the least amount of peak torque of ECO, STREET, and SPORT ride modes. Of all factory ride modes, it features the lowest amount of regenerative braking when the throttle is released, due to being designed for low traction conditions. The **RAIN** riding screen features blue accented color.





The **CUSTOM** mode selection is pre-installed from the factory with identical settings to STREET mode. To customize these settings, use the Zero Motorcycles smartphone application. Once this ride mode is created (ex. "USER1"), it can be uploaded to the motorcycle in place of the CUSTOM ride mode. By default, the **CUSTOM** riding screen features Synapse Blue accent colors. Using the Zero Motorcycles smartphone app allows the rider to select a preferred accent color.

Accent Colors:

- Blue
- Green
- Orange
- Synapse Blue
- Red

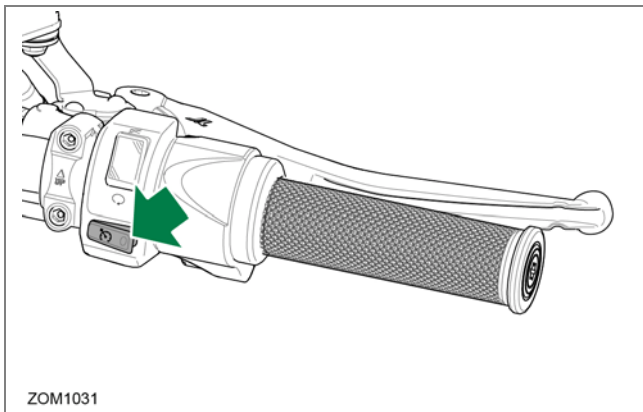
Cruise Control



 Press the cruise control button (see arrow) and hold for 0.5 seconds (long press) to activate cruise control functionality. The cruise control icon will illuminate on the dash when its functionality is enabled.

Minimum cruise control speed: 18 mph (30 km/h)

Maximum cruise control speed: 89 mph (144 km/h)

To set desired cruise control speed

1. When the motorcycle is traveling at the desired cruising speed, press cruise control button and hold for 0.5 seconds (long press).

2. Press cruise control button once (quick press) to set the cruising speed. The selected cruising speed will display next to the cruise control icon on the dash.



Note: Motorcycle must be traveling between the minimum and maximum cruise control speed before the cruise control functionality will be initiated. If cruise control speeds are selected while the motorcycle is traveling at speeds outside these parameters, they will not take affect until those speed parameters are met.

To disable selected cruise control speed

- Press cruise control button once (short press).
- Apply front or rear brake.

Note: There is no method for incrementally increasing or decreasing the speed with input from controls. To set a new speed, the rider must disable the current selected speed and set a new cruise speed.

To disable cruise control functions

- Press the cruise control button and hold for 0.5 seconds (long press). When the cruise control has been disabled, its dash icon will extinguish.

Heated Grips (if equipped)

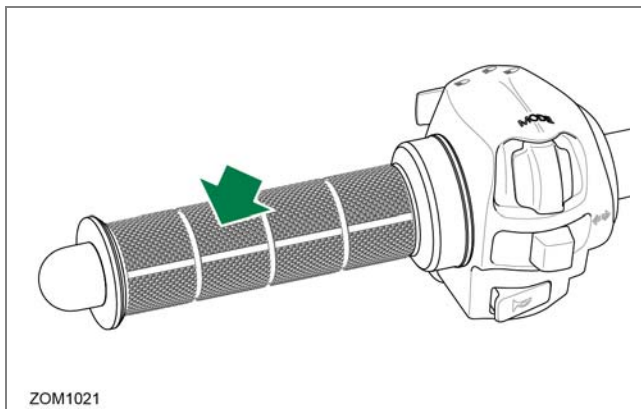

Your Zero Motorcycle may be equipped with heated grips. The Zero Motorcycles heated grips have a molded grid pattern (see arrow), which distinguishes them from standard option (non-heated) grips.

With key switch in the ON position

1. From the Riding Screen, slide the MODE button to the left to enter the heated grips menu (the heated grip option window will pop up on the screen).



2. Using the MODE button, tap left or right to scroll through the circular menu of heat options (Off, Low, Medium, and High).
3. Press the MODE button to select the desired heat level option. The heated grip icon will turn amber on the dash screen when the grips are powered. The icon will turn gray when the grips are powered off.



Note: Heated grip options can be adjusted while riding the motorcycle. It is not necessary to come to a stop to adjust the heated grips.

Front Brake Lever Adjuster

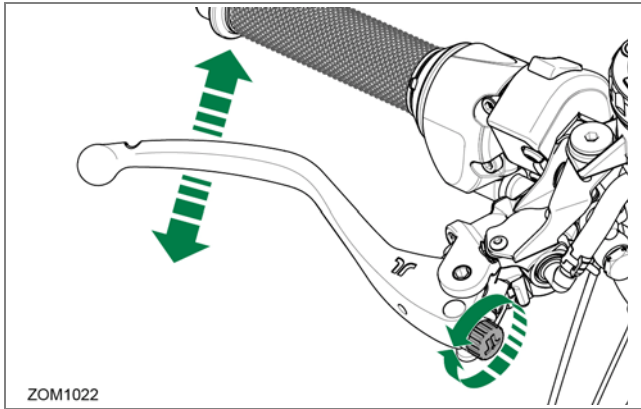

The position of the front brake lever can be adjusted by turning the adjustment knob (shaded) located on the pivoting end of the lever. Turning the knob clockwise or counter-clockwise will adjust the distance between the lever and the throttle control.

Dash Overview

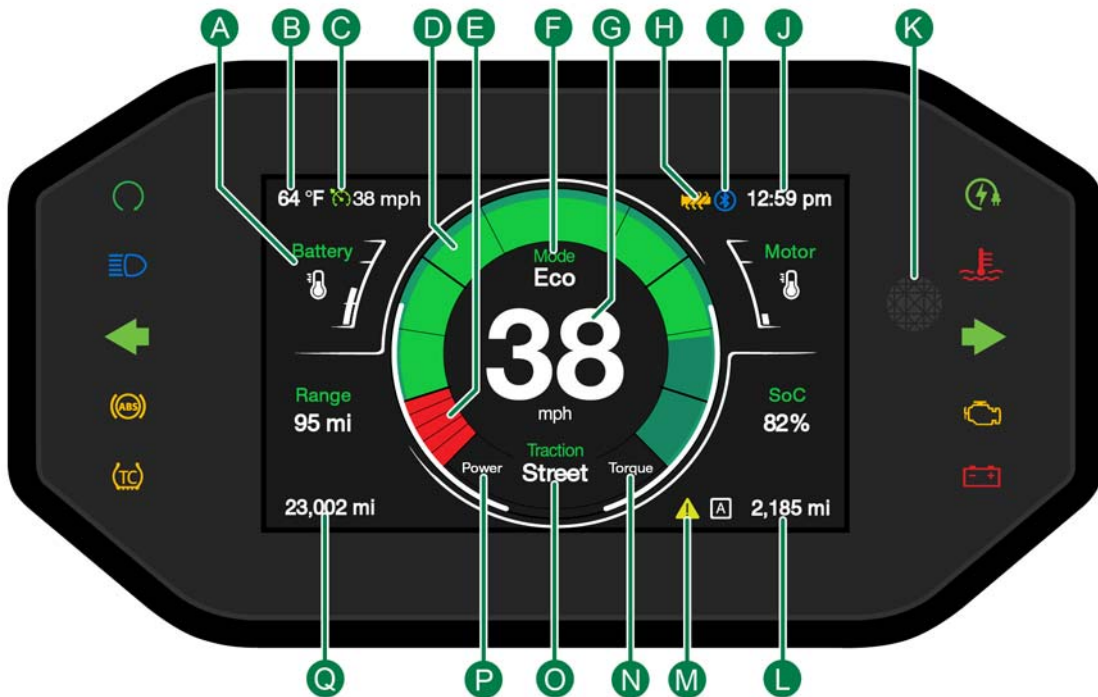

ZOM1040

A. Gauges

There are four quadrants around the charge indicator that can be customized with different gauges or left blank. See [“Dash Quadrant Gauges”, on page 3.25.](#)

B. Temperature

The ambient air temperature displays in °F or °C mode. See [“Units \(Displayed\)”, on page 3.43.](#)

C. Cruise Control

The cruise control indicator will illuminate when cruise control is enabled and selected cruise speed will display. See [“Cruise Control”, on page 3.16.](#)

D. Charge Indicator

The charge indicator gauge displays the amount of energy remaining in the power pack.

E. Low State of Charge Indicator

When the power pack’s SoC drops to 10%, the remaining gauge segments will change to red. The segments return to the proper color when SoC above 10% is obtained.

F. Ride Mode

This location shows the Ride Mode (ECO, STREET, SPORT, RAIN, and CUSTOM). See [“Ride Modes”, on page 3.13.](#)

G. Speedometer

The speedometer displays the speed of the motorcycle. It displays in either miles per hour (mph) or kilometers per hour (km/h). See [“Units \(Display Options\)”, on page 3.43.](#)

H. Heated Grips

The heated grips indicator will illuminate when the heated grips are enabled. See [“Heated Grips \(if equipped\)”, on page 3.17.](#)

I. Bluetooth® Indicator

This indicator turns blue when an active Bluetooth® equipped smartphone is paired with the motorcycle. For Pairing instructions, see [“Bluetooth® Pairing”, on page 4.3.](#)

J. Clock

The clock displays time in standard (AM/PM) or 24 hour format. See [“Time & Date”, on page 3.39.](#)

K. Light Sensor

Senses the ambient light to adjust dash display brightness while in *Auto* mode.

L. Trip Odometers A or B

Displays the selected trip odometer. See [“Trip”, on page 3.32.](#)

M. Error Code Icon

The error code icon will illuminate when active error codes are stored in the dash. To clear the error codes, see [“Dash Error Codes”, on page 7.3.](#) The error code icon will extinguish when all errors have been cleared.

Note: The error code icon will continue to be illuminated until all errors have been cleared. To clear an error code, see [“To Clear an Error Code”, on page 3.58.](#)

N. Torque Meter

The **TORQUE** meter indicates the amount of torque applied to the rear wheel while accelerating (output) or decelerating (regen).

O. Traction Mode

This location shows the current mode of the Traction Control. See [“Motorcycle Traction Control \(MTC\)”](#), on [page 4.18](#).

P. Power Meter

The **POWER** meter indicates the amount of power being consumed while riding and the rate at which energy is feeding back into the power pack during the regenerative braking process.





Q. Odometer





The odometer displays the total distance the motorcycle has been ridden in miles or kilometers. See [“Odometer”](#), on [page 3.55](#).

Warning Indicator Lights



ZOM1053

A		Armed/Live Indicator	Indicates the motorcycle is live or ready to drive forward if the throttle is actuated.
B		High Beam Indicator	When the headlight high beam is on, this indicator illuminates blue and remains on until the high beam is turned off.
C		Left Turn Signal Indicator	Flashes green when the turn signal switch is pushed to the left. This arrow remains flashing until the turn signal is canceled.
D		ABS (Anti-Lock Brake System) Indicator	<ul style="list-style-type: none"> • This indicator illuminates when the key is in the ON position. It also illuminates when the motorcycle is being ridden and an ABS event is taking place. The light will extinguish when the motorcycle exceeds 3 mph (5 km/h). Unless there is a fault, the indicator will stay extinguished until the key switch is cycled off and back to the ON position again. • If the ABS is manually disabled ("Enable or Disable the ABS", on page 4.19) in ABS indicator will stay illuminated. • This indicator blinks when ABS is active. <p>See "ABS (Anti-lock Braking System)", on page 4.18 for more information.</p>
E		Traction Control	<ul style="list-style-type: none"> • This indicator illuminates when the traction control functionality has been disabled and remains illuminated until the traction control has been reinstated. • This indicator blinks when traction control is active. <p>See "Motorcycle Traction Control (MTC)", on page 4.21.</p>

F		Charge/Plug	<ul style="list-style-type: none"> • This indicator flashes when the motorcycle is actively charging. • When fully charged, this indicator illuminates solid for a short period of time before the motorcycle powers down and the whole dash display shuts off.
G		Temperature Warning Indicator	<p>If the light illuminates continuously, it indicates that one or more of the powertrain components have reached their temperature limit and performance will be reduced until the component has cooled sufficiently. See “Temperature Indicator”, on page 4.12.</p>
H		Right Turn Signal Indicator	<p>Flashes green when the turn signal switch is pushed to the right. This arrow remains flashing until the turn signal is canceled.</p>
I		Check Engine Light	<p>Indicates the motorcycle’s diagnostic system has detected an error, causing it to enter into a state of permanent torque reduction. This light will be accompanied by an error code.</p> <p>See “Dash Error Codes”, on page 7.3 for more information.</p> <p>Contact your dealer and arrange to have your motorcycle serviced.</p>
J		Battery (12 volt)	<p>This indicator illuminates when the motorcycle’s diagnostic system has detected an error with the 12 volt system (it could be the 12 volt lithium-ion battery and/or the DC-DC converter).</p>

Dash Quadrant Gauges

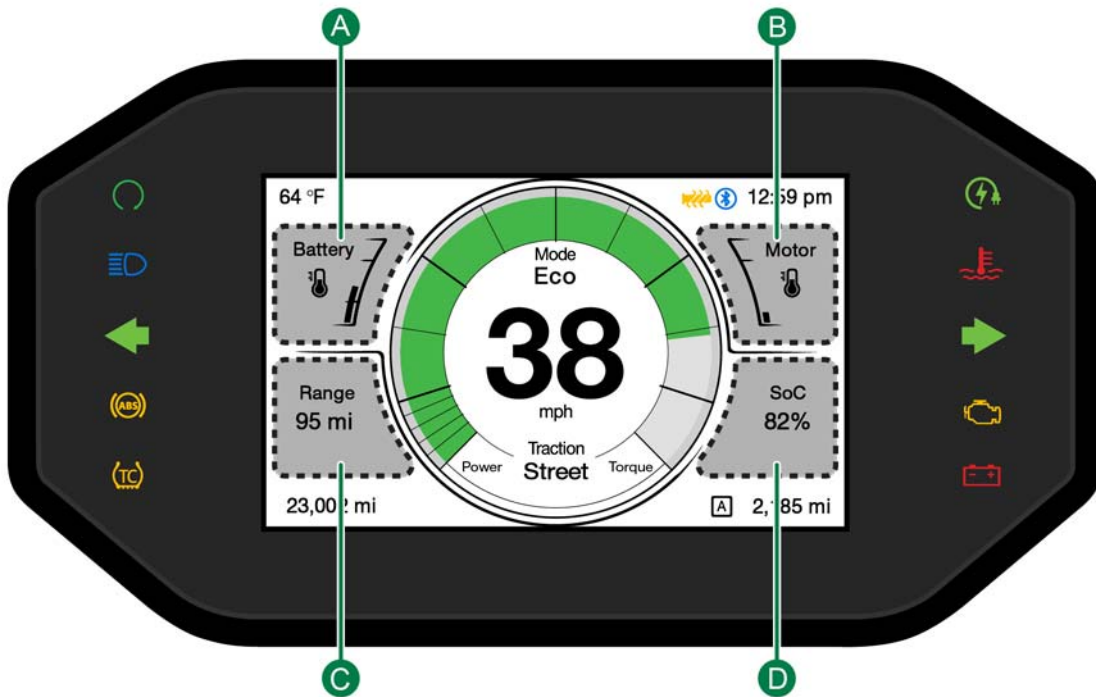

ZOM0868

Controls and Components

Gauge Option	Text Displayed	Units	Quadrant	Notes
Empty	N/A	N/A	A, B, C, or D	Each gauge quadrant can be independently chosen to be empty.
State of Charge Range	SoC	%	A, B, C, or D	Value range 0 to 100%
Estimated Range	Range	mi or km	A, B, C, or D	Measurement system selected for this specific gauge can be independent from measurement system selected for other gauges.
Motor Temperature	Motor	Temperature ranges displayed in colors (blue, white, & red), See page 4.13	A or B	Measurement system selected for this specific gauge can be independent from measurement system selected for other gauges.
Power Pack (high voltage battery pack) Temperature	Battery	Temperature ranges displayed in colors (blue, white, & red), See page 4.13	A or B	Measurement system selected for this specific gauge can be independent from measurement system selected for other gauges.
Instantaneous Efficiency	Instant	Wh/mi or Wh/km	A, B, C, or D	Measurement system selected for this specific gauge can be independent from measurement system selected for other gauges.
Trip Efficiency	Trip	Wh/mi or Wh/km	A, B, C, or D	Measurement system selected for this specific gauge can be independent from measurement system selected for other gauges.
Efficiency Lifetime	Life	Wh/mi or Wh/km	A, B, C, or D	Measurement system selected for this specific gauge can be independent from measurement system selected for other gauges.
RPM	RPM	Revolutions/Minute	A, B, C, or D	RPM of motor

Dash Screens

Note: Before reading through the dash screen portion of this manual, read through “Mode Button Operation”, on page 3.12 and familiarize yourself with the terminology and functionality of the MODE button.

Riding Screen



The Riding Screen is displayed when the key switch is in the ON position and the motorcycle is ready for riding (with the Motor Stop switch in the ON position and the kickstand in the up (retracted) position).

Menu Screen

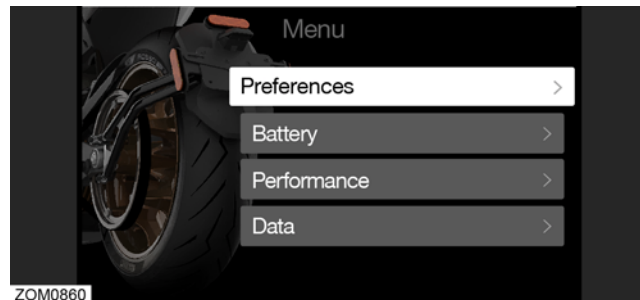

The Menu Screen is displayed when accessed to set preferences to what displays on the Riding Screen, check battery status, check performance status, and check odometer and trip status.

To access the Menu Screen to make changes

- From the Riding Screen, with the Motor Stop switch in the OFF position and/or the Kickstand in the down position, press the MODE button and release after approximately 1 second to enter the main Menu Screen.

To exit the Menu Screen (return to the Riding Screen)

- From any screen while accessing the Menu Screen, hold the MODE button to the left.

Preferences

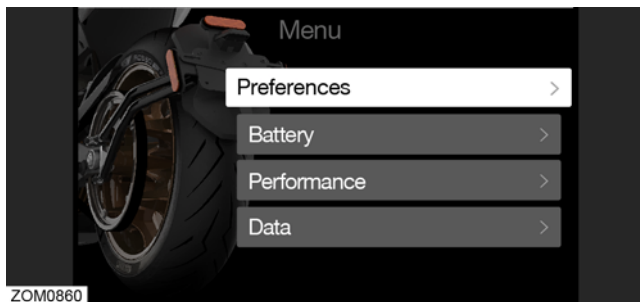

Selecting the Preferences option opens the Ride Interface menu and allows the rider to make changes to what is displayed on the Riding Screen.

To access the Preferences section from the main menu screen

1. From the Riding Screen, with the Motor Stop switch in the OFF position and/or the Kickstand in the down position, press the MODE button and release after approximately 1 second to enter the main Menu Screen. The Preferences option will be highlighted.

Ride Interface



Available menu options are:

- Brightness & Contrast
- Trip
- Gauges
- Time
- Power & Torque
- Connectivity - Bluetooth & Cellular
- Preferences & Settings - Time, Date, and Format.
- Units - Distance, Speed, Time, and Temperature.
- Languages

To access the Ride Interface menu to make changes

1. From the Riding Screen, with the Motor Stop switch in the OFF position and/or the Kickstand in the down position, press the MODE button and release after approximately 1 second to enter the main Menu Screen.
2. From the Menu Screen, press the MODE button once to enter the highlighted Preferences menu.
3. From the Preferences menu, press the MODE button once to enter the Ride Interface menu.

To exit to the Riding Screen, hold the MODE button to the left.

Brightness & Contrast



Available Brightness and Contrast display menu options are:

- Auto

This selection uses the light sensor on the dash to automatically set the brightness of the dash display.

- Brightness (manual settings)

To manually set the brightness of the dash screen, select from the optional levels (1, 2, 3, 4, and 5 - Brightest).

Note: Auto and manual brightness setting cannot be used at the same time.

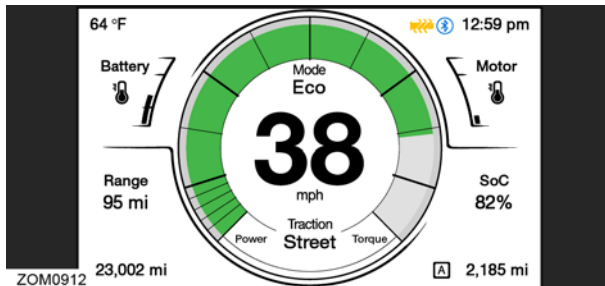

- Visibility Options - High Contrast

For improved visibility, the High Contrast option of the dash display inverts the black and white colors and the colored gauges switch to black.

To access the Brightness & Contrast menu to make changes

1. From the Riding Screen, with the Motor Stop switch in the OFF position and/or the Kickstand in the down position, press the MODE button and release after approximately 1 second to enter the main Menu Screen.
2. From the Menu Screen, press the MODE button once to enter the highlighted Preferences menu.
3. From the Preferences menu, press the MODE button once to enter the highlighted Brightness & Contrast menu.

To select from the Brightness menu options

1. With the Brightness & Contrast selection highlighted, slide the MODE button left or right to scroll through the Brightness & Contrast options.
2. Press the MODE button to select Auto or manual brightness options.

To select from the High Contrast functions

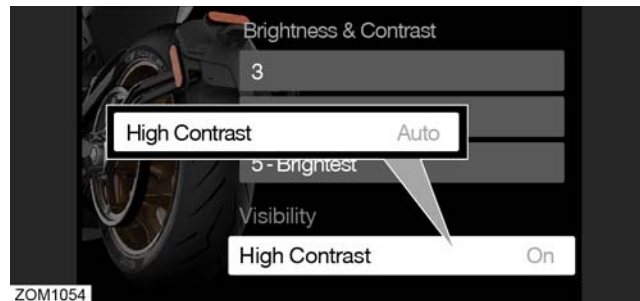

1. From the Brightness & Contrast menu, slide the MODE button left or right to scroll through the Brightness & Contrast options to access the High Contrast option.
2. Press the MODE button to select On, Off, or Auto functions.
 - On/Off
These selections enable (On) and disable (Off) the High Contrast functionality.
 - Auto
This selection uses the light sensor on the dash to automatically set the High Contrast functionality of the dash display.

To exit to the Riding Screen, hold the MODE button to the left.

Trip

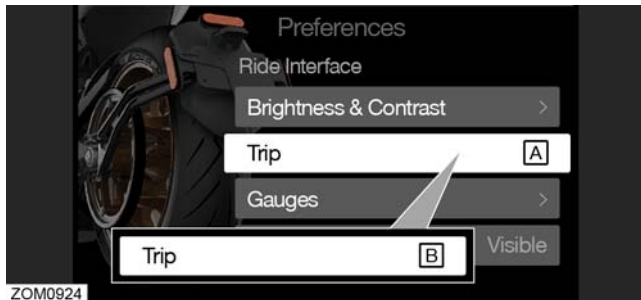

From the trip menu option of the Ride Interface, the rider can choose to display Trip **A** or Trip **B**.

*Note: Trip **A** resets to 0 after each completed charge cycle.*

To access the Trip menu to make changes

1. From the Riding Screen, with the Motor Stop switch in the OFF position and/or the Kickstand in the down position, press the MODE button and release after approximately 1 second to enter the main Menu Screen.
2. From the Menu Screen, press the MODE button once to enter the highlighted Preferences menu.
3. From the Preferences menu, tap the MODE button once to the right to highlight the Trip menu option.

To change which Trip (A or B) is shown on the Riding Screen

1. Press the MODE button once to toggle between Trip **A** and Trip **B**.

Note: To exit to the Riding Screen, hold the MODE button to the left.

Gauges

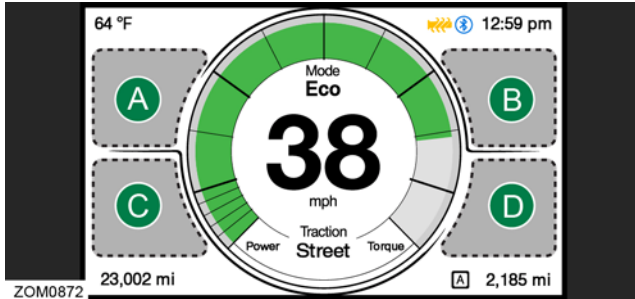

There are four gauge quadrants positioned around the dash's SoC display. The quadrants are labeled as **A**, **B**, **C**, and **D**. Each of the four quadrants can be customized to display one of eight possible gauges, or left **Empty** (blank). See the [“Dash Quadrant Gauges”](#), on page 3.25 the chart for gauge options and quadrant limitations.

To access the Gauges menu to make changes

1. From the Riding Screen, with the Motor Stop switch in the OFF position and/or the Kickstand in the down position, press the MODE button and release after approximately 1 second to enter the main Menu Screen.
2. From the Menu Screen, press the MODE button once to enter the highlighted Preferences menu.

3. From the Preferences menu, tap the MODE button twice to the right to highlight the Gauges menu option.
4. From the Gauges menu option, press the MODE button once to enter the highlighted Gauges menus.

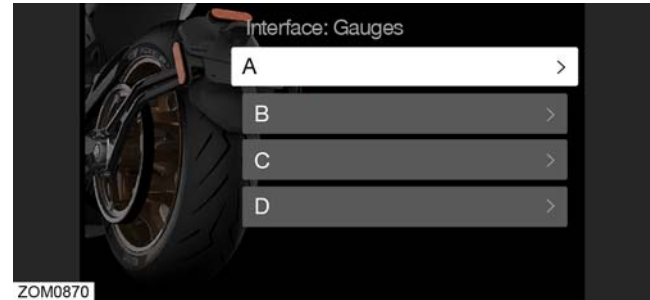

The gauge interface menu will display options **A**, **B**, **C**, and **D**. Tap the MODE button left or right to scroll up and down the gauge quadrant letters. Once the desired gauge quadrant has been highlighted, select it by pressing the MODE button inward to display the available gauge options. For a complete list of available gauges, see [“Dash Quadrant Gauges”](#), on page 3.25

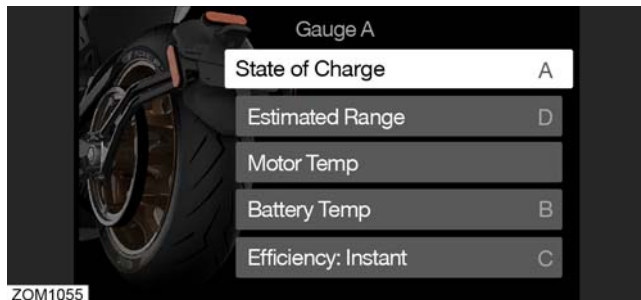

Tap the MODE button to the left or right to scroll up and down the available gauges (sample of available gauges shown above). Gauges currently displayed in the available quadrants (A, B, C, and D) will be annotated on the right side of the selection bar. Once the desired gauge has been highlighted, press the MODE button inward to make your selection. The gauge quadrant letter **A** (when editing **Gauge A**) will display on the right side of the selected gauge bar.

Note: To return to the gauge interface screen, slide the MODE button to the left.

Note: To exit to the Riding Screen, hold the MODE button to the left.

Time (On or Off)

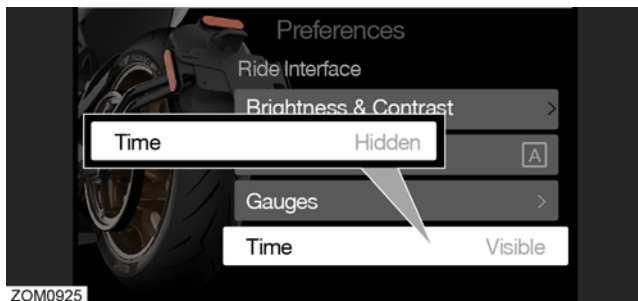

The time display can be Visible or Hidden. Those options are selected from this menu. To change time settings, see [“Time & Date”](#), on page 3.39.

To access the Time menu to make changes

1. From the Riding Screen, with the Motor Stop switch in the OFF position and/or the Kickstand in the down position, press the MODE button and release after approximately 1 second to enter the main Menu Screen.
2. From the Menu Screen, press the MODE button once to enter the highlighted Preferences menu.
3. From the Preferences menu, tap the MODE button three times to the right to highlight the Time menu option.
4. Press the MODE button once to toggle between **Visible** and **Hidden** options.

Note: To exit to the Riding Screen, hold the MODE button to the left.

Power & Torque

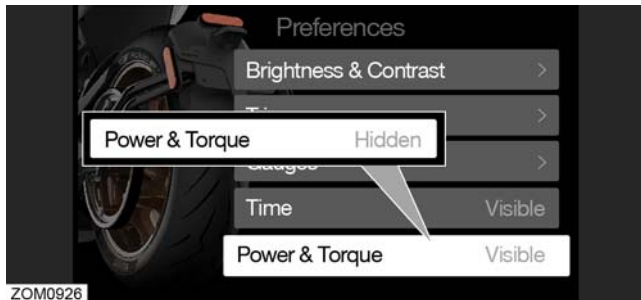

The Power & Torque text on the dash display can be Visible or Hidden.

Note: The power and torque meters stay illuminated whether the text is visible or hidden.

To access the Power & Torque menu to make changes:

1. From the Riding Screen, with the Motor Stop switch in the OFF position and/or the Kickstand in the down position, press the MODE button and release after approximately 1 second to enter the main Menu Screen.
2. From the Menu Screen, press the MODE button once to enter the highlighted Preferences menu.
3. From the Preferences menu, tap the MODE button four times to the right to highlight the Power & Torque menu option.
4. Press the MODE button once to toggle between **Visible** and **Hidden** options.

Note: To exit to the Riding Screen, hold the MODE button to the left.

Connectivity

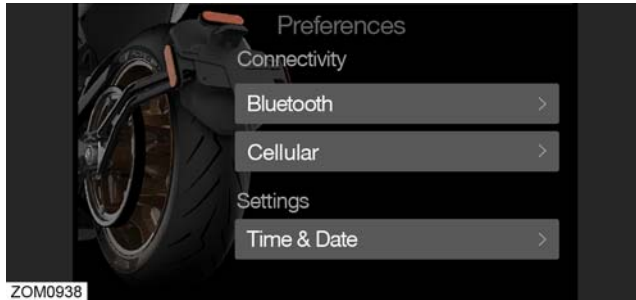

The Connectivity menu is located in the Preferences section of the Menu Screen. The Connectivity menu is the area where Bluetooth® functionality can be enabled or disabled and where the Bluetooth® pairing menu is located. Cellular connectivity can also be confirmed.

Bluetooth

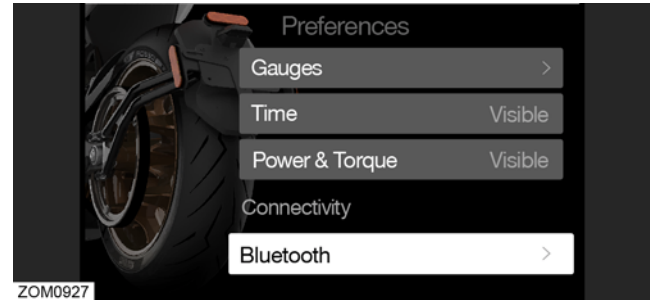

To connect to your smartphone to your motorcycle using Bluetooth®, see [“Bluetooth® Pairing”, on page 4.4.](#)

Cellular

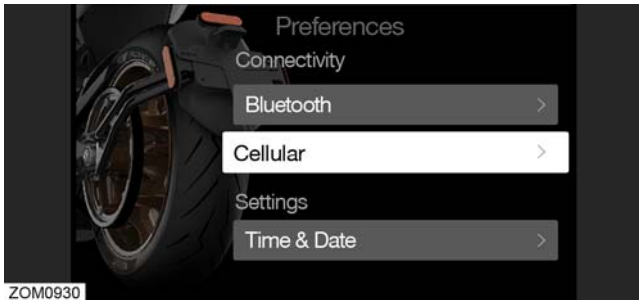

Your motorcycle is connected through cellular networks, transmitting information to the Zero Motorcycles smartphone application at all times. This connectivity gives you the ability to monitor location status and alerts, edit and monitor charging, share ride data with others, and perform system upgrades and updates.

The status of your motorcycle's cellular connection can be checked in the Cellular portion of the Connectivity menu.

To access your motorcycle's connection status

1. From the Riding Screen, with the Motor Stop switch in the OFF position and/or the Kickstand in the down position, press the MODE button and release after approximately 1 second to enter the main Menu Screen.

2. From the Menu Screen, press the MODE button once to enter the highlighted Preferences menu.
3. From the Preferences menu, tap the MODE button six times to the right to highlight the Cellular menu option.



4. From the Cellular menu option, press the MODE button once to enter the highlighted menu selection that displays **Connected** or **Not Connected**.

Note: To exit to the Preferences menu, slide the MODE button to the left and hold for 0.5 seconds.

Note: To exit to the Riding Screen, hold the MODE button to the left.

Settings

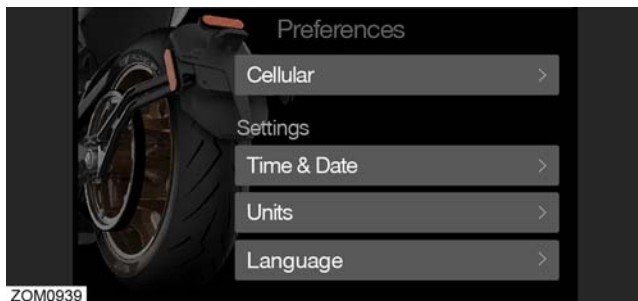

The Settings menu is located in the Preferences section of the Menu Screen. The Settings menu is the area where time and date, units, languages, and time formatting can be set.

Your motorcycle's time can be synchronized with your smartphone by selecting **Yes** or continue in manual mode by selecting **No**. To make these selections, see ["To set the Auto Time Sync"](#), on page 3.42

Time & Date

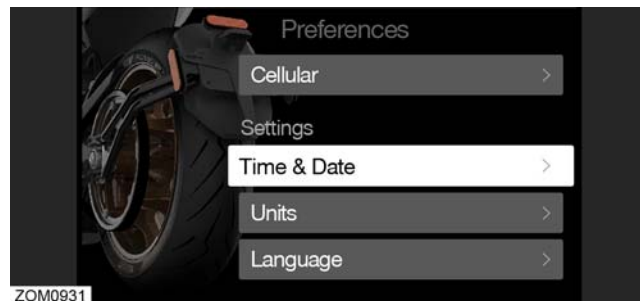

To access and set the Time & Date and change the Format functionality, first start with accessing the Time & Date menu:

*Note: If **Auto Time Sync** is enabled, manual time adjustments are disabled. See ["To set the Auto Time Sync"](#), on page 3.42.*

1. From the Riding Screen, with the Motor Stop switch in the OFF position and/or the Kickstand in the down position, press the MODE button and release after approximately 1 second to enter the main Menu Screen.
2. From the Menu Screen, press the MODE button once to enter the highlighted Preferences menu.
3. From the Preferences menu, tap the MODE button six times to the right to highlight the Time & Date menu option.
4. From the Time & Date menu option, press the MODE button once to enter the highlighted Time & Date menu.

To set the Time

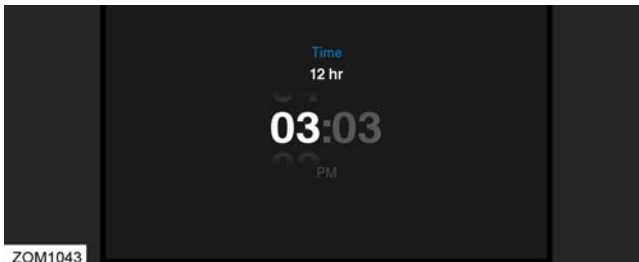

1. The *hour* will be highlighted. Press the MODE button once to select the *hour*.
2. Tap the MODE button to the right or left to change the *hour*.
3. When the desired *hour* has been scrolled to the center, press the MODE button once to make the selection.
4. To set the *minutes*, tap the MODE button once to the right to highlight the *minutes*.
5. Tap the MODE button to the right or left to change the *minutes*.
6. When the desired *minute* has been scrolled to the center, press the MODE button once to make the selection.

Note: To exit to the Time & Date menu for setting the Date, slide the MODE button to the left and hold for 0.5 seconds.

Note: To exit to the Riding Screen, hold the MODE button to the left.

To set the Date

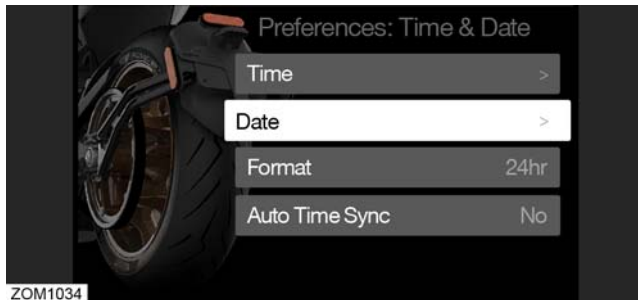

1. From the Time & Date settings menu, slide the MODE button once to the left to highlight the Date menu.
2. With the Date option highlighted, press the MODE button once to enter the Date menu.

To set the time Format (am/pm or 24hr)



ZOM1044

3. The first Date field (MM = *month* [shown above]) will be highlighted. Tap the MODE button to the right until the desired field (DD = *day* or YY = *year*) is selected.
4. Once the desired field is highlighted, press the MODE button once to select the highlighted field.
5. When the desired field has been selected (numbers will appear above and below the highlighted number), tap the MODE button to the left or right to scroll to the desired *date*.
6. When the desired *date* has been scrolled to the center, press the MODE button once to make the selection.
7. Repeat this process until all desired fields are selected.

Note: To exit to the Time & Date menu for setting the Date, slide the MODE button to the left and hold for 0.5 seconds.

Note: To exit to the Riding Screen, hold the MODE button to the left.

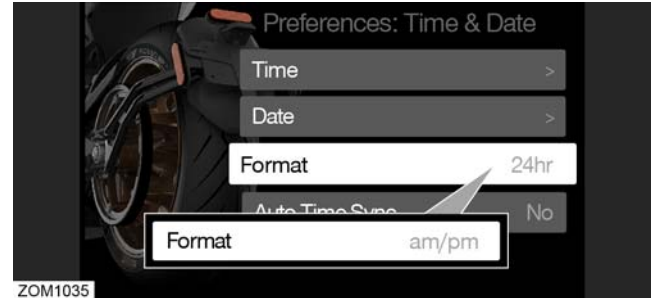

ZOM1035

1. From the Time & Date settings menu, tap the MODE button twice to the left to highlight the Format menu option.
2. With the Format option highlighted, press the MODE button to toggle between **am/pm** and **24hr** options.

Note: To exit to the Riding Screen, hold the MODE button to the left.

To set the Auto Time Sync

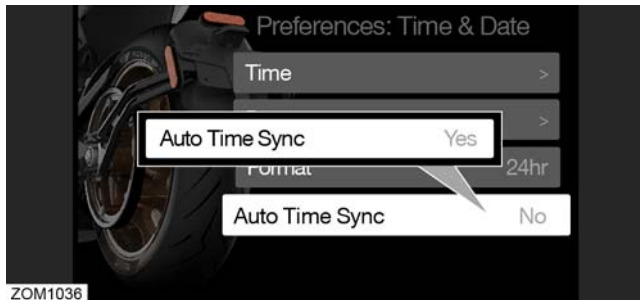

1. From the Time & Date settings menu, tap the MODE button three times to the left to highlight the Auto Time Sync menu option.
2. With the Auto Time Sync option highlighted, press the MODE button to toggle between **Yes** and **No** options.

Note: To exit to the Riding Screen, hold the MODE button to the left.

Units (Display Options)

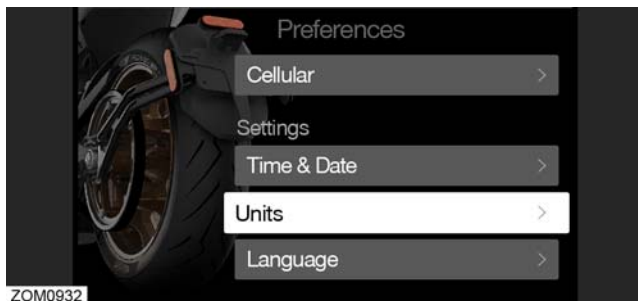

Units can be selected independently.

The Units that can be displayed on dash are:

- Distance: mi or km
- Speed: mph or km/h
- Time: am/pm or 24hr
- Temperature: °F or °C

Note: Units selected to be displayed on the dash are specific to each display item and can be independent from measurement system selected for other display items.

Units (Displayed)



To access and set the Distance, Speed, Time, and Temperature units, first start with accessing the Units menu:

1. From the Riding Screen, with the Motor Stop switch in the OFF position and/or the Kickstand in the down position, press the MODE button and release after approximately 1 second to enter the main Menu Screen.
2. From the Menu Screen, press the MODE button once to enter the highlighted Preferences menu.
3. From the Preferences menu, tap the MODE button seven times to the right to highlight the Units menu option.
4. From the Units menu option, press the MODE button once to enter the highlighted Units menu.

To set the Distance units to be displayed on the dash

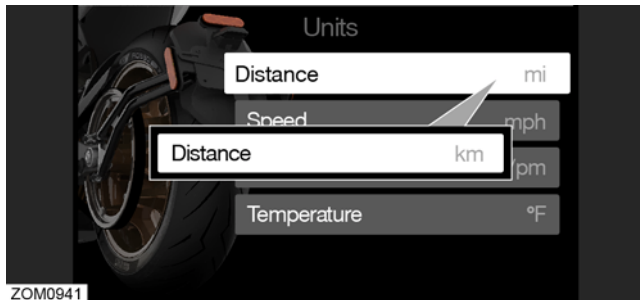

1. From the top of the Units settings menu, the Distance will be highlighted. Press the MODE button to toggle between units **mi** and **km**.

To set the Speed units to be displayed

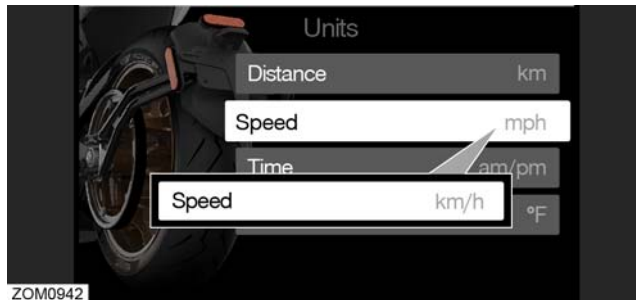

1. From the Units settings menu, tap the MODE button left or right to highlight the Speed menu option.
2. With the Speed option highlighted, press the MODE button to toggle between **mph** and **km/h** options.

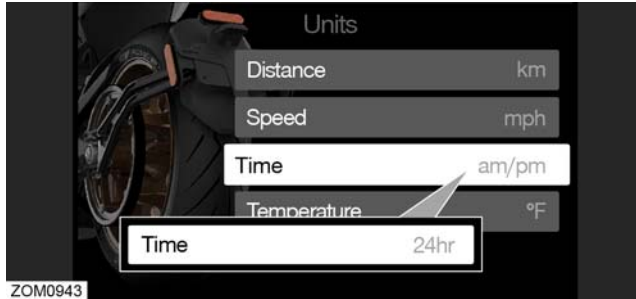
To set the Time format (am/pm or 24hr) to be displayed

1. From the Units settings menu, tap the MODE button left or right to highlight the Time menu option.
2. With the Time option highlighted, press the MODE button to toggle between **am/pm** and **24hr** options.

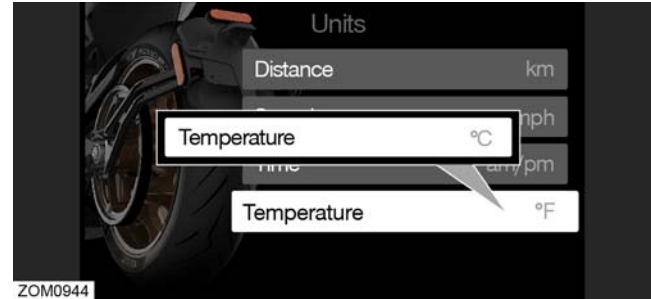
To set the Temperature format (°F or °C) to be displayed

1. From the Units settings menu, tap the MODE button left or right to highlight the Temperature menu option.
2. With the Temperature option highlighted, press the MODE button to toggle between °F and °C options.

Note: To exit to the Riding Screen, hold the MODE button to the left.

Language

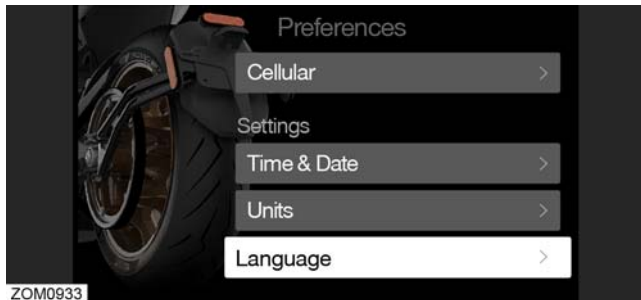

Select a preferred Language to be displayed on the Menu Screens.

Note: Changing to a language (other than English) only changes the text displayed on the menu screens. The text on the Riding Screen does not change when you select a language other than English.

To access and change the Language on the Menu Screens, first start with accessing the Units menu.

1. From the Riding Screen, with the Motor Stop switch in the OFF position and/or the Kickstand in the down position, press the MODE button and release after approximately 1 second to enter the main Menu Screen.
2. From the Menu Screen, press the MODE button once to enter the highlighted Preferences menu.

3. From the Preferences menu, tap the MODE button eight times to the right to highlight the Language menu option.
4. From the Language menu option, press the MODE button once to enter the highlighted Language menu.

To select a Language to be displayed



1. From the Language settings menu, tap the MODE button left or right to highlight your preferred Language menu option.
2. With the preferred language option highlighted, press the MODE button to initiate selection.

Note: To exit to the Riding Screen, hold the MODE button to the left.

Battery

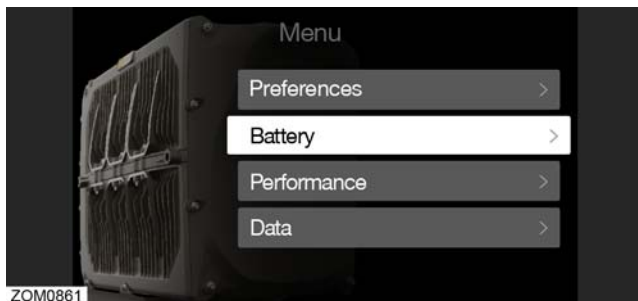

Selecting the Battery option opens the Battery menu and allows the rider to view the status of the battery and make changes to the Charge Target.

To access the Preferences section from the main menu screen

1. From the Riding Screen, with the Motor Stop switch in the OFF position and/or the Kickstand in the down position, press the MODE button and release after approximately 1 second to enter the main Menu Screen. The Preferences option will be highlighted.
2. From the Preferences option, tap the MODE button once to the right to highlight the Language menu option.
3. Press the MODE button once to enter the highlighted Battery menu.

Status

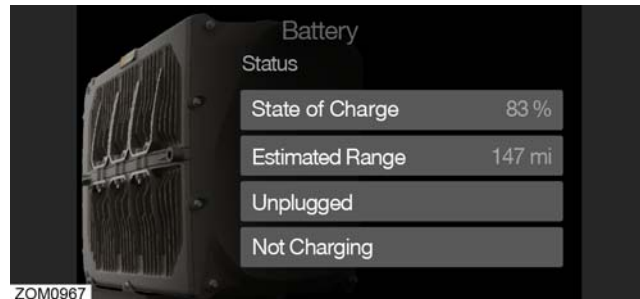

Battery status options are:

- State of Charge (SoC)
- Estimated Range
- Plugged in/Unplugged
- Charging/Not
- Delay/Scheduled
- Charge Target - Enabled/Disabled
- Charge Target - Value

State of Charge

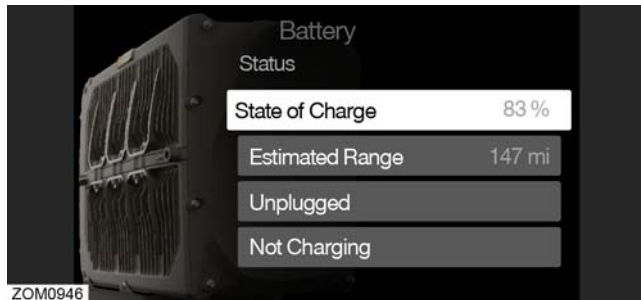

To access the State of Charge:

1. From the Riding Screen, with the Motor Stop switch in the OFF position and/or the Kickstand in the down position, press the MODE button and release after approximately 1 second to enter the main Menu Screen. The Preferences option will be highlighted.
2. From the Preferences option, tap the MODE button once to the right to highlight the Battery menu option.
3. Press the MODE button once to enter the highlighted Battery menu.
4. The State of Charge percentage will be displayed.

Note: To exit to the Riding Screen, hold the MODE button to the left.

Estimated Range

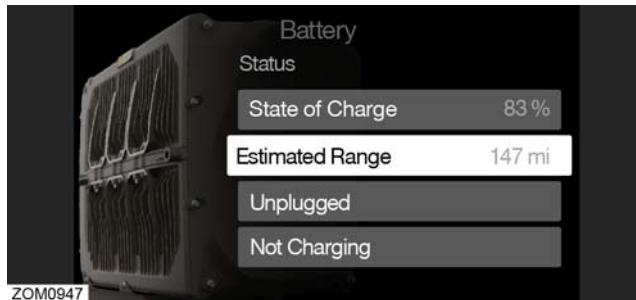

To access the battery's Estimated Range:

1. From the Riding Screen, with the Motor Stop switch in the OFF position and/or the Kickstand in the down position, press the MODE button and release after approximately 1 second to enter the main Menu Screen. The Preferences option will be highlighted.
2. From the Preferences option, tap the MODE button once to the right to highlight the Battery menu option.
3. Press the MODE button once to enter the highlighted Battery menu.
4. The battery's Estimated Range will be displayed.

Note: To exit to the Riding Screen, hold the MODE button to the left.

Plugged In/Unplugged



To access Plugged In or Unplugged status of a charging cable:

1. From the Riding Screen, with the Motor Stop switch in the OFF position and/or the Kickstand in the down position, press the MODE button and release after approximately 1 second to enter the main Menu Screen. The Preferences option will be highlighted.
2. From the Preferences option, tap the MODE button once to the right to highlight the Battery menu option.
3. Press the MODE button once to enter the highlighted Battery menu.
4. The plugged or unplugged status will be displayed.

Note: To exit to the Riding Screen, hold the MODE button to the left.

Charging/Not Charging



To access the battery's Charging status:

1. From the Riding Screen, with the Motor Stop switch in the OFF position and/or the Kickstand in the down position, press the MODE button and release after approximately 1 second to enter the main Menu Screen. The Preferences option will be highlighted.
2. From the Preferences option, tap the MODE button once to the right to highlight the Battery menu option.
3. Press the MODE button once to enter the highlighted Battery menu.
4. The charging status of the power pack will be displayed.

Note: To exit to the Riding Screen, hold the MODE button to the left.

Delay/Scheduled

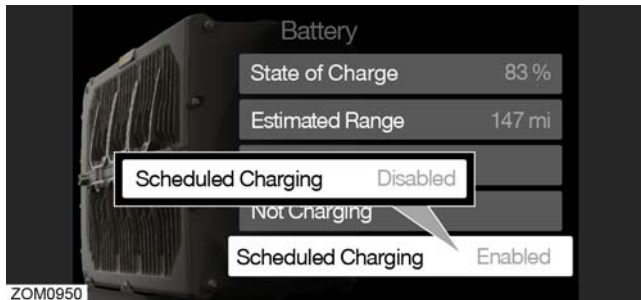

The Delay/Scheduled charging settings are adjusted exclusively using the Zero Motorcycles smartphone application. The setting allows the rider to delay or schedule the charging of the power pack to take advantage of off-peak power rates.

Note: If the Charge Target has been enabled, the Delay/Scheduled functionality takes precedence. If the power pack's Charge Target percentage has not been reached before the scheduled "End Charging" time, the charging will cease at the programmed time.

To access the power pack's charging Delay/Scheduled status

1. From the Riding Screen, with the Motor Stop switch in the OFF position and/or the Kickstand in the down position, press the MODE button and release after approximately 1 second to enter the main Menu Screen. The Preferences option will be highlighted.
2. From the Preferences option, tap the MODE button once to the right to highlight the Language menu option.
3. Press the MODE button once to enter the highlighted Battery menu.
4. From the Battery menu, tap the MODE button four times to the right to highlight the Delay/Schedule menu option.
5. Press the MODE button once to toggle between **Enable** and **Disable** options.

Note: To exit to the Riding Screen, hold the MODE button to the left.

Charge Target

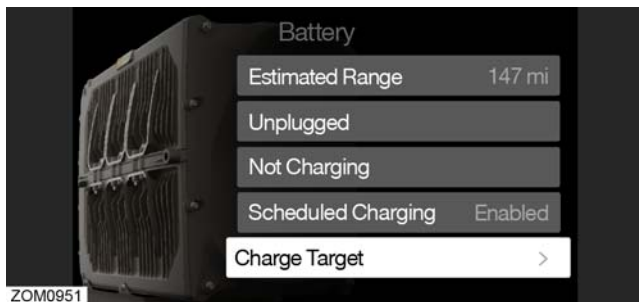

The Charge Target allows the rider to set a maximum State of Charge (SoC) according to the rider's range needs, which can be estimated via the Zero Motorcycles smartphone application. The Charge Target value is a percentage and can be set from 0-100.

*Note: if the Charge Target option is not **Enabled**, the power pack will charge to 100% by default (if allowed to fully charge).*

*Note: Charge Target functionality will be overridden if the rider has **Enabled** the power pack Delay/Scheduled option, which is adjusted exclusively via the Zero Motorcycles smartphone application. If the power pack's Charge Target percentage has not been met before the scheduled "End Charging" time, charging will cease.*

To view the Charge Target:

1. From the Riding Screen, with the Motor Stop switch in the OFF position and/or the Kickstand in the down position, press the MODE button and release after approximately 1 second to enter the main Menu Screen. The Preferences option will be highlighted.
2. From the Preferences option, tap the MODE button once to the right to highlight the Language menu option.
3. Press the MODE button once to enter the highlighted Battery menu.
4. From the Battery menu, tap the MODE button five times to the right to highlight the Charge Target menu option.
5. From the Charge Target menu, press the MODE button once to enter the highlighted Charge Target menu option.
6. Press the MODE button once to toggle between the **Enabled** and **Disabled** options.

Note: To exit to the Riding Screen, hold the MODE button to the left.

To enable the Charge Target



1. From the Charge Target menu, press the MODE button once to toggle between the **Enabled** and **Disabled** options.

Note: To exit to the Riding Screen, hold the MODE button to the left.

To change the Charge Target Value (from 30 to 95%)



1. From the Charge Target menu, tap the MODE button once to the right to highlight the Value option.
2. With the Value option highlighted, press the MODE button once to go to the Charge Target selector.

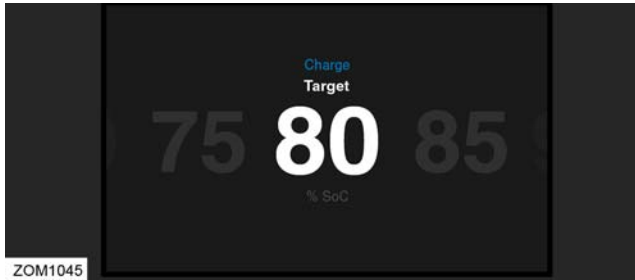

3. To change the Charge Target value, tap the MODE button to the right or left to set the desired Charge Target Value (SoC percentages from 30 to 95, [in 5% increments]).

Note: To exit to the Riding Screen, hold the MODE button to the left.

Performance

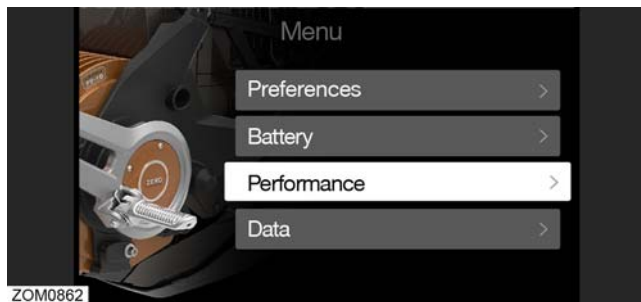

Selecting the Performance option opens the performance Interface menu, where the ABS functionality can be switched **On** or **Off**.

ABS



To access the ABS (On/Off) functionality menu, see [“Enable or Disable the ABS”, on page 4.19](#)

Data

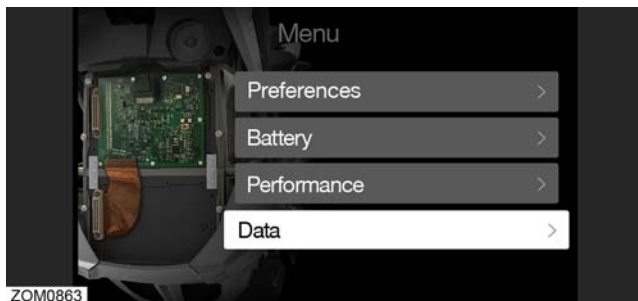

Selecting the Data option opens the odometer and trip data menu list shows the status of:

- Odometer (**ODO**)
- Trip A & B

Odometer

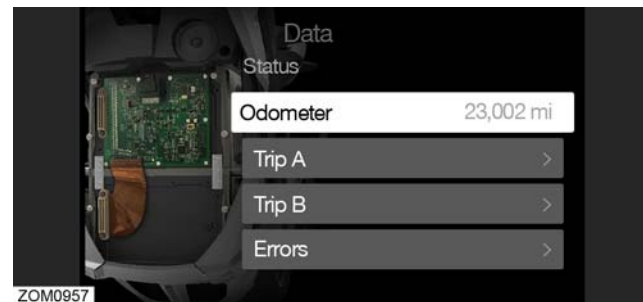

To access the Odometer data:

1. From the Riding Screen, with the Motor Stop switch in the OFF position and/or the Kickstand in the down position, press the MODE button and release after approximately 1 second to enter the main Menu Screen. The Preferences option will be highlighted.
2. From the Preferences option, tap the MODE button three times to the right to highlight the Data menu option.
3. Press the MODE button once to enter the highlighted Data menu.
4. The odometer data will be displayed.

Note: To exit to the Riding Screen, hold the MODE button to the left.

Trip A & B

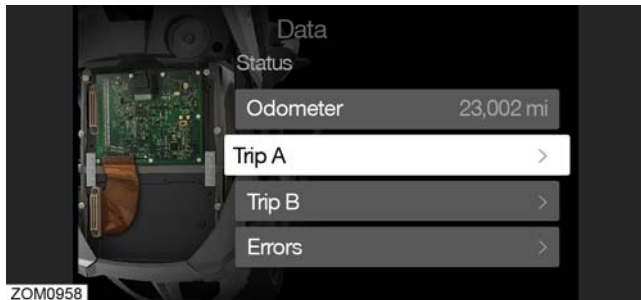

To access and reset the Trip A and B odometers:

1. From the Riding Screen, with the Motor Stop switch in the OFF position and/or the Kickstand in the down position, press the MODE button and release after approximately 1 second to enter the main Menu Screen. The Preferences option will be highlighted.
2. From the Preferences option, tap the MODE button three times to the right to highlight the Data menu option.
3. Press the MODE button once to enter the highlighted Data menu.
4. From the Data menu, tap the MODE button to the right to highlight the preferred Trip (A or B) menu bars.
5. From either Trip (A or B) option, Press the MODE button once to enter the highlighted Trip option.

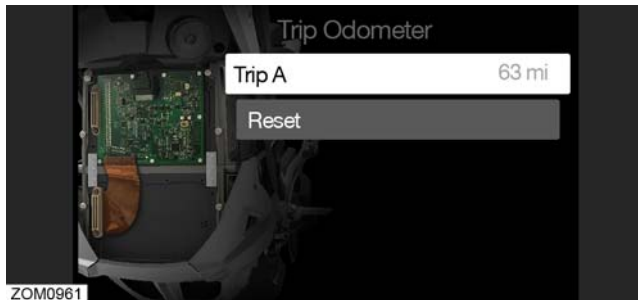

6. The selected Trip odometer will be displayed.
 7. Tap the MODE button to the right to highlight the Reset menu bar.
 8. Press the MODE button to reset the selected Trip odometer.
- Note: To go back to the available trip menu, slide the MODE button to the left and hold for approximately 0.5 seconds and release.*
- Note: To exit to the Riding Screen, hold the MODE button to the left.*

Errors

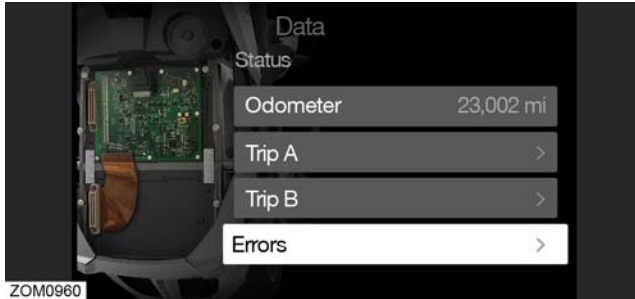

Note: When the Error Code Icon on the dash is illuminated, an error is present. All errors must be cleared for the Error Code Icon on the dash to extinguish. To clear an error code, see “To Clear an Error Code”, on page 3.58.

To access the Errors menu:

1. From the Riding Screen, with the Motor Stop switch in the OFF position and/or the Kickstand in the down position, press the MODE button and release after approximately 1 second to enter the main Menu Screen. The Preferences option will be highlighted.
2. From the Preferences option, tap the MODE button three times to the right to highlight the Data menu option.
3. Press the MODE button once to enter the highlighted Data menu.

4. From the Data menu, tap the MODE button to the right three times to highlight the Errors option.
5. From the Errors option, Press the MODE button once to enter the highlighted Errors option.
6. In the Errors screen, there is space to store up to five error codes. The most recent error will display at the top of the list. From the Errors menu, Tap the MODE button to the left or right to highlight the error you want to view.



7. Press the MODE button to display the highlighted error.

Note: To exit to the Riding Screen, hold the MODE button to the left.

To Clear an Error Code

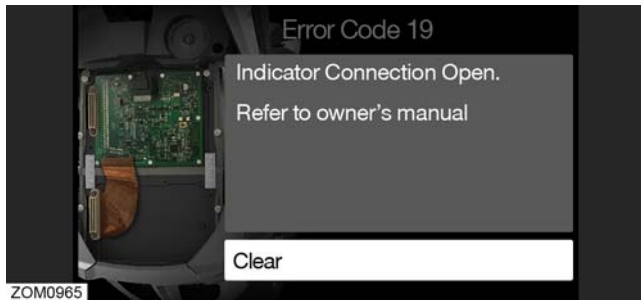

ZOM0965

1. With the error displayed and the **Clear** selection bar highlighted, press the MODE button once to clear the error.

Note: When all error codes have been cleared, the Error Code Icon (see “Dash Overview”, on page 3.19) on the dash will extinguish.

Note: If all error codes have been cleared and the Error Code Icon on the dash continues to be illuminated, an error is recurring. For troubleshooting error codes, see “Dash Error Codes”, on page 7.3.

Note: To exit to the Riding Screen, hold the MODE button to the left.

Firmware Version

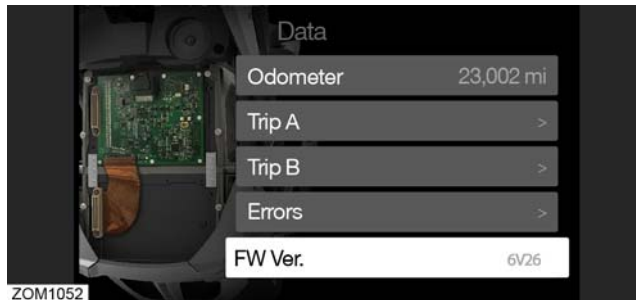

ZOM1052

To access the Firmware Version:

1. From the Riding Screen, with the Motor Stop switch in the OFF position and/or the Kickstand in the down position, press the MODE button and release after approximately 1 second to enter the main Menu Screen. The Preferences option will be highlighted.
2. From the Preferences option, tap the MODE button three times to the right to highlight the Data menu option.
3. Press the MODE button once to enter the highlighted Data menu.
4. From the Data menu, tap the MODE button to the right four times to display and highlight the firmware version.

Note: To exit to the Riding Screen, hold the MODE button to the left.

Locking Your Helmet

Your Zero SR/S motorcycle is equipped with two helmet hooks to secure helmets while parked.

WARNING: Do not ride your motorcycle with a helmet secured to the helmet hook. A helmet hanging from the hook could interfere the rear wheel or suspension, resulting in a loss of control of the motorcycle.

To secure your helmet:

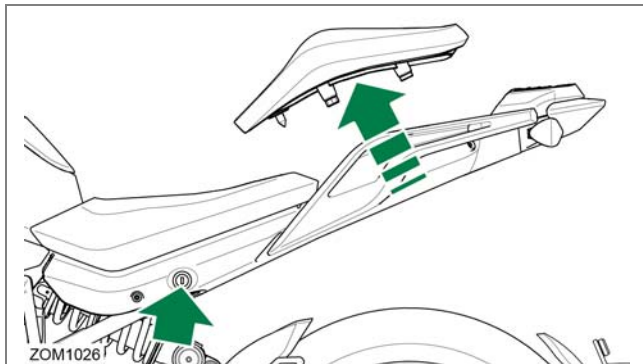

1. Unlock and release passenger seat using the key.

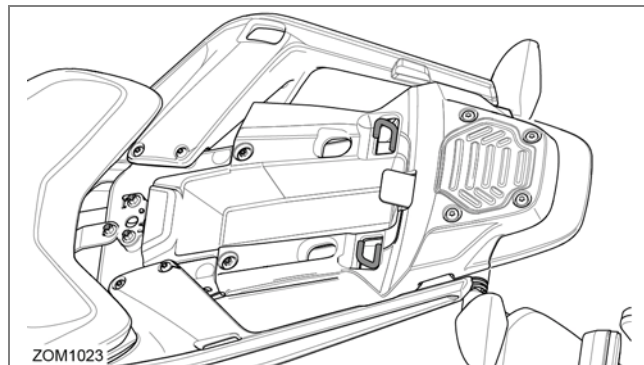

2. Hook helmet buckle on supplied hook (left or right) and drape helmet over the side of the motorcycle.
3. Reinstall passenger seat.

Note: During installation of the passenger seat, confirm the rear of the seat is properly inserted into its receiver prior to latching the pin at the front.

Tank Storage Compartment

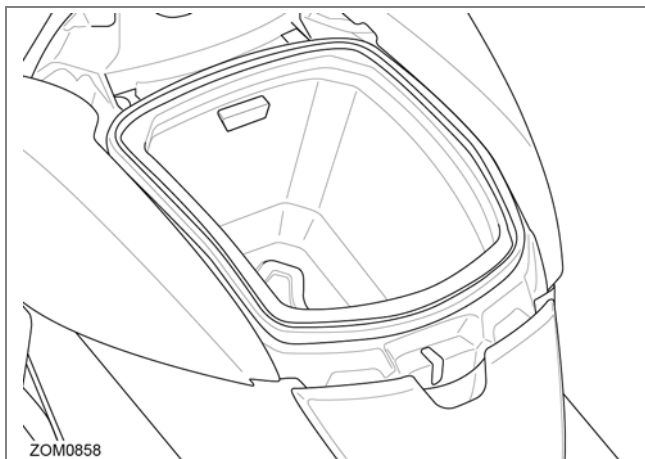

Your Zero Motorcycle is equipped with a lockable tank storage compartment. The storage compartment lid can be locked/unlocked using the key in the lock located on the left side of the storage compartment.

Note: The size of the storage compartment is determined by the equipment installed on your motorcycle.

Pre-ride Inspection

Before operating your Zero Motorcycle, check the following to make sure your motorcycle is ready to ride:

- **Power Pack.** Make sure the charge indicator on the dash is indicating a charged power pack. Check the range indicator on the dash to ensure there is sufficient charge in the power pack for the planned journey.

Note: If the motorcycle has been stored for more than 30 days, turn the key switch to the ON position and back to the OFF position to exit long term storage mode. Then allow it to charge for 24 hours to ensure optimal power pack balance is restored.

- **Drive Belt.** Check belt tension and condition. Adjust if necessary. See [“Drive Belt”, on page 6.24.](#)
- **Brakes.** Squeeze the brake lever and press the brake pedal separately while pushing the motorcycle to see if it rolls. You should be able to lock-up the wheels completely by applying the brakes.
- **Throttle.** With the key switch in the OFF position, apply the throttle and release it to verify that the throttle is smooth and returns correctly.
- **Tires.** Check both tires for condition and tread depth. Check the COLD tire pressures. Check for damage and alignment. Maintain correct tire pressure as specified in [“Wheels And Tires”, on page 6.23.](#)

WARNING! Under-inflation is a common cause of tire failure and may result in severe tire cracking, tread separation, “blowout,” or unexpected loss of motorcycle control causing serious injury or death. Inspect tires regularly to ensure proper inflation levels.

- **Electrical System.** Check for correct function of the headlight, turn signals, and the brake/tail lights.

After riding

Check the remaining charge level of the power pack and charge if necessary.

CAUTION: Never store your motorcycle at a low state of charge (below 30% SoC). Leaving the power pack at a low state of charge for a prolonged period could damage it and void your warranty.

Carrying Passengers and Cargo

WARNING: Overloading or improper loading can cause a crash in which you could be seriously hurt or killed. Observe load limits and loading guidelines in this manual.

Your Zero SR/S has been designed to carry you and only one passenger. When you carry a passenger or cargo, you may feel some difference during acceleration and braking, but as long as you keep your motorcycle well-maintained, with good tires and brakes, you can safely carry loads within the given limits and guidelines.

How much weight you put on your motorcycle, and how you load it, are important for your safety. Any time you ride with a passenger or cargo, you should be aware of the following information.

Loading Guidelines

The carrying capacity (maximum weight capacity) for your motorcycle is specified in “[Specifications](#)”, on [page 8.2](#). This is the maximum safe combined carrying weight of the rider, passenger, all cargo, and any accessories installed.

Your Zero SR/S is primarily intended for transporting you and a passenger. Light weight or small items (for example, a jacket) may be secured to the seat, but If you wish to carry more cargo, we recommend using saddle bags or a top case. Check with your Zero Motorcycles Dealer for the complete range of approved accessories.

Improperly loading your motorcycle can affect its stability and handling. Even if your motorcycle is properly loaded, you should ride at reduced speeds while carrying cargo.

Follow these guidelines whenever you carry cargo:

- Check that both tires are properly inflated.
- If you change your normal load, you may need to adjust the suspension.
- To prevent loose items from creating a hazard, make sure that all cargo is tied down securely.
- Place cargo weight as low and close to the center of your motorcycle as possible.
- Distribute cargo weight evenly on both sides.

Smartphone Application

You can download a smartphone application that lets you perform many tasks related to your motorcycle, including:

- Change dash appearance and settings.
- Adjust the CUSTOM riding mode.
- Collect and email logs to Zero support staff.
- Examine the precise State of Charge (SoC) of your power pack.
- Examine real time power usage.

The Smartphone application is available for free at both the Apple iTunes store and Google Play store.

iTunes® is a registered trademark of Apple. Google Play® store is a registered trademark of Google.

Bluetooth® Pairing

The following steps must be taken to properly pair a Bluetooth®-equipped smartphone with your motorcycle.

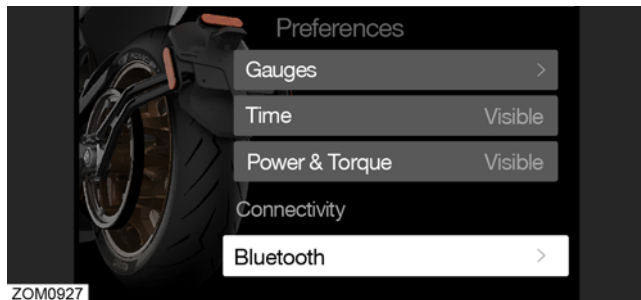

1. On your smartphone, install the Zero Motorcycles application and confirm that your Bluetooth® connectivity is enabled.
2. From the Riding Screen, with the Motor Stop switch in the OFF position and/or the Kickstand in the down position, press the MODE button and release after approximately 1 second to enter the main Menu Screen.
3. From the Menu Screen, press the MODE button once to enter the highlighted Preferences menu.
4. From the Preferences menu, tap the MODE button five times to the right to highlight the Bluetooth® menu option.
5. From the Bluetooth® menu option, press the MODE button once to enter the highlighted Bluetooth® Interface menu.

6. Press the MODE button to toggle between the Bluetooth® Pairing Enabled **Yes** and **No** options.

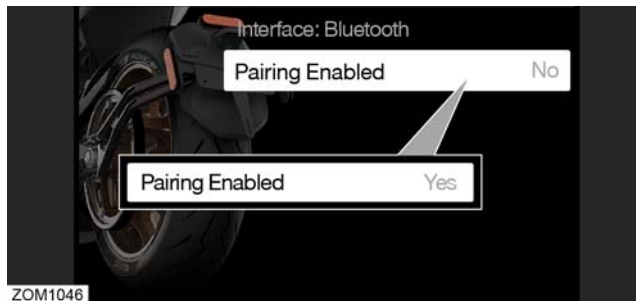

7. The dash will display the motorcycle's ID of Zero_XXXXX (XXXXX refers to the last 5 digits of the motorcycle's VIN).
8. On your smartphone, the application will prompt you with a Bluetooth® pairing request with an ID of Zero_XXXXX (XXXXX refers to the last 5 digits of the motorcycle's VIN).
Note: Only one cell phone can be paired to your motorcycle at a time.
9. Accept the pairing request on your smartphone's screen to start the binding process.
10. The dash will display a 6-digit Verification Code.



Bluetooth® unpairing instructions, see [“Bluetooth® Unpairing”](#), on page 4.6.

Note: When the Bluetooth® indicator on the dash display is solid, your motorcycle and smartphone are paired over Bluetooth®.

11. On your smartphone, enter the 6-digit Verification Code, which will in-turn end the binding procedure and establish a Bluetooth® connection.
12. Accept the pairing request on your smartphone's screen and the application data will populate with the data from your motorcycle within 10 seconds.

Note: To exit to the Riding Screen, hold the MODE button to the left.

Note: Only 1 smartphone can be paired to your motorcycle at a time. To pair a different smartphone's Bluetooth® to your motorcycle, you must unpair the existing paired smartphone's Bluetooth® first. For Bluetooth® unpairing instructions, see [“Bluetooth® Unpairing”](#), on page 4.6.

Note: If you encounter problems pairing your smartphone to your motorcycle, unpair the smartphone's Bluetooth® connection with your motorcycle and try again. For

Bluetooth® Unpairing

The following steps must be taken to properly unpair a Bluetooth®-equipped smartphone from your motorcycle.



From the trip menu option of the Ride Interface, the rider can chose to display Trip **A** or Trip **B**.

1. From the Riding Screen, with the Motor Stop switch in the OFF position and/or the Kickstand in the down position, press the MODE button and release after approximately 1 second to enter the main Menu Screen.
2. From the Menu Screen, press the MODE button once to enter the highlighted Preferences menu.
3. From the Preferences menu, tap the MODE button five times to the right to highlight the Bluetooth® menu option.
4. From the Bluetooth® menu option, press the MODE button once to enter the highlighted Bluetooth® Interface menu.

5. From the Bluetooth® Interface menu, tap the MODE button once to the right to highlight the Phone menu option.
6. From the Phone menu option, press the MODE button once to enter the highlighted Phone menu.
7. With the **Forget this device** option highlighted, press the MODE button to unpair your smartphone from your motorcycle.

Note: If you want to cancel the unpairing process, tap the MODE button to the right once, then press the MODE button to Cancel.

Note: To exit to the Riding Screen, hold the MODE button to the left.

Keys

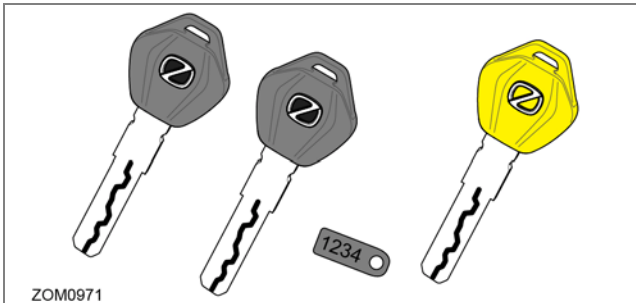

From the factory, your Zero SR/S was supplied with two identical Black keys which have an integrated transponder programmed to communicate with the motorcycle's security system. These Black keys are the **ONLY** ones you should use in the key switch to start the motorcycle and in the locks for the storage compartment and seat.

Your Zero SR/S was also supplied with a Yellow key. The Zero Motorcycles dealer requires this yellow key to program new keys to the motorcycle's security system.

For reference, a four digit key number is provided on a plastic tag with the keys. If a key is lost, contact a Zero Motorcycles dealer who can supply replacement or additional key blanks.

Key blanks can be cut by any automotive locksmith, but will need to be programmed by a Zero Motorcycles dealer.

Note: Keep the spare Black key, Yellow key and key number tag in a safe place - NOT on the motorcycle.

Note: Always take the Yellow key and any Black keys with you when obtaining replacement or additional keys.

Note: Up to five Black keys can be programmed to one motorcycle.

The Yellow Key

The Yellow key is an essential part of the motorcycle's system, without which it will be impossible for your dealer to program replacement or additional keys to the system. **ALWAYS** adhere to the following:

- Store the key in a safe place, NOT on the motorcycle.
- Ensure that you have this key with you when visiting your Zero Motorcycles dealer to obtain replacement or additional keys.
- **DO NOT** attempt to use this key to start your motorcycle - you may inadvertently invalidate the signals from the Black keys preventing the motorcycle from starting.
- When you sell your motorcycle, the Yellow key **MUST** be passed on to the new owner.

Note: Zero Motorcycles is unable to provide a replacement Yellow key. The loss of the Yellow key will require the replacement of the key switch and the motorcycle locks.

Key Switch/Steering Lock

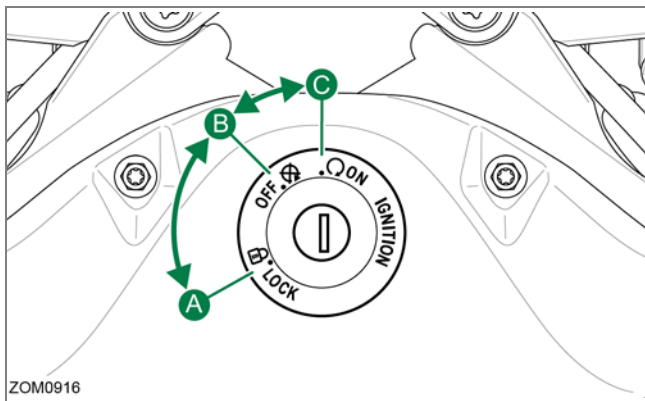

This is a three-position switch that is located on the body, forward of the storage compartment. The switch positions are as follows:

- A. Steering Lock
- B. OFF
- C. ON

The key should be removed from the motorcycle when parked to prevent theft. The key can be removed in either the OFF or steering lock position.

Steering Lock

Using the steering lock when parked prevents unauthorized use and helps prevent theft.

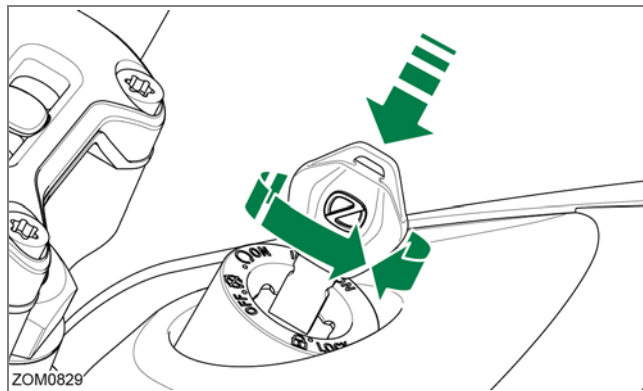

To engage the steering lock:

1. Turn the handlebar all the way to the left.
2. With the key in the OFF position, push the key down and turn the key counter-clockwise.
3. Remove the key.

To unlock the steering lock:

1. Install the key and turn clockwise.
2. Remove the key.

OFF Position

This position is used to turn the motorcycle OFF, disabling the electrical system.

ON Position

This position is used for operating the motorcycle. In this position the following sequence occurs:

- Lights turn ON
- Dash display turns ON
- Contactor closes (audible click).

Motorcycle Tip-Over Sensor

Your motorcycle has a tip-over sensor that will disable the motorcycle's drive mode in the event it is activated. If your motorcycle's tip-over sensor is activated:

- The motorcycle drive mode will be disabled while tipped-over.
- The motorcycle can't be driven or charged while in a tipped-over state.
- Upright the motorcycle and perform one full key cycle (turn the key to the OFF position, wait for the display to go blank and then turn the key back to the ON position) to reset the sensor.

Kickstand

Use the kickstand to support the motorcycle while parked.

1. To lower the kickstand, use your foot to guide it down.

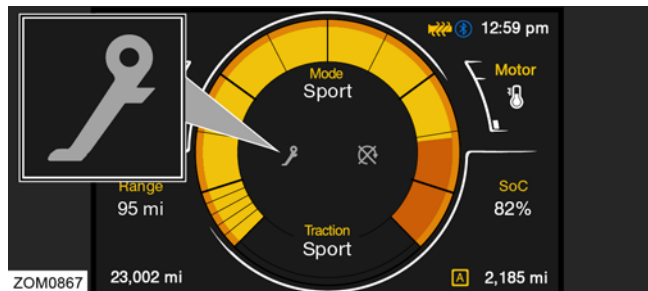

2. Lowering the kickstand will disable the drive system and illuminate the warning indicator on the dash.

Note: The kickstand indicator will illuminate in the center of the dash when the motor stop switch is not activated.

3. Check that the kickstand is down all the way.

Note: If you have to park on a soft surface, place something solid under the kickstand for support.

Operating Your Motorcycle

This section describes how to safely operate your motorcycle.

Starting

1. Turn the key switch to the ON position.
2. Verify that the charge indicator shows enough charge for your ride.
3. Press the motor stop switch to the ON position.
4. With the kickstand up, twist the throttle toward you (counter-clockwise) to increase speed. When the throttle is twisted away from you (clockwise), the speed will decrease.

Braking

The hand operated brake lever is located on the right handlebar. The brake lever controls the front brake when the lever is squeezed. The foot operated brake pedal is located on the lower right side of the motorcycle, next to the foot peg. This pedal controls the rear brake.

When braking, the throttle should be in the closed position.

WARNING: If ABS is disabled or inoperable and you apply the front or rear brake hard enough, it is possible to lock the wheels. This could cause you to lose control of the motorcycle and could lead to serious injury or death. Progressive use of the brakes should bring the motorcycle to a complete stop without locking the wheels. Your Zero Motorcycle is a light-weight performance

vehicle and therefore practice is strongly recommended to perfect safe emergency stops.

Stopping Your Motorcycle

To stop your motorcycle:

1. With the throttle in the closed position press the motor stop switch to the OFF position. This switch can also be used in an emergency to shut the motor off.
2. Turn the key switch to the OFF position and remove the key. To prevent theft, the key should be removed anytime the motorcycle is left unattended.

Temperature Indicator

Zero Motorcycles has developed the most advanced passively air-cooled electric powertrain for your Zero Motorcycle, delivering an unsurpassed level of simplicity, power/energy density, low weight and ease of maintenance. However, this passively air-cooled powertrain cannot be operated indefinitely at high power/high rpm without reaching its thermal limitations. Hence, your Zero Motorcycle has a sophisticated thermal management strategy to ensure the long term performance and durability of its powertrain.



The red temperature indicator light illuminates when the motorcycle's powertrain enters its thermal strategy.

The temperature indicator illuminates solid, letting you know that the thermal strategy is being applied and that your motorcycle's power will be reduced accordingly. If you encounter the strategy while trying to maintain a high speed, the effect of the strategy will be that your motorcycle will be gradually slowed down to the point that the top speed of the bike is "sustainable," from a thermal standpoint. If you encounter the strategy due to a different sustained high power event, such as continued powering through a low traction surface, power will simply be reduced to ensure the continued safe operation of your powertrain.

Note: The temperature indicator does not indicate that there's anything malfunctioning with your Zero Motorcycle; it is simply

letting you know that the thermal strategy is working. If you do not moderate your speed/power, the motorcycle's system will reduce your speed/power until your Zero Motorcycle can maintain its maximum allowable thermal state; but no harm whatsoever will result from this, since this is exactly how the strategy is meant to function.

Temperature Gauges

The battery (power pack) and motor temperature gauges are equipped with indicator bars that change colors depending upon their temperature at the time.

Note: The battery and motor temperature gauges do not have a numerical value display function.



Color	Battery Temperature Range
Blue	14°F (-10°C) to 50°F (10°C)
White	50°F (10°C) to 131°F (55°C)
Red	131°F (55°C) to 167°F (75°C)

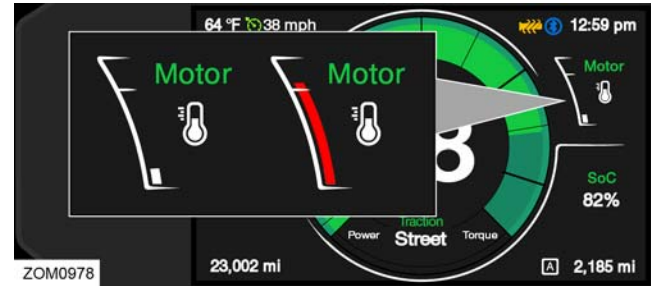

Color	Motor Temperature Range
White	68°F (20°C) to 244°F (118°C)
Red	244°F (118°C) to 302°F (150°C)

Vehicle Range

The range of an electric vehicle is defined as the distance the vehicle travels on a single full charge of the power pack. Just like EPA mileage estimates for an automobile, “your mileage may vary.” Your range results are a direct reflection of your riding habits. The more conservatively you ride, the better range you can expect from your Zero SR/S motorcycle.

Some of the factors which affect range include: speed, acceleration, number of starts and stops, ambient air temperature, and changes in elevation. The combination of these factors, as you travel from one point to another, defines your trip profile. In addition, tire pressure and payload are important considerations.

We suggest that you ride conservatively when you first get your Zero SR/S motorcycle, to get to know your motorcycle and your commute. Once you become familiar with the range versus performance of your motorcycle, then you can adjust your riding characteristics if you desire. This applies mainly to riders with trip profiles which are at the edge of the performance envelope.

The reported motorcycle range values in this Owner’s Manual are measured using different standards, according to the country the Zero motorcycle is being sold.

For Zero motorcycles sold within European countries, range is calculated using European Union regulation EU 134/2014 Annex VII.

For Zero motorcycles sold in all other countries (Rest of the World), range is calculated using the following types of industry standard test procedures:

1. “City”: This range test is specified to determine riding during “stop-and-go” operation typically found in urban areas. Actual range will vary based on riding conditions and habits.
2. “Highway”: This test procedure uses two separate constant speeds of 55 mph (89 km/h) and 70 mph (113 km/h) to simulate highway riding.

Both of these test procedures are run on a single charge, in order to report the associated measured range values.

Range values labeled “Combined” are based on a calculation that assumes a duty cycle comprised of 50% City / 50% Highway.

See [“Specifications”](#), on page 8.2 for these ranges.

Maximizing Your Range

Range varies in electric motorcycles similarly to how it varies in gas motorcycles. However, the big difference between electric and gas is that energy consumption is averaged over a shorter distance on an electric motorcycle. Electric motorcycles are designed for convenient daily recharges versus less frequent and less convenient trips to the gas station. As a result, the same electric motorcycle often yields different ranges from one full recharge to the next.

How to Predict the Range

To generally predict how an electric motorcycle's range will be affected, you can use the four factors:

- route
- rider
- weather
- bike

By considering each of these factors, you can use specifications such as 'city range' as standards to estimate what the motorcycle's real world range will be under your particular usage case.

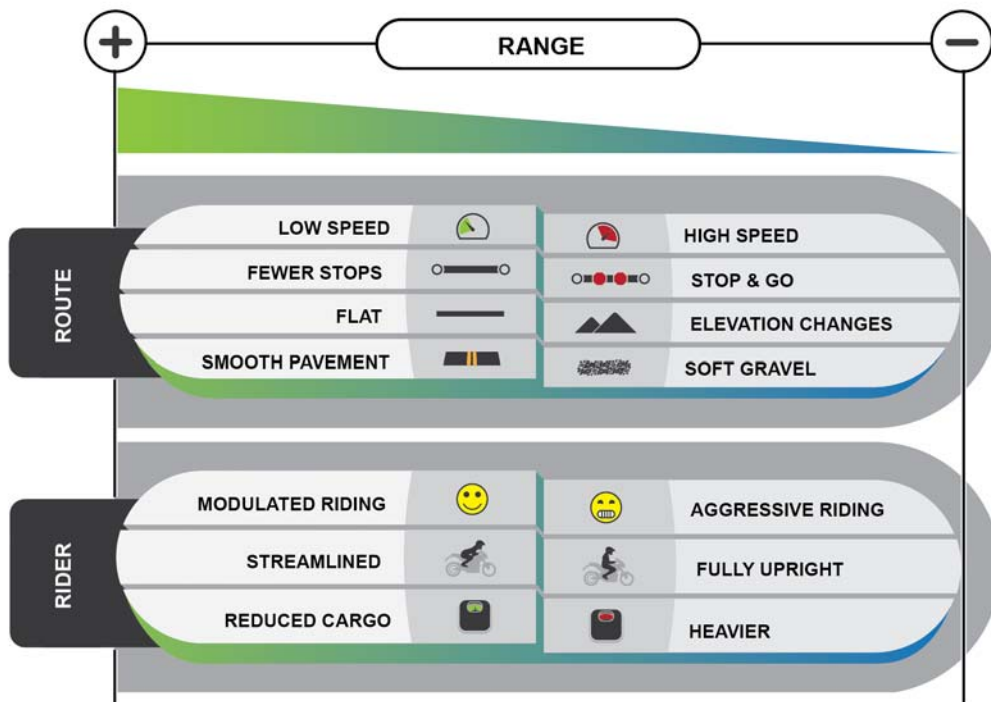

ZOM0455

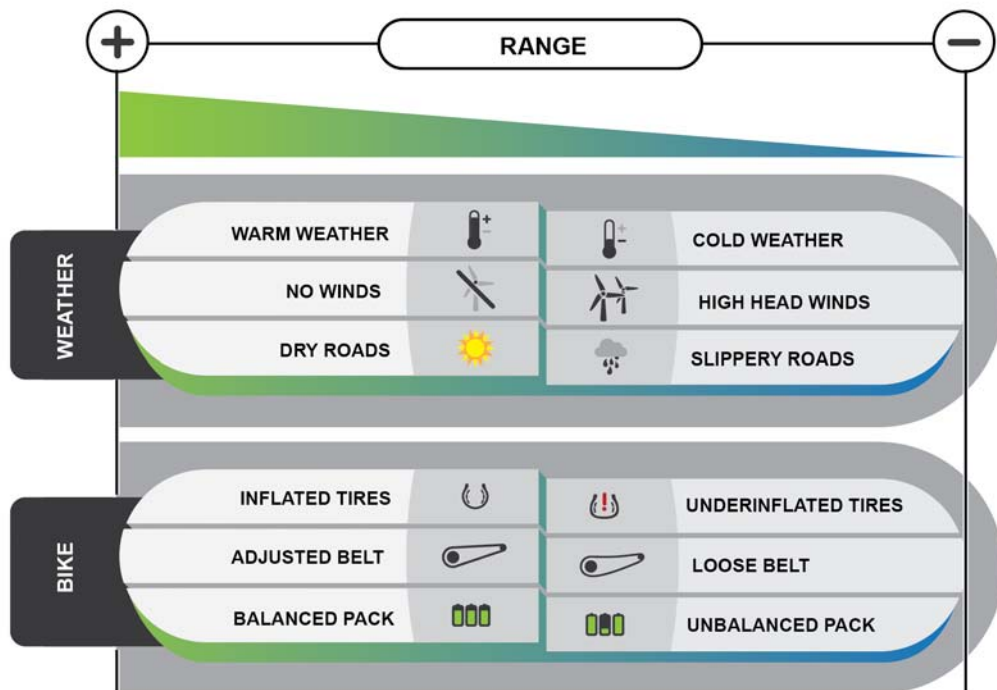

ZOM0467

ABS (Anti-lock Braking System)

WARNING: ABS prevents the wheels from locking, therefore maximizing the effectiveness of the braking system in emergencies and when riding on slippery surfaces. The potentially shorter braking distances ABS allows under certain conditions are not a substitute for good riding practices.

WARNING: Always ride within the legal speed limit.

WARNING: Carefully ride your motorcycle around corners. If applying the motorcycle's brakes while cornering, the ABS cannot counteract the weight transfer and force. Doing so, can create unsafe riding conditions. Some riding conditions and environments may reduce the effectiveness of the ABS and require stopping distances equivalent to those of a motorcycle without ABS.



When the motorcycle is stationary and the key is turned to the ON position, it is normal for the ABS warning indicator on the dash to illuminate. The indicator will remain on until the system detects the motorcycle's speed exceeds 3 mph (5 km/h), after which will stay off until the key is turned to the OFF position and back to the ON position.

Note: The ABS light can illuminate if there is a large difference in wheel speed between the front and rear (wheelies, burnouts, or loose gravel). If this happens, the ABS system will be inactive and can allow the wheels to lock under heavy braking. To reactivate the ABS, bring the motorcycle to a complete stop,

then turn the key to the OFF position, wait for approximately 5 seconds, then turn it back to the ON position. The ABS light should extinguish once both wheels reach 3 mph (5 km/h) and be fully functional.

Enable or Disable the ABS

WARNING: When the ABS is disabled, the motorcycle will operate as a non-ABS equipped motorcycle, potentially with increased stopping distance and unpredictable brake control.

To access the ABS (Enable/disable) functionality menu:

1. From the Riding Screen, with the Motor Stop switch to the OFF position and/or the Kickstand in the down position, press the MODE button and release after approximately 1 second to enter the main Menu Screen. The Preferences option will be highlighted.
2. From the Preferences option, tap the MODE button twice to the right to highlight the Performance menu option.
3. Press the MODE button once to enter the highlighted Performance menu.
4. From the Performance menu, tap the MODE button three times to the right to highlight the Advanced Settings - ABS menu.

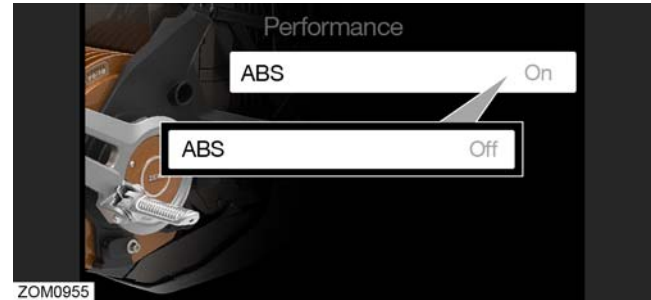

5. Press the MODE button once to toggle between **On** and **Off** options.

Note: To exit to the Riding Screen, hold the MODE button to the left.

Note: When the ABS is manually disabled, the ABS indicator (“Warning Indicator Lights”, on page 3.22) located on the dash will illuminate.

*Note: When the ABS is manually disabled, it will only remain disabled while the key switch is in the **ON** position. Once the key switch is turned to the **OFF** position and back to the **ON** position, the ABS functionality will automatically return to its Enabled state.*

Note: When the ABS is disabled, the DTC (Drag Torque Control) will also be disabled, but the MTC (Motorcycle Traction Control) will not be affected.

ABS Warning Indicator

When the motorcycle is stationary and the key is turned to the ON position, it is normal for the ABS warning indicator on the dash to illuminate. The indicator will remain on until the system detects the motorcycle's speed exceeds 3 mph (5 km/h), after which it will stay off until the key is cycled off and back to the ON position.

Note: Both the front and rear wheel speed sensors must detect speeds exceeding 3 mph (5 km/h) simultaneously in order for the ABS system and its indicator to operate properly.

If the ABS warning indicator is illuminated outside of its normal operating parameters:

- The ABS has been disabled by the rider.
- The ABS has a malfunction and requires attention and/or service.

WARNING: If the ABS indicator light remains illuminated after your motorcycle exceeds 3 mph (5 km/h), ABS is not active and there is a fault with the ABS system. If an ABS system fault exists, take your motorcycle to an authorized dealer at your earliest convenience to have the ABS system repaired. If there are no dealers in your area, call Zero Motorcycles Customer Service. See ["Customer Assistance"](#), on page 9.9.

WARNING: The ABS computer compares the relative speed of the front and rear wheels. Using tires other than those specified

by Zero Motorcycles can adversely affect the ABS functionality and stopping distance of your motorcycle.

WARNING: If the ABS warning indicator is illuminated when traveling at speeds exceeding 3 mph (5 km/h), the ABS is not functioning. When the ABS system is not functioning, your motorcycle will operate as a non-ABS equipped motorcycle with increased stopping distance and unpredictable brake control.

WARNING: If the front and rear wheel speeds vary in speed significantly, such as during a burnout, wheelie, or off road riding, the ABS indicator will illuminate and disable the ABS.

Note: To reactivate the ABS, bring the motorcycle to a complete stop, then turn the key to the OFF position, wait for approximately 5 seconds, then turn it back to the ON position. The ABS light should extinguish once both wheels reach 3 mph (5 km/h) and be fully functional.

Motorcycle Traction Control (MTC)

WARNING: Traction control reduces the rear wheel from spinning in some riding conditions, therefore maximizing the performance and safety when riding on some traction-challenged surfaces. The potentially reduced power due to the intervening of the traction control system under traction-challenged conditions and surfaces is not a substitute for good riding practices.

WARNING: Always ride within the legal speed limit.

The motorcycle traction control (MTC) reduces motor torque in the event of rear wheel traction loss. The selected traction control will dictate the amount of rear wheel slip desired by the rider.



The MTC warning indicator on the dash will illuminate when the MTC system **Off** mode has been selected or a traction control triggering event has been experienced. If the MTC **Off** mode has been selected, the indicator will remain illuminated until the **Street, Sport, or Rain** traction mode has been selected, or until the key is turned to the OFF position and back to the ON position.

*Note: If you create a Custom riding mode with the MTC **Off** mode is chosen, the Traction Control mode will remain **Off** when the key switch is turned to the OFF position and back to the ON position.*

Note: The MTC warning indicator can illuminate if a traction control triggering event (the rear tire has slipped or the system has detected an error) has been experienced. To reactivate the MTC, see “Enabling the Traction Control”, on page 4.23

WARNING: If the MTC warning indicator does not extinguish when the **Street, Sport, or Rain** traction control mode has been selected and the motorcycle is stationary, contact your dealer and arrange to have the motorcycle serviced.

Traction Control Modes



Your motorcycle has four traction modes **STREET**, **SPORT**, **RAIN**, and **OFF**. The current traction mode is displayed on the riding screen below the speedometer.

You can switch between modes while riding. If the throttle is on, the change will not be executed until the throttle is returned to the closed position. If the throttle is closed when switching modes, the change will take effect immediately.

Traction Control modes:

- The **STREET** selection is for performance riding with balanced power and traction control, while allowing the minimal allowable amount of rear wheel slip.
- The **SPORT** selection is for performance riding with direct response to power output, while allowing maximum allowable rear wheel slip.

- The **RAIN** selection is for reduced performance riding, while promoting maximum traction (least amount of rear wheel slip) on traction-challenged surfaces.
- The **OFF** mode selection disables the traction control functionality. This mode allows the motorcycle to operate as a non-MTC equipped motorcycle, with no control of the amount of rear wheel slip.

WARNING: The traction control warning indicator light will illuminate when the traction control OFF mode is selected.

Disabling the Traction Control

WARNING: When the Traction Control is disabled, the motorcycle will operate as a non-Traction Control equipped motorcycle, with no control of the amount of rear wheel slip.

To disable the Traction Control:

1. Ensure that the motorcycle is Armed (the key switch is keyed ON, the kickstand is in the up (retracted) position, and the Motor Stop Switch is in the ON position).
2. Slide the MODE button to the right and hold for approximately 0.5 seconds to enter the Traction Control change mode.
3. Tap the MODE button left or right to scroll to the Traction Control **Off** mode option.
4. Press the MODE button to select the Traction Control Off mode option. This will exit the Traction Control mode and put the traction control in the Off mode at the same time.

Note: You can switch between traction control modes while riding. If the throttle is engaged, the change will not be executed until the throttle is returned to the closed position. If the throttle is closed when switching modes, the change will take effect immediately.

Enabling the Traction Control

To enable the Traction Control:

1. Ensure that the motorcycle is Armed (the key switch is keyed ON, the kickstand is in the up (retracted) position, and the Motor Stop Switch is in the Run position).
2. Slide the MODE button to the right and hold for approximately 0.5 seconds to enter the Traction Control change mode.
3. Tap the MODE button left or right to scroll to the Traction Control to an active mode (**Street, Sport, or Rain**).
4. Press the MODE button to select an active Traction Control mode option. This will exit the Traction Control mode and put the traction control in the selected active mode at the same time.

Note: You can switch between traction control modes while riding. If the throttle is engaged, the change will not be executed until the throttle is returned to the closed position. If the throttle is closed when switching modes, the change will take effect immediately.

Drag Torque Control (DTC)

WARNING: Drag Torque Control reduces the amount of rear wheel slippage in some riding conditions, therefore maximizing safety when riding on some traction-challenged surfaces. The potentially reduced power regeneration due to the intervening of the traction control system under traction-challenged conditions and surfaces is not a substitute for good riding practices.

WARNING: When the ABS is disabled, DTC will also be disabled. The motorcycle will operate as a non-ABS and non-DTC equipped motorcycle, potentially with increased stopping distance, tire slippage during deceleration, and unpredictable brake control. To enable the ABS, see [“Enable or Disable the ABS”](#), on page 4.19.

WARNING: DTC cannot protect the rider from all possible road and riding hazards and is not a substitute for good riding practices. Be aware of the DTC functionality and its limitations. It is the rider’s responsibility to obey traffic laws and ride at appropriate speeds for weather, road surface, and traffic conditions.

WARNING: Always ride within the legal speed limit.

When decelerating, the drag torque control (DTC) manages the drag on the rear wheel by increasing or decreasing the levels of power regenerated. If the wheel speed sensors report rear wheel slippage upon deceleration, the DTC functionality will

automatically reduce the amount of drag torque to assist in maintaining rear wheel traction.



The DTC is disabled when the ABS indicator is illuminated. When the motorcycle is stationary and the key is turned to the ON position, it is normal for the ABS warning indicator on the dash to illuminate. The indicator will remain on until the system detects the motorcycle’s speed exceeds 3 mph (5 km/h), after which will stay off until the key is turned to the OFF position and back to the ON position.

*Note: If you create a Custom riding mode with the ABS **Off** mode chosen, the drag torque control will remain disabled when the key switch is turned to the OFF position and back to the ON position.*

Power Pack

The high voltage battery cells are located within the power pack and requires no special break in period.

The Zero Z-Force® Power Pack™ leverages proven battery cell chemistry, configuration, and enhanced reliability. Not only does the Z-Force® technology enable you to go longer distances (range varies depending on riding type and conditions), it is also designed to last the life of the motorcycle.

The charging time is dependent on infrastructure capabilities and on the power capability of the EVSE (Electric Vehicle Supply Equipment) supplying power to the on-board charger.

The normal recharging time of the power pack to a 100% state of charge is usually less than 5 hours for the ZF14.4 in mild ambient temperatures. Outside of the normal temperature range, charging and run-time times will vary. The power pack should not be used outside of the range of -4°F to 140°F (-20°C to 60°C); the Battery Management System (BMS) turns off the power controller outside of this range.

Note: The power pack will not charge at temperatures below 32°F (0°C) or above 122°F (50°C).

Zero Motorcycles power packs have been designed to operate under normal temperatures and environmental conditions. However, the lithium-ion batteries used in the power packs, age is based on usage cycles as well as calendar time. Aging can be accelerated by prolonged storage of the power pack at a high

state of charge, especially at high temperatures. In order to maximize the life of your power pack and support the worry free operation of your motorcycle, Zero Motorcycles has established a set of guidelines for proper charging and operation.

CAUTION: Failure to follow the charging guidelines could damage the power pack and void your power pack warranty.

Once recharged, disconnect from the AC power source. Leaving your motorcycle unplugged between charges will maximize the long term health of the power pack.

While unplugged with the key in the OFF position, the motorcycle's electronics will consume a very small amount of power and a fully charged power pack will drain at an extremely slow rate.

For guidelines on how to care for the power pack when the motorcycle is not being used for an extended period of time (30 days or more) or if the motorcycle is being stored long term, see Parking and Long Term Storage.

Battery Management System (BMS)

Every power pack contains a Battery Management System (BMS) which monitors the condition of the cells, and optimizes the charging process to provide the highest performance, longest range, and longest life for the power pack.

The BMS safeguards the power pack by means of safety interlocks. These interlocks turn off or control certain operations that could damage the power pack.

The BMS also monitors the power pack for a host of predefined conditions, and then takes actions according to those conditions.

The BMS is sealed inside the power pack. As a rider, you don't need to think much about the BMS - it just silently performs its job as you charge, ride, and store your motorcycle.

How to Identify your Charger

The factory installed charger(s) on the Zero SR/S are located above the power pack and are visible from the sides of the motorcycle.

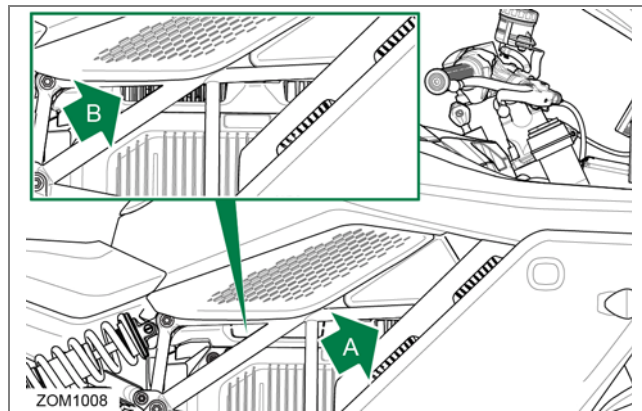

Standard and Premium models of the Zero SR/S have a 3 kWh charger located above the front of the power pack (A).

Premium models have a second 3 kWh charger (B) located behind the first charger which increases its charging capacity to 6 kWh.

Charging the Power Pack

WARNING: Always charge the Zero power pack in a location that is well-ventilated and away from combustible materials. If charging your Zero Motorcycle outdoors, avoid charging in the rain.

WARNING: Only charge the Zero power pack with the Zero charger or approved Zero accessory chargers. Using unapproved chargers or accessories may lead to cell damage or power pack failure.

The maximum power pack internal charging temperature is 122°F (50°C). If the power pack's internal temperature is over that, it will not accept a charge until it has cooled below 122°F (50°C). If the power pack has recently been rapidly discharged from aggressive riding, it may internally be above 122°F (50°C), even if the ambient temperature is lower.

If you experience a power pack that will not take a charge, you should ensure the internal temperature is below 122°F (50°C). If the power pack has recently been operating near maximum output and/or in hot conditions it may not take a charge, the power pack should cool off and begin taking a charge in around 30 minutes or less.

The maximum charging temperature cutoff is a power pack longevity feature. Charging at higher temperatures can shorten the life of the power pack.

To charge using the standard on-board charging equipment

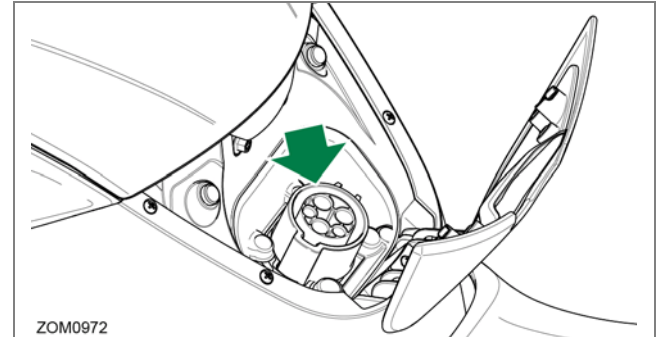

1. Plug the charging connector into the on-board charger socket.

Note: North America region motorcycles use an IEC 62196 Type1 (AKA J1772) charging connector and EU region motorcycles use an IEC 62196 Type 2 (AKA Mennekes) charging connector.

Note: Avoid connecting additional devices to a single 120V AC 15A/20A circuit that is being used to charge your motorcycle.

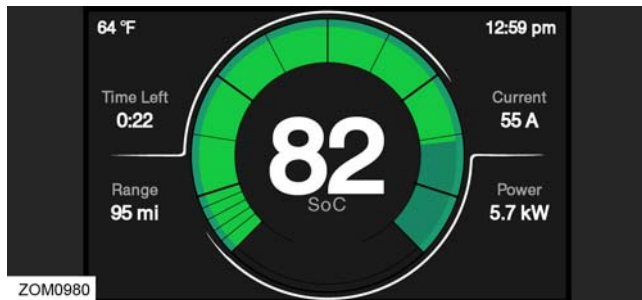

2. The dash will switch to the charging screen, which displays the SoC (percentage), time left to charge, charging current amperage, riding range on current charge, and charging kilowatts.
3. The charging icon flashes as the power pack is being charged. Once charging is complete, the icon will illuminate solid for a short period of time before the motorcycle powers down and the whole dash display shuts off.



Note: While charging with the key in the OFF position, the dash backlight will dim to level 1 after 5 minutes of charging. The dash backlight will extinguish after 10 minutes of charging, but the charging icon will continue to blink and operate normally.

4. For charging times, refer to the Technical Specifications section for charging times specific to the model and equipment level of your Zero Motorcycle. See [“Technical Specifications”](#), on page 8.1.

Power Tank (if equipped)

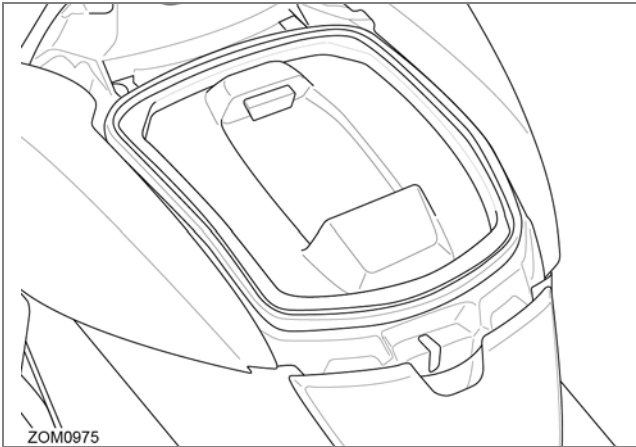

Your Zero motorcycle may be equipped with an optional Power Tank. The Power Tank equipment is installed in the place of the standard tank storage compartment, which also includes a closeout panel with greatly reduced storage space. The Power Tank's power pack increases the battery capacity of the motorcycle, which increases the riding range and charge times.

Charging Levels (Times)

The time it takes to charge the Zero SR/S is determined by the type of charging cable connected to the motorcycle, the charging equipment installed on the motorcycle, and the power rating (voltage and amperage) of the power supply available. To determine the charging equipment installed on your motorcycle, see [“How to Identify your Charger”, on page 5.2.](#)

Note: The charging times quoted in the Specifications section of this manual are the optimum times to charge the Zero SR/S assuming that there are no electrical infrastructure circuit limits.

Dependant upon where you operate your motorcycle in the world, the type of charging connector installed on the Zero SR/S and the terminology used to reference the charging equipment can vary. The following is a guide for reference only and is not exhaustive.

Note: If you are unsure of your charging equipment, either contact a Zero Motorcycles Dealer or a qualified electrician for assistance.

Power Pack and Charging

Europe

The charging connector is an IEC 62196 Type 2 (AKA Mennekes).

Mode 2	Requires a portable EVSE charging cable connected to a domestic wall outlet.
	230 Volt AC, 10 Amp circuit (typically).
Mode 3	Connection is from a wall mounted charging station on a dedicated electrical circuit at home, or a public EV charging station.
	230 Volt AC, 16 or 32 Amp circuit.
	Charging station requirements: Single phase for Standard SR/S (single 3 kW charger) 3-Phase for Premium SR/S (to utilize second 3 kW charger)*
*Premium SR/S 3 kW charger utilizes power supplied from pin specific to a 3-phase charging point.	

Rest of the World

The charging connector is an IEC 62196 Type1 (AKA J1772).

Level 1	Connection is from a domestic wall outlet.
	110 - 120 Volt AC, 12 to 16 Amp circuit (typically).
Level 2	Connection is from a wall mounted charging station on a dedicated electrical circuit at home, or a public EV charging station.
	208 - 240 Volt AC, 12 to 80 Amp circuit (depending on capabilities of the charging station).

Charging Cable Requirements

Always use a UL or CE marked EVSE (Electric Vehicle Supply Equipment) charging cable.

Add-On Electrical Equipment

WARNING: Do not add electrical components to your motorcycle unless they have been approved by Zero Motorcycles. Some add-on electrical components can damage your motorcycle, prevent other components from working as they should, and/or dramatically reduce the range and/or life expectancy of the power pack.

A series of horizontal dashed lines for writing notes.

Owner's Responsibilities

Listed below, are the responsibilities afforded to the owner:

- This owner's manual (supplied on a USB flash drive) should be considered a permanent part of this motorcycle and should remain with it even if the motorcycle is subsequently sold.
- Perform routine care and maintenance of your electric motorcycle as detailed in this owner's manual.
- Use only Zero approved parts and Zero Motorcycles accessories.
- The operator is responsible for learning and obeying all country, federal, state, and local laws governing the operations of an electric motorcycle.
- Always wear a regionally approved helmet, goggles, appropriate boots, and all other appropriate safety equipment when operating an electric motorcycle.

Parts/Maintenance Items

The proper replacement parts and fluid to use for maintaining your motorcycle are listed in the table below.

PART	NUMBER
Headlight Bulb	LED (replace the entire unit)
Turn Signal Light Bulb (amber)	RY10W (10 watt)
Brake/Tail Light Bulb	LED (replace the entire unit)
Front Running Light Bulb	LED (replace the entire unit)
Brake Fluid	DOT 4

Service History

Follow the maintenance schedules on [page 6.2](#). After each scheduled service or routine is performed, record the information in the Maintenance Record chapter of this book.

Scheduled Maintenance

The required maintenance schedule that follows, specifies how often you should have your Zero Motorcycle serviced and what items need attention. It is essential to have your Zero Motorcycle serviced as scheduled to maintain safe, dependable performance.

The service intervals in this maintenance schedule are based on average riding conditions. Some items will need more frequent service if you ride in unusually wet or dusty areas. Consult your dealer for recommendations applicable to your individual needs and use. It is recommended that you have your Zero Motorcycle serviced every 12 months by a Zero Dealer regardless of the distance ridden.

Maintenance Schedule

The scheduled maintenance must be performed in accordance with this chart to keep the Zero Motorcycle in top running condition. The initial maintenance is vitally important and must not be neglected. Where time and mileage are listed, follow the interval that occurs first.

#	ITEM	ROUTINE	EVERY RIDE	INITIAL	INITIAL	ODOMETER MILEAGE READING			
				600 mi (1K km) or 1 month	4K mi (7K km) or 6 months	8K mi (13K km) or 12 months	12K mi (19K km) or 18 months	16K mi (25K km) or 24 months	20K mi (31K km) or 30 months
1	Brake Fluid (front and rear)	Check brake fluid levels. Add brake fluid as necessary.	√	√	√	√	√	√	√
		Replace brake fluid (every 12 months).			√		√		
2	Front Brake	Check operation, and for fluid leakage. Replace brake pads if necessary.	√	√	√	√	√	√	√
3	Rear Brake	Check operation, and for fluid leakage. Replace brake pads if necessary.	√	√	√	√	√	√	√
4	Wheels	Check run-out, and for damage. Replace if necessary.			√	√	√	√	√
5	Tires	- Check tread depth, and for damage. Replace if necessary. - Check air pressure. See page 6.23 . Correct if necessary.	√		√	√	√	√	√
6	Wheel Bearings	Check bearings for smooth operation. Replace if necessary.		√	√	√	√	√	√

Maintaining Your Motorcycle

#	ITEM	ROUTINE	EVERY RIDE	INITIAL	INITIAL	ODOMETER MILEAGE READING				
				600 mi (1K km) or 1 month	4K mi (7K km) or 6 months	8K mi (13K km) or 12 months	12K mi (19K km) or 18 months	16K mi (25K km) or 24 months	20K mi (31K km) or 30 months	
7	Drive Belt	- Check belt tension. - Inspect belt for signs of damage or cracking. Replace belt: - Every 24K mi (37K km).	√	√						
8	Swingarm Pivot Bearings	Check bearings for smooth operation. Replace if necessary.								√
9	Steering Bearings	- Check for looseness. - Repack with all-purpose grease.		√	√	√	√	Repack		√
10	Chassis Fasteners	- Check all chassis fasteners and fittings. - Tighten and adjust as needed.			√	√	√	√	√	√
11	Front Brake Lever Pivot Shaft	- Apply silicone grease lightly. - Check operation. - Service/rebuild if necessary.		√	√	√	√	√	√	√
12	Front Fork	- Check operation and for oil leakage. - Service/rebuild if necessary.	√		√	√	√	√	√	√
13	Rear Shock Assembly	- Check operation and for oil leakage. Replace if necessary.	√		√	√	√	√	√	√

#	ITEM	ROUTINE	EVERY RIDE	INITIAL	INITIAL	ODOMETER MILEAGE READING			
				600 mi (1K km) or 1 month	4K mi (7K km) or 6 months	8K mi (13K km) or 12 months	12K mi (19K km) or 18 months	16K mi (25K km) or 24 months	20K mi (31K km) or 30 months
14	Throttle Grip	- Check operation and free play.	√		√	√	√	√	√
15	Kickstand Pivots	- Check operation. - Apply silicone grease lightly.			√	√	√	√	√
16	Kickstand Switch	Check operation and replace if necessary.		√	√	√	√	√	√
17	Drive Motor	Commissioning and timing.		√		√		√	

Note: From 24,000 mi (37,000 km) or 36 months, repeat the maintenance intervals starting from 8,000 mi (13,000 km) or 12 months.

Component Fasteners

Periodically check and tighten the following fasteners on your motorcycle.

Location	Item	Torque	Notes
A	Upper/Lower triple clamps pinch bolts	16 lb-ft (22 Nm)	Use LOCTITE® 242® (or equivalent)
B	Rear sprocket to wheel bolts	26 lb-ft (35 Nm))	Use LOCTITE® 242® (or equivalent)
C	ROF arm bolts	25 lb-ft (34 Nm)	Use LOCTITE® 242® (or equivalent)
D	Rear brake caliper brake pad bolt	6.6 lb-ft (9 Nm)	-
E	Rear shock mount bolts	52 lb-ft (71 Nm)	-
F	Handlebar clamp mount bolts	19 lb-ft (26 Nm)	-
G	Headlight mount bolts	3.7 lb-ft (5 Nm)	Use LOCTITE® 242® (or equivalent)
H	Front axle	40 lb-ft (54 Nm)	Use LOCTITE® anti-seize lubricant (or equivalent)
I	Front axle pinch bolts	16 lb-ft (22 Nm)	-
J	Rear brake pedal pivot bolt	34 lb-ft (46 Nm)	Use LOCTITE® 242® (or equivalent)
K	Rear brake master cylinder mount bolts	7 lb-ft (9.5 Nm)	Use LOCTITE® 242® (or equivalent)
L	Swingarm bolts	24.5 lb-ft (33 Nm)	Use LOCTITE® 242® (or equivalent)
M	Rear axle adjustment bolts	4 lb-ft (5.4 Nm)	-
N	Rear axle nut	75 lb-ft (102 Nm)	-
O	Motor mount side plate bolts	30 lb-ft (41 Nm)	Use LOCTITE® 242® (or equivalent)
P	Controller carrier to Power Pack bolts	3 lb-ft (4 Nm)	Use LOCTITE® 242® (or equivalent)
Q	Controller to controller carrier bolts	8 lb-ft (11 Nm)	-
R	Front brake caliper mount bolts	30 lb-ft (41 Nm)	Use LOCTITE® 242® (or equivalent)
S	Front brake caliper brake pad bolts	6.6 lb-ft (9 Nm)	-

Left Side of Motorcycle

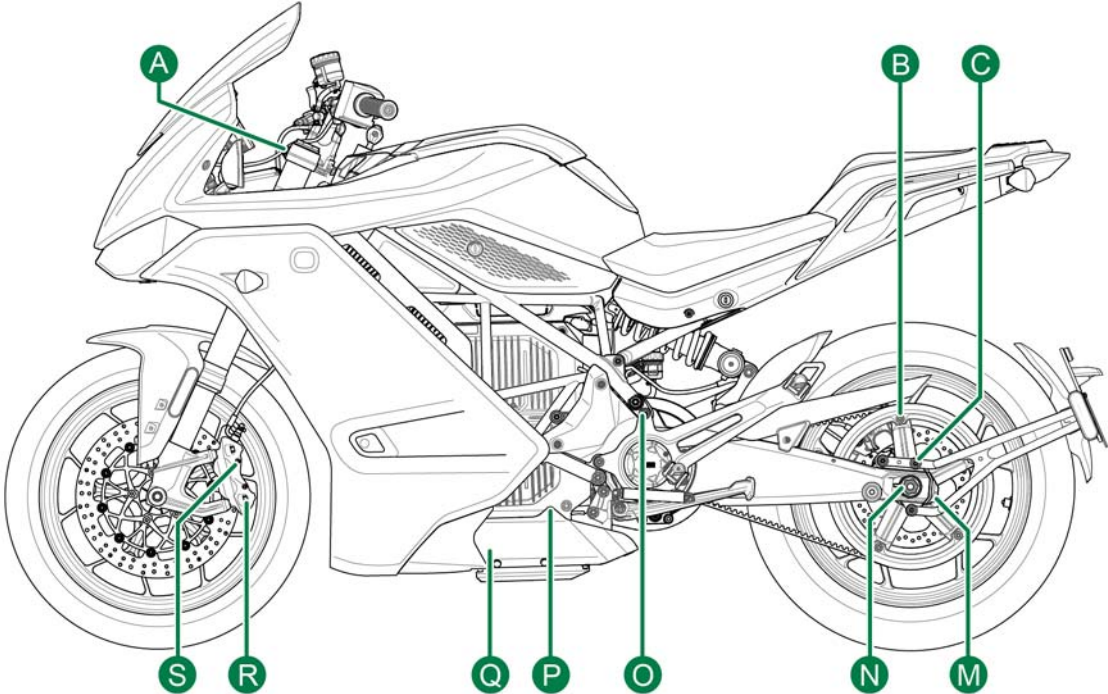

ZOM1009

Refer to Torque table on [page 6.6](#).

Right Side of Motorcycle

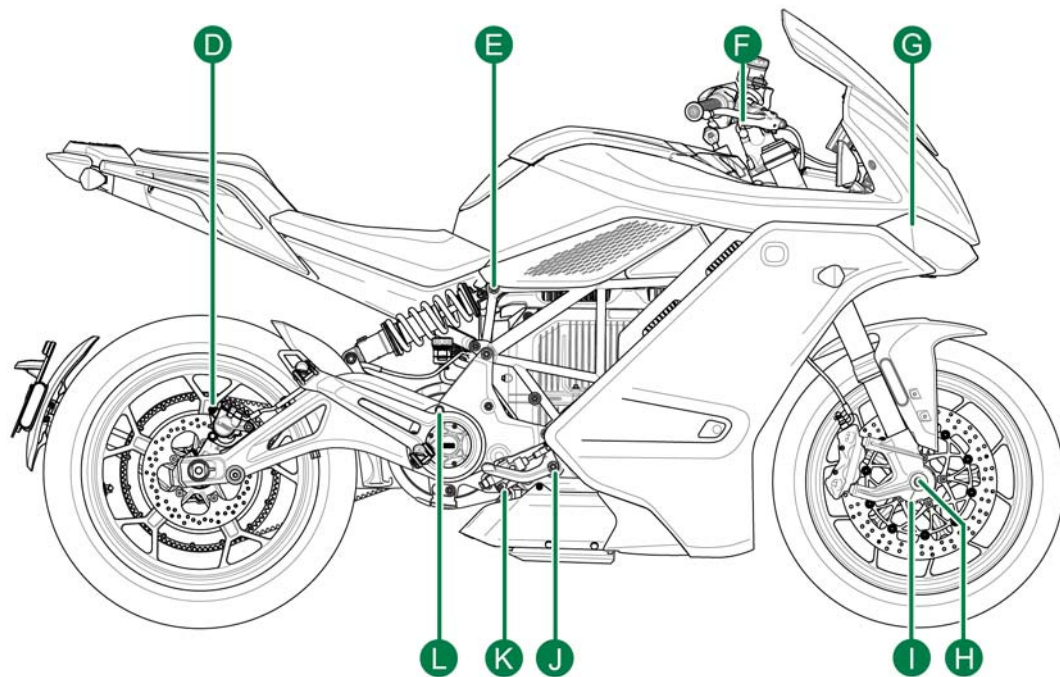

ZOM1010

Refer to Torque table on [page 6.6](#).

Power Pack

CAUTION: Never store your motorcycle at a state of charge less than 30%. Leaving the power pack discharged below 30% for a long period of time could damage the power pack and void the warranty.

Charge your motorcycle's power pack according to guidelines under "[When To Charge Your Z-Force® Power Pack™](#)", on [page 1.3](#). Once charged, disconnect from the AC power source. Leaving your motorcycle unplugged between charges will maximize the long term health of the power pack.

If stored long term, check the state of charge at least monthly and charge it back up to 60% if it has dropped below 30%.

1. The power pack is a lithium ion power system. While it does require charging, it does not require maintenance.
2. The power pack should be kept away from extremes of temperature. To maximize the life of the power pack, avoid leaving it parked in direct sunlight or parked/stored in an area with an ambient temperature below -4°F (-20°C) or above 95°F (35°C) for an extended period.
3. Only an authorized service agent is qualified to have access to the power pack's interior.

4. Dispose of the power pack according to your state and local laws. It is encouraged that the power pack be recycled rather than disposed of in landfills.

Please contact Zero at support@zeromotorcycles.com or locate a recycling center in your area.

Brakes

WARNING: Brake fluid is highly toxic - keep containers sealed and out of the reach of children. If accidental consumption of fluid is suspected, seek medical attention immediately.

WARNING: If the fluid comes into contact with the skin or eyes, rinse immediately with plenty of water.

WARNING: Do not ride the motorcycle if the brake fluid is below the **LOWER** level mark on either reservoir. Brake fluid **MUST** be added to the reservoir before riding.

WARNING: If the brake lever or pedal travel is unusually long, the feel is spongy or if there is any significant loss of brake fluid contact your Zero Motorcycles Dealer. Riding under such conditions could result in extended stopping distances or complete brake failure.

CAUTION: Only use new fluid from an airtight container. Fluid from open containers or fluid previously bled from the system will have absorbed moisture, which will adversely affect performance, and must not be used.

CAUTION: Brake fluid will damage plastic or painted surfaces. Soak up any spillage with an absorbent cloth immediately and wash the area with a mixture of car soap and water.

Your Zero SR/S is equipped with separate front and rear hydraulic braking systems each with their own fluid reservoir.

The fluid level in the reservoirs may drop slightly during normal use, as a result of brake pad wear, but should not be allowed to drop below the **LOWER** mark.

Bleeding the Brake System

Your motorcycle is equipped with ABS. It is only possible to bleed the brake system manually if fluid still remains in the HCU (Hydraulic Control Unit).

Bleeding a dry HCU will require an evacuation and fluid fill machine.

Brake Fluid Replacement

Brake fluid must be replaced every 12 months regardless of the distance the motorcycle has been ridden. It is recommended that this procedure is carried out by a Zero Motorcycles Dealer.

Front Brake Fluid Reservoir

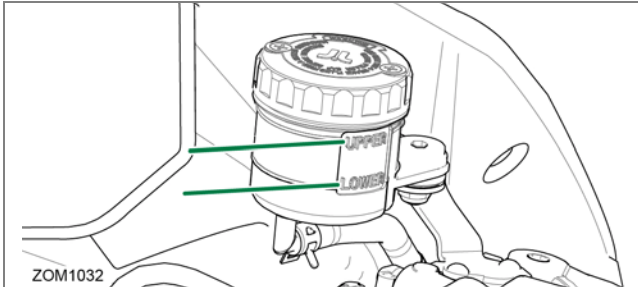

Inspect the level of the front brake fluid, visible through the reservoir. If the fluid level is below the **LOWER** level mark, add brake fluid until it reaches the **UPPER** level mark.

Note: The motorcycle should be in an upright position prior to checking fluid level.

1. Clean any dirt or debris from around the reservoir cap before opening the reservoir. Place a shop towel below the reservoir to absorb any spilled fluid.
2. Unscrew and remove the reservoir cap.
3. Add new DOT 4 brake fluid.

*Note: Do not overfill. Only fill to the **UPPER** level mark. Overfilling will cause fluid leakage while riding.*

4. Inspect the cap seal ensuring that it is free of any wear or damage then reinstall the cap.

Rear Brake Fluid Reservoir

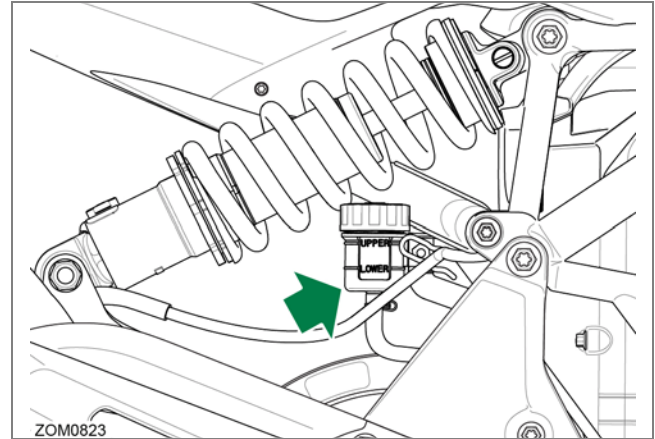

The reservoir is located inboard on the frame above the motor and is best viewed from the right hand side of the motorcycle.

Note: The motorcycle should be in an upright position prior to checking fluid level.

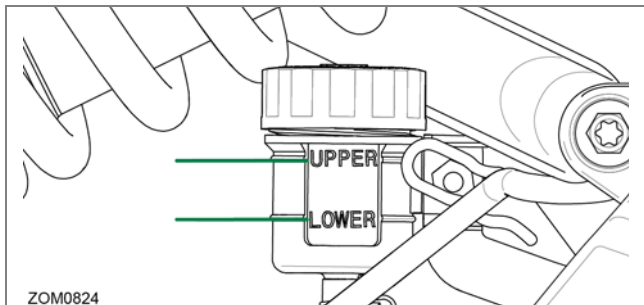

Inspect the level of the rear brake fluid through the reservoir housing. If the fluid level is below the **LOWER** level mark, add brake fluid until it reaches the **UPPER** level mark.

1. Clean any dirt or debris from the cap and reservoir opening before opening the reservoir. Place a shop towel below the reservoir to absorb any spilled fluid.
2. Unscrew and remove the reservoir cap.
3. Add new DOT 4 brake fluid.

*Note: Do not overfill. Only fill to the **UPPER** level mark. Overfilling will cause fluid leakage while riding.*

4. Inspect the cap seal ensuring that it is free of any wear or damage then reinstall the cap.

Brake Pad Inspection

The brake pads must be inspected when specified in the maintenance schedule, see [page 6.2](#).

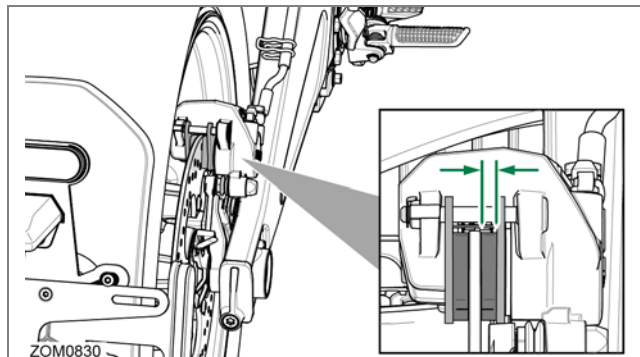

Determine the condition and remaining brake pad material thickness by inspecting the pads through the sides of the brake caliper.

Replace the brake pads if either pad's thickness is less than 0.04 in (1 mm). If the brake pads are worn they should be replaced immediately before riding your Zero SR/S.

Brake Disc Inspection

The thickness of the brake discs should be checked regularly. Replace brake rotor immediately, if less than minimum thickness.

Rotor	Measurement
Front	0.18 in (4.5 mm)
Rear	0.16 in (4.0 mm)

Brake Pad Replacement

Bedding in new brake pads and/or new brake discs is recommended to ensure proper brake performance and maximize brake life. Proper bedding improves brake pedal/lever feel and reduces or eliminates brake squeal. Bedding in the brakes is a process of depositing an even layer of pad material on the surface of the brake disc.

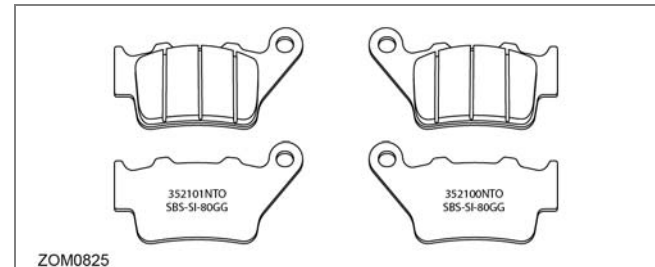

Front brake pads

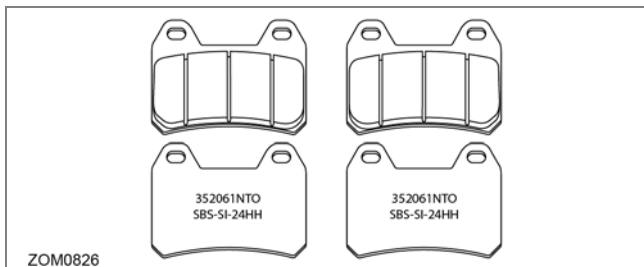

Rear brake pads

WARNING: With new brake systems or just new pads, the first few braking applications will result in very little braking power. Gently use the brakes a few times at low speeds (less than 25 mph [40 km/h]) to develop proper braking friction.

Suspension

Front

- For maintenance, see [“Maintenance Schedule”](#), on page 6.2.
- To adjust the fork, see [“Front Suspension Adjustment”](#), on page 6.15.

Rear

WARNING: The shock absorber assembly contains highly pressurized gas.

- Do not attempt to tamper with or open the cylinder or shock.
- Do not subject the shock to high temperature or open flame.

WARNING: Doing either of the above actions can cause the cylinder or shock to explode causing personal injury or death.

For maintenance, see [“Maintenance Schedule”](#), on page 6.2.

To adjust the rear shock, see [“Rear Shock Adjustment”](#), on page 6.19.

Front Suspension Adjustment

This motorcycle is equipped with Showa SFF-BP (Separate Function Forks - Big Piston) forks, which improves adjustability and provides a significant weight advantage. The left fork has preload adjustment and the right fork has rebound and compression damping. The enlarged 43 mm piston improves responsiveness of dampening force for a high-performance ride.

A shock has two main actions: compression when the shock gets loaded, and rebound when the shock returns back to full length. Compression damping is the adjustment that determines how fast or slow the fork compresses. Rebound damping is the adjustment that determines how fast or slow the fork rebounds.

Measuring Preload

Obtaining the correct front suspension preload (sag) is critical for proper handling. The spring preload must be set to match the weight of the rider. The spring is preloaded for a 200 lb (90 kg) rider (180 lb rider wearing 20 lb of gear). This puts the front tire 1/3 of the way through its travel. Heavier riders require stiffer spring settings. A good approximation of your front springs requirements can be found by measuring the front suspension's sag. This measurement quickly determines if your front springs are approximately correct for your weight. This adjustment is a recommended guideline; personal riding preference may vary from the specifications given.

To Check the Sag Value:

1. Support your motorcycle upright on a stand with the front wheel off the ground.

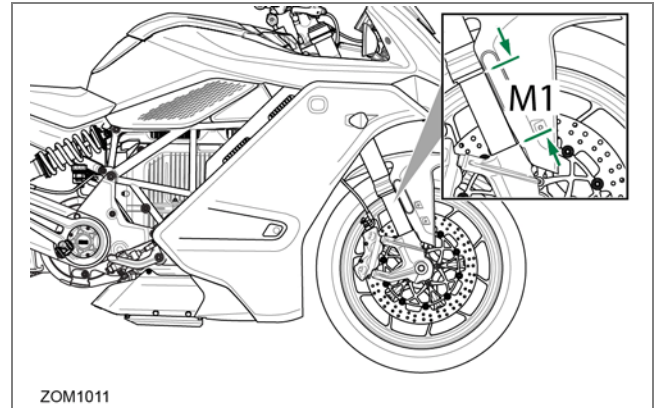

2. Measure vertically from the bottom of the fork tube to the bottom of the tube's dust seal.
3. Record this measurement (this is the measurement referred to as **M1**).
4. Remove the motorcycle from the stand.

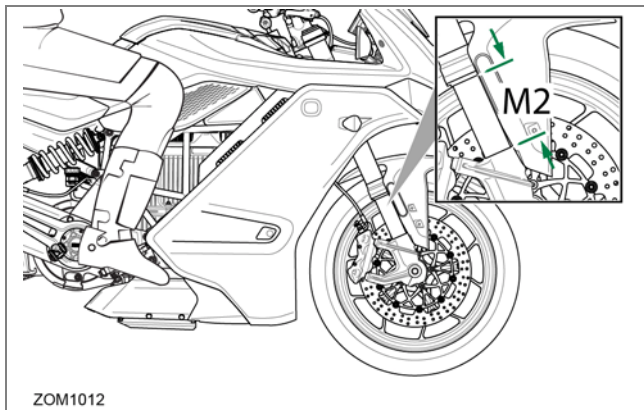

5. Wearing your normal riding apparel, sit on the motorcycle.
6. Have an assistant hold the motorcycle upright, your feet should be on both pegs.
7. Bounce the suspension a couple of times.
8. Have a second assistant take a measurement using the same locations as in step 2.
9. Record this measurement (this is the measurement referred to as **M2**).
10. Subtract the second measurement (**M2**) from the first measurement (**M1**).

Example:

Measurement	Operator	Value
M1		3.93 in (100 mm)
M2	-	2.16 in (55 mm)
Sag	=	1.77 in (45 mm)

In this example, the total sag is 1.77 in (45 mm). Refer to the box below for the correct sag.

Recommended total sag = 1.57 in (40 mm)

Note: If the total sag is greater than the recommended value, the spring preload should be adjusted. In this example the spring should be stiffened by turning the preload adjuster clockwise.

Spring Preload Adjustment

The spring preload adjuster is located on the top of the fork tube and is adjusted by inserting a 6 mm hex wrench and turning clockwise or counterclockwise.

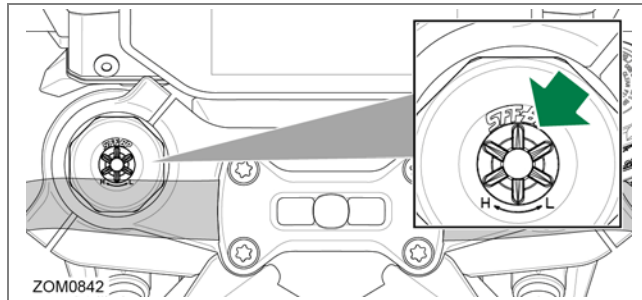

Note: When adjusting preload, always start from the minimum setting.

- Turning the preload adjuster clockwise increases the spring preload and reduces the sag of the front suspension.
- Turning the preload adjuster counterclockwise decreases the spring preload and increases the sag of the front suspension.

CAUTION: Adjusters should never be forced completely clockwise or counterclockwise; always leave one click of adjustment in either direction.

Rebound Damping

Rebound damping determines fork suspension rebound behavior. Due to the design of the SFF-BP fork, always adjust rebound tension before compression.

Note: Rebound adjustments will have some affect on compression setting.

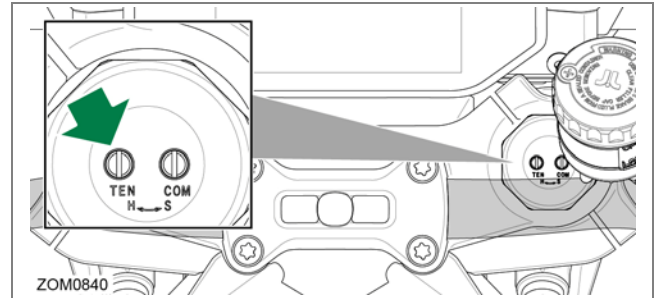

- Turning the rebound tension **TEN** adjuster screw clockwise will increase damping.
- Turning the rebound tension **TEN** adjuster screw counterclockwise will decrease damping.

CAUTION: Adjusters should never be forced completely clockwise or counterclockwise; always leave one click of adjustment in either direction.

Compression Damping

Compression damping determines fork suspension compression behavior.

Due to the design of the SFF-BP fork, always adjust rebound tension before compression. "Rebound Damping", on page 6.17

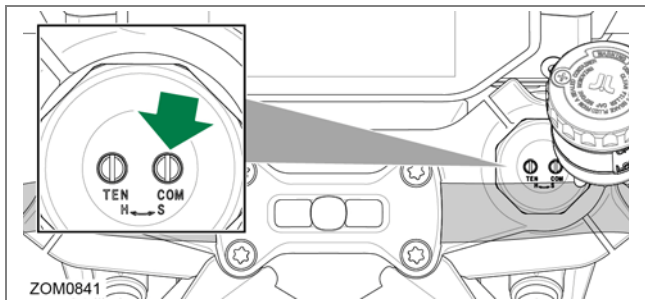

- Turning the compression **COM** adjuster screw clockwise will increase damping.
- Turning the compression **COM** adjuster screw counterclockwise will decrease damping.

Start with a middle setting and fine tune the compression from there. Proper compression allows the tire to track the ground over consecutive bumps. Compression that is set too slow will pack-up (feel harsh over consecutive bumps), while compression that is set too fast will cause the fork to bottom out

harshly. If the fork is bottoming out, turn the adjuster one click at a time until the bottoming out stops.

CAUTION: Adjusters should never be forced completely clockwise or counterclockwise; always leave one click of adjustment in either direction.

Factory Supplied Front Suspension Settings

The following information will allow you to adjust the front suspension back to the factory settings.

Adjustment	Setting
Front Fork Preload	Min + 5.0 turns clockwise
Front Fork Rebound	Max - 3.75 turns counterclockwise
Front Fork Compression	Max - 6.5 turns counterclockwise

Sport Front Suspension Settings

The following information is a suggested baseline for generic sport settings.

Adjustment	Setting
Front Fork Preload	Min + 5.0 turns clockwise
Front Fork Rebound	Max - 4.25 turns counterclockwise
Front Fork Compression	Max - 5.0 turns counterclockwise

Rear Shock Adjustment

Measuring Preload

Obtaining the correct rear spring preload (sag) is critical for proper handling. The spring preload must be set to match the weight of the rider. The spring is preloaded for a 200 lb (90 kg) rider (180 lb rider wearing 20 lb of gear). This puts the rear tire 1/3 of the way through its travel. Heavier riders and motorcycles carrying additional cargo or accessories require stiffer spring rates. A good approximation of your rear spring requirements can be found by measuring the rear suspension's sag. This measurement quickly determines if your rear spring is approximately correct for your weight. This adjustment is a recommended guideline; personal riding preference may vary from the specifications given.

To Check the Sag Value:

1. Support your motorcycle on a stand with the rear wheel off the ground.

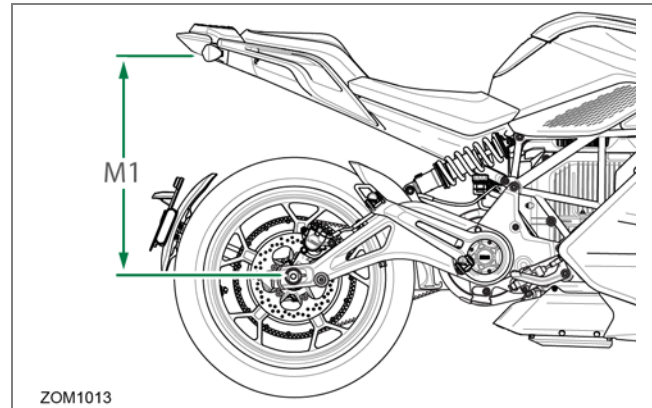

2. Measure vertically from the rear axle to the tail light. Mark this spot as it is used for other measurements.
3. Record this measurement (this is the measurement referred to as **M1**).
4. Remove the motorcycle from the stand.

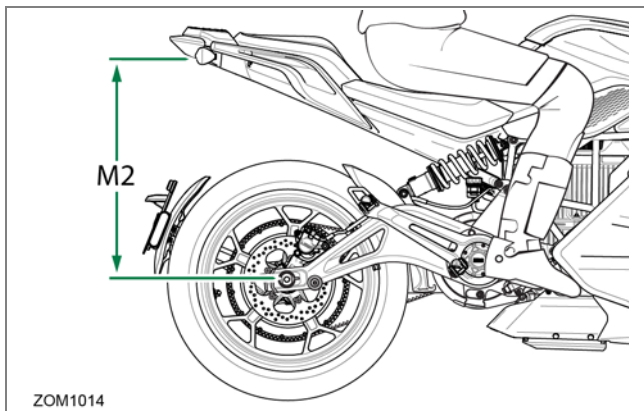

5. Wearing your normal riding apparel, sit on the motorcycle.
6. Have an assistant hold the motorcycle up, your feet should be on both pegs.
7. Bounce the suspension a couple of times.
8. Have a second assistant take a measurement using the same locations as in step 2.
9. Record this measurement (this is the measurement referred to as **M2**).
10. Subtract the second measurement (**M2**) from the first measurement (**M1**).

Example:

Measurement	Operator	Value
M1		23.62 in (600 mm)
M2	-	21.59 in (548.5 mm)
Sag	=	2.03 in (51.5 mm)

The total sag is 2.03 in (51.5 mm). Refer to the box below for the correct sag.

Recommended total sag = 1.83 in (46.5 mm)

Note: If the total sag is greater than the recommended value, the spring preload should be adjusted. In this example the spring should be stiffened by turning the shock's adjustment collar clockwise.

Spring Preload Adjustment

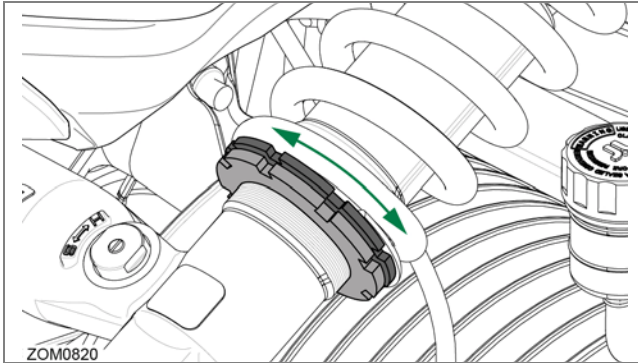

1. Clean any dirt or debris from the slots of the shock adjusting collar.
2. Using an adjusting wrench, loosen the locking collar (bottom).
3. Using an adjusting wrench, turn the adjusting collar (top).
4. For sag measurements less than the specified value, decrease the preload on the spring by turning the adjustment collar counter-clockwise on the shock. If more than the specified value, increase the preload on the spring by turning the adjustment collar clockwise on the shock.
5. Using an adjusting wrench, tighten the locking collar (bottom) against adjusting collar (top).

Rebound Adjustment

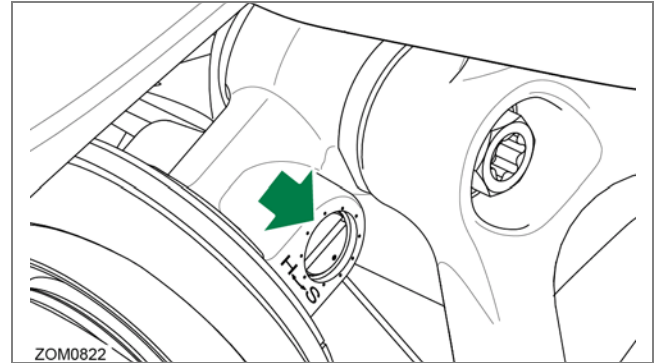

The rebound (tension) damper adjuster screw is at the top of the shock. Printed on the shock, is “H” meaning *Hard* (**MAX**, which is for slower rebound) and “S” meaning *Soft* (**MIN**, which is for faster rebound). The ride quality adjustment screw controls the hardness or softness the ride quality of your motorcycle.

- Turning the screw clockwise, or H direction, is better for big impacts.
- Turning the screw counter-clockwise, or S direction, is better for smaller and more frequent impacts.

Note: Adjusters should never be forced completely “Soft” or “Hard”; always leave one click of adjustment in either direction.

Compression Adjustment

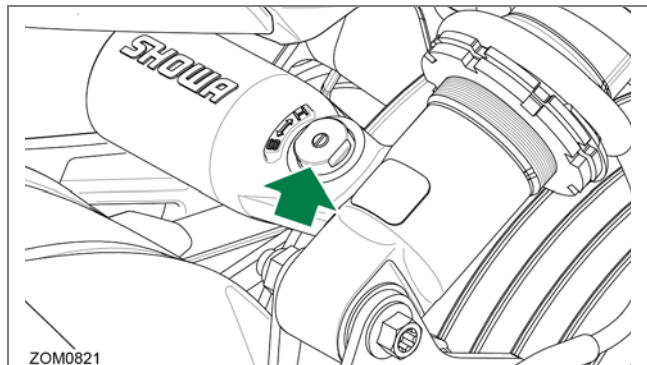

The compression damper adjustment screw is at the bottom of the shock. Printed on the shock, is “H” meaning *Hard* (**MAX**, which is for slower compression) and “S” meaning *Soft* (**MIN**, which is for faster compression). Turn the adjuster clockwise for a harder ride (slower compression). For a softer ride (faster compression), turn the adjuster counter-clockwise.

Start with a middle setting and fine tune the compression from there. Proper compression allows the tire to track the ground over consecutive bumps.

Compression that is set too hard will pack-up (feel harsh over consecutive bumps), while compression that is set too soft causes the shock to bottom out harshly. If the shock is

bottoming out, turn the adjuster one click at a time until the bottoming out stops.

Note: Adjusters should never be forced completely “Soft” or “Hard”; always leave one click of adjustment in either direction.

Factory Supplied Rear Suspension Settings

The following information will allow you to adjust the rear suspension back to the factory settings.

Adjustment	Setting
Rear Shock Rebound	Max - 15 clicks counterclockwise
Rear Shock Compression	Max - 27 clicks counterclockwise.

Sport Rear Suspension Settings

The following information is a suggested baseline for generic sport settings.

Adjustment	Setting
Rear Shock Rebound	Max - 13 clicks counterclockwise
Rear Shock Compression	Max - 15 clicks counterclockwise

Wheels And Tires

Inspect both wheels for the following:

- Bends or cracks.
- Impact marks.

Inspect both tires for the following:

- Cuts, cracks, splits, or missing tread lugs in the tread or sidewall area.
- Bumps or bulges within the tire body.
- Uneven tire tread wear. Wear on one side of the tire tread or flat spots in the tire tread indicate a problem with the tire or motorcycle.
- Exposed tire thread or cords.
- Tread depth below 1/16 in (1.6 mm).

If either of the wheels or tires are found to have any of the above conditions, replace the wheel or tire immediately.

Tire Inflation

WARNING: Under-inflation is a common cause of tire failure and may result in severe tire cracking, tread separation, bead unseating from wheel, “blowout,” or unexpected loss of motorcycle control, causing serious injury or death.

Front Tire	Rear Tire
248 kPa (36 PSI)	248 kPa (36 PSI)

Tire pressure should be checked and adjusted to the proper inflation level before each ride. Tire pressure should be checked using an accurate gauge when the tires are COLD.

Note: A COLD tire is defined as one that has not been ridden on for at least 3 hours.

Note: Always install the valve stem caps after adjusting the tire pressures.

Tire Replacement

WARNING: ONLY replace the tires with Zero Motorcycles approved radial tires. See “Specifications”, on page 8.2. These are the only tires that have been tested and approved for use on the Zero SR/S.

WARNING: Installation of non approved tires may cause adverse handling and performance problems and prevent the correct operation of the ABS and MTC.

Drive Belt

The drive belt provides low maintenance and quiet operation with minimal stretch. Keep dirt, grease, oil, and debris off the belt and sprockets. The drive belt tension should be checked and adjusted at the intervals specified in the Maintenance Schedule. For maintenance information, see the Maintenance Schedule on [page 6.2](#).

Clean the belt with mild soap and water when washing your motorcycle. Towel dry and inspect for the following:

- Cuts or unusual wear patterns.
- Damage to the center of the belt.
- Outside edge beveling. Some beveling is common but it indicates that sprockets are misaligned.
- Outside ribbed surface for signs of stone puncture.
- Inside (tooth portion) of belt for exposed tensile cords normally covered by nylon layer and polyethylene layer. This condition will result in belt failure and indicates worn sprocket teeth.
- Signs of puncture or cracking at the base of the belt teeth.

If any of the above conditions are found, the belt should be replaced.

Checking Drive Belt Tension

Proper belt tension is essential for optimum operation of the drive system.

Lack of belt tension can lead to “ratcheting.” The teeth of the belt slide over the teeth of the rear sprocket. This causes an unpleasant sound; the ratcheting can also cause damage to the carbon tensile cords. If ratcheting has occurred you should replace the belt before the next time you ride.

Too much tension can increase the wear of your drive system and the system can drag.

The drive belt tension can be checked by using a Tension Tester or the Gates® Carbon Drive™ Smartphone application.

Gates® Carbon Drive™ Smartphone Application



The drive belt tension can be checked by using the Gates® Carbon Drive™ Smartphone application, which measures belt tension frequency.

The application is available for free to download at both the Apple iTunes® store and Google Play® store. iTunes® is a registered trademark of Apple. Google Play® store is a registered trademark of Google.

Note: Perform belt frequency measurement on the lower belt span, close to the center (between the sprockets).

Note: The application works best in a quiet environment.

Note: The following application instructions may differ between phones.

1. Remove the key from the key switch.
2. From the application, click the Tension icon and Measure.
3. Confirm the phone's microphone is ON (if applicable).
4. Hold the phone, so the microphone is as close to the drive belt as possible (without touching the belt).

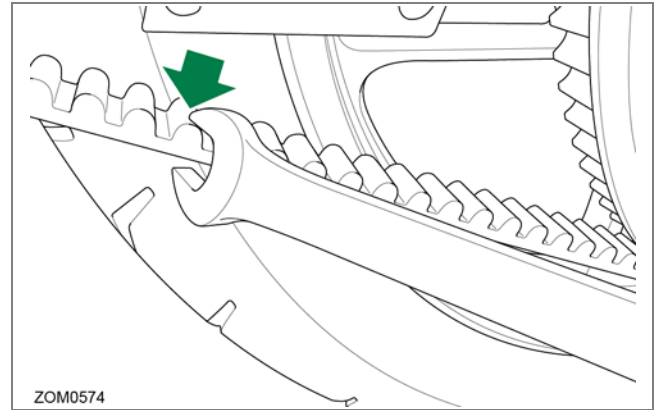

5. Pluck the belt with your thumb or a wrench (as shown) so that it vibrates like a guitar string.
6. The microphone will measure vibration's frequency.

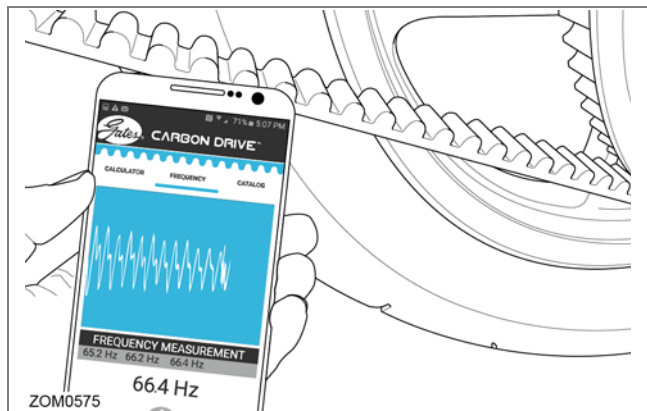

7. Rotate the rear wheel a quarter-turn and repeat the frequency measurement.
8. Compare your belt's frequency readings to the recommended range values below.
9. Adjust drive belt tension if the frequency is outside the recommended range.

Belt Pitch	Recommended Tension Range
11 mm	62 Hz to 82 Hz

Drive Belt Tension Tester

Note: Whenever possible, the preferred Gates® Carbon Drive™ Smartphone application should be used when adjusting the drive belt tension. See “Gates® Carbon Drive™ Smartphone Application”, on page 6.25.

The Tension Tester has a plastic measurement arm, located in a slot. Along this slot there is a measuring scale. The point of intersection of the measurement arm and the measuring scale shows the tension of the belt. There is a button (clicking pad) on the upper side of the Tension Tester, where you can secure your finger with a rubber band holder. A spring is located underneath this clicking pad. If a certain pressure is applied to the spring, it makes a clicking sound.

Note: The belt guard interferes with checking the belt tension using the Tension Tester, from the top side. Belt tension can be checked from under the motorcycle without interference.

Drive Belt Adjustment Procedure

Note: Adjust both sides (left and right) equally.

1. Remove key from the key switch.
2. Remove rear fender arm.
3. Loosen the rear axle nut.

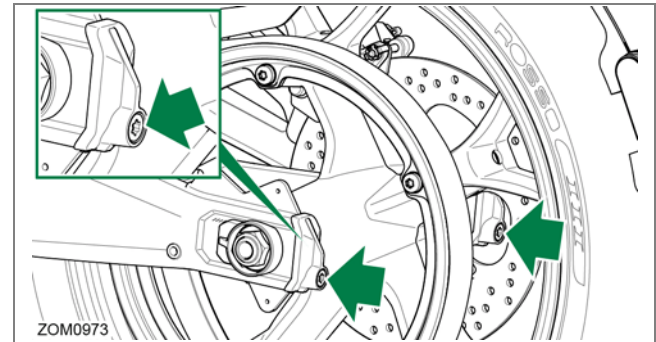

1. Remove the key from the key switch.
2. Press the Tension Tester steadily to the non-cogged side of the belt, half of the distance between the motor-driven sprocket and rear wheel drive sprocket. The “lip” of the tester will lead the tester on to the belt.
3. Slowly increase the pressure on the tester, until you hear a clicking sound. Do not increase the pressure after the tester has clicked.
4. Remove the tester carefully from the belt. Avoid rough movements of the tester, as this would change the results of the measurement.
5. Adjust drive belt tension if the measurement is outside the recommended range.

Belt Pitch	Recommended Tension Range
11 mm	51 kg to 102 kg

-
- The diagram shows a close-up of the rear wheel assembly. A hand is shown adjusting the drive belt tension using adjustment bolts. The diagram is labeled ZOM0973.
4. Turn the (left and right) adjustment bolts 1/4 turn at a time until the belt adjustment is within specification.
 5. Tighten the axle nut. Torque 75 lb-ft (102 Nm).
 6. Test ride the motorcycle.
 7. Recheck the belt for proper adjustment after the test ride and readjust, if necessary.

Seat Removal

The rider's seat must be removed to gain access to the 12 volt battery and 12 volt fuse center.

Removing the rider's seat



1. Unlock and release passenger seat using the key.
2. Remove passenger seat.

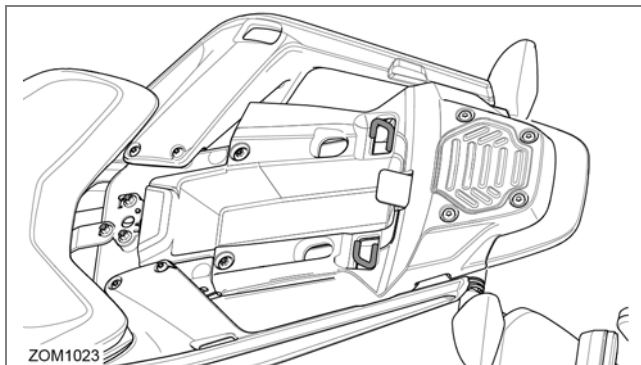

3. Remove bolt securing the rider's seat to the frame. Torque - 8 lb·ft (11 Nm).
4. Remove rider's seat.

Installing the seat

1. Installation of the seat is the reverse of the removal procedure.

Note: During installation of the rider's seat, confirm the front of the seat is properly inserted into its receiver prior to reinstalling the securing bolt at the rear.

Note: During installation of the passenger seat, confirm the rear of the seat is properly inserted into the tab located forward of the tail light.

Headlight Alignment

The headlight should be checked for correct alignment periodically. It must be aligned any time the suspension sag is adjusted because this affects the headlight alignment. Before the headlight can be aligned, the suspension sag and tire pressure must be correctly adjusted. The headlight can be adjusted vertically. If the vertical adjustment is off, it causes the beam to point too close to or too far ahead of the motorcycle. With the headlight on the low beam position, the motorcycle perpendicular to the ground, and the operator sitting on the motorcycle, verify the beam alignment. The motorcycle is shipped with the headlight at a 0.5-2.5% dip.

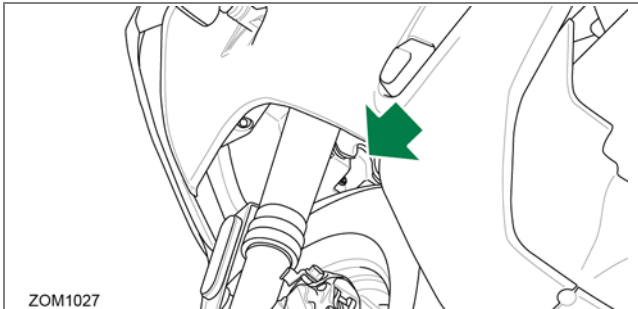

The adjustment screw is located on the back of the headlamp in the center. To adjust the headlight, turn the screw until the correct beam alignment is achieved.

Headlight/Running Light Replacement

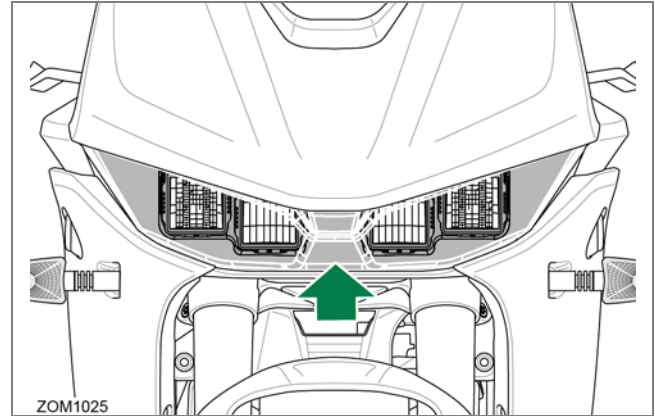

The headlight/running light assembly is sealed and is non-serviceable. Please contact your Zero Motorcycles dealer for replacement.

Turn Signal Light Bulb Replacement

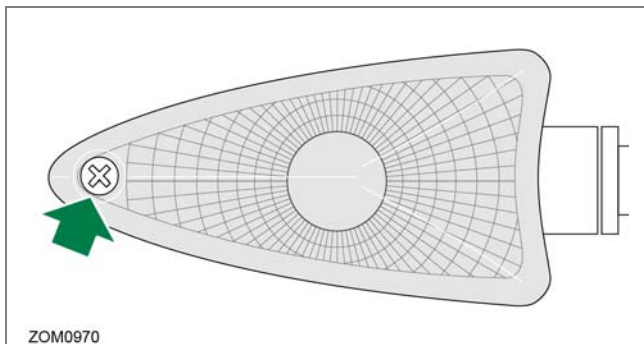

1. Remove the turn signal lens screw and remove the lens.
2. Push in on the bulb, turn the bulb counterclockwise, and then pull the bulb out.
3. Insert the new bulb into the socket, push in and turn clockwise until it stops.
4. Install the lens and screw; tighten the screw. Do not over-tighten the screw.

Brake/Tail LED Replacement

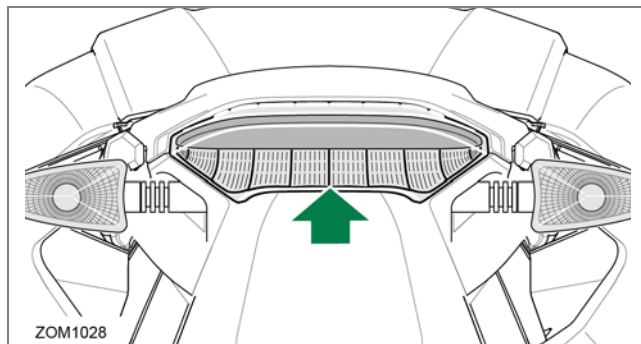

The brake/tail light assembly is a sealed non-serviceable LED unit. Please contact your Zero Motorcycles dealer for replacement.

12 Volt Battery

WARNING: DO NOT connect any accessories directly to the 12 volt battery. Operation of the motorcycle and ABS may be adversely affected. ONLY use the provided 12 volt accessory connectors. See [“12 Volt Accessory Connectors”, on page 6.33.](#)

Your Zero motorcycle is equipped with a 12 volt maintenance free battery to power the motorcycle’s systems when the key switch is in the OFF position.

The 12 volt battery is located underneath the rider’s seat, accessed from the left hand side of the motorcycle.

The 12 volt battery is charged from the motorcycle’s power pack. During regular operation and when connected to a charging cable, the MBB (Main Bike Board) will monitor the 12 volt battery’s charge level to ensure that it’s charge level is maintained.

CAUTION: Only replace the 12 volt battery with a genuine Zero Motorcycles 12 volt battery available from your dealer. The 12 volt battery has a heater mounted to its exterior to ensure optimal operation during cold weather. Installation of a non-approved 12 volt battery may prevent the motorcycle from operating correctly and will cause errors to be displayed on the dash panel.

Charging the 12 volt battery

WARNING: Do not attempt to charge the 12 volt battery if the voltage has fallen below 10V. A 12 volt battery with voltage less than 10V may be damaged and could catch fire/explode if charged.

CAUTION: The 12 volt battery must be removed/disconnected from the motorcycle before testing or charging.

CAUTION: Do not connect a battery maintainer (trickle charger) to the 12 volt battery while it is installed/connected to the motorcycle. The connection of a battery maintainer may cause problems with the motorcycle’s own charging system.

CAUTION: Only use an approved LIFEPO4 charger suitable for your battery’s voltage, chemistry and maximum charge rate.

Removing the 12 volt battery

1. Remove key from key switch.
2. Remove rider's seat. See "Seat Removal", on page 6.28.

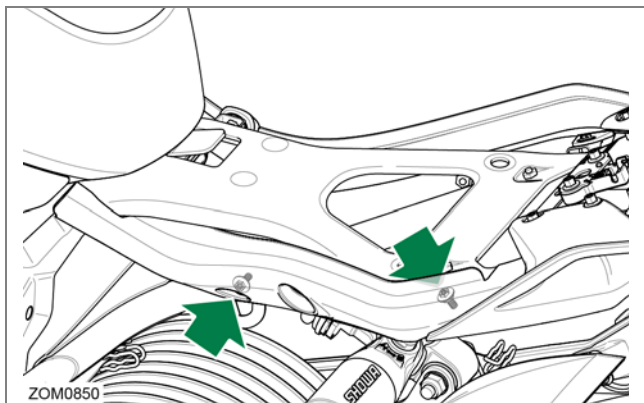

3. Remove bolts (x2) securing seat closeout panel.

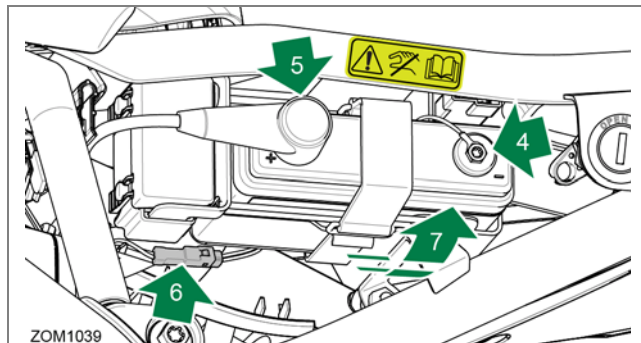

4. Remove bolt securing cable to negative (-) battery terminal.
5. Slide back cover from positive (+) battery terminal and remove bolt securing cable to terminal.
6. Disconnect battery heater harness connector.
7. Release strap securing battery to motorcycle.
8. Remove 12 volt battery from motorcycle.

Installing the 12 volt battery

CAUTION: Ensure the 12 volt battery is correctly orientated and secured with strap to prevent movement when the motorcycle is being ridden.

Installation of the 12 volt battery is the reverse of the removal procedure.

12 Volt Accessory Connectors

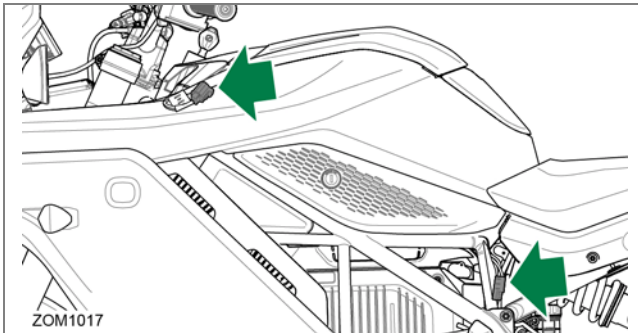

Your Zero motorcycle has two 12 volt accessory connectors for the connection of additional electrical devices. These connectors are powered by the motorcycle's DC-DC converter and not the 12 volt battery.

CAUTION: These connectors are the only approved method for powering Zero approved add-on electrical accessories. If you have any questions on the connection of 12 volt accessories, contact your Zero Motorcycles dealer.

Fuses

Whenever there is an excessive amount of current flowing through a circuit the fusible element will melt and create an open or incomplete circuit. Fuses are a one-time protection device and must be replaced each time the circuit is overloaded. Replace the fuse with one of equal current and voltage rating. If the fuse melts repeatedly, have the electrical system inspected by your dealer.

Power Distribution Unit

The Power Distribution Unit controls many of the functions of the motorcycle and acts in place of the fuses for the following circuits:

- High Beam
- Low Beam
- Running Lights
- Blinkers
- Horn
- 12 volt Auxiliary Outlet
- Brake Light
- Motor Controller
- Dash
- OBDII Port

12 Volt Fuse Center

The 12 volt fuse center is located underneath the rider's seat.

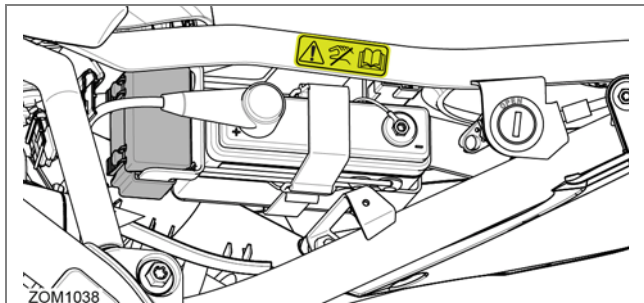

The fuse center (shaded) is equipped with a protective cover that must first be opened to gain access to the fuses.

To access the 12 volt fuse center:

1. Remove rider's seat. See ["Seat Removal"](#), on page 6.28.

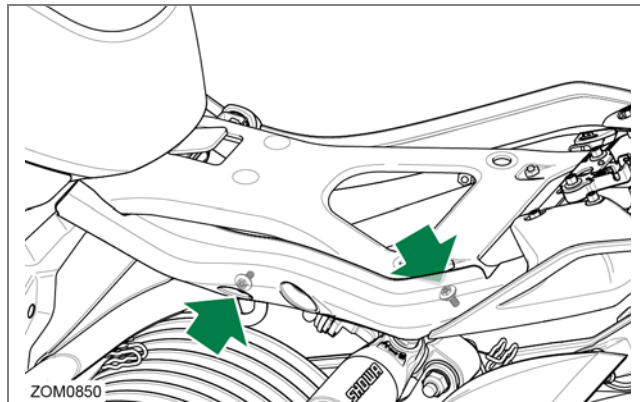

2. Remove bolts (x2) securing seat closeout panel.
3. Release fuse center cover tabs (x2).
4. Open fuse center cover.
5. Replace the fuse(s).

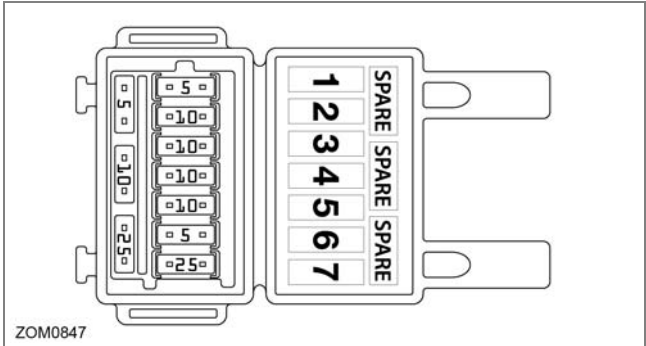

ZOM0847

The 12 volt fuse values are listed below:

Fuse	Rating	Circuits Controlled
1	5A	Cell Module
2	10A	ABS-9 Valve
3	10A	PDU (Power Distribution Unit)
4	10A	PDU (Power Distribution Unit)
5	10A	PDU (Power Distribution Unit)
6	5A	Dash
7	25A	ABS-18, Motor

High Voltage Fuses

The high voltage fuses are located on the left side of the power pack.

To replace a fuse:

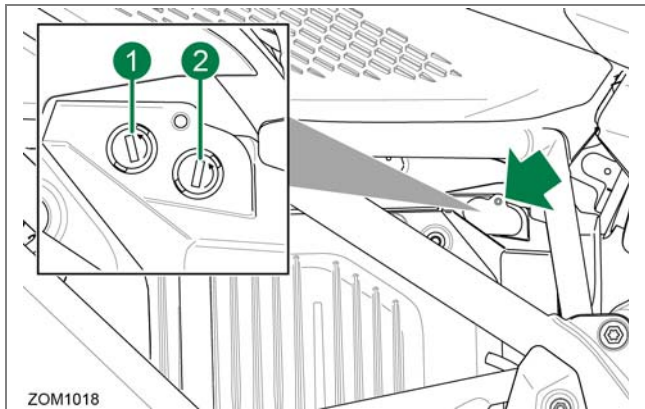

1. Remove bolt securing the fuse cover to power pack and remove cover.
2. Push cap inward and turn counter clockwise to release.
3. Withdraw the fuse and cap from the power pack.
4. Pull fuse from fuse cap and replace fuse with one of equivalent rating.
5. Install fuse and cap.

6. Install cover and secure with bolt. Torque - 0.6 lb·ft (0.8 Nm).

The high voltage fuse values are listed below:

Fuse	Rating	Circuits Controlled
1	SPT3.15A	DC/DC Converter
2	SPT3.15A	MBB (Main Bike Board)/Contactor

Cleaning

CAUTION: Improper cleaning can damage electrical components, cowlings, panels, and other plastic parts. Do not use steam or high-pressure water cleaner systems; they can cause water intrusion of bearing, seals, and electrical components. Avoid spraying water of great force around the dash unit, charge port, power pack, and controller.

To prolong the life of your motorcycle it should be washed periodically. Regular cleaning is an important factor in maintaining the value of your motorcycle. It also ensures that safety related parts remain in full working order.

If tar, bugs, or other similar deposits have accumulated, clean them off as soon as possible.

WARNING: After cleaning and before starting your journey, always test the brakes.

Wheels and tires

Avoid using strong acidic wheel cleaners. If such products are used on hard-to-remove dirt, do not leave the cleaner on the affected area any longer than instructed. Also thoroughly rinse the area off with water, immediately dry it, and then apply a corrosion protection spray.

Do not use products such as tire dressings on tires as this will adversely affect traction.

Washing

WARNING: Do not use high-pressure washers (like those at coin-operated car washes) as these can damage certain parts.

CAUTION: Do not use any harsh chemical products on plastic parts. Be sure to avoid using cloths or sponges which have been in contact with strong abrasive cleaning products, solvent or thinner, fuel (gasoline), rust removers or inhibitors, brake fluid, antifreeze, or electrolyte.

Note: We recommend the use of a garden hose to wash your motorcycle. Avoid directing the water jet at any electrical components or at the swing arm pivot bearings.

1. Gently wash your motorcycle with a sponge or a clean soft cloth, mild detergent, and plenty of water.
2. Use care when cleaning the plastic parts (dash, fenders, and side panels), which can scratch easier than the other parts of your motorcycle.
3. After washing, rinse your motorcycle thoroughly with plenty of clean water to remove any detergent residue.
4. Dry your motorcycle with a chamois or a soft, dry towel.
5. After cleaning, inspect for damage, wear or leaks.

After washing the motorcycle, allow all of the electrical components to dry prior to operation. If the motorcycle is ridden after being washed, apply both brakes several times in order to remove any moisture from the brake pads.

Parking and Long Term Storage

- Whenever you plan on not riding or storing your motorcycle for extended periods of time (more than 30 days), it is recommended that you charge the power pack to approximately 60% state of charge (SoC) and then leave the charger disconnected.
- If the key switch has not been in the ON position within the last 30 days, the Battery Management System (BMS) will activate long term storage mode which will automatically drain the power pack to 60% SoC. If the motorcycle is connected to the charger while in long term storage mode, the maximum SoC will be limited to 60%.
- The power pack will discharge extremely slowly over time. Check the SoC at least monthly and charge it back up to 60% if it has dropped below 30%.
- To prolong the life of your power pack you should store your motorcycle in a cool area. Storing your motorcycle in a hot area will cause your power pack's life to be shortened. The recommended storage temperature is -4°F (-20°C) to 95°F (35°C).
- When you're ready to take your motorcycle out of storage to ride it again, turn the key switch to the ON position and back to OFF to exit long term storage mode. Charge for at least 24 hours to ensure optimal cell balance is restored.

For more information on the power pack and the electrical system, see [page 5.1](#).

WARNING: Opening of the power pack is for trained Zero Motorcycles technicians. Please be aware that incorrect handling of a Zero power pack can be dangerous. **DO NOT OPEN!**

Electric Motorcycle Precautions

Your Zero Motorcycle has high voltage components. The high voltage used by these components is dangerous and can cause personal injury, severe burns, electric shock and even fatal injury unless appropriate precautions are taken.

Always observe and obey the instructions on labels attached to components on the vehicle - they are there for your safety.

Do not touch, attempt to remove or replace any high voltage parts, wiring (identified by the orange outer sleeving) or connectors. If the motorcycle is involved in an accident do not touch any high voltage wiring connectors or the components connected to the wiring. If a motorcycle fire occurs, extinguish visible flame with a Class D powder-type fire extinguisher. After flame has extinguished, douse with a water-based fire extinguisher.

WARNING: Your motorcycle uses high voltage. System components can be too hot to touch during and after starting and when the motorcycle is shut off. Be careful of both the high voltage and the high temperature. Obey all labels that are attached to the motorcycle.

WARNING: The motorcycle's high voltage system has no user serviceable parts. Disassembling, removing or replacing high voltage components, cables or connectors can cause severe burns or electric shock that may result in serious injury or death.

High voltage cables are colored orange for easy identification (see First Responder Information at the back of this manual).

Troubleshooting Your Motorcycle

All of the motorcycles are carefully inspected before they are delivered. Even after the motorcycles are inspected, some technical issues can occur. The following information offers a guide to help you to identify an issue, and if possible, repair it yourself. If you are unable to solve an issue with your Zero SR/S electric motorcycle, take it to an authorized dealer at your convenience. If there is no dealer in your area call Zero Motorcycles Customer Service.

System Notifications

A system notification is generated and appears on bottom of the dash for 5 seconds when a non-critical event occurs.

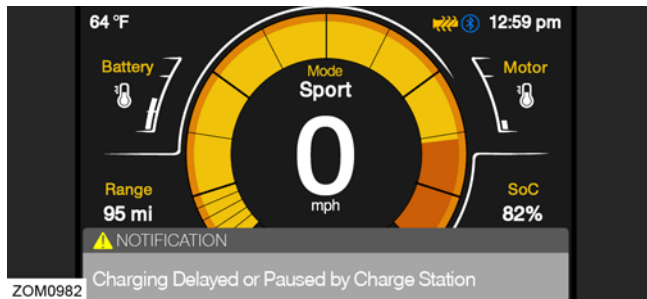

System notifications are displayed at the time of the event, but is not stored or viewable after the notification extinguishes.

Code	Notification Message
1	Acquiring Keys
2	Key Acquired Insert Next Key
3	Key Error - Insert Key Again
4	Max number of Keys Reached
5	Keys successfully stored
6	Storage Mode Active
7	Storage Mode Inactive
8	Heated Grips Not Installed

Code	Notification Message
9	12V Battery Heating up
10	Firmware Update Success!
11	Firmware Update Failure! Please try again.
12	Power Pack has been depleted
13	Power Pack is Too Cold to Charge
14	Power Pack is Too Hot to Charge
15	Charging Delayed or Paused by Charge Station
16	Scheduled Charging based on time set by user.
17	Entered Diagnostic State
18	Exited Diagnostic State
19	Charging paused. Refer to Owner's Manual
20	High Throttle Fault. Refer to Owner's Manual
21	Performance will be reduced and Charging may be disabled.
22	Motorcycle Tipped Over. Key-cycle to reactivate Throttle.
23	Motorcycle in Limp Mode.
24	Bulk charge complete
25	EVSE not compatible

Dash Error Codes

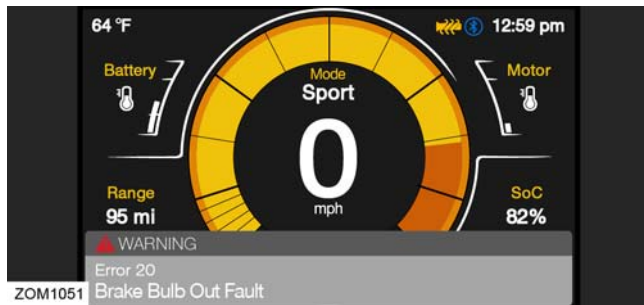

If an error occurs, the error message will briefly appear at the bottom of the riding screen.



If an error code has been recorded, it can be retrieved from the dash display. See [“Errors”, on page 3.57](#).

To clear an error code, see [“To Clear an Error Code”, on page 3.58](#).

Refer to the following table to identify the error associated with the Error Code number and any action required to clear the error.

Note: Some errors will cause the Check Engine Light (CEL) on the dash to illuminate and simultaneously cause the motorcycle to go into a permanent state of torque reduction. Those error codes are identified in the following error code table.

Troubleshooting

Code	CEL *	Fault	Fault Description
1		High Throttle Fault	Throttle Fault.
2	⊗	Torque Fault	Torque Fault, No valid torque input provided from MSC.
3	⊗	Torque Fault	Torque Fault.
4	⊗	Throttle Fault	Throttle Fault.
5	⊗	CAN Fault	Powertrain CAN Communication Fault.
6	⊗	Mode Fault	Reinstall Ride Modes through Smartphone App.
7	⊗	Mode Fault	Reinstall Ride Modes through Smartphone App.
8		Firmware Update Failure	Firmware update failed. Please try again later.
9	⊗	Controller Fault	Motor Controller Fault.
10		Firmware Update Failure	Firmware update failed, insufficient cellular signal. Please try again later.
11		Right Turn Signal Short Fault	Right Turn Signal Connection Short.
12		Traction Control Fault	Traction Control Fault.
13		Traction Control Fault	Traction Control Fault, Communication error.
14		Right Turn Signal Bulb Out Fault	Right Turn Signal Connection Open.
15		Stability Control Fault	Stability Control Fault.
16		Headlight Short Fault	Headlight Connection Short.
17		Headlight Bulb Out Fault	Headlight Connection Open.
20		Brake Bulb Short Fault	Brake Light Connection Short.
21		Brake Bulb Out Fault	Brake Light Connection Open.
22		12V Battery Heater Short Fault	12V Battery Heater Connection Short.
23		12V Battery Heater Disconnect Fault	12V Battery Heater Connection Open.
24		12V Battery Reversed	12V battery installed in reverse.
25		12V Battery Low	12V battery low.
26		DC-DC Low	DC-DC converter voltage low.
27		12V Low Voltage Fault	12V system fault.

Code	CEL *	Fault	Fault Description
28	⊗	12V Low Voltage Fault	12V system fault.
29		HVIL Open Fault	Loose connection detected in power pack harness.
30		Self test Fail	Disconnect charger. Key Off for 2 minutes and then try again.
31		Battery Module Ineligible	Disconnect charger. Key Off for 2 minutes and then try again.
32		Contactors Open	Disconnect charger. Key Off for 2 minutes and then try again.
33		Battery Module Awaiting Connection	Disconnect charger. Key Off for 2 minutes and then try again.
34		Battery Module Connection Retries Fault	Disconnect charger. Key Off for 2 minutes and then try again.
35		Pilot Signal Invalid Fault	Charging station error. Disconnect Charging Pistol, wait for 2 minutes then retry.
36		Region Invalid Fault	Charger region uninitialized.
37		Charger Not Connected	CAN Communication Fault.
38		Charger Fault	Disconnect Charging Pistol, wait for 2 minutes then retry.
39		Immobilizer Disconnected	CAN Communication Fault.
40		Immobilizer Fault	Try Reprogramming Keys.
41		Motor High Temperature	Performance will be reduced.
42		Heated Grip Fault	Heated Grip Fault.
43	⊗	Isolation Fault	Refer to dealer.
44		Memory Fault	Key Off for 2 minutes and then try again.
45		Memory Fault	Key Off for 2 minutes and then try again.
46		Memory Fault	Key Off for 2 minutes and then try again.
47		Memory Fault	Key Off for 2 minutes and then try again.
48		Memory Fault	Key Off for 2 minutes and then try again.
49		Battery Module Incompatible	Battery installed is not compatible with this motorcycle.
50		Battery Module Features Not Supported	Module installed is either newer or older than this motorcycle. Some features may not be available.
51		Battery Pack Voltage Too High	Charging paused.

Troubleshooting

Code	CEL *	Fault	Fault Description
52		Battery pack Voltage Too Low	Refer to dealer.
53		Battery Voltage Low	Please charge motorcycle.
54	⊗	Battery Cell Anomaly	Please charge motorcycle.
55		Battery Temperature High	Performance will be reduced and Charging may be disabled.
56		Battery Temperature Low	Performance will be reduced and Charging may be disabled.
57		Controller High Temperature	Performance will be reduced.
58		Battery Fault	Key off for 5 minutes and then try again.
59		Heated Grip Fault	Heated grips disconnected.
60		CCS Converter Fault	CCS DC-DC converter not connected or not functioning.
61		CCS Interface Fault	CCS interface unit not connected or not functioning properly.
62		CCS Communication Fault	CCS communication fault with charging station.
63		Left Turn Signal Short Fault	Left Turn Signal Connection Short.
64		Left Turn Signal Bulb Out Fault	Left Turn Signal Connection Open.
65 - 99		Motorcycle Fault	Refer to dealer.

*The motorcycle's diagnostic system detected an error code that has caused the motorcycle to enter into a state of permanent torque reduction. The Check Engine Light (CEL) on the dash will also illuminate when any of these errors is detected.

Cold and Hot Weather Considerations

Cold Weather

Cold weather operation of the motorcycle has no permanent impact on its power pack/cells; however, the rider may see a reduction in range due to the effect cold temperature has on the amount of energy the pack/cells can release. The colder the weather, the greater the effect; so that, as compared to operation in 80°F (27°C) ambient, at 30°F (-1°C) ambient, the rider could experience a temporary reduction in range of up to 30%.

In extreme cold weather the motorcycle may also experience a temporary reduction in power and, correspondingly, achieved top speed.

It is not recommended that the motorcycle be ridden while its power pack temperature is below 23°F (-5°C). If it is, its power pack needs to be put on the charger at a temperature above 32°F (0°C) as soon as the ride is concluded. It is worth noting that the Battery Management System (BMS) will not allow the power pack to be discharged below -22°F (-30°C), which is the absolute lowest discharge temperature prescribed by the cell manufacturer.

Storage of the motorcycle for the winter in a non-heated garage is acceptable, as long as:

1. the coldest temperature in the garage does not fall below -31°F (-35°C).

2. the power pack is left on the charger continuously.
3. the power pack is initially topped off at a temperature above 32°F (0°C).

Storage temperatures below -31°F (-35°C) may result in accelerated permanent decay of the power pack performance, and hence it is not recommended. Above this temperature and following the long-term storage guidelines (see [“Parking and Long Term Storage”](#), on page 6.38) will ensure the power pack survives winter storage with no permanent damage, even if the temperatures dip well below freezing for weeks at a time.

Note: When charging, to prevent power pack damage, the BMS will prevent the charger from charging the power pack at a temperature below 32°F (0°C). As long as the motorcycle remains connected to an AC power supply through the winter at temperatures above -31°F (-35°C), the power pack will be safe from damage.

The 12 volt battery is equipped with a heater to warm it when current (or recent) temperatures have been recorded below 41°F (5°C).

Note: During this warming, the motorcycle will be temporarily disabled for 1-15 minutes until the power pack's temperature is determined to be above 32°F (0°C)

Hot Weather Operation

Operation of the motorcycle in hot temperatures should not result in any noticeable performance changes. However, the BMS will not allow motorcycle operation and its associated power pack discharge above 140°F (60°C), as measured at the power pack.

In hot temperatures greater than 110°F (43°C), the charger reduces its charge current to the power pack, increasing charge time accordingly; the hotter the ambient temperature, the greater the effect. Above a power pack temperature of 122°F (50°C), the BMS will no longer allow charging.

Note: Storing the motorcycle or its power pack in direct sunlight in ambient temperatures above 105°F (41°C) may result in accelerated permanent decay of power pack performance, and hence it is not recommended.

Safety Interlocks

If the BMS detects a serious internal fault, it can take either or both of two actions to prevent damage to the power pack:

- **Throttle Disable.** The BMS disables the throttle if the power pack is empty, or if the BMS detects certain serious internal problems. You cannot ride the motorcycle until the problem is resolved.
- **Charger Disable.** The BMS prevents charging if it detects certain serious internal problems - even if the power pack is connected to a charger and plugged in to AC power. The power pack cannot be charged until the problem is resolved.

Throttle Disable Interlock

The BMS communicates with the main motorcycle control module. The BMS can send a signal to the main motorcycle controller requesting that the throttle control on the motorcycle be disabled. When the throttle control is disabled, the motor will not deliver power to the rear wheel, and the motorcycle cannot be ridden.

If the throttle is disabled while riding, the motorcycle will cease to provide power, and the operator must pull over to a safe location.

Charger-Disable Interlock

When the charger is attached and plugged in to AC power, the BMS communicates with the charger. The BMS can send a signal to the charger requesting that charging terminates immediately. When the charger is disabled, the indicator lights on the charger displays that charging has stopped.

There are two conditions that cause the BMS to disable charging:

1. Too hot
The BMS detects an internal power pack temperature above 122°F (50°C).
2. Too cold
The BMS detects an internal power pack temperature below 32°F (0°C).

A series of horizontal dashed lines for writing notes.

VIN Breakdown

The following breakdown of the VIN will help you understand the significance of each digit or character in case you need to reference it when contacting Zero Motorcycles or ordering parts.

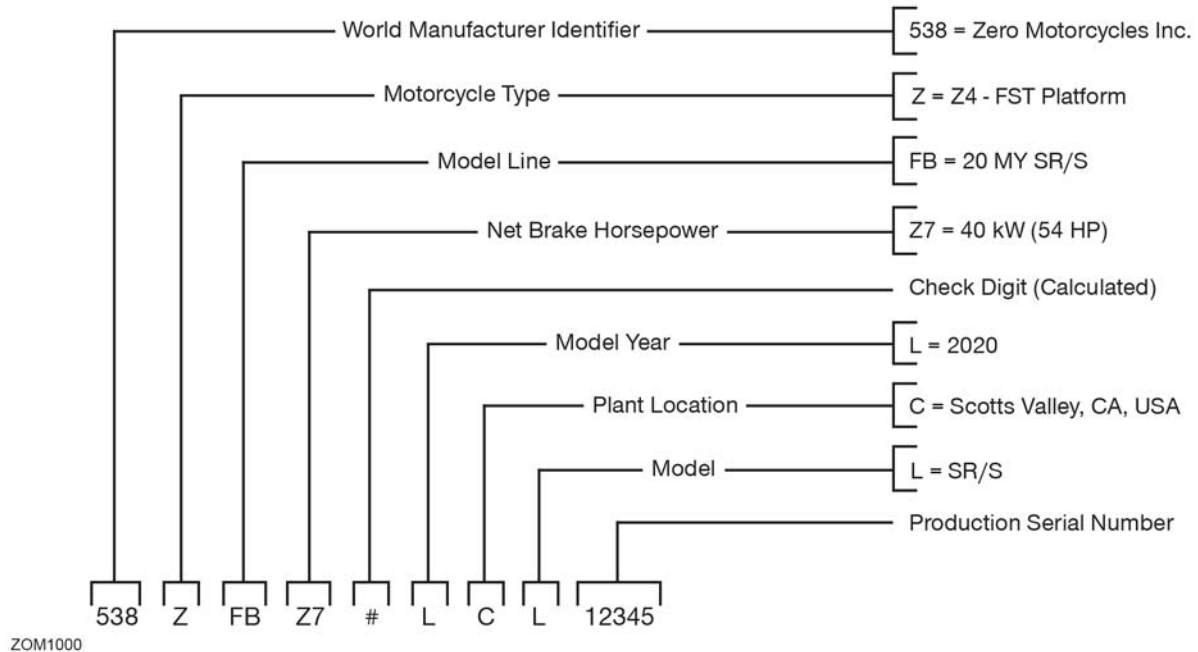

Zero SR/S (Europe)

MOTOR	
Type	Z-Force® 75-10 enhanced thermal efficiency, passively air-cooled, interior permanent magnet AC motor
Controller	High efficiency and power dense, 900 amp, 3-phase AC controller with regenerative deceleration
Estimated Top Speed (max)	200 km/h
Estimated Top Speed (sustained)	177 km/h
Peak Motor Torque	190 Nm
Peak Motor Power	82 kW
Maximum Continuous-rated 30 Minutes Power (According to UNECE Regulation No. 85)	40 kW

DRIVETRAIN	
Transmission	Clutchless Direct Drive
Final Drive	Poly Chain® HTD® Carbon™ belt
Wheel Sprocket - Number of teeth	90
Motor Sprocket - Number of teeth	20

SUSPENSION/BRAKES/WHEELS	
Front Suspension	Showa 43 mm big piston, separate function forks with adjustable spring preload, compression, and rebound damping
Rear Suspension	Showa 40 mm piston, piggy-back reservoir shock with adjustable spring preload, compression, and rebound damping
Front Suspension Travel	120 mm
Rear Suspension Travel	140 mm
Front Brakes	Bosch Advanced MSC, Dual J-Juan radial-mounted 4-piston calipers, 320 x 5 mm disc
Rear Brakes	Bosch Advanced MSC, J-Juan single piston floating caliper, 240 x 4.5 mm disc
Front Wheel	3.50 x17
Rear Wheel	5.50 x17

TIRES		
Zero Motorcycles Factory installed tires	Front Tire	Pirelli Diablo Rosso III 120/70-17
	Rear Tire	Pirelli Diablo Rosso III 180/55-17
Zero Motorcycles Approved alternative tires	Front Tire	Pirelli Angel GT 120/70 ZR17 M/C (58W) TL
		Michelin Road 5 120/70 ZR17 M/C (58W) TL
	Rear Tire	Pirelli Angel GT 180/55 ZR17 M/C (73W) TL
		Michelin Road 5 180/55 ZR17 M/C (73W) TL
WARNING: Only install tires of the same manufacturer and type on both wheels. Mixing tires may cause adverse handling and performance problems, and prevent the correct operation of the ABS and MTC.		

POWER SYSTEM		
	Standard SR/S	Premium SR/S
Type	Z-Force® Li-Ion Intelligent Power Pack	Z-Force® Li-Ion Intelligent Power Pack
Maximum Capacity	14.4 kWh	14.4 kWh
Nominal Capacity	12.6 kWh	12.6 kWh
Charger Type	3 kW Integrated	6 kW Integrated
Input	Universal 100 - 240 V AC	Universal 100 - 240 V AC
Estimated Power Pack Life to 80% (city)	349,000 km	349,000 km

CHARGING TIME			
Input Voltage	Charging Level*	Standard SR/S	Premium SR/S
230V	Mode 2	4.5 hours (100% charged) / 4.0 hours (95% charged)	4.5 hours (100% charged) / 4.0 hours (95% charged)
	Mode 3 (single phase)	4.5 hours (100% charged) / 4.0 hours (95% charged)	4.5 hours (100% charged) / 4.0 hours (95% charged)
	Mode 3 (3-phase)**	4.5 hours (100% charged) / 4.0 hours (95% charged)	2.5 hours (100% charged) / 2.0 hours (95% charged)
* See “Charging Levels (Times)” , on page 5.5 for more information.			
** Premium SR/S 3 kW charger utilizes power supplied from pin specific to a 3-phase charging point.			

RANGE	
According to EU 134/2014 Annex VII	158 km

ECONOMY

Equivalent Fuel Economy (city)	0.55 L/100 km
Equivalent Fuel Economy (highway)	1.08 L/100 km

DIMENSIONS

Wheel Base	1,450 mm
Seat Height	787 mm
Rake	24.5 degrees
Trail	94 mm

WEIGHTS

	Standard SR/S	Premium SR/S
Curb Weight	220 kg	226 kg
Carrying capacity	234 kg	228 kg

Zero SR/S (Rest Of The World)

MOTOR	
Type	Z-Force® 75-10 enhanced thermal efficiency, passively air-cooled, interior permanent magnet AC motor
Controller	High efficiency and power dense, 900 amp, 3-phase AC controller with regenerative deceleration
Estimated Top Speed (max)	124 mph (200 km/h)
Estimated Top Speed (sustained)	110 mph (177 km/h)
Peak Motor Torque	140 lb-ft (190 Nm)
Peak Motor Power	110 hp (82 kW)

DRIVETRAIN	
Transmission	Clutchless Direct Drive
Final Drive	Poly Chain® HTD® Carbon™ belt
Wheel Sprocket - Number of teeth	90
Motor Sprocket - Number of teeth	20

SUSPENSION/BRAKES/WHEELS	
Front Suspension	Showa 43 mm big piston, separate function forks with adjustable spring preload, compression, and rebound damping
Rear Suspension	Showa 40 mm piston, piggy-back reservoir shock with adjustable spring preload, compression, and rebound damping
Front Suspension Travel	4.72 in (120 mm)
Rear Suspension Travel	5.51 in (140 mm)
Front Brakes	Bosch Advanced MSC, Dual J-Juan radial-mounted 4-piston calipers, 320 x 5 mm disc
Rear Brakes	Bosch Advanced MSC, J-Juan single piston floating caliper, 240 x 4.5 mm disc
Front Wheel	3.50 x17
Rear Wheel	5.50 x17

TIRES		
Zero Motorcycles Factory installed tires	Front Tire	Pirelli Diablo Rosso III 120/70-17
	Rear Tire	Pirelli Diablo Rosso III 180/55-17
Zero Motorcycles Approved alternative tires	Front Tire	Pirelli Angel GT 120/70 ZR17 M/C (58W) TL
		Michelin Road 5 120/70 ZR17 M/C (58W) TL
	Rear Tire	Pirelli Angel GT 180/55 ZR17 M/C (73W) TL
		Michelin Road 5 180/55 ZR17 M/C (73W) TL
WARNING: Only install tires of the same manufacturer and type on both wheels. Mixing tires may cause adverse handling and performance problems, and prevent the correct operation of the ABS and MTC.		

POWER SYSTEM		
	Standard SR/S	Premium SR/S
Type	Z-Force® Li-Ion Intelligent Power Pack	Z-Force® Li-Ion Intelligent Power Pack
Maximum Capacity	14.4 kWh	14.4 kWh
Nominal Capacity	12.6 kWh	12.6 kWh
Charger Type	3 kW Integrated	6 kW Integrated
Input	Universal 100 - 240 V AC	Universal 100 - 240 V AC
Estimated Power Pack Life to 80% (city)	217,000 miles (349,000 km)	217,000 miles (349,000 km)

CHARGING TIME			
Input Voltage	Charging Level*	Standard SR/S	Premium SR/S
110V - 120V	Level 1	8.5 hours (100% charged) / 8.0 hours (95% charged)	8.5 hours (100% charged) / 8.0 hours (95% charged)
208V - 240V	Level 2	4.5 hours (100% charged) / 4.0 hours (95% charged)	2.5 hours (100% charged) / 2.0 hours (95% charged)
* See “Charging Levels (Times)” , on page 5.5 for more information.			

RANGE	
City (EPA UDDS)	161 miles (259 km)
Highway, 55 mph (89 km/h)	99 miles (159 km)
- Combined (City + 55 mph)	123 miles (198 km)
Highway, 70 mph (113 km/h)*	82 miles (132 km)
- Combined (City + 70 mph)	109 miles (175 km)
*When "Highway" is referenced elsewhere in this manual for range, consider calculated highway speed as 70 mph (113 km/h).	

ECONOMY	
Equivalent Fuel Economy (city)	430 MPGe (0.55 L/100 km)
Equivalent Fuel Economy (highway)	219 MPGe (1.08 L/100 km)

DIMENSIONS	
Wheel Base	57.1 in (1,450 mm)
Seat Height	31.0 in (787 mm)
Rake	24.5 degrees
Trail	3.7 in (94 mm)

WEIGHTS		
	Standard SR/S	Premium SR/S
Curb Weight	485 lb (220 kg)	498 lb (226 kg)
Carrying capacity	515 lb (234 kg)	502 lb (228 kg)

A series of horizontal dashed lines for writing notes.

Who Is The Warrantor?

Zero Motorcycles Inc. (“Zero”).

Who Does This Limited Warranty Cover?

This Limited Warranty applies to all original owners and any subsequent owners of covered North American model 2020 Zero SR/S motorcycles (“2020 Zero Motorcycle” or “2020 Zero Motorcycles”). It is provided at no additional cost during the applicable warranty coverage period.

Zero requires its authorized dealers to submit warranty registration information on-line or a warranty registration card via mail at the time of purchase to ensure timely service. When a covered 2020 Zero Motorcycle is sold to a subsequent owner, the original owner should submit a warranty transfer request either electronically or in writing. This must be performed to allow Zero the ability to contact the new owner in the unlikely event of a safety related issue. See [“How Do I Transfer Ownership And The Limited Warranty?”](#), on page 9.8.

What Does This Limited Warranty Cover?

Zero warrants that all factory manufactured 2020 Zero Motorcycles are free from defects in material and workmanship during the period of this Limited Warranty.

This Limited Warranty covers parts, including the motor, motor controller, frame, swing arm, fork, rear shock, brake assemblies, wheels and electrical sub-assemblies, and approved Zero accessories installed at the time of purchase by an authorized Zero dealer.

This Limited Warranty also covers the following items, collectively referred to as “Power Packs”:

- The Z-Force® ZF14.4 Power Packs installed on the 2020 Zero SR/S motorcycle.
- The Z-Force® Power Tank accessory that may be mounted in a Zero SR/S model motorcycle. Should the Z-Force® Power Tank be purchased after the initial “in-service date” of the 2020 Zero Motorcycle, the Z-Force® Power Tank’s warranty duration will match the remaining Power Pack warranty from the 2020 Zero Motorcycle.

This Limited Warranty covers all components of the Power Packs including the battery, integrated battery management system, internal wiring, and internal structures.

What Is The Coverage Period Of This Limited Warranty?

The duration of this Limited Warranty depends upon whether your 2020 Zero Motorcycle is a demonstrator or a non-demonstrator.

Demonstrators are 2020 Zero Motorcycles that have been driven by or used by Zero's or an authorized dealership's customers or prospective customers, staff, managers or executives, or members of the press, but have never been registered within the state, province or country.

Non-demonstrators are those 2020 Zero Motorcycles that are not demonstrators.

A. WHAT IS THE COVERAGE PERIOD FOR NON-DEMONSTRATORS?

The duration of this Limited Warranty for non-demonstrator 2020 Zero Motorcycles, not including the Power Packs, is a period of two (2) years from the original "in-service date."

Note: The "in-service date" is the earlier of either (a) the date that the authorized dealer performs a pre-delivery inspection ("PDI") and delivers the motorcycle to the customer; in the event these events occur on different dates, the later date shall be the "in-service date" or (b) the date three (3) years from the date that Zero ships the motorcycle to the authorized dealer.

The duration of this Limited Warranty for the Power Packs (not including the Power Pack's outer case) is:

- Five (5) years from the "in-service date" for the Z-Force® ZF14.4 Power Packs on the 2020 Zero SR/S Motorcycle.
- Five (5) years from the "in-service date" of the host 2020 Zero SR/S Motorcycle for the Z-Force® Power Tank accessory. If purchased after the host Power Pack warranty has expired, the Power Tank will receive the standard parts warranty of one (1) year from date of purchase.

The Power Pack's outer case is not covered under the Power Pack Limited Warranty duration terms above. Instead, the Power Pack's outer case is covered for a period of two (2) years from its "in-service date."

B. WHAT IS THE COVERAGE PERIOD FOR DEMONSTRATORS?

The duration of this Limited Warranty for demonstrator 2020 Zero Motorcycles, not including the Power Packs, is a period of two (2) years and 90 days from the original “shipment date.”

Note: The “shipment date” is the date that Zero ships the demonstrator 2020 Zero Motorcycle to the authorized dealer.

The duration of this Limited Warranty for the Power Packs (not including the Power Pack’s outer case) is:

- Five (5) years and 90 days from the “shipment date” for the Z-Force® ZF14.4 Power Packs on the 2020 Zero SR/S Motorcycle.
- Five (5) years and 90 days from the “shipment date” of the host 2020 Zero SR/S Motorcycle for the Z-Force® Power Tank accessory. If purchased after the host Power Pack warranty has expired, the Power Tank will receive the standard parts warranty of one (1) year from date of purchase.

The Power Pack’s outer case is not covered under the Power Pack Limited Warranty duration terms above. Instead, the Power Pack’s outer case is covered for a period of two (2) years and 90 days from its “shipment date.”

What Is Not Covered By This Limited Warranty?

Due to the battery chemistry, there is a normal, expected reduction in range/capacity that Power Packs can yield over time and usage. Depending on use and storage conditions, Power Packs will degrade during the duration of this Limited Warranty period. Zero will only repair or replace pursuant to this Limited Warranty a Power Pack that exhibits a nominal storage capacity reduction of greater than 20% of the published nominal capacity, as measured by an authorized Zero dealer. To check the capacity of a Power Pack, an authorized Zero dealer can perform a battery management system log data extraction, which will confirm if a reduction is within expected norms.

Further, this Limited Warranty only covers 2020 Zero Motorcycles or Power Packs/Power Tanks that are operated according to “proper use” and “under normal operating conditions.” For purposes of this exclusion, the following definitions apply:

- “Normal operating conditions” require routine care and maintenance of the 2020 Zero Motorcycle and Power Packs as described in the Owner’s Manual.
- “Normal operating conditions” does not include use of the 2020 Zero Motorcycle in for-profit commercial or business activities, such as use as a rental vehicle.
- “Proper use” means only the use of a motorcycle in the manner intended for a rider and passenger on a 2020 Zero

Limited Warranty Information

Motorcycle with proper safety equipment as described in the Owner's Manual, in accordance with local regulations.

- "Proper use" also means never storing and/or leaving the Power Pack at a state of charge below 30% for more than 30 days.

In addition, this Limited Warranty does not cover:

- The cost of parts and labor involved in any routine care and maintenance and/or the replacement of parts due to normal wear and tear, use, or deterioration, including but not limited to: tires, brake pads and rotors, belt drive, fork seals, grips, foot pegs, and the seat;
- The tires installed on the 2020 Zero Motorcycle. The original equipment tires are warranted separately by the tire manufacturer;
- The replacement of fluids, unless their replacement is a necessary part of warranty service on a covered component;
- Wheel damage resulting from off road use;
- Any cosmetic concerns that arise as a result of environmental conditions, owner abuse, misuse, lack of routine care and maintenance, and/or improper use;
- Parts or components damaged by use or operation under abnormal circumstances or contrary to the requirements described in the Owner's Manual including a failure to have the motorcycles firmware updated during the regular service intervals or in a timely basis following a notification that a new update is available.

- 2020 Zero Motorcycles and Power Packs used for racing or other competitive events;
- 2020 Zero Motorcycles and Power Packs misused or improperly operated;
- Damage, malfunctions, or performance problems caused by modifications or alterations to 2020 Zero Motorcycles and/or Power Packs - including modifications or alterations performed by an authorized Zero dealer - that cause the 2020 Zero Motorcycle or Power Pack to fail;
- Damage, malfunctions, or performance problems caused by after-market accessories installed on a 2020 Zero Motorcycle or Power Pack after the "in-service date," or caused by after-market accessories installed by someone other than an authorized Zero dealer;
- Damage, malfunctions, or performance problems caused by the improper repair of the motorcycle, installation of any parts or accessories not sold or approved by Zero, the installation and use of any parties or accessories that alter the motorcycle's specifications from those set by Zero, or the use of new or used parts not approved by Zero;
- Damage, malfunctions, or performance problems caused by the installation or use of any charger not sold or approved by Zero;
- Damage, malfunctions, or performance problems caused by fire, collision, accident, or improper storage;

- Damage, malfunctions, or performance problems caused by continued operation of the motorcycle after a warning light, gauge reading, or other warning indicates a mechanical or operational problem;
- 2020 Zero Motorcycles severely damaged or declared to be a total loss by an insurer, or motorcycles substantially reassembled from or repaired with parts obtained from another used motorcycle;
- Damage, malfunctions, or performance problems caused by the failure to follow recommended maintenance requirements as set forth in the Owner's Manual; and
- Damage, malfunctions, or performance problems caused by airborne industrial pollutants (e.g., acid rain), bird droppings, tree sap, stones, flood water, windstorms, or other similar occurrences.

Further, this Limited Warranty does not apply to 2020 Zero Motorcycles or parts and accessories that are not imported or distributed by Zero.

What Other Limitations Or Disclaimers Apply To This Limited Warranty?

The following additional limitations and disclaimers apply to this Limited Warranty:

- THIS LIMITED WARRANTY IS THE ONLY EXPRESS WARRANTY MADE IN CONNECTION WITH THE SALE OF THIS ZERO MOTORCYCLE MODEL. ANY IMPLIED WARRANTY, INCLUDING ANY WARRANTY OF MERCHANTABILITY OR WARRANTY OF FITNESS FOR A PARTICULAR PURPOSE IS LIMITED IN DURATION TO THE STATED PERIOD OF THIS WRITTEN WARRANTY. Some States do not allow limitations on how long an implied warranty lasts, so the above limitation may not apply to you.
- Zero does not assume – or authorize any person to assume – any other obligation or liability on its behalf.
- THIS LIMITED WARRANTY DOES NOT COVER ANY INCIDENTAL OR CONSEQUENTIAL DAMAGES, INCLUDING LOSS OF VALUE OF THE MOTORCYCLE, LOST PROFITS OR EARNINGS, OUT-OF-POCKET EXPENSES FOR SUBSTITUTE TRANSPORTATION OR LODGING, EXPENSES ASSOCIATED WITH RETURNING THE COVERED PRODUCT TO AN AUTHORIZED SERVICE FACILITY OR DEALER, TOWING AND/OR ROADSIDE ASSISTANCE EXPENSES, EXPENSES ASSOCIATED WITH RETURNING THE COVERED PRODUCT BACK TO ITS OWNER, MECHANIC'S TRAVEL TIME OR COMMUNICATION CHARGES, LOSS OR DAMAGE TO

PERSONAL PROPERTY, LOSS OR TIME, OR INCONVENIENCE. Some States do not allow the exclusion or limitation of incidental or consequential damages, so the above limitation or exclusion may not apply to you.

- Zero reserves the right to change or improve the design of any 2020 Zero Motorcycle, Power Pack, or any other Zero parts (collectively, “Zero products”) at any time, without assuming any obligation to modify any Zero products previously manufactured or sold.
- The purchaser acknowledges that there is an inherent risk in the operation of motorcycles. This Limited Warranty does not cover - and Zero cannot assume responsibility for - any injury arising from the unsafe or improper operation of Zero products, or the user’s failure to comply with instructions, care and maintenance requirements, warnings, and safety precautions.
- The original registered owner or subsequent registered transferee as documented on the Zero motorcycle warranty registration form is responsible for conveying the Owner’s Manual and all safety warnings, instructions, and Limited Warranty if the unit is sold, loaned, or otherwise transferred to another person.

What Are Your Responsibilities As A Customer?

As the owner of a product covered by this Limited Warranty, it is your responsibility to read and understand the Owner’s Manual, this Limited Warranty, and all product warnings before operating your 2020 Zero Motorcycle. Serious injury or death can result from improper operation or failure to observe warnings and safety instructions on any motorcycle.

Further, it is also your responsibility to:

- Perform all recommended and necessary routine care and maintenance and engage in proper use of your 2020 Zero Motorcycle and Power Pack as detailed in the Owner’s Manual, including obtaining any firmware updates available at each service interval or in a timely basis following a notification that a new update is available.
- Learn and obey all federal, state, and local laws governing the operations of a motorcycle, generally, and an electric motorcycle, specifically.
- At all times when operating a 2020 Zero Motorcycle wear proper safety equipment and clothing, including but not limited to helmet, eye protection, and appropriate boots.
- Convey the Owner’s Manual and all safety warnings, instructions, and Limited Warranty if the unit is sold, loaned, or otherwise transferred to another person.

What Will Zero Do Under This Limited Warranty?

During the duration of this Limited Warranty, an authorized Zero dealer will repair or replace (at Zero's discretion), without charge, any 2020 Zero Motorcycle, Power Pack, or parts that are covered by this Limited Warranty and found by Zero or an authorized Zero dealer to be defective in factory materials or workmanship.

How Does This Limited Warranty Relate To State Law?

Notice Under State Lemon Laws

Some States have laws, sometimes referred to as "lemon laws," allowing you to get a replacement motorcycle or a refund of the purchase price under certain circumstances. These laws vary from State to State. If your state law allows, Zero requires that you first notify us in writing of any service difficulty or issue that you may have experienced so that we can have a chance to make any needed repairs before you are eligible for remedies provided by these laws. In all other States, Zero asks that you give it written notice of any service difficulty or issue.

Please send your written notification to Zero at the following address:

Zero Motorcycles Inc.
Attn: Customer Service
380 El Pueblo Road
Scotts Valley, CA 95066
USA

How Do You Obtain Service Under This Limited Warranty?

Warranty services may be obtained by contacting your local Zero Motorcycles dealer. Please refer to the dealer locator on our website (www.zeromotorcycles.com/locator) for your nearest location.

In the event that a dealer is not in your state, province, or country, you can contact Zero Motorcycles Inc. directly at **+1 (888) 786-9376** (Americas, Asia and Oceania) or **+31 (0) 72 5112014** (UK, Europe, Middle East and Africa) or via e-mail at support@zeromotorcycles.com.

In any written or telephonic communication, please state the specific nature of any circumstances leading to the problem and include the VIN and odometer reading.

Zero Motorcycles Inc.
380 El Pueblo Road
Scotts Valley, CA 95066
USA

Zero Motorcycles B.V.
Oester 12
1723 HW Noord-Scharwoude
The Netherlands

(U.S. and International Patents and Trademarks Pending)

How Do I Transfer Ownership And The Limited Warranty?

If you sell your 2020 Zero Motorcycle, please visit the Zero website and access the owner resources section to fill out the transfer of ownership and warranty form. This must be performed to allow Zero the ability to contact the new owner in the unlikely event of a safety related issue. Use the email address below or feel free to contact the Zero Customer Service department for assistance.

- *North America*
Zero Motorcycles Inc.
Phone: **+1 (888) 786-9376**
Monday-Friday 8am to 5pm (Pacific Time)
E-mail: support@zeromotorcycles.com
- *Zero Motorcycles Europe*
Zero Motorcycles B.V.
Phone: **+31 (0) 72 5112014**
E-mail: service.eu@zeromotorcycles.com

For updates and additional information about your motorcycle, visit the owner resources section of Zero Motorcycles website: <http://www.zeromotorcycles.com/owner-resources/>

Customer Assistance

Please have the following available when contacting Zero Motorcycles Inc. as they are essential to effectively and efficiently answer your questions or resolve your concerns.

- Owner's name and address
- Owner's telephone number
- Vehicle identification number (VIN)
- Date of purchase
- Motor serial number (if visible)

Note: An motorcycle information chart is provided on the inside of the front cover to record this information.

Zero Motorcycles Inc. can be contacted as follows:

Zero Motorcycles Inc.
380 El Pueblo Road
Scotts Valley, CA 95066
USA

Phone: **+1 (888) 786-9376**

Monday-Friday 8am to 5pm (Pacific Time)

E-mail: support@zeromotorcycles.com (24 hours)

For updates and additional information about your motorcycle, visit the owner resources section of the Zero website:

www.zeromotorcycles.com/owner-resources/

Reporting Safety Defects

United States

If you believe that your vehicle has a defect which could cause a crash or could cause injury or death, you should immediately inform the National Highway Traffic Safety Administration (NHTSA) in addition to notifying Zero Motorcycles Inc.

If NHTSA receives similar complaints, it may open an investigation, and if it finds that a safety defect exists in a group of vehicles, it may order a recall and remedy campaign. However, NHTSA cannot become involved in individual problems between you, your dealer, or Zero Motorcycles Inc.

To contact NHTSA, you may call the Vehicle Safety Hotline toll-free at:

1-888-327-4236 (TTY: 1-800-424-9153); go to <http://www.safercar.gov>; or write to:

Administrator
National Highway Traffic Safety
1200 New Jersey Avenue SE
Washington, DC 20590

You can also obtain other information about motor vehicle safety from:

<http://www.safercar.gov>

Canada

If you believe that your vehicle has a defect which could cause a crash or could cause injury or death, you should immediately inform Transport Canada, in addition to notifying Zero Motorcycles Inc.

To contact Transport Canada, call their toll-free number:
+1-800-333-0510

United Kingdom, Europe, and Global Markets

If you believe that your vehicle has a defect which could cause a crash or could cause injury or death, you should immediately inform your Zero Motorcycles authorized dealer. If you are unable to resolve the issue with your Zero Motorcycles authorized dealer you can contact Zero Motorcycles Inc. directly on +1-888-786-9376, or through our website at:

<http://www.zeromotorcycles.com>

Service History

After you have had your Zero Motorcycle serviced, please make sure that the appropriate maintenance record has been completed.

Use the space under “Notes” to record issues you want to remind yourself about or mention at the next service.

600 miles (1000 km) or 1 month	
Odometer reading:	Date:
Notes:	
Performed by:	

4,000 miles (7,000 km) or 6 months	
Odometer reading:	Date:
Notes:	
Performed by:	

8,000 miles (13,000 km) or 12 months	
Odometer reading:	Date:
Notes:	
Performed by:	

12,000 miles (19,000 km) or 18 months	
Odometer reading:	Date:
Notes:	
Performed by:	

16,000 miles (25,000 km) or 24 months	
Odometer reading:	Date:
Notes:	
Performed by:	

Maintenance Record

20,000 miles (31,000 km) or 30 months

Odometer reading:

Date:

Notes:

Performed by:

24,000 miles (37,000 km) or 36 months

Odometer reading:

Date:

Notes:

Performed by:

28,000 miles (43,000 km)

Odometer reading:

Date:

Notes:

Performed by:

32,000 miles (49,000km)

Odometer reading:

Date:

Notes:

Performed by:

36,000 miles (55,000 km)

Odometer reading:

Date:

Notes:

Performed by:

40,000 miles (61,000 km)

Odometer reading:

Date:

Notes:

Performed by:

44,000 miles (67,000 km)	
Odometer reading:	Date:
Notes:	
Performed by:	

48,000 miles (73,000 km)	
Odometer reading:	Date:
Notes:	
Performed by:	

52,000 miles (79,000 km)	
Odometer reading:	Date:
Notes:	
Performed by:	

56,000 miles (85,000 km)	
Odometer reading:	Date:
Notes:	
Performed by:	

60,000 miles (91,000 km)	
Odometer reading:	Date:
Notes:	
Performed by:	

64,000 miles (97,000 km)	
Odometer reading:	Date:
Notes:	
Performed by:	

Maintenance Record

68,000 miles (103,000 km)

Odometer reading:

Date:

Notes:

Performed by:

72,000 miles (109,000 km)

Odometer reading:

Date:

Notes:

Performed by:

76,000 miles (115,000 km)

Odometer reading:

Date:

Notes:

Performed by:

80,000 miles (121,000 km)

Odometer reading:

Date:

Notes:

Performed by:

84,000 miles (127,000 km)

Odometer reading:

Date:

Notes:

Performed by:

88,000 miles (133,000 km)

Odometer reading:

Date:

Notes:

Performed by:

A

ABS

Disabling	4.17
Warning Indicator	4.18
Accessories	1.4
Accessory Connectors (12 volt)	6.33

B

Battery	6.31
12 Volt	6.31
High voltage	5.1
Bluetooth	3.20, 3.36
Bluetooth® Pairing	4.3
Bluetooth® Unpairing	4.5
Brake Pad Replacement	6.13
Brake/Tail Light Bulb Replacement	6.30
Brakes	6.10
Anti-lock Braking System (ABS)	4.16
Brake Fluid Type - DOT 4	6.11
Brake Pad Inspection	6.12
Braking	4.9
Front Brake.....	6.11
Front Brake Lever Adjuster	3.18
Rear Brake.....	6.11

C

Charger	
3 kW	5.2
6 kW	5.2
Charging the Power Pack.....	5.3
Charge Target.....	3.50
Delay/Scheduled	3.49
Cleaning Your Motorcycle.....	6.37
Connectivity	3.36
Contact information	
NHTSA	9.10
Zero Motorcycles.....	9.9
Cruise Control	3.10, 3.16

D

Dash.....	3.19
Brightness & Contrast	3.29
Display Units	3.42
Gauges	3.25, 3.32, 4.11
Overview	3.19
Temperature Gauges.....	4.11
Warning Lights	3.22
Dash Screens	3.27
Menu Screen.....	3.27
Riding Screen	3.27
Data.....	8.2

Date	
Setting - Time, Month, & Year	3.38
Drag Torque Control	4.22
Drive Belt.....	6.24
Adjustment.....	6.27
Checking Drive Belt Tension.....	6.24, 6.26
Gates® Carbon Drive™ Smartphone application	6.25

E	
Emissions Information	1.4
Errors	
Access Errors	3.56
Error Code Definitions	7.3

F	
Firmware Version	3.57
Fuses.....	6.33
12 Volt Fuse Center	6.34
High Voltage Fuses.....	6.36

G	
Gauges.....	3.25, 3.32
General Operation	
Key Switch/Steering Lock Positions	4.7
Pre-Ride Inspection	4.1
General Safety Precautions.....	2.1

H	
Headlight	
Alignment	6.29
Bulb Replacement.....	6.29
Heated Grips (if equipped).....	3.17
Helmet Lock	3.58

I	
Ignition switch.....	4.7
Important Operating Information	2.2
Inspection - Pre-ride	4.1

K	
Keys	4.6
Kickstand	3.5, 4.8

L	
Load limits	4.2
Location Of Important Labels.....	2.3, 2.4
Log book	10.1

M	
Maintenance	
Record.....	10.1
Maintenance Schedule.....	6.2
Maximizing Range	4.13
Maximum weight capacity	4.2
Mode Button.....	3.12

Terminology	3.12
Motor Serial Number	1.5
Motor Stop Switch.....	3.10

O

Operating Your Motorcycle	4.9
Braking	4.9, 4.16
Stopping.....	4.9
Tip-over sensor.....	4.8
Owner's Responsibilities.....	6.1

P

Parking	6.38
Parts and accessories.....	1.4
Parts/Maintenance Items	6.2
Power Pack	6.9
Plug in Your Z-Force Power Pack.....	1.1, 5.3
Power pack and battery referencing	1.2
Serial Number.....	1.5
State of Charge	3.20, 3.47
When to charge your Z-Force Power Pack	1.3
Power pack and battery referencing	1.2
Power Tank	5.5

R

Replacement keys.....	4.6
Replacement tires	6.23
Reporting safety defects	9.10

Ride Modes.....	3.13
CUSTOM	3.13
ECO, STREET, SPORT, & RAIN	3.13

S

Safe Riding Information.....	1.2
Safety Interlocks.....	7.9
Seat Removal	6.28
Serial Number	
Motor.....	1.5
Power Pack	1.5
Smartphone Application.....	4.3
Specifications.....	8.1
State of Charge (SoC).....	3.47
Steering lock	4.7
Storage	
Long Term	6.38
Suspension	
Front.....	6.14
Rear.....	6.14
Suspension Adjustment.....	6.15
Front Fork Adjustment	6.18
Rear Shock Adjustment	6.19
Suspension settings	
Front (Factory).....	6.18
Rear (Factory).....	6.22

T

Technical Specifications	
SR/S (Europe).....	8.2
SR/S (Rest Of The World).....	8.6
Time	
Auto Time Sync.....	3.38
Display on Dash (am/pm or 24hr).....	3.42
Format (am/pm or 24hr).....	3.38
Setting.....	3.38
Visible or Hidden.....	3.34
Tip-over sensor.....	4.8
Tire Inflation.....	6.23
Traction Control.....	4.19
Disable.....	4.19
Modes - Street, Sport, & Rain.....	4.19
Traction Control Indicator.....	4.19
Trip	
Display A or B.....	3.31
Reset.....	3.55
Turn Signal Light Bulb Replacement.....	6.30

V

Vehicle Identification Number (VIN)	
Location.....	1.5
Understanding Your VIN Number.....	8.1
Vehicle Range.....	4.12

W

Warning Lights.....	3.22
Warranty	
Coverage.....	9.1
Exclusions.....	9.3
Transfer Of Ownership And Warranty.....	9.8
Wheels And Tires.....	6.23

Y

Yellow key.....	4.6
-----------------	-----

First Responder Information – High Voltage Component Locations



WARNING



**DO NOT CUT
COLORED
ZONES**



NEVER cut high voltage components or cabling. Cutting could result in serious injury or death.



High voltage cables and components may remain energized for up to 60 seconds after disabling.

 HIGH-VOLTAGE

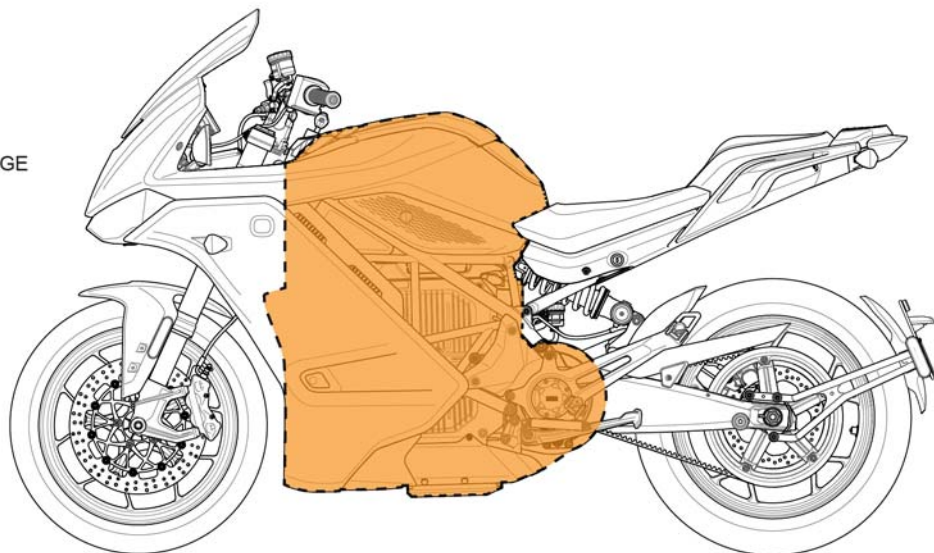

ZERO
MOTORCYCLES®



ZEROMOTORCYCLES.COM

88-09219-01