

Workbook

Transmission Technology

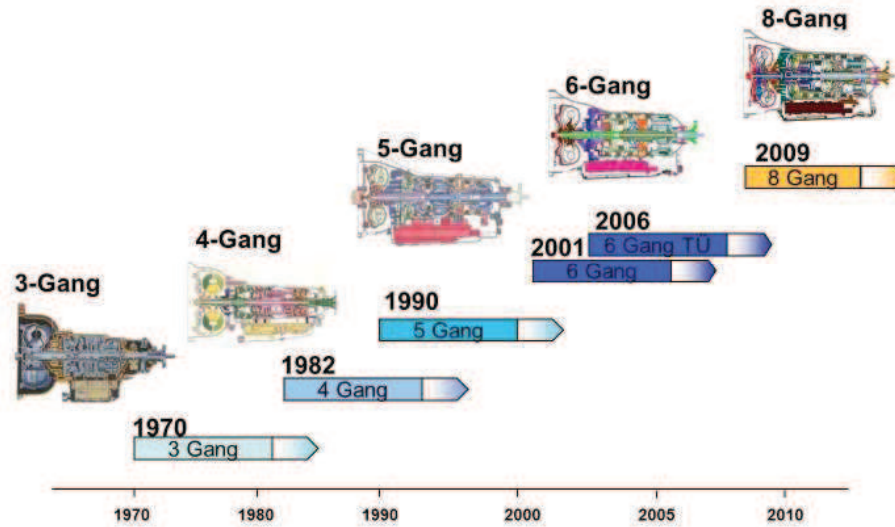



Table of content

1. Transmission History	3
2. 6HP Design	4
3. Adaption	25
3. Oil change Service and Mechatronic	38
4. 6HP Overhaul	60
6. 8 HP Transmission	80
7. Identification of the Transmission	85
8. Troubleshooting	113

History of Automatic Transmissions



16 basic types in 769 versions

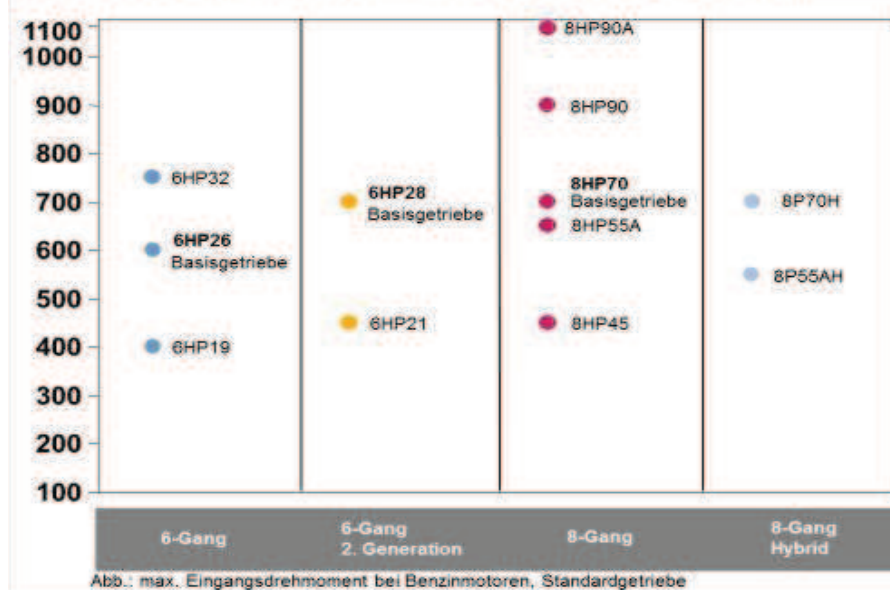

The hydrodynamic torque converter

Converter operating principle

The torque converter consists of the impeller, the turbine wheel, the reaction element (stator) and the oil content needed to transmit the torque.

The impeller, which is driven by the engine, imparts a circular flow of the oil in the converter. This oil strikes the turbine wheel, which causes the flow to change its direction. The oil flows out of the turbine wheel close to the hub and strikes the stator, where its direction is changed again to a direction for re-entering the impeller.

The change in direction at the stator generates a torque reaction that increases the torque reaching the turbine. The ratio between the turbine and the impeller torque is referred to as torque multiplication or conversion.

The greater the difference in speeds of rotation at the impeller and the turbine, the greater the increase in torque.

The maximum increase is obtained when the turbine wheel is stationary. As turbine wheel speed increases, the amount of torque multiplication gradually drops. When the turbine wheel is rotating at about 85% of the impeller speed, torque conversion reverts to 1. That is to say torque at the turbine wheel is no higher than at the impeller.

The stator, which is prevented from rotating backwards by a freewheel and the shaft in the gearbox housing, runs freely in the oil and overruns the freewheel. From this point on, the converter acts only as a fluid coupling.

During the torque conversion process, the stator ceases to rotate and bears against the housing via the freewheel.

Torque converter

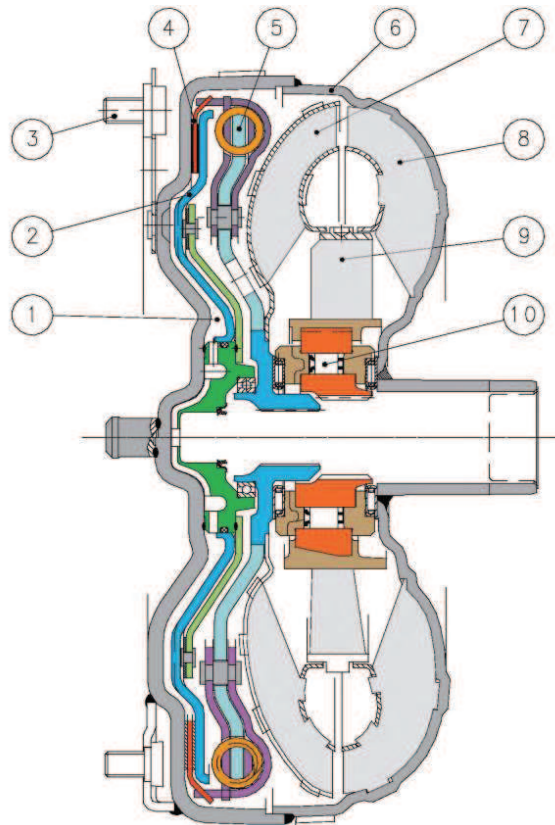

- (1) Space behind lock-up clutch
- (2) Lock-up clutch piston
- (3) n_Mot
- (4) Lined plate of lock-up clutch
- (5) Torsional vibration damper
- (6) Converter cover
- (7) Turbine wheel
- (8) Pump wheel
- (9) Stator
- (10) Stator freewheel

Converter operating principle

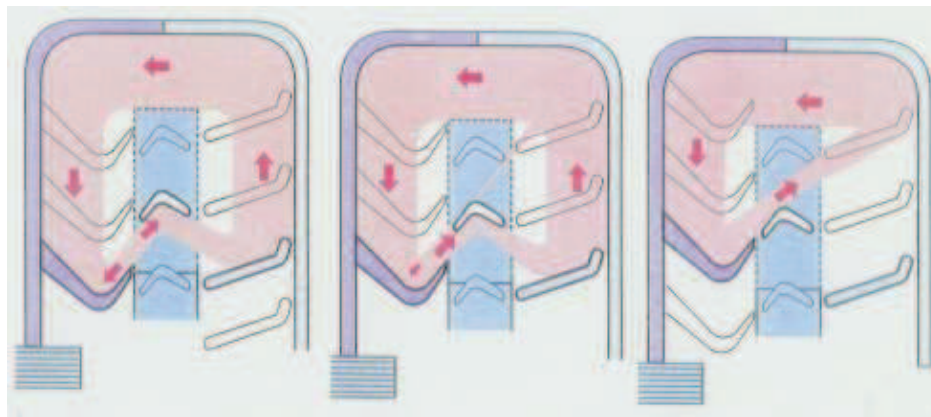
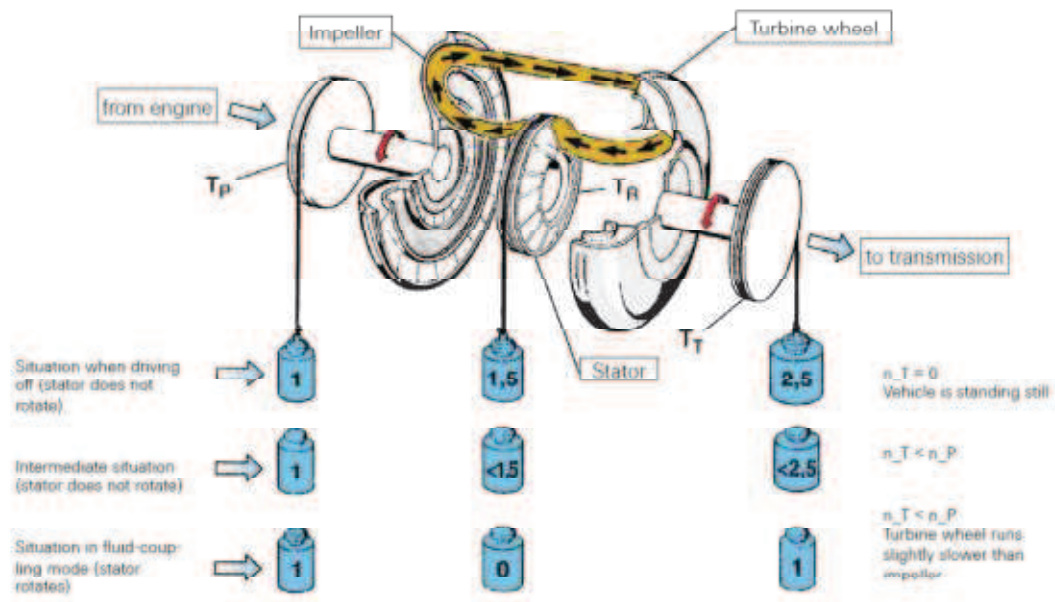

Automatic transmission basics

Planetary gear

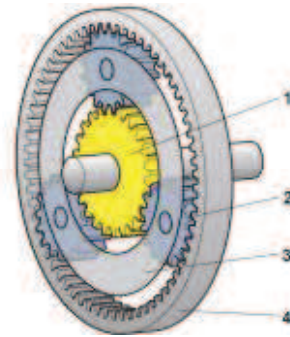
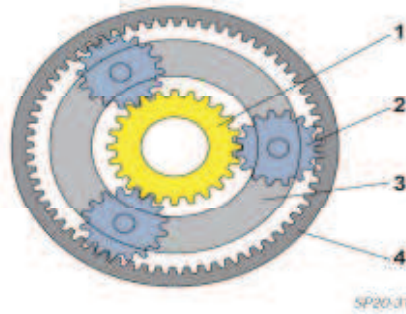

- 1. Sun gear
- 2. Planetary gear

- 3. Planetary gear carrier
- 4. Ring gear

Planetary gear – functional principles



Ring gear fixed – sun wheel drives =
Large transmission into slow

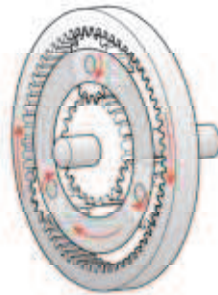

Sun wheel fixes – ring gear drives =
Small transmission into slow



Planetary carrier fixed – sun wheel drives =
Reversion of rotation

Ravigneaux - Gear

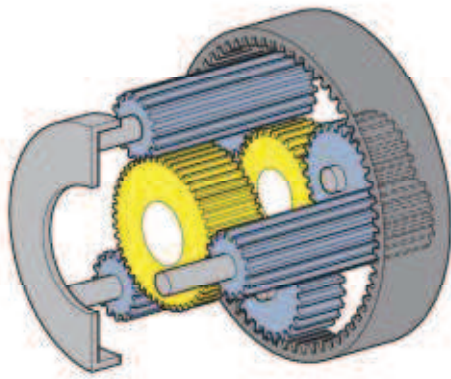

2 sun gears
1 Ring gear



1 Planetary carrier holding:
2 sets of planets. Inner and outer planet

- A Ravigneaux gear set is a Simple gear set on which every planet gear is replaced by an extra set of planets.
- Out of the 2 sets of planets only the outer set meshes the ring gear.
- On almost all applications the ring gear is the output component.
- Mathematically it adds up to 3 forward inputs of different ratio and 1 reverse motion.

Shift elements – multi-disc clutch

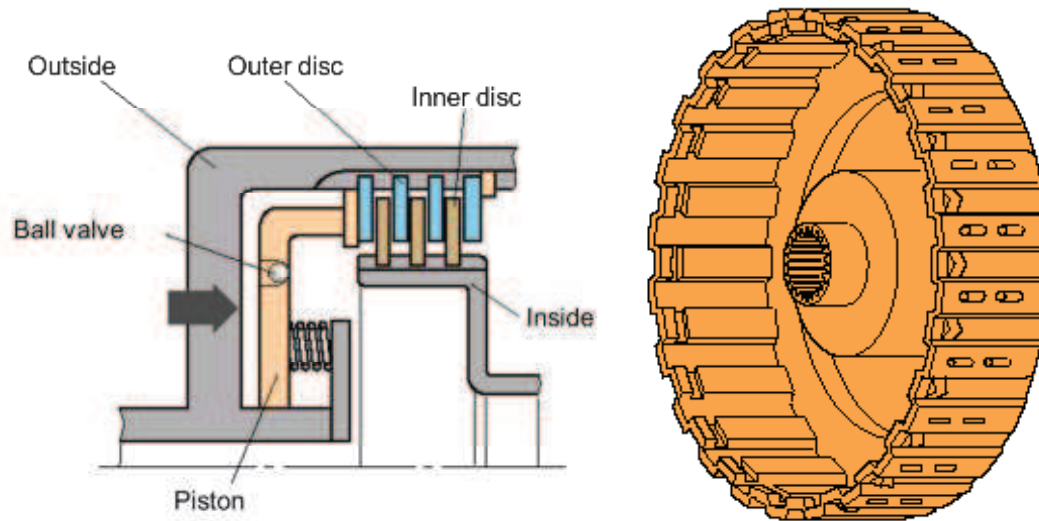

Shift elements – multi-disc brake

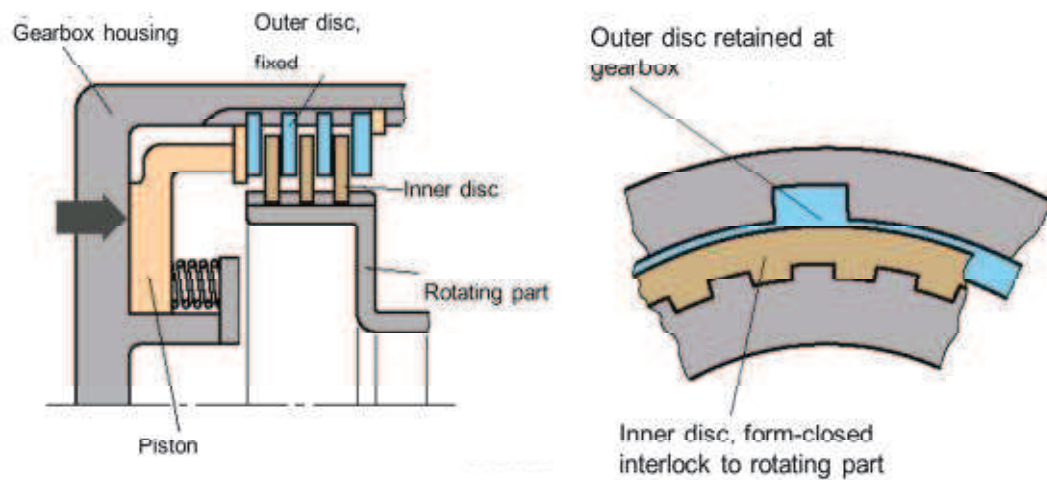

Freewheel

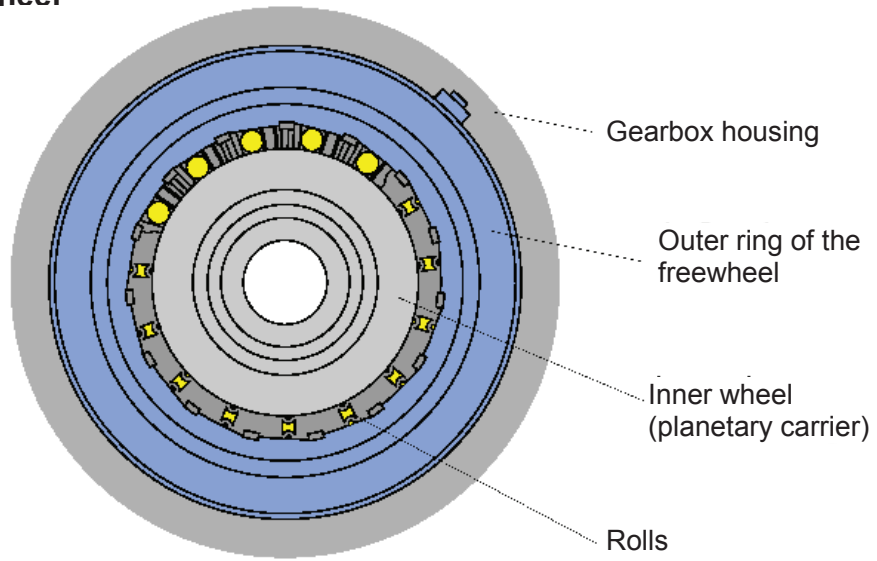

Freewheel

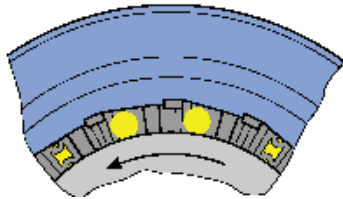

Locking direction

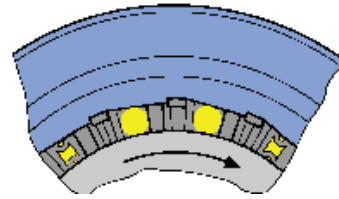

Roll freewheel

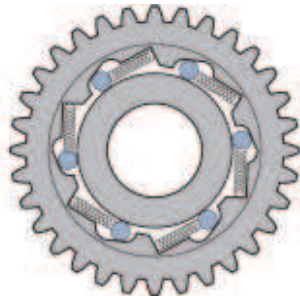

Clamp body freewheel

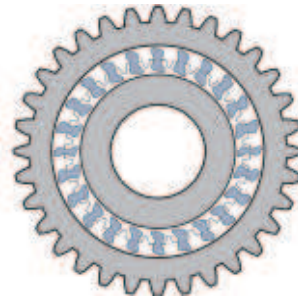

6 HP Design Sizes

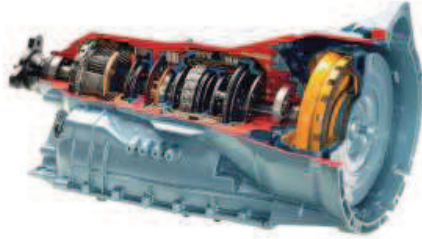

2002 6HP19 → 2007 6HP21

Max. Torque 400Nm



2002 6HP26 → 2007 6HP28

Max. Torque 600Nm

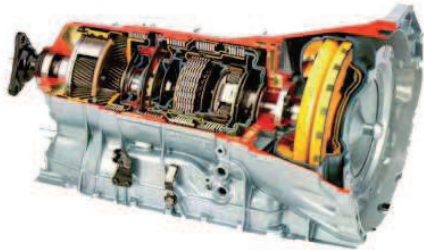

2002 6HP32

Max. Torque 750Nm

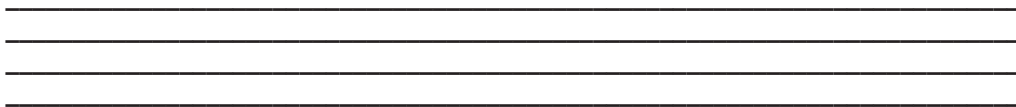



Technical description

- 6 forward and 1 reverse gears
- Electronically controlled
- Fixed sun single planetary gear set IN FRONT of a modified Ravigneaux gear set
- No OWC's
- Ranges weight from 170 to 220 lbs
- Introduction of Mechatronics

Mechanical gear ratios

Gear:	1.	2.	3.	4.	5.	6.	R
Ratio:	4,171	2,340	1,521	1,143	0,867	0,691	3,403
Ratio steps:		1,782	1,538	1,331	1,318	1,255	
Total:	6,04						

Oil pump (Crescent oil pump)

The oil pump is of "crescent" pattern and delivers app. 16 cm³ per revolution and a pressure of 17 bar. It is located between the torque converter and the gearbox housing.

The converter is supported in the pump by a needle roller bearing. The pump is directly driven by the engine via the converter shell and supplies oil to the transmission and the hydraulic control unit.

The pump ingests the oil through a filter and delivers it at high pressure to the main pressure valve in the hydraulic control unit. This valve adjusts the pressure and returns excess oil back to the oil sump.

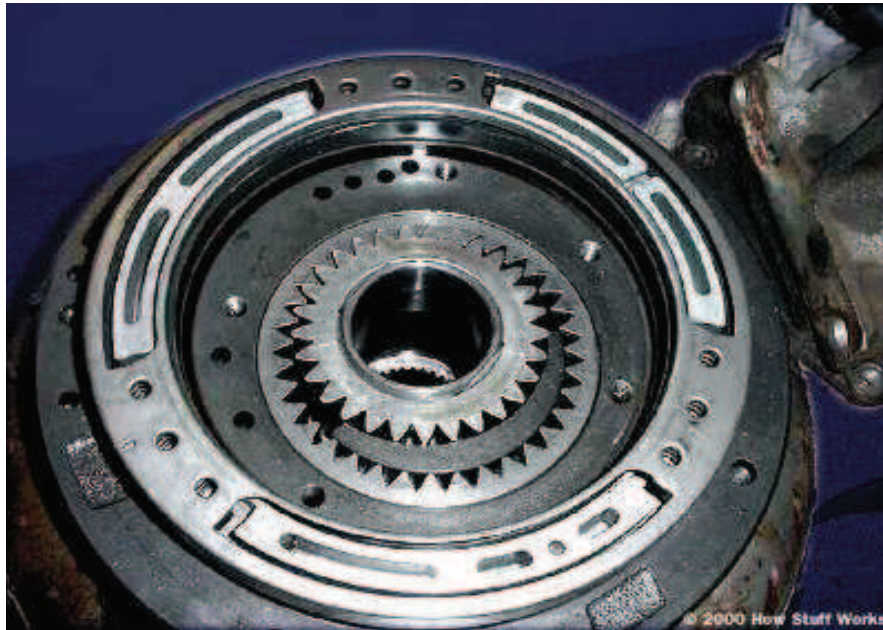

Gearbox Setting for 6 HP Automatic Transmissions

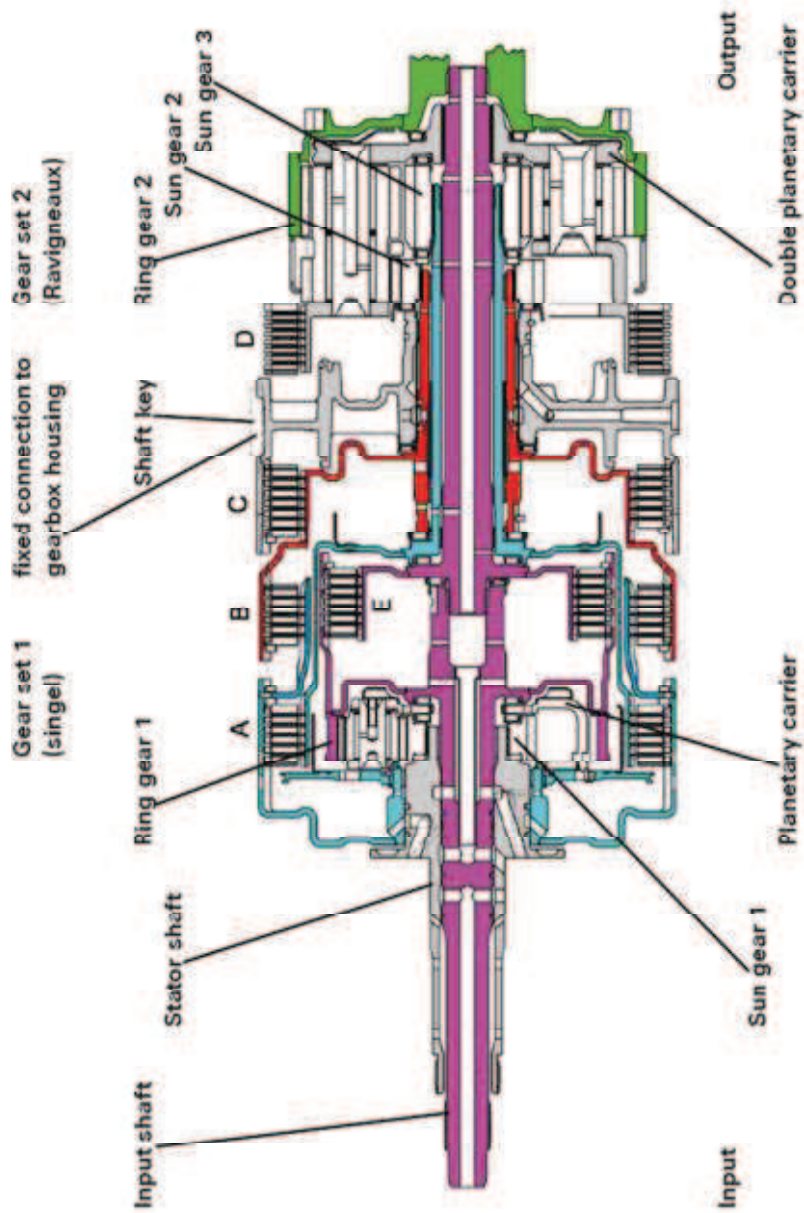

Shift elements clutch A,B and E

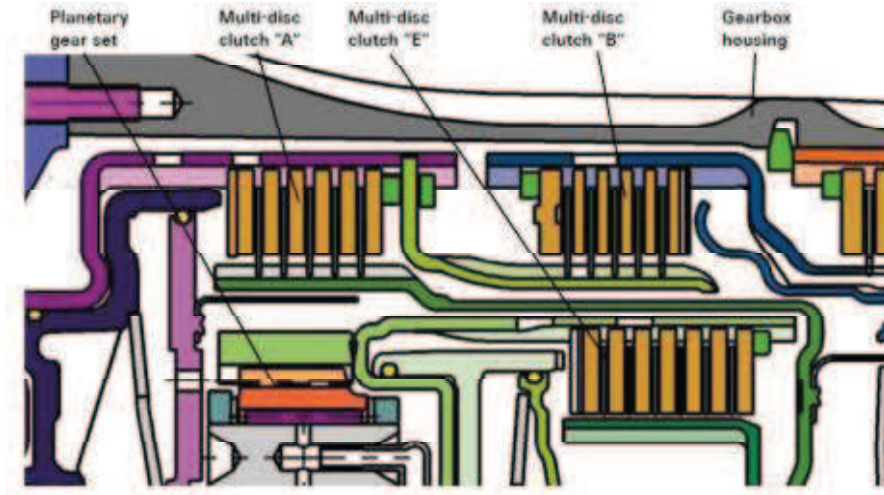

Shift elements brake C and D

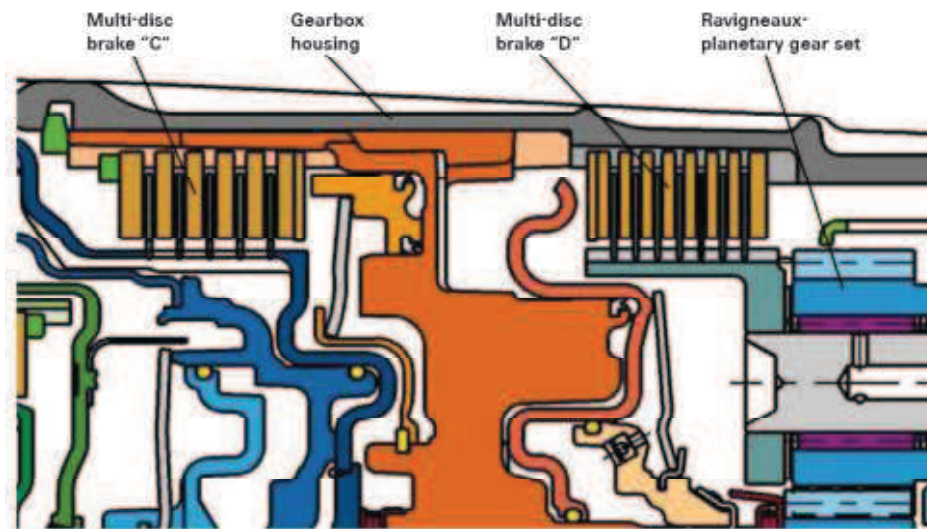

Lepelletier gear design

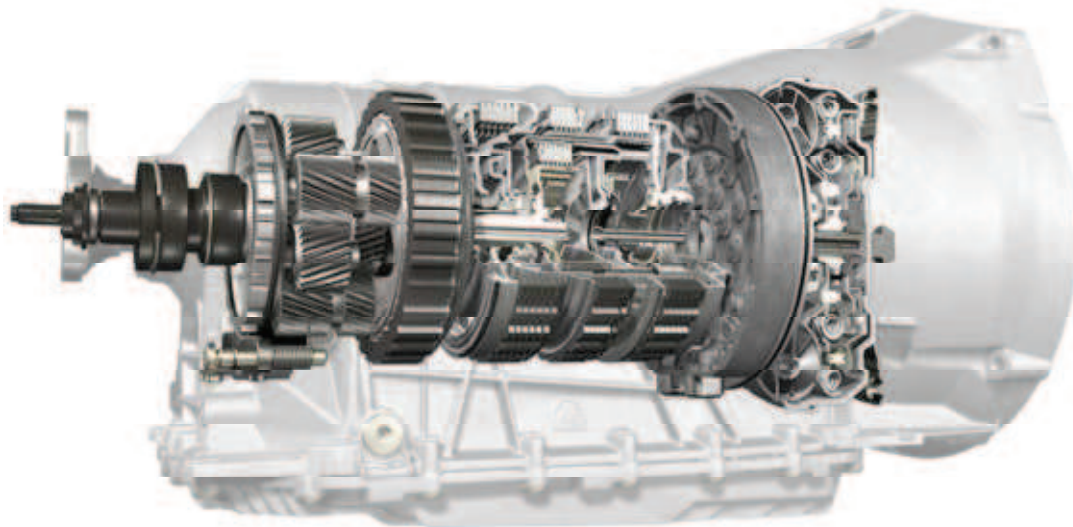

- A single planetary gear set
- Follow by a Ravigneaux gear set
- It is the heart, reason and soul of the 6HP's advantages such as lightweight, lower fuel consumption and impressive performance levels
- It comprises of: 2-Sun gears, 3 short planetary gears, 3 long planetary gears, 1 planetary carrier and 1 ring gear

Lepelletier gear design

Front (primary) planetary gear

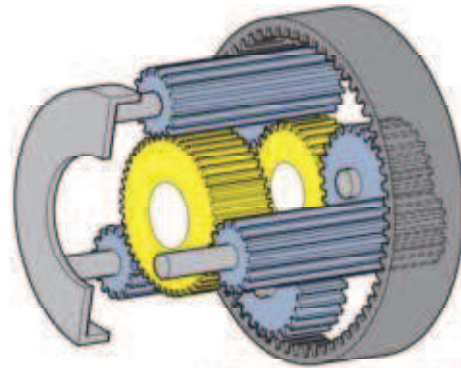
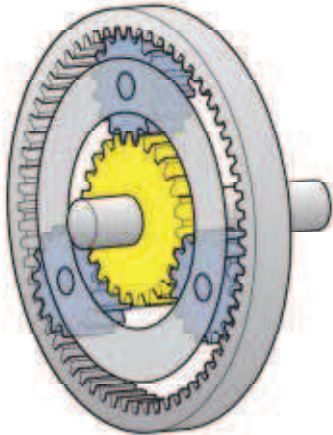

Downstream (secondary)
Ravigneaux-gear set

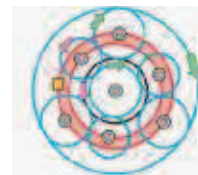
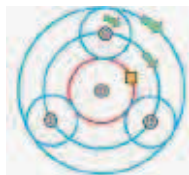
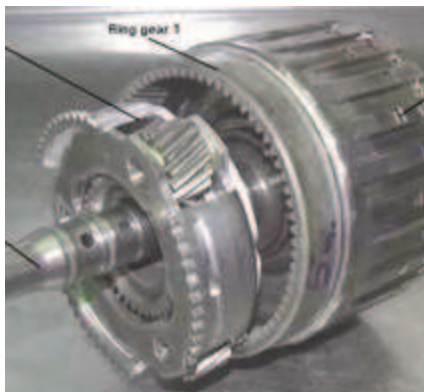

Systematic exposure

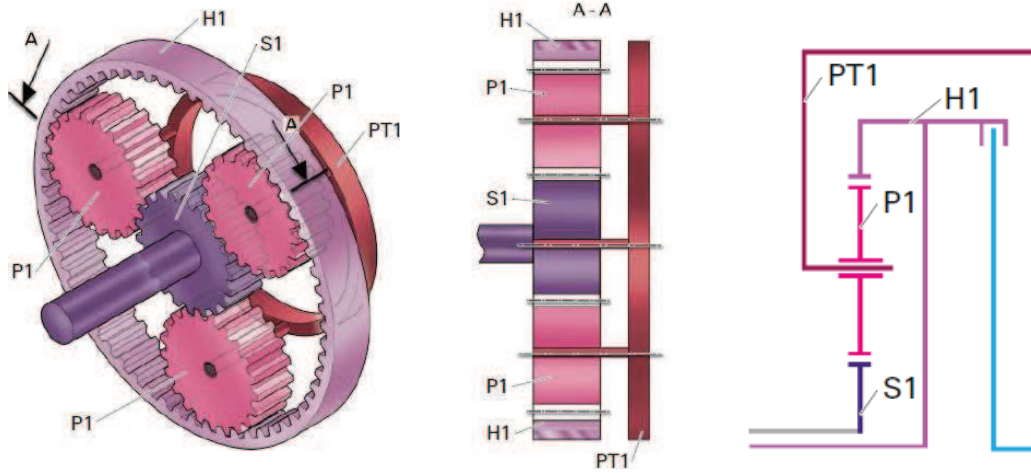

Schematic diagram 6HP

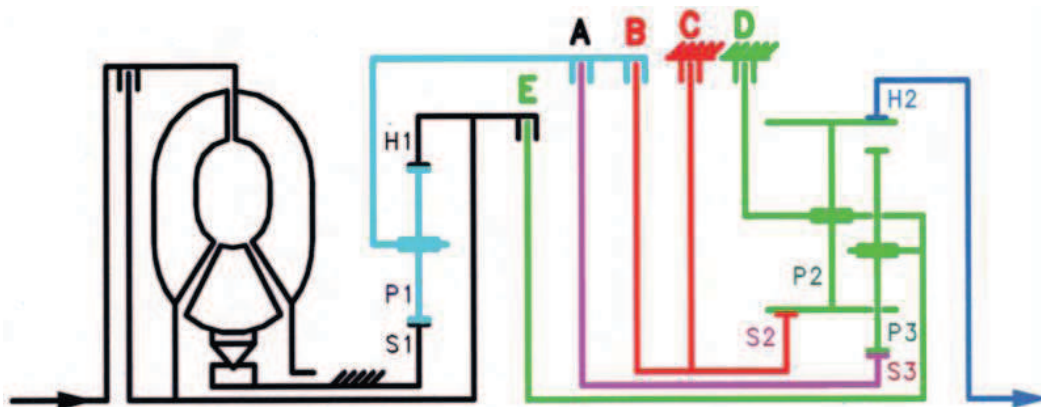

Description of 1st gear power flow

The input shaft drives the ring gear of the front, single planetary gear set and the outer disc carrier of clutch E.

Ring gear 1 drives the planet gears that roll round fixed sun gear 1. This drives planetary carrier 1 and also the outer disc carrier A as well as the inner disc carrier of clutch B.

When clutch A is engaged, sun gear 3 in the Ravigneaux planetary gear set is driven. This meshes with the short planet gears.

The double planetary carrier bears against the gearbox housing by way of brake D. This enables ring gear 2 (output shaft) to be driven in the same direction as the engine via the long planet gears.

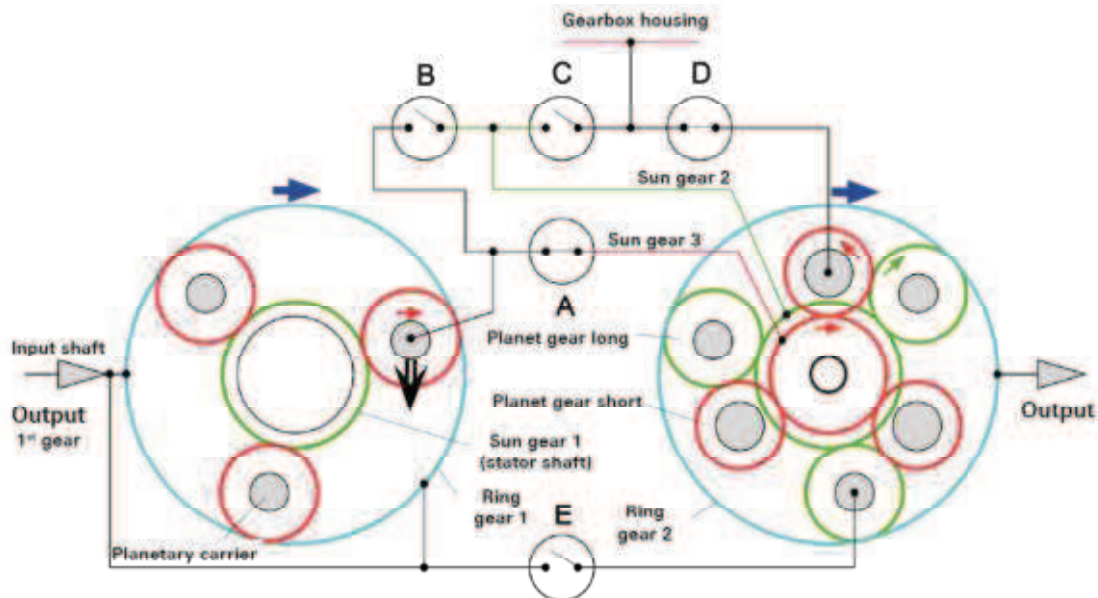

Description of 2nd gear power flow

The input shaft drives the ring gear of the front, single planetary gear set and the outer disc carrier of clutch E.

Ring gear 1 drives the planet gears that roll round fixed sun gear 1. This drives planetary carrier 1 and also the outer disc carrier A as well as the inner disc carrier of clutch B.

When clutch A is engaged, sun gear 3 in the Ravigneaux planetary gear set is driven. This meshes with the short planet gears.

Sun gear 2 is locked to the gearbox housing by brake C. The long planet gears which are meshed with the short planet gears roll round the fixed sun gear 2 and drive the double planetary carrier and the ring gear 2 in the direction of the engine rotation.

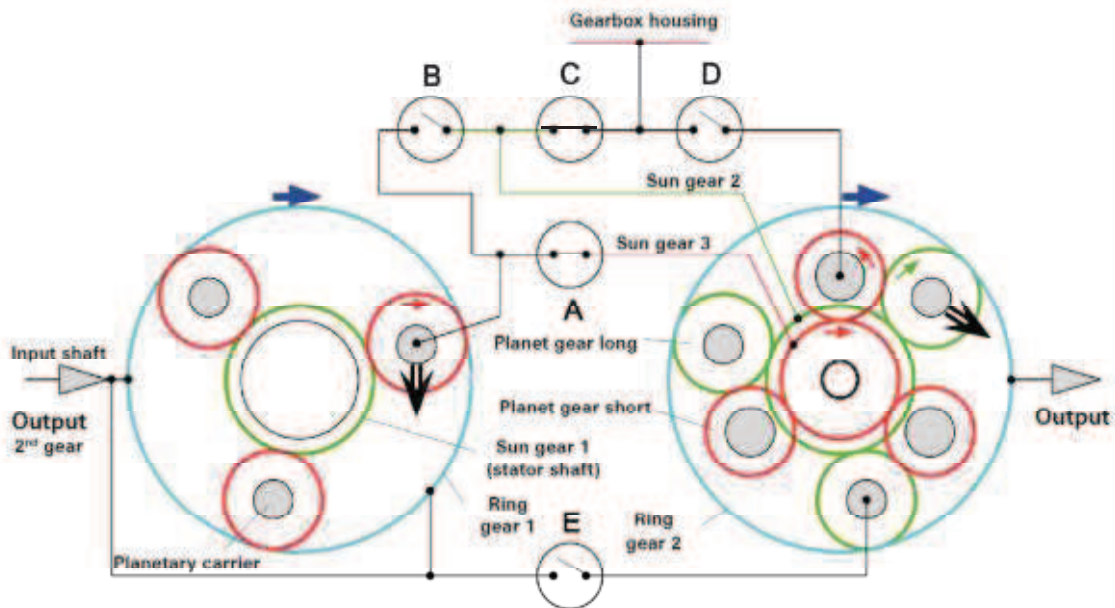

Description of 3rd gear power flow

The input shaft drives the ring gear of the front, single planetary gear set and the outer disc carrier of clutch E.

Ring gear 1 drives the planet gears that roll round fixed sun gear 1. This drives planetary carrier 1 and also the outer disc carrier A as well as the inner disc carrier of clutch B.

When clutch A is engaged, sun gear 3 in the Ravigneaux planetary gear set is driven. This meshes with the short planet gears.

Sun gear 2 is driven via engaged clutch B. The long planet gears which are meshed with the short planet gears cannot roll round the driven sun gear 2 and drive the blocked double planetary carrier in the direction of the engine rotation.

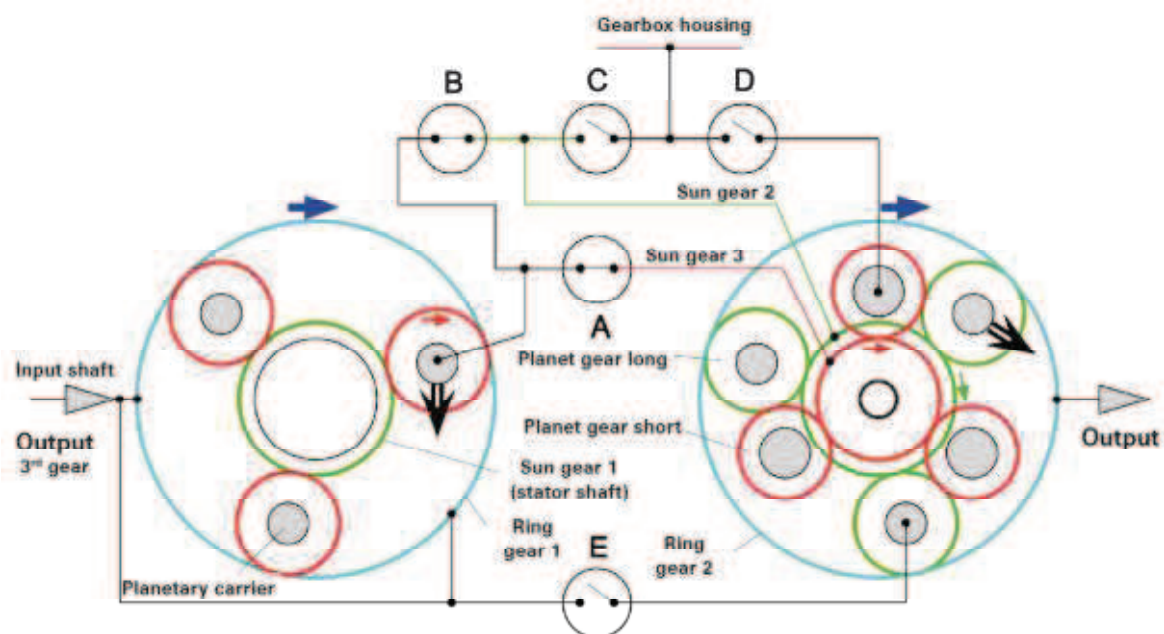

Description of 4th gear power flow

The input shaft drives the ring gear of the front, single planetary gear set and the outer disc carrier of clutch E.

Ring gear 1 drives the planet gears that roll round fixed sun gear 1. This drives planetary carrier 1 and also the outer disc carrier A as well as the inner disc carrier of clutch B.

When clutch A is engaged, sun gear 3 in the Ravigneaux planetary gear set is driven. This meshes with the short planet gears.

The double planetary carrier is driven via the engaged clutch E. The long planet gears which are meshed with the short planet gears drive - together with the double planetary carrier - the ring gear 2 in the direction of the engine rotation.

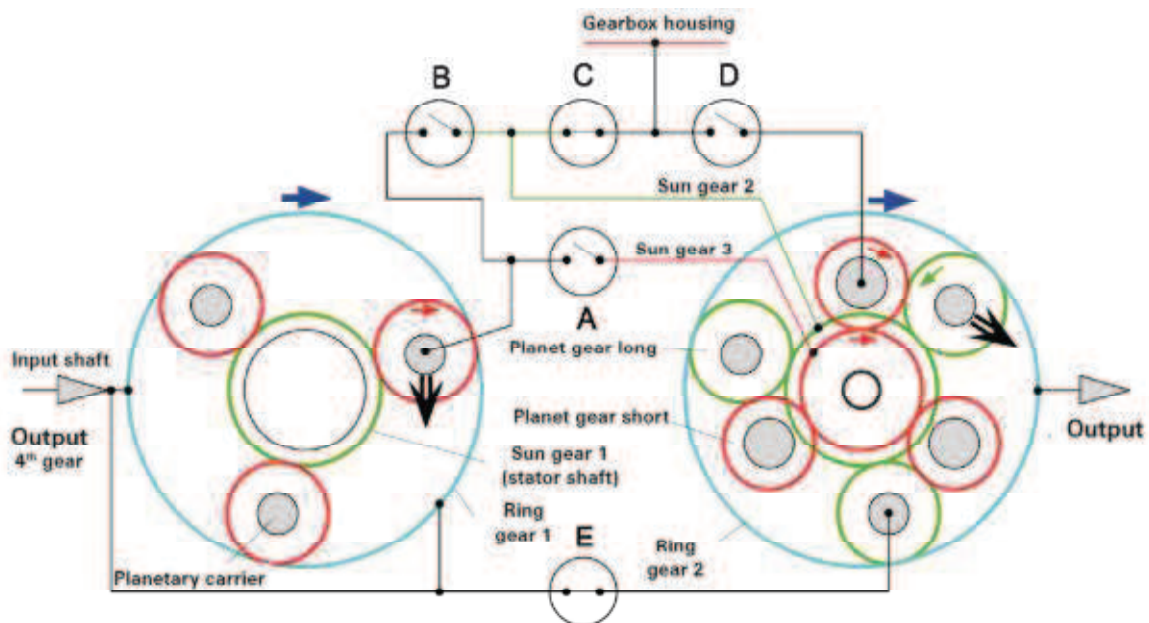

Description of 6th gear power flow

The input shaft drives the ring gear of the front, single planetary gear set and the outer disc carrier of clutch E.

The clutches A and B are released, so that the front planetary gear set has no effect. Sun gear 2 is locked to the gearbox housing via brake C which is applied.

The double planetary carrier is driven via the engaged clutch E. The long planet gears which are meshed with the short planet gears roll round the fixed sun gear 2 and drive the ring gear 2 in the direction of the engine rotation.

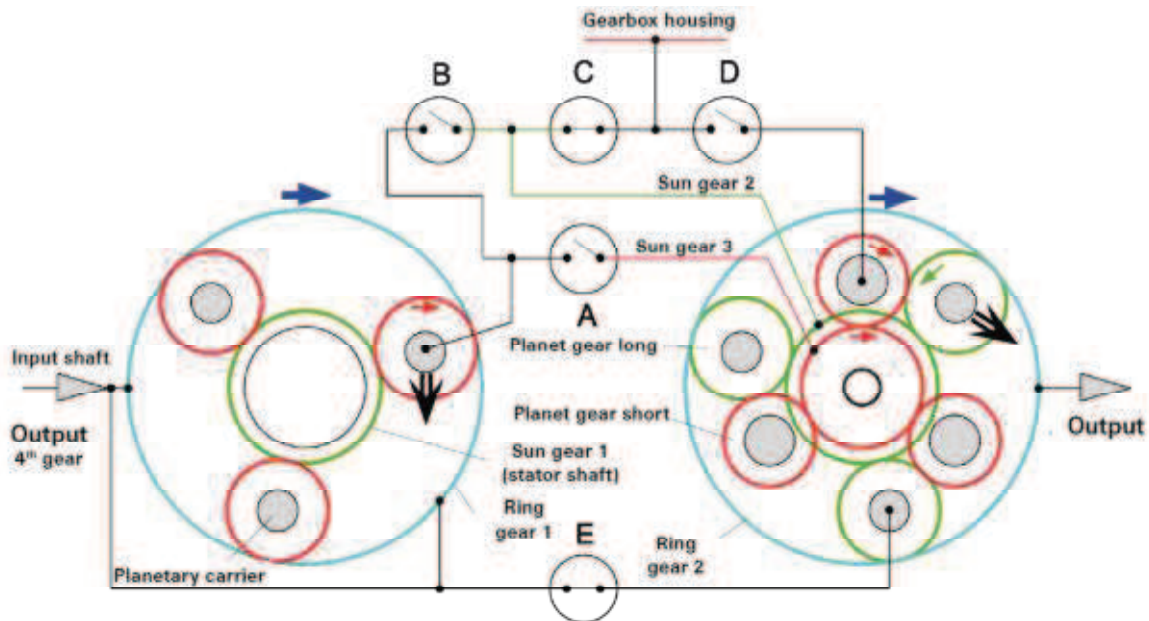

Description of reverse gear (R) power flow

The input shaft drives the ring gear of the front, single planetary gear set and the outer disc carrier of clutch E.

Ring gear 1 drives the planet gears which roll round fixed sun gear 1. This drives planetary carrier 1 and also outer disc carrier A as well as the inner disc carrier of clutch B.

When clutch B is engaged, sun gear 2 in the Ravigneaux planetary gear set is driven. It is in mesh with the long planet gears.

The double planetary carrier is locked to the gearbox housing by brake D. As a result ring gear 2 (output shaft) can be driven in the opposite direction to engine rotation by way of the long planet gears.

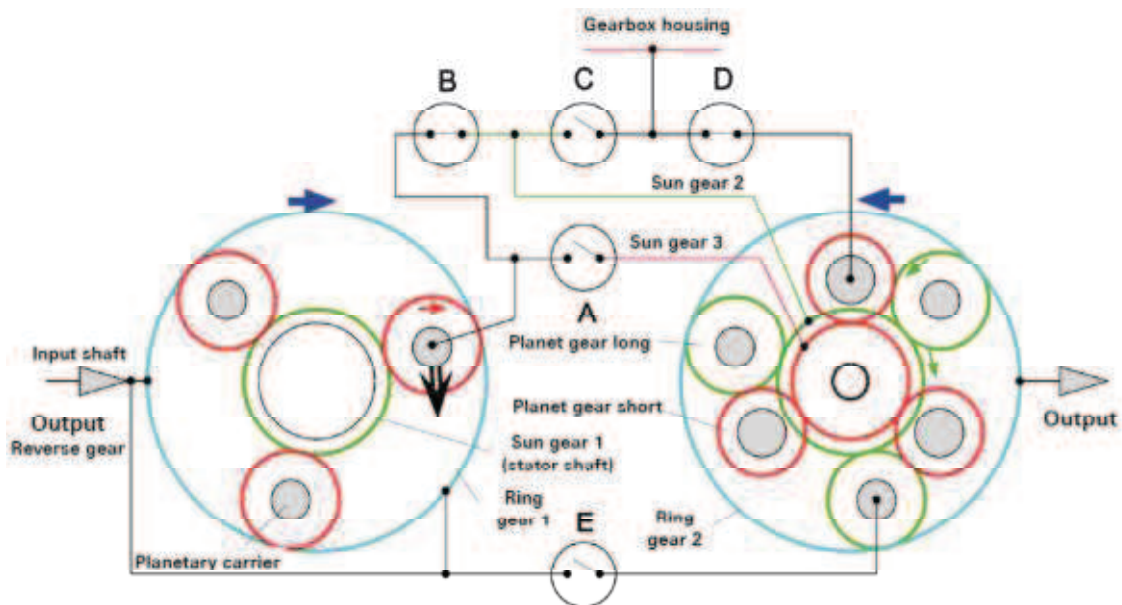

EDS – Pressure regulators

Do not change the composition of the valves!

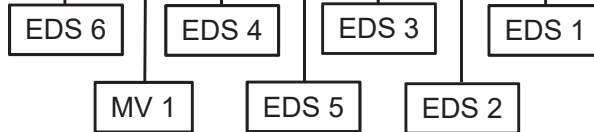
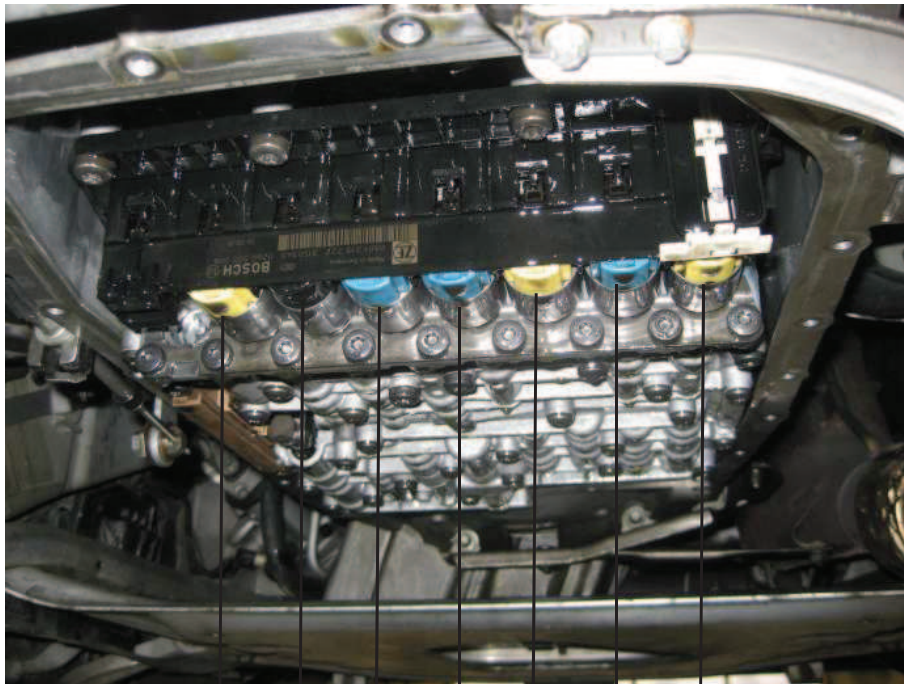

EDS-Types

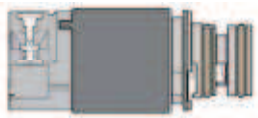

Solenoid valve



Pressure regulator
Pressure range 4,0 – 0bar
Resistance 5,05 Ω

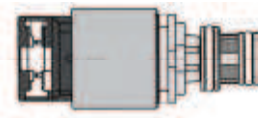

Pressure regulator
Pressure range 4,0 – 0bar
Resistance 5,5 Ω

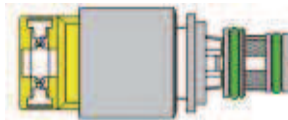

Pressure regulator
Pressure range 0 – 4,0bar
Resistance 5,05 Ω

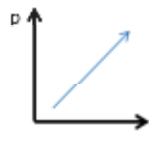
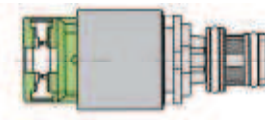

Pressure regulator
Pressure range 0 – 4,6bar
Resistance 5,5 Ω



Pressure regulator
Pressure range 0 – 4,7bar
Resistance 5,05 Ω

Adaption - Introduction

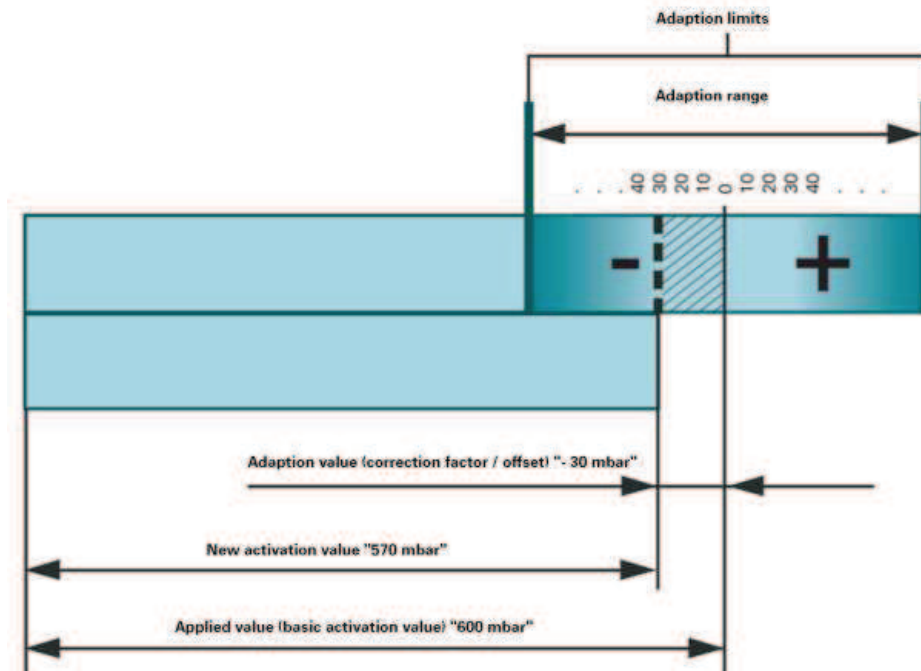

Adaption values are corrective values (so-called offsets) which are either added to or subtracted from the default values (applied values) permanently stored in the gearbox control unit.

Adaption - Introduction

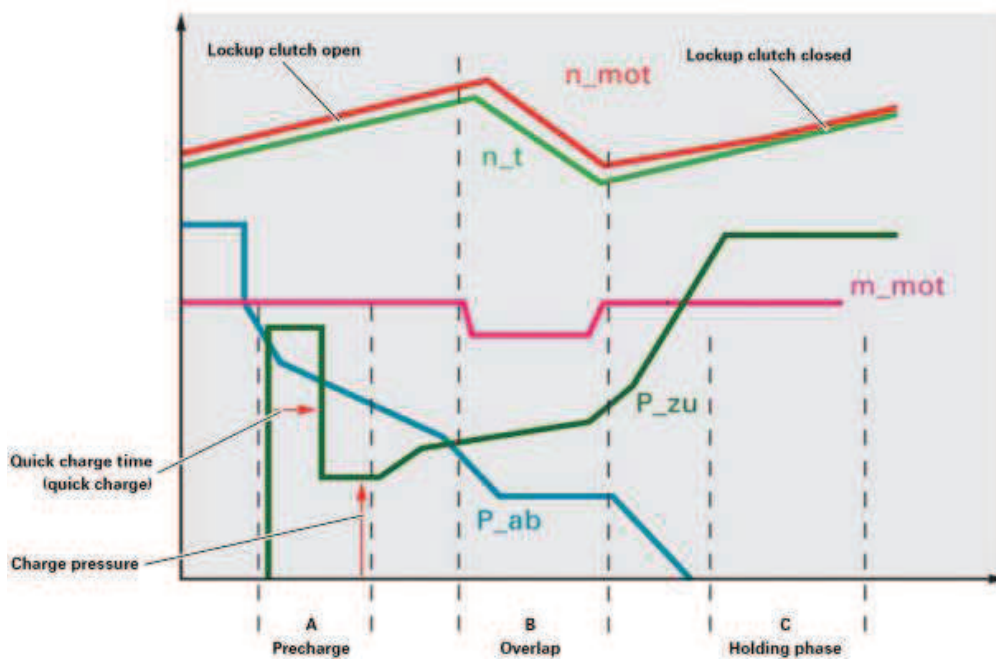

Legend:

- n_{mot} = engine speed
- n_t = turbine speed
- m_{mot} = engine torque
- P_{zu} = pressure engaging clutch
- P_{ab} = pressure disengaging clutch
- t = time
- A, B, C = adaption phases



Adaption - Introduction

Adaption of the precharge cycle...

... (charge pressure and quick charge time) adapts clutch play and clutch resistance until the clutch assembly makes contact, but still does not transmit an appreciable amount of torque.

Adaption of the shift pressure...

... is based on an analysis of the change in gearbox input speed (engine speed gradient) during the gearshift.

Example:

During an excessively harsh gearshift (uncomfortable gearshift), the engine speed drops too quickly (steep engine speed gradient).

The adaption program detects this condition from the engine speed gradients and reduces the clutch pressure by a defined amount (adaption value) during the next gearshift. This type of adaption is mainly carried out during the quick adaption cycle.

Adaption of the holding pressure...

... is generally based on calculations made using the values determined during the charge pressure and shift pressure adaption.

Adaption

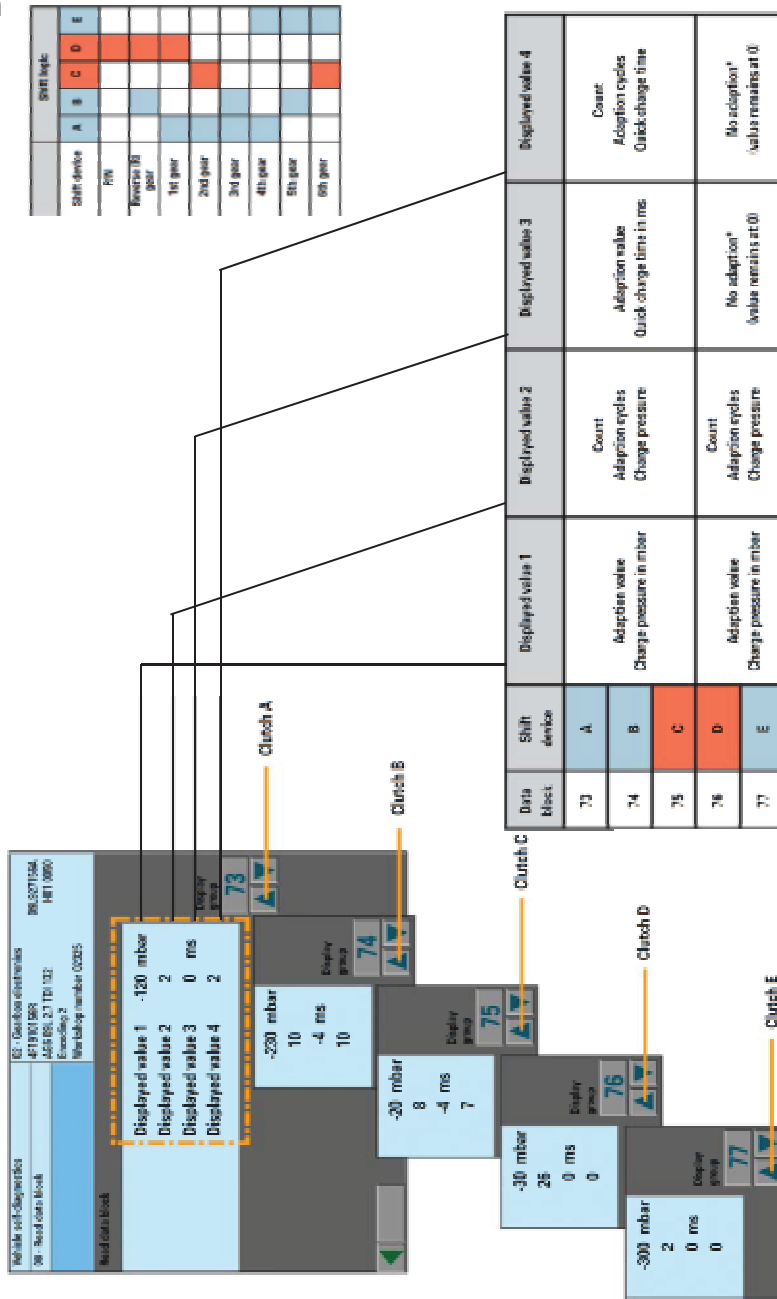

Charge pressure





ADAPTATION VALUES

Existing adaptation values of the automatic transmission:

Clutch fill pressures:

Clutch A:	<input type="text" value="340"/>
Clutch B:	<input type="text" value="748"/>
Clutch C:	<input type="text" value="146"/>
Clutch D:	<input type="text" value="200"/>
Clutch E:	<input type="text" value="750"/>

SCREEN CAPTURE BACK NEXT

   WBANB335X5CN63147   1/2







Quick charge time

ADAPTATION VALUES

Rapid fill times:

Clutch A:	<input type="text" value="64"/>
Clutch B:	<input type="text" value="102"/>
Clutch C:	<input type="text" value="-8"/>
Clutch D:	<input type="text" value="0"/>
Clutch E:	<input type="text" value="0"/>

   WBANB335X5CN63147   2/2



Adaption drive (VW / Audi)

Part A

Accelerate the vehicle from standing with very low throttle (15 – 25%) up to 4th gear and about 80 km/h. Freewheel the car down to about 40 km/h without using the brakes. Afterwards stop the car completely and stay in drive position for about 10 s. Repeat cycle 6 times.

Part B

Accelerate the vehicle up to about 70 km/h und select manually 5th gear. Use your diagnostic tool (VW/Audi block 9) to drive with 100 Nm for about 3 – 4 km.

Accelerate the vehicle up to about 85 km/h und select manually 6th gear. Use your diagnostic tool (VW/Audi block 9) to drive with 100 Nm for about 3 – 4 km.

Part C

Accelerate 5 times with low throttle up to about 100 km/h and freewheel the car down to about 40 km/h without using the brakes.

Adaption drive (BMW)

Depending upon the production date, transmission and vehicle models, there are 4 different adaptation procedures for BMW products.

	Software A (GS19.02)	Software N (GS19.04)	Software P (GS19.11)	Software T (GS19.11)
1 Series 116i	---	---	09/04 – 09/07	---
118i	---	---	09/04 – 03/07	---
120i	---	---	09/04 – 03/07	---
120d	---	---	---	03/07 – now
125i	GM 6 Transmission			
130i	---	---	09/04 – 03/07	---
135i	---	---	---	SOP - now
3 Series 320i	---	---	01/05 – 04/07	---
320d	---	---	---	03/07 – now
323i	---	---	01/05 – 09/07	---
325i	---	---	01/05 – 09/07	---
335i	---	---	---	09/07 – now
5 Series	---	07/03 – 03/05	03/05 – 03/07	03/07 – now
6 Series	---	09/03 – 09/05	09/05 – 09/07	09/07 – now
7 Series	09/01 – 10/03	10/03 – 03/05	08/05 – now	
X3 – E83	---	---	09/05 – 09/07	09/07 – now
X5 – E53	---	09/03 – 09/06	---	---
X5 – E70	---	---	---	10/06 – now
X6 – E71	---	---	---	01/08 – now

Adaption drive (BMW)

Software A

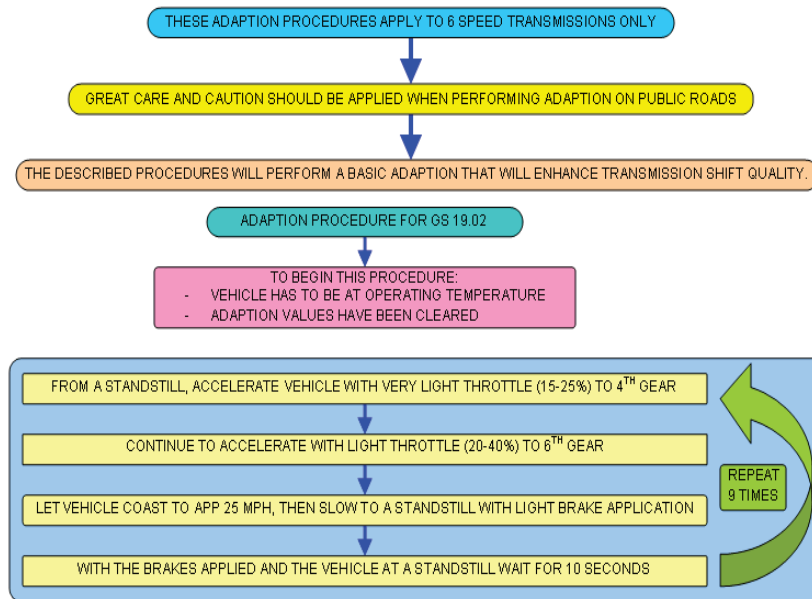

Software N

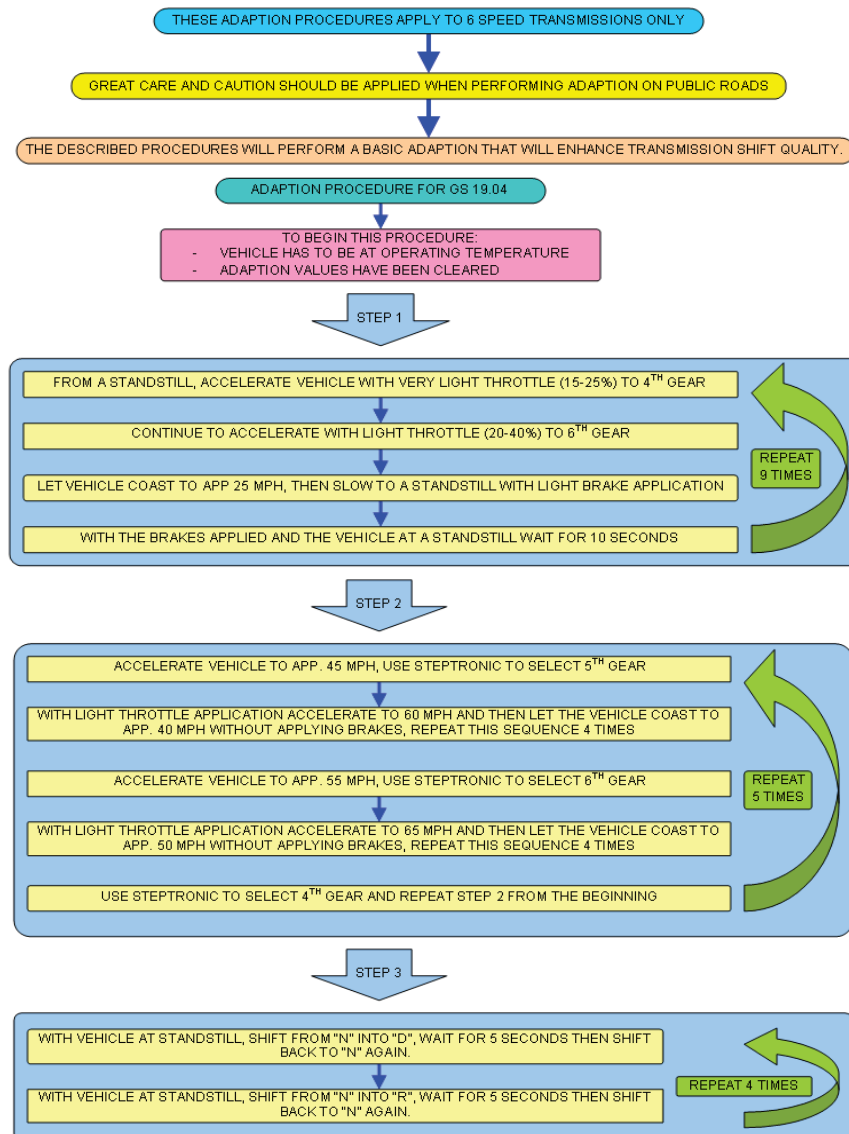

Software P

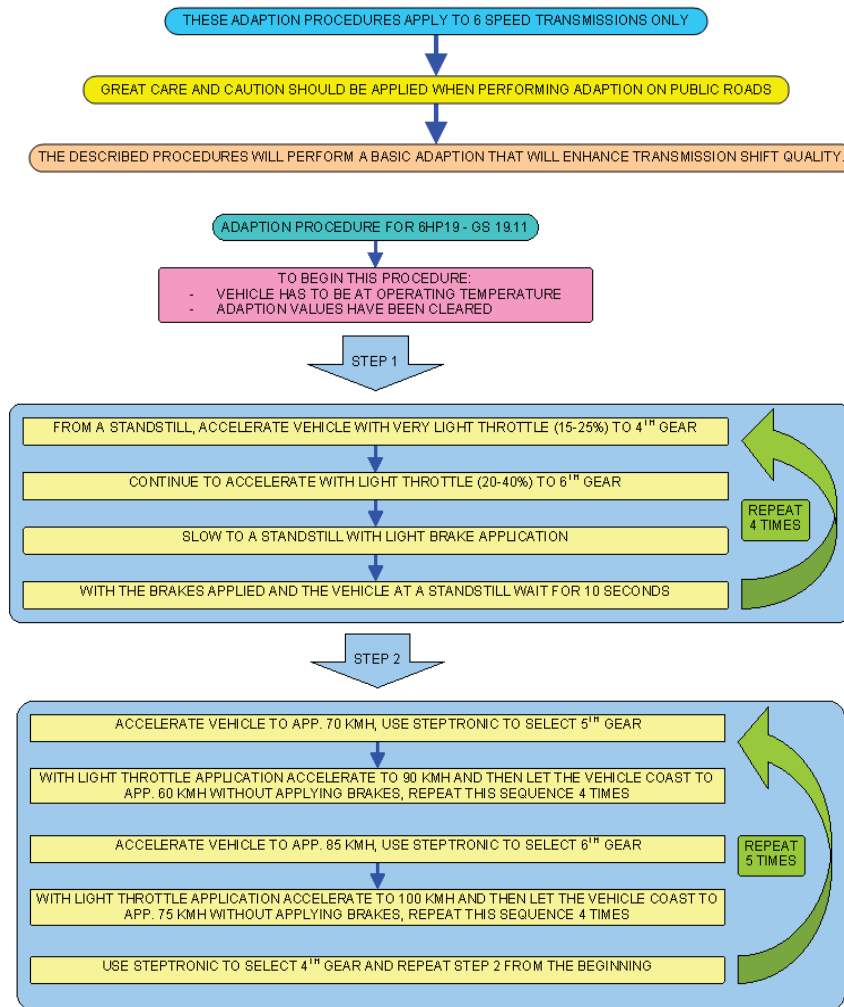

Software T

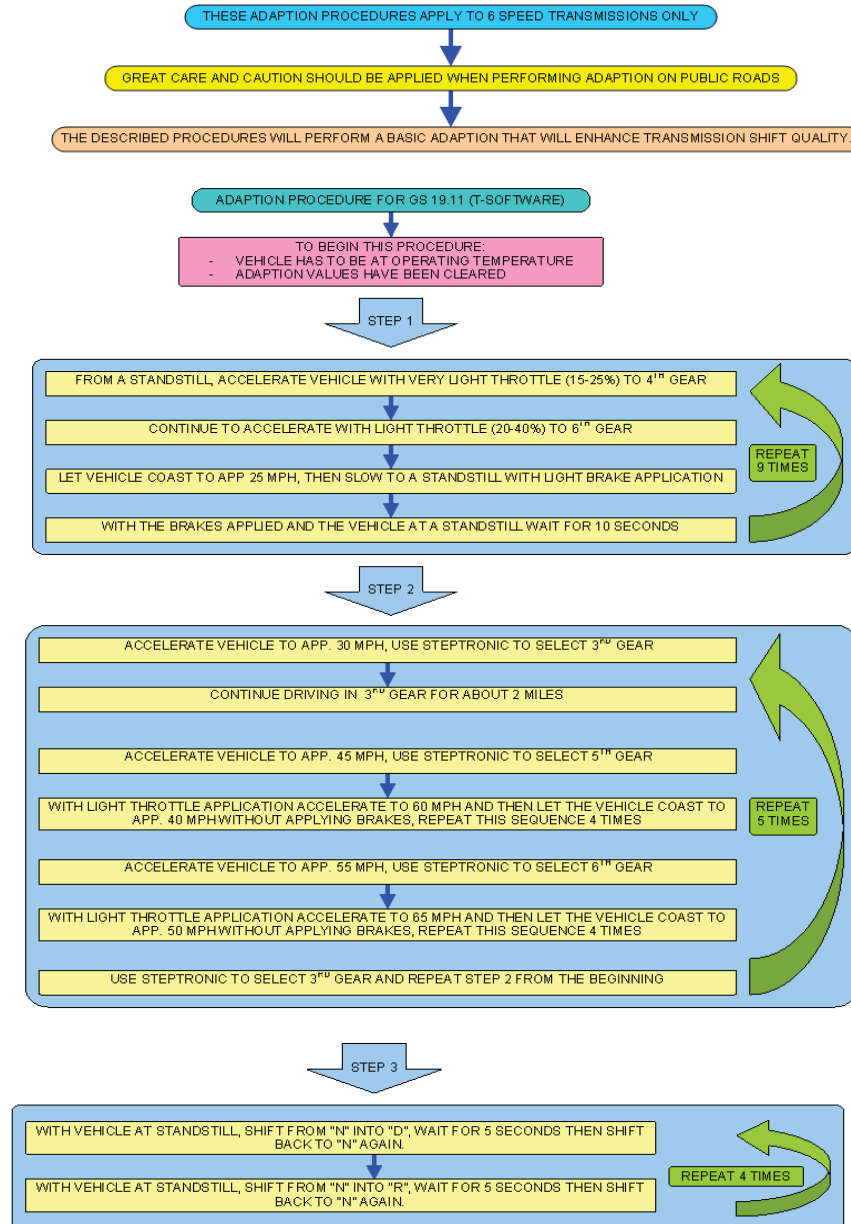

Drain the Oil





Removing and Attaching of the Oil Pan

Remove in any order, for attaching see below.



- Attach all the screws loosely
- Start at Pos. 1 and Pos. 2 to tighten screws
- Tighten the other screws crosswise from inside to outside (positional order)
- Torque 10 Nm of torque for screws M6 X 28,5

Remove the connection socket



External connection socket

Locking mechanism

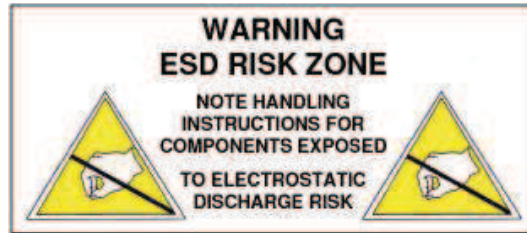

Evacuate the Torque Converter

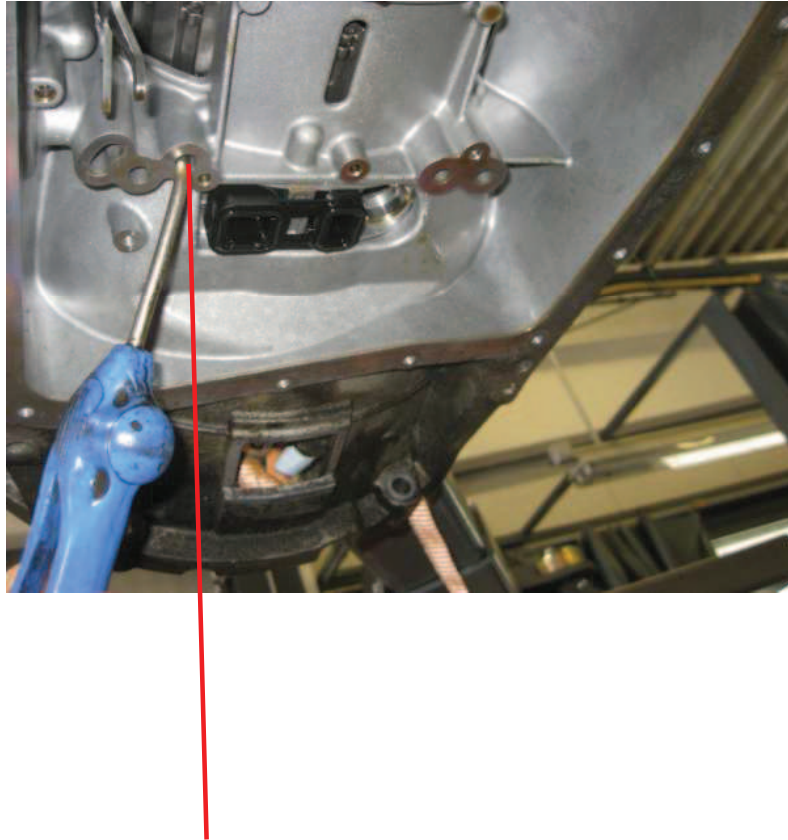



Check clutches and brakes



Dismounted Mechatronic (E shift)



*Transmission
External ZF training*



Demounting the electronic module

-  Bolts M5 (electronic module to hydraulic module), 6x
-  Bolts M6 (Mechatronik, complete to gearbox housing), 10x
-  Bolts M5 (hydraulic module), 18x

Demounting the electronic module

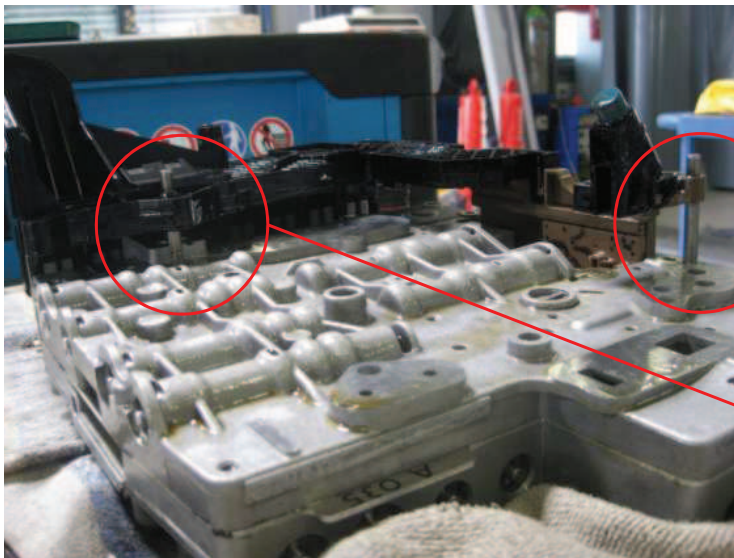

Guiding pins



Opening the Mechatronic

Opening the Mechatronic

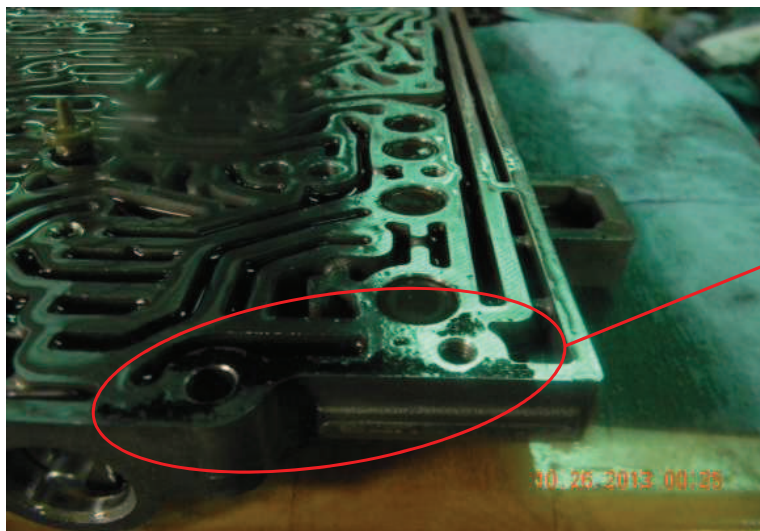
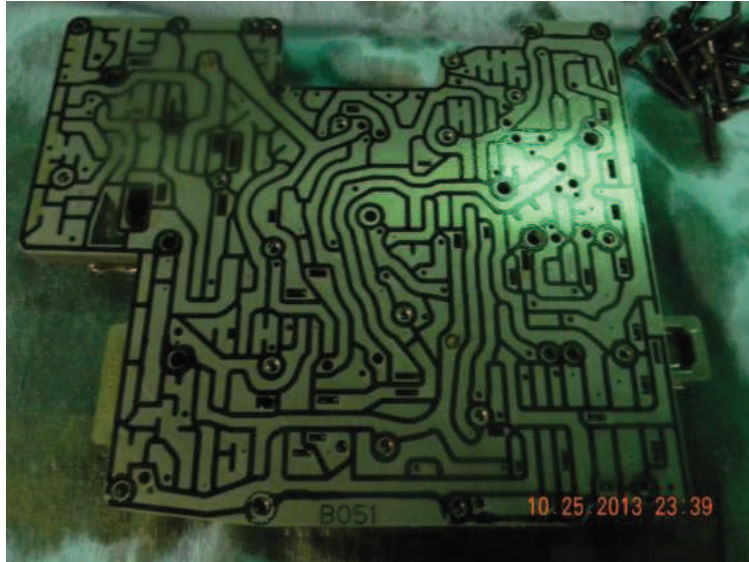

Rubber
contamination

Please clean it!!!

Position of the Check Balls (M-shift)

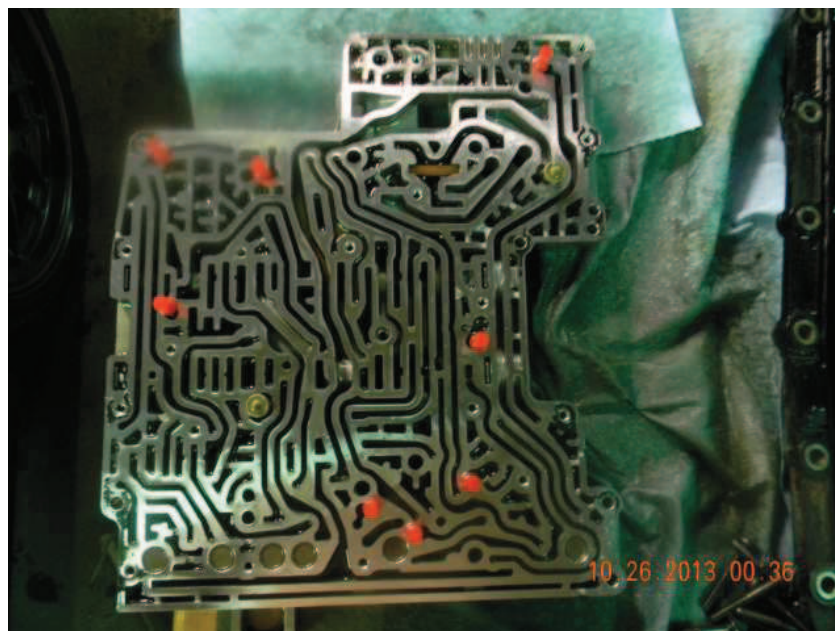
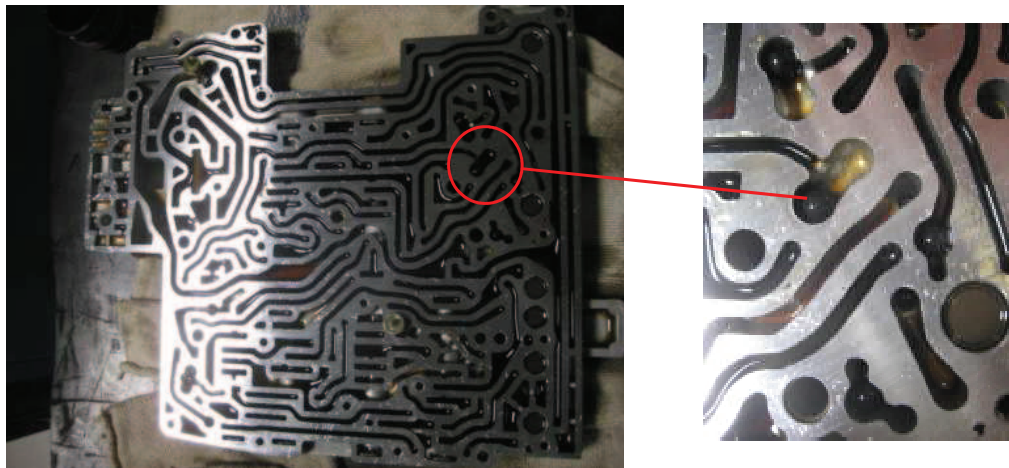

Opened Mechatronic

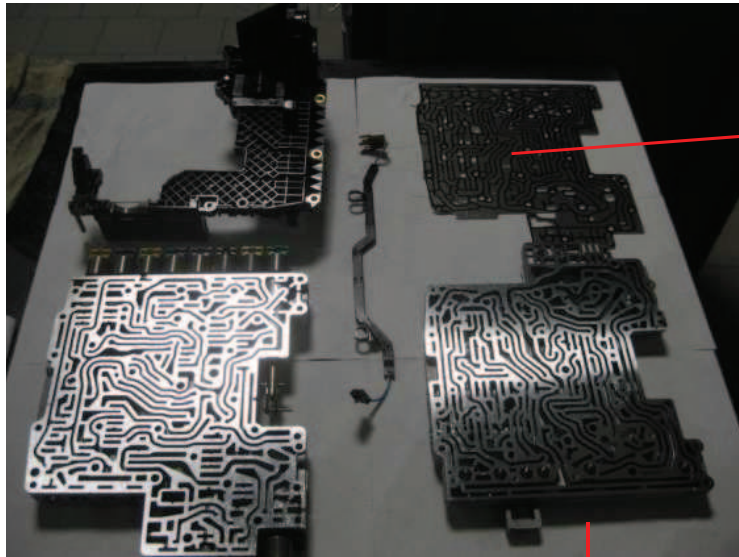

Intermediate plate



Pressure regulator damper

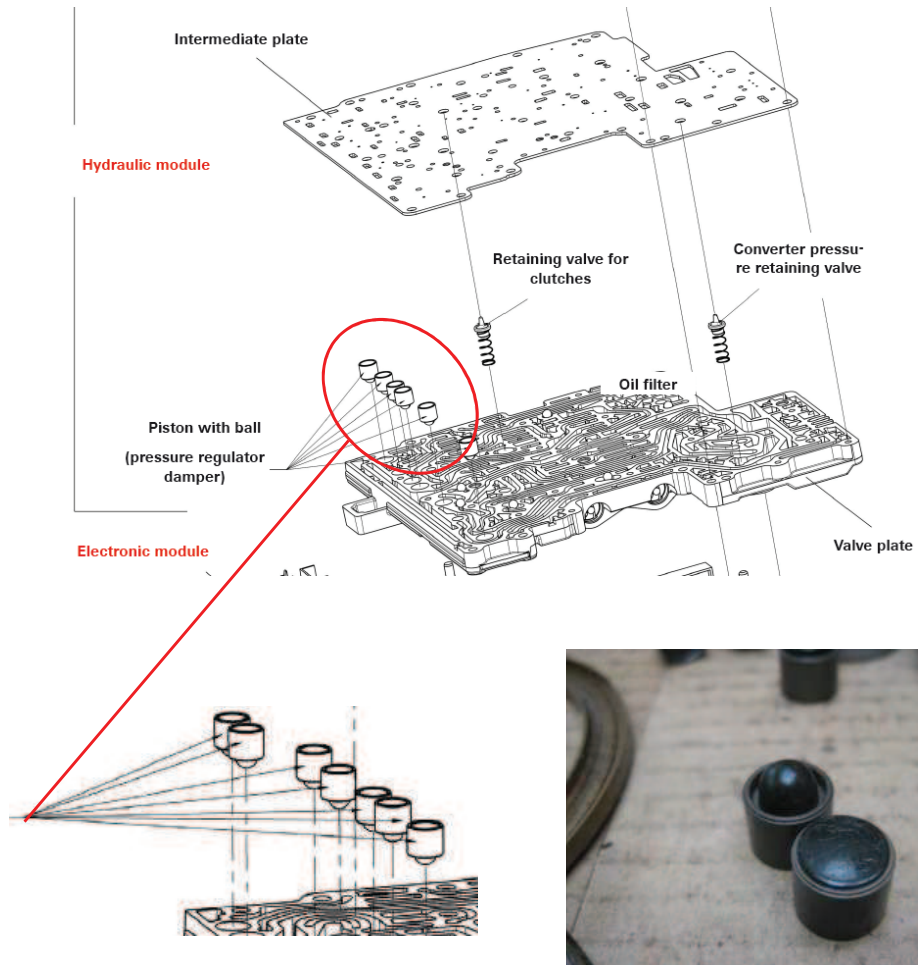

Pressure regulator damper

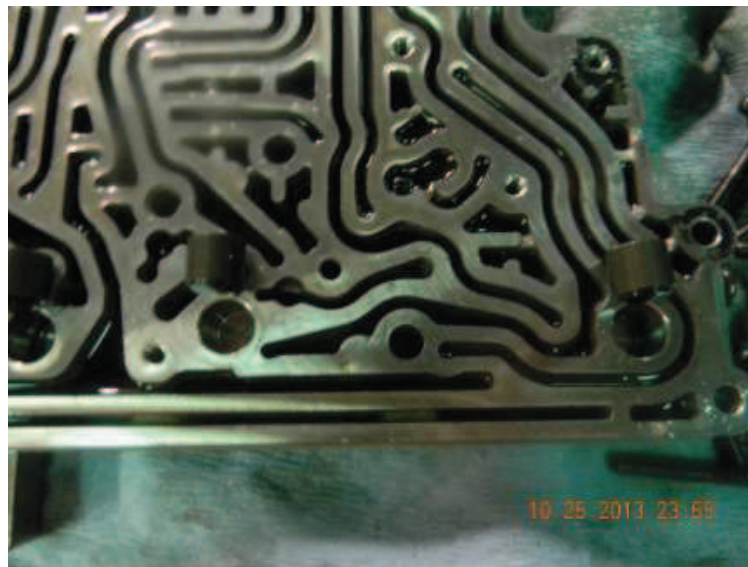

Pressure regulator damper

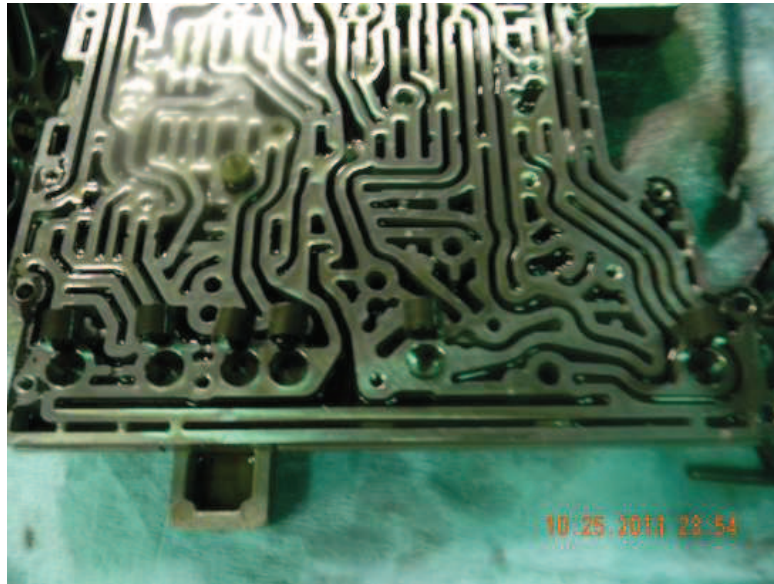

Attach the Mechatronic to the Housing of the Gearbox

M-shift

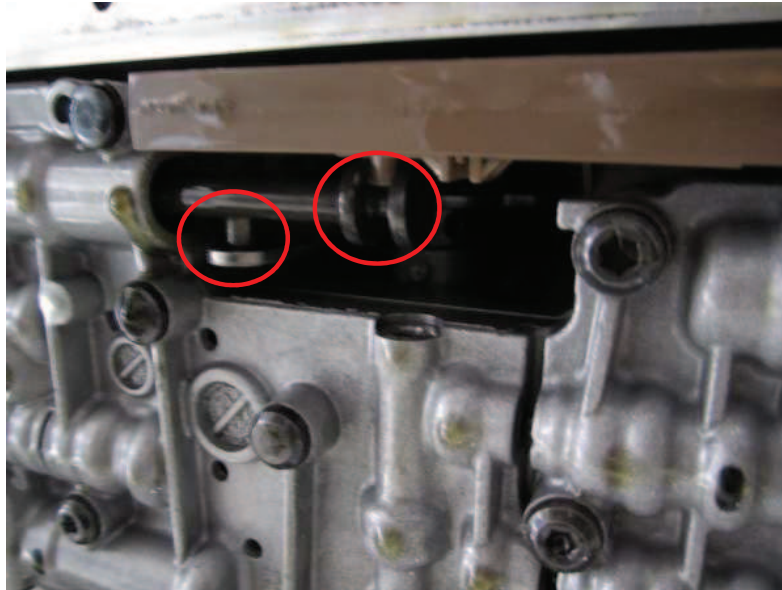

When mounting the mechatronic take care of the sensor for drive position. The picture shows a **not correctly installed** mechanism which would cause an error in the control unit. In this condition the car will not start.

Mechatronic Tightening Sequence

Torque to 8Nm

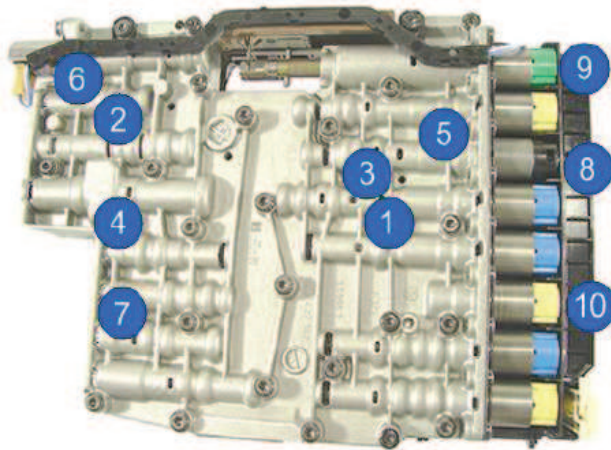
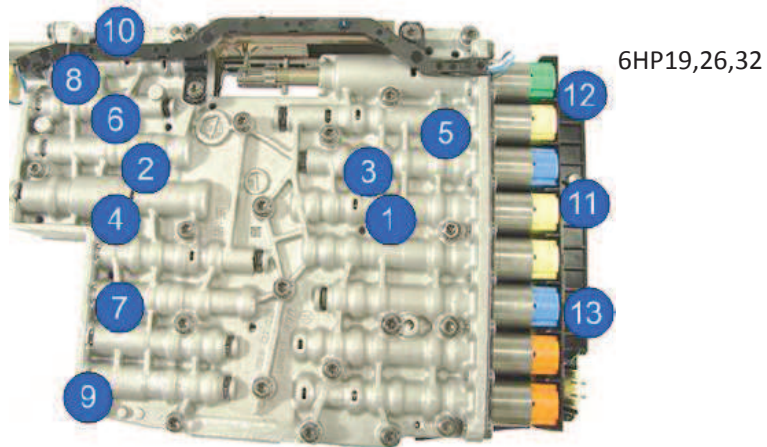

Mounting Connection Socket

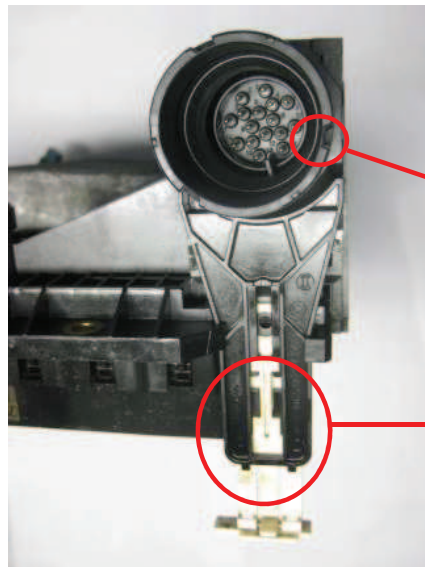

Take care that the marked guide lug is mounted not exactly in vertical position

For orientation use the outside of the socket where the guidance for the plug is almost in horizontal position

After correct fitting close the locking mechanism carefully

Oil Change

Lifeguard Fluid 5 (yellow-red)



Used for:

- 5HP18 (depending on manufacturer)
- 5HP19
- 5HP24
- 5HP30 (depending on manufacturer)

Lifeguard Fluid 6 (yellow)

Used for

- 6HP19
- 6HP19X
(except Audi Q7)
- 6HP/21/26/28 + X
- 6HP26A61
(except Audi W12)
- 6HP28A61
- 6HP32 + X, 6HP32A



Lifeguard Fluid 8 (green)



Used for

- 6HP19A
- 6HP19X (Audi Q7)
- 6HP28AF
- 8HP all



Fill in screw

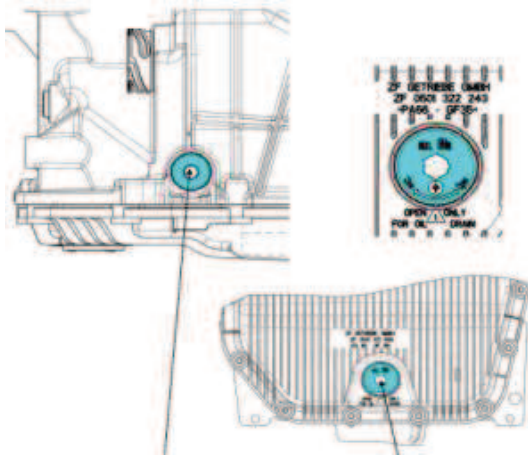

BMW, Jaguar, Ford, Maserati,
Hyundai, Land Rover, Aston Martin,
Rolls Royce, Bentley

For:
6 HP 19/19X/26/26X/32/21/28/28X



Fill in screw (Audi)

- Engine rpm 750 1/min
- Gearbox temperature between 35 and 40 °

Oil level control (Audi)

- Gearbox temperature 35°
- Start engine
- Take screw B out
- Screw worn
- No fluid coming

fill up until ATF runs down

Bolted driveshaft

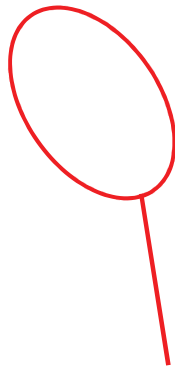

6 HP Automatic Transmissions Overhaul

Overhaul - introduction

Since the introduction of the 5HP series, ZF has aimed for a simplistic and streamlined design. Although the 6HP and the new 8HP series are extremely sophisticated and a technologically advanced, they are also smaller and lighter than the predecessors.

The 5HP introduced a simple 3 part design:

- Input, intermediate brake and output.

The 6HP is no exception. Half of the reaction components are comprised and housed within the input section. Two brakes and a Ravigneaux planetary make up the other two reaction components.

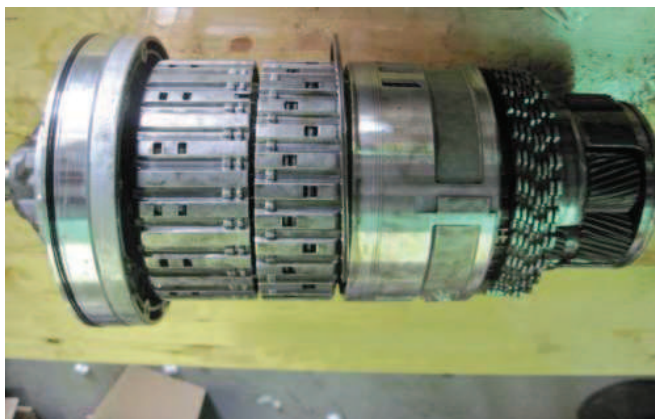

Transmission
External ZF training



Input section – Oil pump

Front cover housing contains:

- Oil pump
- Torque converter stator support
- Single planetary's Sun gear support
- Oil passages for TCC apply and release

Input shaft

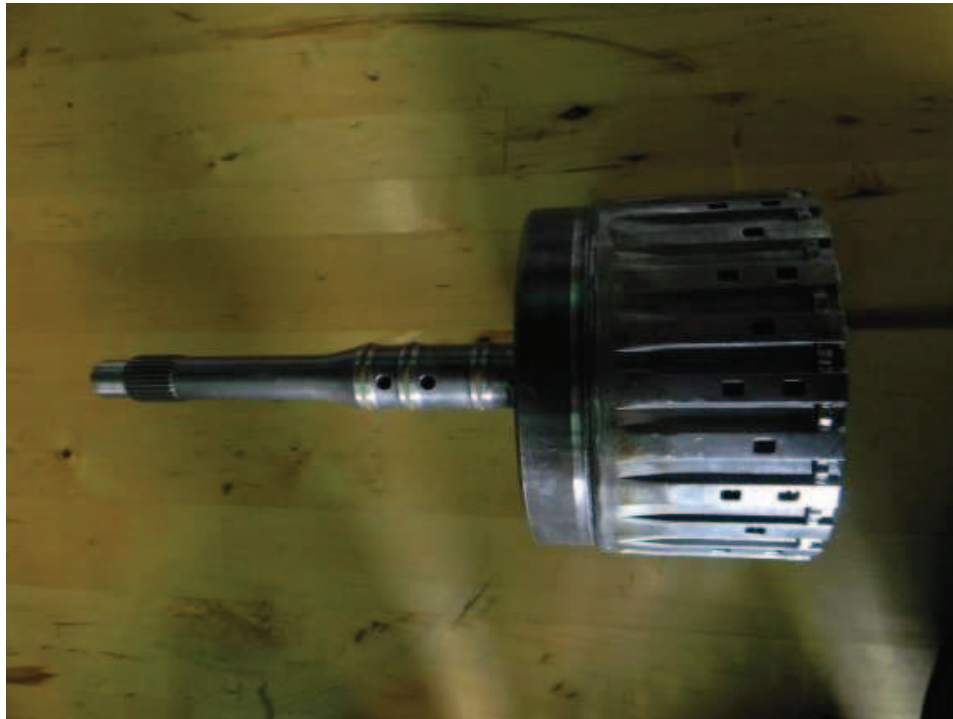

Input shaft contains:

- E Clutch
- Passage for TCC
- Passage for E clutch
- Single planetary ring gear
- Turbine splines

Intermediate shaft



Intermediate shaft connects:

- E clutch friction plates to Ravigneaux planetary carrier

Clutch A



A clutch houses:

- Single planetary gear set carrier and planets

Sun gear shaft

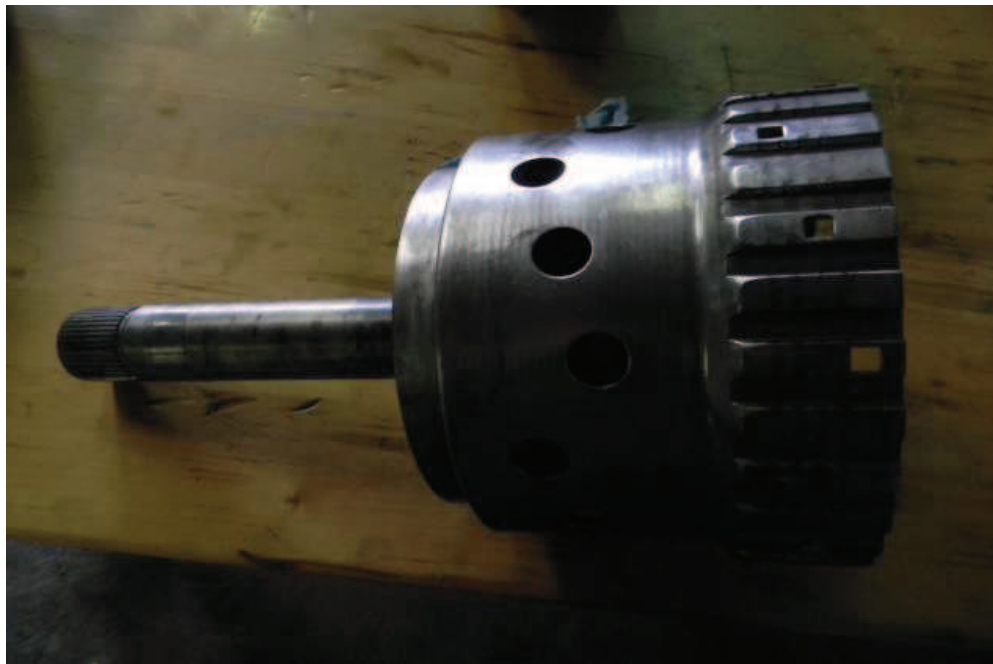

Sun gear shaft contains:

- Engages A clutch friction plates
- Splines into Sun Gear 3

Disc carrier



Disc Carrier contains:

- Meshes with clutch A drum
- Friction plates of clutch B

Clutch B

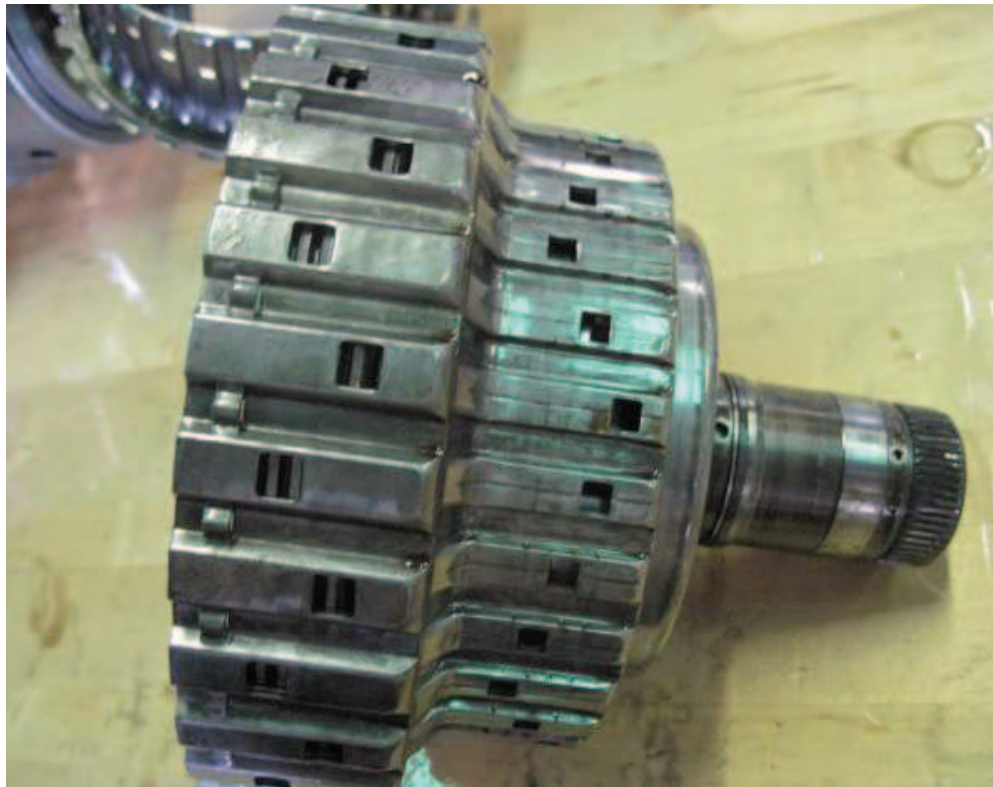

Clutch B contains:

- Engages with Brake C friction plates
- Splines into Sun Gear 2

Assembled

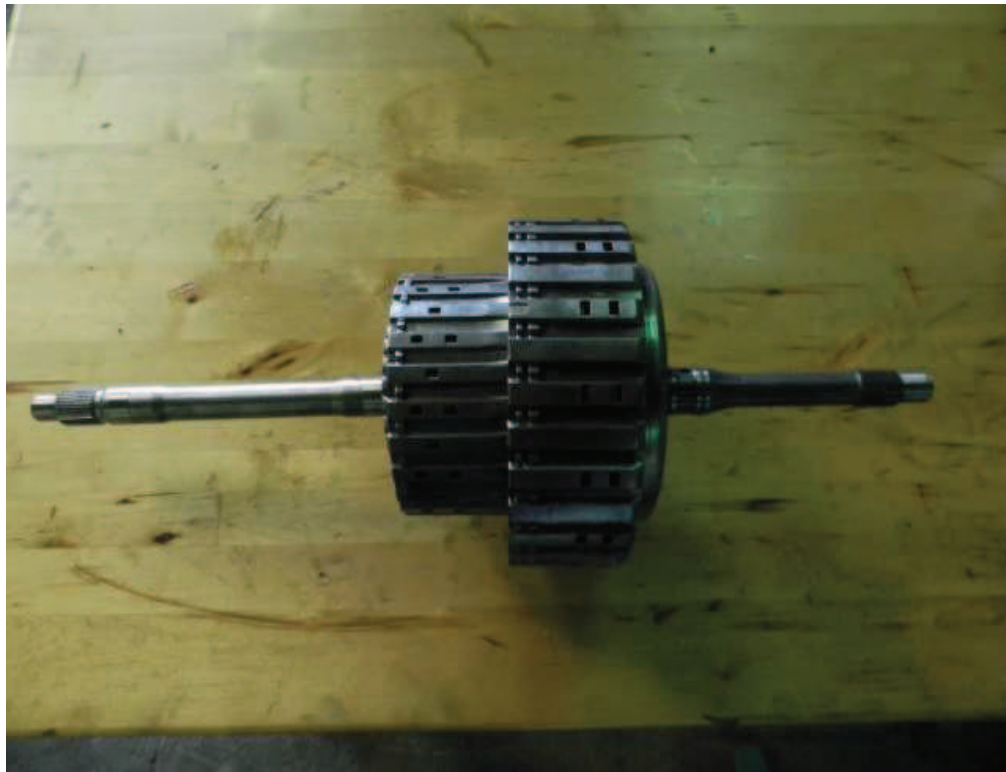

Input shaft, clutch A, clutch E and Intermediate shaft assembled

Assembled

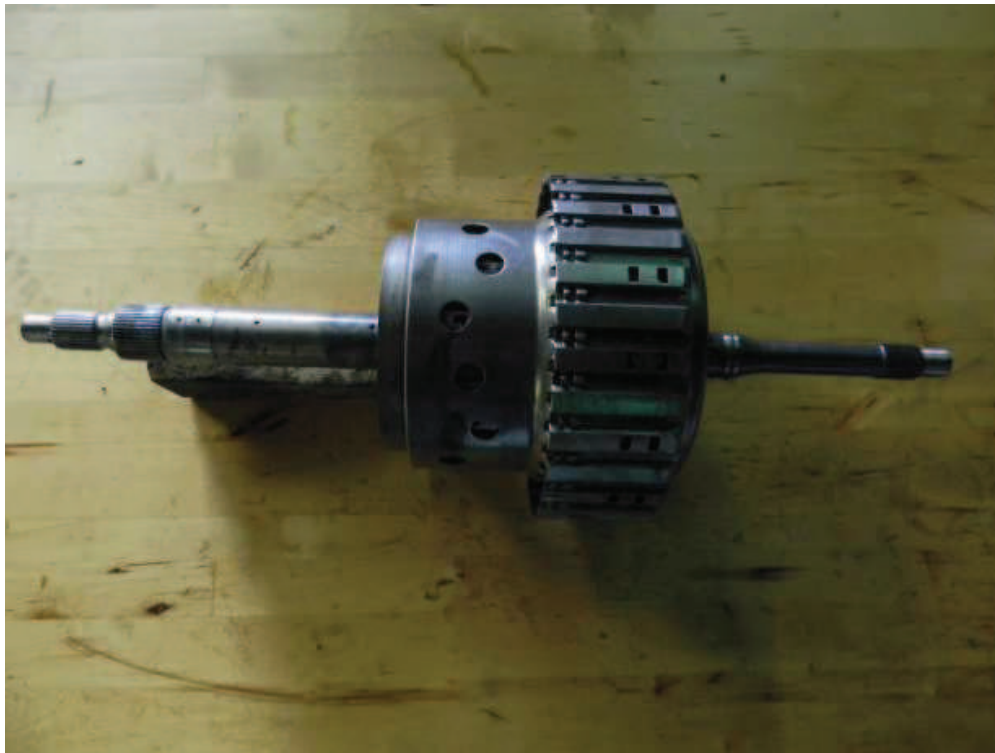

Sun Gear shaft added to previous assembly

Assembled

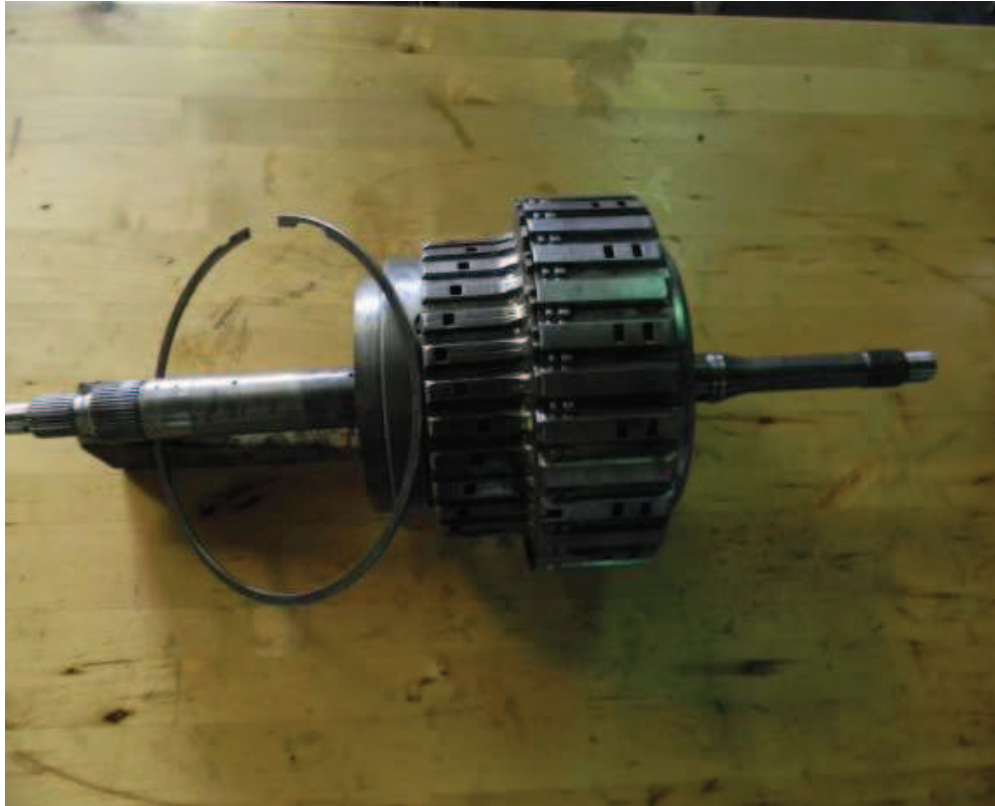

Complete Input assembly

Intermediate Brakes

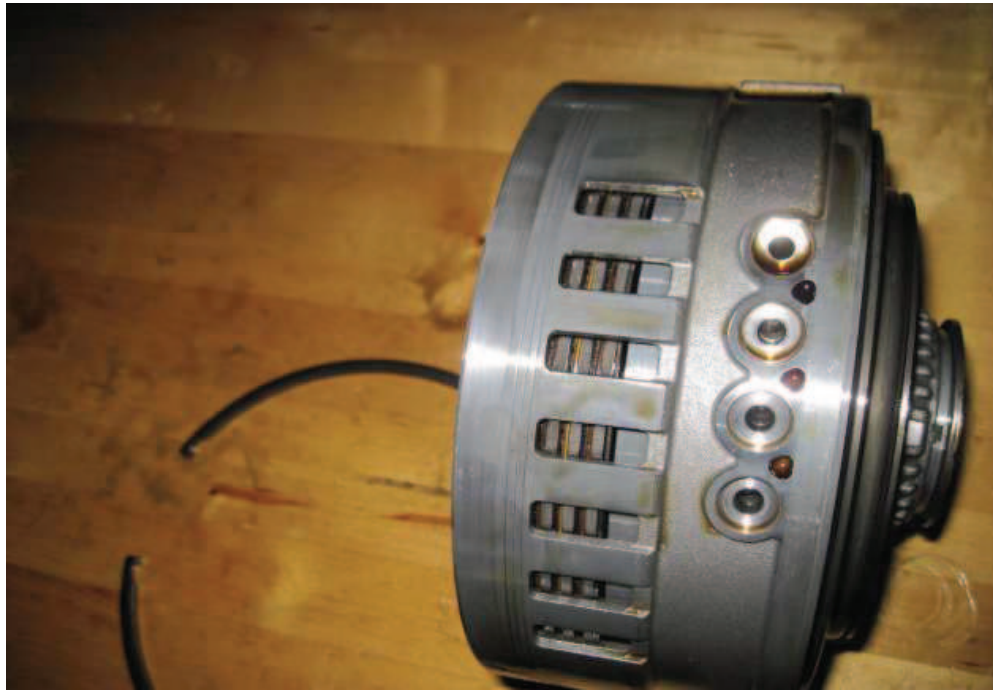

C and D assembly contains:

- C Brake
- D Brake
- Passages for C and D brakes
- Passage for B clutch

Output components



Ravigneaux planetary gear set and D brake frictions and steels

Assembled

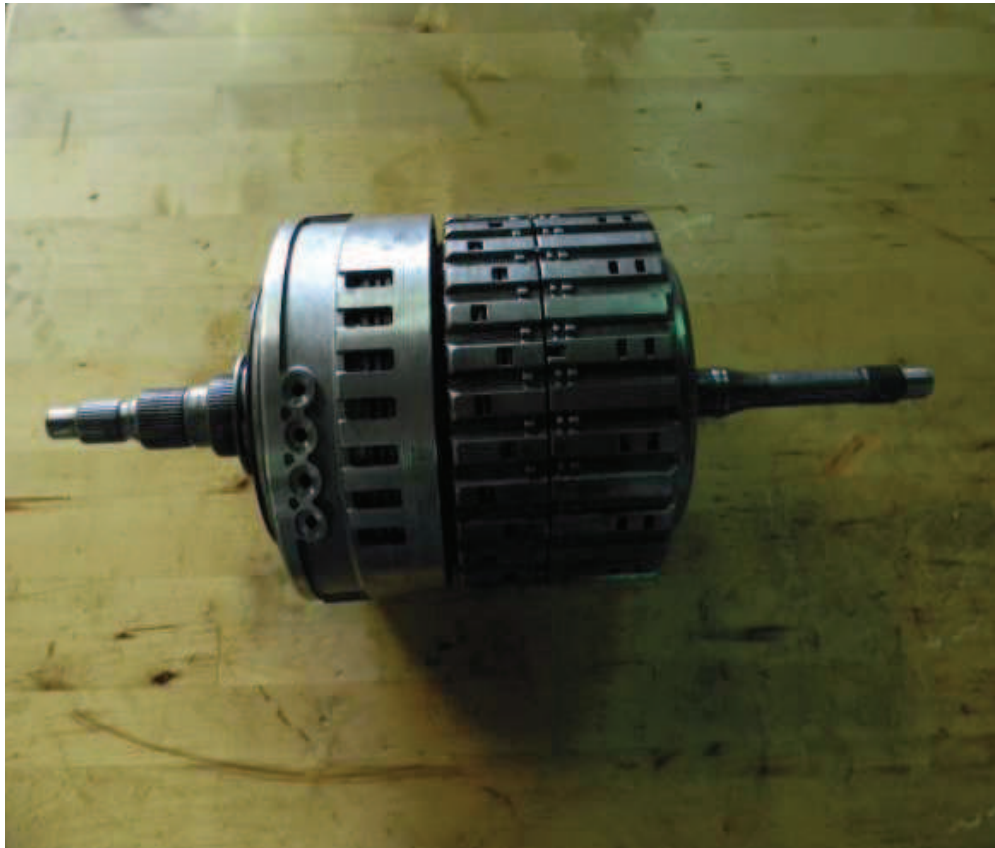

Input assembly and intermediate assembly (C brake)

Assembled

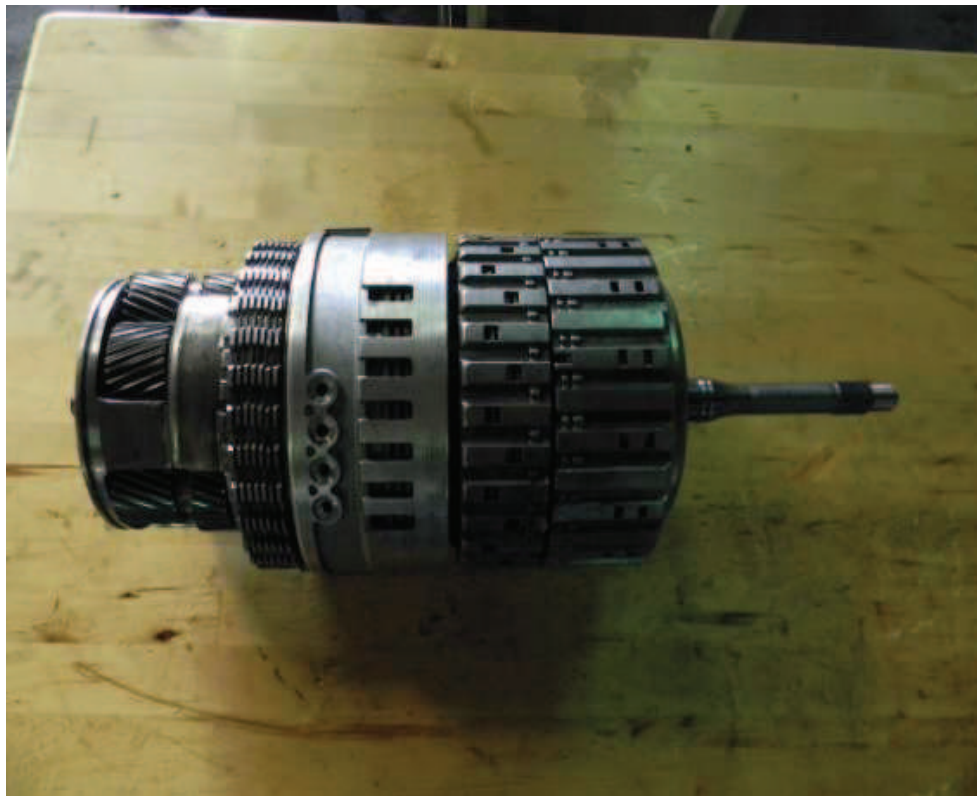

D brake and Ravigneaux planetary added to previous assembly

A Clutch disassemble

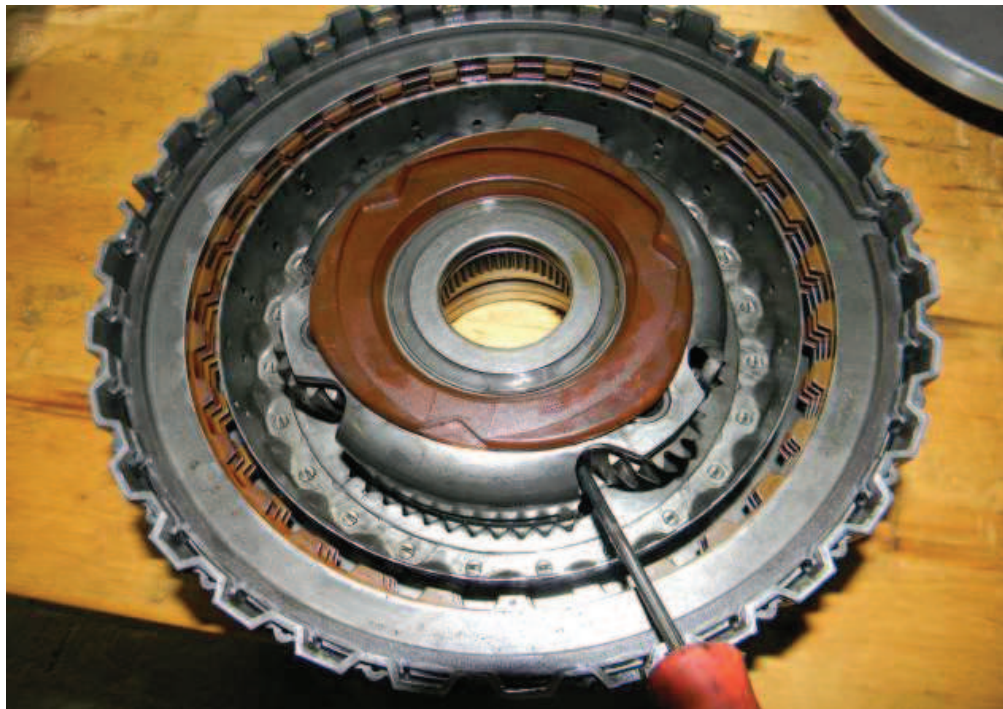

Clutch A is the most unconventional assembly to disassemble. In order to remove the piston, the single planetary gear set has to be removed from the drum. Underneath the planets and towards the center of the carrier lies a snap ring that holds the planetary carrier to the drum. Push slightly towards the center and at the same time lift the carrier.

Disassemble

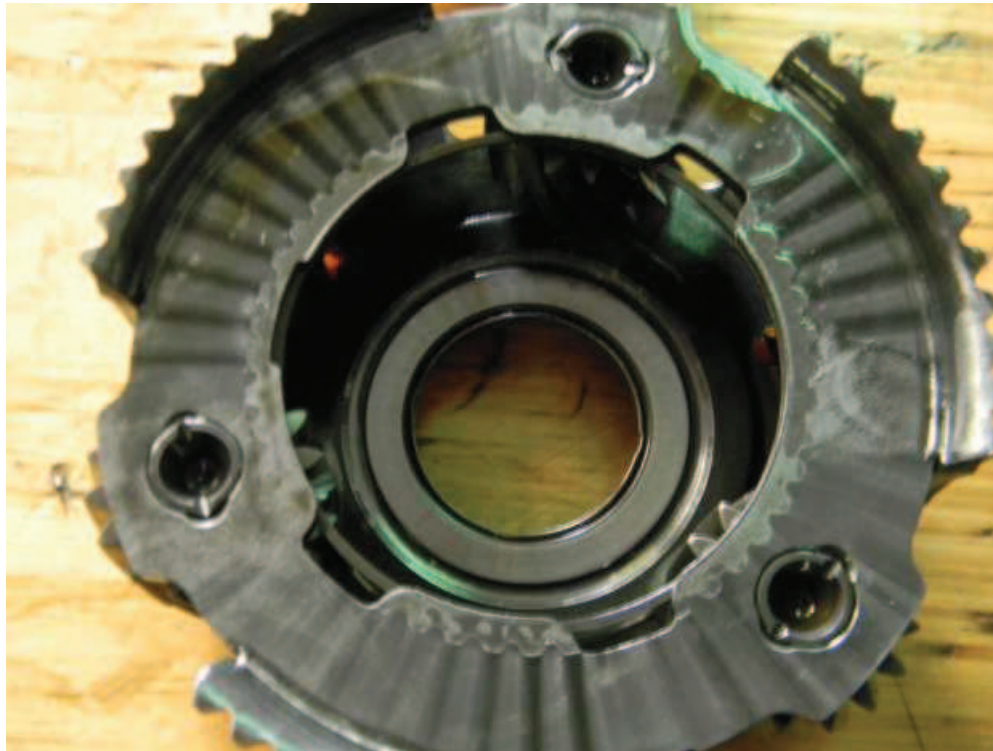

Snap ring can be seen at the four openings in the carrier, right above the planets.

Disassemble



Once the carrier is removed the tabs can be seen

E clutch failure



Most common fault code / failure is for E clutch.
Quite often due to pressure losses at front pump bushing.

Oil pressure is fed through front cover (pump) through input shaft's third port. Unfortunately there's only 1 Teflon ring that seals the input shaft to the pump. The other end of this chamber is sealed by the interference of the shaft and the bushing.

As the bushing wears the clearances become too large and pressure is lost beyond the point of adaptations.

Mechatronics' Separator failure



More often than E clutch failure is the separator, double D, failure. Stress, heat cycles and environmental conditions causes the separator to develop small to obviously large cracks and the rubber seals at the end to shrink or get hard and brittle.

Any of these conditions will cause a working or main pressure loss. These losses are reflected as adaptation faults, delayed gear engagement and, in the E Mechatronics' version, as a parking fault. Along with the separator seal, the 4 ports seals are also prone to shrinking and failure. All of these parts should be replaced.



8 HP Automatic Transmissions

Modular construction system



Torque converter

Sealing gearbox input shaft

ATF-Oil pump

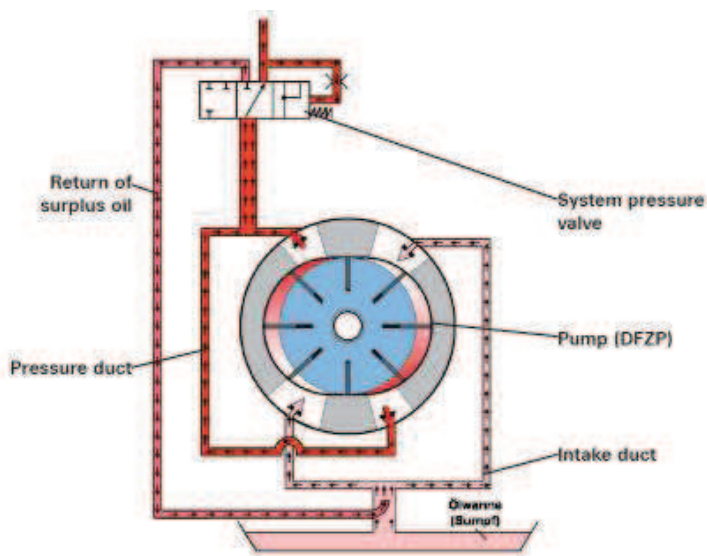

data:
m pressure 5.5 to 17.5 bar
elivery rate 7 to 22 l/min
p speed 550 to 8600 rpm



ATF-Cooling

E-shift Mechatronic (Audi)

Parking brake emergency release (Audi)



Parking brake emergency release lever (Audi – under driver seat)

Parking brake emergency release (BMW)

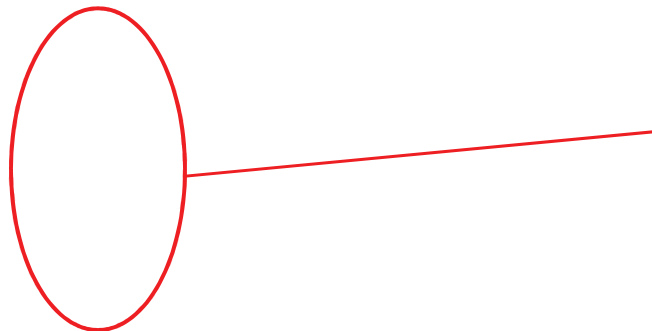

Shift elements Brake B

B is controlled by two pistons

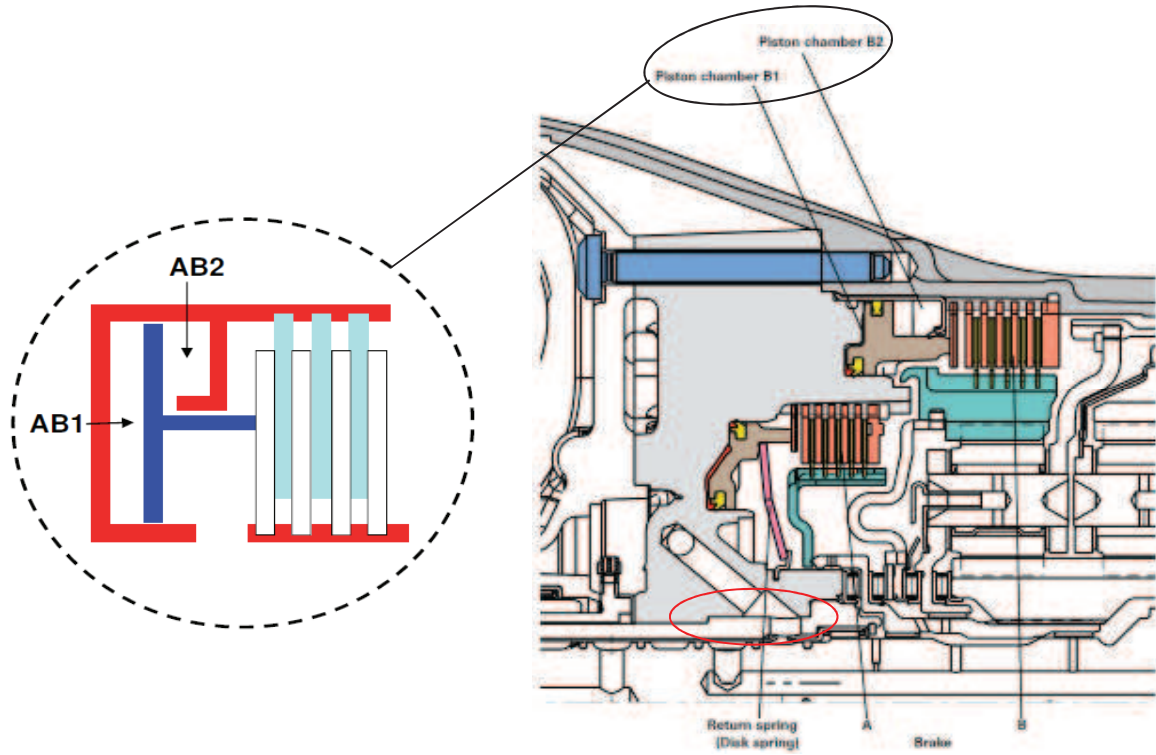

Clutch C, D and E

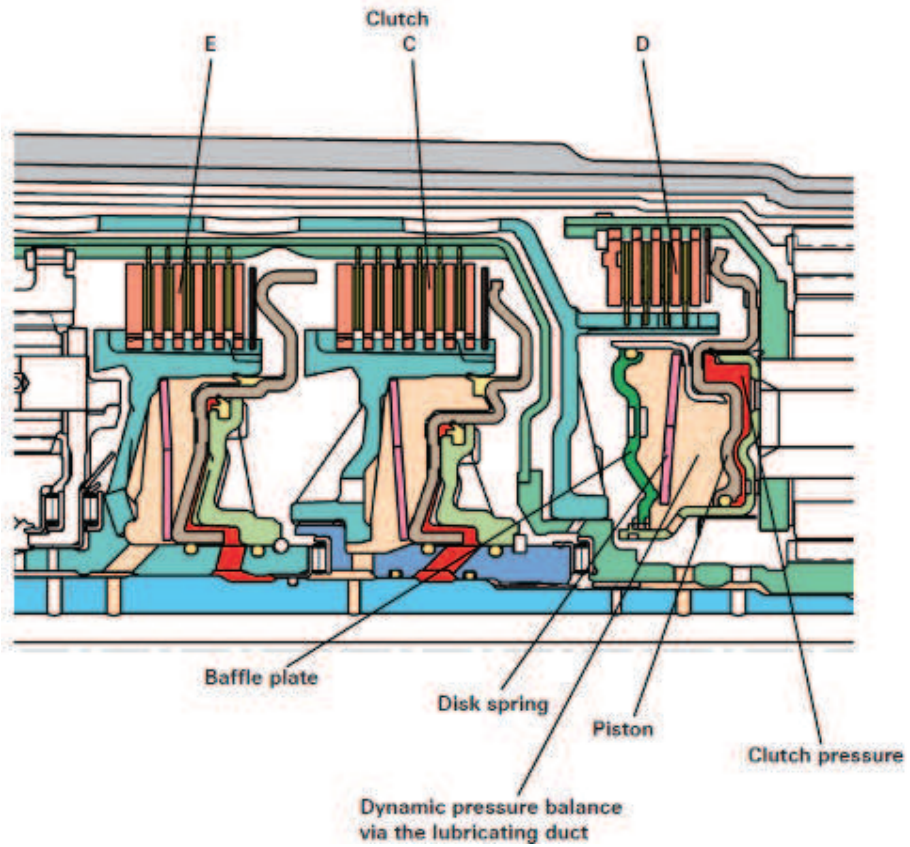



Planetary Gear sets / Shift elements

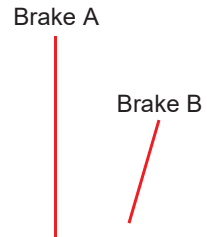

Clutch E

Clutch C

Clutch D

Gear description in 1st gear

In 1st gear, internal ring gear H1 is fixed by the multidisc brake B and the double sun gear S1/S2 via the multidisc brake A against the housing (blocking position on planetary gear train RS1).

The connection of the planet carrier P1 and internal ring gear H4 means that this internal ring gear is also fixed.

The drive shaft provides the driving force via the closed multidisc clutch C to the sun gear S4. This drives sun gear S4 at the same speed as the turbine.

The fixed internal ring gear H4 means that the planetary gears under the internal ring gear turn and drive the planet carrier P4 in the direction of engine rotation.

Planet carrier P4 also acts as the output shaft.

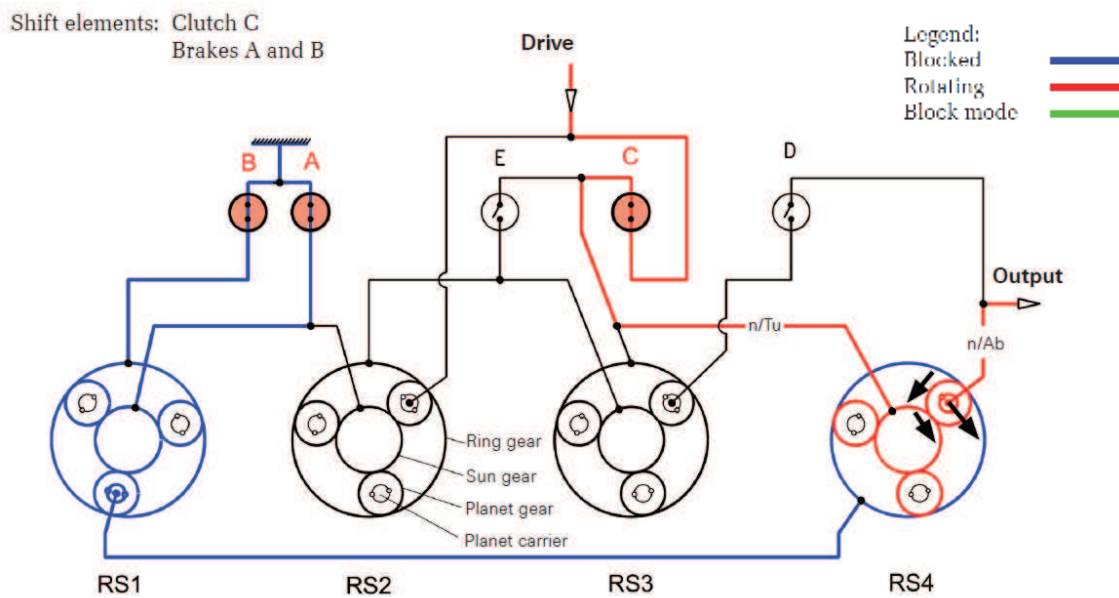



Gear description in 2nd gear

In 2nd gear, internal ring gear H1 is fixed by the multidisc brake B and the double sun gear S1/S2 via the multidisc brake A against the housing (blocking position on planetary gear train RS1).

The connection of the planet carrier P1 and internal ring gear H4 means that this gear is also fixed.

The drive shaft provides the driving force which drives the planet carrier P2 at the same speed as the turbine.

This rolls over the fixed double sun gear S1/S2. This drives the internal ring gear H2 in the direction of engine rotation which in turn drives the sun gear S4 via the closed multidisc clutch E.

The fixed internal ring gear H4 means that the planetary gears under the internal ring gear turn and drive the planet carrier P4 in the direction of engine rotation.

Planet carrier P4 also acts as the output shaft.

Gear description in 3rd gear

In 3rd gear the internal ring gear H1 is fixed against the housing by multidisc brake B.

The drive shaft provides the driving force to the planet carrier P2 and via the closed multidisc clutch C to the sun gear S4. Both are driven at the same speed as the turbine.

The closed multidisc clutch E connects sun gear S4 and internal ring gear H2 and drives them at the same speed in the direction of engine rotation (block mode on planet gear set RS2).

The block position on planetary gear train RS2 means that the double sun gear S1/S2 can drive the planetary gears 1 at the same speed as the turbine which makes them roll under the fixed internal ring gear H1.

This drives planet carrier P1 at lower speed in the direction of engine rotation. The fixed connection between planet carrier P1 and internal ring gear H4 produces the same direction of rotation and speed at internal ring gear H4.

Sun gear S4 drives at the same speed as the turbine which means that planet carrier P4 experiences an increase in speed compared to 2nd gear.

Planet carrier P4 also acts as the output shaft.

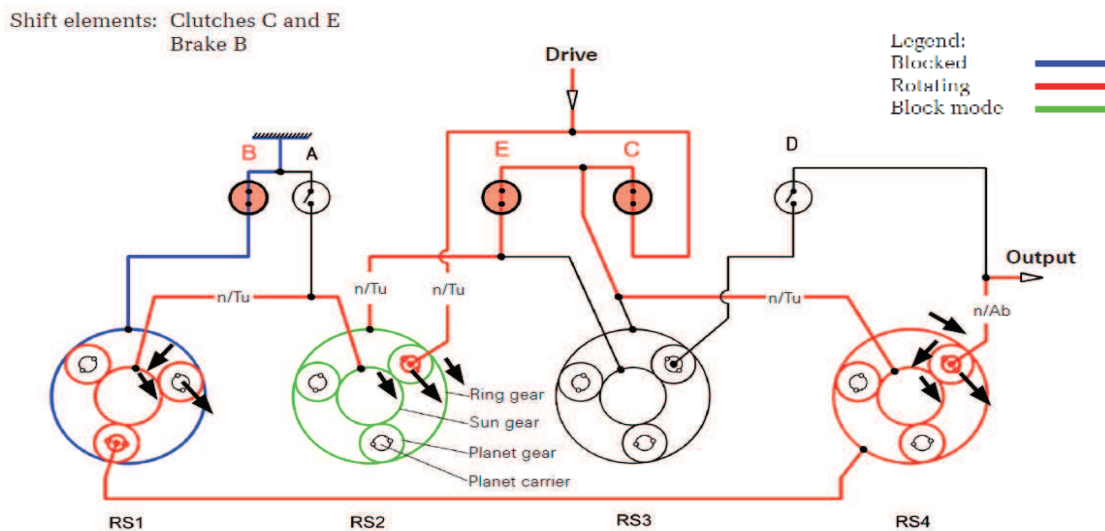

Gear description in 4th gear

In 4th gear the internal ring gear H1 is fixed against the housing by multidisc brake B.

The closed multidisc clutch E short circuits internal gear H3 and sun gear S3 on the planetary gear train RS3 which produces block mode on planetary gear train RS3.

The closed clutch D produces a fixed connection between planet carrier P3 and the output shaft. This means that planetary gear train RS3 is driven in full at output speed in the same direction as the engine.

The fixed connection of internal ring gear H3 and sun gear S4 and between sun gear S3 and internal ring gear H2 means that internal ring gear H2 and sun gear S4 are also driven at output speed.

The drive shaft provides the driving force to planet carrier P2 which rolls under the internal ring gear H2 which rotates at output speed.

The double sun gear S1/S2 is driven accordingly at the speed of planetary gears 2 which means that planetary gears 1 roll under the fixed internal ring gear H1 and drive the planet carrier P1 in the same direction as the engine.

The planetary gear train RS4 is locked against the output shaft by the connection of the sun gear S and the planet carrier P4. This produces block mode on planetary gear train RS4. The planet carrier P1 is firmly connected to internal ring gear H4 which means that the planetary gear train is driven as a block.

Planet carrier P4 also acts as the output shaft.

Shift elements: Clutches D and E
Brake B

Legend:
Blocked —
Rotating —
Block mode —

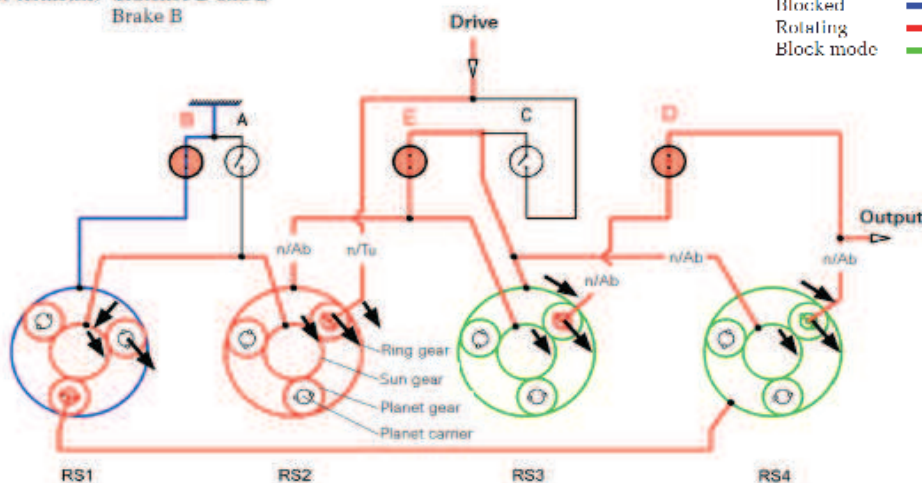

Gear description in 5th gear

In 5th gear the internal ring gear H1 is fixed against the housing by multidisc brake B. The drive shaft provides the driving force to the planet carrier P2 and via the closed multidisc clutch C to the internal ring gear H3 and sun gear S4.

Planet carrier P2, internal ring gear H3 and sun gear S4 are driven in the direction of engine rotation at the same speed as the turbine. The closed multidisc clutch D produces a fixed connection between planet carrier P3 and the output shaft. This drives the planet carrier P3 at output speed in the same direction as the engine so that it rolls under the internal ring gear H3 which is rotating at the same speed as the turbine.

Sun gear S3 is driven in the opposite direction to the engine. The fixed connection between sun gear S3 and internal ring gear H2 rotates internal ring gear H2 in the opposite direction to planet carrier P2 which is driven by the drive shaft.

The double sun gear S1/S2 is therefore driven in the same direction as the engine by planetary gears 2. This results in planetary gears 1 rolling under the fixed internal ring gear H1 and drive the planet carrier P1 in the same direction as the engine.

Internal ring gear H4 has the same speed due to its fixed connection with planet carrier P1. This produces a speed ratio on planetary gear train RS4 between the sun gear S4 turning at the same speed as the turbine and internal ring gear H4 turning at the same speed as planet carrier P1.

This speed ratio produces a resulting peripheral speed of planet carrier P4. Planet carrier P4 also acts as the output shaft.

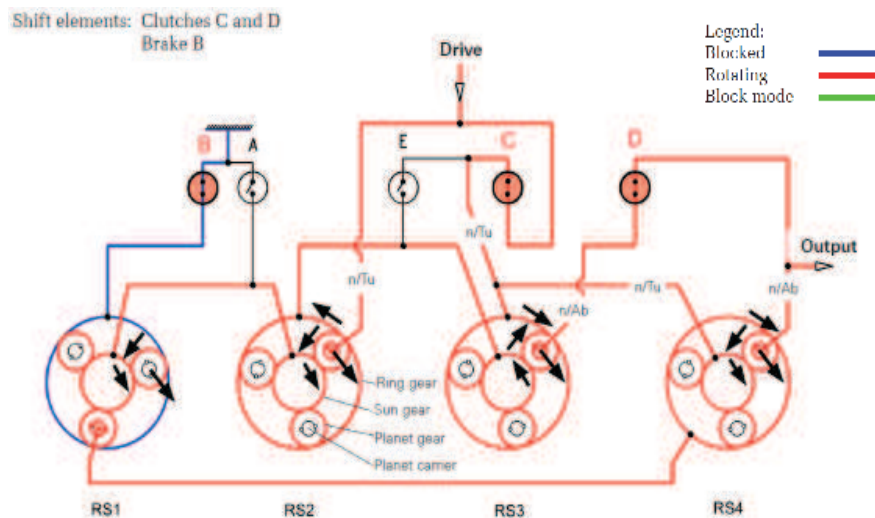

Gear description in 6th gear

The driving force from the drive shaft in 6th gear drives the closed multidisc clutches C and E. The closed multidisc clutch C initiates the propulsion of the engine into the planetary gear set.

The closed multidisc clutch E short circuits internal ring gear H3 and sun gear S3. Both of these, sun gear S3 and internal ring gear H3 are driven at the same speed as the turbine which produces block mode on planetary gear train RS3.

Planet carrier P3 is connected to planet carrier P4 by the closed multidisc clutch D. This results in the same speed in the same direction as the engine on planet carrier P4.

Planet carrier P4 also acts as the output shaft.

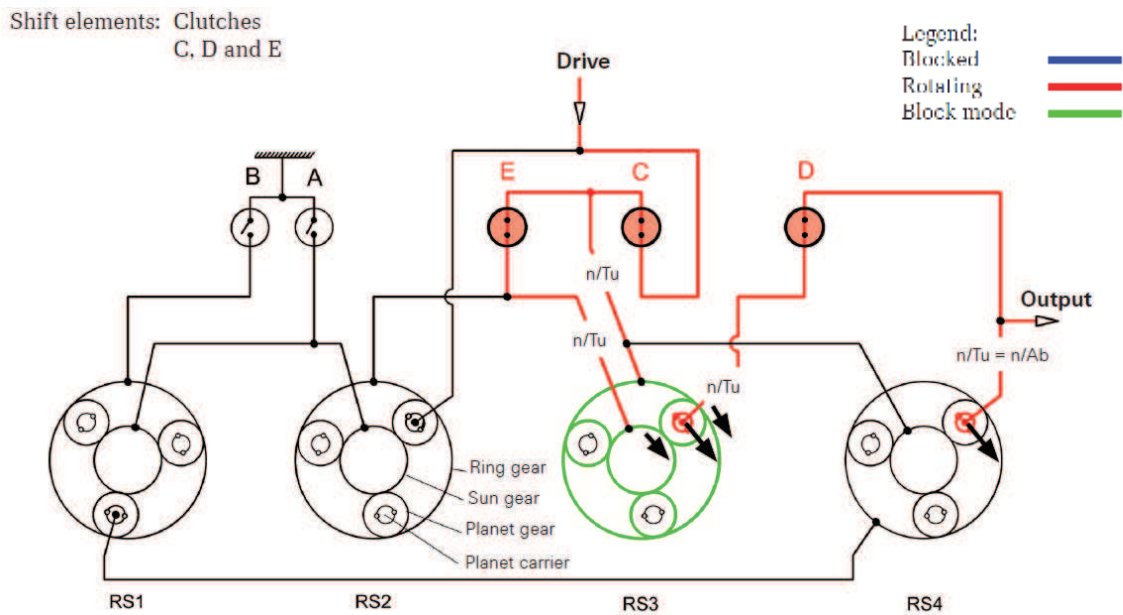

Gear description in 7th gear

In 7th gear the double sun gear S1/S2 is fixed against the transmission housing by the closed multidisc brake A.

The drive shaft provides the driving force to the planet carrier P2 and via the closed multidisc clutch C to the internal ring gear H3. Both, planet carrier P2 and internal ring gear H3, are driven at the same speed as the turbine.

As a result of driving the planet carrier P2 the planetary gears 2 roll over the fixed double sun gear S1/S2 and drive the internal ring gear H2 at the corresponding speed in the same direction as the engine.

The internal ring gear H3 drives planet carrier P3 at the same speed as the turbine and sun gear S3 at a correspondingly higher speed due to the connection with internal ring gear H2. This drives the planet carrier P3 via planetary gears 3 in the same direction as the engine.

Planet carrier P3 has a fixed connection with planet carrier P4 via the close multidisc clutch D which results in the same speed in the same direction as the engine at planet carrier P4.

Planet carrier P4 also acts as the output shaft.

Shift elements: Clutches C and D
Brake A

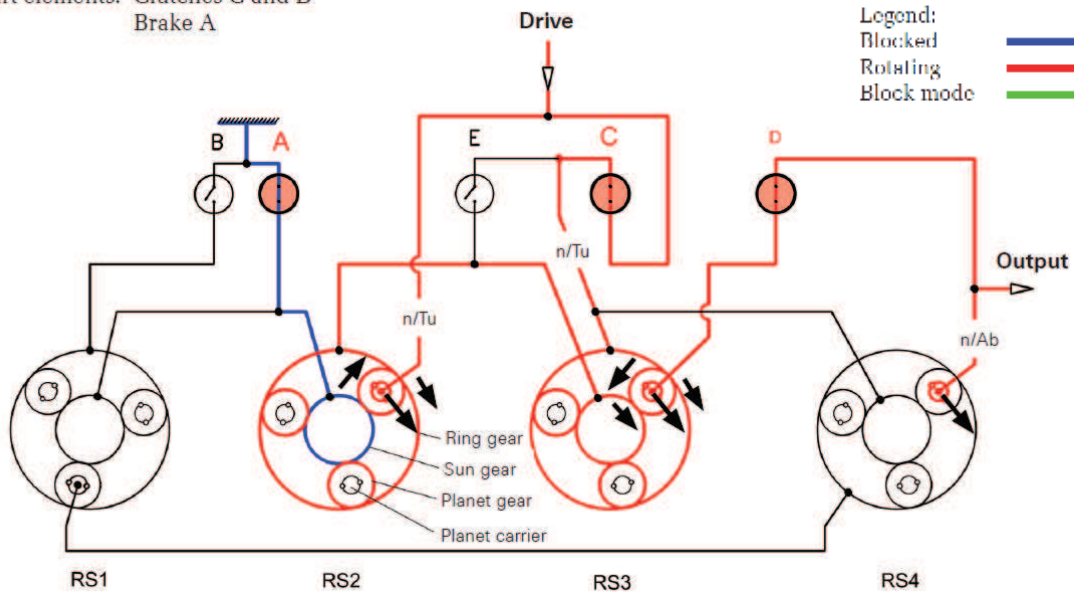

Gear description in 8th gear

In 8th gear the double sun gear S1/S2 is fixed against the transmission housing by the closed multidisc brake A.

Internal ring gear H3 and sun gear S3 are short circuited by the closed multidisc clutch E which produces block mode on planetary gear train RS3.

The drive shaft provides the drive direct to planet carrier P2. As a result of driving the planet carrier P2 the planetary gears 2 roll over the fixed double sun gear S1/S2 and drive the internal ring gear H2 at the corresponding speed in the same direction as the engine.

Internal ring gear H2 drives sun gear S3 and internal ring gear H3 via the closed multidisc clutch E (block mode on planetary gear train RS3).

Planet carrier P3 has a fixed connection with planet carrier P4 via the close multidisc clutch D which results in the same speed at planet carrier P4.

Planet carrier P4 also acts as the output shaft.

Shift elements: Clutches E and D
Brake A

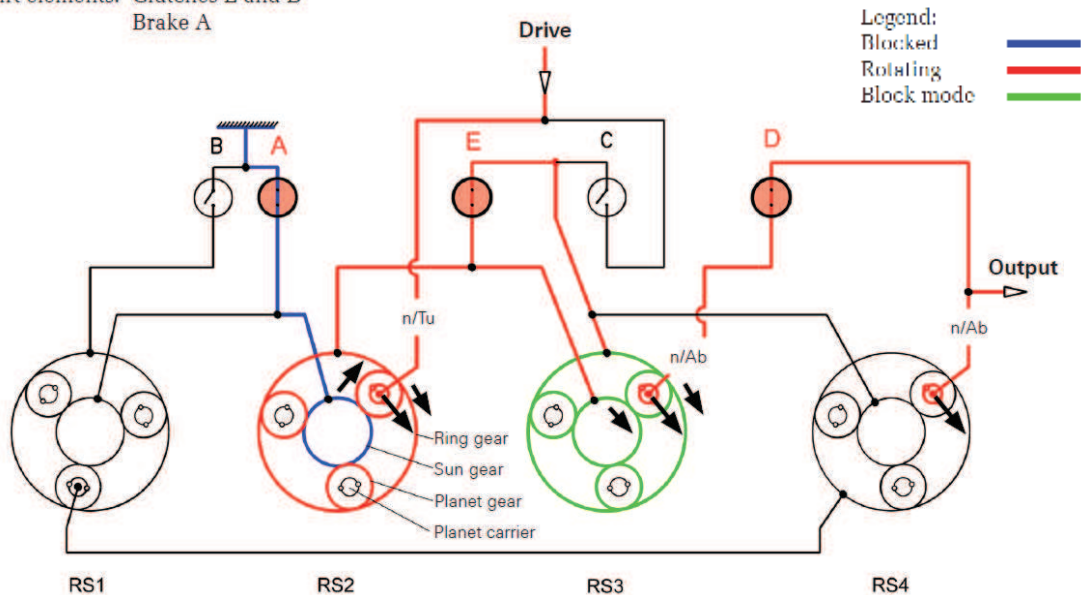

Gear description for reverse gear (R)

In reverse gear, the ring gear H1 is secured to the transmission housing using the closed multidisc brake B, and the double sun gear S1/S2 is secured to the transmission housing using the closed multidisc brake A.

The planet carrier P1 is linked with the ring gear H4 and thus is likewise secured to the housing. The planet carriers P3 and P4 are firmly linked to one another by means of the closed multidisc clutch D.

Drive takes place directly from the drive shaft to the planet carrier, whereby planetary gears 2 roll onto the stationary double sun gear S1/S2 and take the internal ring gear H2 in the direction of engine rotation.

The internal ring gear H2 and the sun gear S3 are firmly connected to one another. In this way, the sun gear 3 drives the internal ring gear H3 against the direction of engine rotation. The internal ring gear H3 is firmly connected with the sun gear S4, whereby the same rotational direction is achieved on sun gear S4.

The sun gear S4 drives the planetary gears 4 against the direction of engine rotation, which roll beneath the stationary ring gear H4 against the direction of engine rotation and take the planet carrier P4 with them.

Planet carrier P4 also acts as the output shaft.

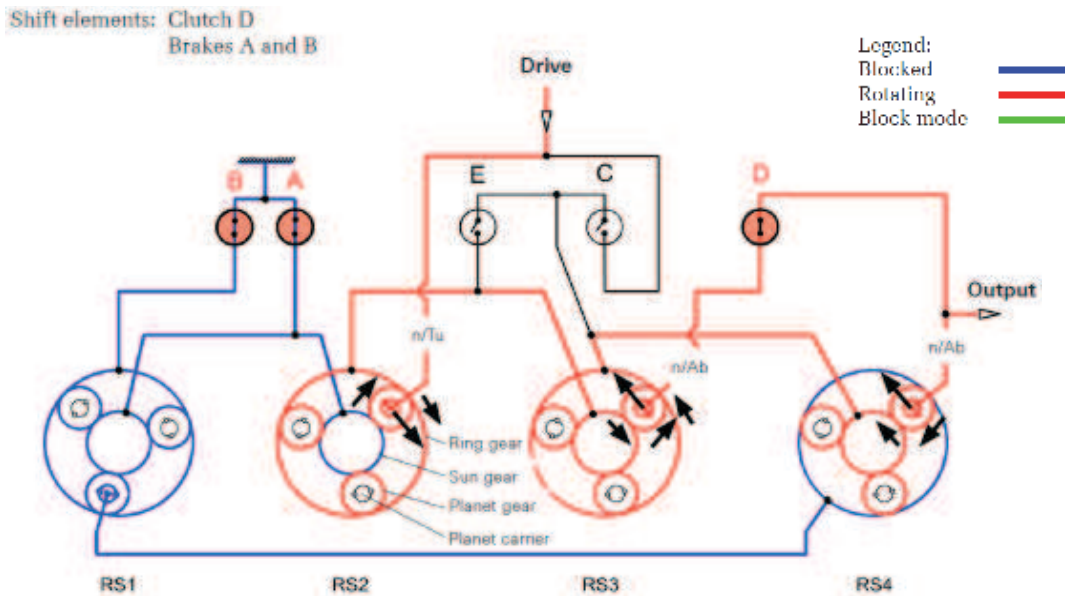



Ratio

Gear:	1.	2.	3.	4.	5.	6.	7.	8.	R
Transmission ratio:	4.7	3.13	2.1	1.67	1.29	1	0.84	0.67	R
Ratio spacing:	1.5	1.49	1.26	1.3	1.29	1.19	1.25		-3.3
Total:	7,05								

Mechatronic E-Shift

Controller Matrix E-Shift

Position	1	2	3	4	5	6	7	8
P-EDS	EDS 1	EDS 4	EDS 2	EDS 5	EDS 3	EDS 6	EDS 7	MV 1
Responsible	Brake A	Clutch D	Brake B	Clutch E	Clutch C	Cc	System p.	Solenoid v.
Character	↗	↗	↗	↗	↘	↗	↘	↖
Parking	1	0	1	0	1	0	-x-	0
Neutral	1	0	1	0	1	0	-x-	1
R-gear	1	1	1	0	1	0	-x-	1
1st gear	1	0	1	0	0	-x-	-x-	1
2nd gear	1	0	1	1	1	-x-	-x-	1
3rd gear	0	0	1	1	0	-x-	-x-	1
4th gear	0	1	1	1	1	-x-	-x-	1
5th gear	0	1	1	0	0	-x-	-x-	1
6th gear	0	1	0	1	0	-x-	-x-	1
7th gear	1	1	0	0	0	-x-	-x-	1
8th gear	1	1	0	1	1	-x-	-x-	1

 Brake closed
 Clutch closed

EDS-Types



Position of the Mechatronic pressure channel

Check clutches and brakes



Check clutches and brakes

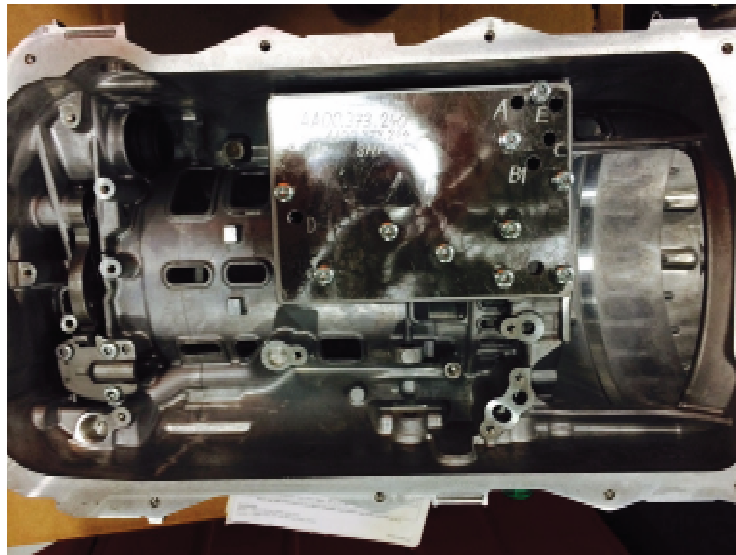

Check clutches and brakes

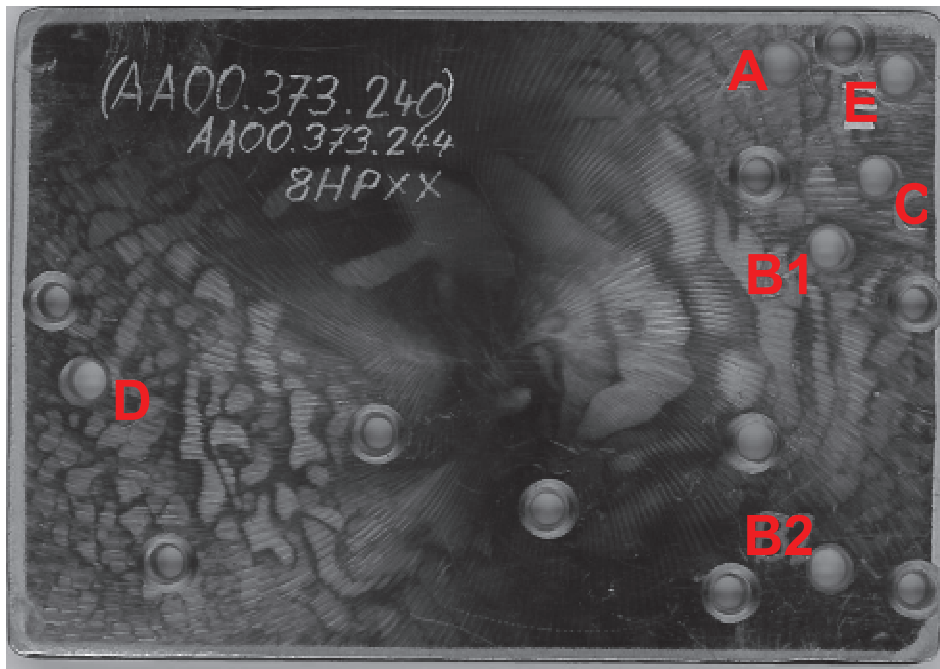



Template for the tool

Parts to changing the Mechatronic Example Audi



Parts needed

- Connection socket
- Oil reflux cartridge
- Sealing ring oil approach cartridge
- Sealing cartridge

Sealing oil pipes



Sealing cartridge



Guiding pins for mounting the mechatronic

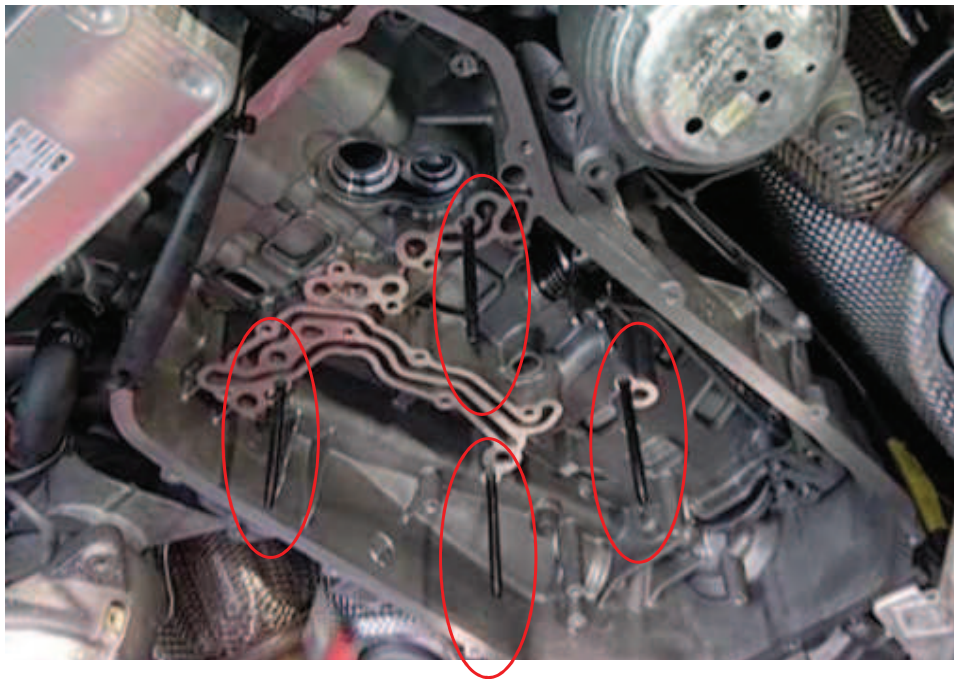

Oil level control



- Gearbox temperature 35°
- Start engine
- Take screw B out
- Screw worn
- No fluid coming fill up until ATF runs down

The hydraulic impulse oil storage – HIS

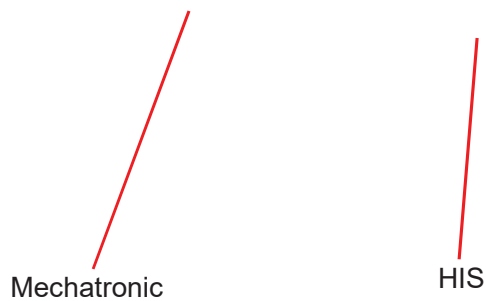

Some customer-specific versions of the new generation 8-speed automatic transmission from ZF will have an integral hydraulic impulse oil storage system.

This supplies hydraulic oil to the shift elements of the transmission required for starting. In turn this makes it possible to move off quickly if the engine has been stopped – as required for a start-stop function.

The car is ready to move away just 350 milliseconds after the engine has been started.

The hydraulic impulse oil storage – HIS

The “HIS” hydraulic impulse oil storage is a spring piston accumulator which fills with oil as the car is being driven, thus tensioning a spring.

This “reserve” has a capacity of around 100 centiliters which is fed back into the hydraulic system lightning-quick by the spring when the engine is started to supply oil to the shift elements in the transmission required for moving away.

This means that the car is ready to move away just 350 milliseconds after the engine has been started. Without the bridging created by the hydraulic impulse oil storage system this would take around 800 milliseconds which would therefore mean a perceptible loss of driving dynamics for



The hydraulic impulse oil storage – HIS

Audi plugged driveshaft

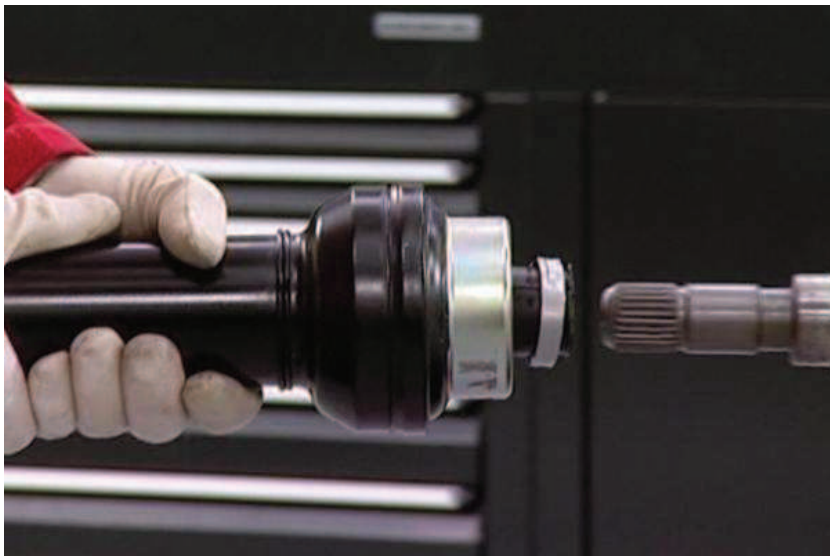
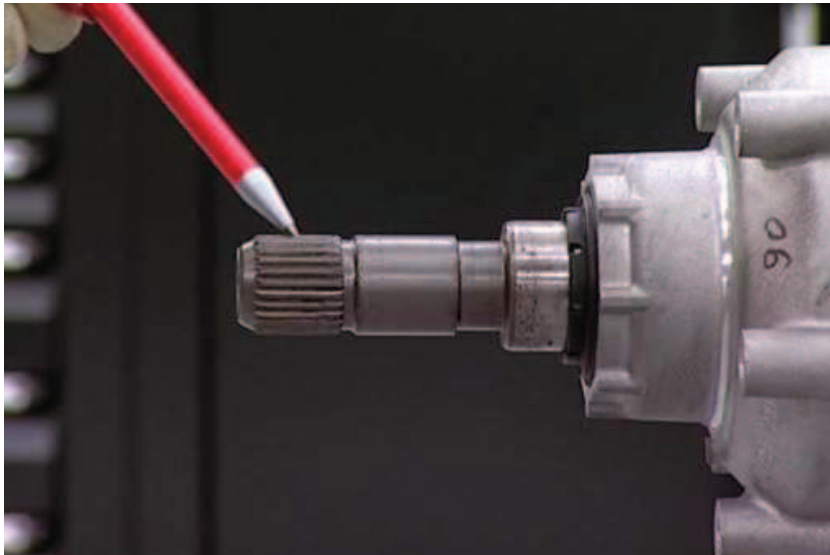

Audi plugged driveshaft

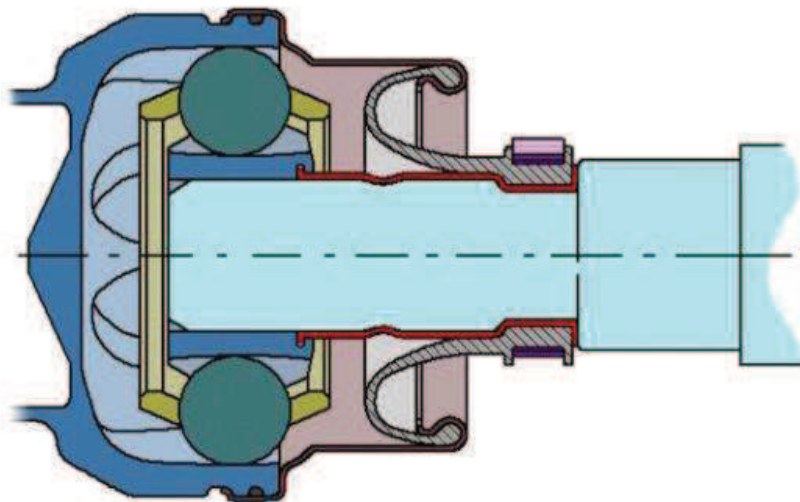



Vehicle for 8HP Transmission
BMW group



Jaguar & Land Rover

Fiat group





Troubleshooting

While freewheeling and changing from second into first gear (for example when approaching traffic lights) a kick happens.

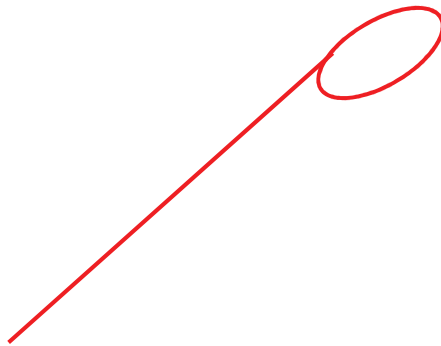

Check play on the flex disc

Towing in case of breakdown

Audi towing

The vehicle can be towed at a maximum vehicle speed of **50 km/h** over a maximum distance of **50 km** using the drive wheels. The transmission must be mechanically unlocked.

That means:

The parking lock must be released by means of a Bowden cable. The automatic transmission can be seriously damaged if the above-mentioned boundary values are not maintained.

BMW towing

The precondition for towing a vehicle with an unraised drive axle is that the parking lock be opened by means of a Bowden cable emergency release. If this is the case, towing with a maximum speed of **50 km/h** over a maximum distance of **50 km** is possible.

The automatic transmission can be seriously damaged if the above-mentioned boundary values are not maintained.

Vehicles on which the parking lock must be opened with an unlocking screw cannot be towed. In case of breakdown, the vehicle must be raised with a crane and delivered to the workshop for repair on a flatbed tow truck.

Four-wheel-driven vehicles

Vehicles with four-wheel drive must not be towed with one axle lifted.



Pushing

The engine cannot **be started** by pushing the vehicle. That is to say, if the engine is stopped, there is no transmission of power from the hydrodynamic coupling of the engine and transmission and the pressure-less shift elements.



