

# ZOOLOGY

**HIGHER SECONDARY - SECOND YEAR**

Untouchability is a sin  
Untouchability is a crime  
Untouchability is inhuman



**TAMIL NADU  
TEXTBOOK CORPORATION**

*College Road, Chennai - 600 006.*

© Government of Tamilnadu  
First Edition - 2005  
Reprint - 2006

*Chairperson*

**Prof. T. SARGUNAM STEPHEN**

P. G and Research Dept. of Zoology  
Govt. Arts College  
Nandanam, Chennai - 600 035.

**Reviewers**

**Dr. K. Vijayaraman**

Reader Head, P. G. Dept. of Zoology  
Periyar EVR Govt. Arts College  
Trichy - 620 020.

**Dr. K. Ramalingam**

Reader P.G and Research Dept. of Zoology  
Govt. Arts College, Nandanam,  
Chennai - 600 035.

**Dr. P. Daisy**

Reader and Head, Dept. of  
Zoology and Biotechnology  
Holy Cross College  
Trichy - 620 002.

**Authors**

**Tmt. Kannaki Prabakaran**

P.G.T. in Zoology  
Sri R.K.M.Sarada Vidyala Model  
Hr. Sec. School, T.Nagar, Chennai - 17.

**Dr. (Tmt) Flankit Thomas**

PGT in Zoology  
CSI Jessie Moses Mat. and Hr.Sec School  
Anna nagar, Chennai - 600 040.

**Thiru. T. Sekar**

P.G.T. in Zoology  
Govt. Girls Higher Sec School  
Choolaimedu, Chennai - 600 094.

**Thiru N. Kumaravel**

P.G.T. in Zoology  
M.F.S.D. Higher Sec.School  
Sowcarpet, Chennai - 600 079.

**Price : Rs.**

This book has been prepared by The Directorate of School  
Education on behalf of the Government of Tamilnadu.

This book has been printed on 60 GSM Paper.

## **Preface**

Biology or Life science has made rapid progress. Advancements in several fields of Science and Technology have provided the tools to understand life processes. As humanity faces several problems related to population growth, environmental degradation, energy crisis, epidemic diseases, food production and species extinctions the challenges faced by the biologists in finding appropriate solutions to such issues has become his/her sacred duty. Thus the future remedial measures for ensuring human survival and biosphere safeguarding shall require a vast army of personnel with a sound knowledge of Biology. Hence the scope for future biologists is evergrowing.

The contents of this book provide basic informations on several fields of biology that have become life supporting disciplines. The students are exposed to fascinating fields such as Human Physiology, Medicine, Microbiology, Immunology, Bio-informatics, Environmental Biology, Genomics, Aquaculture, Medical Laboratory Techniques, Livestock management etc. More information related to these fields can be obtained from appropriate websites and reference books. Contents in this book have been prepared in such a way that the students can have a glimpse of several disciplines and might help them to decide on their future career and further given study plans. Further, the materials given are technical information that provide knowledge for to-day's living.

**T. Sargunam Stephen**  
Chairperson  
Biology (Zoology)  
Text book writing committee.

## Standard XII - Zoology Syllabus - (Theory)

**I : Human physiology** - Nutrition : Introduction - Carbohydrates - Proteins - Lipids - Vitamins - Minerals - Water - Balanced diet - Calorie values (ICMR standards) - Obesity - Hyperglycemia - hypoglycemia - Malnutritions.

Digestion : Enzymes and enzyme action - Brief account of following - Dental caries - Root canal therapy - Peptic ulcer - Hernia - Appendicitis - Gall bladder stone - Liver cirrhosis - Hepatitis.

Bones and Joints (Major types) : Fractures - Dislocations - Arthritis - Rickets and osteomalacia - Orthopaedics - Gout.

Muscles : Muscle action - Muscle tone - Rigor mortis - Muscle pull (hernia) - Isometric and aserobic exercises (Body building) - Myasthenia gravis.

Respiration : Process of pulmonary respiration - Inspiration - Expiration - Exchange of gases at alveolar level - Control of respiration - Pneumonia - Pleurisy - Tuberculosis - Bronchitis - Breathing exercises

Circulation-Functioning of heart-Origin and conduction of heart beat. Artificial pacemaker-Coronary blood vessel and its significance-Myocardial infarction,Angina pectoris-Angiogram,angioplasty and coronary bipass surgery-Atherosclerosis-Heart attack-Heart block-ECG and Echo cardiograph-Heart valves Rheumatic Heart Disease (RHD)-ICCU- Arterial and venous systems-Blood pressure-pulse rate-Heart transplantation Resuscitation in Heart attack (First Aid)-Blood components Function-Plasma-Corpuscles -Blood clotting-Anticoagulants-Thrombosis-Embolism-blood related diseases like polycythemia Leukemia-Lymph fluid.

Physiological-Co-ordination Systems-Brain-Functioning of different regions-Memory-Sleep-Stroke-Alzhemier's disease-Meningitis/Brain fever Conditioned reflex-Electroencephalography-Right brain-left brain concept-Spinal cord-Functioning-Reflex action-CSF-Chemical co-ordination-Pituitary (Hormones of Adenohypophysis and their regulations)-Thyroid,Parathyroidal hormones-Insulin and Glucagon-Hormones of Adrenal cortex and Medulla-Reproductive Hormones-Problems related to Secretion Non secretion of Hormones.

Receptor Organs-Eye-Focussing Mechanism & photo chemistry of retina-Short sightedness-Longsightedness-Optometry-Retinopathy-Cataract-Lens replacement-Nyctalopia-Eye infection-Conjunctivitis-Glaucoma-Eye care-EAR-Hearing mechanism-Organ of corti-Hearing impairments and aids-Noise pollution and its importance-SKIN-Melanin-functions-Effect of solar radiations/UV-Skin Grafting-Dematitis-TONGUE-Gustatory reception.

Excretion-Ureotelism-Urea Biosynthesis (Ornithine Cycle)-Nephron ultrafiltration,tubular reabsorption and tubular secretion-Renal failure-Dialysis Kidney stone formation-Kidney Transplantation-Diabetes.

Reproductive system-Brief account of spermatogenesis - Oogenesis Menstrual cycle-  
Invitro fertilization-Birthcontrol

**II. Microbiology :** Introduction-History of Medical Microbiology-The influence of Pasteur Koch, and Lister-Virology, Structure, Genetics, Culture and diseases-AIDS and its control-Bacteriology-Structure,Genetics and diseases-Protozoan microbiology-Disease oriented-Larval microbiology-Diseases oriented-Life cycle of Taenia solium-Ascaris.Pathogenicity of Micro organism-Anti microbial resistance Chemotherapy.

**III.Immunology:** Innate(Non-specific) Immunity-Anatomical Barriers-Physiological Barriers-Phagocytic Barriers-Lymphoidal organs -Thymus-Bursa of Fabricius-Peripheral Lymphoid Organs-Lymph nodes-Spleen-Antibodies-Immunoglobulins-Regions of polypeptide chain-Transplantation immunology-Classification of grafts-Genetic basis of organ transplants-Immune system disorder.

**IV. Modern genetics :** Introduction-Scope-Human Genetics karyotyping Chromosome gene mapping, Recombinant DNA technology and segmenting.

Genetic diseases-Human Genome project-Cloning-Transgenic organisms Genetically Modified Organisms (GMO)-Genetherapy-Bio informatics application-DNA sequencing and protein structure.Biological database-

**V. Environmental science :** Human population and explosion-Issue-Global warming Crisis Green House Effect-Ozone layer depletion Waste mangement-Biodiversity conservation (Biosphere reserves) Government and Non Governmental organisations involved-Energy crisis and Environmental impact-Poverty and environment-Fresh water crisis and management.

**VI. Applied biology :** Livestock and Management-Dairy-Breeds of cattle-Milch breed-Draught breed-Dual purpose-Common diseases and control-Exotic and cross breeds-Techniques adopted in cattle breeding.

Poultry-Farming techniques-Breeds. Farming methods-Poultry diseases-Economic value.

Pisciculture-Fish farming-Edible fishes of Tamilnadu.

Medical Lab Techniques-Stethoscope-Sphygmomanometer-Heamocytometer-Urine-Sugar analysis-ECG-'PQRST' wave-CTScan-Endoscopic (Laprosopic) techniques-Artificial pacemaker-Auto analyser--

**VII. Theories of evolution :** Lamarckism-Neolamarckism-Darwinism-NeoDarwinism/Modern concept of natural selection-Species concept-Origin of species and Isolating Mechanisms

**VIII. Aquaculture :** History-Prospects-Kinds-Pond structure-Bunds-Pond types-Location-Culture-Physics-Chemical factors-Food-Bionomics of cultivable fishes and freshwater prawns-Induced breeding-Diseases parasites and control-Ornamental fishes - Culture-Feeding-Mariculture.

**SYLLABUS FOR PRACTICAL**  
**ZOOLOGY - (Long Version)**  
**STANDARD - XII**

1. Qualitative test for carbohydrates, proteins and lipids - 2 test each
2. Test of urea in urine of a mammal
3. Rate of activity of human salivary amylase in relation to temperature and pH
4. **Study of prepared slides** - Entamoeba, Scolex of tapeworm, mature proglottis, Red blood corpuscles, white blood corpuscles
5. **Models and specimens** - Mammalian Brain / model, Eye model, Ear model, Mammalian Kidney - Nephron model, Heart model
6. **Instruments / Drugs** -
  1. Stethoscope
  2. Sphygmomanometer
  3. An eye drop bottle having antibiotic fluid
  4. Eye lotion
  5. Bifocal eye lens
7. **Project Report**
  1. Visit to Medical Laboratory or Hospital or Research Laboratory
  2. Visit to a Dairy or Poultry or Fish farm
  3. Visit to a site having rain water harvesting

# ZOOLOGY

## CONTENTS

		<b>PAGE</b>
1.	<b>HUMAN PHYSIOLOGY</b>	<b>001</b>
2.	<b>MICROBIOLOGY</b>	<b>116</b>
3.	<b>IMMUNOLOGY</b>	<b>142</b>
4.	<b>MODERN GENETICS</b>	<b>157</b>
5.	<b>ENVIRONMENTAL SCIENCE</b>	<b>181</b>
6.	<b>APPLIED BIOLOGY</b>	<b>215</b>
7.	<b>THEORIES OF EVOLUTION</b>	<b>270</b>
8.	<b>AQUACULTURE</b>	<b>286</b>

# 1. HUMAN PHYSIOLOGY

## Introduction

Physiology is the study of functioning of organs and organ systems. All physiological activities are aimed at maintenance of **homeostasis, living and reproduction**. Homeostasis differentiates a living being from the non-living world. It provides the uniqueness for a self-duplicating, genomicized groups of organisms. **Homeostatic mechanisms** involve stabilizing an optimum level of water, minerals and other components of the body fluids and other thermal regulations. It is achieved by several bio-physical, bio-chemical processes, hormonal secretions and related metabolic modifications.

The phenomenon of **living** is made possible due to several types of evolved organs and their well co-ordinated functions. The functioning of heart as a pumping organ being emotionally controlled is astonishing. The oxygen association and dissociation capabilities of blood pigments, cascading effects of minimal amount of hormones at molecular limits, the process of nervous conduction, analyzing and memory maintaining capacities of the brain, the holistic visual perception of the eye are all wonderful inventions of nature towards a simple process of living.

The attainment of a simplified process of **sexual reproduction** for a complicated, genetically oriented mechanisms for sex cells production and procreation is stunningly marvellous. The orientation of reproductive strategies towards social, environmental and futuristic motives is highly precise and purposeful.

Thus all the functionings of a living system are highly complicated mechanisms with a simple outlook. In the forthcoming chapter an attempt has been made to highlight defects in functioning, remedial attempts and life-style modifications. Proper treatment of such an objective will result in a voluminous work. Yet, a simple attempt has been made to provide the information.



While going through the pages of this chapter, the learners may recollect the human anatomy learnt in the previous class. Knowledge and remembrance of anatomy will simplify an understanding of physiological processes.

## **Nutrition**

The survival of all living organisms is due to several types of nutritive processes. The process of nutrition involves ingestion digestion, absorption and assimilation of food materials. The composition of nutrients vary in different types of feeding. However, for all living organisms, the nutrient comprises the following organic and inorganic components. They are carbohydrates, proteins, lipids, vitamins, minerals and water. Each component has a specific functional role. A well proportioned intake of nutrients depends on several factors such as stage of growth, sex, health condition, bodily activities and environmental situations.

### **Carbohydrates (Poly hydroxyaldehydes (or) ketones)**

A carbohydrate is composed of carbon, hydrogen and oxygen in the ratio of 1:2:1 ( $\text{CH}_2\text{O}$ )<sub>n</sub>. They are of three types namely monosaccharides, disaccharides and polysaccharides

#### **Monosaccharides:**

These are the simplest form of carbohydrates being comprised of a single organic molecule. Depending on the number of carbon atoms they are classified into trioses, tetroses, pentoses, and hexoses.

The **trioses** ( $\text{C}_3\text{H}_6\text{O}_3$ ) are common intermediary products in carbohydrate metabolic processes. They play an important role in inter conversion of biomolecules. (eg. glyceraldehydes). **Pentoses** ( $\text{C}_5\text{H}_{10}\text{O}_5$ ) like ribose and deoxyribose are the integral components of RNA and DNA molecules. The **Hexoses**( $\text{C}_6\text{H}_{12}\text{O}_6$ ) such as glucose, fructose and galactose are food components commonly consumed.

Carbohydrates are commonly employed by the cells for providing energy. The energy metabolism happens through glycolytic processes involving oxidative, citric acid cycle. The energy liberated is stored in the form of ATPs (Adenosine triphosphate).

Each gram of carbohydrate is capable of yielding energy equivalent of 4.1 calories.

### **Disaccharides**

These are the carbohydrates formed by condensation of two monosaccharide monomers. These are found in common food substances such as milk and sugar. There are three common disaccharides namely maltose, sucrose and lactose. They have the following composition

Maltose ( <i>In germinating cereals</i> )	□	glucose + glucose
Sucrose ( <i>cane sugar</i> )	□	glucose + fructose
Lactose ( <i>milk</i> )	□	glucose + galactose

### **Polysaccharides**

These are complex carbohydrates formed by polymerisation of a large number of monosaccharides. Nature abundantly produces various types of polysaccharides. Several of them are structural components in the living world eg. chitin, cellulose. Starch molecules serve as storage food materials trapping enormous amount of energy. In food grains, starch is available as pectin and amylopectin molecules. Glycogen, a polysaccharide is found in liver and muscles.

### **Proteins(Polypeptides)**

Proteins are nitrogenous compounds being made up of carbon, hydrogen, oxygen and nitrogen. Proteins also contain sulphur. In living systems proteins play an important role in the **structural** organisation eg., cell membrane, hairs, nails and muscles. Many of the proteins serve as enzymes. They are named as **functional** proteins.

The building blocks of proteins are aminoacids. There are approximately twenty different types of amino acids, such as glycine, alanine, serine, valine, leucine, proline etc. The amino acids are classified as essential and non essential amino acids. Essential amino acids can not be synthesised in our body. Hence they should be made available through food. The **essential amino acids** are arginine, valine, histidine, isoleucine, leucine, lysine, methionine, phenylalanine, threonine and tryptophan. The non-essential amino acids can be synthesized in our body from other compounds. Such amino acids need not be added in the diet.

A protein (or) a polypeptide chain is formed of several amino acids linked with each other by peptide bonds. This linear arrangement is termed as primary organisation of a protein. However in most of the proteins, the straight chain structure gets complicated, into secondary, tertiary or quaternary stages. These levels are due to several other chemical bonds. The complicated nature of a particular protein is specifically required for its prescribed function. The amino-acids sequence and level of organisation is determined genetically. Hence the genome gets its importance due to its capability to produce, specific types of protein for bringing out genetical characteristics.



**Fig.1.1. Marasmus**



**Fig.1.2. Kwashiorkor**

The daily requirement of protein, according to the Nutrition experts committee of ICMR (Indian Council for Medical Research) and WHO (World Health Organisation) is 1 gm per kg body weight. Reduction in the intake of protein leads to protein malnutritions, such as **marasmus** and **kwashiorkor**. In marasmus the child loses weight and it also causes severe diarrhoea and the body muscles get wasted. It will appear as though the bones are covered by the skin. In kwashiorkor there is a wastage of muscles. Face and feet will have oedema. The belly region will appear enlarged.

### **Lipids**

Lipids are important cellular constituents. They are energy rich compounds. They form the most important storage food in the body. In our body, it serves as an insulating material. Cosmetically, the presence of limited amount of fat beneath the skin adds to beauty. Further, steroidal hormones are produced from certain lipids.

The most common type of lipids are the simple lipids (or) triglycerides. They are naturally occurring substances (vegetable oils). In s

constituent of adipose tissue. Chemically a triglyceride is formed of glycerol and fatty acids.

Fatty acids are of two types namely **saturated** and **unsaturated fatty acids**. The unsaturated fatty acids are capable of easier oxidative breakdown, hence poly unsaturated fatty acids(PUFA) are favoured for persons having high blood pressure and other related ailments. These fatty acids are abundant in sunflower oil and safflower oil.

Each gram of lipid is capable of yielding 9.3 calories of energy. It is suggested that 25% to 30% of total calories should come from fat.

### **Vitamins**

Vitamins are complex organic compounds, whose presence in trace amount in the food is essential for growth and other physiological activities. Vitamins do not have any energy value. However they are essential for controlling energy yielding processes. The identified vitamins are classified as **A,B,C,D,E** and **K**. Of these, vitamin **B** and **C** are water soluble in nature. Vegetables and fruits containing these vitamins if washed in water as cut pieces would loose them easily. Vitamin **A,D,E** and **K**, if consumed beyond required level may cause defects, commonly referred to as vitaminosis.

Of the various vitamins, vitamin **D** or calciferol on exposure to sunlight can be synthesised by our body through the lipid compound called ergosterol, found below our skin. Hence it is known as 'sunshine vitamin'.

The most important functions of vitamins include.

1. **Physiological processes** : Vitamin **A** plays a very important role in visual perception. Vitamin **E** might ensure fertility in animals. The clotting of blood is aided by vitamin **K**. Vitamin **C** provides immunity against infections and it may also support processes of growth.

2. **Maintenance of body tissues** : The epithelial tissues of the body are maintained by vitamin **A** and **B<sub>2</sub>**. The growth of bones is ensured by vitamin **D**. Vitamin **E** plays a role in the rejuvenation of tissues. Nourishment to nerve cells is provided by vitamin **B<sub>1</sub>**. The process of maturation of erythrocytes is due to vitamin **B<sub>12</sub>**.

3. **Metabolic processes** : The process of calcium and phosphorus metabolism happens due to the presence of vitamin D. Vitamin E remains an antioxidant. Vitamin B<sub>1</sub> remains as a co-enzyme in tissue metabolism and it is found useful in the process of oxidation of glucose in CNS. Vitamin B<sub>2</sub> is essential for carbohydrate metabolism. Niacin (vitamin B) plays a role as a co-enzyme and is essential for oxidation-reduction reactions. Normal metabolism of amino acids and fat are due to vitamin B<sub>6</sub>. Biotin (vitamin B) serves as a co-enzyme and co-factor in oxidative metabolism. Vitamin C activates certain intra-cellular enzymes.

### **Vitamin Deficiency Ailments.**

#### **Vitamin A**

1. Atrophy of lacrymal glands of the eye and reduction in tear secretion
2. Corneal epithilium becomes red and dry (**xerosis**). It may also become wrinkled and Keratinised (**xerophthalmia**). Appearance of Bitot's spot in the cornea might happen.
3. Cornea may get necrosed and get infected (**keratomalacia**).
4. May cause night blindness (**nyctalopia**).

**Vitamin D** :- Defective calcification of bone, deficiency of vitamin-D, causes **rickets** in growing children and **osteomalacia** in adults.

**Vitamin E** :- Rare in human, **sterility** in experimental animals.

#### **Vitamin K** :-

1. Lack of vitamin K leads to **defect in blood coagulation**.
2. In humans, vitamins K deficiency leads to **haemorrhagic** manifestations.

#### **Vitamin B<sub>1</sub>** :-

Gross deficiency of vitamins B<sub>1</sub>, leads to a condition known as **beriberi**. Beriberi affects nervous and cardiovascular systems. In children and infants the onset is acute.

### **Vitamin B<sub>2</sub> :**

Loss of appetite and other gastro-intestinal symptoms, soreness and burning of lips, mouth and tongue. Fissures appear at edges of the mouth.

### **Vitamin Niacin :**

Its deficiency leads to **pellagra**. The principal symptoms of pellagra include mental changes, (dementia) dermatitis and stomatitis. The tongue becomes smooth, red and painful.

### **Vitamin B<sub>6</sub>: (Pyridoxine)**

In human pyridoxine deficiency causes dermatitis around eyes, nose and behind the ears. Fissures appear above the lips and angles of the mouth.

**Vitamin B<sub>12</sub> :-** Its deficiency causes **pernicious anaemia**, typical sore tongue and several neurological problems related to the spinal cord.

**Vitamin C :-** Its deficiency in the body leads to **scurvy**, a disease characterised by bleeding gums, loosening and falling out of teeth and intra muscular haemorrhages. In the absence of this vitamin the collagen and connective tissue proteins are not synthesised properly.

### **Minerals**

Along with complex organic substances, such as carbohydrates, proteins and lipids, our body needs substances such as minerals, vitamins and water as accessory food factors.

Of the minerals certain elements are found in greater concentration. They are sodium, calcium, potassium, magnesium, phosphorus, sulphur and chlorine. Certain other minerals are required in slightly lower concentration for performing useful functions. These include, iron, copper, zinc, cobalt, manganese, iodine and fluorine (trace elements). Of these minerals, larger portion of certain minerals are concerned with **body building activities** such as formation of bones and teeth (Calcium, Magnesium and Phosphorus). Trace elements and other minerals are useful in **physiological activities** such as oxygen transport (Iron), hormone synthesis (Iodine) and intermediary metabolism (Manganese, Copper, Zinc). Some of the elements remain as **constituents** of the body fluids (Chlorine, Sodium and Potassium). Presence of certain minerals is essential for

**neuro-muscular irritability** (Magnesium, Sodium and Potassium), blood clotting (Calcium), **cardiac functions** (Potassium and Calcium).

## **Water**

Water is a major constituent in the body of all **mammals**. The proportion of water in the lean body mass (mass of the body - fat content) is constant at around 71 to 78 % in animals including human beings.

The total body water content varies with age, sex and body weight. In a new born child it is 85 to 90 % of body weight. In young adults it ranges from 55 - 60 %.

Of the total body water, about 2/3 is found as intra-cellular fluid (ICF) and 1/3 as extra-cellular fluid (ECF). About 25% of ECF is the plasma of blood.

The body water content is kept constant by maintaining a proper balance between water intake and loss. Intake of water happens through drinking of water and beverages, water in the food consumed and water generated during metabolism. The average water intake is around 2500 ml/day (as water 1400 ml).

Water loss happens through four routes. They are

1. Urine (about 1400ml), 2. Expiration (400ml), 3. Through skin (600ml), 4. Loss in faeces (100ml)

## **Role of water**

1. It is an essential constituent of all the cells of the body.
2. It serves as a transport medium for nutrients and excretory products.
3. It serves as a site for chemical reactions.
4. It is a valuable solvent for electrolytes, enzymes, hormones and vitamins.
5. It plays a vital role in the maintenance of body temperature.
6. It helps to maintain form and texture of tissues.

## Balanced diet

A balanced diet must have all food supplements in needed proportion. It should be preferred in such a way that normal growth, working capability, nitrogen balance and full calorie requirement can be maintained. While planning a balanced diet, the total calorie requirement of the individual is calculated and then the different components of the food are selected. Normally the calorie content of the food is fixed with an understanding that 10 -15 % of calories are to be obtained from proteins, 25 - 30% from fats and the rest from carbohydrates.

## Calorie values

In nutrition and dietetics a calorie means the amount of heat required to raise 1 Kg water by 1°C. As per the Nutrition Expert Committee of ICMR (1968) the calorie requirements are prescribed for Indian Reference Man (IRM) and Woman (IRW). The IRM and IRW have following characteristics.

**IRM :-** 25 years of age, 1.62 sq.mt of body surface, 55 kg body weight and remains healthy.

**IRW :-** 25 years of age, 1.4 sq.mt of body surface, 45 kg body weight and remains healthy.

The calorie requirement for IRM and IRW depending on their nature of work is prescribed as follows

### IRM

Daily activities	Sedantary work	Moderate work	Heavy work
A. Basal metabolism (BMR) (8 Hrs of Sleep)	460 calories	460 calories	460 calories
B. Non occupational activities (8 Hrs)	1220 calories	1220 calories	1220 calories
C. Occupational activities (8 Hrs)	750 calories	1100 calories	2200 calories
<b>Total</b>	<b>2430 calories</b>	<b>2780 calories</b>	<b>3880 calories</b>



## **IRW**

A. Basal metabolism (8 Hrs of sleep)	354 calories	354calories	354 calories
B. Non occupational activities (8 Hrs)	826 calories	826calories	826 calories
C. Occupational activities (8 Hrs)	610 calories	900calories	1800 calories
<b>Total</b>	<b>1790calories</b>	<b>2080calories</b>	<b>2980calories</b>

While formulating and planning the diet for a person, his/her calorie requirement is assessed. This assessment is based on the requirement of IRM and IRW. It is adjusted according to age, weight, health and working conditions. Final prescription of food is provided based on the calorie value of each item of food. Due attention is given also for palatability and social food habit. Balanced diet for Indian adult male and female doing moderate work.

## **Obesity**

Obesity is the storage of excess of body fat resulting in a significant impairment of health from a variety of diseases, notably hypertension, atherosclerotic heart disease and diabetes. A level of 10% above the standard weight, for subjects of same age and sex, is considered as obese.

The degree of obesity is assessed by the body mass index (BMI). It is calculated as weight in Kg divided by the square of height in meters. For example, a 70 Kg person with a height of 180 cms would have a BMI of 21.6 ( $70/1.8^2$ ). Normal BMI range for adults is 19 - 25. Men and women having BMI values above this range are considered obese

Obesity may be due to genetic reasons, increased appetite leading to excessive intake of food than is needed by the body, endocrine causes and / or metabolic disorders.

## **Digestion**

### **The digestive system**

The digestive system includes the gastro-intestinal tract (mouth to anus) and the glandular organs. This system serves to transfer organic molecules, salts and water from the external environment to the body's internal environment. Most of the food taken into the mouth are large particles containing macromolecules such as polysaccharides and proteins. As such they cannot be absorbed by the intestinal wall. They must be dissolved and broken down into much smaller molecules. This process is named as digestion. Digestion is accomplished by substances called enzymes produced from the digestive glands. The enzymes are biocatalysts in the food breakdown process.

### **The process of digestion**

**Mouth :-** In the mouth, digestion starts with chewing. It breaks up large pieces of food into smaller particles that can be swallowed without choking. It is accomplished by teeth, tongue, jaws and saliva.

Chewing is controlled by the somatic nerves to the skeletal muscles of the mouth and jaw. Rhythmic chewing motions are reflexly activated by the pressure of food against the gums, hard palate at the roof of the mouth and tongue.

**Saliva :-** The saliva is secreted by three pairs of exocrine glands, namely : the parotid, the submandibular and the sublingual. The daily secretion of saliva ranges from 1000 to 1500ml. It contains the organic substances amylase and mucin. The **salivary amylase** or **ptyalin** can act on starch. It converts cooked starch into the disaccharide, **maltose**. **Mucin** is a glycoprotein. It helps in the lubrication of food. The lubricated, swallowable form of food is called the **bolus**. The salivary secretion is controlled by reflex activities.

**Swallowing :-** It is a complex reflex activity. It is controlled by the swallowing center in the medulla oblongata. During swallowing the soft palate is elevated, the larynx gets raised. The tongue forces the food back into the pharynx, the epiglottis closes the glottis and the food slowly passes into the oesophagus.

The oesophageal phase begins with relaxation of the upper oesophageal sphincter. In the oesophagus the food is moved towards the stomach by a progressive wave of muscle contractions that proceed downward to the stomach. Such waves of contraction in the muscle layer surrounding a tube is known as **peristaltic waves**. In the oesophagus one peristaltic wave takes about 9 seconds to reach the stomach. Due to peristaltic waves, swallowing can occur even while a person is upside down.

### **The stomach**

It is a wide chamber, located below the diaphragm. The size and shape of the stomach depends on the food inside it. The stomach volume during feeding may increase upto 1.5 lit. Stomach's primary contractile action will produce peristaltic waves. Each wave begins in the body of the stomach and proceeds towards the pyloric region. The initial wave influences the muscles to close the **pyloric sphincter**, a ring of smooth muscles between the stomach and the duodenum.

The inner wall of the stomach is lined with gastric glands. There are nearly 40 million glands engaged in producing gastric juice. The chief cells of the lining of stomach secrete enzymes and the parietal cells (Oxyntic cells) produce HCl to create acidic medium for enzymes.

The enzymes of the stomach are the **pepsin** and **rennin**. Pepsin is secreted in an inactive precursor form known as **pepsinogen**. The activity due to HCl converts pepsinogen into pepsin. Pepsin hydrolyses the proteins into short polypeptide chains and peptones. It is most effective in an acidic environment.



Rennin acts on soluble milk protein caesinogen and converts it into insoluble casein. In the presence of calcium ions casein is precipitated as insoluble calcium-casein compound (curds).

Repeated peristaltic waves in the stomach help to soften the food. The frequency of contraction is determined by the basic electrical rhythm and remains essentially constant. It is also aided by neural and hormonal influences. The food leaves the stomach in the form of chyme and enters the upper small intestine at periodic intervals.

**The small intestine :-** It is about 5-7 metres long. It is divided into three segments namely the initial short segment the **duodenum**, the **jejunum** and the longest segment the **ileum**.

The food is propelled down into the duodenum due to peristaltic action of stomach wall. The pyloric sphincter located at the junction of stomach and duodenum regulates movement of chyme.

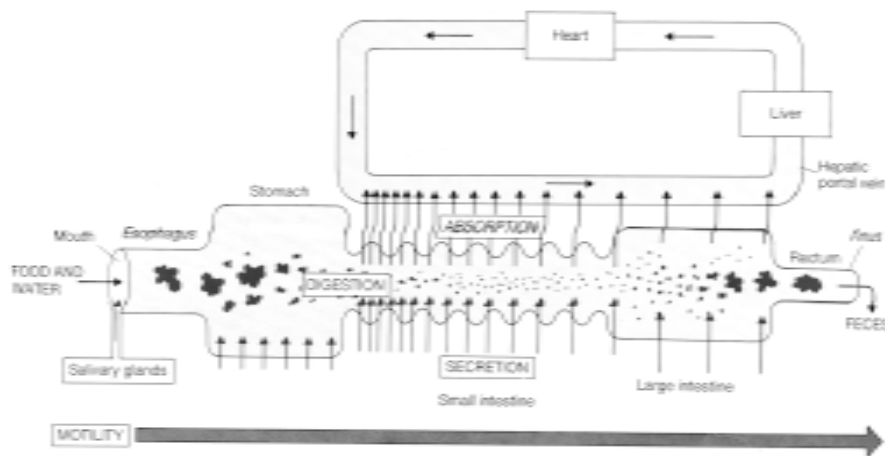
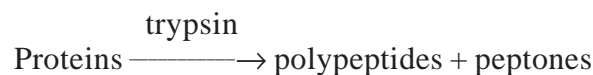

**Fig.1.3 Process of digestion**

The food in the small intestine is mixed with three juices namely bile juice, pancreatic juice and intestinal juice.

**Bile juice :-** It is a brownish green, alkaline secretion of the liver. It is stored in the gall bladder and poured into the duodenum via the bile duct. The bile contains water, mucus, inorganic salts, cholesterol and bile salts. The bile salts emulsify fats and help enzymes like lipase to act upon fats. During emulsification, the bile salts convert bigger fat particles into smaller fat globules.

**Pancreatic juice :-** It is an alkaline fluid (pH 7 to 8). It is transported to the duodenum through the pancreatic duct. It contains water, mineral salts and a variety of enzymes like : **trypsin**, **chymotrypsin** which are secreted in the form of inactive precursors **trypsinogen** and **chymotrypsinogen**. The precursors are activated by enterokinase of the intestinal juice, the amylolytic enzyme **amylase**, the pancreatic **lipase** (steapsin), **carboxypeptidase** and **nuclease**. The enzyme trypsin hydrolyses proteins into polypeptides and peptones.



Chymotrypsin hydrolyses peptide bonds associated with specific amino acids like phenylalanine, tyrosine or tryptophan. It results in large peptides.



**Carboxypeptidase** is an exopeptidase. It attacks the peptide bonds at the carboxyl end of the polypeptide chain resulting in di-, tripeptides and amino acids. The pancreatic amylase converts starch into maltose. The lipase acts on emulsified fat (triglycerides) and hydrolyses them into free fatty acids and monoglycerides. Monoglycerides may be further hydrolysed to fatty acid and glycerol.

#### **Intestinal juice: (Succus entericus)**

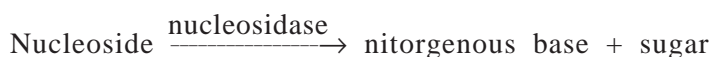
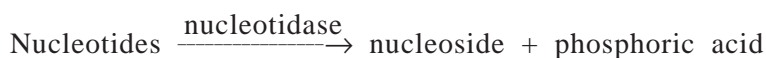
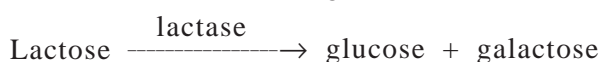
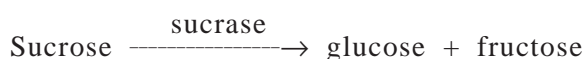
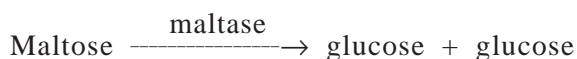

#### **Absorption and assimilation**

As a result of digestion, all macromolecules of food are converted into their corresponding monomeric units. Carbohydrates are broken into monosaccharides such as glucose and fructose. Proteins are hydrolysed into amino acids. Lipids get broken into glycerol and fatty acids. The simpler organic molecules along with minerals, vitamins and water enter into body fluids through the villi.

The villi are small microscopic finger-like projections. Each villus is an absorbing unit consisting of a lacteal duct in the middle surrounded by fine network of blood capillaries. While the fatty acids are absorbed by the lymph duct, other materials are absorbed either actively or passively by the capillaries of the villi.

From the lumen of the alimentary canal absorbed food materials are carried to the liver through hepatic portal vein. From the liver, materials are transported to all other regions of the body for utilisation. This conversion of food into energy and cellular organisation is called as assimilation.

### **Dental Caries (Tooth decay)**

Tooth decay is the gradual erosion of enamel (the protective covering of the tooth) and dentine (the substance below the enamel). Plaque formation is the main cause of tooth decay. The most common sites of initial decay are areas where plaque easily becomes trapped, such as the grinding surfaces of the back teeth (which have minute grooves in them), the lateral (side) edges of adjacent teeth, and near the gum line. Plaque consists of food remains, salivary mucus by-products, and the bacteria that live in the mouth.

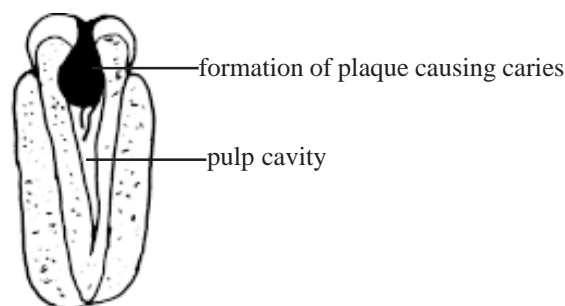

**Fig.1.4 Dental caries**

The bacteria feed mainly on the fermentable carbohydrates (simple sugars and starches) in food, and in breaking them down, create an acid that gradually destroys enamel, forming a cavity. If the process is not checked, the dentine gets eroded. The cavity gets enlarged enabling the bacteria to invade the pulp at the centre of the tooth and causes infection.

#### **Symptoms :**

Early decay does not usually cause any symptoms. The chief symptom of advanced decay is tooth ache, which may be aggravated by eating very sweet, hot or cold food. Decay may also cause bad breath.

#### **Treatment :**

Treatment consists of the drilling away the area of decay and filling the cavity with either dental amalgam (a mercury alloy) or cement (a composite resin that matches the colour of the tooth). In cases of advanced decay, it may be necessary to remove the infected pulp (the central, living part of a tooth) and replace it with a filling or to extract the tooth.

## **Root Canal Treatment**

It is a modern dental procedure to save a tooth in which the pulp (the living tissue within a tooth) has died or become untreatably diseased, usually as a result of extensive dental caries.

### **Steps involved in Root Canal Treatment**

(1) A hole is drilled into the crown to remove all material from the pulp chamber. The root canals are then cleaned with fine-tipped instruments. The procedure is usually monitored by X-rays.

(2) The cavity is washed out, and antibiotic paste and a temporary filling are packed into it. Some days later, the filling is removed and the canals are checked for sterility.

(3) When no infection can be detected, the cavity is filled with a sealing paste and/or tapering solid “**point**” made of gutta - percha resin mixed with zinc and bismuth oxides. The mouth of cavity is then sealed with cement.

## **Peptic ulcer**

It refers to an eroded area of the tissue lining in the stomach or duodenum. The lining of stomach or duodenum are protected from the effects of HCl by a layer of mucous. If the mucous layer is damaged, the acid may cause inflammation and erosion of the lining. It is known as peptic ulcer. Ulcer is of two types namely, duodenal and gastric. Of the two, duodenal ulcer is more common. It occurs in people in the age group of 25 - 45 years. Gastric ulcer is more common in persons above the age of 50 years. Peptic ulcer is a very common gastric ailment.

**Causes:-** The ulcer is mostly due to infections by a bacterium called *Helicobacter pylori*. It may also be caused due to uncontrolled usage of aspirin or certain anti inflammatory drugs such as Ibuprofen. Ulcer may also be caused due to smoking, alcohol, coffiene and psychological stress. In severe peptic ulcer, upper digestive tract endoscopy is done to assess the extent of damage. A bleeding or perforated ulcer requires hospitalization. Common treatment of ulcer is aimed at healing the ulcer and preventing its recurrence. Life style changes such as giving up smoking and alcohol may be required. Anxiety, stress, strain and worrying should be avoided.

## **Hernia**

Hernia is commonly called “ruptures”. A hernia occurs at a weaker region in the abdominal muscle. Due to increased pressure in the abdomen, the muscles become stretched at the weak point, the pressure may be due to lifting heavy weights, continuously. Due to hernia, a visible bulge can develop. It will contain fatty tissues or part of the intestine. Abdominal hernias are common in men having heavy manual job.

In hernia, a section of intestine may become twisted and get trapped inside the bulge. The blood supply may be cut off. This is known as strangulated hernia. If it causes severe pain immediate surgery is needed. Hernia can occur in other areas of the body.

### **Types of Hernia**

**1. Inguinal Hernia** - a portion of the intestine pushes through inguinal canal. This region is the weak spot.

**2. Femoral Hernia** - It occurs in the part of the groin where the femoral vein and artery pass from the lower abdomen to the thigh, women who are over weight (or) who have several pregnancies may be affected.

**3. Umbilical Hernia** - It develops in babies, behind the navel due to weakness in the abdominal wall.

**Hernia repair** - For hernia often a simple surgery is needed. It is done by using local or general anaesthesia.

### **Appendicitis**

It is the inflammation of the appendix, leading to severe abdominal pain. Appendix is a small blind ended tube found at the beginning of the large intestine. This disorder is very common among adolescents. It is more common in developed countries where diet contains less fibre food. The inflammation causes blockage. The closed end of the appendix beyond the blockage then becomes infected by bacteria.



The early symptoms includes sudden pain in the upper abdomen, nausea with or without vomiting. It may also cause mild fever. If a treatment is delayed the appendix may rupture and result in infection in the abdomen. The serious infection is called as peritonitis. The treatment involves the removal of appendix by surgery.

### **Gall Stones**

These are the stones of various sizes and content that form in the gall bladder. The stone formation occurs in about 1/10 people, over 40 years of age. The Gall stones are formed by bile. Bile is made up of cholesterol, pigments and several salts. Any alteration in the composition of the bile can cause the formation of stones. The stones are mostly formed of cholesterol.

There is no obvious reason for such a formation. However, obesity is a risk factor. High fat diet can also cause stone formation. In severe, complicated situations it may block the bile duct and cause jaundice.

### **Hepatitis**

An acute hepatitis may happen due to variety of causes. Its manifestation is inflammation of the liver. Such inflammation may happen due to viral infection. Non-infectious hepatitis can happen due to excessive alcohol consumption. In early stage, the symptoms are not conspicuous. The symptoms include fatigue, poor appetite, nausea, vomiting, fever and discomfort in upper right side of the abdomen. There is no specific treatment. People are usually advised to take rest, and avoid drinking of alcohol.

### **Bones and Joints**

The adult human skeleton consists of 206 bones. The bones along with approximately 700 skeletal muscles, account for 50% of our body weight. Bones provide protection and support. When two or more bones join together, a joint or articulation is formed. Through several types of joints, they help in movements.

## Fractures

Fracture is defined as a break or crack in the bone. Trauma or injury to the bones of human body is getting increased with the development of industry and transportation. Trauma is the biggest killer and maimer of human beings all over the world. **Hippocrates** in the 14th century B.C. described the treatment of fractures and injuries to limbs. In India, the treatment of fractures to limbs is still carried out by traditional bonesetters. Modern methods of treatments are available. They are more scientific and appropriate.

### Types of fractures :

1. **Green stick fracture** : - This fracture occurs in the young bones of children. This fracture break is incomplete leaving one side of the cortex intact.
2. **Closed fracture** :- A closed fracture is the one where the haematoma (blood clot) does not communicate with the outside.
3. **Open fracture** (Compound fracture ) :- In this type, the fracture haematoma communicates with the outside through an open wound. It is a serious injury through which infectious germs may enter into the body.



Fig.1.5. Types of fractures



**Fig.1.6. X-ray of fractures - Fracture dislocations**

4. **Pathological fracture** :- This type of fracture occurs, due to pathological lesions after a trivial violence in a weak bone. It may be due to hyperparathyroidism.

5. **Stress fracture** :- It is a fracture occurring at a site in the bone, due to repeated minor stresses over a long period of time.

6. **Birth fracture** :- It is a fracture occurring in the newborn babies due to injury during delivery.

**Mechanism of fracture :**

A fracture can be caused either by direct violence or indirect violence. Direct violence causes a fracture at the site of impact of the force. Indirect violence fracture is one that is transmitted to a bone away from the site of impact and producing the fracture there.

Torsion produces spiral or oblique fracture. It is important to understand the mechanism of fracture as it helps in deciding the manoeuvres

for reducing further damages. When a man falls down from a building or from a coconut tree he sustains a fracture on bones and the spine. The fracture of bone is caused by direct violence and the fracture spine is caused by indirect violence.

### **Healing of Bones in fracture :**

It involves three phases, viz.,

1. Inflammatory phase
2. Reparative phase
3. Remodelling phase.

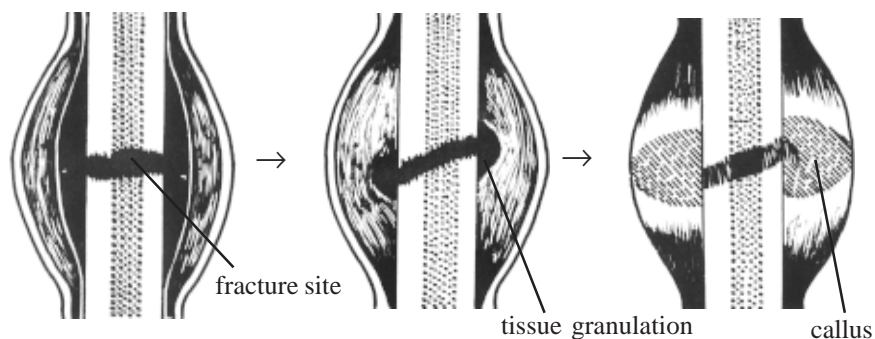

**Fig.1.7. Healing of bone in fracture**

**1. Inflammatory Phase :** - When a fracture occurs, at the site of fracture the blood vessels get broken and the blood fills up the gap of the bone. This blood clots to form a haematoma. This process takes place in one to two days. The soft tissue of this region undergoes inflammation.

**2. Repairative Phase :** - A stage of callus is formed. It bridges the gap and establishes contact between the ends of fractured bone. The callus is nothing but granulation of tissues around the site of fracture. This phase takes place about eight to twelve weeks.(Fig. 1.7)

**3. Remodelling phase :** - Once the fracture is bridged by the callus tissue, the site of fracture undergoes remodelling by muscular and weight bearing stresses and slight deformity gets corrected by moulding. This remodelling takes up to one year.

### **Physiotherapy and rehabilitation**

Physiotherapy is the therapeutic exercise to make the limbs work normally. Therapeutic exercise is carried out by physiotherapists under the

supervision of orthopaedic surgeon. The common problem at the end of fracture treatment is the wasting of muscles and stiffness of joints. These two problems can be rectified by physiotherapy, by gradual exercises.

### **Dislocation of joints**

**Dislocation** is the total displacement of the articular end of the bone from the joint cavity. The normal alignment of the bones becomes altered. Various factors are attributed for bone and joint dislocations.

Dislocations are classified as 1. Congenital, 2. Traumatic, 3. Pathological and 4. Paralytic. Congenital deformities are due to genetic factors or factors operating on the developing foetus. These are also called teratogenic or teratologic disorder.

**Traumatic dislocation** is due to a serious violence. It occurs in the shoulder, elbow and hip.

**Pathological dislocation** is caused by some diseases like tuberculosis. Tuberculosis of the hip may cause dislocation of the acetabulum.

**Paralytic dislocation** occurs when a remarkable imbalance occurs on the muscle power. e.g. Poliomyelitis.

### **Arthritis**

Arthritis is the inflammation of all the components and structures of the joints. It involves synovium, articular surfaces and capsule.

Several etiological factors are attributed to the origin of arthritis (arthritogenesis). They are diet, psycho-somatic illness, infections, diseases and metabolic abnormalities, etc., Types of arthritis include.

1. **Infective arthritis** :- Infections such as Staphylococcal, Streptococcal, Gonococcal, Rheumatic, Small Pox, Tuberculosis, Syphilitic, Guinea worms, etc., can cause damages at the joints. It produces pain in joints.

2. **Rheumatic arthritis** : -It is a generalized disease affecting the connective tissues, of the whole body. It focalizes the involvement of

musculoskeletal system. It is an inflammation of synovial membrane. Rheumatic disease is considered to be of auto immune origin. It is due to immunological disorder against an unknown antigen..

**3.Osteoarthritis (Osteoarthrosis) :** - It is a degenerative condition of the joints, without any inflammatory process. Osteoarthritis is a progressive process affecting the articular cartilage of aging joints. It is characterized by focal degeneration of the articular cartilage. In the later stage, the cartilage gets eroded and exposing the sclerosed bone.

**4.Metabolic arthiritis :-** Metabolic arthiritis is due to metabolic disorders. This is a disease due to an inborn error of Purine metabolism. It is commonly called **gout**. This condition is characterized by the deposition of Sodium Urate crystals (uric acid) on the articular cartilage, synovial membrane and in the periarticular tissues. Gout is characterized by onset of pain swelling and reddening of joints.

### **Rickets and Osteomalacia**

Rickets and Osteomalacia are caused due to inadequate mineralisation of the bones. Our skeletal system stores 98% of the calcium in the human body and hence calcium metabolism has a major influence on the structure and growth of bone.

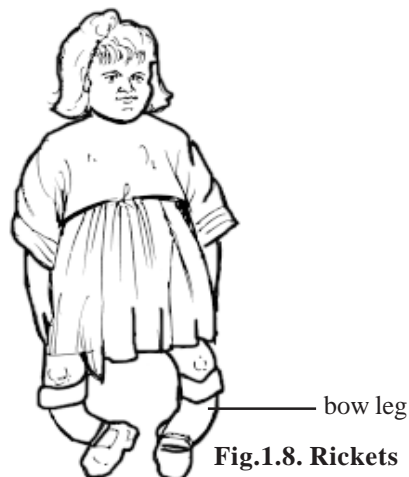

**Rickets :-** In this case, mineralization of bones is defective. The rickets caused by nutritional deficiency is called **Nutritional rickets** . In India, it is a common problem among the population below the poverty line. It is due to

Vitamin D deficiency. It occurs in children below four years. But it can afflict all age groups who have calcium and D deficiency. Vitamin D is associated with calcium absorption and deposition. Lack of calcium and vitamin D causes softening of bones and pliable deformity. In children the symptoms of rickets are bowed legs, knock knees, pigeon chest, broadening of wrist and ankles, protruberant abdomen, etc.,

The primary prevention of the Rickets, in the child begins by better nutrient of the pregnant mother, followed by supply of Vitamin D. Cod and shark liver oil are very good sources of Vitamin D.

**Osteomalacia** : - In adults Vitamin D and Calcium deficiency leads to osteomalacia. This is characterized by bone pain and tenderness. It causes brittleness in the bones.

## **Orthopedics**

Orthopedics deals with all bone deformities occurring in children as well as adults. The deformities may either be congenital or acquired. The former is caused by developmental abnormalities (teratogenic), the latter is caused by trauma or infections or by metabolic disorders. The corrective measures in the management of these disorders involve physiotherapy, splinting and use of appliances, traction procedure, plaster cast and wedging, manipulation under anaesthesia, surgical and neurological examination.

## **Muscles**

Muscles are elastic in nature. They are capable of contraction in response to stimulus from the central nervous system. The muscle cells function like biological machines that convert chemical energy into mechanical work. The mechanical work involves various movements including vital processes like contraction of the heart and blood vessels. Approximately 40% of the body is skeletal muscle and almost 10% is smooth and cardiac muscles.

### **Structure of a skeletal muscle:**

A striated muscle is composed of many fibres arranged in bundles. The diameter of each fibre varies from 10 to 100 microns. The

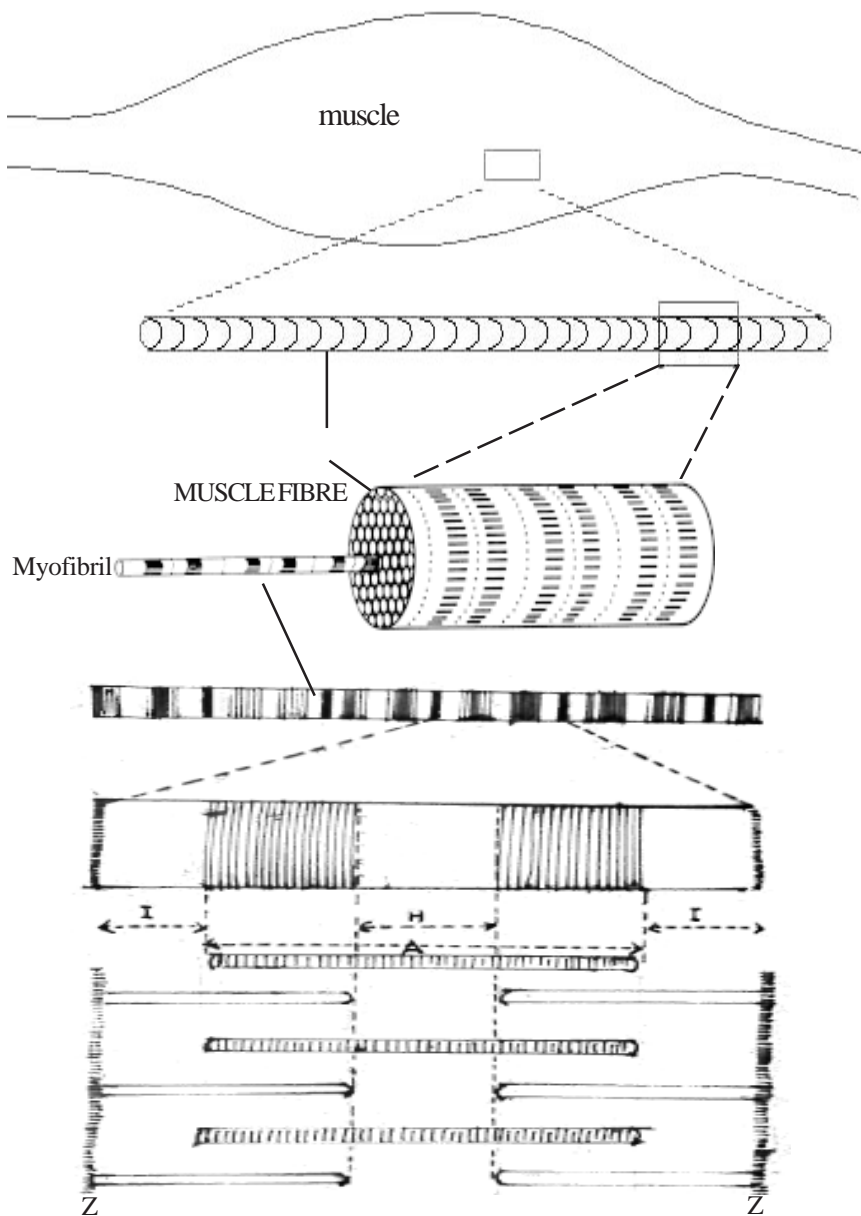

Fig.1.9. Ultra structure of muscle fibre



length of fibres ranges from 1 to 20mm. Each fibre is surrounded by a membrane, called the **sarcolemma**.

Each muscle fibres is made up of 4 to 20 thread-like structures called **myofibrils**. They are parallel to each other. The myofibrils are 1 to 3 micron in diameter. In between the myofibrils, the sarcoplasm is present. A small segment of the myofibril is called as the **sarcomere**.

#### **Structure of sarcomere :**

When a sarcomere is observed under a microscope, we could see alternative dense (**A band**) and light bands (**I band**). The central region of the A band is often less dense and is known as the "**H Zone**". The 'I band' is bisected by a dense narrow line, the **Z line**. Thus each sarcomere includes repeating units between two Z lines in linear order as Z line, I band, A band, I band and next Z line.

Electron microscopic studies have shown that the striations are due to the regular arrangement of 2 types of protein filaments. 'A band' contains a set of thick filaments formed of the contractile protein **myosin**. It may range upto 110 A° in diameter and 1.5 micron in length.

The second set of thin filaments ( 50 A° diameter) overlap the long filaments in 'A band'. The second set of filaments extend partly in 'I band' and partly in 'A band'. These filaments are formed of a substance called **Actin**.

Myosin, actin, tropomyosin and troponin are the four major proteins which constitute the contractile machinery of muscle fibre. The energy for muscle action is provided by ATP molecules.

#### **Mechanism of muscle contraction.**

##### **I. Sliding - filament hypothesis.**

Hanson and Huxley proposed this hypothesis (1955). According to this hypothesis, the contractile unit of muscle is made up of two types of filaments i.e., myosin and actin. These filaments during contraction slide over one another. It has been observed that both at the time of contraction and stretching, the length of the 'A band' remains constant. The length of the 'I band', on the other hand, changes in accordance with the length of the muscle.

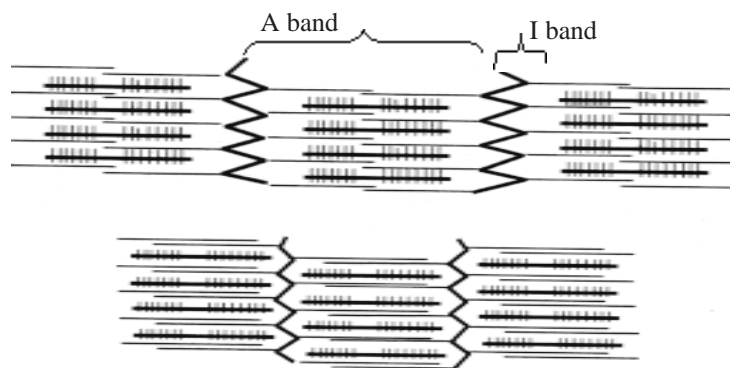

**Fig.1.10. Mechanism of muscle contraction**

Due to this, the Z discs are pulled together. Thus successive sarcomeres are pulled. This leads to the contraction of the muscle.

**ATP as the source of Energy for contraction :-** For a muscle in action, energy is required. This energy is released by cleaving ATP molecules to ADP+ Pi. Greater amount of work is performed by the muscle, with greater amount of ATP that is cleaved. This energy binds with active site of actin filament to contract.

**Neuro muscular Transmission :-** The muscles are innervated by myelinated nerve fibres that originate from the spinal cord. The nerve ending makes a junction, called **neuromuscular junction**. The nerve is connected at the midpoint of muscle fibre so that action potential in the fibre travels in both directions. When a nerve impulse reaches the neuro-muscular junction, a substance called **acetylcholine** is released. The acetylcholine induces muscle fibre for contraction.

**Initiation of muscle contraction :-** Initiation of contraction of skeletal muscle begins with action potentials in the muscle fibres. These elicit electrical currents that spread to the interior of the fibre, where Ca ions are released from the sarcoplasmic reticulum. The Ca ions in turn initiate the chemical events of the contractile process. This overall process of controlling muscle contraction is called **excitation**.

**Maximum strength of contraction :** The maximum strength of contraction of a muscle operating at a normal muscle length is about 3.5 Kg / Sq.cm. of muscle.

**Changes in muscle strength :** When a muscle begins to contract after a long period of rest, its initial strength of contraction may be as little as one half of its maximum strength. It gains strength after 30-50 muscle twitches. Weight lifters apply this to reach maximum capacity.

### **Muscle Tone**

When the muscles are at rest, a certain amount of contraction usually remains. This residual degree of contraction in skeletal muscles is called **muscle tone**. The skeletal muscle tone is the result of nerve impulses from the spinal cord. These in turn are partially controlled by impulses transmitted from the brain. To some extent, the muscle tone is due to the muscle fibres itself.

### **Muscle Fatigue :- ( muscle contraction is diminished)**

Prolonged and strong contraction of muscle leads to the state of muscle fatigue. This is due to muscle glycogen depletion and lactic acid accumulation. Fatigue probably results from inability of the contractile process and deficient metabolic process of the muscle fibre.

However, experiments show, that transmission of nerve signals through the neuromuscular junction can occasionally diminish the prolonged muscle activity, thus further reducing the power of muscle contraction. It is a well known fact that non-supply of blood to the muscles leads to almost complete fatigue within a minute. This is due to non-supply of O<sub>2</sub> and nutrients to the muscles.

**Rigor Mortis :-** Several hours after death all the muscles of the body attain a state of contracture called **Rigor mortis**. This is due to complete depletion of ATP in muscle fibres. The muscle remains in rigor, until the lysosome enzymes completely destroy all muscle proteins. This will take place within 15-25 hours after death.

### **Muscle Pull**

Muscle pull is actually a muscle tear. A traumatic pulling of the fibres produces tear known as **strain**. This injury can occur due to sudden stretching of muscle beyond their point of elasticity. While some strains are the result of high velocity impacts, other types of pull can be due to repetitive

movements. When the muscles are being exerted over a long period of time, they become vulnerable to tearing from a simple change in the position of muscles.

Back pain is a common problem, caused by muscle pull. This may be due to improper posture at the chairs. In these cases, the muscles are tightened over a long time, but the muscles may not tear until something as simple as reaching for a glass of water occurs.

### **Types of muscle contraction :-**

There are 2 types of muscle contractions.

**1. Isotonic contraction:** It involves muscle shortening as the myofilaments slide. This contraction produces normal movements, such as bending the knee, rotating the arms and smiling.

**2. Isometric contraction:** It occurs when the myofilaments “spin their wheels” without moving, causing tension in the muscle. This is due to the muscles that are pitted against some more or less immovable object.

### **Isometric and aerobic exercises**

In isometric exercise, muscles are moved through a short distance against a high resistance, as in pushing or pulling an immovable object. Isometric exercise is best for developing large muscles, whereas isotonic exercise has beneficial effects on the cardiovascular system. Isometric exercise-increases the thickness of the muscle fibres and their ability to store glycogen.

### **Exercise :**

The muscle inactivity always leads to weakness and wasting of muscles. Muscles are no exception to the saying “use it or lose it”. Regular exercise increases muscle size, strength and endurance. There are several exercises according to the needs and benefits. For example jogging or biking results in stronger, more flexible muscles with greater resistance to fatigue. Stamina formation is mainly carried out through aerobic activities, such as running and swimming.

**Benefits of aerobic exercise:** Physical exercise is a major contributor to health and can improve the body in three ways: more efficient heart, and lungs, improved muscle tone, and more supple joints. It is also essential to prevent obesity. Due to regular exercise, blood supply to muscle increases, it results in supply of more O<sub>2</sub>. Further aerobic exercises make overall body metabolism more efficient, improve digestion and enhances neuromuscular co-ordination. Heart beat enlarges, so that more blood is pumped out with each beat, fat deposits are cleared from the blood vessels and the lungs become more efficient in gaseous exchange. These benefits may be temporary or permanent on the basis of regular and vigorous exercises. Aerobic exercises do not cause the muscle to increase in size, even though the exercise may go on for hours. Aerobic exercises increase the adaptability of muscles and give greater endurance to muscles. To gain good health, it is suggested that a total of at least 20 minutes per day, of moderate exercise, to burn around 200 calories (837 joules) a day, is required. Regular exercise is preferable to occasional intense sessions.

The bulging of muscles of a body builder or professional weight lifter results mainly from resistance or isometric exercise in which muscles are pitted against some immovable, or nearly so, object. Endurance and resistance exercises produce different patterns of muscle response, it is important to know what your exercise goals are. Weight lift will not improve your endurance for a marathon race. At the same time, Jogging will do little to improve your muscle definition nor will it make you stronger. Proper exercise for proper goal is necessary.

### **Myasthenia Gravis**

This disease, affects one in 20,000 persons. It causes the person to become paralysed because of inability of neuromuscular junction to transmit signals from the nerve to muscle fibre. The muscles affected include those used in walking, breathing, chewing, and talking. A characteristic sign of the disease is drooping eyelids. Myasthenia gravis most often affects women between the ages of 20 and 30, but it can strike anyone after adolescence. It is believed that myasthenia gravis is an **autoimmune disease** in which patients have developed antibodies against their own acetylcholine activated ion channels. These antibodies are produced by thymus gland. If the disease gets intense enough, the patient dies of paralysis of respiratory muscles. The

disease can be cured by removal of the thymus and by a blood-cleansing process, called *plasmaphoresis*, that removes the destroying antibodies. About 10 per cent of the victims die.

## **Respiration**

Respiration is a process by which oxygen reaches the body cells and is utilized by them in metabolism and carbon-di-oxide formed as a waste product gets eliminated. The real function of respiration is to provide the energy needed by body cells. Cells obtain energy by metabolizing glucose utilising oxygen. Hence they require a constant supply of oxygen. In addition, the waste products of the metabolic process, namely carbon-di-oxide must be carried away from the cells. The transport of oxygen and carbon-di-oxide between lungs and body cells takes place by an efficient cardio-vascular system.

### **Process of pulmonary respiration**

Respiration includes several processes which are listed below

- (i). **ventilation** is the breathing in of air with more oxygen into the lungs (inspiration). It is followed by expulsion of air with more of carbon-di-oxide (expiration).
- (ii). **Diffusion** of oxygen from the alveoli into the blood inside surrounding capillaries.
- (iii). **Transport** of oxygen by the blood to the heart through the pulmonary vein.
- (iv). **Distribution** of oxygen by various arteries and their capillary network to all cells of the body. As the blood passes through tissue capillaries, it gives up oxygen (and nutrients such as glucose) to the body, tissues and picks up the waste products of cellular respiration (Carbon-di-oxide and water).
- (v). **Exchange** of the oxygen and carbon-di-oxide between the blood and body cells. With in body cells glucose and oxygen take part in a complex series of reactions which provide energy to power the cells. During this cellular respiration glucose is converted to carbon-di-oxide and water. (Enzymatic oxidation).

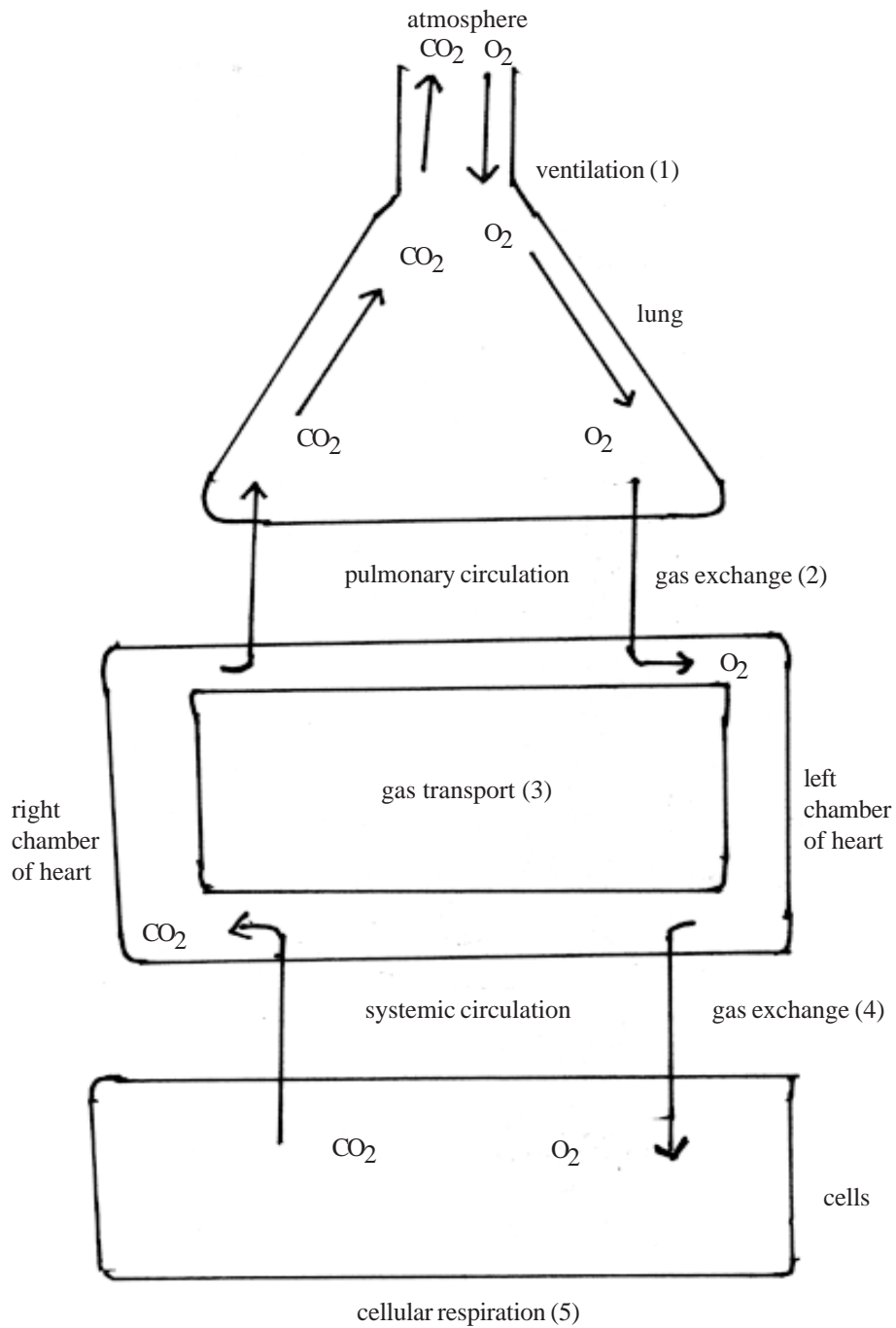

**Fig.1.11. Exchange of gases at lungs and tissue**

(vi). **Transporting** blood with carbon-di-oxide. Carbon-di-oxide is carried back in the blood to the heart then to the lungs where it diffuses into the alveoli and is breathed out of the body (External respiration).

(vii) **Exchanging** of carbon-di-oxide with oxygen at the alveolar surface.

(viii) **Expiration** of air with carbon-di-oxide from the lungs.

### **Mechanism of Breathing :**

The process of inspiration and expiration happens due to pressure changes in the thoracic cavity. The thorax is an airtight compartment bounded by the sternum in front, the vertebral column at the back, the ribs encircling the sides and the diaphragm found below. The rib bones are provided with the two sets of muscles namely **external** and **internal intercostal muscles**. By the contraction and expansion of these muscles the volume of the thoracic cavity is reduced or increased. The floor of the thoracic cavity is completely closed by the diaphragm. The act of breathing is performed by expansion and contraction of the thoracic cavity.

**Inspiration :-** Inspiration is the process by which fresh air is drawn into the lungs. It is an active process. The muscles participating in the inspiration process are external - intercostal muscles present in between the ribs and the diaphragm.

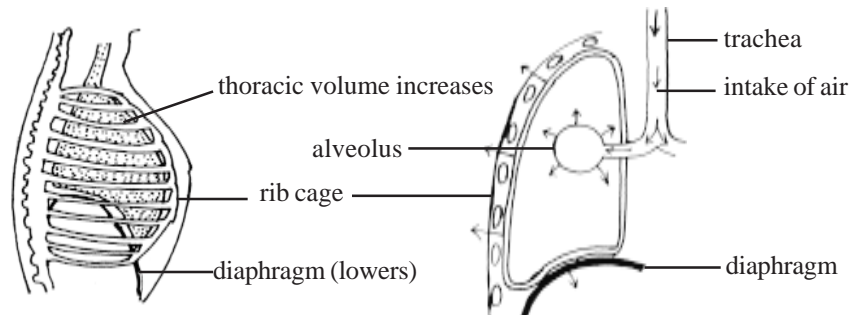

**Fig.1.12. Inspiration**

During quiet respiration, contraction of external intercostal muscle causes the ribs to move anteriorly and outwardly. This movement enlarges the cavity of the thorax by increasing it side to side and in dorso-ventral dimensions.



The contraction of radial muscles of the diaphragm leads to flattening of inelastic, dome shaped central part of the diaphragm. As a result of these muscular movements, the volume of the thoracic cavity is increased. This causes the air pressure within the lungs to fall below the atmospheric pressure. So air (tidal air) from outside passes through the air passage into the lungs to equalize the pressure.

**Expiration :** Inspiration is followed by expiration. It is a passive process. Expiration is the process by which air is exhaled or blown out from the lungs. The expiration results when the volume of the thoracic cavity is decreased and air pressure in the lung is increased. The expiratory process involves the following movements.

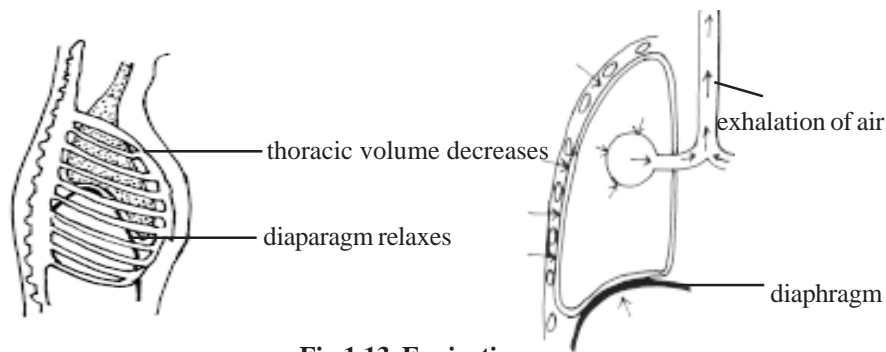

**Fig.1.13. Expiration**

1. The diaphragm relaxes and rises to resume the original dome shape.
2. The ribs take their original position as a result of contraction of the internal intercostal muscles.

### **Gaseous exchange in the alveoli**

Once the air is within the lungs the process of gaseous exchange begins. Capillaries of the pulmonary artery remains close to the wall of the alveoli. This enhances the exchange of gases.

	<b>Oxygen</b>	<b>carbon-di-oxide</b>	<b>water vapour</b>
Inhaled %	21.00	0.04	variable
Exhaled %	15.7	3.6	saturated

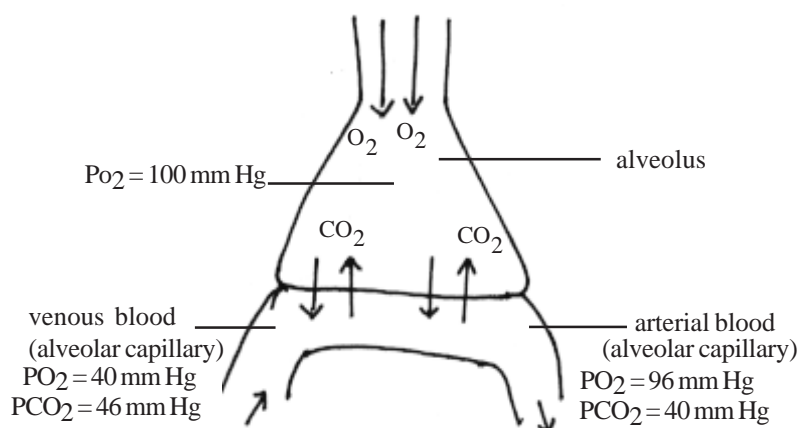

**Fig.1.14. Exchange of gases in the alveolus**

Oxygen and carbon-di-oxide are exchanged across the alveolar membrane by diffusion from the site of higher to low partial pressure until the partial pressure of the two regions are equal. This process is a simple physical one which does not involve any secretory or active transport mechanism.

In the atmospheric air there is a high concentration of oxygen 20-95% ( $PO_2$  140mm Hg) while the proportion of carbon dioxide is low (0.04%).

The alveolar  $PO_2$  is about 100mm Hg and the  $PO_2$  of venous blood is about 40mm Hg. This pressure gradient is sufficient for the transfer of  $O_2$ . The  $PCO_2$  of venous blood is 46mm.Hg and that of alveolar air is only 6mm.Hg ( $1/10^{th}$  of  $O_2$ ), it is adequate for  $CO_2$  transfer by diffusion.  $CO_2$  diffuses 20 times faster than  $O_2$ .

### **Regulation of respiration :**

In the brain the medulla oblongata contains a respiratory center. This controls breathing. The respiratory center consists of an inspiratory center and an expiratory center. The axons from the nerve cells of these centres lead to the intercostals muscle through the intercostals nerves and the diaphragm via the phrenic nerves. These nerve fibres transmit impulses to the external intercostal muscles and internal intercostal muscles alternately. The walls of the alveoli have sense endings which are stimulated by changes in the tension of alveolar walls.

When the alveoli are stretched at the height of inspiration the receptors send stimuli to the expiratory center of the medulla through the vagus nerve which inhibits further inspiration. This sequence of events is called **Herring – Breuer reflex**.

In addition the medulla contains a pneumotaxic center which is connected to the breathing centre and helps to ensure rhythmic breathing. During inspiration, the inspiratory part of the respiratory center sends impulses to the pneumotaxic center which responds by sending impulses to the expiratory part of the respiratory center. The expiratory center is then activated and so the inspiratory center is inhibited reflexly, respiratory rhythm is controlled in this manner by these centers in the brain.

### **Pneumonia :**

Inflammation of the lungs due to infection is called pneumonia. Pneumonia is caused by viruses or bacteria. *Viral pneumonia* is due to adenovirus, respiratory syncytial virus or a coxsackie virus. The most common bacterial pneumonia is *Pneumococcal pneumonia*. Pneumonia may also be caused by a mycoplasma (an organism that is intermediate between a bacterium and a virus)

**Symptoms and Signs :** Symptoms and signs include fever, chills, shortness of breath and a cough that produces yellow - green sputum and occasionally blood.

**Treatment :** The drugs prescribed depend on the causative microorganism. They may include antibiotic drugs or antifungal drugs. Aspirin or paracetamol may be given to reduce fever. Oxygen therapy and artificial ventilation may be required.

### **Tuberculosis (TB)**

It is an infectious disease, caused in humans by the bacterium **Mycobacterium tuberculae**. It was once common world wide and was a killer disease. People infected with HIV are highly susceptible to tuberculosis and the disease is becoming more common again in communities with high rates of HIV infection.

**Causes :-** Infection is caused by airborne droplets (produced by coughing or sneezing). The bacteria breathed into the lungs multiply to form an infected “focus”. In a high proportion of cases, the body’s immune system then halts the infection and healing occurs. The infection can also occur in intestines, bones and kidneys.

**Symptoms :** The main symptom includes coughing (sometimes bringing up blood) chest pain, shortness of breath, fever and sweating (at night) poor appetite and weight loss. The main complications of tuberculosis of the lungs are pleural effusion. (Collection of fluid between the lung and the chest wall).

### **Bronchitis**

Bronchitis is the inflammation of the bronchi, the air ways that connect the trachea (wind pipe) to the lungs, resulting in cough that may produce considerable quantities of sputum (Phlegm). Two forms, of the disease are recognized as acute bronchitis (sudden onset and short duration) and chronic bronchitis (Persistent over a long period and recurring over several years). Both are more common in smokers and in areas with high atmospheric pollution.

**Acute bronchitis :** It is caused by viral infection or by the effect of air pollutants. Bacterial infection may cause acute bronchitis. Attacks occur more often in winter. Smokers, babies, the elderly and people with lung diseases are particularly susceptible.

### **Chronic Bronchitis :**

It is a form of bronchitis in which sputum is coughed up on most days for atleast three consecutive months. The disease results in narrowing and obstruction of the air - ways in the lungs. It often coexists with another form of lung disease, emphysema (widening of alveoli). Chronic bronchitis and emphysema together are called chronic obstructive lung disease (COLD) or chronic obstructive airways disease.

**Causes :** Pollution and smoking are the causes of chronic bronchitis. It stimulates the production of mucus in the lining of the bronchi.

## Circulation

### The Circulatory System

All cells of our body require constant nutrition and waste removal since they are metabolically active. Most of the body cells are located at some distance from the nutrient sources such as the digestive tract and sites of waste disposal such as kidneys. The cardiovascular system which consists of the heart, blood vessels and blood, connects the various tissues of the body. While the heart pumps the blood through the blood vessels, the blood delivers nutrients and collect waste products.

### Functioning of Human heart

Heart is a pumping organ. It receives blood from different parts of the body through the veins that open through **inferior** and **superior vena cavae** and **pulmonary veins**. While the right atrium receives deoxygenated blood, the left atrium receives the oxygenated blood from the lungs. When the wall of the atria contract the right and left atria pump the blood into the right and left ventricles respectively. A **pulmonary trunk** arising from the right ventricle takes away the blood to the lungs for oxygenation. The left ventricle gives rise to an **aorta**, from which oxygenated blood is supplied to the coronary arteries and the systemic circulation of the body.

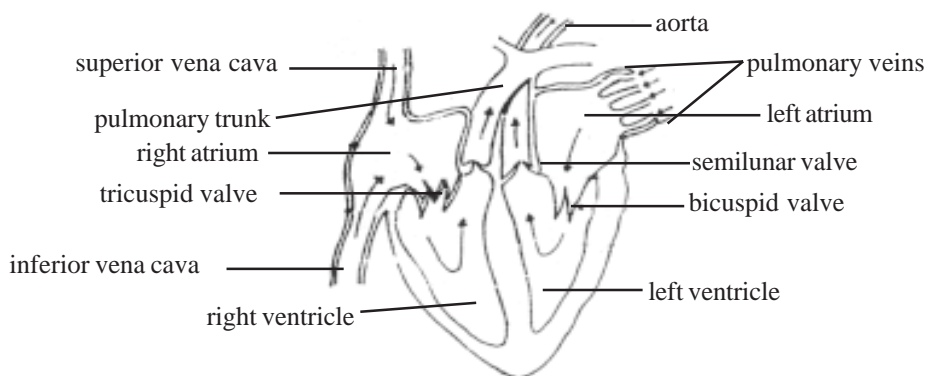
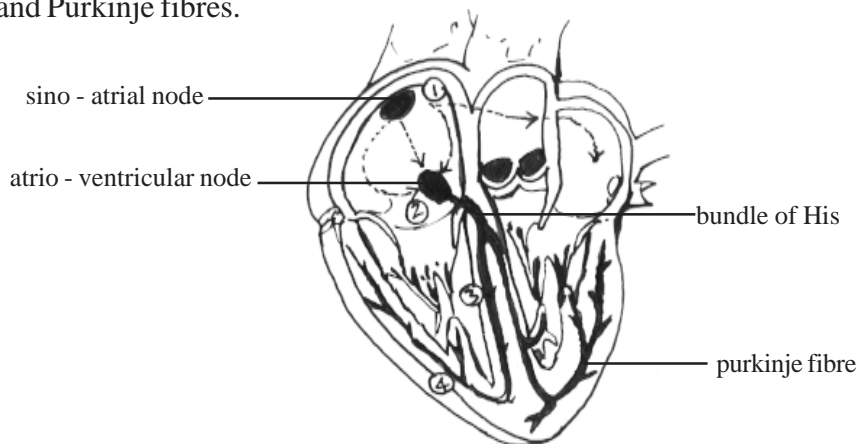

**Fig.1.15. Functioning of human heart**

The blood flow between the right atrium and the right ventricle is regulated by the **tricuspid valve**. The **bicuspid** or **mitral valve** regulates the flow on the left chambers of the heart. In the pulmonary trunk and the aorta, back flow of blood is prevented by a set of **semilunar valves**.

### Origin and conduction of heart beat

During pumping action of heart, the heart muscles cause rhythmic contraction and relaxation of the heart chambers in a specific sequence. The rhythmic, sequential functioning of the cardiac chamber is maintained by sino-atrial node (SA node), atrio-ventricular node (AV node), bundle of His and Purkinje fibres.



**Fig.1.16. Origin and conduction of heart beat**

The SA node situated in the upper, lateral wall of the right atrium is a small, flattened strip of muscle fibre that is 1.5cm x 3mm in size. The fibres of the SA node are closely associated with the muscles of auricles. SA node is capable of generating action potential that can travel throughout the auricles. The velocity of conduction is 0.3m/sec. The excitation from the SA node stimulates the AV node. The AV node in turn conducts the stimulus to bundle of His and Purkinje fibres. These myocardial fibres are found all over the wall of the ventricles. In the conduction of stimulus through the AV node and the fibrous system there is a delay in transmission.

### Cardiac cycle

The sequential events occurring from the initiation of one heartbeat to the commencement of the next is called as one **cardiac cycle**. In this cycle, the contraction phase is called **systole**. The relaxation phase is the **diastole**.

A single heart beat comprises a systole and diastole in both atria and ventricles.

**Atrial systole :** There is a continuous flow of blood into the right atrium through superior and inferior vena cava and coronary sinus. Simultaneously the left atrium receives blood from 4 pulmonary veins. There is a passive movement of nearly 70% of the blood. The remaining 30% is pumped into the ventricles by atrial contraction.

**Ventricular filling :** When the valves in between atria and ventricles open nearly two-third of the ventricle is filled. Remaining space gets filled up by atrial contraction.

**Ventricular systole :** As the atrial systole ends, the action potential generated by the SA node reaches the AV node and rest of the fibrous system. It causes contraction of the ventricular wall. Thus ventricular pressure results. The very strong ventricular pressure pumps the blood into respective arteries by causing the semilunar valves to open.

**Ventricular diastole :** Soon after the blood leaves the ventricles there is a fall in the ventricular pressure. The semilunar valves close and the atrial valves open to begin the next cycle.

**Heart sound :** The heart sound felt by a stethoscope is caused due to the closure and opening of the valves. The generation of sound is rhythmic. The first sound is louder (**lubb**) and of longer duration (0.16-0.90sec). It is due to closure of the atrioventricular valves at the beginning of the ventricular systole. The second sound is of shorter duration (**dubb**) (0.10sec). It is caused at the end of the ventricular systole by the closure of semilunar valve. The heart beats at the rate of about 72-80 times per minute in adults. The ventricular systole causes a wave of distension due to blood flow. It is called as **arterial pulse**. It can be felt on the wrist. The pulse rate corresponds to rate of heartbeat.

### **Coronary blood vessel and its significance**

There are two main coronary arteries the left and the right. The left one branches into the left circum flex artery and the left anterior descending artery. Right main coronary artery and the left coronary arteries branch off from the aorta, surround and penetrate the heart muscle. Arterioles and capillaries

branch off from the coronary arteries to supply heart muscle with oxygen rich blood. Deoxygenated blood drains into the coronary veins, which carry it back into the heart's right atrium.

Damage to the coronary blood vessel or narrowing of the coronary vessel leads to coronary artery disease (CAD). Blood flow through the arteries is restricted, leading to damages of the heart muscle. Heart disorders like heart attack, myocardial infarction, the chest pain or Angina are usually caused by CAD. In many parts of the world mortality from coronary artery disease is rising due to changing life style factors.

**Myocardial infarction** : Myocardial infarction is a coronary artery disease which involves sudden death of part of the heart muscle due to blockage in the coronary artery. It may cause severe unremitting chest pain.

**Causes** : The coronary arteries that supply the heart muscle with fresh oxygenated blood become narrowed. This narrowing is usually due to an accumulation of droplets of fatty substances, like cholesterol. The fibrous cover of the fat deposit sometimes rupture, triggering the formation of a blood clot. If this blood clot blocks the artery, blood flow to an area of the heart muscle stops, causing myocardial infarction and leads to death of tissue.

**Symptoms** : (1) Severe heavy crushing pain may spread up to the neck and in to the arms especially the left arm. (2) Sweating (3) Shortness of breath (4) Nausea and vomiting (5) Anxiety sometimes accompanied by fear of dying.

About one in five people experience no chest pain in myocardial infarction. However, there may be fainting, sweating and pale skin. This pattern of symptom is known as "silent infarction". This type of infarction is common in people with diabetes mellitus or those with elevated blood pressure.

#### **Risk factors**

1. Habitual cigarette smokers have a substantially increased risk of dying from myocardial infarction.
2. High blood pressure is a major risk factor and the risk increases with higher pressure.



3. The risk of atherosclerosis and coronary artery disease increases dramatically in those who are more than 30 percent overweight.
4. A raised blood cholesterol level increases the risk. A high fat diet is also a factor.
5. Physical inactivity is also a major factor.

**Angina pectoris** : Angina is a term that describes a strangling or constrictive pain. Angina has become synonymous with the heart disorder called Angina pectoris. This heart disorder refers to chest pain caused by insufficient supply of oxygen to the heart muscle, usually a result of poor blood supply. Angina pectoris usually occurs when the demand for oxygen is increased during exercise and at the time of stress. The pain usually comes on suddenly. The pain ranges from a tight ache to intense crushing agony. It lasts for 30 minutes or more and it is not relieved by rest.

**Causes** (1). Inadequate blood supply to heart due to coronary artery disease such as atherosclerosis (2). Severe attack of anaemia which reduces the oxygen carrying capacity of blood. (3). Polycythemia (Increased number of red blood cells) which thickens the blood, causing it to slow its flow through the heart muscle. (4). Thyrotoxicosis (a disorder caused by excessive secretion of thyroxine) can precipitate angina pectoris by making the heart work harder and faster than its blood supply will permit.

### **Angiogram**

Angiogram is a special contrast X ray and can be used to detect an abnormality in a blood vessel such as a narrowing of a large diseased artery.

### **Coronary Angiography**

Coronary angiography is used to image the arteries that supply the heart muscle with blood. Angiography can image narrowed or blocked coronary arteries, which are not visible on a normal X-ray. A local anesthesia is injected and a fine flexible catheter is passed within the femoral artery, through the aorta and into a coronary artery. A contrast dye is injected through the catheter and a series of x rays taken. The procedure is painless.

## **Coronary Angioplasty**

Coronary angioplasty is an operation done to clear flow of blood when the coronary arteries are narrowed or blocked by fatty deposits with the help of a balloon catheter. Under local anesthesia, a guide wire is inserted through the femoral artery in the groin and up into the affected coronary artery. A **balloon catheter** is passed up the wire and the balloon is inflated in the narrowed area to widen it. Sometimes, a metal tube called a **stent** is inserted afterward. It keeps the artery open.

**Coronary bypass surgery** is an operation to circumvent narrowed or blocked coronary arteries by grafting additional blood vessels to transmit blood flow. During this procedure the heart is temporarily stopped and blood circulation and oxygenation is taken over by a heart lung machine.

## **Atherosclerosis**

Atherosclerosis is narrowing of the arteries caused by plaques on their inner linings. These plaques are composed mainly of fats deposited from the blood stream. They disrupt the normal flow of blood through the affected artery. Atherosclerosis encourages thrombus and embolus (fragment of blood clot). Men are affected earlier than women because women are protected by natural oestrogen hormones.

**Causes** : Narrowing of the vessel is due to the development of raised patches called plaques. These plaques consists of athroma (fat and oil mixture), decaying muscle cells, fibrous tissue, clumps of blood platelets, cholesterol and calcium (abnormal blood clot)

### **Risk factors :**

Cigarette smoking, Hypertension, male gender, obesity, physical inactivity, diabetes mellitus, heredity, aggressive personality. Severe effects of atherosclerosis is stroke (loss of blood supply to brain), heart attack (loss of blood supply to heart).

## **Heart block**

Complete failure of the system that conducts electrical impulses from the upper to the lower heart chamber is called the heart block. Normally,

electrical impulses pass from the sinu auricular node to the atrio-ventricular node in the right atrium and then to the ventricle. In complete heart block, the impulses cannot reach the ventricle. This defective production of the sinu atrial impulses and its conduction in the heart is called heart block.

### **Echo cardiography**

Echo cardiography is a technique that uses ultra sound waves to image the interior of heart. It is used to diagnose disorders of the heart and the heart valves. The test is usually done by using an ultrasound transducer (probe) placed on the skin of the chest directly over the heart. In some cases a small probe is passed down the oesophagus.

### **Heart Valves :**

Heart valves are essential for precisely controlling the flow of blood in between auricles and ventricles and between the heart and major blood vessels. The valves are delicate pockets and their function is to prevent any backward flow of blood. The heart valve's functioning is vital for the efficiency of the heart as a pump.

The opening and more particularly the closing of heart valves during each heart cycle are responsible for heart sounds. Any of the four heart valves may be affected by stenosis (narrowing) which causes the heart to work harder to force blood through the valve. Incompetence or insufficiency (leakiness) makes the valve unable to prevent backwash of blood. These defects cause characteristic heart murmurs which can be heard by a doctor.

### **Rheumatic Heart Disease (RHD)**

It is a common form of disease found throughout the world. RHD is a crippling disease. Rheumatic fever develops due to an infection usually of the throat, caused by streptococcal bacteria. The condition is caused by the immune system attacking the body's own tissues in response to the infection. The symptoms of Rheumatic fever may include high fever, pain and swelling in bone joints.

### **ICCU - (Intensive Coronary Care Unit)**

All major hospital in urban towns and cities have. Intensive Coronary Care Unit to care for people in a critical or unstable condition.

They require continuous monitoring. This unit has a wide variety of sophisticated equipments for constantly monitoring the condition of the seriously ill patient. The patient may be connected to a ventilator to maintain breathing. Body fluids and blood sugar levels are maintained by intra venous infusion of salts and glucose. Nutrients may also be supplied intravenously. Urine is collected through a catheter. Blood pressure is continuously monitored by an automatic sphygmomanometer. Heart rate and rhythm are monitored by an ECG machine. Results are often relayed to a central monitoring unit. Monitors are fitted with alarms to alert the staff if there is any dangerous variation from the normal range.

### **Blood Pressure**

Blood pressure is the force exerted by the flow of blood against the walls of the main arteries while flowing through them. Blood pressure rises or falls as the heart responds to the varying demands made by the body during different activities such as exercise, stress and sleep.

Two types of pressure are measured. **Systolic** (the highest) is the pressure created, by the ventricular muscle and the elastic recoil of the aorta (main vessel leaving the heart) as the blood flows through it. **Diastolic** pressure (the lowest) is recorded during relaxation of the ventricles between beats. It reflects the resistance of all the small arteries in the body and the load against which the heart must work. The pressure wave transmitted along the arteries with each heart beat is felt as the pulse.

Blood pressure is measured using a sphygmomanometer. A healthy adult has a blood pressure reading of about 120/80 mm Hg (120 mm.Hg - systolic and 80 mm Hg - diastolic). This often rises normally with age to about 130/90 at 60. Abnormally high blood pressure is known as hyper tension. Hyper tension is defined as the “Systolic pressure equal to or greater than 160 mm Hg and (or) the diastolic pressure equal to or greater than 95 mm Hg”. Abnormally low pressure is termed hypotension.

## **Intensive of hypertension**

Hyper tension puts a strain on the heart and blood vessels. Apart from increasing the risk of having a stroke or developing heart failure or coronary artery disease, high blood pressure may cause kidney damage and retinopathy (damage to the retina at the back of the eye).

### **Causes**

Hypertension is linked with obesity and in some people to a high intake of salt, alcohol, smoking appears to aggravate the effects of hypertension.

**Preventive measures** :- Alcohol consumption and smoking should be avoided. Obese persons should make an attempt to reduce weight through restriction of food intake and try regular exercise. The dietary intake of animal fat (milk, cream, cheese fatty meat and eggs) should be reduced. A restricted intake of salt is recommended.

**Heart transplantation** involves replacement of a person's damaged or diseased heart by a healthy human heart taken from a donor in whom brain death has been certified. Heart transplantation in animals was first achieved in 1959. The first human heart transplant was performed by Professor Christian Bernard in South Africa in 1967.

Limiting factors for Heart transplant surgery

1. Problem of timing : A heart transplant is possible only when a suitable donor heart is available at right time.
2. Problem of fall-back system : If the heart is rejected (attacked by the body's immune system) the only hope for the patient is another transplant.
3. Problem in the certification of brain death.

The success of heart transplant lies in allowing doctors to certify brain death while the heart was beating. Heart is generatly removed for transplantation from a person certified for brain death by doctors.

## **Pulse rate**

The rhythmic expansion and contraction of an artery as blood is forced through it (pumped by the heart) is known as pulse.

The pulse can be described in terms of its rate (number of expansion per minute) its rhythm, strength and whether the blood vessel feels hard or soft.

The pulse rate is determined by counting the beats in a set period (minimum 15 to 20 seconds) and multiplying to give the beats per minute. The pulse rate usually corresponds to the heart rate which varies according to the persons state of relaxation or physical activity.

Abnormal rhythm may be a sign of heart disorder. If the pulse feels weak, it may be a sign of heart failure, shock or an obstruction to the blood circulation. Weak or absent pulse in one or both legs is a sign of peripheral vascular disease.

## **Cardio - Pulmonary Resuscitation**

Cardio - pulmonary resuscitation is the administration of the life - saving measures of external cardiac compression massage and mouth to mouth resuscitation (Artificial respiration) to someone collapsing with Cardiac arrest (Cessation of heart beat)

It is vital to restore the circulation of oxygen carrying blood to the brain as quickly as possible because permanent brain damage is likely to occur if the brain is starved of oxygen for more than three to four minutes

## **The blood :-**

The blood is a fluid connective tissue. It consists of liquid plasma and cells. The plasma makes up 55% of the total volume and 45% of cells or formed elements. The total blood volume in human female is about 4-5 litres and 5-6 litres in males.

**Plasma :-** The blood plasma is a slightly alkaline fluid. It is straw coloured.

## Composition of plasma

### Components

### Functions

1. <b>Water</b>	- as a solvent and suspending medium for blood components.
2. <b>Plasma proteins-</b> Albumin Globulins Fibrinogen	- Osmotic pressure. - Antibody formation - Blood clotting.
3. <b>Ions</b> - Na, K, Ca, Mg, Cl <sub>1</sub> , Fe, PO <sub>4</sub> <sup>3-</sup> , H and HCO <sub>3</sub> <sup>2-</sup>	- Osmosis, acid-base balance. - buffer etc.,
4. <b>Nutrients</b> - Glucose, amino acids, triglycerides, cholesterol, vitamins.	- source of energy, building blocks - enzyme activity.
5. <b>Waste products</b> - Urea, uric acid creatinine, ammonia } Bilirubin Lactic acid	- excreted by the kidneys. - breakdown product of erythrocytes - product of anaerobic respiration.
6. <b>Gases</b> Oxygen CO Nitrogen <sup>2</sup>	- for aerobic respiration - waste product of respiration - inert gas.
7. <b>Regulating substances</b> Hormones and Enzymes	- body functions

### Blood cells or formed elements

There are three types of blood cells or corpuscles. They are

#### 1. Red Blood Corpuscles (RBC) or Erythrocytes

These are circular, biconcave and non-nucleated cells. Males have about 5.2 million erythrocytes per cubic millimeter of blood (range : 4.2-5.8 million). Females have about 4.5 million/mm<sup>3</sup> (range 3.6-5.2 million).

Each disc shaped RBC is about 7.5  $\mu\text{m}$  in diameter. Their main component is a pigmented protein, **haemoglobin**. It gives red colour to the blood. The haemoglobin transports  $\text{O}_2$ . The oxygenated form of haemoglobin is called **oxyhaemoglobin**.

Erythrocytes stay in circulation for about 120 days in males and 110 days in females. They are manufactured in the marrow of bones such as ribs and vertebrae. They disintegrate in the spleen and liver.

## 2. White Blood Corpuscles (WBC) or Leucocytes

These are clear cells lacking haemoglobin. They are nucleated cells exhibiting amoeboid movement. They protect the body against invading micro-organisms and remove dead cells from the body. There are five types of leucocytes.

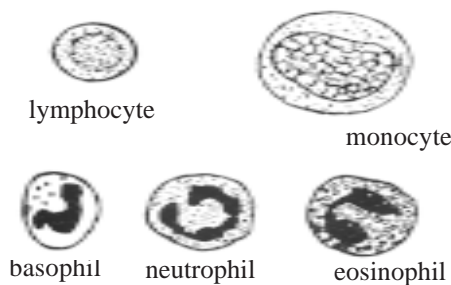

**Fig.1.17. Different types of WBC**

a). **Neutrophils** - These are the most common type of leucocytes (60-70%) in the blood. Their nuclei can occur in more than one form. Hence they are called **polymorphonuclear neutrophils** (PMN).

b). **Eosinophils** (0.5-3.0%) - They are motile cells that leave the circulation to enter the tissues during an inflammatory reaction. During allergy reaction their number increases.

c). **Basophils** (0.1%) - They play a role in allergic and inflammatory reaction. They contain heparin which inhibits blood clotting.

d). **Lymphocytes** (20-30%) - These are smallest leucocytes. They are more common in lymphatic tissues namely the lymph nodes, spleen, tonsils and thymus. Lymphocytes, called **B-cells** can produce proteins called **antibodies** that can get attached to the bacteria and destroy them. **T-cells**



protect us against viruses by attacking and destroying cells in which viruses are reproducing.

e). **Monocytes** (1-4%) - These are largest leucocytes. They destroy bacteria, dead cells and cell fragments. During chronic infection their number increases.

### 3. Blood Platelets or Thrombocytes

These are minute fragments of cells that play a very important role in coagulation of blood. Their life expectancy is 5-9 days.

#### Clotting of Blood or Haemostasis

When a blood vessel is damaged, it results in coagulation or clotting of blood. A blood clot is a network of thread like protein fibers, called **fibrin**, that traps blood cells, platelets and fluid.

The clotting depends on several proteins in the plasma. They are called **coagulation factors**. Normally these factors are in an inactive state. After injury they are activated to produce a clot. The activation can happen in three stages.

**Stage 1 - Formation of thrombokinase** - Damaged tissues release a mixture of lipoproteins and phospholipids called **tissue factor** (TF) or thromboplastin. This factor in the presence of certain factors in the blood form a complex called prothrombinase or **thrombokinase**.

**Stage 2 - Formation of thrombin** - During this stage soluble plasma protein prothrombin is converted into the enzyme thrombin by prothrombinase. Prothrombin synthesis in liver requires vitamin K.

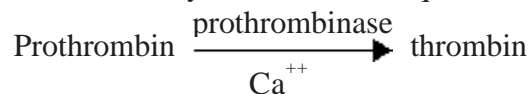

**Stage 3** - The soluble plasma protein fibrinogen is converted to insoluble protein, fibrin by thrombin

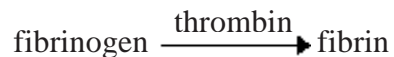

The fibrin forms the fibrous network of the clot.

## **Thrombosis**

The formation of a thrombus or blood clot within an intact blood vessel is called thrombosis. Clotting is a normal response that prevents bleeding when a blood vessel wall is injured. However thrombus formation is abnormal if it occurs in an intact vessel.

A thrombus within an artery may block the artery preventing blood and oxygen from reaching the organ or tissue supplied by an artery.

A thrombus that forms within one of the coronary arteries supplying heart muscle is known as coronary thrombosis. This is the cause for heart attack .

A thrombus within arteries supplying the brain is known as **cerebral thrombosis**. It causes **stroke**. When a portion of a thrombus clot becomes fragmented and enters the circulating blood, it is called **embolus**. Embolus may block a circulation to vital parts resulting in serious consequences such as stroke.

## **Co-ordination systems**

### **Nervous Co-ordination**

All living animals maintain a constant inner state, irrespective of changes happening in the environment. This phenomenon is named as homeostasis. It is achieved due to coordination of response. The coordination is due to the animal body, acting as a self-regulating system capable of making appropriate responses to stimuli.

The coordinating system of the body contains suitable structures for detecting stimuli, transmitting information and responding to stimuli. There are feedback mechanisms that ensure that degree of responses is related to the intensity and direction of the stimuli.

Mammals have two main coordinating systems, namely the nervous system and the endocrine system.

## Nervous system

The neurons are the basic units of the nervous system. They help in conducting the stimuli in between the receptor organs - spinal cord, brain and effector organs. The neurons conduct the stimulus as electrochemical events. These sequential events involve migration of 'Na' and 'K' ions outside and inside the neuronal cells. This phenomenon is known as **Sodium-Potassium pump**. This sequence of electro chemical events is known as the **impulse**.

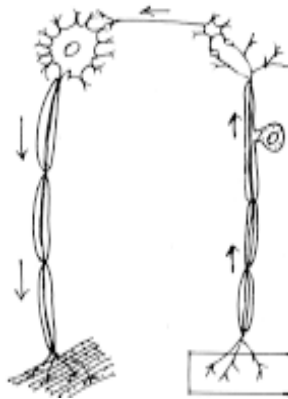

**Fig.1.18. A synapse**

The junctions of neurons in nerve pathway are called the **synapses**. A synapse is formed between the bulb-like end structure of the axon called **boutons** and the cyton or dendrite of the adjacent neuron. At the junction there is a gap called the **synaptic cleft**, which is usually about 10 to 20 nm. At this point, transmission of stimulus happens through transmitter substances such as **acetylcholine**.

In the nervous system the bundles of parallel axons of the nervous tissue having myelin sheath constitute the **white matter**. Collection of neurons having unmyelinated axons form the **grey matter**.

The axons make up the white matter of the CNS for nerve tracts. They propagate action potentials. The grey matter performs integrative functions. The outer surface of the brain (cortex) and the central area of the spinal cord consist of grey matter. Within the brain, collections of grey matter form centers called **nuclei**.

## **The brain**

There are more than a thousand million neurons in the adult human brain. An estimate shows that the cerebral cortex alone has about  $10^{2783000}$  synapses. Thus the brain is a complex organ.

On structural and functional basis the brain can be divided into 3 regions. They are (1). Fore brain, (2). Midbrain, (3). Hind brain.

**Fore Brain (Prosencephalon) :-** This region of the brain comprises **Diencephalon** and the **cerebrum**.

The diencephalon is formed of **thalamus** and **hypothalamus**.

**Thalamus :-** It is the largest part of the diencephalon. This region contains a cluster of nuclei. Most of the sensory inputs are conducted to the cerebral cortex through the thalamus. Axons carrying auditory, visual and other sensory informations synapse with specific nuclei of this region. This region may also influence mood and general body movements due to strong emotions such as fear or anger.

**Hypothalamus :-**

This region contains small nuclei and nerve tracts. The nuclei called **mamillary bodies** are involved in olfactory reflexes and emotional responses to odours. The funnel shaped infundibulum from the hypothalamus connects it to the posterior **pituitary** or **neurohypophysis**. This region controls the secretions of the pituitary gland.

The hypothalamus receives inputs from several sensory systems such as tongue, nose and external genitalia. It is associated with emotional and mood relationships. It provides a relaxed feeling. Feeling good after a meal, rage and fear are also due to this region. It also coordinates responses to the sleep-wake cycle with other areas.

**Cerebrum :-**

It is the largest part of the brain. It weighs about 1400g in males and 1200g in females. Larger brains are normally associated with larger bodies and not with greater intelligence.

The grey matter on the outer surface of the cerebrum is the **cortex**. It forms clusters deep inside the brain called **nuclei**. The inner part of the brain, in between the cortex and the nuclei has white matter named as **cerebral medulla**.

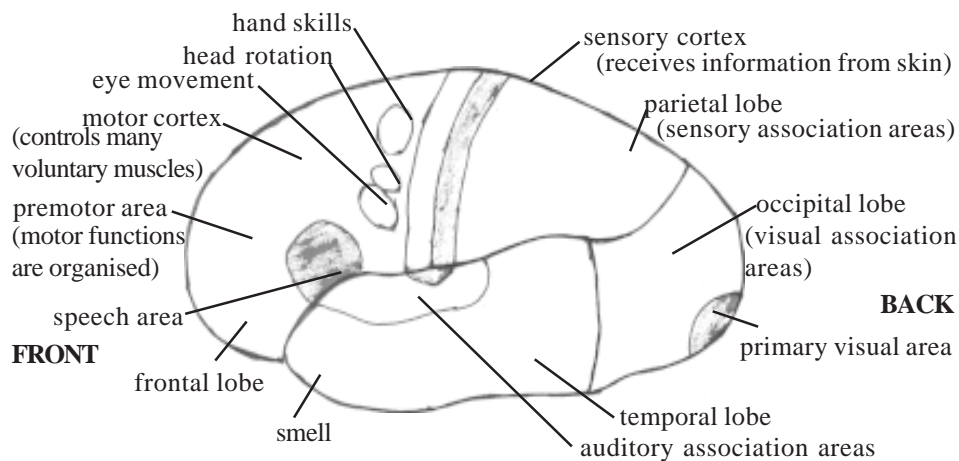

**Fig.1.19. Cerebral cortex - functional areas**

### **Cerebral cortex :-**

The cortex contains several primary sensory areas. These areas include **taste area**, **primary auditory cortex** for processing auditory stimuli, **visual cortex** for perceiving visual images and areas for other **cutaneous sensations**.

The cortical areas adjacent to the primary sensory centers are called the **association areas**. These areas are involved in the process of recognition. For example the sensory stimulus from the retina of the eye reaches the **visual association area** of the cortex. Here the visual information is compared with past experiences. Further this area has connections with other parts of the cortex, which influence decisions. Thus visual information is judged several times. This may be one of the reasons why two people who witness the same event can present somewhat different versions of what happened.

The **primary motor area** of the cortex controls many voluntary movements, especially the finer motor movements of the hands. Muscle groups such as facial muscles, that have many motor units have greater innervation. They are represented by a large area of the motor cortex.

Anterior to the primary motor area are the **premotor area**. It is the staging area in which motor functions are organized before they are initiated in the motor cortex. For example, if a person decides to lift a hand, the neurons of the premotor area are stimulated first. This area determines the order and the degree to which the muscles must contract.

The **prefrontal area** provides motivation and foresight to plan and initiate movements. This area is well developed only in primates and especially in humans. Our emotional behaviour and mood are controlled by this area.

#### **The midbrain or Mesencephalon :-**

The roof of this region contains four nuclei. The nuclei form mounds. They are collectively called **corpora quadrigemina**. It is formed of 2 **superior colliculi** or mounds and 2 **inferior colliculi** or mounds. The superior colliculi are involved in visual reflexes. They control eye and head movements. They aid in visual tracking of moving objects. The inferior colliculi are involved in hearing.

#### **The hindbrain or Rhombencephalon :-**

This part of the brain comprises Cerebellum, Pons and Medulla oblongata.

#### **Cerebellum :-**

This region communicates with other region of the CNS through three large nerve tracts called the **cerebellar peduncles**.

The cerebellum consists of following three parts

<b>Parts</b>	<b>Control</b>
1. flocculonodular	balance and maintenance of muscle tone.

- |  |  |
|--|--|
| 2. vermis – anterior part                          | motor coordination and muscle tone.      |
| 3. vermis – posterior part and lateral hemispheres | fine motor coordination and muscle tone. |

Cerebellar dysfunction may cause decreased muscle tone, imbalance and lack of co-ordination.

### **Pons :-**

This region relays information from the cerebrum to the cerebellum. It also contains sleep center and respiratory centers. These centers along with medulla help to control respiratory movements.

### **Medulla oblongata :-**

It is the most inferior part of the brain stem. It acts as a conduction pathway for both ascending and descending nerve tracts. The **nuclei** inside medulla oblongata function as centers of several reflexes involved in the regulation of heart rate, blood vessel contractions, breathing, swallowing, vomiting, coughing and sneezing.

### **Memory**

The term ‘memory’ denotes a specific brain function of storing and retrieving of informations related to experiences. The duration of memory varies from few seconds or hours, to several years.

### **Types of memory :-**

**1. Sensory memory :-** It means the ability to retain sensory signals in the sensory areas of the brain for a short interval of time following the actual sensory experience. This is the initial stage of memory process.

**2. Primary memory :-** It is the memory of facts, words, numbers, letters or other information. The information in this memory is instantaneously made available so that a person need not search through his or her mind for it.

**3.Secondary memory :-** It is the storage in the brain of information that can be recalled at some later time(hours, days, months or years later). This is also called long-term memory, fixed memory or permanent memory.

**Physiology of memory :-** Certain anatomical, physical or chemical changes occur in the pre synaptic terminals (a part in the neuron) or perhaps in whole neurons that permanently facilitate the transmission of impulses at the synapses.

All the synapses (nerves junctions) are thus facilitated in a thought circuit. This circuit can be re-excited by any one of many diverse signals at later dates thereby causing memory. The overall facilitated circuit is called a **memory engram** or a **memory trace**.

**Amnesia :-** Amnesia means memory loss. It is the inability to recall memories from the past.

### **Sleep**

Sleep is defined as a state of unconsciousness from which a person can be aroused by appropriate sensory or other stimuli.

#### **Types of sleep :-**

During each night a person goes through two stages of sleep that alternate with each other. They are (1) Slow wave sleep and (2) REM sleep.

**Slow wave sleep :-** In this type of sleep the brain waves are very slow. Though this sleep is frequently called “dreamless sleep”, dreams actually occur very often and even nightmares occur during this sleep. During this sleep the process of consolidation of the dreams in memory does not occur. This sleep is highly useful in decreasing blood pressure, respiratory rate and basal metabolic rate.

**REM sleep or Rapid eye movement sleep :-** In a normal night sleep, REM sleep lasting 5-30 minutes usually appear on an average every 90 minutes. It is usually associated with active dreaming. The muscle tone throughout the body is exceedingly depressed during this sleep indicating strong inhibition of the spinal projections from the reticular formation of the brain stem.

The heart rate and respiration usually become irregular, which is characteristic of the dream state. During REM sleep, the brain is quite active. But, the brain activity is not channeled in the proper direction for persons to be aware of their surroundings and therefore to be awake.



**Physiological effects of sleep :-** Sleep restores both normal sensitivities of nervous system and “balance” among the different parts of the central nervous system. Due to good sleep arterial blood pressure falls, pulse rate decreases, skin vessels dilate, muscles fall into relaxed state and overall metabolic rate of the body falls by 10-30 percent.

## **Stroke**

“Stroke is a rapidly developed clinical sign of focal disturbances of cerebral function lasting more than 24 hours or leading to death”. (WHO)

In spite of the presence of factors inhibiting the coagulation of blood within vessels, clotting may occur at times. Such clots frequently are formed in veins than in arteries. The blood clot or thrombus formed in the streaming blood is called **thrombosis**. A clot in the cerebral vessel is called stroke or cerebral thrombosis. Stroke may be caused due to vascular occlusion, which is a blockage in the cerebral artery. The occlusion and stroke lead to infarction. The infarction leads to abnormal symptoms in the brain.

Vascular occlusion is of two types viz., Thrombotic and embolic. An embolus is a portion of the thrombus clot that becomes detached and enters into circulating blood. An embolus may block the circulation to vital parts leading to serious consequences.

**Brain haemorrhage:** Haemorrhage or bleeding of brain vessels may be caused by hypertension which results in bursting of blood vessels or due to **aneurysm** wherein the arterial wall bulges and forms a sac like structure and ruptures later. The stroke and the haemorrhage are also due to vascular malformations.

Stroke causes both **physical**; and **mental** crippling. It is a worldwide health problem. It can occur at any age. Several risk factors may lead to stroke and brain haemorrhage. They are cardiac abnormalities, diabetes, elevated blood lipids, hypertension, obesity, smoking and stenosis (narrowing of valvular orifice), etc.

One can control stroke by controlling the above risk factors.

## **Alzheimer's Disease**

Alzheimer's disease is otherwise called **Chronic brain syndrome**. It is characterized by progressive loss of memory followed by general loss of cognitive functions and death. This disease becomes more and more prevalent among aged persons. Occasionally people develop the disease before 50 or even before the age of 40. It affects less than 5 per cent of the population between 65 – 74. In the aged people beyond 80 almost 50 per cent are affected invariably.

Alzheimer's disease is associated with the atrophy of cerebral cortex. Neurons undergo degeneration. In the damaged regions, plaques formed by the degeneration of axons and dendrites, appear.

Alzheimer's disease is commonly attributed to **genetic mutation**. People with Down syndrome are invariably affected with this disease. It is presumed that atleast two or three genes in chromosome 21 are linked to this disease. However genetics is not the only **etiological factor**, for this disease.

## **Meningitis (Brain fever)**

The term Meningitis refers to the inflammatory condition of the brain membranes and the sub-arachnoid space. Meningitis may be caused by bacterial infection, or viral infection or fungal infection. The clinical symptoms of meningitis include headache, photophobia, irritability, stiffness of the neck, fever and other neurological symptoms.

## **Conditioned reflex**

The Russian Physiologist **Ivan Pavlov** first demonstrated 'the conditioned reflex' phenomenon. The cerebral cortex controls the conditioned reflexes. It is also called the classical conditioning, in which a stimulus comes to elicit a response similar to the response produced by some other stimulus.

In his experiment, Pavlov presented a dog with a sound of a bell (**Neutral stimulus**) followed by meat (**Unconditioned stimulus**). This combined stimuli stimulated the dog to salivate (**unconditioned response**). After many such conditioned pairings the sound alone (**Conditioned stimulus**) would stimulate the dog to salivate (**Conditioned response - CR**).

The bell sound initially called the neutral stimulus which after a number of trials pairing with the unconditioned stimulus (UCS) viz., the meat piece, becomes the conditioned stimulus. Similarly the salivation of the dog during the initial trials of pairing (NS + UCS) is called Unconditioned Response (UR). This unconditioned response later on becomes designated into a conditioned response (CR). It will be elicited just by bell sound (CS).

The conditioned reflexes are developed in animal's life in association with previously established reflexes. This is the basis of learning and memory.

### **Electroencephalography (EEG)**

The tissues of the cerebral cortex consists of a vast range of neuronal elements. The brain tissue is characterized by a continuous rhythmic oscillation of electric potential. EEG is a device to record electrical activity of the brain via electrodes attached to the scalp. It displays a net average of all the neuron's potential. EEG yields information about the brain function in health and disease. It provides data about brain functions during various functional or behavioral activities such as sleeping or waking states. It is also used in the diagnosis of brain disease such as tumour, lesions and also in epilepsy.

### **Right and Left brain concept**

In the cerebral cortex, the left hemisphere is connected to the skin receptors in the right half of the body. It also controls the muscles on the right side of the body.

The right hemisphere is connected to the sensory receptors on the left half of the body. Further, it controls muscles on the left side. Both the hemispheres are also connected to the eyes. The sensory nerve tracts of the left eye is connected to the right hemisphere and the right eye to the left hemisphere through the optic chiasma. Thus the left half sees the right half of the world while the right half sees only the left half of the world.

The left and right hemispheres exchange information through a set of axons called the corpus callosum, and also through anterior commissure and hippocampal commissure. The two hemispheres have their own specific functions and the above division of functions or labour between the two hemisphere is called '**lateralization**'.

The corpus callosum enables the right and left half of the brain to operate cooperatively, instead of independently. The anterior commissure plays an important role in unifying the emotional responses of two sides of brain. Damage to the corpus callosum blocks the exchange of information between the two hemispheres.

The left brain is concerned with language, number skills, reasoning, spoken language, scientific skills and right hand control.

The right brain is concerned with art awareness, imagination, visual functions, emotions, music awareness, 3D forms and left hand controls. The left brain is meant for analytical tasks while the right brain is for creative tasks.

### **Spinal cord functioning**

The spinal cord remains as a connecting, functional nervous structure in between the brain and sensory / effector organs. The sensory inputs received by sense organs are conducted towards appropriate regions of the brain. Similarly from the brain motor sensations are transmitted towards effector structures. Further as the brain, the spinal cord can effect motor initiation and bring about an effect. This activity is known as reflex action.

### **Reflex action**

Reflex action is the spontaneously involuntary response caused due to stimulation of receptor organ. E.g. The quick closure of eye lid when some object touches the eyelashes.; the sudden withdrawl of hand when the hand touches hot pan.

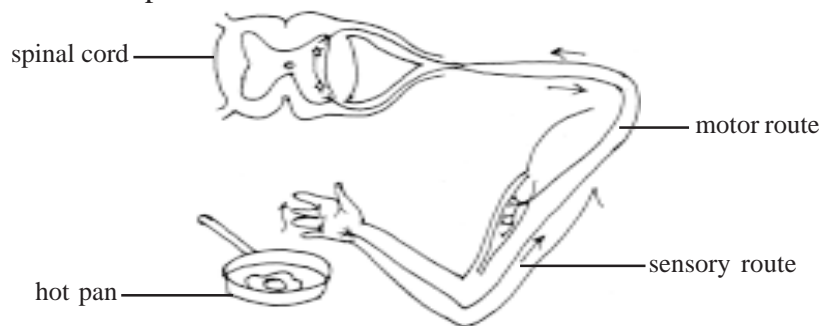

**Fig.1.20. Route of reflex action**

A reflex action is an involuntary process and does not involve the intervention of consciousness. The anatomical basis of reflex action is the reflex arc. It is a nerve chain between receptor organ and effector organ. The reflex arc has the following route.

Sensory organ → sensory or afferent neuron → grey matter of the spinal cord → intermediary or relay neuron → efferent or motor neuron → effector organ.

### **Cerebro Spinal Fluid (CSF)**

The ventricle of the brain and the central canal of the spinal cord contain, a clear fluid similar to plasma called **cerebrospinal fluid** (CSF). CSF is formed by a group of cells called the choroid plexus located inside the four ventricles. In human the volume of CSF is 150 ml and the rate of its secretion is 550 ml/day.

#### **Functions:**

1. CSF cushions the brain against mechanical shock when the head moves.
2. It acts as a protective covering for the CNS and confers buoyancy to brain.
3. The CSF also provides a reservoir of hormones and nutrition for the brain and spinal cord.
4. It acts as a **mechanical buffer**. Remaining inside and outside the CNS, it equalizes the mechanical pressure. If the intracranial pressure tends to rise the CSF is pressured out. If the pressure tends to fall, more CSF is retained.

### **Chemical co-ordination**

The two major systems of the human body that coordinate, regulate and integrate almost all physiological functions are the nervous system and the endocrine system. The information transmitted by the nervous system in the form of electric impulses is conducted rapidly in the neurons. The signals from the endocrine glands or ductless glands are communicated by means of chemical substances called **hormones**. The hormones are secreted into and carried by the blood stream from their point of origin to the target organs or tissues. In the target tissues, the hormone action is manifested.

A hormone may be defined as a chemical substance synthesized by the cells of endocrine glands and carried by blood to the site of action where it exerts its physiological effects. Hormones are considered as **chemical messengers**.

### **Functions of Endocrine glands:**

Endocrine glands play an important role in maintaining the constancy of internal environment (milieu interior) and hormones integrate and regulate various physiological functions. They regulate the general metabolism viz., the metabolism of carbohydrates, proteins, fats, minerals and water. The endocrine glands also control the reproductive functions of animals. The adrenal hormones prepare the body to meet emergency and stressful situations. The hormones are also responsible for **intercellular communication**.

Each endocrine gland may secrete excess quantities of its own hormone. However, once the normal physiological response is over, this information is fed back to the endocrine gland. As a result, its secretion decreases or inhibited. Conversely, if the secretion of the hormone is subnormal and the physiological effects or responses are reduced, the information is taken to the gland and it secretes the hormone at an increased rate. Thus, **homeostatic equilibrium** is restored.

### **Hypothalamus**

Hypothalamus represents the central part between the nervous system and endocrine system. Though pituitary is designated as the master gland controlling the functions of other endocrines, the pituitary itself is controlled by the hypothalamus. The above control is effected by means of releasing hormones or factors and inhibitory hormones or factors. The hypothalamus is connected to the posterior lobe of pituitary by the **neural tissue** and to the anterior lobe of pituitary by the **epithelial tissue**. The releasing factors from the hypothalamic cells reach the anterior pituitary through their axons. The hormones from the pituitary enter the blood stream.

### **Pituitary gland:**

The Pituitary gland is otherwise called the hypophysis. It is located at the base of the brain. It is approximately 1 cm long, 1-1.5 cm wide and 0.5

cm thick. It weighs about 500 mg. Anatomically the pituitary gland is divisible into anterior **adenohypophysis** and posterior **neurohypophysis**. The adenohypophysis consists of three lobes or zones namely, **Pars intermedia**, **Pars distalis** and **Pars tuberalis**. The anterior lobe or adenohypophysis is embryologically derived from the roof of the mouth as a dorsal pouch. The neurohypophysis on the other hand, originates from the floor of diencephalon, as a downward growth.

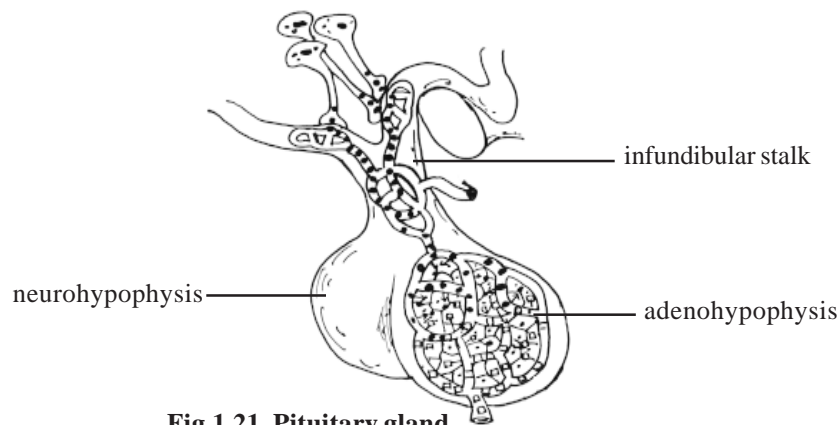

**Fig.1.21. Pituitary gland**

### **The hormones of anterior pituitary:**

The adenohypophysis is responsible for the secretion of six trophic hormones or tropins. They are **growth hormone** or **somatotropic hormone (GH/STH)**, **thyrotropic hormone** or **thyroid stimulating hormone (TSH)**, **Adrenocortico tropic hormone (ACTH)**, **Follicle Stimulating Hormone (FSH)**, **Leutinizing hormone (LH)** and **Prolactin** or **Leuteotropic hormone (LTH)**.

### **Metabolic functions of the growth hormone:**

Growth hormone is responsible for various general metabolic functions. It affects the diverse spectrum of integrated metabolic reactions, which participate in the overall process of growth. Growth hormone influences carbohydrate, protein and lipid metabolism. Growth hormone stimulates both the formation of cartilage (Chondrogenesis) as well as bone (Osteogenesis). It causes the retention of minerals such as nitrogen, potassium, phosphorus, sodium, etc useful for growth.

Deficiency of growth hormone or hyposecretion in children results in retarded growth. The premature arrest of skeletal development causes **dwarfism**. The adult dwarfs will grow to a height of only 0.9 to 1.2 meter. They never attain puberty or do not develop secondary sexual characters.

Excessive secretion of GH results in over growth of the skeletal structures and the person may reach a height of 7 to 9 feet (gigantism). The excessive GH in adults also results in the increase in thickness of lower jaw and disproportionate over growth of bones of the face, hands and feet. The above condition is known as **acromegaly**.

### **Thyrotrophic hormone or thyroid stimulating hormone (TSH):**

TSH is a glycoprotein with a molecular weight of 28,000 daltons. It is made up of 211 amino acids. The specific target organ for the TSH is the thyroid gland. It stimulates the thyroid to secrete the thyroxine. There exists a **negative feedback mechanism** between the circulating level of thyroxine and the hypothalamic releasing factor. When the thyroxine is less in blood, the hypothalamus produces more TSH releasing factor which on reaching the pituitary stimulates secretion of TSH. TSH on reaching the thyroid, stimulates the thyroid to secrete more hormone. Conversely, when there is excess thyroxine in the blood, the production of thyroxine is controlled by non-secretion of releasing factor from the hypothalamus.

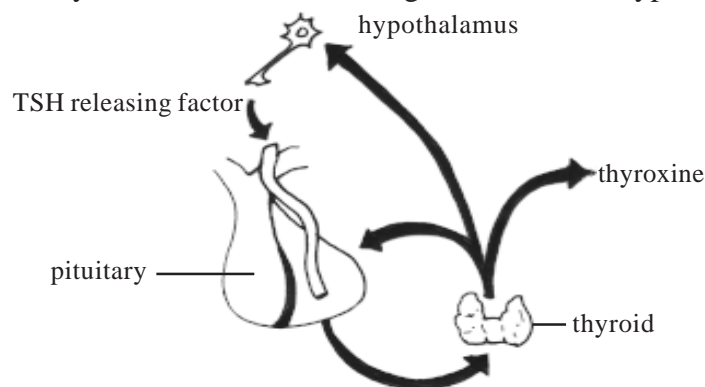

**Fig.1.22. Negative feedback mechanisms of TSH**

### **Adreno cortico trophic hormone (ACTH) :**

It is a protein hormone. ACTH also functions by the negative feedback mechanism and stimulates the adrenal cortex and its secretion. Its other



functions include the stimulation of formation of melanin pigments in the melanocytes of the skin, stimulation of insulin secretion and mobilization of fats from adipose tissue.

### **Follicle stimulating hormone (FSH):**

It is a gonadotropic hormone that directly stimulates the gonadal functions in both males and females. The human FSH is a small glycoprotein. The target organs for FSH in the females are the ovaries. It promotes the growth of graffian follicles and thereby increases the total weight of the ovary. It also promotes the secretion of oestrogen. In males, the target organs for FSH are the testes. It directly stimulates the germinal epithelium of the seminiferous tubules and augment the rate of spermatogenesis.

### **Leutinizing hormone or Interstitial cells stimulating hormone (LH or ICSH):**

Human ICSH or LH is a glycoprotein. In females, the LH stimulates the ripening of ovarian follicles and induces ovulation. In males, the LH or ICSH, specifically affects the leydig cells or interstitial cells of the testes and stimulates the synthesis and secretion of the male hormone (Androgen) testosterone.

### **Prolactin or Luteotropic hormone (LTH):**

Prolactin is called by several names such as luteotropin, luteotrophic hormone, lactogenic hormone, mammotropin etc. It is a protein hormone. Its main function is stimulation of milk formation or initiation of lactation following parturition in mammals. It also stimulates the corpus luteum to secrete the progesterone. Prolactin together with estrogen stimulates the growth of mammary glands and makes it ready for milk secretion.

### **Hormones of Neurohypophysis:**

The neurohypophysis or the posterior pituitary secretes oxytocin and vasopressin. **Oxytocin** contains a sequence of amino acid residues. The term oxytocin refers to rapid birth. This hormone directly stimulates the smooth muscles of uterus and causes the contraction, and helps in the delivery of foetus. Another major physiological role of oxytocin is the secretion of milk from the lactating breast. Oxytocin stimulates the myoepithelial cells, which

surround the alveoli and ducts of mammary gland. The contraction of myoepithelial elements in turn expels the milk from the alveoli of the breast into the larger ducts or sinuses. From the sinuses, the milk is ejected out.

### **The vasopressin:**

It is otherwise called as the antidiuretic hormone (ADH). Its main function is the retention of water inside the body by acting on the renal tubules. ADH increases the permeability of the distal tubules and collecting ducts and promotes the reabsorption of water from the renal filtrate. It causes the constriction of all blood vessels and increases the blood pressure. It also helps in the retention of urea. ADH deficiency leads to **Diabetes insipidus**. The symptoms of Diabetes insipidus are excretion of large volumes of dilute urine (**polyurea**), combined with an intense thirst leading to the consumption of large quantities of liquids (**polydipsia**).

### **Thyroid gland and thyroxine**

Thyroid gland consists of a pair of lobes, which lie one on either side of larynx in the neck region. The paired lobes are joined by a narrow anterior bridge of glandular tissue called Isthmus of the thyroid. The lobes of thyroid in turn are divided into many lobules. The lobules consist of follicles. The follicles are called acini (acinus – singular). Each acinus is lined with glandular cubical epithelial cells. The cavity of acinus is filled with a gelatinous material called colloid, which contains the thyroxine. The hormone thyroxine is an iodinated hormone. It contains 65% iodine. The amino acid residue in thyroxine is **tyrosine**.

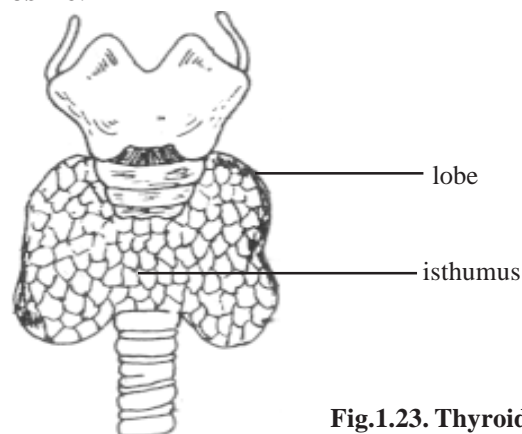

**Fig.1.23. Thyroid gland**

### **Functions of thyroid:**

Thyroxine stimulates normal growth and development, especially the skeletal and nervous systems. It controls the rate of cellular oxidation and increases the basal metabolic rate. The basal metabolic rate (BMR) is defined as the amount of heat produced in the body in a given time, in complete state of physical and mental rest at 20°C room temperature.

### **Actions of thyroxine:**

(i) This hormone is very essential for the development of nervous system particularly at the time of birth and during the first year, (ii) This hormone increases the metabolism of all tissues except brain, gonads and accessory sex organs, lymph nodes, spleen and lungs, (iii) The most important function is to increase the absorption of glucose from the small intestine. (iv) This hormone reduces serum cholesterol level, (v) It promotes protein anabolism, and helps in growth, (vi) It increases heart beat rate, force of contraction and pulse pressure, (vii) Presence of optimum level of thyroxine in the blood maintains efficient muscle functions and (viii) The optimum level of thyroxine in the blood is also necessary for normal gonadal function.

### **Hypothyroidism:**

The physiological effect due to deficiency of thyroid hormone is referred to as hypothyroidism. It is manifested by iodine deficiency and **simple goiter, cretinism** and **myxoedema**. If the dietary intake of iodine becomes inadequate (below 10 micro grams per day) the synthesis of thyroxine is impaired. As a result, the thyroxine level falls in circulation and secretion of TSH increases, causing the hypertrophy of thyroid gland as a consequence. The thyroid enlarges to enormous proportions. This is called simple **goiter**. This condition is also called endemic goiter. It is caused due to lack of iodine in the soils of different regions of the world.

### **Cretinism:**

Cretinism is found in children who are deficient of thyroxine hormone from the time of birth. The characteristics of cretinism are, retardation of mental growth to extreme degree, dwarf stature, protruding tongue and

abdomen, low basal metabolic rate, subnormal body temperature, retardation in skeletal growth and arrest of pubertal sexual maturity etc.

### **Myxoedema:**

Myxoedema in adults, is a syndrome with the following characteristics viz., low BMR, dry, coarse, scaly skin, puffy and bloated face, coarse and sparse hair, hoarse voice, slow speech, slow thought processes, poor memory, etc. Other symptoms are muscular weakness and fatigue, low blood pressure, anaemia with increased serum cholesterol, etc.

### **Hyperthyroidism or thyrotoxicosis (Grave's disease or exophthalmic goiter):**

The hyper function of thyroid gland results in Grave's disease. Grave's disease is characterized by increased BMR with increased pulmonary ventilation, protrusion of eye balls from the sockets (exophthalmas), increased heart beat rate, nervousness, emotional instability, weight loss, increased blood glucose and decreased serum cholesterol, derangement of sexual function etc.

### **Parathyroid gland**

In man the parathyroid glands are small oval yellow-brown bodies found attached to the posterior surface of the thyroid gland. The parathyroid glands secrete two hormones namely, 1. **Parathormone** and 2. **Calcitonin**.

### **Parathormone:**

Purified parathormone is a simple polypeptide chain. It has short duration of biological activity. The half-life of the hormone is of about 20-30 minutes only.

### **Physiological effects of Parathormone:**

Parathormone manifests its regulatory effects at three different loci in the body namely the skeleton, kidneys and the gastro intestinal tract. In skeleton, the hormone directly acts upon the bone tissue to stimulate the activity of osteoclast cells (bone destroying cells). Under the influence of this hormone calcium is released from the bone matrix into the circulation. As a result plasma calcium level increases. Thus it helps in the skeletal remodelling.

In kidney, parathormone induces a marked increase in phosphate excretion. In the gastro intestinal tract, parathormone stimulates the absorption of calcium and phosphate from the gut by enhancing the vitamin D synthesis. As a result, more phosphate and calcium are transported into the blood stream. Its other physiological effects include its inhibitory action over the osteoblasts or bone forming cells, bicarbonate reabsorption and reduction of urine pH, etc.

### **Calcitonin:**

It is a calcium-lowering hormone secreted by the parafollicular cells of the parathyroid gland. It is a protein. Its physiological effects are antagonistic to that of parathormone. It inhibits bone resorption. In kidney, it inhibits the reabsorption of calcium, phosphorus, sodium, potassium, magnesium and other ions. It decreases gastric HCl secretion. It also decreases the insulin and glucagon secretion.

### **Hyperparathyroidism**

It is a condition where there is an increased amount of parathyroid hormone in circulation. Excess secretion of parathormone brings about demineralization of the bones. The protein matrix of the bone is also absorbed. These changes result in bone cyst and the elevation of the calcium level in the blood. The latter causes calcification of kidneys, arteries, stomach and lungs.

### **Hypoparathyroidism**

Removal of parathyroids causes the blood calcium levels to fall and results in tetany. Tetany is characterized by low serum calcium (Hypocalcemia), reduced urinary excretion of calcium and phosphate, neuromuscular hyperexcitability, spasms of muscles and cramps etc.

### **Pancreas**

The endocrine part of the pancreas consists of specialized groups of cells known as Islets of Langerhans. These cells synthesize, store and secrete two hormones namely insulin and glucagon. There are two kinds of cells namely, alpha and beta cells. The alpha cells produce glucagon while

the beta cells secrete insulin. In addition to alpha and beta cells another type of cells called delta cells are present in human pancreas. According to some investigators the delta cells represent the transitional forms of the two cell types alpha and beta.

### **Insulin:**

Insulin is a protein hormone or a polypeptide hormone with 51 amino acid residues. Human insulin has a molecular weight of 5,734 daltons. It consists of two chains A and B, which are linked together by disulphide bridges formed between two cystine residues.

### **Physiological effects of Insulin:**

It decreases glucose level in the blood in three ways:

- a. It increases conversion of glucose into glycogen and deposition of it in liver and muscles.
- b. It increases the rate of oxidation of glucose in the tissues.
- c. It increases the rate of conversion of glucose into fat and facilitates its storage in adipose tissue.
- d. It also regulates the rate at which amino acids are catabolised into water and CO<sub>2</sub>.
- e. Moderately, it also regulates the gluconeogenesis in the liver.

Thus, insulin reduces the glucose level in the blood (**Hypoglycemia**). If the insulin is not secreted sufficiently, the liver and the muscles are unable to convert the glucose into glycogen. As a result more glucose enters into the bloodstream raising the blood sugar level. This condition is called **Hyperglycemia**. The excess of glucose is eliminated along with the urine resulting in a disease called **diabetes mellitus**. A diabetic patient excretes large amount of urine (**polyurea**) and consumes excessive fluid (**polydipsia**). He always feels hungry and eats excessively (**polyphagia**). When insulin levels are low, fat catabolism is increased and fats are converted into glucose. This further increases blood glucose levels and results in the accumulation of ketone bodies (**Ketosis**).

## **Hyperglycemia**

The normal fasting blood glucose level is 70 to 110 mg/dl (dl = deciliter). This range is maintained under varying conditions of food intake, fasting or body exercise. After a carbohydrate meal the blood sugar may reach a peak level of about 140mg/dl. If such a high level is maintained for a prolonged time, the condition may be termed as **hyperglycemia**. Hyperglycemia over a long period may cause degenerative changes in several organs and systems leading to malfunctions and mortality. Elevated blood sugar level of 400 mg/dl or more, in a few days causes dehydration leading to coma and death.

## **Hypoglycemia**

It means a low plasma glucose concentration. This concentration can drop to very low values during fasting. It is termed as fasting hypoglycemia. It may result due to excess of insulin or other physiological factors. There is no fixed level of blood sugar at which **hypoglycemia** occurs.

Fasting hypoglycemia may show symptoms such as hunger, increased heart rate, tremulousness, weakness, nervousness and sweating. These are caused due to activities of the sympathetic nervous system. Other symptoms such as headache, confusion, uncoordination and slurred speech are due to availability of too little glucans to the brain. Serious brain defects such as convulsions (epilepsy) and coma can occur if the plasma glucose concentration goes low.

## **Diabetes Mellitus**

The name '**diabetes**' in Greek means '**syphon**' or '**running through**'. This term describes the enormity of urinary volume excreted by people suffering from this disease. A persistent hyperglycemia leads to diabetes mellitus. This disease can be due to a deficiency of insulin or to a hypo responsiveness to insulin.

In **type I (insulin dependent) diabetes**, the hormone is completely or almost completely absent from the islets of Langerhans and the plasma. In type II (insulin-independent) diabetes, the hormone is often present in plasma at near normal or even above normal levels.

The type I is less common. It is due to the total or near total destruction of the pancreatic  $\beta$  cells.

The type II is due to insulin resistance. The insulin target cells do not respond normally to the circulating insulin. This may result due to obesity, over-eating and lack of exercise. The insulin hyporesponsiveness can be corrected if the person reduces his or her caloric intake. Thus dietary control without any other therapy is frequently sufficient to eliminate the elevated blood glucose level of type II diabetics. An exercise programme is also useful, since it will help to increase the number of insulin receptors.

### **Glucagon:**

Glucagon, secreted by the alpha cells of the pancreas is a polypeptide hormone with 29 amino acids residues.

### **Physiological actions of glucagon:**

The major function of glucagon in the body is to elevate the blood glucose level by glycogenolysis in the liver. As it raises the blood sugar level it is also called as Hyperglycemic hormone. A second important function of glucagon is the gluconeogenesis in the liver in which amino acids are used as substrates. It promotes lipolysis and the release of fatty acids in the adipose tissues. The increased fatty acid oxidation leads to ketogenesis. Glucagon also stimulates the myocardial contractility. Glucagon exerts a direct effect upon the kidneys and accelerates the renal plasma flow and glomerular filtration rate. A proper balance between insulin and glucagon production is necessary to maintain proper blood glucose level.

### **Adrenal gland**

The adrenal gland or supra renal gland is composed of an outer **cortex** and an inner **medulla**. The adrenal cortex forms the major portion of the total mass of tissue of adrenal gland. In adults three concentric zones are discernible within the cortex. 1. A thin outer most layer, the **Zona glomerulosa**, 2. A thick middle region, **Zona fasciculata** and 3. A relatively thick inner layer, the **Zona reticularis**. In man, the cells of zona fasciculata and zona reticularis act as a single unit, the main function of which is to form glucocorticoids and to a lesser extent androgens and possibly



oestrogens. The mineralocorticoid hormone, aldosterone is secreted by the cells of the zona glomerulosa. The enzymes necessary for its synthesis reside in the cells of the zona glomerulosa. All the adreno corticoid hormones are steroids.

### **Action of glucocorticoids**

The major glucocorticoids are cortisone and certain closely related steroids. These hormones stimulate the production of glucose from non-carbohydrate sources such as fats and amino acids. Glucocorticoids also decrease glucose utilization by tissues in general. All these effects lead to increased blood glucose level. Cortisone also acts as an anti-inflammatory agent.

### **Action of mineralocorticoids:**

The major effect is on the metabolism of sodium ions and indirectly potassium ions. The major mineralocorticoid hormone is Aldosterone. Its most important effect is to promote the resorption of sodium ions from the renal glomerular filtrate. Secondary effects of sodium retention are an increased chloride retention and a decreased potassium retention by the kidneys. The most important function of the adrenal cortex is its role in stress tolerance.

### **Adrenal medulla:**

The medulla of adrenal gland differs both in morphology and physiology from the cortex portion. Both cortex and medulla are derived independently and from totally different tissues in the embryo. The adrenal medulla in the adult humans and other mammals is invested closely by the cortical tissue. The cells of the adrenal medulla are large ovoid and columnar in type and are grouped into clumps around the blood vessels. The hormones produced by adrenal medulla are 1. **Adrenalin** or **epinephrine** and 2. **Nor adrenalin** or **nor epinephrine**. The two hormones belong to a group called **catecholamines**. The various physiological and biochemical actions of adrenalin or epinephrine are the following:

1. Adrenalin stimulates constriction of blood vessels supplying the intestine, kidneys, viscera and skin and causes dilation of blood vessels supplying skeletal and heart muscle.

2. It increases the rate, amplitude and frequency of the heart beat.
3. It causes relaxation of the smooth muscles of the digestive tract and brings peristalsis to a halt
4. It causes relaxation of the bronchi, dilation of the pupil, closure of sphincters and increases sweating
5. It causes contraction of muscles associated with hair follicles and makes the hair “stand on end” and causes goose flesh
6. It accelerates respiration and stimulates mental alertness
7. It stimulates the breakdown of glycogen to glucose, thereby increasing oxygen consumption and heat production.
8. Biochemically it releases the free fatty acids and increases blood glucose level.
9. Adrenalin prepares an individual during emergency or stress situations. Hence it is called the **fight, flight and fright hormone**.

#### **Action of Nor adrenalin or Nor epinephrine:**

Nor adrenalin has certain effects similar to that of adrenalin. For example, both the hormones dilate the coronary vessels. However, nor epinephrine cause vaso constriction in most organs other than heart. It increases both the systolic and diastolic blood pressures. It exerts a weakly inhibitory action upon the contractile activity of smooth muscle in the gastro intestinal tract. However, it does not relax the smooth musculature of the pulmonary bronchioles. Nor epinephrine exerts very little effect upon carbohydrate metabolism and oxygen consumption.

#### **Gonads:**

Both testes and ovaries, in addition to their role as reproductive gamete producing organs, function as endocrine structures also.

#### **Testis**

The testis in males, in addition to the germinal epithelial cells, contains groups of epithelioid cells called the interstitial or leydig cells. These cells constitute the endocrine tissue of the testis. The leydig cells secrete the

androgenic hormone testosterone. The androgens are C19 steroids. In the normal post pubertal males, the rate of secretion of testosterone ranges from 4-9 mg per day.

**Action of testosterone:**

1. Testosterone causes embryonic development of male reproductive organs,
2. It promotes the development of the secondary sexual characters of males, including physical development, hair distribution, masculine voice and male behaviour at puberty.

**Ovary**

The ovaries are paired, oblong in shape and situated in the pelvic portion of the abdominal cavity. It releases hormones such as **oestrogen** and **progesterone**.

**1. Oestrogen**

Under the influence of the FSH from the adenohipophysis, the ovum grows and becomes enclosed in the Graafian follicle. Associated cells of the follicle produce a steroid hormone called estrogen. The oestrogens are C18 steroid compounds. It is responsible for the growth of female reproductive organs and for the appearance of secondary sexual characters.

**2. Progesterone:**

After the discharge of the ovum from the Graafian follicle and after fertilisation, the ruptured follicle cells form a new structure called corpus luteum. It produces the pregnancy hormone progesterone. Progesterone is also synthesized and secreted by the placenta during the later part of gestation. This hormone is a C-21 steroid compound.

Progesterone is responsible for the premenstrual growth in the non-pregnant woman's uterus. The development of the placenta during pregnancy and the embedding of the fertilized ovum in the uterus (implantation).

### 3. Relaxin:

The corpus luteum of the pregnant woman secretes another hormone, relaxin in addition to progesterone. Relaxin helps in relaxing the muscles and ligaments of pelvic organs during childbirth (parturition).

### Receptor Organs

The survival of animals depends on their ability to compute all the information flowing from the environment and integrate them into meaningful instructions to the effector organs. Information relating to the external and internal environment can be gained only through the sensory receptor organs. These organs have specialized cells that can transform the stimuli falling on them, whether it is chemical, radiant, electrical or mechanical, into electrical signals and convey the same to the central nervous system. In the CNS the integration and coordination of the data happens. This ability of the sensory cells is known as transduction and the receptors are sometimes referred to as transducers.

### Eye

The visual system gives information about size, shape, color, luminosity and movements of object in the external world.

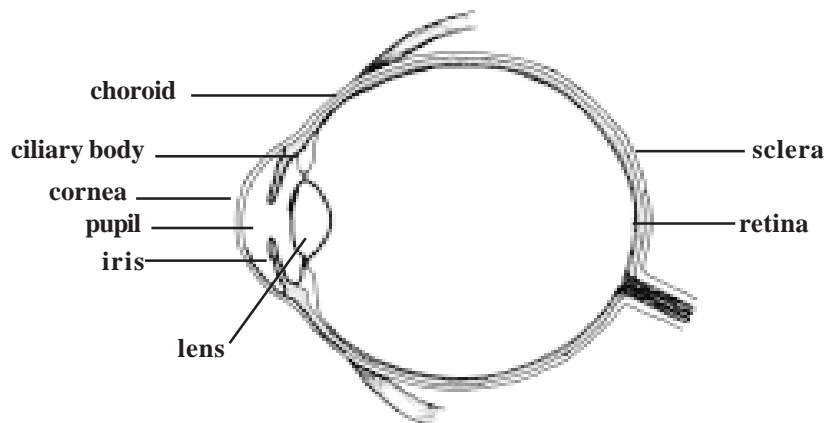
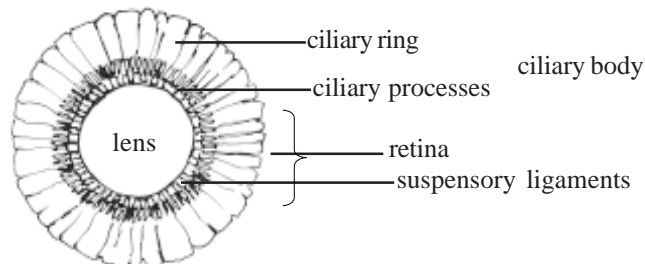

Fig.1.24. V.S. of human eye

### (a) Focusing Mechanism in the Human Eye

Light rays entering the eye are redirected or refracted. Refraction occurs through three surface of the eye before the light reaches the retina. The first of the refracting surfaces is the cornea, then the front surface of the lens and finally the rear surface of the lens.

Between the cornea and the lens is a colourless, watery fluid called aqueous humour. At the back of the eye between the lens and the retina is the vitreous humour made of a **gelatinus mucoprotein**. The humours are transparent so that transmissions of light through the cavities of the eye to the retina is not normally impeded. Human eye has a lens apparatus whose convexity can be adjusted for focusing near and distant objects. This ability of the eyes to focus objects at varying distances is called **ACCOMMODATION**. The accommodation is achieved due to suspensory ligament, ciliary muscle and ciliary body.



**Fig.1.25. Lens with ciliary muscles**

When a normal eye is looking at a distant object, the ciliary muscles is fully relaxed and parallel rays from the object come to focus on the retina. Hence a clear image is seen. When the object is brought close to the eye the refractive power of the eye is increased by the process of accommodation. The increase in refractive power is the result of an increase in the curvature of the anterior surface of the lens. This avoids the blurred image for a closer object. Similar accommodation happens for viewing a distant object by stretching the suspensory ligament attached to the lens. This act alters the contour of the lens.

### **Photochemistry of Retinal visual Pigments**

Rhodopsin or Visual Purple is a purplish red photosensitive pigment present in the outer segment of the **rods** (120 million rods). It is made up of

protein portion, an opsin (scotopsin) combined with an aldehyde of vitamin A called Retinene 1, which is referred to as a retino. On exposure to light, rhodopsin is bleached, i.e., broken down to retinene and opsin, but is resynthesised in the dark. Some of the retinene recombines with scotopsin to form rhodopsin while some are reduced to vitamin A. The rods are extremely sensitive to light and are responsible for vision in dim light. This is called SCOTOPIC VISION.



cone

**Fig.1.26. Rod**



rod

**Fig.1.27. cone cells**

**Cones** also contain visual pigments made up of retinene, combined with a protein opsin (photopsin). Three pigments each responding to different wavelength are found in man. There are three primary colors namely red, green and blue. Color vision is a function of bright light vision and cones are responsible for color perceptions. In bright light maximum perception of colors is at the fovea region of the retina where rods are absent and only cones are present. In dim light when the rods in the extra foveal retina function, colors are not perceived and the various colors appear as shades of grey. Cones function in bright light and the system has more acuity and can perceive colors (PHOTOPIC VISION).

Photochemical basis of retinal function is a basis of conversion of light energy into nerve impulses. It is this process that excites the nerve fibres and sets up nerve impulses.

The impulses generated in the receptor neurons in response to generator potentials in the cones are interpreted by the brain as the appropriate intermediate colour. The interpretation or perception of colour pictures seen by our eyes is a complex function of the brain. It is located in the occipital lobe of the cerebral cortex.

## The visual pathway

The axons of ganglion cells pass through the eyeball at the posterior end and form the optic nerve which enters the cranial cavity. Therefore this region of the retina lacks receptors and is unable to perceive images which fall on it. This region is called optic disc and when charting the field of vision it is referred to as the blind spot.

## Errors of refraction

In a normal eye focused for distant objects, parallel rays of light come to a sharp focus exactly on the retina. It can accommodate for clear vision of objects from infinity (far point) down to 25 cm (near point). This ideal refractive state is called **emmetropia**. A deviation from emmetropia is called **ametropia**. The important forms of ametropia are **myopia**, **hypermetropia**, **astigmatism**, **presbiopia**. Ametropia results from an imbalance between the length of the eye ball and its refractive power.

### (a) Myopia (Short Sightedness)

Myopia results if the lens curvature is too great or the entire eyeball becomes elongated. Light rays entering the eye are refracted more than is necessary. Consequently light is focused in front of the retina. The image perceived is thus blurred. The condition is called **short-sightedness** as objects near the eye are clearer than those further away. Myopia can be corrected by placing a concave lens in front of the eye. The surface of the concave lens refracts light rays in such a way that the rays diverge slightly from their original path. The lens of the myopic eye now refracts the diverged light rays in to focus on the retina.

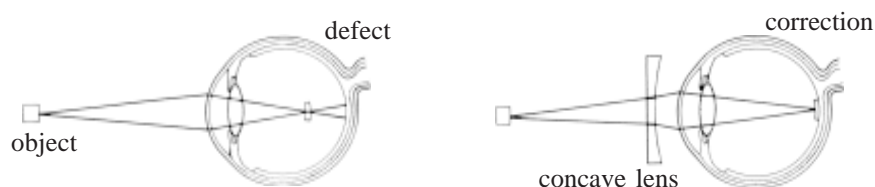

**Fig.1.28. Myopia and its corrections**

### (b). Hypermetropia (Long Sightedness)

Hypermetropia results when the curvature of the eye lens is not great enough. Light rays are not refracted enough and would thus be focused behind the retina. The condition is called **long-sightedness** because distant objects are clearer than near ones. This happens because light rays from distant objects require less refraction than rays from near objects. Correction of hypermetropia requires placing a convex lens in front of the eye. The lens converges light rays before they enter the eye so that the eye's focuses the light correctly on the retina.

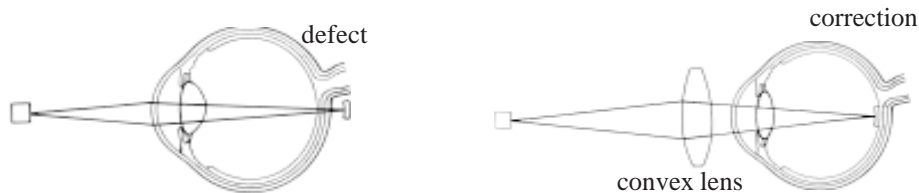

**Fig.1.29. Hypermetropia and its corrections**

### (c). Astigmatism

Astigmatism occurs if either the cornea or lens is distorted. One part of the focusing mechanism then refracts light rays too much, or too less. Usually most of the images perceived is out of focus. Light rays from part of the object are focused in front of the retina, as in myopia. Rays from other parts would be focused behind the retina, as in hypermetropia. Astigmatism can be corrected by placing a lens in front of the eye. The curvature of this lens varies from one part to another to compensate for the eye's deficiencies.

### (d). Presbiopia

This is the result of a reduction in the amplitude of accommodation with age due to hardening and loss of plasticity of the lens. Hence it becomes less capable of being moulded into a more complex form. Presbiopia begins at about 40 years of age. The remedy is convex lenses for reading. Any defect in the eye should be consulted immediately with the optometrist.

## Optometry

The practice of assessing vision and establishing whether glasses or contact lenses are needed to correct any visual defect is known as



optometry. The eyes are examined by a qualified **optometrist** who will assess the errors of refraction, prescribe and supply glasses or contact lenses to correct it. Optometrists are not qualified to diagnose or treat disorders of the eye but will refer patients requiring further to an ophthalmologist.

### **Retinopathy**

Retinopathy is the disease of the retina, usually resulting from either diabetes mellitus or alternatively from persistent hypertension (high blood pressure). There are two types of retinopathy.

(1). **Diabetic retinopathy** is characterized by tiny **aneurysms** (balloon like swellings) of the capillaries (tiny blood vessels) in the retina. New abnormal blood vessels which are fragile and bleed readily grow on the retinal surface. Haemorrhage into the vitreous humour may occur, fibrous tissues can also grow forward into vitreous humour. Treatment by laser surgery can often halt a progress of the condition.

(2). **Hypertensive retinopathy** is characterized by narrowing of the retinal arteries. Areas of the retina may be destroyed and causes haemorrhage and white deposits may also occur in the retina. It may even lead to **retinal detachment**. Remedy is laser treatment.

### **Cataract**

Cataract is the opacity in the lens of the eye. The normal lens allows light to reach the retina when it becomes opaque and does not allow light to reach the retina, the person is unable to see clearly. Cataract is due to (coagulation) changes in the delicate protein fibres within the lens, cataract never causes complete blindness but causes increased loss of transparency. The clarity and the detail of the image is progressively lost. The front part of the lens becomes densely opaque and whiteness is visible in the pupil.

The causes for cataract formation in the adult is related to aging, sun light exposure, smoking, poor nutrition, eye trauma, systematic diseases like diabetes mellitus, infection and injuries and certain medications such as steroids. Sometimes German measles in pregnant mothers causes cataract in the child.

To delay the onset of cataract one should have nourishing diet, protect eye from excessive exposure to sun rays, X-rays, intense heat and injuries. Diseases like diabetes and syphilis should be treated early and effectively.

Two types of cataracts are dense nuclear cataract (cataract in the center of the lens) and Peripheral cataract (cataract in the periphery of the lens). There is no medical treatment for cataract. The only treatment is surgery. Once the cataract is removed, the eye is unable to focus, as there is no lens. So one has to use an artificial lens. This can either be glasses, contact lenses or insertion of introcular lenses.

Today modern medical advances have made cataract surgery very successful. New surgical techniques and intracular lenses can restore excellent vision (97%).

### **Lens Replacement**

For individuals who are over 40 years of age, considering refractive surgery to decrease dependence on glasses and contact lenses, Clear Lens Replacement (CLR) is an exciting option. In essence, this procedure entails removing the natural lens of the eye and replacing it with an intraocular lens (IOL) implant.

CLR may be an excellent alternative to these procedures for people already wearing bifocals since CLR requires removal of the natural lens of the eye, the patient is subsequently unable to focus (accommodate) at near by objects . This is why CLR is best suited for patients over 40 who are already wearing bifocals. One potential solution to this problem of accommodative loss is implantation of the multifocal IOL (Intra Ocular Lens) implant. This implant allows focusing at both near and far objects.

### **Glaucoma**

Glaucoma is a serious disorder of the eye and is a common cause of blindness. Increased IOP (Increased Occular Pressure) compresses the optic nerve at the optic disc with degeneration of optic nerve fibres and cupping of the optic discs with progressive loss of visual acuity starting with peripheral vision. The retinal artery which enters the eye ball at the optic disc

is compressed causing retinal degeneration. In most cases the cause of glaucoma is unknown but in some cases it may be due to infection or trauma in the eye. When the IOP is very high (50-70 mm Hg) blindness occurs within few days.

### **Nyctalopia**

Vitamin A is necessary for resynthesis of visual purple. Nyctalopia or night blindness is the first sign of vitamin A deficiency. Prolonged deficiency of vitamin A leads to degenerative changes in rods and cones and nervous layers of the retina. Administration of vitamin A before degenerative changes occur will restore retinal functions. Normal retinal function also requires the presence of optimal amounts of other vitamins especially the B complex just as other nerve tissues do.

### **Infections**

**1. Stye :** A stye is an acute infection of the glands located at the eyelid margin. There is swelling, pain, itching and redness in a small area at the lid margin. Treatment consists of using frequent warm compresses on the eye.

**2. Conjunctivitis:** Infection in the conjunctiva is called conjunctivitis. Due to the infection the invisible blood vessels within the conjunctiva become engorged. Inflammation of the conjunctiva causes redness, discomfort and a discharge from the affected eye. The most common causes for conjunctivitis are infections (in children) and allergy (in adults).

**2a. Infective conjunctivitis :** Most conjunctival infection are caused by bacteria (e.g staphylococci) and are spread by hand-to-eye contact or by viruses associated with a cold, sore throat, or illness such as measles, viral conjunctivitis sometimes occurs in epidemics, spreading rapidly through schools and other groups.

**2b. Allergic conjunctivitis :** An allergic response of the conjunctive may be provoked by a variety of substances including cosmetics (mascara), contact lens cleaning solution and pollen.

**Symptoms :** All types of conjunctivitis cause redness, irritation, itching, discharge and occasionally photophobia (abnormal sensitivity to bright

light). In infective conjunctivitis the discharge contains pus and may cause the eyelids to be stuck together in the morning. In allergy conjunctivitis the discharge is clear and the eyelids are often swollen.

**Treatment :** Warm water is used to wash away the discharge and remove any crust on the eyelid. Infections are treated with **eye drops** or **ointment containing an antibiotic drug**. Allergic conjunctivitis may be relieved by use of eye drops containing an **anti histamine** drug.

### **Eye care**

Eye is an important organ and it is to be taken care of.

1. Eye examination should be periodically done to determine the cause of visual disturbance or other symptoms relating to the eye.
2. Foreign particles in the eye are very common and it may penetrate in the eye ball. So care should be taken while removing the dust to avoid damage.
3. The retina should be periodically examined to assess conditions such as hypertensive retinopathy for hypertension and diabetic patients.
4. Self medication should be avoided. A doctor should be consulted immediately if there is any sudden pain or blurry vision.

### **EAR**

Our ears provide us with two vital but very different senses : hearing and balance. Sound detected by the ears provides essential information about our external surrounding and allow us to communicate. In addition our ears contribute to our sense of balance to maintain upright posture and move without falling over.

Sound is the sensation produced by longitudinal vibrations in the external environment. Loudness of sound is correlated with amplitude of sound wave and pitch with frequency (No.of waves / unit time). Audible frequencies to humans is in the range 20 - 20,000 cycles per second (cps, Hz). Only the young people are able to hear this full range.

Sound perception depends on the loudness as well as frequency. The human ear is most sensitive to 50 - 5000 Hz range. But most sounds we normally hear fall within 500 - 5000 Hz. Since the human ear can

differentiate a wide range of sound energy (the loudest noise perceived is approximately  $10^{12}$  times more intense than the softest whisper) the decibel (dB) scale is used to measure the intensity of sound.

Our ability to hear depends on a complex series of events that occur in the ear. Sound waves in the air are transmitted as vibrations through a series of structures to the receptor for hearing. The physical vibrations are detected and converted into electrical signals. Nerves carry the electrical signals to the brain where they are interpreted. The interpreted messages allow us to perceive the subtleties of sounds such as speech and music.

### Mechanism of hearing

**Functions of External Ear :-** Sound waves enter the external auditory meatus, pass along the external eustachian canal and fall on the tympanic membrane (TM). This causes the TM to vibrate.

**Functions of Middle Ear :-** The middle ear is an air filled cavity in the temporal bone which opens via the eustachian tube into the nasopharynx. The auditory tube opens during chewing, swallowing and yawning thus keeping the pressures on both sides of the tympanic membrane equal.

The three auditory ossicles are localised in the middle ear. Of these, the **malleus** is attached to the TM, and the **stapes** to the membranous oval window on the medial wall. **Incus** articulates with these two bones. Thus vibrations of the TM are transmitted to the oval window. As the TM has an area of  $90\text{mm}^2$  and the foot plate of the stapes  $3.2\text{mm}^2$  and the lever system formed by the ossicles multiplies the force 1.3 times.

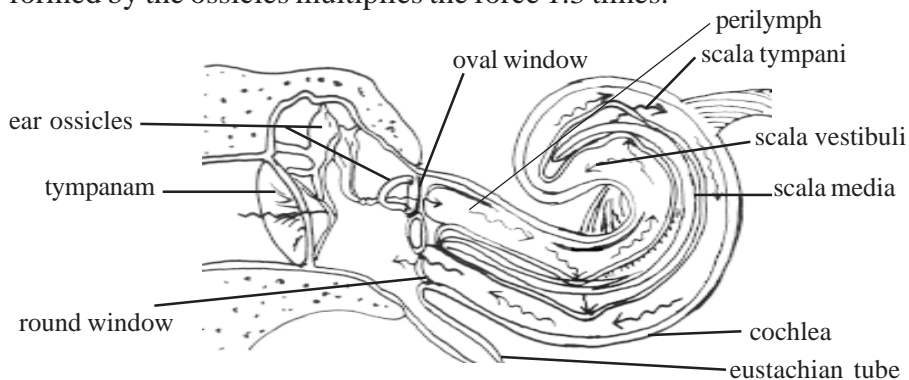

**Fig.1.30. Internal structure of Ear**

The vibrations of the oval window generate pressure waves in the fluid filling the vestibular canal. The pressure waves pass to the median canal and vibrate the basilar membrane. The tympanic canal is connected to a circular membrane called the round window just beneath the oval window. This arrangement allows the pressure waves to transmit through the cochlear fluid.

**Functions of Cochlea :-** The inner ear (labyrinth) is made up of the cochlea and the vestibule. The cochlear portion of the labyrinth is a tubule coiled 2.75 times. Throughout its length the cochlea is divided into three compartments by the basilar and the Reissner's membranes. The middle compartment (scala media) contains endolymph and the other two (scala vestibuli & scala tympani) contain perilymph.

**Organ of Corti :**

Located on the basilar membrane is the Organ of Corti which contains the auditory receptors. Four rows of hair cells arise from the basilar membrane.

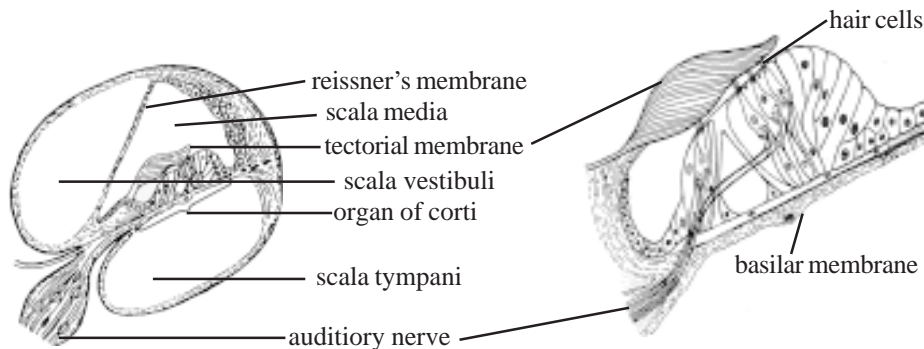

**Fig.1.31. CS of Cochlea**

**Fig.1.32. Organ of Corti**

**Stimulation of hair cells :-** Movements of the foot plate of the stapes set up a series of waves in the perilymph of the scala vestibuli. This in turn causes vibrations of the vestibular membrane and hence of the endolymph in the scala media. These waves deflect the Reissner's membrane and this in turn produces disturbances in the basilar membrane which bend the hairs of hair cells in the organ of Corti. This leads to development of action potentials in the related nerve fibres which are transmitted along the auditory nerve.

The site of maximum distortion in the organ of Corti is determined by the frequency of sound, for high pitched sounds the maximum height of the waves is near the base of the cochlea and for low pitched near the apex. The extent of distortion is determined by the loudness of the sound. Interpretation of these impulses is made in the auditory cortex.

Sound waves → vibrate tympanic membrane → movements in ear ossicle chain → vibration of oval window → waves in perilymph (scala vestibuli) → waves in endolymph → deflection in the Reissner's membrane → basilar membrane disturbed → bending of hair cells → action potential → transmission by auditory nerve.

### **Defects of the ear**

Several defects of the ear lead to hearing loss or even deafness. Hearing loss, or hearing impairment, happens when there is a problem with one or more parts of the ear or ears.

**Types of Hearing Loss :-** There are a few different types of hearing loss: conductive, sensory, mixed (conductive and sensory combined), and neural.

**Conductive hearing loss:-** This happens when there is a problem with a part of the outer or middle ear. Most kids with conductive hearing loss have a mild hearing loss and it is usually temporary because in most cases medical treatment can help.

**Sensory hearing loss :-** This happens when the cochlea is not working correctly because the tiny hair cells are damaged or destroyed. Depending on the loss, a person may be able to hear most sounds (although they would be muffled); only some sounds; or no sounds at all. Sensory hearing impairment is almost always permanent and the ability to talk normally may be affected.

**Neural hearing loss:-** This happens when there is a problem with the connection from the cochlea to the brain.

The hearing loss may be congenital or due to middle ear fluid, serious infections, such as meningitis, head injury, listening to very loud music, especially through headphones, repeated exposure to loud sounds, such as machinery.

One of the common causes of conductive hearing loss is blockade of the external auditory meatus with wax secreted from ceruminous glands in the skin lining the meatus. In some people wax accumulates in the meatus and hardens, sometimes pressing against the eardrum. Normal hearing is usually restored after the hardened wax is removed with a special syringe.

Another cause of conductive hearing loss, is a perforated eardrum. Perforation can be caused by infection in the middle ear or by mechanical injury resulting from a nearby explosion or a sudden blow to the head. Injury to the head can also cause the ossicles of the middle ear to become disconnected from one another, thus breaking the conductive path to the cochlea.

Malfunction of the cochlea and acoustic nerve can be the cause of hearing loss, even though vibrations are conducted perfectly into the inner ear. Such hearing loss is called sensorineural (perceptive) hearing loss. Acquired forms of this condition can result from infection, head injury, blast from explosions or exposure to excessive noise.

### **Hearing Aid**

Patients with a conductive defect which does not respond fully to treatment may be helped with a hearing aid.

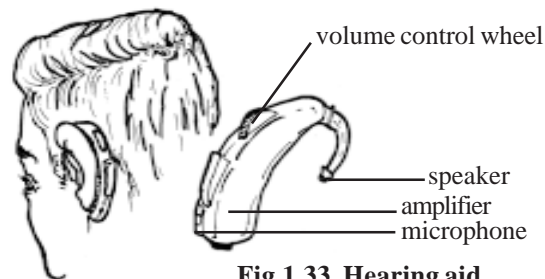

**Fig.1.33. Hearing aid**

A hearing aid is an electronic, battery-operated device that amplifies and changes sound to allow for improved communication. Hearing aids receive sound through a tiny microphone, which then converts the sound waves to electrical signals. The amplifier increases the loudness of the signals and then sends the sound to the ear through a speaker in an ear piece which fits into an outer ear canal. The electric signals are converted back to sound waves.



A volume control on the aid usually operated by turning a tiny wheel enables the level of incoming sound to be adjusted.

More powerful aids that amplify sound to a greater degree are available. In these aids the microphone, amplifier and battery are contained in a larger case worn on the body; the currents is carried to the ear piece by a thin wire. Some people with conductive deafness especially if there is an infection or discharge in the ear canal may be given a bone conduction hearing aid. This type of hearing aid may be fitted to a glass frame or hair band.

Other devices available for the hard-of-hearing include amplified telephone receivers, flashing lights instead of door bells and telephone bells, vibrators that respond to sound, head phone for television sets, teletype writers and guide dogs for the deaf.

### **Noise pollution**

The term noise is derived from the Latin word *Nausea* referring to the feeling of sickness in the stomach with an urge to vomit. Any unpleasant and unwanted sound is considered as noise. It is one form of pollution. Noise pollution can be defined as unwanted or offensive sounds that unreasonably intrude into our daily activities. It is responsible for various adverse effects. In recent years noise is recognized as a major pollutant on par with other chemical pollutants of air, water and biosphere. Noise has many harmful effects on man and the damage incurred is irreversible.

There are various sources of noises and the sources are broadly classified into industrial sources and non industrial sources. The noise dumped into the atmosphere by the industries due to the functioning of machineries form the industrial sources. On the other hand the noise associated with urban development; road, air and rail transport; loud speakers, radio and television stations, construction sites, neighbourhood and recreational noise levels, and activities associated with urban living generally lead to increased noise levels.

Sound is measured by several complex systems. The best known unit of measurement is the measurement of sound in **decibel** which is named after Sir Alfred Bell. The industrial noise survey of India recognized noise levels from 81dB to 120dB as permissible levels.

Loud noises (above 130 dB) can cause immediate and permanent damage to the muscles in the middle ear, altering the stiffness of the ossicles, damaging the hair cells of the cochlea and causing the rupture of ear drum thereby reducing the efficiency of hearing.

Prolonged exposure to unpleasant noises may lead to severe mental disturbances and violent behaviour. Noise is also partially responsible for the increased consumption of alcohol, drugs, tranquilizers and sleeping pills. Noise pollution further contributes to a few cardiovascular problems. Peptic ulcers and asthma are aggravated. Small vessels to glomerular circulation are subjected to vaso constriction and ultimately the output of urine is reduced. Persons exposed to excessive noise at work place have temporary impairment of hearing.

## **Skin**

The skin is a major organ of the body forming 8% of its total mass and having an area between 1.1-2.2m<sup>2</sup>. It is the major interface between the body and the environment and covers the entire surface. It is continuous with mucosae at the various orifices and with lining tissue of organs like eyes and ears

Various structures including sebaceous glands, sweat glands, hair follicles and nails are formed by modifications of epidermis. Sebaceous glands secrete an oily substance called **sebum** and open on the sides of the hair follicles. Sweat glands are of two types, **Merocrine** and **Apocrine**. Merocrine glands are found throughout the body opening on the surface and secreting a clear watery fluid. Apocrine glands are found in the regions like axilla, areola, pubis, scrotum and perianal regions. Their ducts may open on the surface or into the hair follicle.

Dermis is made up of connective tissue consisting of matrix in which is embedded elastic and collagen fibres to give strength and elasticity. It also provides a compartment for blood vessels, lymphatics, nerves and cells associated with immunity. Receptors for the sensations such as touch, pain, pressure, warmth, cold and vibration senses are also found in the skin.

Circulation through the skin serves two major functions nutrition and conduction of heat to the environment.

## Functions of skin

1. Skin forms an effective barrier against infection by microbes.
2. It prevents dehydration and provides defense against chemical, osmotic, thermal and photic damage.
3. It limits and regulates heat loss.
4. It provides a major sensory surface with a range of receptors.
5. It has limited excretory and absorptive functions.
6. Skin also helps in the formation of vitamin D.
7. Its keratinization and high friction coefficient gives the skin a characteristic texture and helps in movement and handling of various substances.

## Melanin - functions

Melanin is the brown black, non-haemoglobin-derived pigment normally present in the hair, skin choroid of the eye, meninges and adrenal medulla. It is synthesized in the melanocytes and dendritic cells, both of which are present in the basal cells of the epidermis. Melanin is stored in the form of cytoplasmic granules in the phagocytic cells called the melanophore, present in the under lying dermis. Melanocytes possess the enzyme tyrosinase necessary for the synthesis of melanin from the amino acid called tyrosine



Various disorders of melanin pigmentation cause generalized and localized hyperpigmentation and hypopigmentation.

### I. Generalized hyperpigmentation

- a) In Addison's disease, there is generalized hyperpigmentation of the skin, especially in areas exposed to light and buccal mucosa.
- b) Hyper pigmentation on skin of face, nipples and genitalia during pregnancy under the influence of oestrogen.
- c) In chronic arsenical poisoning, there is characteristic rain-drop pigmentation of the skin.

## **II. Generalized hypopigmentation**

Albinism is an extreme degree of generalized hypopigmentation in which tyrosinase activity of the melanocytes is genetically defective and no melanin is formed. Albinos have blonde hair, poor vision and severe photophobia. They are highly sensitive to sunlight. Chronic sun exposure may lead to pre-cancerous lesions, squamous and basal cell cancers of the skin.

## **III. Localised hypopigmentation**

- a) Leucoderma is a form of partial albinism and is an inherited disorder.
- b) Vitiligo is local hypopigmentation in the skin.
- c) Acquired local hypopigmentation can result from various causes such as leprosy, healing of wounds, radiation dermatitis, etc.

## **Effects of solar radiation / UV radiation**

Invisible light forms a part of the electromagnetic spectrum immediately beyond the violet end of the visible light spectrum (i.e. between visible light and X-rays). Long wavelength ultraviolet light (i.e. that nearest visible light) is often termed as UVA; intermediate wavelength ultraviolet light is designated UVB; and short wavelength ultraviolet light (i.e. that nearest X-rays) is called UVC.

The main source of UV radiation is the sunlight; others are UV lamps and welder' arcs. UV light penetrates the skin for a few millimeters only so that its effect is limited to epidermis. In human excessive exposure to UV rays can cause various forms of skin cancer such as squamous cell carcinoma, basal cell carcinoma and malignant melanoma. The efficiency of UV light as carcinogen depends upon the extent of light-absorbing protective melanin pigmentation of the skin. Fair skinned people and whites are more prone to skin complications due to UV exposure. People living close to the equator, outdoor workers and farmers in Tropics are exposed to light radiations.

## **Skin grafting**

Skin grafting is a technique used in plastic surgery to repair areas of lost or damaged skin. A piece of healthy skin is detached from one part of the body and transferred to the affected area. New cells grow from the graft and cover the damaged area with fresh skin.

Skin taken from an identical twin can be used for a graft, but skin from another person or an animal is soon rejected by the recipient body. A skin graft is performed because the area is too large to be repaired by stitching or because natural healing would result in scarring that might be ugly or restrict movement.

Most grafts are performed by removing skin from the donor site and transferring to the recipient site.

## **Dermatitis**

It is inflammation of the skin, sometimes due to an allergy but in many cases it occurs without any known cause. Many types of dermatitis such as eczema are known.

### **Contact dermatitis**

In this type of dermatitis the rash is a reaction to some substances that comes in contact with the skin. The reaction may result from a direct toxic effect of the substances or it may be an allergic response. Among the more common causes of the reaction are detergents, nickel (eg. in watch straps, bracelets, necklaces and fastening of underclothes), certain plants (eg. Rag weed), certain cosmetics and some medications in the form of creams, lotions or drops. The type of rash varies according to the substance causing it but it is often itchy and may flake or lister. Distribution of the rash corresponds to the skin area that has been in contact with the causative substance.

### **Photo dermatitis**

This type of dermatitis occurs in people whose skin is abnormally sensitive to light. In the most common form of photo dermatitis a cluster of spots or blisters develop on any part of the body exposed to sun.

## **Tongue**

In man the taste buds are found only in the mouth and are abundant in the tongue. They are distributed over the dorsal and under surface of of the tongue, on the laryngeal surface of the epiglottis, pharynx and on the cheek.

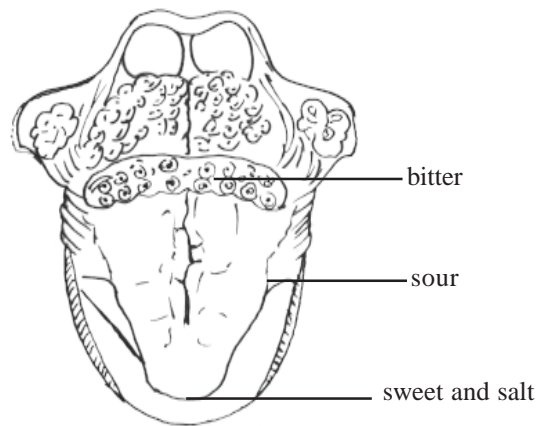

**Fig.1.34. Taste area of the tongue**

Each taste bud occupies the entire thickness of the epithelium. There is an opening on its free surface known as the pore canal. Taste buds are numerous at birth and their number decreases with age.

Taste sensation and distribution of taste cells :-

There are four primary or fundamental tastes. They are sweet, sour, salt and bitter. Alkaline and metallic taste are also sometimes included.

Taste buds mediating the four primary taste are localized in certain regions on the tongue. The taste bud sensitive to **bitter** taste are at the back of the tongue. Those for sour tastes are on the lateral surface. Those mediating **salt** at the anterior part of the dorsum near the tip. The taste bud **sensitive to sweet** are near the tip. The taste bud in the palate respond to sour and bitter taste but have some sensitivity to sweet and salt. The pharynx and epiglottis are not sensitive to all four tastes. It is found that both sweet and salt are insensitive to taste in these regions.

### **Mechanism of Stimulation**

Taste receptors are stimulated by substances in solution. The dissolved substances act on the microvilli of the taste receptors which project at the gustatory pore and sets up a generator potential to the receptor. This inturn activates the afferent nerve ending at the base of the receptor,

producing a propagated action potential in the nerve. The mechanism of production of generator potential varies in different receptors of taste.

## Excretion

As a result of continuous synthesis and breakdown of materials many waste products are formed in cells. The process by which the cellular nitrogenous wastes are eliminated is called excretion. Three main nitrogenous wastes are ammonia, urea and uric acid. Various vertebrates excrete different form of nitrogenous wastes, according to the nature of their habitat and availability of water.

### Ureotelism

Ureotelism is an adaptation for a semi-terrestrial habitat. Urea requires only a small quantity of water to form urine and never involves much water loss; Further, urea is much less toxic than ammonia and it can be retained in blood for sometime before it is transported and eliminated through the excretory organs. Though the concentration of urea in the blood is small, it can be stored safely in the bladder in high concentration. Thus ureotelism is conditioned by the shortage of water, characteristic of the terrestrial habitat.

### Urea Biosynthesis (Ornithine Cycle)

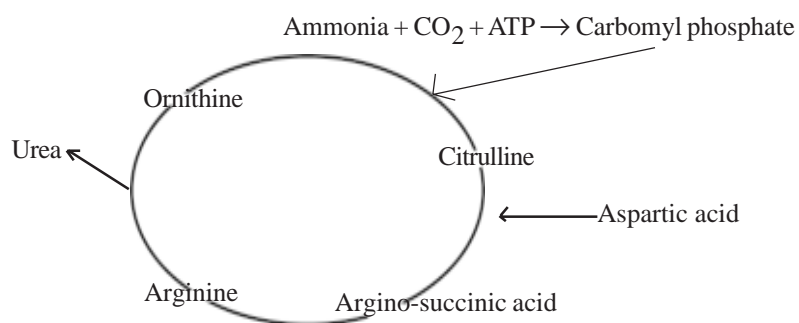

Liver is the principal organ of urea biosynthesis. In the ornithine cycle, ammonia, formed by deamination in cells and tissues, combines with carbon dioxide to form carbamyl phosphate. This compound is subjected to a cyclic

chemical reactions as provided in the figure. Three molecules of ATP are spent to convert the toxic ammonia into a molecule of urea.

## **Nephron**

Nephron is the structural and functional unit of the kidney. There are about a million nephrons

In general, the kidney performs the following vital functions in the body :

1. *Excretion of waste products* resulting from protein metabolism.
2. *Regulation of acid-base balance* by excretion of  $H^+$  ions (acidification) and bicarbonate ions.
3. *Regulation of salt-water balance* by hormones secreted both intra- and extra-renal.
4. *Formation of renin and erythropoietin* and thereby playing a role in the regulation of blood pressure and erythropoiesis respectively.

## **Mechanism of urine formation**

Urine is continually formed by each nephron and the processes involved in the formation of urine are

1. Glomerular ultra filtration, Tubular Reabsorption, Tubular Secretion

### **Glomerular ultra filtration**

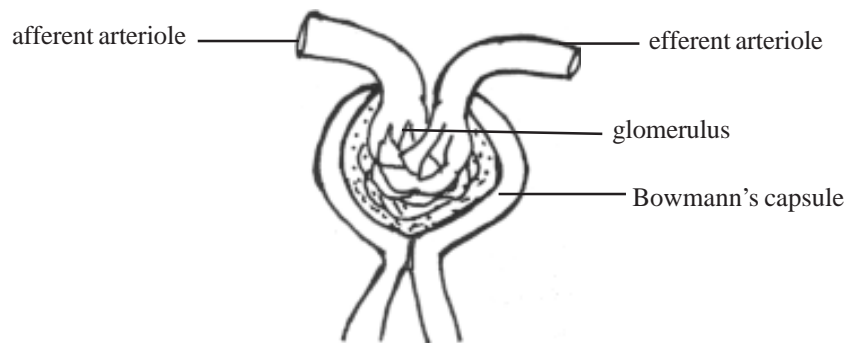

**Fig.1.35. Malpighian capsule - Ultra filtration**



Ultrafiltration of blood takes place in the malpighian body which acts as a biological filter. A malpighian body comprises Bowman's capsule and glomeruli.

### **Dynamics of filtration**

The kidneys normally receive an abundant blood supply of about 1200ml/min or about 20 to 25 percent of the cardiac output. It flows through the capillaries of glomerulus where the blood pressure is comparatively high. The high blood pressure brings about effective filtration. The hydrostatic pressure (forward pressure 75mm/Hg.) of the blood in the afferent glomerular capillaries and the cumulative effect of the opposition pressures and renal intratubular pressure (10mm/Hg.) play an important role in producing the glomerular filtrate. The hydrostatic pressure of the blood is always greater than the opposing pressures existing in the plasma protein and renal capillaries. Thus the available net filtering force (75-50mm/Hg. = 25mm/Hg.) is chiefly responsible for glomerular filtration. The fluid in the capsule which is obtained by the process is termed glomerular filtrate. The volume of the glomerular filtrate produced each minute is called **glomerular filtration rate** (GFR). In man it is about 125ml/min. In 24 hours the total volume of glomerular filtrate is 170 to 180 liters.

### **Tubular Reabsorption**

This is the second step in the urine formation. The glomerular filtrate contains many useful substances such as glucose, amino acids, mineral salts and vitamins dissolved in large amount of water. Reabsorption takes place in the uriniferous tubules. Reabsorption of useful substances is a differential or selective process. Substances such as glucose, sodium and calcium, are called "high threshold substance". They are actively reabsorbed in considerable quantities. Substances like urea and uric acid etc which are called "low threshold substances" are reabsorbed in small quantities by a simple diffusion process or passive reabsorption. Substances like creatinine are not reabsorbed. They are completely eliminated.

### **Reabsorption in Proximal Convoluted Tubule**

Proximal convoluted tubule is responsible for the reabsorption of water, glucose, sodium phosphate and bicarbonates. The urine is found to

be isotonic in the proximal convoluted tubule. Isotonic condition of a solution indicates no passage of water across the membrane separating two such solutes.

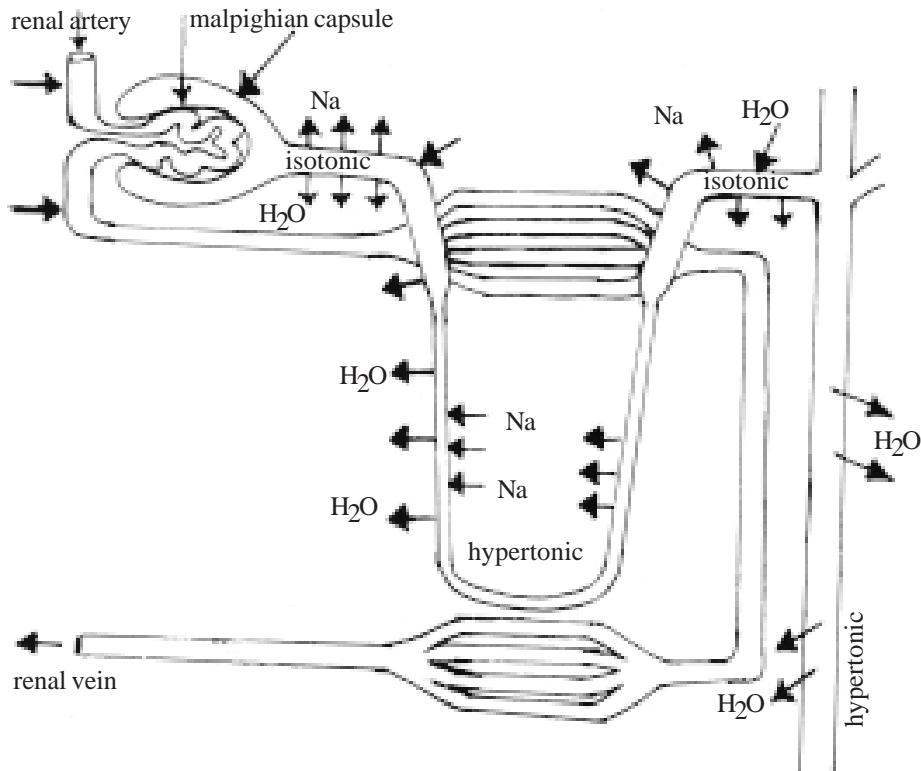

**Fig.1.36. Renal Tubular Absorption**

### **Reabsorption in Henle's loop**

Urine becomes more and more hypertonic as it passes through the descending limb of the loop of Henle's. This is due to the fact that the thin descending portions of the Henles loop are freely permeable to sodium. As the urine slowly passes through the thick ascending limb of the loop of Henle, it becomes less hypertonic since the sodium is actively transported from the ascending limb to the descending limb through the interstitial tissue space.

### Reabsorption in distal convoluted tubule

On entering the distal convoluted tubule, the urine becomes nearly isotonic to the surrounding tissue fluid due to the active transport of sodium and passive transport of water. **Summary of Renal Filtration and Reabsorption in 24 hours**

### Reabsorption in collection tubule

As urine (isotonic) passes into the collecting tubule it becomes once more hypertonic by the osmotic reabsorption of water under the influence of the hormone ADH. The release of ADH is controlled by the osmoreceptors in the hypothalamus in response to changes in the osmotic pressure of the plasma circulating through the collecting tubule. Thus the urine formed contains 96% of water, 2% urea and 2% of the metabolic products.

### A comparison of the amounts of various substances in 24 hrs in the glomerular filtrate and excretion

Substance	Amount filtered each day	Amount excreted in Urine each day
Water	180 ltrs	1-2 ltrs
Protein	2g	0.1g
Sodium	580g	5g
Chloride	640g	6g
Potassium	30g	2g
Bicarbonate	275g	0
Glucose	180g	0
Urea	53g	25g
Uric acid	8.5g	1g
Creatinine	1.6g	1.6g

### Tubular Secretion

This is the final step in the formation of urine during which the walls of tubule actively remove additional waste substances which are harmful to the body from the blood that have escaped filtration.

## **Renal Failure**

The reduction in the ability of the kidneys to filter waste products from the blood and excrete them in the urine is called as renal failure. The regulation of the water balance, salt balance and control of blood pressure are impaired due to kidney failure. The kidney failure also leads to uraemia (a built up of urea and waste products) and other chemical disturbances in the blood and tissues. This leads to various disorders and symptoms.

Kidney failure can be acute (of sudden onset) or chronic (developing more gradually). In acute Kidney failure kidney function returns to normal once the causes have been discovered and treated. In chronic kidney failure the kidney function does not revive since it is caused by poor supply (flow) of blood, major illness, heart attack or pancreatitis. This damages the kidney tissue and its function. Heart transplantation is suggested for chronic type of failure.

## **Dialysis**

Dialysis involves a technique used for removing waste products from the blood and excess fluid from the body as a treatment for kidney failure.

### **Why it is done?**

The kidneys filter approximately 1500 liters of blood daily. From this volume of blood, the kidney reabsorbs important elements such as sodium, potassium, calcium, amino acids, glucose and water. In people whose kidney have been damaged this process may fail either suddenly (in acute kidney failure) or gradually in chronic renal failure. Waste starts to accumulate in the blood, with harmful, sometimes even life threatening effects. In severe cases, the function must be taken over by artificial means of dialysis. Dialysis is called artificial kidney.

## **Kidney Machines**

A kidney machine is a mechanical device through which a patient's blood passes. The blood leaves the body usually from an artery in the forearm and return to a nearby vein. Inside the machine the blood flows over or between membranes containing dissolved fluid (Dialysing fluid) and salt in concentrations normally found in blood. Solid constituents in the blood

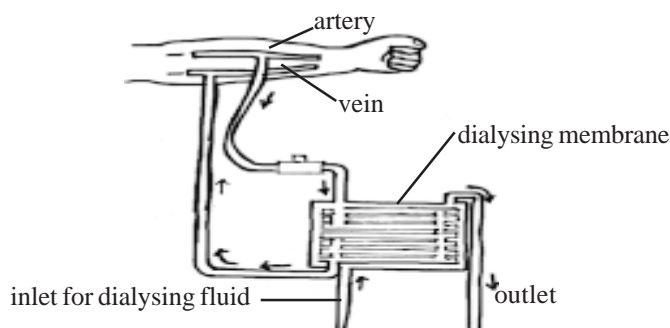
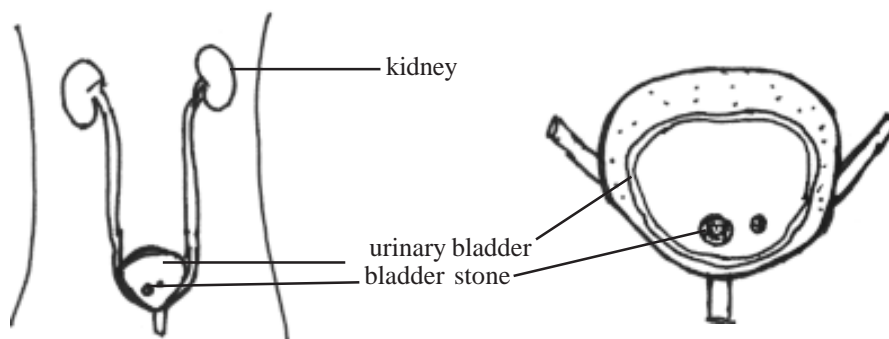

**Fig.1.37. Artificial dialysis**

in excess of normal concentrations diffuse across the membrane into the dialyzing fluid. In this way waste like urea which accumulate in the body are extracted. Blood cells and protein remain in the blood. The process is called haemodialysis.

Two kinds of dialysis are performed in clinical medicine. They are haemodialysis and peritoneal dialysis.

### **Kidney stone (Calculus)**



**Fig.1.38. Excretory system**

**Fig.1.39. Stones in the bladder**

Stone formation in the kidneys, Ureters or Bladder, is caused by the precipitation from the solution of the substances in urine. Kidney and Ureter stones are more common than Bladder stones. The incidence of stone formation is highest in summer months as the urine is more concentrated due the loss of fluid in the sweat. The stones tend to be a recurrent problem. Chronic dehydration is the main cause for kidney stones. Kidney stone consists mainly of calcium oxalate and/or phosphate.

Stone consists mainly of uric acid and may occur in people with GOUT.

Bladder stone usually develops as a result of a diet that is low in phosphate and protein. The most common symptom of a stone in the kidney or ureter is renal colic (a severe pain) and the symptom for the bladder stones manifest with difficulty in passing urine. Stones in the bladder and lower ureter can be crushed and removed by cystoscopy or by ureterorenoscopy. The first line of treatment is **lithotripsy** which disintegrates stones by focusing shock waves on them from outside the body.

### **Kidney transplantation**

Kidney transplantation refers to an operation in which a diseased kidney is replaced by a transplanted healthy kidney, either from a living donor or from a person who has just died (cadaver). One healthy donor kidney is sufficient to maintain the health of the recipient.

Factors in improving the results of transplant surgery are

- (1) To prevent rejection, effective immune suppressant drug treatment is given.
- (2) Tissue typing is necessary to help in matching recipient and donor tissue for transplant surgery thus minimizing the risk of rejection of a donor organ by the recipient's immune system.
- (3) After removal of organ from the donor it should be washed with an oxygenated fluid and cooled. This reduces the risk of damage.

### **Diabetes mellitus**

Diabetes mellitus is the metabolic disorder of carbohydrate metabolism caused by insufficient or nil production of the hormone *insulin* by the *pancreas*. Insulin is responsible for the absorption of glucose into cells for their energy needs and into the liver and fat cells for storage as glycogen reserve. Insulin deficiency may be due to (1) pancreatic disorders (2) defects in the synthesis of insulin from Beta cells of Langerhans (in pancreas) (3) destruction of Beta cells and (4) genetic defects etc.

### **Symptoms**

- (1) The blood sugar level is more than 120mg. in diabetic patients.

(2) Untreated diabetes exhibits the following symptoms.

(a) **Polyurea** - excretion of increased quantity of urine.

(b) **Polydipsia** – excessive thirst leading to increased consumption of water.

(c) **Polyphagia** – excessive appetite leads to increased intake of food. In spite of over eating, diabetic patient loses weight.

(3) Weakness and body pain are the common symptoms.

(4) The body's inability to store or use glucose causes weight loss, insatiable hunger and fatigue.

(5) Diabetes mellitus also results in abnormal (fat) metabolism.

(6) Accelerated degeneration of small blood vessels.

Types of diabetes mellitus

(1) Insulin –dependent type.

(2) Non-insulin dependent.

*Insulin-dependent type:* This type develops due to heavy viral infection which reduces the production of insulin.

*Non-insulin dependent:* This is due to inadequate amount of insulin production. Obesity (over weight) is the major reason. This type usually has a gradual onset and develops mainly in people over 40. Recently insulin resistant diabetes is commonly noticed and reported in younger persons too.

### **Causes for Diabetes**

(1) Diabetes tends to run in families so it occurs in people who inherit the genes responsible for the insulin dependent form.

(2) Viral infection that damages the pancreas causing the deficiency of insulin.

(3) Obesity is the major cause leading to development of non insulin dependent diabetes.

(4) Severe illness such as pancreatitis and thyrotoxicosis causes diabetes.

(5) Intake of drugs like corticosteroid drugs and diuretic drugs.

### **The preventive measures comprise**

- (1) Maintenance of normal body weight through adoption of healthy nutritional habits and physical exercise.
- (2) Correction of over nutrition and obesity may reduce the risk of diabetes and its complications.
- (3) Alcohol and smoking should be avoided.
- (4) Control of high blood pressure, elevated cholesterol and high triglyceride levels.
- (5) Susceptible persons can prevent diabetes by avoiding the risk factors.

When diabetes is detected, it must be adequately treated. In order to maintain blood glucose levels within the normal limits one should maintain ideal body weight. It is achieved by balanced diet, physical exercise, frequent checking of blood sugar, blood pressure. Maintenance of body weight and visual acuity are some prognostic tips.

### **Reproduction**

All living organism maintain their populations by reproduction. Most simple organisms such as bacteria reproduce asexually by cell division resulting in offspring's that are genetically identical.

In human beings, reproduction is sexual, involving the fusion of two reproductive cells, namely a sperm (male gamete) and an egg (female gamete). If a sperm succeeds in fertilizing an egg, DNA (genetic material) from each parent combines to create a unique individual. Sexual reproduction results in an infinite variety of offsprings.

### **Functioning of male reproductive system**

The central role of the male reproductive system is carried out by the testes, which produce sex cells called spermatozoa or sperms containing genetic material. The testes produce sperms continuously from puberty onward. Men remain fertile for a much longer period than women. In addition, the testes manufactures male sex hormones or androgens which influence sperm production, fertility and sex drive. Male sex hormones also promote the secondary sexual characters.



## Gametogenic function of testes

Factors controlling spermatogenesis: FSH of pituitary gland stimulates and controls spermatogenesis. It acts on sertoli cells to facilitate last stages of maturation of spermatids. It further stimulates the production of androgens such as testosterone.

The LH of the pituitary acts on the Leydig's cells of the testes that releases testosterone. The temperature of testes should be maintained at 32°C for an effective production of spermatozoa.

## Spermatozoa

Each mature spermatozoan is a motile cell . It has an oval flat head having an acrosome and a large nucleus containing chromosomal material. The head is followed by a short neck, a body (middle piece) and a long tail. The middle piece contains spiral mitochondrial sheaths which are the site of energy production. The tail has a main piece and an end piece. The energy for movement is provided by ATP molecule.

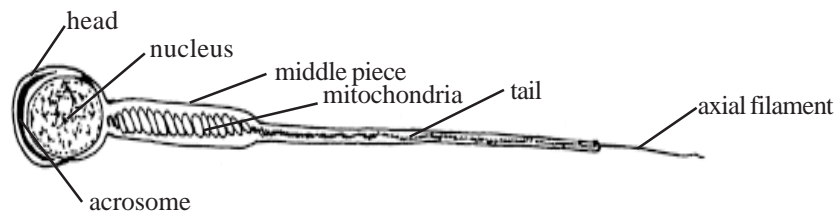

Fig.1.40. Spermatozoan structure

## Puberty

Puberty is a process in sexual development. Once puberty is reached sperms are manufactured continuously in the two testes at a rate of about 125 million each day. Puberty occurs between age 12-15 Hormones secreted by the pituitary cause levels of the male sex hormone testosterone to increase, stimulating changes such as general growth, and the development of secondary sexual characters.

**Transport of spermatozoa.** For reproduction to take place, the sperm must be transported to the female reproductive system. The mature spermatozoa that are formed leave each testis through an epididymis, a long coiled tube that lies above

and behind each testis. The sperms are stored in the epididymis and periodically pushed into the vasdeferens the tube that connects an epididymis to an ejaculatory duct. During sexual activity each vas deferens, contracts and pushes the sperm toward urethra, the tube that connects the bladder to the outside of the body. The sperms are carried in a fluid consisting of secretions from various glands forming a thick seminal fluid or semen.

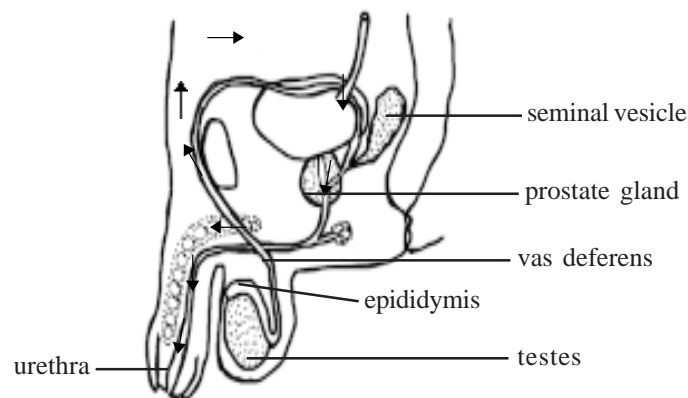

**Fig.1.41. Male reproductive system**

Semen is a milky mucoid fluid which contains sperms (50 million in single ejaculate) plus seminal plasma made up of secretions of the seminal vesicles, prostate, Cowper's gland and bulbo - urethral glands. Semen provides nutrient that help to keep the sperm healthy and also serves as a medium for the spermatozoa to swim.

During arousal, the penis gets enlarged and becomes firm. Muscular contraction at the have of the penis then forces the sperm through the male urethra into the vagina during male orgasm.

**Hormonal control:** Male reproductive function is controlled by several hormones.

1. The hypothalamus of the brain controls the release of FSH and LH through its releasing factors.
2. FSH and LH stimulate the gonads. Hence the gonads produce sperms and secrete the hormone, testosterone.

3. Testosterone controls further male reproductive functions. It also helps to develop and maintain secondary sexual characters, such as enlargement of larynx, deepening of voice, growth of hair and other adolescent changes.

### **Regulation of testicular function**

The hypothalamus, anterior pituitary and testes are interrelated in testicular functions. FSH from the pituitary stimulates spermatogenesis in the presence of testosterone. High concentration of testosterone is maintained due to the presence of androgen binding protein which is secreted by the sertoli cells. These cells also secrete another hormone called inhibitin which inhibits the action of testosterone.

Testosterone secretion by Leydig cells is stimulated by LH. The testosterone has its action on different target cells. It diffuses into the seminiferous tubules and stimulates spermatogenesis and suppresses secretion of LH by acting on hypothalamus and anterior pituitary.

### **Functioning of female reproductive system**

The central role of the female reproductive system is carried out by the ovaries. They produce sex cells called ova or eggs containing genetic material.

By a process of fertilization an egg derives the potentiality to develop into a foetus. The ovaries also secrete female sex hormones that control sexual development and the menstrual cycle

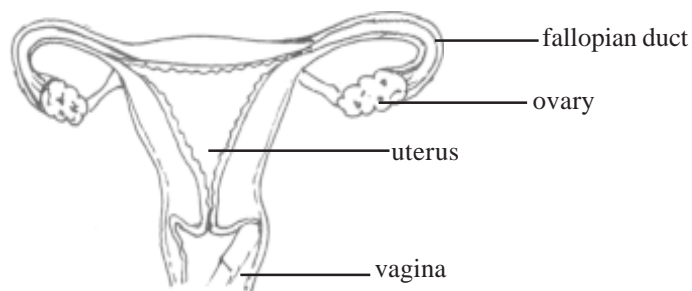

**Fig.1.42. Female reproductive system**

### Endocrine function of Ovary (Female Sex Hormones)

The ovaries produce the female sex hormones oestrogen and progesterone. The secretion of these hormones are controlled by follicle - stimulating hormone and lutenizing hormone which are produced by pituitary gland. Female sex hormones control sexual development at puberty, the menstrual cycle and fertility.

#### Oestrogens

These are steroidal hormones secreted by the theca interna of the ovum, cells of graffian follicle, corpus luteum and placenta. Oestrogen hormone controls the development of accessory sex organ and secondary sexual characters. It regulates menstrual cycle. Oestrogen promotes growth of ovarian follicles. Further it causes the growth of the breasts and formation of melanin pigments.

**Progesterone** is the principal hormone secreted by the corpus luteum. It prepares the uterus for implantation of the fertilized ovum. It helps in the formation of placenta and for maintaining pregnancy. Further during pregnancy it inhibits contraction of uterus. It also suppresses ovulation and menstruation in pregnancy.

#### Structure of a mature ovum

Human ovum is small and contains no yolk (Alecithal egg) It is more than 100µm in diameter At the time of ovulation, the ovum is surrounded by a striated membrane called zona radiata and later it is replaced by an unstriated membrane **Zona pellucida** (Primary egg membrane).

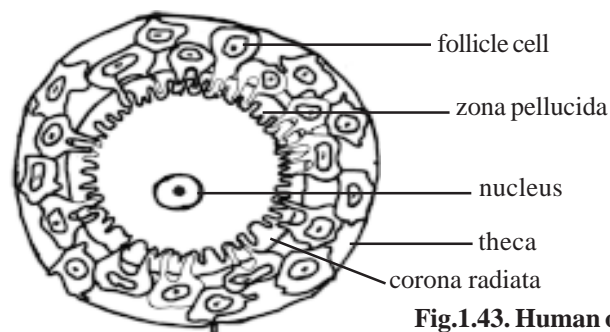
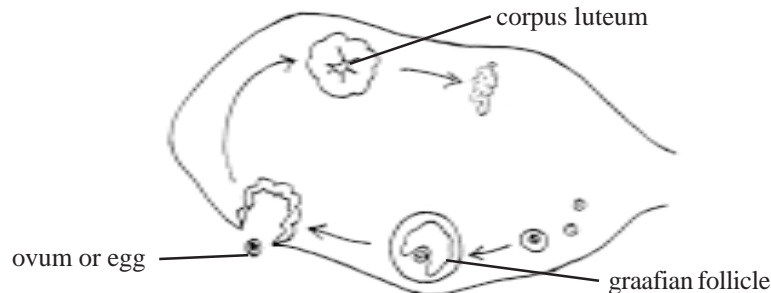

Fig.1.43. Human ovum

The growing oocytes are surrounded by follicle cells. Some of the follicular cells of the ovary are found outside the zona pellucida and are termed as **Corona radiata** (Secondary egg membrane) which is peeled off when the oocyte passes down the oviduct. The follicles and the developing oocyte together constitute **Graafian follicle**. The whole surface of the graafian follicle is supported by theca interna and theca externa.

### Ovulation and fate of the ovum

The shedding of the ovum from the ovary is called ovulation. The ovarian follicle enlarges and reaches the surface of the ovary. The stroma and the theca of the Graafian follicle ruptures and the ovum is shed from the ovary. As it reaches



**Fig.1.44. Ovulation**

the fallopian tube it may get fertilized. The fertilized egg reaches the uterus and gets implanted on its wall. If the ovum is not fertilized in the fallopian tube it dies in 12- 24 hours.

### Corpus luteum

The corpus luteum is an important structure needed at the time of pregnancy. It is derived from the empty graafian follicle after ovulation. The corpus luteum secretes a hormone called progesterone. It is a steroid hormone, secreted in significant amounts by the corpus luteum and placenta.

### Menstrual cycle

The functioning of the reproductive system in human adult female is characterized by the menstrual cycle. While the changes concerned within ovulation and the formation of the corpus luteum, are going on in the ovary, the uterine

endometrium shows striking cyclical changes. The rhythmical series of changes in the sex organs occur for about 28 days through out the reproductive life of women from puberty to menopause (except during times of pregnancy). It is called the **menstrual cycle**.

The most prominent feature of this cycle is a monthly flow of blood from the genital canal. This is called menstruation or menses. A menstrual cycle begins with the onset of menstrual bleeding and ends just before the next menstruation.

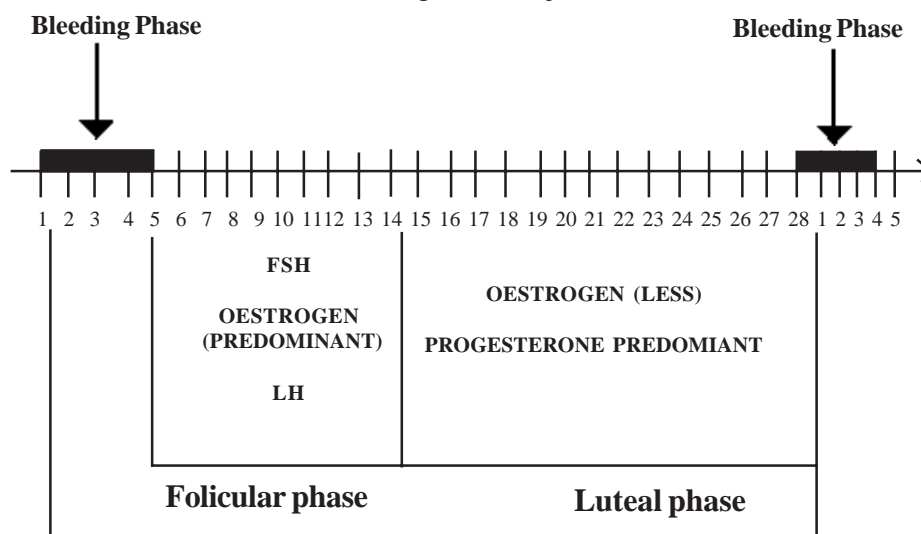

**Menstrual cycle.** Fig.1.45. Menstrual cycle

The menstrual cycle is usually divided into the following phases on the basis of changes taking place in the uterine endometrium.

**The follicular phase or Proliferative phase ( 5th day - 14th day)**

The follicular phase is initiated by the release of follicle stimulating hormone (FSH) from the anterior pituitary gland. During this phase, a primary follicle begins to enlarge. While it is growing, the follicles secrete **oestrogen** and smaller quantities of progesterone into the blood. Under the effects of oestrogen from the developing follicle, the endometrium starts regenerating from the basal portion. Deeper parts of the glands start

proliferating. By day 14, graffian follicle has matured and pushed up against the ovary surface. The secretion of FSH ceases at the end of follicular phase.

### **The Luteal phase or Premenstrual phase (15th day - 28th day)**

The luteal phase begins at day 14. Under the influence of Leutenizing hormone (LH) released by the anterior pituitary, rupture of graffian follicle and release of ovum (ovulation) occurs. After ovulation, the empty follicle is transformed into a transitory endocrine gland called **corpus luteum**. The corpus luteum slowly increases in size and releases a large quantity of **progesterone** and smaller amount of oestrogen into the blood. The progesterone acts on endometrium of the uterus, preparing it to receive the fertilized ovum. To maintain pregnancy and to prevent the contraction of uterus, the progesterone hormone is highly essential. If there is no fertilisation, the corpus luteum degenerates and is reabsorbed by the ovary at the end of luteal phase.

### **The menstrual phase (1st - 5th day)**

The decline in progesterone and oestrogen initiates shedding of the endometrium and severe bleeding in a process called mensus or menstruation. During this phase, all the extra layers are sloughed off along with unfertilized egg. At the termination of menstruation, the corpus luteum is converted into a scar tissue called **corpus albicans**.

### **Fertilization**

The union of the egg and the sperm is called **fertilization**. It results in the production of a single diploid cell called **zygote**.

At the time of ovulation, the ovum is fully matured and it enters the infundibulum of the uterine tube and passes into the ampulla. Fertilization of the ovum occurs in the ampulla of the uterine tube. One spermatozoan pierces the egg membrane, zona pellucida and enters the ovum. Polygamy (entry of more sperms) is avoided by the formation of fertilization membrane around the ovum.

### **In vitro fertilization (Test tube babies)**

The so called test tube babies are produced by the technique of in vitro fertilization. (*In vitro* = outside the body, as against *in vivo* = within

the body). This technique is being increasingly used in couples who are not able to achieve fertilization in the normal way

Gonadotropins are administered to the woman to stimulate growth of follicles in the ovary. Just before ovulation, the ovum is removed (using an aspirator) and is placed in a suitable medium. Spermatozoa are added to the medium. Fertilization and early development of the embryo takes place in this medium.

The process is carefully monitored. When the embryo is at the 8-celled stage, it is put inside the uterine endometrium. Successful implantation takes place in about 20 percent of such trials. The techniques are complex and need a team of well trained experienced personnel with high degree of skill. The success rate is only about 20% and 2 or 3 attempts may be necessary. It is also very expensive. The first success with this technique was achieved by *Steptoe* and *Edwards* of UK in 1978. However successful 'test tube babies' have been produced in many countries including India.

### **Gamete Intra fallopian transfer (GIFT)**

It is a newer method in which the fertilized ova are introduced into the fallopian tube from where they naturally pass to the uterus for implantation. This method is considered to have a higher success rate than IVF. An even newer technique is the introduction of a single sperm into the ovum by microinjection.

### **Birth control**

The population problem is assuming serious proportions in many developing countries. In India, the population which was about 400 million in 1960 is now 100 crores or 1000 million. Realizing the dangers inherent in population growth, the government of India has taken several measures to check population growth and have given family welfare programmes an important place in the five year plans. The World Health Organization (WHO) has also stressed the importance of family planning in the Global Strategy for Health for All by 2000 AD.

The National Family Welfare programme is a comprehensive scheme which includes:



1. Maternal and Child Health Care (MCH)
2. Immunization of mothers, infants and children.
3. Nutritional supplement to pregnant women and to children.
4. Contraception with health education, to motivate couples to accept contraceptive methods and to adopt small family norms.

### **Contraception :**

Contraception is the prevention of pregnancy resulting from coitus.

#### **A. Barrier Methods**

Prevents entry of sperms into vagina or uterus.

(a) **The Condom:** The male wears a condom which covers the erect penis, and prevents deposition of sperms in the vagina. Condoms are made of rubber from latex. Ejaculated semen is retained within the condom preventing their entry into uterus. In India thin condoms called Nirodh, are manufactured and widely used. Condoms can be combined with spermicides inserted into the vagina. Condom also protects against sexually transmitted diseases (STD) like syphilis, AIDS.



**Fig.1.46. Condom**



**Fig.1.47. Cervical caps**

(b) **The Diaphragm (cervical cap):** Women can wear a vaginal diaphragm fitting into the vagina or a cervical cap fitting over the cervix. They prevent entry of sperms into the uterus. They are made of synthetic rubber or plastic, and are used in combination with chemical spermicides.

#### **B. Hormonal Methods**

Hormones are prescribed as *pills, implants, or injections*. Some hormonal contraceptives contain only progestin, which is a type of female hormone and some contain a combination of both (*combined pill*) progesterone and oestrogen and prevents ovulation. Hormonal methods are

nearly 99 percent effective. The effects of Hormonal method stops (interfere) the mechanism of ovulation. They can also stop the mechanism of conduction of ovum along the fallopian tubes. The hormones interfere in the thickening of the endometrium and they may also cause the formation of mucus in the cervix and vagina to prevent the penetration of sperms.

### C.Mechanical Methods

The intrauterine device (IUD) and intrauterine system (IUS) are contraceptive devices inserted into the uterus. *Copper-T* is a synthetic T shaped device made up of copper and plastic (non irritant), is placed inside the uterus. This can remain for a period of 3 years. This also helps to give adequate time interval between pregnancies.

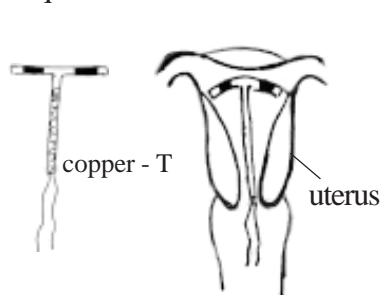

Fig.1.48. Copper-T

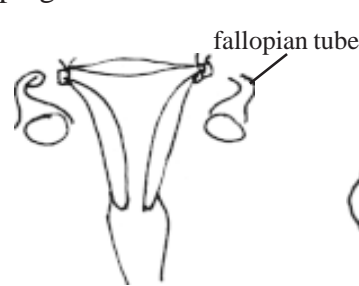

Fig.1.49. Tubectomy

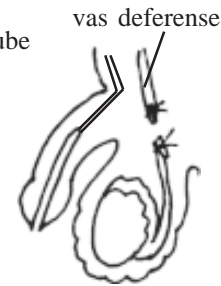

Fig.1.50. Vasectomy

### D.Surgical Methods

Surgical contraception, or sterilization, is an operation that makes a person infertile. This surgery can be carried out in men (vasectomy) and in women (tubectomy).

**Vasectomy** is the method of permanent birth control in male in which the removal of a part of the vas deferens and ligations are performed. It is simple in all aspects. Male sterilization is not immediately effective. The seminal vesicles still contain sperm after the operation, and a condom must be used until semen analysis shows that no sperm are left. **Tubectomy** is the method of permanent birth control in female, here a portion of fallopian tube is cut of and the cut ends are ligated to prevent fertilization. Female sterilization is effective immediately, but the risk of ectopic pregnancy is slightly increased.

## 2. MICROBIOLOGY

### **Introduction:**

The world of microorganisms includes various species of bacteria, viruses, fungi and protozoan parasites. The discovery of microscope and the ingenious techniques of isolation and identification of these microbial organisms opened up a new field of study named **Microbiology**. This study deals with the form, structure, reproduction, physiology, metabolism and classification of micro organisms. The area of microbiological studies include various aspects of their distribution in nature, their relationship to each other and to other organisms, their effects on plants, animals and human beings, their roles in the sustainability of environmental habitats such as soil, air and water and also their beneficial aspects to biotechnology.

### **History of Medical microbiology:**

The medical microbiology had its origin in the year 1888 when the Pasteur Institute in Paris (France) was established. Robert Koch became the Director of the Institute For Infective Diseases. Both Louis Pasteur and Robert Koch infused the spirit and interest to gain knowledge in medical microbiology to the countrymen of America and Europe. The medical microbiology deals with the aspects of infection, the causative agents of infection and the diseases due to infection. Following the establishment of Germ Theory of Diseases by Pasteur, innumerable infectious diseases that haunt the human population were discovered. For most of these infectious diseases, the drugs and vaccines have been found.

### **Pasteur, Koch, Lister :**

Medical Microbiology involves the study of micro organisms that colonize or infect human beings; the mechanism by which they cause diseases; the body's response to infection and specific antimicrobial prevention and treatment.



**Fig. 2.1. Louis pasteur**

The contribution of **Louis pasteur** (1822 - 1895) in France in the field of microbiology lead to a greater understanding of human ailments and animal diseases. Much of Pasteur's work involved the growth of bacteria and yeasts in liquid cultures. He developed methods of sterilization and of pasteurization. Pasteur (1857) observed different kind of microbes associated with different kinds of fermentation. e.g. Spheres of variable size (yeast cells) within alcohol fermentation and smaller rods (Lactobacilli) with lactic fermentation. This finding led Pasteur to state that specific microbe may cause specific disease in man.

His crowning achievements were Pasteurisation of milk, the development of techniques to reduce the virulence of infectious organism, without eliminating their capacity to produce immunity. In this way he developed vaccines, for the control of "cholera" "anthrax" and "rabies" in man.

### **Robert Koch - (1843 - 1910)**

Robert Koch, a younger contemporary of Pasteur, made his contributions on new procedures for staining, visualizing and growing bacteria. He solidified liquid culture media with agar. He also isolated and characterized the bacilli of anthrax, and tuberculosis and demonstrated their causative role by a series of experiments.

After identifying the tubercle bacillus, Koch has advocated his postulate, in order to distinguish a pathogenic microbe from adventitious microbes. The impact of his work towards the end of 19th century lead to the discovery of "specific toxins" made by the causative bacteria for diphtheria and tetanus and "antibodies" produced in host animals against the

toxins to neutralise their effect. His finding also lead to immunization therapy. He was awarded the Nobel Prize in the year 1905 for his work on tuberculosis.

**Contributions of Joseph Lister :** (1827 - 1912) to microbiology is the technique of “pure culture” of bacteria. The growth of a mass of cells of the same species in a laboratory vessel / test tube using serial dilutions in the liquid media is called pure culture. Lister obtained a pure culture of the organism *Bacterium lactis* and also found the importance of pure culture which form the suitable media for the growth of micro organisms, responsible for infections, fermentation, nitrogen fixation in soil, etc. The pure culture techniques lead to developments in modern microbiology.

On the basis on Pasteur’s evidence, in 1860 Joseph Lister, discovered a system for “antiseptic” surgery. This system prevents the surgical wound infection and other lethal complications.

### **I. Virus: Structure, Genetics, Culture and Diseases:**

Viruses are infectious agents. They are much smaller than the bacteria. Their approximate size ranges from 20 to 300 nm. Viruses are incapable of independent growth in artificial media. They can grow only in animal or plant cells or in microorganisms. Hence they are referred to as obligate intracellular parasites. They reproduce in these cells by replication. Replication is a process in which many copies or replicas of the viral component are assembled and made to represent the progeny. They lack metabolic machinery of their own to generate energy or to synthesize proteins. They depend on the host cells to carry out these vital functions. The bacterial viruses are called **bacteriophages**. These viruses infect the bacteria and multiply inside the bacterial body and cause the lysis of bacteria (lytic cycle) or integrate themselves with the bacterial genome (lysogeny).

#### **Structure of Viruses:**

Animal and plant viruses are composed of a central core of nucleic acids surrounded by a protein covering called capsid. The capsid is made up of units called capsomeres. Viruses exhibit a characteristic symmetry, 1. Spherical viruses are isohedral, 2. Rod shaped viruses are helical in symmetry. Certain group of viruses are complex in symmetry.

Some animal viruses, in addition to the nucleocapsid structure contain an outer membrane like structure called the envelope. The envelope is made up of lipoproteins. The envelope conceals the symmetry of viruses. Virions with envelopes are sensitive to lipid solvents such as ether and chloroform. On the other hand, the naked virions are not affected by the lipid solvents.

Isohedral viruses such as adeno viruses, SV15, polio viruses and blue tongued viruses are spherical in shape and their surface is a lattice with identical triangular units.

Helical surface symmetry and structure are characteristic of tobacco mosaic virus(TMV) and animal viruses that cause diseases such as measles, mumps, influenza and rabies. In these, the nucleocapsid is a flexible structure packed within a fringed lipoprotein envelope. The fringes are made of glycoproteins. In TMV the nucleic acid core is covered by a capsid consisting of closely packed capsomeres arranged in a helix.

Complex or uncertain symmetry is seen in Pox viruses, T-bacteriophages. These have different proteins and lipoproteins.

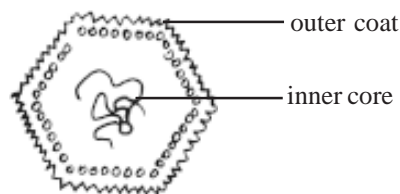

**Fig. 2.2. Morphology of viruses**



**Fig. 2.2(a). T<sub>2</sub>-bacteriophage**

### **Viral genetics:**

The viral genome contains all the genetic information either as DNA or RNA. but never both. The proportion of nucleic acid in a virion varies from 1 % as in influenza virus to about 50%, as in certain phages. Smaller viruses like paraviruses may have 3 to 4 genes while larger viruses like herpes and pox may have several hundred genes. Virions contain only a single copy of the nucleic acid. Hence they are called haploid viruses. The only exception is the retroviruses, which are said to be diploid as they contain two identical single-stranded RNA genomes. The virions are called the infectious particles.

The structure of nucleic acid in the virion may be either linear or circular. The DNA of most animal viruses is a linear molecule. In some plant viruses the genome is a circular RNA. But the RNA in animal viruses exists only as linear double stranded or single stranded molecule.

### **Cultivation (culture) of Animal viruses:**

Viruses can grow only in living cells. However the culture of viruses is possible nowadays. The most economical and convenient method of cultivating a wide variety of animal viruses is the 'chicken embryo technique'. In this technique, fertile chicken eggs incubated for 5 to 12 days are inoculated with the virus particles through the shell, aseptically. The opening may be sealed with paraffin wax. The eggs incubated at 36°C are ideal sources for the growth of viruses.

Chick embryos contain several different types of cells in which various viruses will undergo replication. The yolk sac is a general ideal medium for the growth of viruses.

Viral cultures are of three types viz., Primary cell cultures, diploid cell strains and continuous cell lines.

#### **1. Primary culture:**

Primary cell culture are derived from normal tissue of an animal such as mouse, hamster, chicken and monkey or a human being. When cells from these tissues are processed and cultured the first monolayer is referred to as the primary culture. A monolayer is a confluent layer of cells covering the surface of a culture vessel.

#### **2. Diploid cell strain:**

Diploid cell strains are derived by primary cell cultures from a specific tissues like lung or kidney which is of embryonic origin. These diploid cells are the most employed host of choice for the production of human vaccine virus.

#### **3. Continuous cell lines:**

Continuous cell lines are capable of an infinite number of doublings. Such cell lines may arise with the mutation of a cell strain or more commonly

from the established cell cultures from malignant tissue. Many viruses, which are difficult or impossible to grow have been cultured in continuous cell lines.

### **Viral Diseases:**

#### **A. Cancer and Viruses:**

Viruses have been identified as one of the causative agents for cancer or tumour. Such tumour inducing viruses are called oncogenic viruses. Adenoviruses, polioma virus, simian virus 40 (SV 40), Epstein-Barr virus (EBV) ( a herpes virus) are oncogenic DNA viruses. The RNA sarcoma viruses are oncogenic RNA viruses (eg., Rous sarcoma).

#### **B. Rabies Virus and Rabies disease:**

Rabies virus belongs to the rhabdovirus family. It is a parasite of domestic and wild mammals. The transmission to humans occurs through the bite of an infected animal. Dogs, cats, bats, are the mammalian animal sources for the rabies virus.

In humans, the symptoms of rabies are severe headache, high fever, alternating excitement and depression, muscular spasms in throat and chest, hydrophobia etc. The incubation time in humans is usually about 3 to 8 weeks but it may also vary. If untreated the mortality rate from rabies is 100 percent.

The new rabies vaccine was discovered in 1980. It is an inactivated vaccine prepared from the virus propagated in cultures of diploid human cells. This vaccine is both safe and highly immunogenic.

#### **C. Pox virus:**

Pox viruses are the largest of all viruses and are brick shaped. They contain double stranded DNA, protein and lipid. They have a dum bell shaped nucleoid surrounded by two membrane layers.

Variola virus is called the small pox virus. It is transmitted by droplet infection either directly from the infected person or by handling articles infected by the patient. Small pox is completely eradicated. The small pox vaccine consists of vaccinia, closely related to variola. It gives protection both by humoral and cell mediated immunity.

Other pox viruses are chicken pox and measles viruses.



## D. Hepatitis-B:

Hepatitis B virus (HBV) is an enveloped virus with a double stranded DNA. This causes jaundice and hepatic carcinoma. This disease is deadly and more infective than AIDS. HBV vaccine consists of purified HBV Ag (Australian antigen) obtained from the blood serum of apparently healthy carriers.

## II. Bacteria - structure

The structure, size and arrangement of bacterial cells constitute their morphology.

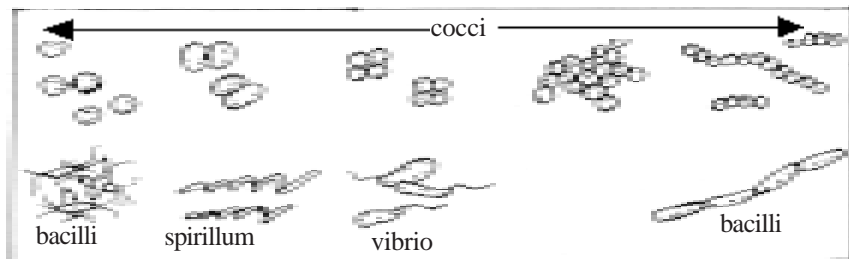

Fig. 2.3. Morphology of bacteria

The various morphological features are

1. They are spherical or rod like or spiral shaped.
2. The arrangement of cells in pairs, clusters, chains, trichomes and filaments etc.
3. The appendages are visible by special staining techniques or by electron microscopy.

The above three features represent the gross morphological characteristics, which are of taxonomic importance in bacterial species identification. In addition, the bacterial cells possess elaborate internal structures, which constitute microbial cytology and bacterial anatomy.

## Bacterial Culture

All bacteria need nutrients for their growth. They need a nutrient

medium for their growth and culture. A bacteriological medium is composed of known chemical compounds. It is called a chemically defined medium or synthetic medium, The compounds are carbohydrates, proteins, nucleic acids, lipids, vitamins and other complex organic substances. Certain complex materials include peptones, meat extract, yeast extract etc. The medium with the above raw materials can support the growth of a wide variety of heterotrophic bacteria. Agar is included as a non-nutritive solidifying agent. Nutrient agar and nutrient broth are the simple solid and liquid media for the growth of heterotrophs respectively.

The preparation of bacteriological media involves the following steps.

1. Each ingredient or the complete dehydrated medium is dissolved in the appropriate volume of distilled water.
2. The pH of medium is determined.
3. Agar is added and the medium (solid medium) is boiled to dissolve agar.
4. The medium is dispersed in flasks or tubes.
5. The medium is sterilized by autoclaving.

The growth of bacteria also require in addition to nutrients, physical conditions such as temperature, gaseous conditions and pH (acidity and alkalinity) and other miscellaneous requirements such as illumination, hydrostatic pressure, etc.

### **Bacterial Genetics :**

In bacteria the cells have a single circular strand of DNA. It is not associated with proteins as are eukaryotic chromosomes. The bacterial genes, like the eukaryotic genes possess the features of replication, phenotype expression, mutation and genetic recombination etc. In bacteria the genetic recombination results from three types of gene transfer viz., conjugation, transduction and transformation.

Conjugation involves the transfer of some DNA from one bacterial cell to another followed by the separation of the mating pair of cells. In this, large segments of the chromosomes and in special cases the entire chromosome may be transferred.

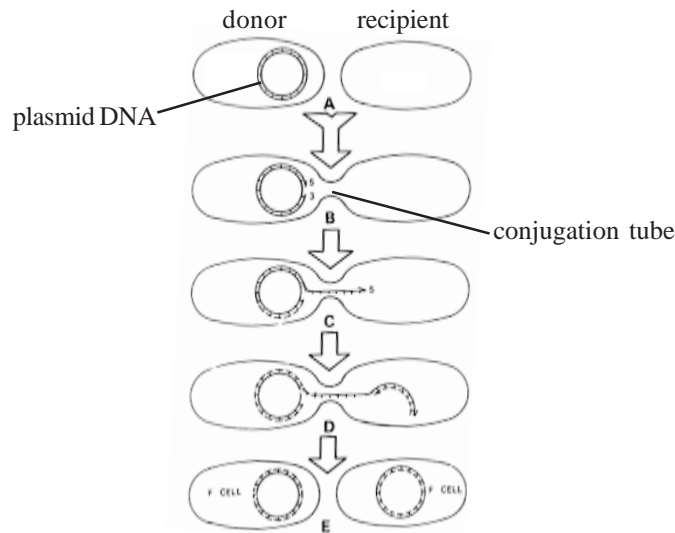

**Fig. 2.4. Bacterial conjugation**

Bacterial transformation is a process in which cell free or naked DNA containing the genetic information is transferred from one bacterial cell to another. It was discovered by an English health officer, Griffith in 1928. The transforming principle was identified as DNA by Avery Macleod and Mc Carthy in 1944.

In transduction, a bacteriophages acts as a vector, transferring a portion of DNA from one bacterium (donor) to another (receptient). If all fragments of bacterial DNA have a chance to enter a transducing phage, the process is called **Generalized transduction**. On the contrary if a few restricted genes of the bacterial chromosomes are transduced by bacteriophage, it is called **specialized transduction**.

## Bacterial Diseases

### A. Salmonella and Human Diseases:

Salmonella are pathogenic bacilli which cause three kinds of infection to humans viz., enteric fever (Typhoid or Paratyphoid), Gastroenteritis and Septicemia.

Typhoid fever is caused by *S.typhi*. It is transmitted via Pathogen contained food and water. The disease is characterized by a continued

fever, inflammation of the intestine, formation of intestinal ulcers and enlargement of the spleen.

Gastroenteritis is caused by Salmonella, but most commonly by *S.choleraesuis*. The bacteria reach the blood stream from the intestinal tract, where it multiplies. It causes recurring high fever, chills, loss of appetite and weight loss. When the bacteria infect the organs from blood they can cause meningitis, pneumonia, abscesses, nephritis, osteomyelitis, or endocarditis, etc.

### **B. Cholera :**

Cholera is caused by *Vibrio cholere*. It is a disease of antiquity and has been the cause of untold sufferings and death. Cholera is transmitted in water and food contaminated with this bacteria. In the small intestine, the bacteria adhere to epithelium, multiply and produce the enterotoxin. The symptoms of cholera are vomiting, profuse diarrhoeal stool (rice water stool) Which results in severe dehydration, loss of minerals, increased blood acidity and haemoconcentration.

### **C. Plague :**

Plague is caused by the bacterial species *Yersinia pestis*, a non motile gram negative bacilli. There are two types of plagues. They are **bubonic plague** and **pneumonic plague**. Bubonic plague is characterized by enlarged and inflamed lymph glands (Bubos). The symptoms are shivering, fever, nausea, vomiting and general weakness. In untreated cases the bubonic plague can cause 58% mortality. Pneumonic plague is a pneumonia characterized by a thin watery sputum with bright red streaks of blood. The mortality is 100% in untreated cases.

### **D. Syphilis:**

The disease syphilis is a well known and dreadful sexually transmitted disease (STD). It is caused by *Treponema pallidium*. Syphilis occurs only in humans and is transmitted by direct sexual contact (Venereal syphilis) or through placenta from an infected mother to the foetus (Congenital syphilis). Venereal syphilis progresses in three stages viz., primary, secondary and tertiary stage. The symptoms are very prominent in

the tertiary stage. It will lead to blindness, loss of hearing, brain damage, insomnia, headache and delusions and spinal cord damage.

#### **E. Gonorrhoea :**

Gonorrhoea is another sexually transmitted disease caused by *Neisseria gonorrhoea*. In the males the primary site of infection is the urethra. In the female it is the cervix. It causes pain during urination and a yellowish discharge from the urethra of males. In females also it causes painful urination and vaginal discharge. Other symptoms are fever, abdominal pain, arthritis, meningitis etc.

### **III. Protozoan microbiology**

Protozoans are eukaryotic, single celled organisms, which are predominantly microscopic in size. The majority are between 5 to 250 microns in diameter. Protozoan microbiology is mostly concerned with the disease aspects in humans. Some well known protozoan diseases in human beings are the intestinal amoebiasis, African sleeping sickness, and malaria. Several flagellate protozoans are responsible for diseases in both children and adults. *Giardia intestinalis* is associated with diarrhoea in children. Trichomonads are found in the mouth and cause gingivitis.

#### **A. Plasmodium and Malaria:**

Malaria is a mosquito borne disease caused by the protozoan, Plasmodium. The life cycle of malarial parasite comprises two phases namely the asexual phase in man and the sexual phase in the female Anopheles mosquito (Definitive host).

Four different types of Malaria are recognized on the basis of period of recurrence of fever. They are 1. Tertian, Benign Tertian or Vivax malaria, caused by *Plasmodium vivax*. 2. Quartan Malaria caused by *Plasmodium malariae* 3. Mild Tertian or Ovale Malaria caused by *Plasmodium ovale* 4. Malignant Tertian or Pernicious Malaria caused by *Plasmodium falciparum* Of the four, the malignant type is fatal.

In malarial fever, the patient suffers from shaking chills, and sweating. As the chills subside, the body temperature may rise to 106° F. The high fever is induced by the toxic haemozoin granules, which are

liberated in plasma when the parasite schizonts burst out from the RBCS. The patient also suffers from severe anaemia due to destruction of erythrocytes. Other symptoms are enlargement of spleen, due to massive increase in the number of phagocytic cells of the lymphoid macrophage system. In the case of falciparum infection thrombosis of visceral capillaries occurs. Death takes place when the capillaries of brain are plugged with both the parasites and the malarial pigment. Another very serious outcome of the falciparum infection is black water fever. It is characterized by the wholesome destruction of patient's erythrocytes and the excretion of liberated haemoglobin in the urine.

### **B. Amoebiasis**

Amoebiasis in man is due to the infection by the protozoan endoparasite (Sarcodina) *Entamoeba histolytica*. It is worldwide in distribution but, its prevalence is greater in tropics and sub tropics than in temperate zones. The vegetative trophozoite form is pathogenic. The trophozoites make their way deep into the sub mucosa of the large intestinal wall by eating through the intestinal mucosa. The blood and the ulcer contents pour into the lumen of the intestine and pass out as bloody stool. This characterizes the amoebic dysentery or amoebiasis.

### **C. Other pathogenic protozoans**

1. *Trypanosoma gambiens* - causes African sleeping sickness
2. *Leishmania donovani* - causes kala azar
3. *Leishmania tropica* - skin leishmaniasis

### **Larval microbiology**

Larval microbiology deals with human diseases caused by parasitic larvae. Parasitic infections which man acquires from animals are known as zoonotic infections or **zoonoses**. In the zoonoses, human infections are only accidental events and the parasite is not benefited since the chain of transmission is usually broken with human infection. The term **anthroponoses** means infections with parasites species that are maintained in man alone. Malaria and filaria are examples. The term **Zooanthroponoses** refers to infections in which man is not merely an incidental host but an essential link in the life cycle of the parasite (eg., Beef and pork tapeworm).

## Schistosomes or blood flukes

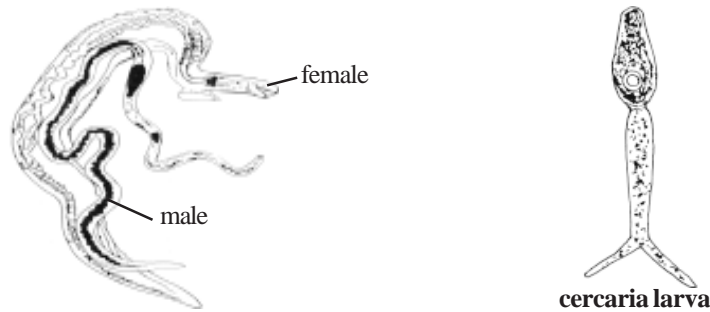

Fig. 2.5. Blood flukes

## Taenia solium (The Pork Tapeworm)

**Distribution** - *Taenia solium* is found commonly in all parts of the world where pork is eaten without being properly cooked. It is an endoparasite.

**Habitat** - Found inside the small intestine of man.

**External characters** : The body of *Taenia solium* is long, dorsoventrally flattened, narrow, ribbon like reaching a length of six to ten feet. The body is divided into three parts viz (i) Head or scolex (ii) Neck and (iii) Strobila.

**Head (Scolex)** :- The anterior end of the body of *Taenia* has a knob like part about the size of a pin-head called **scolex**. The scolex has a flat structure called the rostellum which can be protruded slightly. At the base of the rostellum, there is a double circle of minute, chitinous curved hooks. The inner circle contains larger hooks and outer circle has smaller hooks. The hooks help to fix the **scolex** firmly to the wall of the host intestine. The scolex also has cup like four suckers on the four sides. The suckers and hooks help the parasite for attachment to the intestinal wall of the host.

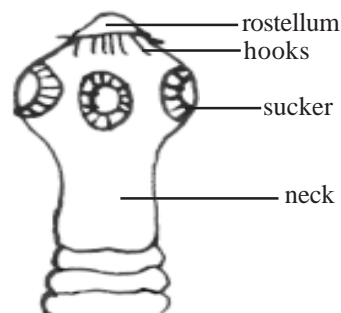

Fig.2.6. Scolex of *taenia solium*

**Neck :** The scolex is followed by a thin, narrow, unsegmented neck region. New segments called proglottides (sing. proglottis) proliferate from this region by transverse fission. Hence it is known as the region of proliferation. As the region of proliferation grows and produces new proglottides, the older ones are pushed back and gradually enlarge in size. The process of formation of new proglottides is known as **strobilization**.

**Strobila :** The rest of the body constituted by proglottides is known as **strobila**. The strobila of a mature tape worm contains about 800 to 900 segments. It hangs freely in the lumen of the intestine of the host. The segments are divided into three regions on the basis of the genital development.

**(a) Immature proglottides :** These are broader than long and have their sex organs in the process of formation or without sex organs. These are found in the anterior region of the body

**(b) Mature proglottides :** They have fully developed sex organs.

**(c) Ripe or gravid proglottides :** These are found at the posterior most region of the body and are filled with fertilised eggs.

**Life cycle -** The fully developed gravid proglottides at the posterior end get detached singly or in short chains (or groups). As the old gravid proglottides get detached, new segments are added in the neck region and the length of the worm remains constant. Some of the eggs escape out of the gravid proglottides. Therefore, both gravid proglottides and free eggs are passed out along with the faeces of an infected person.

The gravid proglottides and the eggs may be swallowed along with the faeces by the pig which is the intermediate host. On reaching the stomach of the pig, all the eggs escape out of the gravid proglottides.

The egg is whitish in colour and spherical in shape. In the centre of the egg, there is an embryo called **Onchosphere** or **Hexacanth**. The embryo is protected by a thick shell. The onchosphere possesses three pairs of minute hooklets (or hooks).

On reaching the small intestine of the pig, the onchosphere penetrates the wall of the small intestine and enters into the blood stream. Ultimately



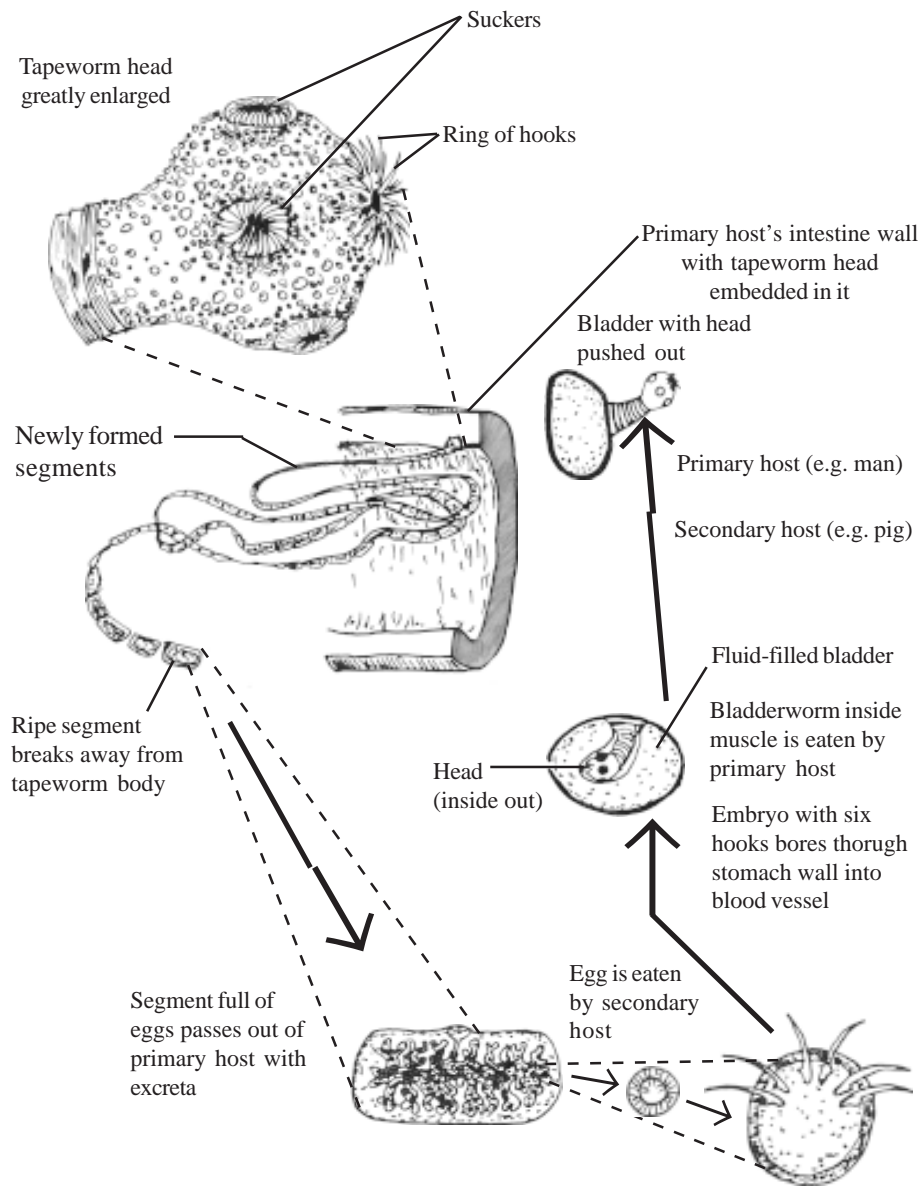

**Fig. 2.7. Life cycle of the pork tapeworm**

the onchosphere settles in the skeletal muscles. The onchosphere may settle in almost any part of the body. Then it develops into a minute bladder-like structure. This stage is called the **cysticercus** or **bladder worm**. The cysticercus gets fully developed at the end of two months.

The cysticercus is whitish in colour and oval in shape. The cysticercus of *Taenia solium* is called 'cysticercus cellulose'. It carries a small scolex enclosed in a cavity. The cysticercus can remain embedded in the muscles of the pig for many years. In the body of the pig, the cysticerci are found mainly in the striated muscles. In some cases they may be found in liver and lungs.

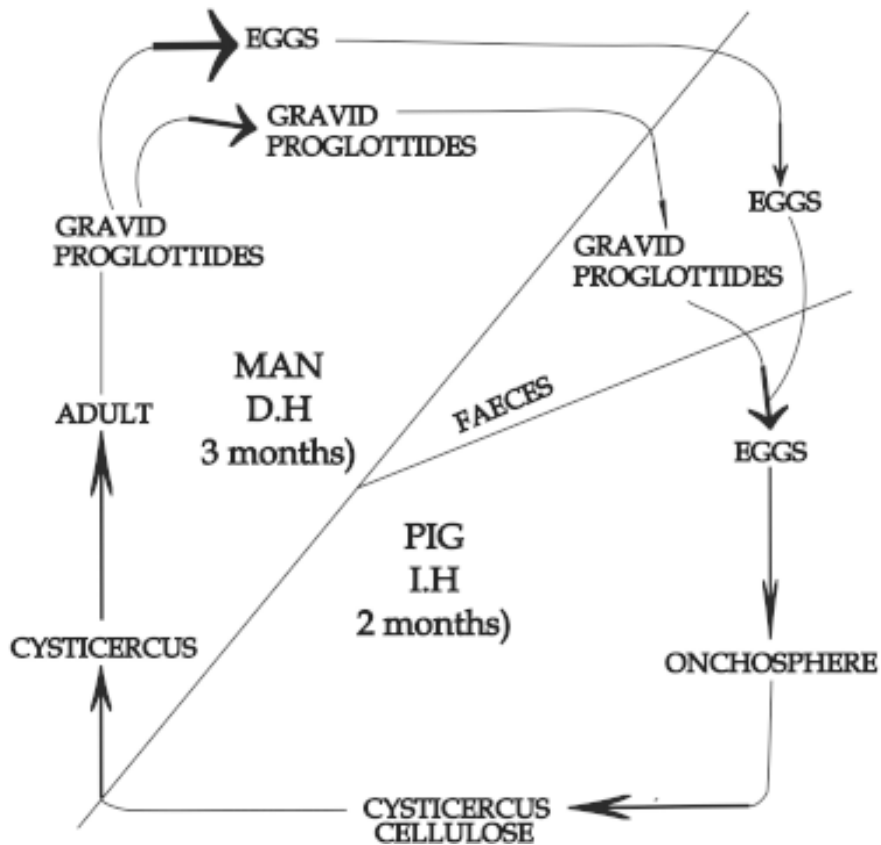

Fig. 2.8. Schematic representation of life cycle of *Taenia solium*

Man gets infected by eating raw or improperly-cooked pork containing cysticerci. Pork containing cysticerci is described as 'Measly pork'. On reaching the small intestine of man, the bladder portion of the cysticercus gets disorganised and the scolex escapes out. The scolex then attaches itself to the mucous membrane and begins to develop proglottides. The full adult stage is reached after a period of three months. For this parasite, man is the **definite host** and the pig is the **intermediate host**.

**Pathogenicity or parasitic effect :** The disease caused by adult Taenia is known as Taeniasis. The disease caused by bladder worm infection is called cysticercosis. Taeniasis is characterised by abdominal pain, indigestion, vomiting, loss of appetite and nervous disorders. Tapeworm blocks the alimentary canal passage.

**Treatment :** For treatment of Taenia infections antihelminthic drugs may be administered in prescribed dose.

**Control :** (1) Measures against indiscriminate defaecation.

(2) Proper disposal of night-soil or faeces.

(3) Proper cooking of the pork.

(4) It is important to detect and treat persons who have adult worms as they can develop cysticercosis due to autoinfection.

**Ascaris lumbricoides** (The Round worm, Giant intestinal worm)

**Distribution.** This worm is found throughout the world except very cold regions.

**1. Habitat :** The round worm, *Ascaris lumbricoides* is the largest nematode parasite in the human intestine.

#### **External Characters**

*Ascaris lumbricoides* is an endoparasite found in the small intestine of man. The body is long and cylindrical in shape with pointed ends. It has an unsegmented body with dull reddish yellow colour. The mouth lies at the anterior end and is provided with three finely toothed lips (one dorsal and the other two are venterolateral). The lips are provided with two pairs of sensory papillae.

The worms show sexual dimorphism ie sexes are separate. They differ in the following ways.

1. Male worm is about 15-30cm in length and the female worm is about 20-40cm in length.
2. The posterior end of the female is straight, whereas that of the male is curved ventrally like a hook.
3. Anus is present in the female and the cloacal aperture in the male.
4. In the female, the genital aperture is distinct from the anus and lies ventrally about a third of the length of the body from the anterior end, whereas in the male, there is a single aperture, the cloacal aperture which serves both as the anus and the genital opening.
5. Two curved chitinous spicules are projecting from the cloacal aperture in male only.

A little behind the anterior end a median excretory pore is present on the ventral side in both the sexes. Four longitudinal streaks or lines are present on the body wall extending from end to end of the animal. (One mid dorsal, one mid ventral and two lateral in position).

The body is covered by a thin cuticle which is secreted by the underlying epidermis. The mouth is at the anterior end of the body guarded by three lips or oral papillae. The alimentary system is poorly developed with a mouth, pharynx, intestine, rectum and anus.

**Life cycle :** The male and the female worms come into sexual union after which the female worm lays about two lakhs (2,00,000) eggs per day. The eggs are passed out along with the faeces. The eggs which are freshly passed out are not infective to man. After a period of 16 to 20 days, a small larva develops inside the egg. The egg is now called embryonated egg. Only the embryonated eggs are infective to man.

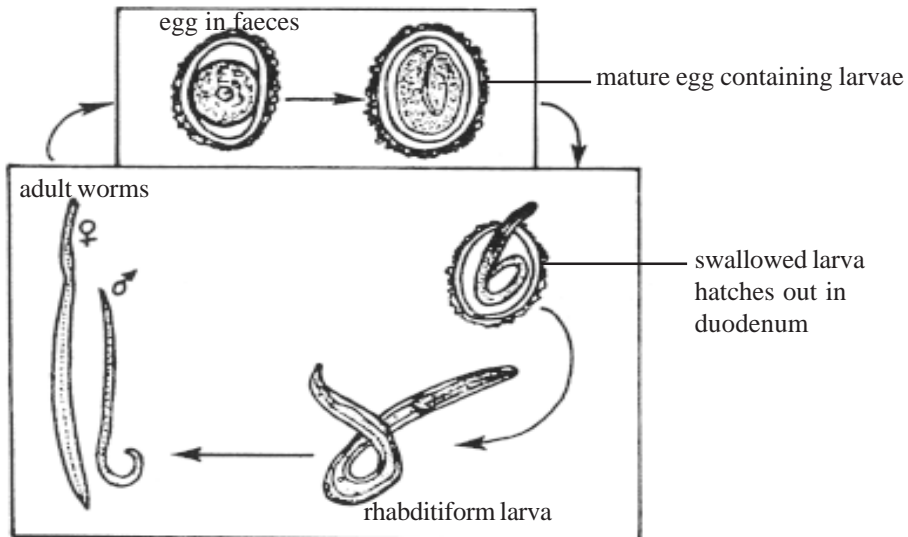

Fig. 2.9. Life cycle of *Ascaris lumbricoides*

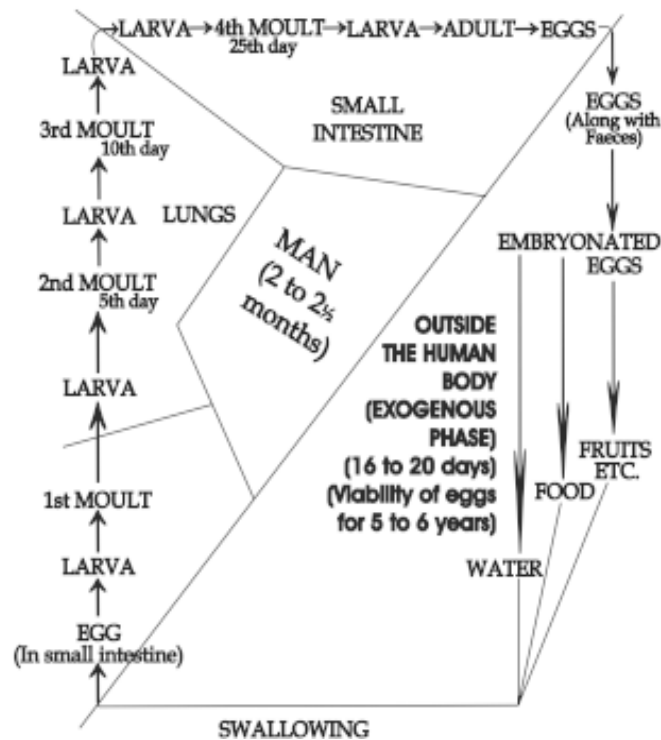

Fig. 2.10. Schematic representation of life cycle of *Ascaris lumbricoides*

The egg is broadly oval in shape with a thick shell. The shell is surrounded by another colourless albuminous layer. The eggs are highly resistant and are not affected by desiccation, freezing or by the usual strength of disinfectants. However, the eggs are killed in direct sunlight. The eggs of *Ascaris* can live for five to six years.

The eggs are found in water, food, on exposed sweets, fruits etc., since the eggs are carried away by wind. So they can easily settle down on sticky surfaces such as sweets, water melons, cut fruits etc.

Man gets infected by swallowing the embryonated eggs along with contaminated water and food. The infection is generally through ingestion. On reaching the small intestine, the egg hatches and a tiny larva measuring about 200µm to 300µm escapes out. This larva sheds its outer skin immediately. It is the first moult. Now it is called **rhabditi form** larva. The larva then penetrates the wall of the small intestine and reaches the blood stream. The larva is then carried to the right auricle and right ventricle and reaches the lungs ultimately. On the fifth day the larva sheds the outer skin which is the second moult. On the tenth day another moult takes place, the third moult. (Second and third moults take place in the lungs). Now the larva is about 1 to 3 mm. in length. The larva then goes through the bronchiole, the bronchus and reaches the trachea. Later, the larva is coughed out into the pharynx and from there it goes down the oesophagus and reaches the small intestine. On the 25th day the larva sheds its outer skin which is the fourth moult. After a period of two to two and a half months of infection, the adult stage is reached. The development outside the human body is termed as Exogenous phase.

**Pathogenicity :** Infection with this worm is called 'Ascariasis'. The common symptoms are loss of appetite, intestinal pain, abdominal discomfort with indigestion. It also causes disturbed sleep in children. Appendicitis may also be caused by the worms blocking the appendix. If a large number of adult worms are present, they may get twisted together and cause mechanical obstruction of the intestine. Such a blockage or obstruction may be fatal if not surgically removed.

**Control :**

1. Measures against indiscriminate defaecation.
2. Protection of water against contamination by embryonated eggs.
3. Proper disposal of night-soil
4. Covering of sweets and other edibles from getting contaminated by embryonated eggs.
5. Fruits, vegetables etc. should be washed before use.

**Pathogenicity of Microorganisms:**

Pathogenicity refers to the ability of microorganism to cause the disease in animals and humans. Infectious diseases more often result due to the interactions between the disease producing pathogenic microorganisms and host organisms.

**The Pathogenic adaptations**

The Pathogenicity of the microbes is due to several phenomena or adaptations.

1. Pathogens are able to selectively attach to the external surfaces such as the skin and conjunctiva or the internal surfaces such as the mucus membranes of the respiratory, gastrointestinal or urinogenital tracts.
2. They also penetrate the above body surfaces and gain access to the internal tissues.
3. In some infections, the pathogen may remain localized, growing near its point of entry into the body.
4. Some pathogens become widely distributed in different tissues or organs. This is called generalized infections.
5. Some other pathogens can grow within the cells of host, causing severe disturbances to normal physiological processes.
6. Yet another group, may grow extracellularly and bring damage to the body tissues by elaborating substances called toxins.

The pathogenicity differs in different strains of pathogenic species. Some strains are highly virulent. In the case of **virulent strains**, only a few bacterial cells may suffice to cause disease in a host. On the contrary, other strains may be less virulent, and large numbers of cells may be needed to cause the disease. Some strains may be **avirulent**, and are incapable of causing the disease even when large numbers of cells are inoculated into the host. Such avirulent strains are called attenuated strains. These are widely used as vaccines to elicit the immunity.

### **Antimicrobial Resistance:**

Pathogenic microbes are provided with their own mechanisms to establish infection in the host animals and humans. Similarly the host's body has a number of defense mechanisms to mount resistance against the invasion and to prevent infection of pathogens. The antimicrobial response of hosts may be natural, non-specific and specific.

Natural resistance includes species resistance, racial resistance and individual resistance.

### **Chemotherapy**

The control and treatment of infectious diseases with a chemical compound or drug is called **chemotherapy**. The chemical compounds and drugs are called chemotherapeutic agents.

A good chemotherapeutic agent possesses the following characteristics:

1. It destroys or prevents the activity of a disease causing pathogen, without injuring the host tissues
2. It is able to penetrate the cells and tissues of the host and can encounter the pathogens in effective but safe concentrations or dosage.
3. It leaves the host's natural defense or immune mechanisms such as phagocytosis or antibody production, unaffected.
4. It exhibits selective toxicity, that is it kills or inhibits the pathogenic microbes without having harmful effect or having least harm to the host.



## **Antibiotics and Chemotherapy:**

Antibiotics are special and unique type of chemotherapeutics agents obtained from living organisms such as bacteria or fungi. The word antibiotic refers to a metabolic product of one microorganism that in very small amounts is detrimental or inhibitory to other microorganisms. The first antibiotic that was discovered was Penicillin from the fungus, *Pencillium sp.* by Alexander Flemming in 1929. Since then hundreds of antibiotic substances have been isolated.

Antibiotics are of two types. 1. Broad spectrum antibiotics can destroy or inhibit many different species of pathogens. 2. Narrow spectrum antibiotics can destroy specifically some or few species of pathogens.

The mode of action of antibiotics may be either bactericidal or bacteriostatic. The former destroys the microbial cells while the latter inhibits the growth of them. Moreover, the antibiotics may inhibit cell wall synthesis or disrupt the cell wall or damage the cytoplasmic membrane or inhibit the protein synthesis and nucleic acid synthesis (purine and pyrimidines); inhibit the specific enzyme systems and also inhibit the metabolic pathway of pathogens through competitive inhibition of key enzymes.

Some notable antibiotics are Ampicillin, Streptomycin, Tetracyclin and Erythromycin etc. Some antifungal antibiotics are Griseofulvin and Imidazole etc. Some antiviral antibiotics are Amantidine and Cycloguanosine. The more promising chemotherapeutic agent for treating viral diseases is the Interferon. Interferons are glycoprotein molecules secreted by the leucocytes and fibroblasts. Some of the antitumour antibiotics are of the anthromycin group.

## **AIDS (HIV) and its control**

The disease Acquired Immuno Deficiency Syndrome (AIDS) was identified in the year 1981 (December). Early epidemiological studies have established that it is a communicable disease transmitted through sexual contact or through blood and blood products. In 1983 **Luc Montagnier** at

Pasteur Institute, Paris and **Gallo** at National Institute of Health (NIH) USA isolated the virus that caused AIDS. In 1986, the committee on taxonomy of virus coined the term HIV or Human Immunodeficiency Virus to avoid confusion due to different names being given by different researchers.

HIV is new member of the Lentivirinae subfamily of human retroviruses. Retroviruses are RNA viruses, which have the capacity to convert their RNA into DNA with the help of an enzyme called reverse transcriptase.

### Structure of HIV:

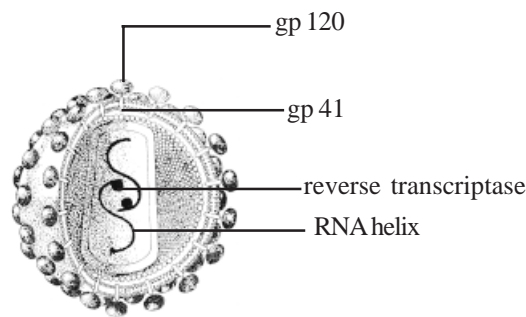

**Fig. 2.11. Structure of HIV**

HIV is spherical in shape. Its size is about 100-140 nm. Like any other virus, it is made up of a central icosahedral capsid core containing the genetic material surrounded by a protein envelope. The protein envelope is attached several spicules of glycoprotein, Like other retroviruses the glycoprotein sticks out on both sides (inside and outside) of its protein coat. The outer position of glycoprotein called gp120 is attached to the gp 41 situated on the inner side of the viral coat. gp 41 is an unusually long protein with over 100 amino acids. gp 120 appears like a knob. Electron microscopic studies have revealed that the distribution of proteins of the viral surface is very much like a soccer ball made of 12 pentagons and 20 hexagons, stitched together to make a sphere. The envelope of HIV also contains other proteins including some HLA antigens (Human Leucocyte Antigen).

The genome of HIV contains two helix of RNA molecules in folded form. The enzyme reverse transcriptase is attached to RNA.

### Pathogenesis:

HIV causes profound immunodepression in humans. It is due to the depletion of one type of WBC, which is involved in the formation of antibodies called CD<sub>4</sub> plus T-helper cells (lymphocytes). In addition other

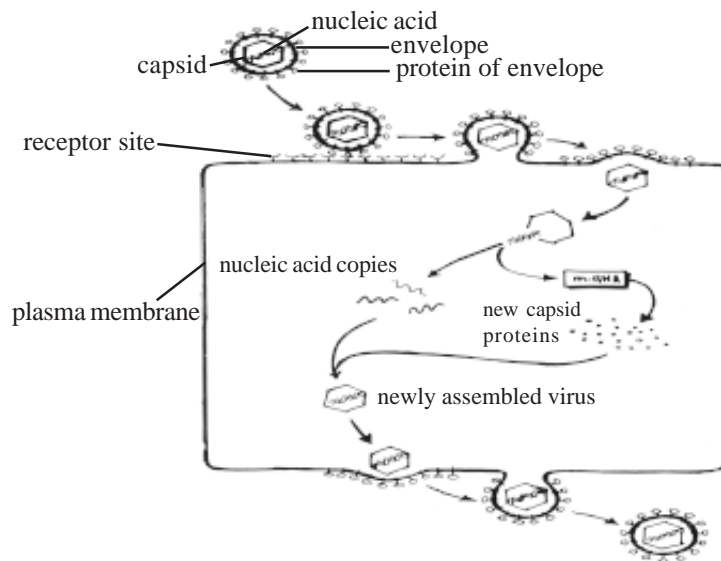

**Fig. 2.12. Viral multiplication**

cells such as B-lymphocytes and macrophages are destroyed by HIV infection. The infected macrophages serve as the reservoir of viruses and disseminate to all tissues in the body. HIV is found besides blood, in all body fluids such as semen, vaginal secretion, cervical secretion, breast milk, CSF, synovial fluid, pleural fluid, peritoneal fluid, pericardial fluid and amniotic fluid. HIV can even destroy the brain cells.

### Symptoms:

The following symptoms have been defined by WHO.

1. Weight loss at least 10% body weight
2. Chronic diarrhoea for more than a month
3. Prolonged fever for more than one month
4. Night sweats and persistent coughs

5. Opportunistic infections such as tuberculosis, oropharyngeal candidiasis (fungal infection in mouth and throat)
6. recurrent herpes zoster (viral) infection
7. Meningitis and nerve damage
8. Loss of memory and intelligence
9. An unusual cancer, kaposi sarcoma which produces scattered purplish lesions over the chest and abdomen.

**Diagnosis:**

ELISA test (Enzyme Linked Immuno Sorbent Assay) is a sensitive preliminary blood test used to detect HIV antibodies.

Western Blot is the confirmatory test, which is highly specific and based on specific antibodies to viral core proteins.

**Control and Management:**

1. Screening of blood and blood products.
2. Education to people about do's and don'ts in AIDS contraction and bringing more awareness among the public.
3. Education about protected sexual behaviour and practices
4. Participation of voluntary agencies, teachers, NGOs, paramedical workers, several other voluntary health organizations, in AIDS awareness programmes
5. Making the antiretroviral drugs such as AZTs (Azidothymidine/Zidovudin) and saquinovir etc., available to patients.

The management of HIV infection involves the above general measures, treatment of opportunistic infections and cancer, antiretroviral drugs, immunomodulators and supportive treatment and counselling.

### 3. IMMUNOLOGY

Animals and human beings are continually exposed to various infectious agents like bacteria, viruses, fungi and parasites. It has long been noticed that survivors of certain diseases, e.g., measles, are not attacked by the same disease again. Clearly, these people have become immune to the concerned disease. The system of animal body, which protects it from various infectious agents and cancer, is called **Immune system**. A study of the immune system is known as **Immunology**. This chapter introduces the fundamental concepts of immune system and their use for the improvement of human health and welfare.

The Latin term “**Immunis**”, meaning “**exempt**” or “**freedom**”, gave rise to the English word immunity. It refers to all the mechanisms used by the body for protection from environmental agents that are foreign to the body. These agents may be microorganisms or their products, certain food items, chemicals, drugs and pollen grains. Immunity is of two types : (a) innate, and (b) acquired immunity.

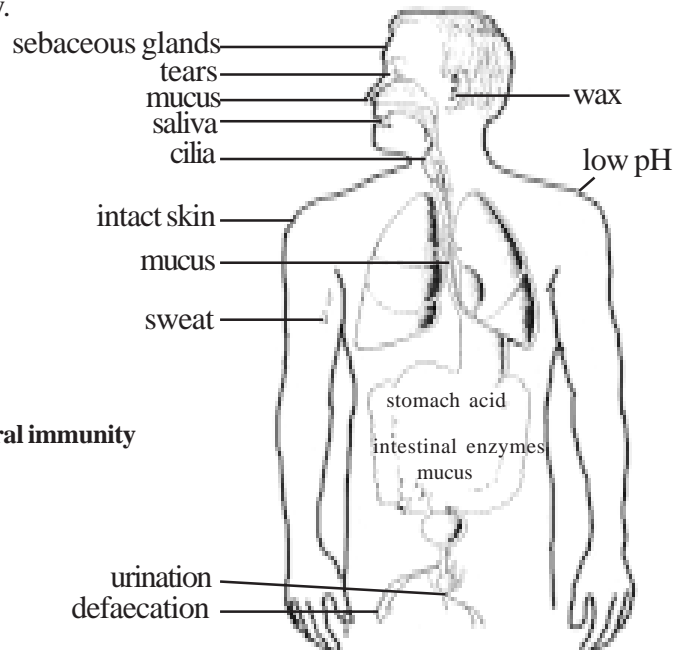
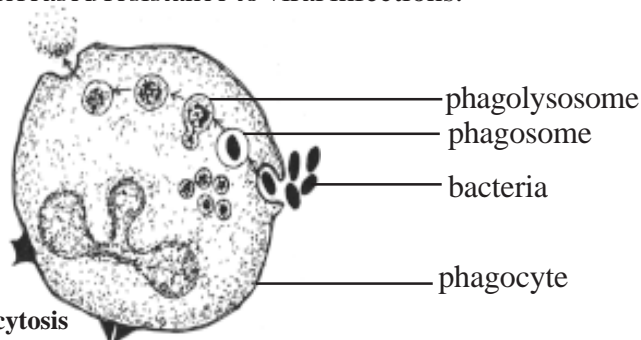

**Fig. 3.1. Natural immunity**

**A. Innate Immunity (Non-specific):** Innate immunity comprises all those natural defense mechanisms with which an organism is protected from infection. As a strategy, innate immunity consists of various types of barriers that prevent entry of foreign agents into the body. The pathogens that enter into the body, are quickly killed by some components of the immune system. This is the **first line of defence** in most animals. Innate immunity consists of the following four types of barriers.

**1. Anatomical Barriers :** These barriers block the entry of organisms into the body. The **skin** and the **mucous membrane** lining the respiratory and intestinal as well as the reproductive passages constitute the **barriers**. Mucous material entraps foreign microorganisms. The ciliary movements produced by the epithelial lining cells expel out micro-organisms from the body.

**2. Physiological Barriers :** Factors like body temperature, pH and various body secretions, prevent the growth of pathogenic micro-organisms. For example, fever response inhibits growth of many pathogens. Acidity of the stomach contents due to **HCl secretion** kills ingested micro-organisms. Lysozyme present in secretions, such as **tears** and **saliva**, digest bacterial cell walls. Certain cells, like WBC, when infected with a virus, respond by releasing anti viral proteins, called **interferons**. Interferons, in turn, make the cells in the vicinity resistant to viral infections. As a result, the concerned persons exhibit increased resistance to viral infections.



**Fig. 3.2. Phagocytosis**

**3. Phagocytic Barriers :** Phagocytosis is an important mechanism of innate immunity. It is performed by **leucocytes**. In response to pathogenic infections, the total count of leucocytes will increase sharply. Humans contain wandering phagocytes that circulate throughout the body. The most important phagocytes are the **macrophages** and the **neutrophils**. Macrophages are large irregular-shaped cells that engulf microbes, viruses and cellular debris. In response to an infection, monocytes are liberated at

the site of infection. These monocytes get converted into macrophages. These cells are provided with **bacteriolytic enzymes** and **free radicals**, which destroy the pathogens.

**4. Inflammatory Barriers :** Usually an infection or tissue injury results in redness and swelling, along with pain and production of heat that may result in fever. The above phenomenon is known as **inflammatory response**. This response occurs due to release of chemical alarm signals, notably **histamine, serotonin** and **prostaglandins**, by the **damaged mast cells**. At the site of inflammation there may be leakage of vascular fluid, which contains serum proteins with antibacterial activity. Further, there is an **influx of phagocytic cells into the affected area**. These responses inhibit and destroy the invading microorganisms.

Besides the phagocytes, **natural killer cells** (NK cells) (T Lymphocytes) kill virus-infected cells and some tumour cells of the body by creating perforin-lined pores in the plasma membrane of the target cells. These pores allow entry of water into the target cell, which then swells and bursts.

#### **Acquired Immunity (Specific immunity)**

Acquired immunity, also known as adaptive or specific immunity, is capable of recognizing and selectively eliminating specific microorganisms. Acquired immunity is found only in vertebrates. It supplements the protection provided by innate/natural immunity. It is generated in response to an exposure or encounter to the microorganisms in question. Specific defence mechanisms require several days to be activated, following the failure of non-specific defence mechanisms. Adaptive immunity has the following unique features.

(i) **Specificity :** It is the ability to distinguish differences among various foreign molecules.

(ii) **Diversity :** It can recognize a vast variety of foreign molecules.

(iii) **Discrimination between Self and Non-self :** It is able to recognize and respond to molecules that are foreign (non-self) to the body. At the same time, it can avoid response to those molecules that are present within the body (self antigens) of the given animal.

(iv) **Memory** : When the immune system encounters a specific foreign agent, e.g., microbe, for the first time, it generates an immune response and eliminates the invader. The immune system retains the memory of this encounter for a prolonged interval. As a result, a second encounter with the same microbe evokes a heightened immune response.

Specific immunity employs two major groups of cells : (a) lymphocytes, and (b) antigen presenting cells. A healthy individual possesses about a trillion of lymphocytes. The lymphocytes are of two types viz., **T- lymphocytes** or **T-cells** and **B - lymphocytes** or **B - cells**. Both the types of lymphocytes, as well as the other cells of the immune response, are produced in bone marrow. The process of their production is called haematopoiesis. Some immature lymphocytes, destined to become thymocytes, migrate via blood to the thymus, where they mature and differentiate as T - cells. The B- cells, on the other hand, mature in the bone marrow itself. The B and T cells, together, generate two types of specific immunity, viz., (a) **cell-mediated** and (b) **antibody-mediated** or **humoral immunity** respectively.

#### **(a) Cell-mediated Immunity (CMI)**

Cell-mediated immunity is the responsibility of a subgroup of T cells, called cytotoxic T lymphocytes (CTLs). An activated cytotoxic lymphocyte is specific to a target cell, which has been infected, and kill the target cell by a variety of mechanisms. This prevents the completion of life cycle of the pathogen and its growth, since it depends on an intact host cell to do that. Cell-mediated immunity is also involved in killing of cancer cells.

#### **(b) Antibody-mediated Immunity / Humoral Immunity**

Antibody mediated or humoral immunity involves the synthesis of specific antibody molecules called immunoglobulins by the B-lymphocytes. Each antigen has many different **antigenic determinants**, each of which matches a specific antibody and binds to it. The B cells, direct the antibody-mediated immunity. The antibody molecules (Igs) may be bound to a cell membrane in the form of receptors or they may remain free. The free **antibodies have three main functions** viz., 1. agglutination of particulate matter, including bacteria and viruses, 2. opsonisation or coating over bacteria to facilitate recognition and phagocytosis by the phagocytes and 3. neutralization of toxins released by bacteria.



Adaptive immunity may be **active** or **passive**. **Active immunity** is due to the immune response generated in the individual in question by a **pathogen** or **vaccine**, whereas **passive immunity** is conferred by transfer of immune products, like **antibodies**, etc., from an individual into a non-immune individual.

### **Activation of Adaptive Immunity**

Every antigen is processed by **antigen presenting cells (APC)**, like macrophages, B lymphocytes and dendritic cells. The processed antigen is presented on the surface of these cells. A subgroup of T cells called **T helper cells**, specifically interacts with the presented antigen and becomes activated. The activated T helper cells then activate B cells, and a subgroup of T cells called cytotoxic lymphocytes (CTLs), in a specific manner. The activated B and cytotoxic lymphocytes proliferate to produce clones. All the cells of a clone can recognize the same antigen and eliminate it.

### **LYMPHOIDAL ORGANS**

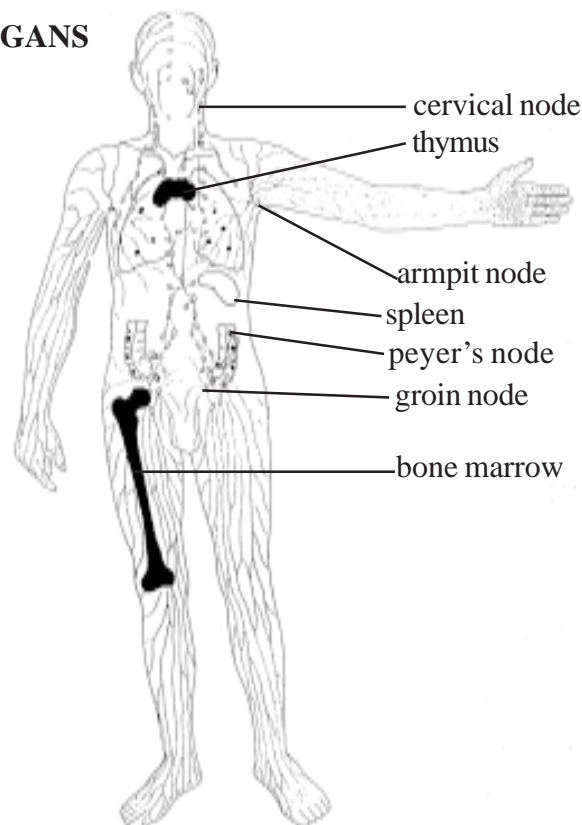

**Fig. 3.3. Various Lymphoid organs of Human**

## Structure and Functions of the Immune System

The lymphoid system consists of the **lymphoid cells** (lymphocytes and plasma cells) and **lymphoid organs**. Based on different roles they perform, lymphoid organs can be classified into **central (primary)** and **peripheral (secondary) lymphoid organs**. The central lymphoid organs are lymphoepithelial structures in which the precursor lymphocytes proliferate, develop and acquire immunological capability. In mammals, the bone marrow, the thymus and the **bursa of fabricius** in birds represent primary lymphoid organs. After acquiring immunocompetence, the lymphocytes migrate along blood and lymph streams, accumulate in the peripheral lymphoid organs and, following antigenic stimulus, effect the appropriate immune response. The **spleen, lymph nodes** and **mucosa – associated lymphoid tissue (MALT)** constitute the major peripheral or **secondary lymphoid organs**. Lymphoidal tissues in the gut (peyer's patches), appendix, tonsils, salivary glands, tear glands and also the secretion (colostrums) of the lactating breast of the mother also are included in the immune system.

### I. Primary Lymphoid Organ

#### Thymus :

The thymus develops at about the sixth week of gestation. By eighth week, it grows into a compact epithelial structure. Mesenchymal stem cells (precursors of lymphocytes) from the yolk sac, foetal liver and bone marrow reach the thymus and differentiate into the thymic lymphoid cells (thymocytes).



Fig. 3.4. Thymus entire

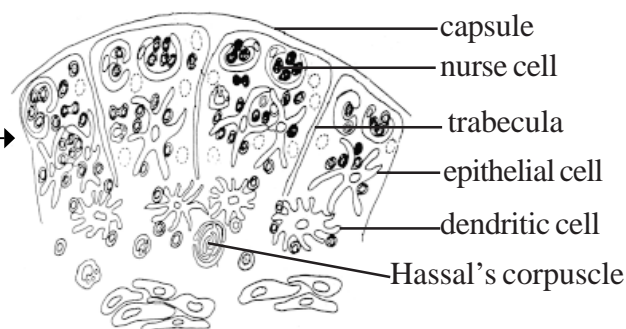

Fig. 3.5. Thymus C.S

The thymus acquires its characteristic lymphoid appearance by the third month of gestation. It is thus the first organ in all animal species to

become predominantly lymphoid. In human beings, the thymus reaches its maximal size just prior to birth. Thymus continues to grow till about the 12<sup>th</sup> year. After puberty, it undergoes spontaneous progressive involution, indicating that it functions best only in early life.

The thymus is located just behind the upper part of the heart. It has two lobes surrounded by a **fibrous capsule**. Septa arising from the capsule divide the gland into **lobules** which are differentiated into an outer cortex and an **inner medulla**. The cortex is crowded with actively proliferating small lymphocytes. The medulla consists mainly of epithelial cells and mature lymphocytes amidst which are the Hassall's corpuscles, which are whorl-like aggregations of epithelial cells.

The thymus was considered as an organ without any recognized function. But its role in the development of cell mediated immunity has been found recently. The primary function of the thymus is the production of thymic lymphocytes (T cells). It is the major site for T lymphocyte proliferation in the body. However, of the lymphocytes produced, only about one per cent leave the thymus. The rest are destroyed locally by programmed cell death or apoptosis. In the thymus, the lymphocytes acquire new surface antigens (Thy antigens). Lymphocytes produced in the thymus are called 'thymus (T) dependent lymphocytes' or 'T cells'. Unlike, lymphocyte proliferation in the peripheral organs, the function of thymus is independent of antigenic stimulation.

The thymus confers immunological competence on the lymphocytes during their stay in the organ. Prethymic lymphocytes are not immunocompetent. In the thymus they are 'educated' so that they become capable of mounting cell mediated immune response against appropriate antigens. This is effected by hormone-like factors produced by the thymus such as **thymulin, thymosin and thymopoietin**. The importance of thymus in lymphocyte proliferation and development of CMI is evident from the effects of lymphopenia, and in neonatally thymectomised mice.

T lymphocytes are selectively seeded into certain sites in the peripheral lymphatic tissues. These are found in the white pulp of the spleen, around the periarteriole region, and in the paracortical areas of lymph nodes.

## II. Peripheral Lymphoid Organs

### A. Lymph nodes :

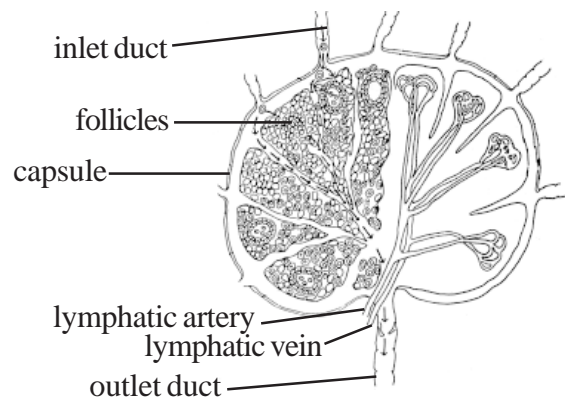

**Fig. 3.6. Lymph node - C.S**

The lymph nodes are small, round or ovoid bodies placed along the course of lymphatic vessels. They are surrounded by a fibrous capsule from which trabeculae penetrate into the nodes. The node can be differentiated into an **outer cortex** and an **inner medulla**. In the cortex are accumulations of lymphocytes (primary follicles) within which germinal centers (secondary follicles) develop during antigenic stimulation. The follicles contain, besides proliferating lymphocytes, dendritic macrophages which capture and process the antigen. In the medulla, the lymphocytes are arranged as elongated branching bands (medullary cords). The cortical follicles and medullary cords contain B lymphocytes and constitute the bursa or bone marrow dependent areas. Between the cortical follicles and medullary cords, there is a broad, intermediate zone called paracortical area which contains T lymphocytes and constitutes the thymus dependent area.

Lymph nodes act as a filter for the lymph. Each group of nodes drain a specific part of the body. They phagocytose foreign materials including microorganisms. They help the proliferation and circulation of T and B cells. They enlarge following local antigenic stimulation. In the human body, totally about 600 lymph nodes are distributed.

## **B. Spleen :**

It is the largest lymphoid organ. It contains red and white pulp regions that serve as filters. The macrophages within the spleen help to remove and destroy pathogens.

### **Functions of Spleen :**

1. The spleen serves as the graveyard for effete(aged) red blood cells, 2. It acts as a reserve tank and setting bed for blood and 3. It acts as a systemic filter for trapping circulating blood borne foreign particles. (The immunological function of the spleen is primarily directed against blood borne antigens).

## **III. Secondary Lymphoid Organs**

### **Mucosa associated lymphoid tissues (MALT) :**

The mucosa lining the alimentary, respiratory, genitourinary and other lumina and surfaces are constantly exposed to numerous antigens. These areas are endowed with a rich collection of lymphoid cells, either specialized aggregates as the **Peyer's patches** or **Scattered isolated lymphoid follicles** – collectively called the **Mucosa associated lymphoid tissues (MALT)**. Such lymphoid tissues in the gut are called **Gut associated lymphoid tissue (GALT)** and those in the respiratory tract are called **Bronchus associated lymphoid tissue (BALT)**. MALT contains lymphoid cells as well as phagocytic cells. Both B and T cells are present. The mucosa is endowed with secretory IgA. The mucosal regions afford/confer protection from many enteric and respiratory infections.

### **Antigens**

The terms immunogen and antigen are often used synonymously. However, these terms imply two closely related entities. The first describes a molecule that provokes an immune response(immunogenicity) and hence is called an immunogen. The other describes a molecule which reacts with the antibody produced, or with the activated cellular constituents of cell mediated immunity(antigenicity), and is referred to as an **antigen**.

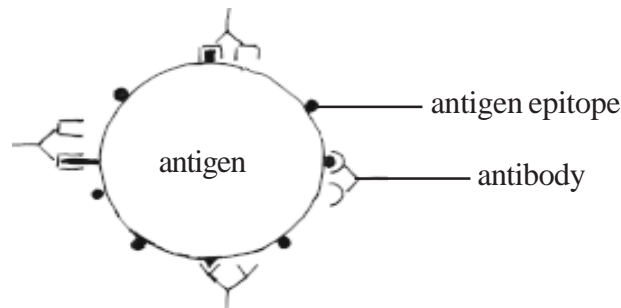

**Fig. 3.7. Antigen - Antibody binding**

In contrast to this is the hapten. Haptens are small well defined chemical groups such as dinitrophenol (DNP) which are not immunogenic on their own but will react with preformed antibodies. To make a hapten immunogenic, it must be linked to a carrier molecule which is itself immunogenic.

Antigens are recognized not only by antibodies, but also by antigen specific T cell receptors. In contrast to immunoglobulins, which usually recognize intact antigens, T cell surface receptors recognize processed antigens on the surface of antigen presenting cells.

### **Antigenic determinants and epitopes**

The part of the antibody molecule which makes contact with the antigen is termed the **paratope**. Consequently, the part of the antigen molecule that makes contact with the paratope is called the **epitope**. As most antigens are protein in nature, they exist in a folded, three dimensional, tertiary structure. Hence there may be a cluster of amino acid sequences on the three dimensional structure constituting a series of epitopes. Each of these epitope clusters on the antigen are known as an antigenic determinant.

Generally the substances, which are capable of eliciting an immune response, that is, the synthesis of antibodies are called antigens. However the above definition of antigens do not infer the cell mediated response. Hence the term immunogen is introduced to denote antigenic substances which elicit both humoral and cell mediated immune response or either humoral or cell mediated response.

Antigens may be either natural or artificial/synthetic ones. Natural antigens, fall into two categories viz., particulate antigens and soluble antigens. Bacteria, viruses, erythrocytes and cells represent particulate type antigens. Bacterial toxins, proteins, carbohydrates, glycoproteins and lipoproteins represent the soluble antigens.

In addition, a variety of chemical compounds, biological macromolecules, synthetic polypeptides are regarded as potential antigens. Several polysaccharides, nucleoproteins and lipoproteins are also considered as antigens. Recently antibodies to DNA have been used in immunization.

### Antibodies - Immunoglobulins

Immunoglobulins (Igs) are **glycoproteins**. Each molecule of Ig consists of two pairs of polypeptide chains of different sizes. The smaller chains are called '**light**' (L) chains and the larger ones are called '**heavy**' (H) chains. The L chain has a molecular weight of approximately 25,000 and the H chains is of 50,000. The L chain is attached to the H chain by a **disulphide bond**. The two H chains are also joined together by **S-S bonds**, depending on the class of immunoglobulins. The H chains are structurally and antigenically distinct for each class and are designated by the Greek letter corresponding to the immunoglobulin class, as follows :

IgG (Gamma) IgA (alpha) IgM(mu) Igd (delta) and IgE (epsilon)

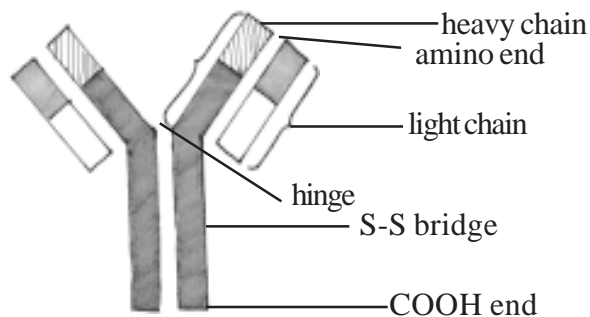

Fig. 3.8. Immunoglobulin (IgG)

The L chains are similar in all classes of immunoglobulins. They occur in two varieties, **kappa** (k) and **lambda** ( $\lambda$ ). A molecule of immunoglobulin may have either kappa or lambda chains, but never both.

### **Region of polypeptide chains :**

Each heavy and light chains consists of two regions viz.,

1. **The variable (V) region or Fab region:** The V region shows a wide variation in amino acid sequences in the amino or N-terminal portion of the molecule. These areas of high variability in the variable region of H and L chains are called '**hotspots**' or hypervariable regions. These hotspots are most intimately involved in the information of the antigen-binding site. In both VH and VL regions of the chain atleast three hypervariable regions/hotspots are present. The infinite range of the antibody specificity of immunoglobins depends on the variability of the amino acid sequences at the 'variable regions' of the H and L chains, which form the antigen combining sites (Paratope).

2. **Constant (c) region (or) Fc region (Fc = fragment of constant region) :** The C region denotes constant region with unvarying amino acid sequence in the C or COOH terminal portion of the molecule.

(Fab – Fragment of antigen binding site

Fc – Fragment of constant region)

Depending on the observable reaction produced on mixing with antigens, the antibodies are designated variously as **agglutinins**, **precipitins** and so on. Sera having high antibody levels following infection or immunization are called **immune sera** or **anti sera**.

### **Transplantation immunology**

The replacement of a diseased organ by a transplant (healthy tissue or organ) is called **transplantation**. In the early 1940 Medawar explained the nature of graft (transplant) rejection while working with the burn patients of World War II. In his observations the following features were made clear. 1. graft of skin from one region of the body to another in the same patient was easily accepted, 2. grafts obtained from close relatives like brother or sister, were rejected 3. when a second graft was performed, by obtaining the tissue from the same donor, the rejection reaction occurred with greater intensity and speed. The graft or transplant leads to various complications in the host body. They are mediated by the host's immune response. Very often



the transplant gets rejected or may lead to graft versus host reaction or disease. Before discussing the nature and implications of this rejection phenomenon let us look into the terms involved in various types of grafts.

**Classification of grafts :** The graft can be classified into four major types.

**1. Autograft :** The tissue of the original donor is grafted back into the same donor. For example, skin graft from thigh to face in severely deformed case of burnt individuals (plastic surgery).

**2. Isograft :** Graft between syngeneic individuals (ie., identical genetic constitution). For example, clones or identical twins.

**3. Allograft :** (Homograft). Graft between allogenic individuals (ie., members of the same species but of different genetic constitution. For example, kidney transplanted from one human to another.

**4. Xenograft :** (Heterograft). Graft between xenogenic individuals (ie., different genetic lineage). For example organ transplanted from pig to human, baboon to human.

**Genetic basis of organ transplants :**

Success of organ transplants (ie., Cornea, Kidney, Heart, Liver, Bone marrow) and skin grafts depends on a proper matching of histocompatibility antigens that occur in all cells of the body. Chromosome 6 of mouse contains a cluster of genes known as the **major histocompatibility complex (MHC)**, which in humans is called **human leukocyte antigen (HLA)** complex. The alleles of HLA genes determine the histocompatibility ie., the compatibility between donor and recipient tissues in transplants.

**Process of graft rejection :** (Allograft)

When the graft or tissue involves two genetically distinct members of the same species, graft rejection occurs because the antigens of the graft and host being different, the immune response of the host rejects the graft. The graft dies, decays and is eliminated from the host. The host also reacts to the graft and shows the following symptoms. 1. Skin rashes, 2. Fluid accumulation in spleen and enlargement (Splenomegaly), 3. Emaciation (becoming thin), 4. Diarrhoea, 5. hepatomegaly, 6. Anaemia and general immune

suppression, 7. Damage in bile ducts, 8. Increased bilirubin synthesis etc. Both cell mediated and humoral immune responses follow in rejection. Sensitized T cells (lymphocytes), macrophages, plasma cells are all involved in the primary or first set rejection. In the secondary or second set reaction, B cells (B lymphocytes) and their antibodies are involved. In the cell mediated reaction substances such as interleukin 1 (IL-1), Interleukin – 2 (IL-2) etc take part. The final lysis of the graft is achieved by lymphotoxins or TNF (Tumour necrosis factors) or proteolytic enzymes.

In clinical fields, graft rejection is prevented by : 1. Blood groups estimation (ABO and Rh) in the host, 2. Testing the presence of cytotoxic antibodies in the host serum, 3. Cross matching of tissues (Host Vs graft) prior to transplantation, 4. Giving immunosuppressive drugs like cyclosporin and steroids etc to the host, 5. Total lymphoid tissue irradiation etc.

In recent years, the cloning technology promises to bring solution to the problems of graft or tissue rejection in transplantation surgery. By stem cell technology and cloning of cells, organ culture is feasible. Organs cultured from the same embryo or individual are safe and valuable for transplantation surgery.

### **Immune system disorders**

The immune system is a multicomponent interactive system. It effectively protects the host from various infections. But an improper functioning of the immune system can cause discomfort, disease or even death. The improper functions fall into the following major groups : (1) hypersensitivity or allergy, (2) auto-immune diseases, and (3) immunodeficiency.

#### **(1) Hypersensitivity**

Allergies result from an inappropriate and excessive immune response to common antigens. Substances that cause allergies are called allergens ; they include dust, moulds, pollen, certain foods, and some medicines (such as penicillin). Allergy involves mainly IgE antibodies and histamine. Mast cells secrete the histamine. A common manifestation of allergy is asthma. Sometimes an allergen may cause a sudden, violent and fatal reaction in a sensitive individual ; this is called anaphylaxis.

## **(2) Autoimmune diseases**

Autoimmune diseases result when the immune system attacks and destroys “self” cells and molecules. This condition can cause chronic and serious diseases. Examples of autoimmune diseases are insulin-dependent diabetes, multiple sclerosis, rheumatoid arthritis, etc. Multiple sclerosis is caused by antibodies that attack the myelin sheath of nerve cells.

## **(3) Immunodeficiency diseases**

Immunodeficiency Diseases result from a defect in one or more components of the innate or adaptive immunity. Affected individuals are susceptible to diseases that normally would not bother most people. Immunodeficiency may result from gene mutations, infections, malnutrition or accidents. 1. Severe combined immunodeficiency (SCID) results from one of many genetic defects; one such genetic defect leads to adenosine deaminase deficiency. SCID is characterized by a very low number of circulating thymocytes. Affected individuals usually die at an early age. 2. AIDS (Acquired Immuno Deficiency Syndrome) is another example for immunodeficiency disease. It is caused by a retrovirus, known as human immunodeficiency virus (HIV). Retroviruses have RNA genomes that are replicated via DNA copies. HIV, selectively infects and kills T-helper cells. The depletion of T-helper cells weakens the acquired immune response and may even abolish it completely. The viral RNA genome is converted into DNA copy by the viral enzyme reverse transcriptase. The DNA copy of HIV becomes inserted into the human chromosome and replicates with the cell DNA. It may be transcribed to produce RNA copies of the viral genome. The RNA copies are packaged and liberated as virus particles. The infected cell is lysed in this process, and the released virus particles infect new T-helper cells.

## 4. MODERN GENETICS

### Introduction and Scope

Genetics deals with various concepts and phenomena related to inheritance. Mendel's findings sowed the seeds for understanding the secrets of heredity and paved the way for further knowledge on genes and chromosomes. The post Mendelian period was remarkable in that many new concepts and hypotheses related to general genetics such as factor (gene) interactions, sex determination, linkage, sex linkage, crossing over, cytoplasmic inheritance, multiple allelism polygenic inheritance were added. The discovery of double helical DNA by Watson and Crick in 1953 has unraveled the secrets of gene functions. The voluminous works on *Drosophila* and prokaryotes like *Escherichia coli* opened up a new era of modern (molecular) genetics. In modern genetics, human genetics constitutes a part. It attempts to bring informations most important for understanding the genetics of man who is also a species like any other taxonomic species. Human genetics involves the identification of human chromosomes; genetic engineering prospects; genetic diseases and gene therapy; cloning devices; transgenic or genetically modified organisms etc. Towards this line, the modern genetics also deals with the human genome project; bioinformatics / biological data base and proteomics.

### Human Genetics - Karyotyping.

Karyotyping is a technique through which the complete set of chromosomes are separated from a cell and the chromosomes are lined up in a **karyogram**. The term karyogram has now been replaced by another word called **Idiogram** referring to a diagrammatic representation of chromosomes.

The karyological studies are usually made during mitosis, though the chromosome structure and details can also be best done in meiotic preparations. It is much easier to obtain and prepare suitable mitotic cells. Mitosis also reveals the replicated chromosomes viz., sister chromatids.

The diploid set of chromosomes in the eukaryotic cells has constant morphological (phenotypic) features such as number, size, shape. The chromosomes are identified by other features such as the secondary constriction, arm ratio, and banding pattern. The summation of all such characters, which identify a set of chromosomes is called **karyotyping**.

Karyotyping involves the culture of foetal cells found in the amniotic fluid, in vitro, in a highly nutritive solution containing phytohaemagglutinin. The foetal cells are cultured with colchicine. Colchicine stops mitosis at metaphase. When these cells are subjected to a hypotonic solution, the cells swell because the soluble salts are of lower concentration than in normal protoplasm. The water diffuses into the cell and separates the chromosomes. The scattered chromosomes are then placed on a slide, stained and photographed under a microscope. Individual chromosomes are then cut off from the photograph and marked as homologous pairs to form an idiogram.

**Karyotyping of Human chromosomes :**

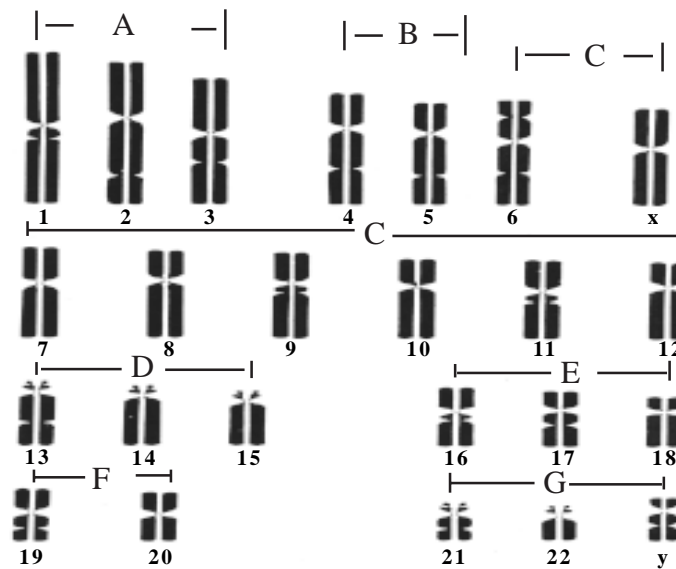

**Fig. 4.1. Karyotyping of human chromosomes - pairs of chromosomes during metaphase**

The 23 pairs of chromosomes in human are classified into seven groups viz, A-G based on position of centromere.

**Group A :** This group includes the largest chromosomes 1,2 and 3. These are **metacentric** with centromere found in center with two equal arms.

**Group B :** This group represents chromosomes 4 and 5 which are **submetacentric** with two unequal arms.

**Group C :** This is the largest group containing chromosomes 6,7,8,9,10,11,12 and X. These are of medium size and submetacentric. The X chromosome resembles the chromosome 6 in this group.

**Group D :** These are medium sized chromosomes with nearly (acrocentric) terminal centromeres. The chromosomes 13,14 and 15 are kept in this group.

**Group E :** It consists of chromosomes 16,17 and 18. They are shorter and meta or submetacentric.

**Group F :** Shorter metacentric chromosomes 19 and 20 represent this group.

**Group G :** This group comprises the very short **acrocentric** chromosomes 21, 22 and Y belong to this category.

**Uses :**

1. Karyotyping helps to identify the sex of individuals through amniocentesis.
2. Genetic diseases in human beings can be detected by this technique. If a disease is detected, the medical counselling for termination of pregnancy and abortion of such foetus can be done.
3. By characterizing the normal karyotype, the chromosomal abnormalities such as deletion, duplication, translocation, non-disjunctions and the consequent aneuploids could be detected.

### **Genetic Engineering (Recombinant DNA Technology)**

All living organisms are endowed with specific genetic information. With advancement that progressed in genetical science, many

aspects of gene functions became obvious. The molecular functioning of genes revealed the central dogma that DNA in a eukaryotic cell undergoes transcription to synthesize RNA and the latter undergoes translation to produce protein (polypeptide). Even before the modern aspects of molecular genetics are discovered, the existence of mobile genetic elements (Transposons) were visualized by the geneticist Barbara McClintock in her work on maize plant *Zea mays* in 1965.

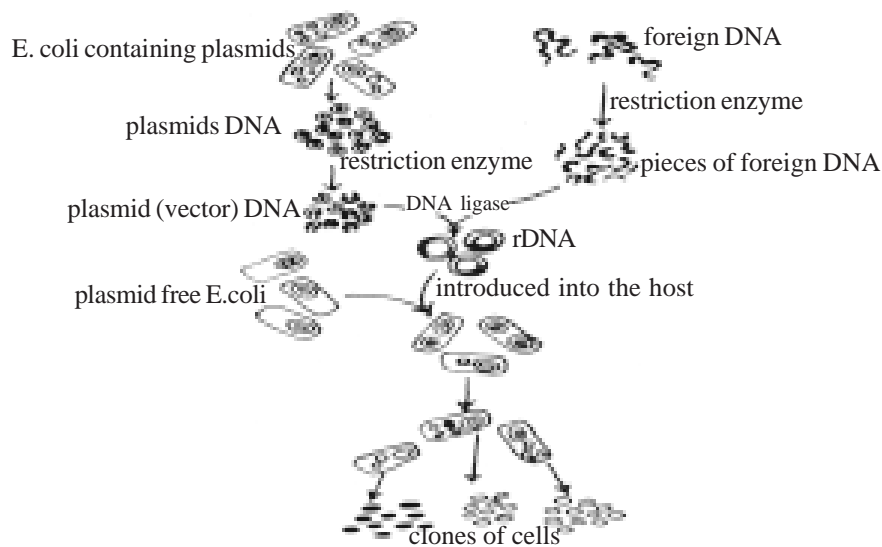

**Fig. 4.2. Genetic engineering - Recombinant DNA technology**

Genetic engineering deals with the manipulation of genes according to human will. A gene of known function can be transferred from its normal location into an entirely different cell or organism, via a suitable carrier or vector. The carrier may be a plasmid DNA segment of a bacterium or a virus. The gene transferred likewise starts functioning to synthesize the particular protein in the new environment. Thus, the fact that, a gene can function irrespective of its environment formed the basis for genetic engineering.

### **Tools of Genetic Engineering :**

Genetic engineering which involves isolation of a gene segment from the whole genome, cloning of the gene into multiple copies and their expression needs several biological tools. Some of them are given below.

1. Enzymes : a. Exonucleases, b. endonucleases, c. restriction endonucleases, d. SI enzymes to convert the cohesive ends of single stranded DNA fragments into blunt ends, e. DNA ligases, f. Alkaline phosphatase, g. Reverse transcriptase, h. DNA polymerase etc.

2. Foreign DNA / Passenger DNA : It is a fragment of DNA molecule, which is to be enzymatically isolated and cloned.

3. Cloning vectors : Vectors or vehicle DNA are those DNA that can carry a foreign DNA fragment when inserted into it. The vectors generally used are bacterial plasmids and bacteriophages.

### **Plasmids :**

A plasmid is a circular DNA with about 200-300 nucleotides. It is present in bacterial cells alongside their main chromosomes. A plasmid sometimes can leave from one bacterial cell and enter another, through conjugation and thereby transfer genetic traits to the recipient cell. The plasmid DNA inside a bacterium can replicate independently of the main DNA and can depart from main genome dragging a piece of main DNA along with it. It is called the bacterial DNA. A plasmid can sometimes fuse with the main DNA. Thus the plasmid seems to be an efficient gene exchanging vehicle which the nature has produced.

### **Isolation of gene**

In recombinant DNA technology, restriction endonucleases cut the DNA double helix in very precise manner. They recognize specific base sequences on DNA. They cut each strand of DNA at a given place. These enzymes recognize specific DNA sequences which are called palindrome sequences. A palindrome refers to a base sequence that read the same on the two strands but in opposite directions. For example if the base sequence on one strand in GAATTC read in 5'-3' direction, the sequence on the opposite (complementary) strand is CTTAAG read in 3'-5' direction. There is a point of symmetry within the palindrome. In the example given this point is in the center between the AT/TA.

5' GAATTC 3'  
3' CTTAAG 5'



### **Examples of Restriction enzymes :-**

The restriction enzymes cut the DNA molecule around the point of symmetry. The above palindrome sequence is recognized by the restriction enzyme derived from *Escherichia coli*, called EcoR1. It cuts the DNA molecule into discrete fragment with staggered cut ends.

### **Recombinant DNA :-**

The foreign DNA fragment isolated is made to recombine with the plasmid DNA which is cleaved by the same restriction endonuclease. The recombination of the two DNAs is effected by the DNA ligase enzyme. The product formed is called recombinant plasmid or recombinant DNA.

### **Molecular cloning :-**

The recombinant DNA must be introduced into a host cell, within which it may replicate freely. *Escherichia coli* has been employed as a suitable host to the above. Alongside, with the multiplication and growth of the bacterium in the medium, copies of rDNA are also produced. In molecular cloning, besides *E. coli* other microbes that have been employed include *Bacillus subtilis*, *Streptomyces sp.*, *Saccharomyces cerevisiae* etc.

When the rDNA copies are introduced into the host cells, (*E. coli*) a few thousand of rDNA pieces may enter the cells. These cells are called transformed cells. Each transformed cell grows a colony of its own in which every member is genetically alike. These colonies are then distinguished and recultured separately.

From the recultured colonies, the recombinant DNA is extracted from lysed cells, purified and used. The first gene was cloned in 1973 by Hebert Bayer and Stanley Cohen of Stanford University, California of USA.

### **Application and Uses of Recombinant DNA Technology**

1. Genetic engineering/recombinant DNA technology has enabled the understanding of structure of eukaryotic genes and their components.
2. Genetically engineered bacteria are employed to synthesize certain vital life saving drugs, hormones and antibiotics eg., Antiviral / anticancer interferons ; human growth hormone (HGH) somatostatin, etc.

3. Through recombinant DNA technology, the gene types of plants are altered. New transgenic plants which are resistant to diseases and pest attack have been produced.

4. Genetic defects in animals as well as human could be corrected through gene therapy.

5. Genetically engineered bacteria are called **superbugs**. Superbugs can degrade several aromatic hydrocarbons, at the same time. They are employed in clearing oil spills in the ocean. Thus these are used in pollution abatement. The super bug was produced first by an Indian researcher Anand Chakrabarty in USA. He developed a strain of Pseudomona bacterium to clear up oil spills. The above superbug can destroy octanes, xylenes camphors and toluenes.

#### **DNA - Segmenting / Fragmenting**

DNA segmenting in genetic engineering refers to fragmenting of DNA and sequencing or mapping the DNA in terms of its nucleotide sequences. Chemical and enzymatic methods are available for the above. As a result the genic and non-compartments of DNA can be identified.

In human beings, more than three hundred hereditary diseases have been identified. All these diseases have genetic background. Gene mutations, chromosomal aberrations are the attributed reasons for the manifestation of such genetic diseases in man. Most of them are congenital in nature.

**Pedigree analysis** : Unlike animals, controlled crosses can not be made in human beings. Hence human geneticists, resort to a scrutiny of established matings. The scrutiny of established matings to obtain information about the genetic characters / traits is called **pedigree analysis**.

**Pedigree chart** : Pedigree chart defines the history of a character in a family. It is drawn up using certain standard symbols. It is also called as the **Family tree**. Pedigree chart helps to identify and visualize the course of genetic diseases in the progeny. This is especially true of diseases such as fibrosis and phenylketonuria (PKU).

## Symbols commonly used in Pedigree Charts

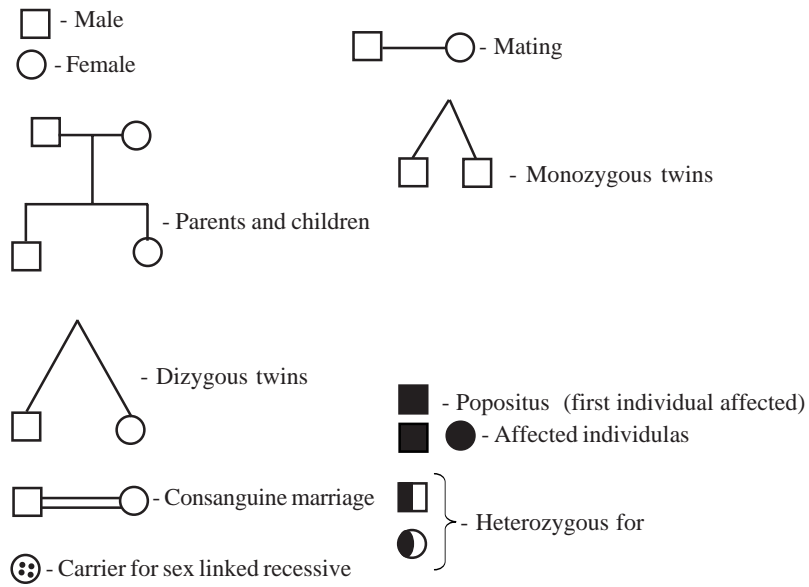

Fig. 4.3. Symbols for pedigree chart

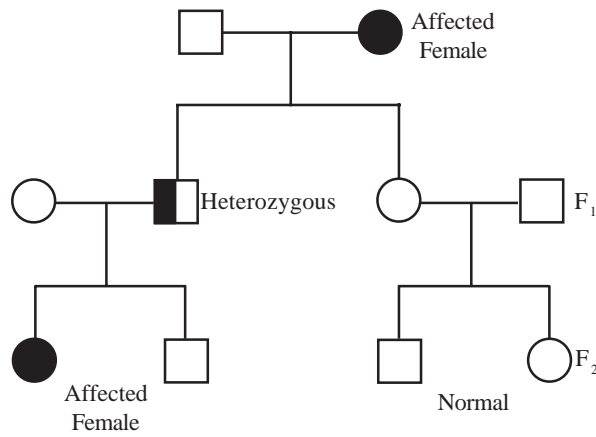

Fig. 4.4. Pedigree chart for polydactyly



## Genetic Diseases

### 1. Sickle cell anaemia :

Sickle cell anaemia is a genetic syndrome caused by an autosomal mutant allele Hb<sup>s</sup>. In homozygous condition (Hb<sup>s</sup> Hb<sup>s</sup>), it causes the production of an abnormal haemoglobin called haemoglobin S. The normal haemoglobin is designated as Hb<sup>A</sup> (Hb<sup>A</sup> Hb<sup>A</sup>). Sickle cell persons with the genotype Hb<sup>s</sup>Hb<sup>s</sup> suffer from a fatal haemolytic anaemia. The patient dies due to damaged heart, kidney, spleen and brain as a result of clogged blood vessels or vascular obstruction. Persons with heterozygous genotype Hb<sup>A</sup> Hb<sup>s</sup> are said to be carriers and they survive.

### 2. Thalassemia :

Thalassemia is an erythroblastic anaemia due to homozygous recessive gene expression in children. Two types of this disease viz., thalassemia major and thalassemia minor exist. The former is the severe form while the latter is its milder form. The homozygotes suffer from severe thalassemia while all heterozygotes suffer from milder thalassemia. The clinical manifestations of thalassemia include i) decrease in the bone marrow activity, ii) peripheral haemolysis, iii) splenomegaly (enlarged spleen) and hepatomegaly, (enlarged liver) etc. The thalassemic children die at the age of seventeen.

### 3. Agammaglobulinemia :

Agammaglobulinaemia is a recessive gene disease, wherein r-globulin synthesis fails to occur. In this disease, the patient shows a great deficiency or total absence of plasma cells and unusual lymph nodes with fewer lymphocytes than normal. The failure of antibody synthesis in this disease, makes the subjects more prone to viral and bacterial infections especially of the chest. This disease mostly affects boys.

### 4. Albinism :

It is an inherited disorder of melanin metabolism characterized by the absence of melanin in the skin, hairs and eyes. The clinical characteristics of this disease are the milk-white coloured skin and marked photophobia. Albinism is an inborn error metabolic disease, In this,

the genes by undergoing mutation do not produce particular enzymes, which take part in the metabolic pathways. The metabolism of one amino acid phenylalanine proceeds in chains of enzyme-mediated reactions. The change or absence of enzyme due to defective genes, results in physiological abnormalities. In albinism, complete lack of melanin pigment (a dark brown pigment) causes the albino to suffer. The incidence of albinism in human has been reported to be from 1:5000 to 1:25000. The albinism may be generalized albinism, localized albinism of the eye (ocular albinism) or partial albinism (skin and hair). The recessive genes 'aa' do not produce the tyrosinase enzyme, which converts DOPA (3,4 – dihydroxy phenyl alanine) into melanin in the melanocytes.

#### **5. Huntington's chorea :**

This is a fatal disease caused by an autosomal dominant gene in human. The onset of the disease is between 35 and 40 years of age. It is characterized by uncontrolled jerking of the body due to involuntary twitching of voluntary muscles. It leads to progressive degeneration of the central nervous system accompanied by gradual mental and physical deterioration. Huntington's disease was the first completely dominant human genetic disease to come to light. The affected gene is located on chromosome 4. Other characteristics of this disease are deterioration of intellectual faculty, depression, occasional hallucination and delusions and other psychological problems. This disease is incurable.

#### **6. Severe Combined Immunodeficiency (SCID) :**

This is an extremely rare inherited disease affecting children. The gene for the disease called ADA (Adenine deaminase) is located on chromosome 20. The children suffering from the syndrome completely lack the immune defense mechanism against infection due to rapid death of all white blood cells. SCID is also called Bubble Boy Syndrome. The child is kept in a sterile bubble. Unless given bone marrow transplant, the child's life span is short lived.

### **Human Genome Project (HGP)**

Human genome project involves the human genome programmes to understand the genetic composition and genetic instruction that make up a

human. The human genome is nothing but the DNA that resides in every human cell. The location and composition of 30,000 (thirty thousand) genes in human have been identified by sequencing the genome. It is known that the genes carry the information for the synthesis of various proteins. These proteins take up different profiles such as enzymes, hormones and antigens, which are responsible for various physiological and biochemical functions. The completion of the human genome project, by determining the DNA sequence of all the 23 pairs of chromosomes is a turning point and a break through in biology and medicine.

### **Human gene bank / genome database**

Human gene bank or the genome database is the collection of sequenced genes and cataloging of them for future use. They represent the fundamental data.

### **Proteomics**

Human genome analysis involves the analysis of proteins. Analysing different proteins and locating them in cells and identifying their respective genes, which encode them in the cells, represent the science of Proteomics. For identifying the proteins, the cells, mRNAs are probed. Researchers have identified about 60000 (Sixty thousand) different m-RNAs in human beings. From the mRNAs the respective genes/DNA are traced. The above said DNA is known as cDNA (Complementary DNA).

In the human genome project many disease related genes have been mapped to specific chromosomal regions.

### **Protein coding genes**

In the human genome project, proteins of different families which are involved in development and cellular processes such as neuronal function, homeostasis, immune function and cytoskeletal complexity have been identified.

## **Significance and Benefits of HGP**

1. The sequence of human genome will enable geneticists to cure the killer diseases like cancer.
2. It may enable us to understand more about the diseases and thereby to design drugs.
3. HGP aids in diagnosis of defective genes that cause disease.
4. As HGP may serve as a tool to Eugenic concept, scientists can create superior, disease free human beings in future.
5. It helps in somatic cell gene therapy and germ line gene therapy.

## **Cloning**

Cloning is an experimental technique wherein, a group of genetically identical organisms is produced. Cloning of various animals has become possible due to knowledge gained in the field of developmental biology and developmental genetics. It helped a lot, to understand the genetic control over differentiation of cells and the development of multicellular organisms.

**Differentiation :** In the development of multicellular animals the zygote represents the progenitor cell of the future embryo. Multitudes of cells arise from mitotic divisions of the fertilized egg cell. These cells later become distinct cell types differing in form and function. This process is called differentiation.

In the 1950s two embryologists R.Briggs and T.King developed a technique called nuclear transplantation. The nuclei from frog egg cells are taken out with a micropipette (enucleation) and replaced with nuclei taken from the cells of an embryo of the same animal. The recipient cells developed into normal tadpoles and frogs with all the different cell types. The investigators, with the above technique produced a number of genetically identical individuals. Cells of early embryo which are capable of complete development and producing the whole organisms are said to be totipotent.

However, experiments by J. Gurdon revealed that nuclei from older embryos and tadpoles when transplanted to the enucleated egg cells affected the developmental potential. The older the individual from which the nuclei were taken, less the recipient egg cell was able to develop normally. His experiments also revealed that cells from different parts of the embryo differed in the degree of successful development attained after nuclear transplantation. It is learnt that cells of embryos at a later stage of development switch over from totipotent state to pluripotent state. The later gives rise to development of specific tissues or organs.

**Cloning of Sheep (Mechanism) :**

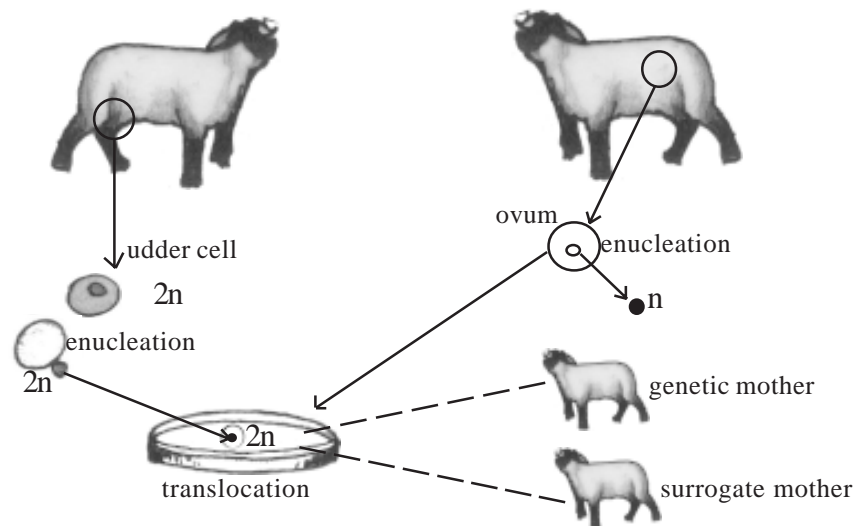

**Fig. 4.5.Mechanism of cloning of sheep**

Dr. Ian Wilmut has produced a cloned sheep called **Dolly** by nuclear transplantation method. To produce cloned sheep he took the udder cell which is a somatic cell with diploid number of chromosomes. An egg cell was also removed from a donor sheep. The egg cell cannot grow into a new sheep on its own because it only has half a set of chromosomes(n). The body cell cannot grow into a new sheep on its own because it is not a reproductive cell. So udder cell nucleus(2n) was removed. Similarly the egg cell nucleus (n) was also removed. The nucleus of the somatic cell (Udder) was injected into the enucleated egg. The egg after the nuclear



transplantation comes to possess full set of chromosomes viz. the 2n diploid. The egg was then transplanted back into the uterus of the sheep from which it was removed. The egg also can be transplanted to a new surrogate mother for development. The egg cell grew and developed into a sheep (Dolly). This cloned sheep is genetically identical to the donor sheep, which donated the diploid nucleus of its somatic cell and not the sheep which donated the egg cell.

### **Ethical Issues, Merits and Demerits of cloning :-**

1. Cloning of animals is considered as an unethical and unnatural technique by some people.
2. It is feared that attempts to clone human may lead to the birth/production of wrong persons.
3. Cloning cannot produce children like the children born to genetic mothers. Variations in traits are bound to appear.
4. When organisms are created by cloning from somatic cells of the adult, the longevity of the new born, disease tolerance capacity are some criteria to be considered. Cloned animals have also developed diseases like arthritis.
5. Cloning also leads to wastage of egg cells. In the cloning of Cat, 200 egg cells were used and 57 were implanted. Out of that only one cloned cat survived to birth.
6. Cloned animals may have health problems. They may die at a much earlier age than the rest of the species. So cloned animals from somatic cells of adult, may have short life span.
7. Among the benefits of cloning, special mention should be made regarding its role in biodiversity. Cloning will help to maintain biodiversity. It can bring back even the animals which have become extinct recently and safe guard all endangered species facing extinction.
8. Though human cloning has its own ethical problems, the principle could be used to grow new organs from the cloned stem cells. Such organ culture may solve transplantation problems, such as tissue

incompatibility, tissue rejection, harmful immune reactions etc. Many human lives could be saved.

## **Transgenic organisms**

### **Genetically Modified Organisms (GMOs)**

In genetic engineering, the methods of gene transfer lead to the production of transgenic animals and plants. These are called genetically modified organisms. Transgenism has been recognized as one of the thrust areas of biotechnology.

### **Gene transfer Methods**

The uptake of genes by the cells in animals is called **transfection**. The transfected cells are used for a variety of purposes such as 1. The production of chemicals and pharmaceutical drugs, 2. Study of structure and function of genes and 3. Production of transgenic animals of commercial value such as livestock animals and fishes. It is also called **molecular farming**. In transfection, fertilized eggs/embryos or the cultured cells are employed.

### **Transfer of genes to Fertilized eggs or embryos**

The transfection of fertilized egg involves either the transfer of whole nuclei or whole chromosomes; or their fragments or the DNA segments.

A. For the transfer of whole nuclei, the cells are treated with cytochalasin B and enucleated. The enucleated cells are incubated with the desired karyoplasts (nuclei) for induction in presence of polyethylene glycol (PEG).

B. For transfer of whole chromosomes, metaphase cells are subjected to hypotonic lysis and individual chromosomes or fragments are isolated and then incubated with whole cells/eggs for transfection.

C. Microinjection of DNA segments : In this the fertilized eggs are injected with DNA segments for integration. DNA integrated eggs are then used for getting transgenic animals.

D. Transfer of genes to cultured cells : In this stem cells are used. The stem cells are undifferentiated precursor cells. In these cultured cells, the gene can be delivered through vectors like retroviruses or directly by techniques such as microinjection using particle gun, electroporation or by the use of liposomes.

Transgenic animals have been produced in a variety of animals such as mice, rabbits, sheeps, pigs, goats, cows, fishes etc.

#### **Uses:**

1. Transgenic animals are more efficient than their normal counterpart in feed assimilation.
2. They exhibit faster growth and hence achieve the marketable size sooner.
3. Meat quality is good.
4. They are resistant to certain diseases.
5. They serve as bioreactors for obtaining valuable recombinant proteins and pharmaceuticals from their milk or urine or blood.

#### **Gene therapy**

The fact that genes can be cloned to several thousand copies through genetic engineering has given rise to an entirely novel model of therapeutic device viz., Gene therapy. Gene therapy involves the replacement of corrective genes in place of defective genes in human. There are two types of gene therapy. They are 1). Somatic cell gene therapy and 2). Germ line cell gene therapy. Both may be employed for treating the inherited diseases. In **somatic cell gene therapy** the patient's cells are taken from blood or bone marrow, or skin and brain, treated through genetic engineering and then replaced to the patient. Somatic cells are non-reproductive cells. These cells and their genes when corrected, the genetic changes will not be inherited to their children. On the other hand, this type of treatment could cure diseases caused by single gene mutations. In this therapy, retroviruses are employed as carriers of the genes. Their genetic material, RNA is copied into DNA. To produce effective vectors certain essential genes are spliced out from the

viruses. This will render the virus harmless and allow space for the therapeutic genes to be inserted. Hundreds of millions of copies of the genes are needed for somatic cell gene therapy. To carry them, the vectors should also be multiplied in equal numbers. Experimentally, such enormous copies of virus vectors are made using helper virus. The integrated vector and the cloned gene is used in somatic cell gene therapy. Somatic cell gene therapy has been successful in animals, so far.

### **Germ line cell gene therapy**

The gene therapy is extended to reproductive or germ line cells in order to prevent the genetic defects being inherited to children. The technique has been shown to work positively in animals. In this, DNA is injected into the nuclei of single celled embryos of cows, mice and sheep. The DNA may get integrated into the chromosomes. The intergrated DNA, ie., the new genes can direct the synthesis of new proteins into animals which develop from these embryos. *Germ line therapy has already been incorporated developed in human embryos.* Genes are inherited likewise through retroviral vectors into human germ cells. Germ line therapy in human is feasible, at any time, since eggs, sperms and single celled embryos can be collected and stored by deep freezing using liquid nitrogen. In vitro fertilization also may favour the above therapy. However, the therapy is still underway.

## **Bioinformatics**

### **Definition :**

Bioinformatics deals with the creation and maintenance of databases of biological information such as the nucleic acid, gene sequences and protein sequences. It has its own applications in gene therapy, diagnostics, drug designing, crop improvement, biochemical processes etc. It involves the data analysis or creation of electronic databases on genomes and protein molecules.

### **History of Bioinformatics**

From the beginning of the post Mendelian's period, genetic principles propounded by various geneticists have revealed the functional behaviour of

discrete hereditary particles called the genes, in the expression of various morphological (phenotypical) and biochemical traits of organisms. During the last three decades, the advancement in molecular biology, the invention of computers, ultra developments in scientific methodologies and introduction of instrumentation at nano level, have paved the way for the origin of bioinformatics.

The preliminary discoveries such as the amino acid sequence of bovine insulin (1950s), nucleic acid sequence of yeast alaine tRNA with 77 bases (1960s); X-ray crystallographic structure of protein, formed the basis and original databases for data entries and file making. With further advancements made in computational methods , empolying rapid search algorithms (**BLAST**) with hundreds of command options and input formats, the birth of bioinformatical science has been made.

### **Applications**

Bioinformatics is a synergistic study of both biotechnology and information technology. In biotechnology living organisms of micro level and macro level organizations are employed, and manipulated towards harvesting beneficial products to human. In recent years Biotechnology is turning into an industrial science through genetic engineering.

Genetic engineering helps the scientists to incorporate a single gene into an organism, and synthesize the desirable product without affecting other genes and their functions. In this way the biological systems or the microbial systems are manipulated

### **Scope of Genetic Engineering**

- i. To manufacture drugs and other life saving bioproducts such as insulin, growth hormones, interferons, cytokines and monoclonal antibodies.
- ii. For environmental management to reduce or abate the pollution load in soil or water.
- iii. In waste recycling to increase productivity.
- iv. In plant breeding by the incorporation of useful genes (nif genes = nitrogen fixing genes).

- v. In bringing pest resistance in agriculture crops.
- vi. And in treatment of diseases by way of gene therapy etc.

Such genetic engineering and biotechnological processes involve knowledge of enormous number of genes, their coding and their protein sequences. Computers and newly evolved software packages are utilised for these purposes. Thus biological studies are provided with a support from electronic computers. This new integrated field constitutes Bioinformatics.

### **Scope of Bioinformatics**

1. Bioinformatics helps to create an electronic database on genomes and protein sequences from single celled organisms to multicellular organisms.
2. It provides techniques by which three-dimensional models of biomolecules could be understood along with their structure and function.
3. It integrates mathematical, statistical and computational methods to analyse biological, biochemical and biophysical data.
4. Bioinformatics deals with methods for storing, retrieving and analysing biological data such as nucleic acid (DNA/RNA) and protein sequences, structure, functions pathways and genetic interactions.
5. The computational methods in bioinformatics extend information for probing not only at genome level or protein level but up to whole organism level, or ecosystem level of organization.
6. It provides genome level data for understanding normal biological processes and explains the malfunctioning of genes leading to diagnosing of diseases and designing of new drugs.

### **Definition of Database :**

‘Creating’ database means a coherent collection of data with inherent meaning, used for future application. Database is a general repository of voluminous information or records to be processed by a programme.

Databases are broadly classified as **generalized databases** and **specialized databases**. Structural organisation of DNA, protein,

carbohydrates are included under generalized databases. Databases of Expressed Sequence Tags (ESTs), Genome Survey Sequences (GSS), Single Nucleotide Polymorphisms (SNPs) sequence Tagged sites (STSs). RNA databases are included under specialized data bases.

Generalized databases contain **sequence database** and **structure databases**.

a. Sequence databases are the sequence records of either nucleotides or amino acids. The former is the nucleic acid databases and the latter are the protein sequence databases.

b. Structure databases are the individual records of macromolecular structures. The nucleic acid databases are again classified into **primary databases** and **secondary databases**.

Primary databases contain the data in their original form taken as such from the source eg., Genebank (NCBI/USA) Protein, SWISS-PROT (Switzerland), Protein 3D structure etc.

Secondary databases also called as value added databases contain annotated data and information eg., OMIN – Online Mendelian Inheritance in Man. GDB - Genome Database – Human.

### **Nucleic acid sequence databases**

European Molecular Biology Laboratory (EMBL) ; National Centre for Biotechnology Information (NCBI) and DNA data bank of Japan (**DDBJ**) are the three premier institutes considered as the authorities in the nucleotide sequence databases. They can be reached at

[www.ebi.ac.uk/embl](http://www.ebi.ac.uk/embl) (for EMBL)  
[www.ncbi.nlm.nih.gov/genbank](http://www.ncbi.nlm.nih.gov/genbank) (NCBI)  
[www.ddbj.nig.ac.jp](http://www.ddbj.nig.ac.jp) (DDBJ)

### **Protein sequence databases :-**

The protein sequence databases elucidate the high level annotations such as the description of the protein functions ; their domain structure (configuration), amino acid sequence, post-translational

modifications, variants etc. SWISS-PROT groups at SIB (Swiss Institute of Bioinformatics) and EBI (European Bioinformatics Institute) have developed the protein sequence databases. SWISS-PROT is revealed at <http://www.expasy.ch/sprot-top.html>.



Fig. 4.6.Home page of DDBJ

### Genome sequencing :

The genome of an organism can be split up into different sized molecules by a technique called electrophoresis. When DNA of an organism is subjected to electrophoresis they migrate towards the positive electrode because DNA is a negatively charged molecule. Smaller DNA fragments move faster than longer ones. By comparing the distances that the DNA fragments migrate, their number of bases could be distinguished. The sequence of bases in the DNA fragments can be identified by chemical / biochemical methods. Nowadays automated sequencing machines called **sequenators** are developed to read hundreds of bases in the DNA. The DNA sequence data are then stored in a computer accessible form.



### DNA library :

A DNA library is a collection of DNA fragments, which contains all the sequences of a single organism.

### cDNA library (Complementary DNA) :-

In cDNA copies of messenger RNA are made by using reverse transcriptase enzymes. The cDNA libraries are smaller than genomic libraries and contain only DNA molecules for genes.

In the representation of either the nucleotides or the proteins, IUB/IUPAC standards are followed. The accepted amino acid codes for proteins are given below.

A-Alanine	B-aspartate / asparagines	C-Cystine	D-Aspartate
E-Glutamate	F-Phenylalanine	G-Glycine	H-Histidine
I-Isoleucine	M-Methionine	K-Lysine	N-asparagine
P-Proline	Q-Glutamine	R-Arginine	S- Serine
T- Threonine	Z-Glutamate/glutamine	X-any	*-Translation stop
	—gap of indeterminate length.		

### The nucleic acid codes as follows (FASTA format)

A-adenosine	B-GTC	C-cytidine	D-GATG-guanosine
R- Purines (guanine, adenine)		T- Thymidine	
Y- Pyrimidines (thymidine, cytosine)	U-Uridine	H – ACT	
V-GCA	N-AGCT	B-GTC	D-GAT
	—gap of indeterminate length.		

To specialize in bioinformatics, knowledge of both biology and information computer technology is required. A biologist needs to know programming, optimization (code) and cluster analysis, as they are bioinformatics methods. The biologists should also be familiar with key algorithms (set of steps). The languages, which help in bioinformatics, are C, C++, JAVA, FORTRAN, LINUX, UNIX etc. Besides knowledge of ORACLE database and Sybase are essential. On the mathematical part knowledge of calculus and statistical techniques are needed. Knowledge of CGI (common gateway interface) scripts is also needed. With the above, a bioinformaticist could collect, organize, search and analyze the biological data viz., the nucleic acids and protein sequences.

## Uses of bio informatics

1. It helps to understand gene structure and protein synthesis.
2. It helps to know more about the diseases.
3. It helps to understand more about the fundamental biology and the thread of life, - the DNA.
- 4.. It paves the way for the medical and bio engineering applications.
5. It helps to apply the biophysical and biotechnological principles to biological studies. In turn, it will help to design new drugs and new chemical compounds to be used in health and environmental management respectively.

## Protein structure

Protein are **linear chains molecules** made up of units called amino acids. Approximately twenty different amino acids make up a protein chain. They are called polypeptide chains as they often contain a few to several hundred amino acids linked with each other by peptide bonds. Several polypeptide chains form subunits for a large protein. For example the haemoglobin consists of four subunits (Two alpha and two beta chains) each harbouring haeme, an iron containing molecule. The peptide bond between amino acids is fairly flexible. As a result, oligopeptide and polypeptide chains fold to a convoluted shapes. Every protein folds in a particular way to form a distinctive configuration for its specific function. The protein configuration is made primarily by the amino acids side chains. Some amino acid side chains are electrically charged (positive or negative). Others called polar molecules or neutral and strongly attract the electrons. A third group of amino acids are said to have non-polar or hydrophobic side chains. Thus proteins fold up in such a way that non-polar-hydrophobic groups remain buried inside the molecule and the polar and charged groups remain outside.

The sequential and linear arrangement of amino acids in a polypeptide represents its primary structure. The folding of protein chain to form recognizable modules such as alpha helix and beta sheets represents its secondary structure . The three dimensional shape of a polypeptide is called its tertiary structure. Alpha helices and beta sheets provide further stability to protein structure.

The proteins synthesized inside a cell undergo the above mentioned configurational changes to attain stable structures. Otherwise, they will be digested or destroyed by the cellular proteolytic enzymes. The proteins take up different profiles as **structural** and **functional proteins** such as enzymes and hormones etc.

In **proteomics**, the amino acid sequences are read by automated sequenators and stored in computers as internationally available databases. The information regarding three-dimensional structure of protein is stored in another computerized database called **Protein Data Bank**. Only three dimensional forms are used to define protein structure.

### **Protein Model**

In proteomics, to delineate information about a protein at atomic and molecular levels, models are constructed. X-ray crystallography can give a skeleton model of a protein from its results on its atomic details. With atomic data, computers nowadays generate **graphic images of the molecules** on high-resolution screen. Computer modeling of protein began as early as 1970. The computer-generated models depict not only the properties of amino acids in a protein but also help to understand the protein function. One of the computer graphic models is the “Glowing coal” model.

#### **Uses :**

1. Protein structure helps in understanding biomolecular arrangement in tissue or cellular architecture.
2. Protein structures, protein models and computer aided graphic models help to understand biological reactions mediated by enzymes (proteins).
3. Graphic models provided by computers are valuable to predict which fragments of a medically important protein can be used to design drugs and vaccines.
4. Proteomics also helps in chemical industries to manufacture drugs, various chemical compounds and enzymes.

## 5. ENVIRONMENTAL SCIENCE

Environment literally means the surroundings of an object. Environmental science or ecology can be defined as the study of organisms in relation to their surrounding. Ecology is one of the most popular areas in biology. Mankind is greatly interested in ecology in view of the problems of over population, environmental pollution, human survival, pest control and conservation of natural resources. The solution to all these problems involve ecological principles. Hence knowledge of environmental science is necessary for the survival of human race.

### Human population and explosion - Issues

The world population was probably only a few million people before the invention of agriculture and the domestication of animals. The following table shows the alarming rate at which population has increased.

#### World population growth

Date	Population
5000 B.C.	50 million
800 B.C.	100 million
200 B.C.	200 million
A.D. 1200	400 million
A.D. 1700	800 million
A.D. 1900	1600 million
A.D. 1965	3200 million
A.D. 1990	5300 million
A.D. 2000	6100 million

It has been calculated that the human population is growing at a rate of 90 million per year. At this rate the population would reach 12.5 billion by the year 2050. If the population keeps growing at this rate, after a few decades it will perhaps be too large for to be supported by the limited resources available on the earth. The rapid growth will affect living standards, resource use and the environment all over the world.

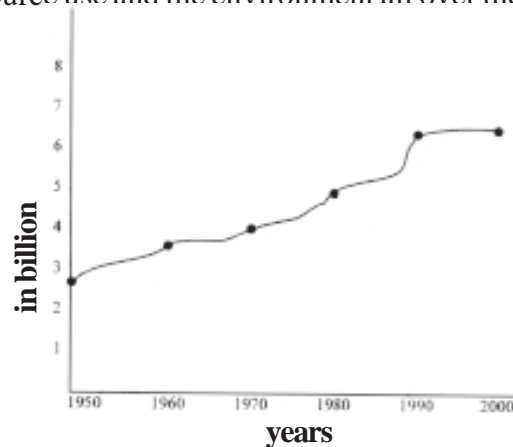

Fig.5.1. Total World population 1950 - 2000

## Demography

Thomas Malthus studied the nature of population growth. He claimed that population was increasing faster than food production and feared global starvation. He proposed that, Population grows geometrically (1, 2, 4, 8) rather than arithmetically (1, 2, 3, 4). The field of collecting, compiling and presenting information about population is called **demography**, and the people engaged in this work are named as **demographers**.

### Malthus and population growth

In 1798, the English economist Thomas Malthus realized that while the human population was embarked on an exponential growth the agricultural production remain limited. He forecasted that massive famines would occur in the early 1800's. Malthus foresaw a world, headed toward calamity if something was not done to control the population increase. Contrary to his predictions, technological innovations have enabled enough agricultural production to the rapidly growing human population.

## **Population Dynamics**

A Population is a group of interbreeding organisms in a specific region. It is analysed in terms of its variability, density and stability along with environmental and other processes and circumstances that affect these characteristics. Thus the nature of a given population is determined based on birth and death rates, the distribution of ages and sexes, behavioral patterns, food supplies, other environmental features and migration. Fertility and birth rates, mortality and death rates helps us to assess the population growth rates. A dynamic population possess a stable life span and life expectancy.

### **Uneven distribution of population**

Declining mortality and not the rising fertility is the primary cause for population growth during the past three hundred years. Population growth and its variation among nations is not uniform. Some regions of the world are over populated while others are literally uninhabited. The distribution of population is influenced by a number of physical and economic factors. The **ecumen areas** of the world with a congenial climate and fertile soils are highly favourable for human occupancy. Areas of harsh climate – too hot, too cold, too humid or too dry, rugged relief and low in resources are the **non-ecumen areas**. These are the areas where the natural environment is not conducive for human occupancy.

### ***Demographic statistics : Terminologies***

**Fertility** is the actual production of offspring.

**Birthrate** is the number of births in a year per thousand persons.

The **total fertility rate** is the number of children born to an average woman in a population during her entire reproductive life.

The **Zero Population Growth Rate (ZPG)** is the number of births by which people are just replacing themselves.

**Mortality** or death rates is the number of deaths per thousand persons in any given year.

## **Growth rates**

Death rate subtracted from birthrate gives the natural increase of a population.

The **total growth rate** includes immigration and emigration, as well as births and deaths.

## **Life span and Life expectancy**

Life span is the oldest age to which a species is known to survive.

Life expectancy is the average age that a newborn infant can expect to attain in any given society.

## **Population Explosion**

The rapid and dramatic rise in world population has occurred over the last few hundred years. The world's population increased from 1.65 billion in 1900 to 3.02 billion in 1960 and reached 6.1 billion in 2000. Thus the size of the population nearly quadrupled in the span of 100 years, a historically unprecedented rate of increase. This sudden acceleration of population is called as **Population Explosion** or **Population Bomb** or **Population Trap**.

### **Regions with majority of world population**

The major regions of population concentration are the East Asian Region, South Asian Region and West European Region.

**The East Asian Regions** : The largest populated areas. It includes countries like China, Korea, Vietnam, Cambodia, Japan and Indonesia with one fourth of the total population of the world.

**The South Asian Regions** : The countries with second largest population concentration. India, Bangladesh, Myanmar, Pakistan and Srilanka are the South Asian countries accounting for 20% of the global population.

**The West European Region** : has the third largest population concentration. European countries, Mediterranean and Arabian countries and British islands are the examples.

## **Reasons for the Explosion**

The main reason for slow and fluctuating population growth prior to early 1800's was the prevalence of diseases such as small pox, diphtheria, measles and scarlet fever. In addition, epidemics of diseases such as typhoid fever, cholera and plague eliminated large number of adults. Famines also were not unusual. Biologically speaking, prior to 180s the population was essentially in a dynamic balance with natural enemies and other aspects of environmental resistance. High reproductive rates were largely balanced by high mortality.

Since the 19th century

- discoveries of vaccination provides protections to many of the infectious agents
- discovery of antibiotics is a major breakthrough in the medical history,
- improvements in agricultural techniques,
- improvements in the nutrition and
- better sanitation and personal hygiene

brought about spectacular reductions in mortality, especially among infants and children. The birth rate has remained high. So the human population entered into exponential growth, as they were freed from natural enemies and other environmental restraints.

## **Growing Population and Environmental impacts**

Increasing numbers of people put increasing demands on the environment, both through demands for resources and through production of wastes. Most of the human population survived through subsistence agriculture to meet their needs. After the modern medicines and industrial revolution, the death rate plummeted and population growth increased. What are the impacts of rapid growth on a population that is largely engaged in subsistence agriculture? Five basic alternatives are being played out to various degrees,

- people can subdivide farms among the children or intensify cultivation of existing land to increase production per unit area.



- open up new land to farm.
- move to cities and seek employment.
- engage in illicit activities for income.
- emigrate to other countries legally.

The rapid population growth especially affects women and children. Increasing the average wealth of a population affects the environment both positively and negatively.

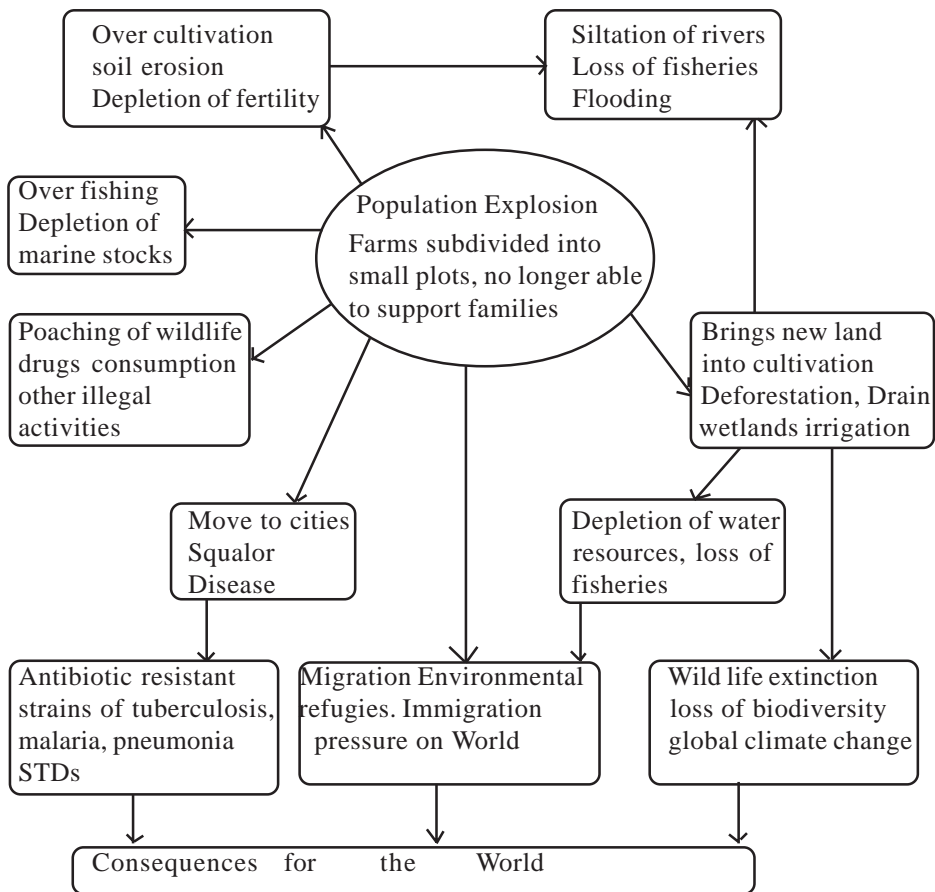

**Fig. 5.2. Consequences of Population explosion in developing nations**

## Global warming : Green house effect

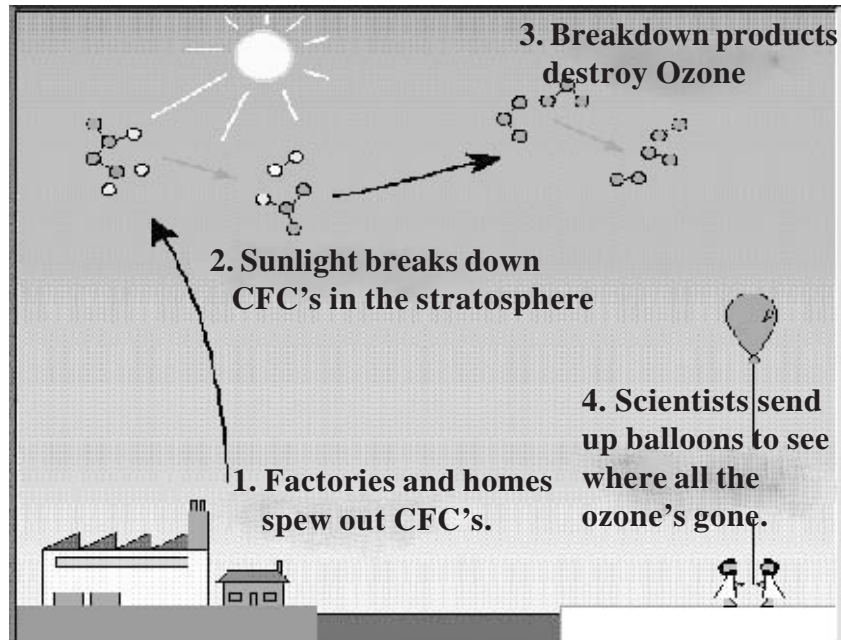

Fig. 5.3. Destruction of Ozone layer

Global warming refers to an average increase in the earth's temperature, which in turn causes changes in climate. During the past 4.65 billion years of its history, earth has warmed many times. But at present it is facing a rapid warming mainly due to human activities. The average temperature of earth is about 59°F (15°C). During the last century this average has risen by about 1°F. By the year 2100, it is believed that the rise would be between 2.5 and 10.4°F. This will cause dramatic changes such as rise in sea level, changes in rainfall patterns, wide range of impacts on plants, wildlife and humans.

### Green house gases and Green house effect :-

The trapping of energy from the sun by certain gases in the atmosphere leading to the rise in earth's temperature is known as **Green house effect**. Hence these gases are known as green house gases. Some gases such as water vapour, carbon dioxide, nitrous oxide and methane act as the trap. These gases absorb and reflect infra-red waves radiated by earth. By doing so, these gases conserve heat as the glass in a green house does.

Normally all life on earth depends on this green house effect. If it does not exist, earth would be cooled, and ice would cover earth from pole to pole. But if the greenhouse effect becomes strong it could make the earth warmer than usual. Even a little extra warming may cause problems for humans, plants and animals.

### **Types of Greenhouse Gases :-**

In the environment, greenhouse gases occur (i) naturally or (ii) from human activities.

The most abundant greenhouse gas is **carbon dioxide**. It reaches the atmosphere due to volcanic eruptions, respiration of animals, burning and decay of organic matter such as plants. Normally carbon-dioxide is removed by the plants by photosynthesis. Carbon-dioxide is also absorbed into ocean water. But humans by their activities increase the release of carbon dioxide into the atmosphere . Such activities include burning of fossil fuels, solid wastes, wood and wood products to drive vehicles, generate electricity etc. At the same time due to deforestation, the number of trees available to absorb carbon-dioxide through photosynthesis has been greatly reduced.

Human activities have caused carbon-dioxide to be released to the atmosphere at rates much faster than that at which earth's natural processes can recycle this gas. There were about 281 molecules of carbon-dioxide per million molecules of air (i.e., parts per million or ppm) in 1750. Today atmospheric carbon-dioxide concentrations are 368 ppm, a 31% increase.

Methane traps 20 times more heat than carbon-dioxide. It is emitted during the production and transport of coal, natural gas and oil. It is also emitted from rotting organic waste in sand fills, by the cows as a by product of digestion. Since 1750, the amount of methane in the atmosphere has more than doubled.

Nitrous Oxide traps 300 times more heat than carbon-dioxide. burning fossil fuels and ploughing farm soils releases nitrous oxide. Since 1750 its level increased by 17%. **Hydrocarbons** formed from the manufacture of foams, coolants such as **chlorofluorocarbons** used in refrigerators are the other gases responsible for global warming.

In 2000, scientists discovered an alarming increase in the level of a new gas called **trifluoromethyl sulphur penta fluoride**. Even though the gas is rare, it traps more effectively than all other greenhouse gases. The saddest part of it is that the industrial source of the gas is not yet identified.

#### **Effects of Global warming :-**

1. Due to the warming of oceans, sea level will rise. Glacier ice will also melt, causing further rise in sea level. As a result in the 21<sup>st</sup> century sea level will rise from 9 to 88 cm. Such a rise will submerge many parts of countries.
2. Seasons will be longer in some areas.
3. The warmed world will be generally more humid and greater humidity will increase the rainfall.
4. Storms are expected to be more frequent and intense.
5. Some regions of the world would become dry.
6. Wind blows will be harder and in different patterns. Hurricane would be more severe.
7. Weather patterns would be less predictable and more extreme.
8. Crops and forests may be affected by more insects and plant diseases.
9. Animals and plants will find it difficult to adjust to the changed environment. Animals will tend to migrate toward the poles and toward higher elevations.
10. Some types of forests may disappear.
11. More people will get sick or die from heat stress.
12. Tropical diseases such as malaria, dengue fever, yellow fever and encephalitis will spread to other parts of the world.

#### **Efforts to control Global warming:-**

Two major ways are there to control global warming: 1. to keep the carbon-dioxide out of the atmosphere by storing the gas or its carbon component somewhere else, a strategy called **carbon sequestration**. 2. to reduce the production of green house gases.

### **Carbon sequestration :-**

The simple technique is to preserve trees and plants more. Trees, take up carbon-dioxide, break it down in photosynthesis, and store carbon in new wood. It need massive reforestation. Carbon-dioxide can also be sequestrated directly into deep ocean water or into oil wells or some aquifer form which it cannot escape.

Usage of alternate fuels such as nuclear energy, solar power, wind power and hydrogen fuel cells which emit no greenhouse gases are being considered.

### **Ozone layer depletion**

Ozone is a form of oxygen (O<sub>3</sub>). In the stratosphere (ozonosphere), ozone blocks out the sun's ultraviolet rays and is a lifesaver.

### **Ozone as a natural sun block**

The electromagnetic radiation emitted from the sun includes ultraviolet radiation, which is potentially harmful to most living things since it can damage DNA. The ozone layer screens out the sun's harmful ultraviolet radiation. Even 1% reduction in the amount of ozone in the upper stratosphere causes a measurable increase in the ultraviolet radiation that reaches the earth surface. If there was no ozone at all, the amount of ultraviolet radiation reaching us would be catastrophically high. All living things would suffer radiation burns, unless they were underground, or in the sea.

In the stratosphere, small amount of ozone are constantly being made by the action of sunlight on oxygen. At the sametime, ozone is being broken down by natural processes. The total amount of ozone usually stays constant because its formation and destruction occur at about the same rate. But unfortunately human activity has recently changed that natural balance. Some manufactured substances such as chlorofluorocarbons and hydrochlorofluorocarbons can destroy stratosphere ozone much faster than it is formed.

### **Ozone hole:**

Ozone loss was first detected in the stratosphere over the Antarctic. The part of the atmosphere where ozone is most depleted is referred as “**Ozone hole**” but it is not a real hole just a vast region of the upper atmosphere where there is less ozone than elsewhere.



**Fig. 5.4. Ozone hole**

Ozone-poor air can spread out from the Polar Regions and move above other areas. In addition, direct ozone less elsewhere is slowly increasing.

Ozone-poor air can spread out from the Polar regions and move above other areas. In addition, direct ozone depleted are is also slowly increasing.

### **Reasons for the Antarctic Ozone hole:**

Scientific observations prove that the ozone hole formed over Antarctic is due to compounds of chlorine and bromine formed in the atmosphere. Nearly all of the chlorine and half of the bromine in the stratosphere comes from human activities, the chlorofluocarbons released due to human activities transported up into the upper stratosphere.

The most common Ozone depleting substances (ODS) are chlorofluocarbons (CFC) or freon gases, bromine compounds on halons, nitrogen oxides and methyl bromide. These compounds are liberally released from air-conditioners, freezers, foam insulations, aerosol products, industrial solvents, fire extinguishers and pesticides.

### Effect of Ozone depletions:

If the ozone is depleted more ultraviolet radiations (especially ultraviolet B (UVB) will reach the earth's surface.

**Effect on plants:-** will affect crop yield and forest productivity.

**Effect on animals:-** will cause damage to fish larvae and other small animals

**Effect on human health:-** Results in non-melanoma skin cancer and melanoma, acute erythema (sun burn), ocular abnormalities, cataract, affect immune responses.

The general effect of ozone depletion is summed up in the following chart

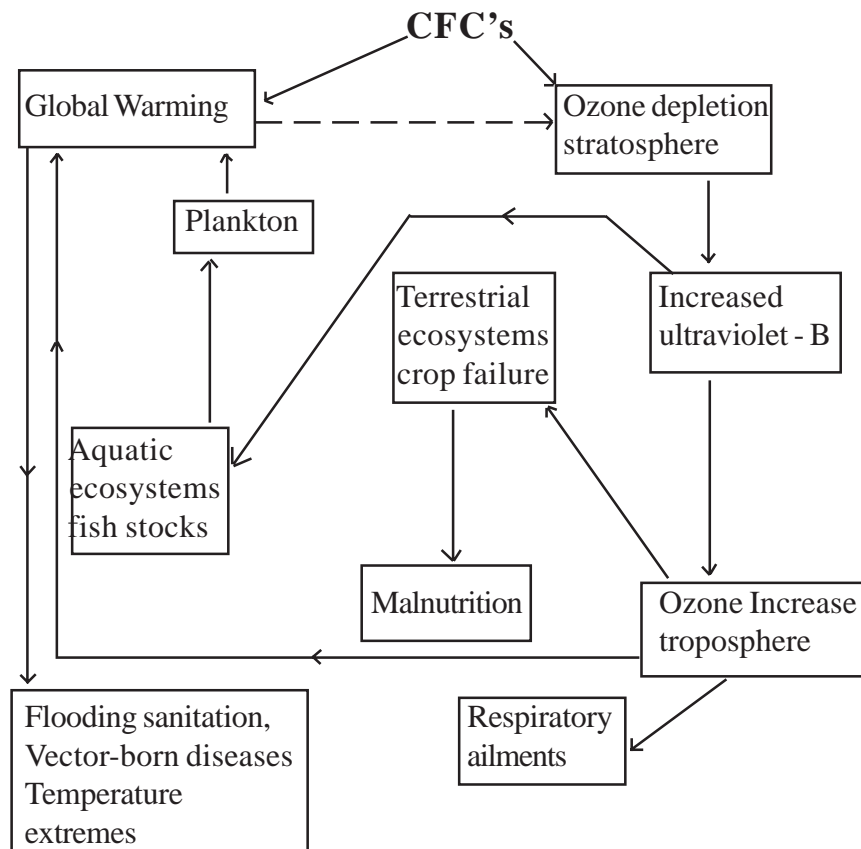

### **Preventing ozone depletion:**

1. CFC's (Chloro Fluoro Carbons) should be replaced by HCFC's (Hydro Chloro Fluoro Carbons). (If over used could damage ozone), HFC's (Hydro Fluoro Carbons), Hydrocarbons such as butane and propane. (but flammable and poisonous), Ammonia (must be handled carefully), Water and steam.
2. Production, use and emission of ozone – depleting chemicals should be controlled.
3. Recycling of these chemicals should be increased.
4. Servicing of refrigerators and air-conditioners should be regulated.
5. Refrigerants should be recaptured and used.
6. Adopt protection measures from sun's radiation.

#### **Monitoring Ozone depletion**

· In early eighties scientists reported a large hole in the ozone layers over Antarctica, where ozone level dropped by 30 percent. CFC was the prime suspect for causing ozone depletion.

· Subsequently a similar hole was discovered over the thickly populated northern hemispheres (North Europe and USA).

· An international agreement made in 1987 at Montreal organized by 34 countries (Montreal Protocol) called for reduction in the usage of CFC up to 50% by the end of the century.

· In June 1992 Japanese scientists announced that the ozone hole was 13 times wider in 1991, than it had been in 1981.

· In 1990, at London conference the developed countries agreed to 100 percent ban of CFCs by 2000 A.D.

· In 1991-1992, Scientists working in European Arctic stratosphere Ozone experiment in Sweden sent 39 balloons with payload up to 500 kg and 800 ozone probes. Their findings revealed that ozone layer was reduced by 15-20 percent. Chlorine was also found in active form in the atmosphere.



## **Waste management**

Human activities related to livelihood and welfare generate waste. All wastes are pollutants and they create pollution in one way or other. Fundamentally air, land and water pollution results mostly due to improper disposal of wastes.

### **Pollution, Pollutants**

Pollution is the human caused addition of any material or energy (heat) in amounts that cause undesired alterations to water, air or soil. Any material that causes the pollution is called a pollutant.

### **Classification of wastes**

#### **1. Bio – degradable waste**

These are wastes capable of being removed or degraded by biological or microbial action. Waste from agricultural products, animal wastes and waste from food processing, leather, fibre, paper and wood etc. come under this group.

#### **2. Non bio-degradable waste**

The substances which are normally not acted upon and decomposed by microbes are non-bio degradable wastes. It includes mineral waste, mining waste and industrial waste and non-degradable metallic and plastics substances.

#### **3. Mixture of biodegradable and non-biodegraded wastes**

It includes municipal waste and industrial waste. Municipal waste contains household garbage, piles of food scrapes, old newspaper, discarded and throw away materials, glass, cans, old appliances, broken materials, leather shoes, fibres, plastics and others. Construction waste materials, packaging materials, sewage, hospital waste, junk and vehicles are varied types of urban wastes. All these wastes are found in the form of semisolid, solid, semiliquid, sludge and in fly ash form.

## Management of hazardous wastes

Hazardous wastes may remain dangerous for thousands of years. The hazardous waste include radioactive refuse, metallic compounds, organic solvents, acid asbestos, organic cyanides, pathological hospital wastes, disposable medical equipments and tools.

The following methods are adopted for the disposal of hazardous wastes.

**1. Land fills :** There are permanent storage facilities for military related liquid and radioactive waste materials in secured lands. High level radio active wastes are stored in deep underground storage.

Wastes are carefully contained to prevent cross – mixing of reactive substances. The land fill is capped with impervious clay to prevent infiltration and percolation of water through the fill. Fill bottom is lined and provided with drainage system to contain and remove any leakage that occurs. Monitoring the wells provides a final check.

**2. Deep – well injection :** It involves drilling a well into dry, porous material below groundwater. Hazardous waste liquids are pumped into the well. They are soaked into the porous material and made to remain isolated indefinitely. However fractures in the impermeable layer may permit the injected wastes to escape and contaminate ground water.

**3. Surface impoundments :** This method is used to dispose large amounts of water carrying relatively small amounts of chemical wastes. Surface impoundments are simple excavated depressions (ponds) into which liquid wastes are drained. Solid wastes settle and accumulate while water evaporates. If the pond bottom is well sealed and if evaporation equals input, wastes may be stored in the impoundment indefinitely.

**4. Incineration :** The hazardous biomedical wastes are usually disposed off by means of incineration. Human anatomical wastes, discarded medicines, toxic drugs, blood, pus, animal wastes, microbiological and biotechnological wastes etc are called **Bio-medical wastes**.

**5. Bioremediation :** This is another rapidly developing clean up technology. Cleaning the environment with biological options such as microbes and plants is called bioremediation. Some naturally occurring bacteria and other microorganisms have the capability to degrade or absorb or detoxify the wastes such as heavy metals. Many plant materials are successfully used as adsorbents for xenobiotics (phytoremediation). Genetically Engineered Microorganisms (GEMS) are currently produced in large scale to remove the hazardous radionuclides and heavy metals such as mercury, chromium, cadmium etc. Certain plants such as *Gibberella fusarium* were able to breakdown cyanide and reduce it to a non-toxic form. The bacteria *Pseudomonas*, nicknamed as ‘super – bug’ are capable of degrading variety of toxic compounds and also degrade oil.

### **Management of non-hazardous wastes- Solid Waste Management**

**1.Sanitary land fills :** The refuse is spread in a hollow land or in a trench and compacted with a layer of clear sand fill. The sanitary land fills are far more desirable than open dumps but the ground water contamination is always a potential problem. Once a land fill operation has been completed the site must be inspected periodically. This land fill is suitable for recreational activities such as parks and play ground.

**2.Incineration :** Municipal incinerators burn combustible solid waste and melt certain non-combustible materials. Since the high temperature destroys pathogens and their vectors, it is a good method of disposal from health point of view. The incineration can reduce the volume of solid waste by 80 to 90 percent.

**3.Reuse and recycling techniques :** Resource recovery is a broad term that is used for the retrieval of valuable materials or energy from a waste. The separating out of materials such as rubber, glass, paper and scrap metal from refuse and reprocessing them for reuse is named as reclamation of waste or recycling.

Paper (54% recovery) can be repulped and reprocessed into recycled paper, cardboard, and other paper products; finally ground and sold as cellulose insulators or shredded and composted.

Glass (20% recovery) can be crushed, remelted and made into new containers or crushed used as a substitute for gravel or sand in construction materials such as concrete and asphalt.

Some forms of plastics (2.2 % recovery) can be remelted and fabricated into carpet fibre, fill for insulated apparel, irrigation drainage, tiles and sheet plastics.

Metals can be melted and refabricated (39% recovery).

Food wastes and yard wastes (leaves, grass etc.) can be composted to produce humus soil conditioner.

Textiles can be shredded and used to strengthen recycled paper products.

Old tyres can be remelted or shredded and incorporated into highway asphalt.

### **Waste water treatment and management**

The main steps in typical water – treatment plants are coagulation, settling and filtration to remove suspended particles, aeration to remove the volatile substances most responsible for taste and odour, and chlorination to kill pathogenic organisms.

For the treatment of sewage, **primary treatment** consists of mechanical filtration, screening, and settling, followed by chlorination. It removes 50 to 65% of the suspended solids.

In **secondary treatment** the organic wastes are transformed by bacteria in the treatment plant, where oxygen is provided by aeration, instead of depleting dissolved oxygen in the receiving waters. The sludge from this process, consisting largely of bacterial masses, is concentrated and processed further in an anaerobic digester.

## **Biodiversity conservation (Biosphere reserves) Government and non Governmental organizations**

### **What is biodiversity?**

Biological diversity means the variability among living organisms from all sources including terrestrial, marine and other aquatic ecosystems and the ecological complexes of which they are parts. It is usually considered at three different levels – genetic diversity, species diversity and ecosystem diversity.

### **Reasons for Decline of Biodiversity**

#### **1. Natural causes of Bio diversity extinction**

Studies of the fossil record suggest that more than 99% of all species ever existed are now extinct. Most of them were gone before humans came on the scene. At the end of Permian period about 250 million years ago, a greater disaster wiped 2/3 of all marine species and half of all plant and animal families.

#### **2. Human caused reduction**

Natural areas are converted to farms, housing subdivisions, shopping malls, marinas and industrial centres. For example, when a forest is cleared, it is not just the trees that are destroyed, but also every other plants and animals that occupy that destroyed ecosystem, either permanently or temporarily also suffers.

### **Importance Biodiversity conservation?**

Biodiversity is the backbone for agriculture, aquaculture, animal husbandry, forestry and a host of other applied branches of biology. Biodiversity is fast becoming the fundamental requirement on which the new industrial developments and innovations are going to be based. Biodiversity will offer in the coming years, new sources of food, medicine and other human requirements.

To save the races of endangered and endemic species the bio resources should be identified and the hotspots in each country should be given prior importance to conservation. Only then the remaining species at the verge of extinction could be saved.

## **Consequences of Losing Biodiversity**

Many species have already become extinct and we do not know really what we are losing when we lose species. In future we might lose a keystone species, a species whose role is absolutely vital for the survival of many other species in an ecosystem. For example, the Orchid bees play a vital role in tropical forests by pollinating trees. If they disappear, the eventual fall of that ecosystem is evident. This loss may remove and constrict the natural habitats in which wild species live. Recreational, aesthetic and commercial losses will also be inevitable.

## **Conservation of Biodiversity**

The conservation of biodiversity and the growing human population are the two great challenges facing our generation and those to follow. The following strategies are adapted to conserve biodiversity.

### **a. International Conservation Strategies**

Biodiversity should be preserved as the common heritage of all humans. All species have a right to exist; one strategy considered as a priority is **conserving hotspots** around the globe. These are areas characterized by high concentrations of endemic species and experiencing unusually rapid rate of habit modification loss. There are around 25 hotspots identified from all over the world.

### **b. National Conservation Strategies**

Several measures like legal measures, *in situ* and *ex situ* conservation efforts, documenting of indigenous knowledge and the application of science and technology have been taken by Indian government legislations.

India is one of among the 12 Mega biodiversity countries of the world. India was a party to the **International Convention on Biological Diversity (CBD)** in May 1994. The Union Ministry of Environment and Forests is co-ordinating an effort to formulate **National Biodiversity Action Plan**. This is being carried out with the help of several other Government and Non-governmental organizations, and individuals.

### 3. Establishment of Bioreserves

A biosphere reserve is a unique concept which includes one or more protected areas and surrounding lands that are managed to combine both conservation and sustainable use of natural resources. '**Biosphere Reserve**' is an international designation made by the United Nations Educational, Scientific and Cultural Organisation (UNESCO). It is based on the basis of nominations submitted by countries participating in the **Man and the Biosphere Program** (MAB). The MAB was launched in 1971 to catalyse a greater understanding and provision of knowledge and skills to support sustainable relationships between people and their environment. Biosphere Reserves act as a keystone of MAB by providing a global network of sites for cooperative research toward this end. As at the end of November 2002, the World Network of Biosphere Reserves included 495 sites in 95 countries.

#### Characteristics of a Bioreserve

- It is a land and/or coastal/marine area in which people are an integral component, and which is managed for objectives, ranging from complete protection to intensive yet sustainable production.
- It is a regional centre for monitoring, research, education and training on natural and managed ecosystems.
- It is a place where government decision makers, scientists, managers and local people cooperate in developing a model programme for managing land and water to meet human needs while conserving natural processes and biological resources.
- Finally, each biosphere reserve is a symbol of voluntary cooperation and use resources for the well being of people everywhere.

#### Bioreserves in India

Tamilnadu has the distinction of having a marine biosphere reserve viz., the **Gulf of Mannar Biosphere Reserve** and also a hill Biosphere Reserve, the **Nilgiri biosphere Reserve**.

### ***Nilgiri Biosphere Reserve:***

The total area is 5,520 sq. km. It is rich in plant diversity. It was established to conserve *in situ* genetic diversity of species and restore degraded ecosystem to its natural conditions.

### ***The Gulf of Mannar Biosphere Reserve:***

This reserve was one of six areas chosen on the basis of its threatened status and richness of biological wealth for inclusion into an action programme to save India's protected areas for future generations. It encompasses 21 small islands along the coast. It is considered as a 'biologists paradise' with 3600 species of plants and animals.

The other biosphere reserves of India are: Nokrek (Meghalaya), Namdapha – (Arunachal Pradesh), Nanda Devi – (Uttar Pradesh), Great Nicobar (Andaman & Nicobar islands), 5. Sundarbans (West Bengal):

**Project Tiger :** This programme was launched in 1973. This is started with the protection of nine tiger reserves located in different habitats. Today there are 23 tiger reserves are under this project to look after tiger population and the environment.

### **Organizations involved in Biodiversity Conservation**

The organizations involved in biodiversity conservation are 1. **World Wildlife Fund:** (WWF) 2. **Resources for the Future :** (RFF) 3. **The Nature Conservancy:** 4. **World Resources Institute :** (WRI), 5. **IUCN (International Union for Conservation of Nature and Natural Resources)**, 6. **African Wildlife Foundation:** (AWF), 7. **Genetic Resources Action International :** (GRAIN), 8. **International Science Foundation,** 9. **The Biodiversity Support Program:** (BSP)

### **Organizations functioning to preserve and safeguard biodiversity in India :**

1. National Bureau of Plant Genetic Resources in New Delhi.
2. National Bureau of Animal Genetic Resources at Kamal.
3. National Bureau of Fish Genetic Resources in Allahabad.
4. The Union Ministry of Environment and Forests.



5. The Foundation for the Revitalisation of Local Health Traditions (FRLHT) in Bangalore.
6. Centre for Ecological Sciences, Bangalore.
7. World Wide Fund for Nature, India.
8. Department of Biotechnology, Government of India.

## **Energy crisis and its environmental impact**

Energy may be defined as any property, which can be produced from or converted into work. In today's world for any development and for all industrial operations, energy is a prerequisite. Life is unthinkable without energy. Energy production and energy utilization are the indicators of a country's progress. Heat, light, electricity are different forms of energy. While energy drives the world, the energy generated and utilised affects environment on a phenomenal scale. More population, rapid industrialisation, increased energy generation, over production, uncontrolled consumption and damages to environment are all inter-linked issues. Major issues are slowly being converted into crisis threatening our survival.

### **Background history of energy usage:**

**Fire** was probably the first human energy technology. **Charcoal** from fires has been found at sites occupied by our early ancestors. **Wind** and **waterpower** have been used early as long. **Muscle power** provided by domestic animals has been important for agriculture. The invention of the **steam engine**, together with diminishing supplies of wood in industrializing countries caused a switch to **coal** as our major energy source in the nineteenth century. Coal in turn, has been replaced by **oil** in this century due to the ease of shipping, storing and burning liquid fuels. Recently **electricity** and **gas (petrol)** has changed the economic prosperity and lifestyle in many countries.

### **Renewable and non-renewable energy sources**

Energy sources that are being made available continuously are known as renewable energy sources. (Eg). geothermal energy, wind energy, tidal energy, solar energy, ocean currents, nuclear fusion, gobar gas, biomass and vegetable refuse etc.

Non-renewable sources of energy – those sources, which are being accumulated in nature from a very long time and cannot be replaced if they are exhausted. (Ex). Coal, ores, petroleum, timber, natural gas, electricity etc. Fossil fuels like **petroleum, natural gas** and **coal** are now providing about 95% of all commercial energy in the world.

### **Energy crisis**

Energy crisis is due to the increase in population accompanied by rapid urbanization and industrialization. Our resources of petroleum and natural gas are dwindling day by day. We can hardly expect the oil industry to operate at full capacity until the last drop is removed from the ground. It appears that we will run out of petroleum and natural gas by about 2020 unless domestic supplies are extended by taking one or more of the following steps.

### **Steps to be taken to resolve energy crisis**

**1.Reduce the consumption of fuels :** The principal target areas are heating and transportation, which account for about 18% and 25% respectively, of our total energy requirements. The consumption of fuel in these areas can be reduced by (a)proper insulation of existing buildings and design changes in new constructions (eg. using less plate glass), (it saves about 33% of energy) (b)improving the fuel economy of automobiles, (c) using more efficient means of transportation.

**2. Develop new sources of energy:** The energy crisis has prompted the development of alternate energy sources (alternatives to fossil fuels) other than the heat available from the combustion of fossil fuels.

#### **(a)Wind Energy :**

In India, the wind power is of great significance as there are large coastal, hill and desert areas where wind energy can be usefully exploited for generation of electricity and water pumping.

The harnessing technology of wind energy is simple. The strike of the blowing wind on a specially designed blades of a windmill's rotor causes it to rotate. This rotation, which is the mechanical energy, when coupled to a

turbine, drives the power generator. The wind energy thus delivers on the spot small quantities of energy. The Indian subcontinent is a high wind zone with energy potential estimated at about 20,000 MW. Wind farms are already located in Tamil Nadu, Gujarat, and Andhra Pradesh.

*Advantages of wind power :* i. Power generation is cheaper. Power is procured at 40 paise per unit ii. free from pollution and environmental degradation, iii. Since generation is continuous unlike in diesel power, investment is never idle.

### ***(b) Geothermal Energy***

Geothermal energy is fast emerging as a significant source of electricity in several island nations, mainly in the Indian oceans and the Pacific regions. Geothermal plants make use of naturally heated steam drawn to the surface through a series of boreholes.

### **Hot Rocks for energy generation**

The Hot Dry Rock (HDR) technology is especially suitable for countries like India, where the geological pattern favours easy exploitation of this source. Tapping of energy involves drilling of holes several km deep into the earth where the temperature of rocks ranges from 200 – 250°C. Water is pumped into these bore holes and allowed to circulate through the source rock's fracture net work, which may have fissures barely a few millimeter wide. This water is then ejected under pressure from a second hole in the form of steam. The steam is used to power turbines for electricity generation, after which it is condensed back to water that can be used again.

### ***(c) Mini hydel generation***

Energy generation from small water source is probably the most cheapest and reliable of all renewable energy sources. It can be harnessed conveniently from nearby canal or stream in a most environmentally benign manner. Nature has been very generous and bounteous in providing a vast hydro electric potential to the Indian subcontinent.

### ***(d) Ocean energy***

The various methods of extracting energy from oceans are as follows.

1.Ocean winds, 2.Ocean waves, 3.Ocean tides, 4.Ocean currents, 5.Ocean geothermal, 6.Ocean Thermal Energy Conversion (OTEC), 7.Salinity gradient and 8.Bioconversion of sea weeds.

India's first power plant generating electricity from ocean energy is commissioned at Vizhinjam fishing harbour in Kerala to provide energy of 150 MW in a year.

**Tidal energy :** *Ocean waves and tides contain large amount of energy. Tidal energy is important because it is renewable, pollution free and more stable in comparison with hydroelectric power which is dependent on monsoon cycle. Tidal power plants are being designed in the Bay of Canada, Kutch in India etc where tides have been found to be in the right range.*

**(e) Solar energy:**

Solar energy is another energy source. Each year the earth receives from the sun an enormous total of  $5 \times 10^{20}$  k.cals of energy. Solar energy, which is the primary source of all energy forms on the earth, is the renewable form of energy.

*Advantages of solar energy:*

(a) Solar energy is a kind of universal, decentralized and non-polluting energy (b) it helps considerably in maintaining the ecological balance through the process of photosynthesis and green house effect. (c) it has none of the disadvantages found in the combustion of fossil fuels such as coal, oil or gas.

**(f) Nuclear energy :**

Nuclear energy is the only energy source, known to be economically feasible in the present and for the near future. It can replace fossil fuels. In nuclear fission, a heavy atom splits under neutron bombardment into smaller fragments, with the evolution of huge amount of energy. In spite of this advantage the problem of disposal of nuclear wastes remains.

**Nuclear fusion** is expected to be an ideal energy source for the future. In nuclear fusion, light nuclei such as deuterium ( ${}^2_1\text{H}$ ) and tritium ( ${}^3_1\text{H}$ ) combine to form heavier stable nuclei.

Moreover, the products of fusion are not radioactive and so safety hazards associated with fission reactors are greatly reduced. The light isotopes needed for fusion are sufficiently common to supply all of our energy needs for hundreds of years. Unfortunately, the above fusion reaction has not been perfected to sustain flow of energy.

***(g) Bio gas or Gobar gas:***

Gobar gas plants are based on anaerobic fermentation of organic wastes in the absence of air. Through gaseous stage the heating efficiency of the cattle dung increased production by about 20%. There is a production of an organic manure which is about 43% better than dry cattle dung itself. This manure can also reduce pressure on naphtha-based fertilizers. It has been estimated that 10m<sup>3</sup> of biogas has energy equivalent of 6.0 m<sup>3</sup> of natural gas, 3.6 litres of butane, 7.0 litres of gasoline or 6.1 litres of diesel fuel.

***(h) Hydrogen – Source of power for future***

The hydrogen has been found to be a good choice among all the alternative fuel options. It can be produced in virtually unlimited quantities with on hand production technologies. It has been established that hydrogen can meet all the energy needs of human society, including power generation more efficiently and more economically than petro fuels, and with total compatibility with the environment. In addition, hydrogen is non-toxic, reasonably safe to handle, distribute and use as a fuel. Hydrogen has the highest mass energy content – its heat of combustion per unit weight is about 2.5 times that of hydrocarbon fuel, 4.5 times that of ethanol and 6.0 times that of methanol. Its thermodynamic energy conversion efficiency of 30-35% is greater than that of gasoline (20-25%).

**Environmental impacts**

**1. Thermal Power**

The air, water and soil pollution caused by these plants in terms of fly ash, CO<sub>2</sub>, SO<sub>2</sub>, NO<sub>2</sub> and particulates etc. is becoming unacceptable in the environmentally conscious society.

## **2. Hydel power**

Hydro-electric power generation is associated with displacement and resettlement of human population from the site of hydel plant to other places. This leads to considerable human problems causing considerable delay in the implementation of the project and escalation of its cost. New dams built may affect the ecosystem of the locating sites.

## **3. Nuclear power**

Radioactive pollutants released from nuclear power plants are chronically hazardous. The commissioning of boiling water power reactors (BWRS) have resulted in the critical accumulation of large number of long lived radionuclides in water. Environmentalists argue that thermal effluents from nuclear reactors have acutely affected the aquatic eco system. The dangerous radioactive waste cannot be buried in land without the risk of polluting soil and under ground water. Several well publicised accidents (Ex. Chernobyl disaster at former U.S.S.R.) and radiation episodes have given a lot of fear in the mind of general public regarding the radiation hazards.

## **4. Solar energy**

The use of solar energy, from the environmental viewpoint, is a completely safe operation. However, the sites for larger installations of solar power plants should be selected without reducing the forest cover. Cadmium, used in fabricating thin film solar cells, is both poisonous and a possible carcinogen. Carbon dioxide produced while forming silicon from silica may increase the atmospheric temperature causing green house effect. Silicon dust is also an important occupational hazard.

## **5. Fossil fuels**

The burning of coal, oil, wood, dung cakes and petroleum products would cause environmental problems. (1) The increase in CO<sub>2</sub> concentration is largely responsible for green house effect and global warming, while (2) disposal of fly ash requires large ash ponds and may pose a severe problem (3) The smoke produced by burning of wood, agricultural by-products or animal's dung cake causes respiratory and digestive problems and may also lead to eye and lung diseases. (4) Nitrous oxide, Sulphur di-oxide and CO<sub>2</sub> can cause acid rain.

## Poverty and environment

Poverty is a condition of having insufficient resources or income. It is a lack of basic human needs such as adequate and nutritious food, clothing, housing, clean water and health services. Extreme poverty can cause terrible suffering and death. The world's poorest people – many of whom live in developing areas of Africa, Asia, Latin America, Eastern Europe – struggle for daily food, shelter and other necessities. They often suffer from severe malnutrition, epidemic disease outbreaks, famine and war. In wealthier countries – such as United States, Canada, Japan and those in Western Europe – the effects of poverty may include poor nutrition, mental illness, drug dependence and crime. Extreme poverty, which threatens people's health or lives, is known as **destitution** or **absolute poverty**. A condition of having fewer resources or less income than others within a society or country when compared to worldwide averages is known as the **relative poverty**.

The cycle of poverty, illness and limited opportunities becomes a self-sustaining process that passes from one generation to another.

## Poverty and Environmental issues

Some favour the argument that poverty leads to environmental degradation while others argue that environmental degradation will lead to poverty.

The increase in population and poverty has made an impact on natural resources and the environment in many regions. In many parts of the world, environmental degradation – the deterioration of the natural environment, including the atmosphere, bodies of water, soil and forests – is an important cause of poverty. Environmental problems have led to shortages of food, clean water, materials for shelter, and other essential resources. As forests, land, air and water are degraded; people who depend upon these natural resources are adversely affected. As we know, global environmental degradation may result from a variety of factors, including over population and the resulting over use of land and other resources. Drastic environmental degradations may result in poverty.

## **Poverty alleviation**

Various measures to eradicate poverty in human society include the following:

- a) Achieving self sufficiency by intensifying agriculture, augmenting green revolution, increasing crop productivity through modern genetic and bio technological approaches.
- b) Increasing land and water resources. Expanding the area of able cultivable lands, transforming dry lands into productive lands through irrigation water sheds development.
- c) Prevention of land and water pollution by minimizing the usage of chemical pesticides and adopting biological control strategies for pest eradication.
- d) Establishment of industries and technologies and creating more avenues for employment and man power utilization.
- e) Anti- poverty programmes and social security scheme by the Governments.
- f) Establishing more primary health centres, hospitals and orphanages for destitutes and diseased.
- g) Enforcement of strict family planning methods.

## **Fresh water crisis and management**

Clean, fresh water is essential for nearly every human activity. Perhaps more than any other environmental factors, the availability of water determines the location and activities of humans beings. Almost all agricultural operations which supply food to humanity need water.

### **Freshwater resources**

Of the total water available on earth, only 3% is fresh water.

**1. Glaciers, ice and snow :** Of the 3 percent of all water that is fresh, about three – fourths is tied up in glaciers, ice caps and snowfields. They occur only at high altitudes or high latitudes.



**2. Ground water** : After glaciers, the next largest reservoir of fresh water is held in the ground in ground water. Water held in the lower soil layers is known as water table. Porous- water bearing layers of sand, gravel and rock are called aquifers.

**3. Lakes and Ponds** : Lakes are inland depressions that hold standing fresh water year around. Ponds are small temporary or permanent bodies of shallow water. While lakes contain nearly one hundred times as much water as all rivers and streams combined, they are still a minor component of total world water supply.

**4. Wet lands** : Bogs, swamps, wet meadows and marshes play a vital and often a minor role.

### **Freshwater shortages**

At least one billion people or nearly 20 percent of the world's population, lack safe drinking water. The W.H.O. considers 53,000 gallons of good water per year to be the minimum for a healthful life. Some forty countries (including island nations, Middle East countries) in the world fall below this level.

### **Reasons for freshwater shortages**

#### **1. Natural forces**

Deficits are caused by natural forces such as poor rain fall and hot winds, rivers changing courses.

#### **2. Human causes**

Include increased population, rapid urbanization, over grazing by cattle, improper cultivation methods, poor sewage systems, inadequate finances for providing infra structures.

#### **3. Depleting ground water**

Ground water is the source of nearly 40 % water for agricultural and domestic use in most of the countries. Nearly 95% of rural population depends on groundwater for drinking and other domestic purposes. Over

use of the supplies causes several kinds of problems, including drying of wells, natural springs and disappearance of surface water features such as wetlands, rivers and lakes.

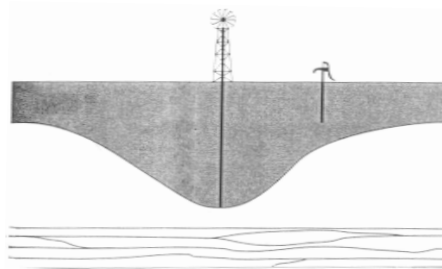

**Fig. 5.5. Depletion of ground water**

In many parts of the world, groundwater is being withdrawn from aquifers faster than natural recharge can replace it. On a local level this causes a level of depression in the water table. A heavily pumped well can lower the ground water table so that nearby shallower wells go dry. On a broader scale, heavy pumping can deplete a whole aquifer. Many aquifers have slow recharge rates, so it will take thousands of years to refill them once they were emptied.

#### **4. Salt water intrusion**

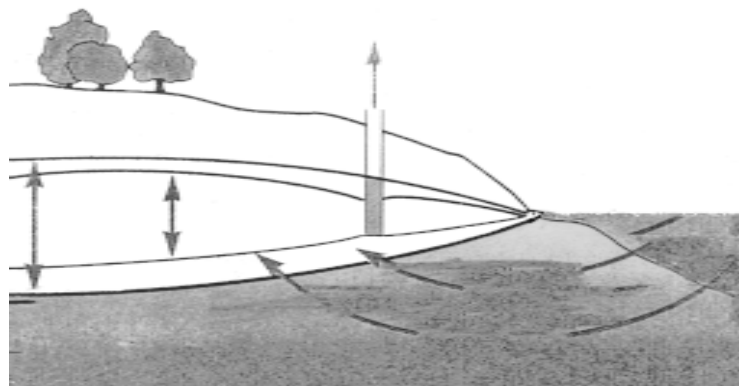

**Fig. 5.6. Salt water intrusion**

Many parts of the world are losing freshwater sources due to saltwater intrusion. Over use of under ground freshwater reservoirs often allows salt water to intrude into aquifers and affect the water table.

## **5. Loss of free flowing rivers**

Loss of free flowing rivers that are either drowned by reservoir impoundments or turned into linear, sterile irrigation channels is yet another cause for freshwater crisis.

## **6. Evaporations, leakage and siltation**

It happens in freshwater lakes, ponds and dams.

### **Freshwater Management**

On a human time scale, the amount of water on the earth is fixed, for all practical purposes. There is little we can do to make more water. However, there are several ways to increase local supplies.

#### **a) Seeding clouds**

Seeding clouds with dry ice or potassium iodide particles sometimes can initiate rain if water laden clouds and conditions that favour precipitation are present.

#### **b) Desalination**

Desalination of ocean water is a technology that have great potential for increasing fresh water. The common methods of desalination are distillation (evaporation and recondensation) or reverse osmosis (forcing water under pressure through a semipremeable membrane whose tiny pores allow water to pass but exclude most salts and minerals). Although desalination is still three to four times more expensive than most other sources of freshwater, it provides a welcome water supply in such places like Dubai, Oman and Bahrain where there is no other access to fresh water.

#### **c) Dams, Reservoirs, Canals and Aqueducts**

It is common to trap run off with dams and storage reservoirs and transfer water from areas of excess to areas of deficit using canals, tunnels and underground pipes.

#### d) Watershed management

A series of small dams or tributary streams can hold back water before it becomes a great flood. Ponds formed by these dams provide useful wildlife habitat and stock-watering facilities. Small dams can be built with simple equipment and local labour, eliminating the need for massive construction projects and huge dams.

#### e) Rain water harvesting

The activity of collecting rainwater directly or recharging it into ground to improve ground water storage in the aquifer is called rain water harvesting. By rainwater harvesting the ground water can be conserved, water table depletion can be reduced and also sea water intrusion in coastal areas can be arrested. To recharge the groundwater rainwater that falls in the terrace of the buildings and in the open space around the buildings may be harvested. Roof top rain water can be diverted to the existing open / bore well. Rainwater available in the open spaces around the building may be recharged into the ground by the following simple but effective methods.

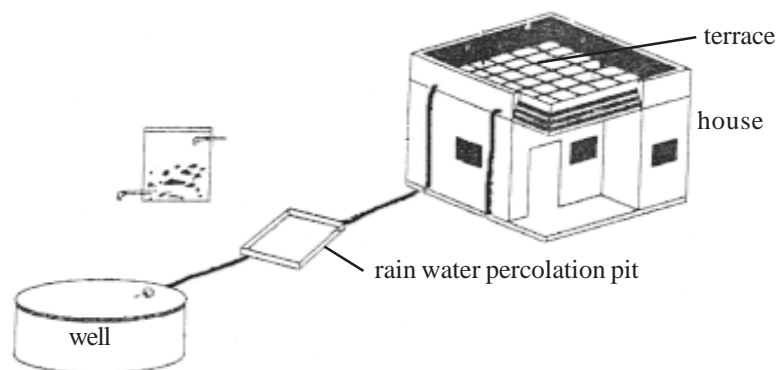

**Fig. 5.7. Rain water harvesting**

The Government of Tamilnadu leads the nation in implementing rain water harvesting programme. It has made it mandatory for all houses and buildings in the State to install rain water harvesting facility.

#### **f) Better agricultural practices**

Sound farming and foresting practices can reduce runoff. Retaining crop residues on fields reduces flooding. Minimizing ploughing and forest cutting on steep slopes protects watersheds. Wetlands conservation preserves natural water storage capacity and aquifer recharge zones.

#### **g) Domestic conservation**

We could save as much as half of the water we now use for domestic purposes without great sacrifice or serious changes in our lifestyles. The use of washing machines, dish washers and low volume shower heads can reduce water loss.

#### **h) Industrial conservation**

Nearly half of all industrial water use is for cooling of electric power plants and other industrial facilities. By installing dry cooling systems, this could be avoided. Cooling water can be recharged, some industrial wastewater may be treated, recycled and reused.

#### **i) Saving water -an individual's role**

As an individual you can conserve water by the following methods.

- Take shorter showers.
- Don't wash car and two wheelers often
- Don't allow tap run while washing hands, dishes, food or brushing your teeth unnecessarily.
- In your lawn consider planting native plants, a rock garden or some xerophytic landscaping.
- Use water conserving appliances : low – flow showers and low -flush toilets.
- Use recycled water for lawns, house plants and car washing
- Check taps for leaks

## 6. APPLIED BIOLOGY

### Livestock and Management

The well being of human population is directly linked to the natural resources of a country. Natural resources are of various kinds. They are plants, animals, land, water and minerals. Animal husbandry and dairying have been mainly rural-based, generating employment and revenue among the rural people. Extensive studies have been undertaken by ICAR (Indian Council for Agricultural Research), State Agricultural Universities, and non-governmental research organizations, etc, to improve the livestock and its management. Intensive crossbreeding programme in cattle has led to the evolution of high-yielding milch animals.

### Dairy

Dairy operation consists of proper maintenance of cattle, the collection of milk, processing the milk, and its by products. Dairying is the production and marketing of milk and its products.

Dairy technology made rapid growth in the later half of the 19<sup>th</sup> century. New methods and equipments are available for machine-milking of cows. Artificial feeds and nutrient foods are manufactured to improve the milk yield of cows. Breeding techniques and applications of biotechnology in stock improvement programme of cattle have tremendously increased the production of new breeds with high milking capacities. Since milk forms a staple food, majority of the Indian population rely on milk for their protein supplement.

### Important cattle breeds and their characteristics

Among mammals, cattles belong to the genus *Bos* (ruminant quadrupeds), and the species being divided into *Bos indicus* (humped cattle), *Bos taurus* (without any hump), *Bos bubalis* (the buffalo).

In India at present there are twenty six well defined breeds of cattle and six breeds of buffaloes found spread all over the country. Cattles are

classified under three groups based on the purpose they serve to man. They are **Dairy breeds**, **Dual purpose breeds** and **Draught breeds**. A **breed** is a group of animals of a species which has for a long period been bred among themselves. The members of the breed have closely resembling characters and these characters are hereditarily transmissible to young ones.

### Cattle Breeds

**Dairy purpose**  
cows are high milk yielders, with extended lactation.

1. Sahiwal
2. Sindhi
3. Gir
4. Umblachery
5. Karan swiss

**Dual purpose**  
cows are meant for milk and bullocks are meant for draught.

1. Haryana
2. Ongole
3. Tharparker
4. Kankrej

**Draught purpose**  
Bullocks are good draught animals while the cows are poor milk yielders.

1. Amritmahal
2. Kangayam
3. Malvi
4. Siri
5. Hallikar

### I. Milch breeds (or) Dairy breeds

The cows of this group are high milk yielders with extended lactation periods. The bullocks are of poor draught qualities. These cattle are well built with strong limbs. e.g Deoni, Gir, Sindhi and Sahiwal. The cows in domestic usage for milk are non-descriptive types.

#### 1. Sindhi (Red Sindhi, Red Karachi) :



Fig.6.1.Sindhi cow



Fig.6.2.Sindhi bull

**Origin and distribution :** The home of this breed is Karachi and Hyderabad.

**Distinguishing characters :** Medium size and compact body. Thick horns emerging laterally and ending in blunt points. They have intelligent facial expression. Deep dark red colour. Bulls are darker than the cow. They have hump and the udder is large with medium sized teats. The animals are docile and quiet. Bullocks are steady workers, suited for road and field work.

Sindhi cows are hardy and have high degree of resistant to heat and ticks. These are the most economical milk producers among the dairy breeds of India.

Milk production :- Yields as high as 5,443 kg per lactation period.

## **2. Gir (Kathiawarhi, Surti) :-**

**Origin and distribution :** The breed originated from the Gir forest of South Kathiawar. Impure forms of Gir breeds are found in Baroda and some parts of Maharashtra.

**Distinguishing characters :** The colour is not always entire. Most of these cows have spotted skin. It is usually red, black and red, red and white or white with red spots. The body is well built with clear cut lines. The pure breed has a majestic appearance. Ears are long like a leaf. Tail is long and whip like. Legs are long and well built. Udder is large with matching teats. Bullocks are heavy, powerful and good for draught.

**Milk Production :** Gir cows are good milk yielders. In some, the maximum yield is 3,715 Kg per lactation period.

**II. Dual purpose breeds :** This breed of cattle are meant for both milk yield and draught works. The cows are fairly good milkers and the bullocks are sturdy and are useful in draught works like ploughing the field, transport, cart pulling etc. Important examples are Hariana and Ongole.

### **1. Ongole : Nellore**

**Origin and distribution :-** Ongole tract of Andhra Pradesh, Guntur, Narasaraopet, Venukonda, Kandukur taluks of Nellore.





**Fig.6.3.Ongole**

**Distinguishing characteristics :** This breed is a larger form. The matured male weighs about 700Kg and female weighs about 400 Kg. Ongole breed is usually white in colour with grey marking. Males are dark grey at extremities. Hump is well developed and erect. The horns are stumpy and they grow outwards and inwards. Bullocks are powerful and suitable for cart and road work but are not fast.

**Productions :** Cows are good yielders, yielding from 1700 kg to 3500kg per lactation.

**III. Draught breeds :** These breeds are exclusively meant for pulling carts, ploughing fields etc. They are well-built and the skin is well stretched. The bulls are used for draught works. The cows are poor milkers. Important Indian draught breeds are Amrithamahal, Kangayam, Malvi, Hallikar etc.

**1. Kangayam (Kanganad, Kongu) :-**



**Fig.6.4.Kangayam**

**Origin and distribution :** It originated from Kangayam divisions of Dharapuram taluk of Coimbatore district in Tamilnadu. The breed is also found in Udumalaped, Palladam, Pollachi and in other parts of South India.

**Distinguishing characters :** The cattle of this breed are of moderate size and the colour of the body is white or grey with black markings. The horns are strong and are curved upwards and outwards. The head is short with prominent forehead. Neck is shorter and thick and the ears are smaller and pointed. They have moderate sized hump, wide muzzle, strong limbs, fine skin and a fine tail. The udder is medium sized with small teats. The bulls are excellent type for hard work.

**Production :** The cows are poor milkers, yielding about 666 kg per lactation.

## **2. Hallikar**

**Origin and distribution :** Commonly found in the South Indian States, predominantly in Karnataka. Hassan and Tumkur regions of Karnataka are the home places of this breed.

**Distinguishing characters :** Body is dark grey in colour, some times almost black. The animals are of medium size. The head is usually long with a bulging forehead and a prominent furrow in the middle. The face is long with small ears. The long horns emerge out, slant backwards in a graceful sweep and then curve upwards to terminate in a sharp point. The hump is moderately developed. The udder is medium sized with small teats. The Hallikar bullocks are draught breeds. They are used for heavy ploughing, transport and other field works.

**Production :** The cows are poor milkers.

**Exotic breeds of cattle :** Many milk yielding breeds of cattle are imported and reared in India. The exotic breeds are successfully crossed with indigenous breeds to obtain cross breeds, which have sufficient desirable characters. European breeds are the first kind of exotic breeds introduced in India about 90 years back. Important ones are short horns Ayreshire, Jersey, Brown swiss, Holstein Friesian, Guernsey and Red Dane.

**Jersey :** Jersey is one of the oldest dairy breed. It originated from Jersey island adaptable to wide range of climatic conditions and heat. The colour

of the breed ranges from white to dark grey, and it is broken and found as patches. Jerseys are nervous and sensitive animals. Jerseys have good udders with large teats. The lactational yield is 4,950 kg with milk fat 5% . The milk has a characteristic yellow colour because of high carotene content. The bulls are vicious than other breed. Cross breeding of Jersey and indigenous Sindhi and Hariyana produced excellent cross breeds with more than 2000 kg of milk yield per lactation period.



**Fig.6.5. Jersey**

**Common diseases and control :** Cattle are subjected to a large number of diseases. Cattle in normal health appear bright, alert and active in their movements with a shiny coat. They also enjoy normal appetite and sleep. Cattle in ill health appear dull, restless and change posture frequently with a drop in milk yield.

**Contagious diseases :** The diseases which spread easily by various modes are called contagious diseases. These diseases are of bacterial or viral origin. The bacterial diseases are **anthrax, haemorrhagic septicemia, mastitis** and **tuberculosis**. The **viral dieases** are **cow pox, foot and mouth disease** and **rinderpest**.

**1. Anthrax :** Anthrax, a bacterial disease is due to  $\beta$  anthracis which causes sudden death in cattle.

**Symptoms :** High temperature (41-41.5<sup>0</sup>c), swelling of the neck, thorax, flanks and lumbar regions which are neither hot nor painful. Blood discharges from natural openings, the affected animal dies in 10 to 36 hrs.

**Control :** Vaccination with spore vaccine at the age of 6 month and then annually. Affected animals are to be segregated, contaminated place to be disinfected and the carcasses to be burried deep.

**2. Cow pox** is a contagious viral disease attacking cows and buffaloes.

**Symptoms :** Retarded rumination, swelling of udder and teats, rise in temperature, eruptions on skin and udder and teats developing into vesicles, pustules and scabs by stages ultimately leading to mastitis and loss of milk.

**Prevention :** Segregation of affected animal, giving sloppy food for swallowing and digestion, fomenting udder with warm disinfectant solution, giving saline laxative and diuretics, treating lesions with mild antiseptic ointment. Cow shed should be kept clean.

**3. External parasitic diseases :** Common ectoparasites are flies, ticks, mites, fleas and lice. They are directly involved by sucking the blood from cattle and become an irritant. They are also indirectly involved in transmitting bacterial, viral and protozoan diseases.

**4. Internal parasitic diseases :** Hook worm, round worm, tape worm and flukes are some of the intestinal parasites causing diarrhoea, dysentery and some other complications.

**Non-contagious diseases :** The diseases which does not spread by external modes but are caused by physiological or genetical means is known as non contagious diseases.

**1. Milk fever :** Milk fever is common in high milk producing cows and buffaloes during the early part of the lactation. It is due to inability of the animal to assimilate calcium from the feed, leading to demineralization in the bone. The serum Ca and P levels become low and the sugar level gets increased.

**Symptoms :** Staggering, loss of appetite, temperature becoming below normal, pulse rate becoming high, restlessness and become inactive.

**Precaution and first aid :** Feeding jaggery along with lime water, few days prior to calving and giving soft nutritious and easily digestible food for a few days after calving prevents milk fever. Cleaning the udder with warm cloth and preventing infection from the floor. Pumping clean air into the udder and massaging are other measures to be adopted.

**2. Constipation :** Constipation is severe due to over eating of coarse

fibrous roughages, inadequate intake of water and lack of exercise. Which leads to lack of appetite, lack of rumination or chewing and dull appearance.

**Precaution and first aid :** The affected animals can be given wheat bran meal or rice gruel and succulent fodder. Plenty of drinking water with jaggery or salt, evacuating the rectum by giving warm soap water enema and massaging the abdomen are the other measures of treatment.

### **Techniques adopted in cattle breeding**

**A. Out breeding :** Out breeding is mating of less closely related or unrelated animals. The individuals involved do not have a common ancestor in the preceding 4-6 generations.

**B. Cross breeding :** Cross breeding is mating of animals of different breeds. It is valuable as a means of introducing desirable characters into new breed in which they have not existed formerly. The cross breeds exhibit increased growth and vigour by the blend of desirable dominant genes from two breeds in the first generation.

**C. Artificial insemination :** Artificial insemination is the deposition of male reproductive cells (spermatozoa) in the female reproductive tract by mechanical means rather than by natural mating. The semen is collected from the male by artificial means. The semen is inseminated into the female by placing a portion of it either in a collected or in a diluted form into the cervix of the uterus by mechanical methods at the proper time and under most hygienic condition.

It helps to eliminate the need for maintenance of herd sire, permits long distance transport of semen by air, avoids spreading of genital diseases, and increase the rate of conception. Further this method helps better recording, permits use of semen from injured and old bulls and provides a chance of detecting any genital abnormalities or pathological infection and inflammation in cows.

### **Poultry**

The term poultry refers to the rearing and breeding of avian species such as chickens, ducks, turkeys, geese and guinea-fowls which have been

domesticated. They are the best converters of feed into animal protein compared to other livestock. Chickens are the most common poultry enterprises. Chickens alone occupy 90% of the total poultry.

## Breeds

There are more than hundred breeds and more varieties of fowls. The fowls are classified based on their utility to man. They are meat type, egg type, dual type and games and ornamental type. Based on their origin there are four major exotic breeds of fowls. They are American breeds, Asiatic breeds, English breeds and Mediterranean breeds. In addition to the above many of the indigenous breeds are also reared.

### I. American breeds:-

Most of the American breed of fowls are dual purpose forms giving meat and egg. These breeds are characterized by yellow feathers, red ear lobes and many of them lay brown-shelled eggs. **Rhode island reds, Plymouth rock, New hampshire** and **Wyandotte** are some of the important breeds of American class.

*a. Plymouth rock:-* Plymouth rock is the oldest and most popular breed of America. The birds are single combed with long and deep body . The breed produces good sized eggs. The plumage is generally greyish white. The female looks darker in colour than males. This colour feature is used to distinguish the sex of the birds. The females usually have black spots on the shanks.



Fig.6.2.1. Plymouth Rock Hen



Fig.6.2.2. Plymouth Rock Cock

*b. White plymouth:* The white plymouth rock has white plumage throughout the body and it is commonly used in broiler production. Standard weights of cock, 4.3kg; hen 3.4kg; cockerel,3.6kg; pullet, 2.7kg.

## **II. Asiatic breeds:-**

The breeds of this class belong to Asian continent. They are characterised by large body with heavy bones, feathered shanks, red ear lobes and yellow skin. They are used for egg and meat purpose. The egg shells are light to dark brown in colour. The important breeds of this class are Brahma, from Brahmaputra valley in India, Cochin and Langshan are from China.

**Brahma :-** Brahma breed is well known for its massive body with heavy bones, well - feathered and proportionate body. Peacomb is one of important breed character. Light, Dark Brahma are of two common varieties of Brahma .



**Fig.6.2.3. Brahma Hen**



**Fig.6.2.4. Brahma Cock**

**Light Brahma :-** It has light grey to white colour and the hackle feathers are black. The beak and legs are light yellow coloured. Standard weights of light Brahma are, cock 5.4 kg; hen 4.3 kg; cockerel 4.5kg; and pullet 3.6 kg .

**Dark Brahma:-** Dark brahmas are light black or steel grey coloured with greenish hackle. standard weight of dark Brahma are, cock 4.9 kg; hen 3.9 kg; cockerel 4.0 kg; and pullet 3.1 kg.

## **III. English breeds :-**

All the breeds of this class originated from England. Presence of white plumage and pink coloured earlobes are the characters of the breed of this class. Most of them lay brown shelled eggs. Sussex, Orpington, Australorp and Corinsh are some of the important breed of this class.

## **IV. Mediterranean breeds:-**

Breeds of this class originated from European countries which are by

the side of Mediterranean sea. The important breeds of this class, Leghorn and Ancone originated from Italy whereas Minorca originated from Spain. The breeds are light bodied with non feathered shanks. The fowls of this class lay white shelled eggs and they are non-sitters.

**Leghorn:-** The white leghorns are the most popular and commercial breed in India, Colours of plumage may be white, brown or black. The fowls of this breed are small, compact with single comb and wattles. Though the leghorns are adapted to most of the climates, they are thriving well in dry areas. They mature early and they begin to lay eggs at the age of 5 or 6 months. Hence, the breed is economically important and preferred in commercial forms. The standard weight of the cock is 2.7kg; hen 2.0kg; cockerel 2.3kg; and pullets 1.8kg.

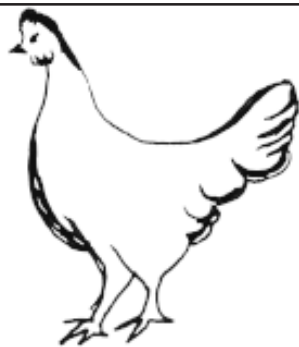

Fig.6.2.5. Leghorn Hen



Fig.6.2.6. Leghorn Cock

#### **V. Indigenous breeds of fowls:**

The common country hen of India is known as 'Desi' which is the best mother for hatching. Some of the Indian fowls resemble the leghorn, but have poor laying qualities. Chitagon, Aseel, Karaknath and Busra are four breeds of indigenous fowl in India.

**a. Aseel:-** Aseel is noted for its pugnacity. The colour of the breed is white or black. The hens are not good egg layers but are excellent sitters. Aseel breed is found in almost all states of India, but abundant in Andhra Pradesh.

**b. Chittagong:-** Chittagong breed is largely found in West Bengal. The plumage colour varies, but the popular shade is golden or light yellow. The beak is long and yellow in colour, the ear lobes and wattles are small and red in colour. They are good egg layers and are delicious.



**c. Karaknath:-** It is a fowl with black flesh. It is abundant in Madhya Pradesh and bred by tribals and the eggs are light brown in colour. The adult plumage varies from silver and gold-sprangled to bluish- black. The comb, wattles and tongue are purple in colour,

**d. Busra:-** This is a small to medium sized bird found in some parts of Gujarat and Maharashtra. They are light feathered with wide variation in body colour.

## **Farming methods**

Poultry farming has now become very popular. It is recognized as an organised and scientifically based industry with tremendous employment potential. It plays an important part in the rural economy of India. It provides a ready source of income to the cultivator. Besides meat and eggs, poultry supplies feathers and rich manure. The following factors are being taken into consideration for the growth of poultry farming 1) small initial investment 2) availability of quality chicks 3) short generation interval 4) quick, assured and better returns compared to other livestock species 5) availability of trained man power 6) better understanding and knowledge of the improved and scientific methods of feeding 7) management and health control.

**Rearing involves the following stages:-** Selection of eggs, incubation and hatching of eggs, brooding or care of new borns, housing of poultry, feeding of poultry are the important steps in rearing of chickens.

**1. Selection of eggs:-** Eggs meant for hatching and rearing must be selected very carefully. The following points should be considered during selection of eggs.

(1) The egg should be fertile (2) Over-sized and small sized eggs should not be selected instead medium sized should be preferred (3) Dark-brown shelled eggs hatch earlier than light-brown shelled eggs (4) Freshly laid eggs are preferred for rearing.

### **2. Incubation and hatching:**

The fertilized hen's egg undergoes development during incubation and hatching processes. The fully formed bird emerges out of egg after a hatching period of 21-22 days. During this period the egg must obtain optimum

temperature, humidity and ventilation etc. The maintenance of newly laid eggs in optimum condition till hatching is called **incubation**.

The incubation is of two types namely **natural incubation** and **artificial incubation**. In the natural incubation method, the eggs are subjected to the care of mother. Only a limited number of eggs can be incubated by a mother hen. In artificial incubation the eggs are maintained in a chamber (incubator) which stimulates the optimum environmental condition. In artificial incubation more number of eggs can be incubated than natural incubation.

**3. Brooding :-** Brooding is the care and management of young chickens for four to six weeks immediately after hatching. Like incubation, brooding also has the natural and artificial methods. In the former, day-old chickens are left to the care of mother and in the latter temperature controlled artificial brooder is used.

***Factors involved in brooding :***

***Temperature :-*** The hatched chicks are kept inside the incubator for about 36 hours and then transferred to artificial brooder. The optimum temperature is 33°C during the first 3 days. During the subsequent weeks of brooding the temperature is reduced by 3°C each week till it reaches 21°C.

***Ventilation :-*** Fresh air movement is important for good health and proper growth of the chicks. Poor ventilation results in the accumulation of carbon monoxide, ammonia and water vapour which may lead to microbial infection.

***Floor space :-*** Adequate floor space is to be provided for the proper development of chicken. Minimum 500sq.cm of floor space per chicken is to be provided. Crowding of chickens leads to poor growth and induces cannibalistic tendencies amongst the birds.

***Litter :-*** The floor of the brood house is layered by beds of hay, rice husk or saw dust and this is called **litter**. The litter bed should be 5 to 7.5cm thick and it must be kept dry.

***Light :-*** To keep the brood house free from infectious germs, the brood house must be well ventilated. Evenly distributed sunlight promotes proper growth of the birds and formation of vitamin D.

**4. Housing of poultry :-** Open sided poultry is popular in our country. The primary objective of providing housing to poultry is to protect them from sun, rain and predators and to provide comfort. Poultry house should be well ventilated. It should be kept cool in summer and warm in winter. The floor of the poultry house should be moisture-proof, rat proof, free from cracks, easily cleanable and durable.

**Poultry feeding :-** Feeding of poultry bird is an important part of rearing. The diet of chickens must contain adequate amount of water, carbohydrates, proteins, fats, vitamins and minerals. The food stuffs such as maize, barley, sorghums, wheat, oil cake, rice etc are to be given in standard requirements.

### **Poultry byproducts**

Poultry and poultry products are highly perishable. Hence, due attention has to be paid to the problems relating to processing, preservation and marketing of poultry and poultry products for the benefit of producers, processors and consumers. In a poultry processing unit, raw materials go as waste in the form of blood, feathers, heads and feet. Hatchery waste includes infertile eggs, dead embryos, and hatchery unstable chicken. Large quantity of wet droppings are also available. Processing and using of this byproducts will not only reduce the cost of poultry production, but also solve the disposal problem and minimize pollution hazard. A great deal of work has been done for processing this by-products into feather-meal, poultry byproducts meal, hatchery byproducts meal, egg shell meal, albumin flake, dried and poultry manure.

**Poultry diseases :** These birds are commonly affected by diseases such as ranikhet, coccidiosis, fowl pox and tick fever.

### **Pisciculture**

Pisciculture or fish culture, included under the broad term 'aquaculture', can be defined as the 'farming and husbandry of economically important fish, under controlled conditions'.

Fish farming is a productive venture. Fishes are highly nutritious sources of easily digestible proteins (rich in lysine and methionine. They are essential amino acids); minerals like calcium, phosphorous, iron, sodium, potassium, magnesium and sulphur; vitamins such as A, D and health promoting fats. Fish are the source of polyunsaturated fatty acids which are

helpful in cholesterol regulation and promoting cardiac health. Fish farming can help in integrated rural development by generating employment opportunities.

## **Fish farming**

### **Definition**

Fish farming is the raising of fish for personal income or profit. Based on the environment in which culture is done, fish farming may be categorized as freshwater fish farming, brackish water fish farming, saltwater or marine fish farming (mariculture).

### **Characters of cultivable fish**

The following criteria should be considered before selecting a fish for farming purpose.

- *Rate of growth* :Fish which grow to a larger size in shorter period are suitable for culture.Eg. Carps.
- *Adaptation to climate*: The cultured species of fish should be able to adapt to the local climatic conditions of the farm.
- *Tolerance*: The fish should have the capacity to tolerate wide fluctuations in the physico chemical conditions such as oxygen, salinity, temperature etc of the water.
- *Acceptance of artificial feed* : When more number of fish is to be accommodated in a limited space, there is the need for supplementary feeding on compounded diets. The fish should show ready preference for these feeds.
- *Resistance*:It is desirable that the cultured fish is hardy enough to resist the common diseases and attack of parasites.
- *Amiability and compatibility*: The fishes proposed to be cultured together ('poly culture') should be able to live together without interfering or attacking the other.
- *Conversion efficiency*: The species of fish which give more edible flesh per unit of food consumed, is preferred.

· *Consumer's preference:* Food preference of people vary with the geographic regions. Hence, the species cultured should be easily marketable locally or to the targeted consumers.

### **Culturable Fishes of India**

Carps, Catfishes, Murrels, Tilapia etc are the main culturable fishes.

#### **Culturable Fishes of India**

##### **Indian major carps**

##### **Carps (Kendai)**

*Catla catla* (Catla)

*Labeo rohita* (Rohu)

*Cirrhina mrigala* (Mrigal)

##### **Exotic (Chinese) carps**

*Cyprinus carpio* (Common carp)

##### **Minor Carps**

*Labeo bata* (Bata)

##### **Catfishes ( 'Keluthi' )**

*Wallago attu* (freshwater shark : 'Valai')

*Mystus aor* (Cat fish)

*Clarias batrachus* (Magur)

##### **Murrels or snake heads ( 'Viral' )**

*Channa striatus* (Striped snake – head)

##### **Tilapia**

*Oreochromis mossambicus* ( 'Jilebikkendai' )

##### **Sport fishes (Cold – water fishes)**

(i) *Trouts* (Order : Salmoniformes)

*Salmo gairdneri* (Rainbow trout)

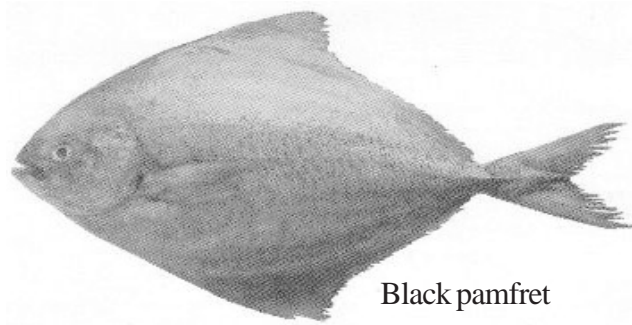

Black pomfret

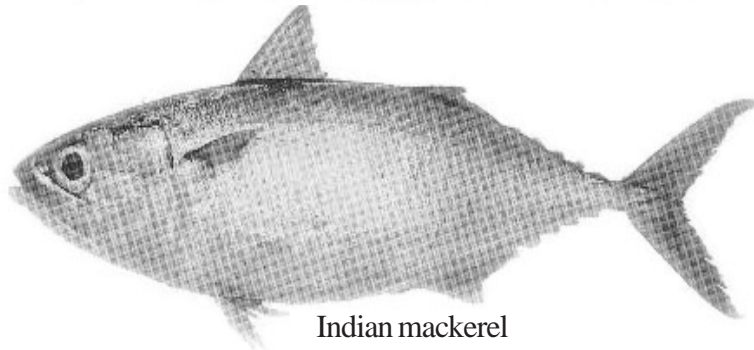

Indian mackerel

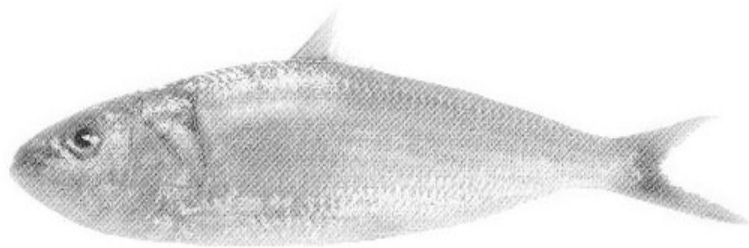

Indian oil sardine

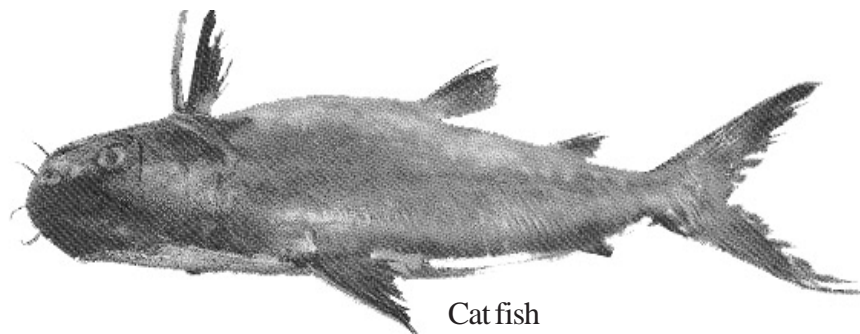

Cat fish

### **Marine fishes**

*Lates calcarifer* (Sea bass or cockup, 'Koduva')

*Mugil cephalus* (Grey mullet, 'Madavai')

*Chanos chanos* (Milk fish) besides these food fishes, there is an enormous potential for the mass culture of a variety of ornamental fishes, which can bring in high profit, also from overseas markets.

### **Fish Pond**

A successful aquaculture practice with a good harvesting is usually due to proper construction preparation and maintenance of the fish pond.

### **Types of fish ponds**

Within the fish farming pond system there can be different pond components, namely nursery, rearing, production, segregation and breeding or spawning ponds. The area percentage of these ponds in a fish-farming complex can be:

Nursery pond	-	3%
Rearing pond	-	11%
Production pond	-	60%
Segregation pond	-	1%
Breeding pond	-	25%

Nursery ponds are shallow, while the others are moderately deep. In larger production ponds, water can be maintained at a depth of 2 and 3 metres. A fencing around the fish farm, may be constructed for protection.

### **Preparation of pond**

Before the culturing of fish, the pond should be conditioned.

### **Conditioning**

A layer of lime (calcium hydroxide) is spread over the bottom, for two weeks. It removes the acidity of the soil, facilitates desirable geochemical cycles and kills unwanted soil organisms.

Water may be let in slowly after two weeks and filled to the desired depth. The quality parameters such as temperature, oxygen content, pH,

turbidity, hardness, alkalinity and plankton growth should be checked for their optimal levels, before stocking the fish.

### **Manuring**

After 15 days of liming, the fertilization is to be done in order to develop the fish food organisms (phytoplankton and the zooplankton: macro and micro). Manure may be of organic or chemical nature. Organic manure may be urine or sewage rich in nitrogenous matter, cow dung, pig dung, poultry manure and plant manure such as green manure, compost, oil cake etc. If the organic carbon is less, cow dung for the stocking pond is applied at the rate of 2-3 tonnes / ha. Poultry manure at the rate of 5000 kg / ha is known to enhance zooplankton induction. Use of chemical fertilizers should vary according to the concentration of phosphorus and nitrogen in the soil. The standard combination of NPK as 18 : 10 : 4 is generally recommended for freshwater ponds. For a production pond of medium fertile soil; urea at the rate of 200 kg / ha / yr or ammonium sulphate at the rate of 450 kg / ha / yr may be applied in split up doses, alternating with organic manure.

### **Management of fish farm**

Feed and water quality are the two major factors governing the productivity of the fish culture pond. Besides, seed quality, stocking and other management measures also determine the extent of fish production.

### **Water quality involves the regulation of**

**Temperature at 25-33°C, dissolved oxygen, pH (6.5 – 9.0 ), hardness, alkalinity, turbidity and plankton culture etc..**

### **Feeding**

Apart from natural food, most cultured species take artificial feeds. In general artificial feed should contain 30-40% protein, 5-10% fat, 50-60% carbohydrate, less than 5% cellulose, 10% water, vitamins and minerals. Animal and vegetable ingredients can be used in formulating feed pellets. Fishmeal, prawn meal, soybean meal, silkworm pupa, wheat, tapioca, slaughter house wastes, rice bran, aquatic weeds, oilcakes etc are



good feed ingredients. Usually Indian farmers give rice bran and oil cakes in powder form to major carps. Carnivorous fishes such as murrels and catfishes may be provided with trash fishes. For adult fish, daily supplementary feeding can be at 2% of its body weight.

### **Routine Management and Diseases**

Analysing water parameters, replenishment of water, aeration, regular feeding, observation for mortality and disease symptoms should be routine checks in the management of aquaculture ponds. Diseases can be of viral or bacterial origin or may be due to ectoparasites or endoparasites.

### **Edible Fishes Of Tamilnadu**

#### **1. Fresh Water Fishes**

Among the freshwater fishes, carps belonging to the order Cypriniformes form significant components of reservoir, riverine and culture fisheries. They have no teeth in any part of their mouths, however pharyngeal teeth may be present.

#### **1. Indian Major Carps ('Kendai' meen)**

a) *Catla catla* (catla) : Catla has a deep body with prominent head, large upturned mouth, non-fringed lips, devoid of barbels and a broad dorsal fin with 14-16 branched rays are the identifying features. It feeds on zooplankton of the pond surface using large gill rakers; however, young ones (15-20 mm) feed on zooplankton and phytoplankton. It grows to a

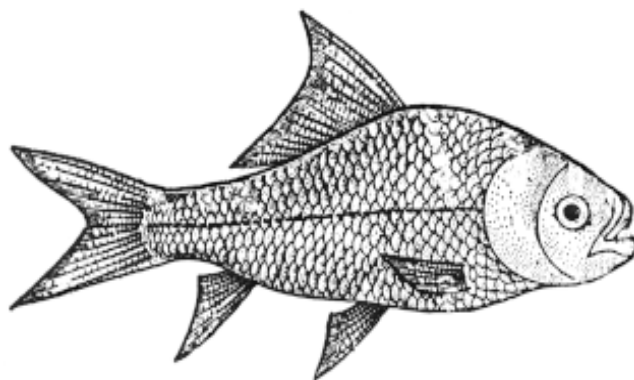

**Fig. 6.3.3. Catla catla**

maximum size of 1.8 m (45 kg). It is a fast growing species among the Indian major carps. First year growth is 35-45 cm and about 1.5 – 2.0 kg. It matures in the second year.

b) *Labeo rohita* (Rohu) : Of all the carps, this is considered as the tastiest fish. It has a small and pointed head, terminal small mouth with fringed lower lip. A dorsal fin with 12-13 branched rays and full reddish scales are its identifying features. It is a column feeder on phytoplankton, plant debris or decaying debris of aquatic plants; however, the young ones feed on zooplankton. The maximum size attained is 1m. It is fairly fast growing species and first year growth is 35 – 40 cm and 900 g.

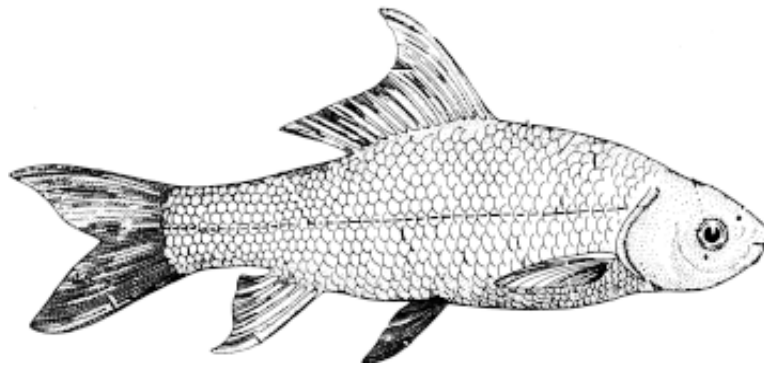

**Fig. 6.3.4. Labeo rohita**

c. *Cirrhina mrigala* (Mrigal) : A linear body small head with blunt snout, subterminal mouth with thin non-fringed lips, dorsal fin with 12-13 branched rays and a bright silvery body having golden tinge are its identifying features.

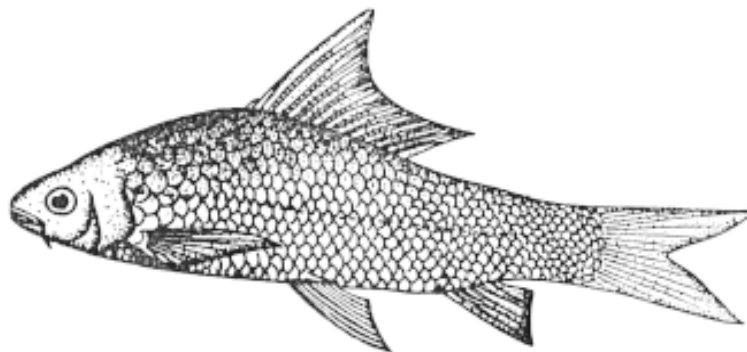

**Fig. 6.3.5. Cirrhina mrigala**

It is a bottom feeder on decaying organic and vegetable debris; however, its young feed on zooplankton. The maximum size attained is 0.9 m. Its growth in the first year is about 30 cm (700 g).

**(iv) Catfishes (Order: Siluriformes-‘Keluthi’)**

The catfish are air-breathing, or live-fishes as they are capable of directly breathing atmospheric air. They can live for a long time without water and can therefore be transported live and in fresh condition over long distances. The body is without scales and each of the upper and lower jaws possesses two pairs of long barbels in each. The mouth is non-protractile having jaws with teeth. Majority of the catfish are predatory and cannibalistic, feeding on all pond animals including fish fry.

**v. Murrels or Snakeheads (Order : Channiformes-‘Viral’ meen)**

These fish are also air-breathing and have a good demand. Elongated and cylindrical body, depressed head, large and protractile mouth are its identifying features. Murrels are suitable for culture in irrigation wells and shallow swamps.

a) *Channa marulius* (Giant snakehead) : Dorsal and anal fins of this species are long and without spines. It reaches a maximum size of 1.2 m. It is suitable for culture in ponds along with tilapia, the young ones of which serve as food source to this species.

b) *C.striatus* (Striped snake-head or Common murrel) : Stripes are present on its body. Attains a maximum size of 90cm.

**vi. Tilapia (Order : Perciformes)**

a) *Oreochromis mossambicus* (Tilapia -‘Jilabi’ kendai) : An exotic fish introduced in India from East Coast of Africa in 1952. It is characterized by an anterior spinous dorsal fin and posterior soft dorsal fin. Maturity occurs even in two months old individuals. It breeds nearly eight times in a year. Female keeps the fertilized eggs guarded in its mouth.

**II. Brackish water Fishes**

Brackish water fishes spend most of its life in river mouths (estuaries) back waters, mangrove swamps and coastal lagoons. These are

*Chanos Chanos* (Milk fish), Grey mullets ('Madavai'), *Pearl spots* ('Kari'meen), Seabass ('Koduva'), The Seabreams.

### III. Marine Fishes

Marine edible fishes of Tamilnadu coast include both cartilaginous and bony fishes.

#### Elasmobranchiata

Cartilaginous fishes are the sharks and skates.

**Bony Fishes** are

i) Pomfrets ('Vavva'): ii) Indian Mackerel ('Kanangeluthi') : iii) Seer fish ('Vanjiram' or 'Neimeen'): iv) *Carangids* ('Para' meen):(v) Ribbon fishes: (vi) Catfishes ('Keluthi'): (vii) Flat fishes ('Naakku meen'):(viii) Sardines ('Maththi meen').

### Medical Lab Techniques

In medical therapeutics both diagnosis and treatment are the two important vital aspects. Diagnosis involves identifying or determining the nature of disease while treatment involves the curative aspects in order to eliminate the disease causing agent. The clinical laboratory tests help a physician in correct diagnosis and treatment.

#### 1. Stethoscope:

A stethoscope is used to hear the heart beat sounds, sound due to inhalation and exhalation of air in the lungs and the respiratory pathways and



Fig. 6.4.1. Stethoscope

also the stomach movement. It is a very useful diagnostic tool to help localize problems and to diagnose disease. Stethoscopes are also used along with the sphygmomanometer. The first usable binaural stethoscope was invented in 1855. The modern electronic stethoscopes are high precision instruments. These can be used to hear a patient's heart and lung clearly even in high noisy environments and even through layers of clothing. The electronic stethoscopes also make it possible to hear the foetal sounds in mother's womb.

### Uses:

1. Stethoscope helps to find normal (lub-dub) versus abnormal heart sounds (heart murmurs) and also to diagnose valve functions.
2. Stethoscopes can indicate fluid in lungs in case of pneumonia and pulmonary edema. It can diagnose airway diseases like bronchitis and pleuritis.
3. Stethoscopes are also used to compare the movements in the normal versus overactive or underactive intestinal tract.

### 2. Sphygmomanometer:

A sphygmomanometer is an instrument used to measure blood pressure. The word is derived from the Greek *sphygmus* (pulse) plus the scientific (physical) term manometer.

Arterial blood pressure is the force of pressure, which the blood is exerting on the walls of the blood vessels in which it flows. The blood pressure in the artery varies during the cardiac cycle. The cardiac cycle is defined as the cycle of events that take place during one systole and diastole of the heart. Systole refers to contraction and diastole the relaxation. During ventricular systole, when the left ventricle is forcing blood into the aorta the pressure rises to a peak which is referred to as **systolic pressure**. During diastole the pressure falls and the lowest value reached is referred to as **diastolic pressure**.

The blood pressure depends partly on the force and volume of blood pumped by the heart and partly on the contraction of the muscles in the walls

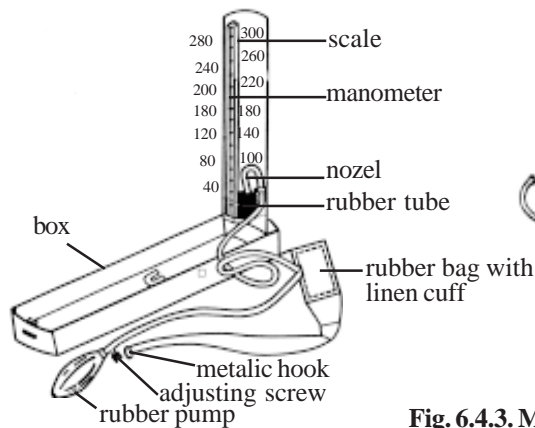

**Fig. 6.4.2. Sphygmomanometer**

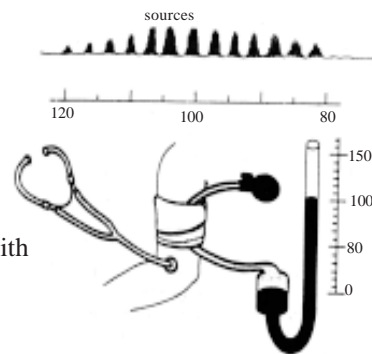

**Fig. 6.4.3. Method of measuring blood pressure**

of the arterioles. Blood pressure changes during physical exercise, during anxiety and emotion and in sleep etc. However a prolonged or constant elevation of blood pressure, a condition known as hypertension can increase a person’s risk for heart attack, stroke, heart and kidney failure and other health problems. It is always suitable to measure blood pressure when a person is in a relaxed and in resting condition.

The normal blood pressure value is 120/80 mm Hg, in which ‘**120**’ denotes the **systolic pressure** and **80** the **diastolic pressure**.

There are two types of sphygmomanometer viz., Monometric type and 2. Digital (modern) type.

**Uses:**

1. Sphygmomanometer helps to estimate the state of blood circulation and the working of heart.
2. Sphygmomanometer helps to diagnose pathological conditions such as hypertension (increased BP) and hypotension (reduction in BP).

**Haemocytometer**

The counting of blood cells after proper dilution is known as haemocytometry and the instrument used to count the blood cells is called haemocytometer. Using haemocytometry method, red cells, platelets and

eosinophils are often counted. Now-a-days it is also used for counting cells of bacteria, yeast, or algae.

### Haemocytometer - instruments description

A haemocytometer consists of a counting chamber, a coverglass for the counting chamber and diluting pipettes. Many types of counting chambers are available. Improved Neubauer and Fauchs Rosenthal are the two most commonly used counting chambers in laboratories.

RBCs and WBCs in blood cannot be counted as such. The blood has to be diluted in specific isotonic solutions. RBC, diluting fluid is called Hayem's solution. For WBC counting Turk's solution or Toisson solution can be used.

The total number of cells is expressed per  $\text{mm}^3$ . The isotonic diluting fluid keeps up the cells intact. In WBC counting, the solution will lyse the red blood cells and the remaining nucleated WBCs are counted. Venous blood is used in blood cells counting.

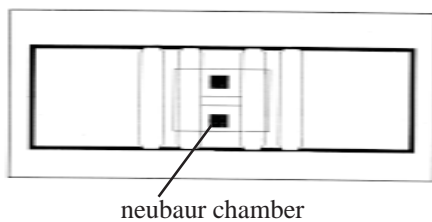

Fig. 6.4.4. Counting chamber front and side views

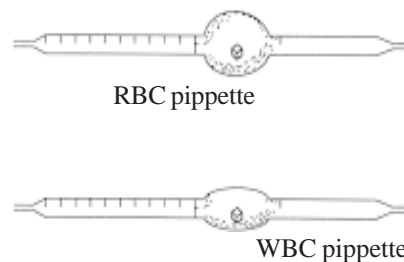

Fig. 6.4.5. RBC & WBC counting pipettes

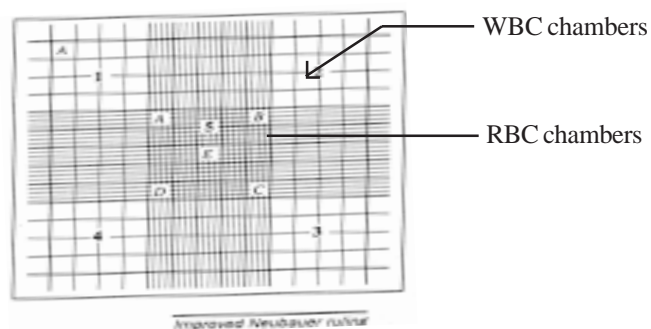

Fig. 6.4.6. Counting chambers

Normal Range of RBCs in human is as follows :

Men : 4.5 - 5.9 million/mm<sup>3</sup>

Women : 4.1 - 5.1 million/mm<sup>3</sup>

At birth : 4.0 - 5.6 million/mm<sup>3</sup>

Normal Range of WBCs in human is as follows :

Adults : 4,500 - 11,000/mm<sup>3</sup>

Neonates : 10,000 - 25,000/mm<sup>3</sup>

Clinical significance :

1. Decrease in the number of circulating erythrocytes indicates anaemia.
2. An increased number of erythrocytes indicates the possibility of polycythemia.
3. An increase in WBC count for a transient period indicates bacterial infection.
4. Progressive increase in abnormal WBC count indicates the possibility of leukemia.

#### **4. Urine - Sugar analysis**

The examination of urine (physical, chemical and microscopic) is called **Urinalysis**. It provides a valuable picture of the general health pattern of a patient. Urinalysis is usually done to

- (i) find out the state of the kidneys and the urinary tract, and
- (ii) gather information about metabolic and systemic abnormalities.

To diagnose metabolic and systemic disorders such as **diabetes** and **jaundice**, tests for glucose, ketone bodies, bilirubin and urobilinogen should be carried out.

#### **Collection and preservation of Urine**

Urine is mainly composed of 95% water, and the rest being made of urea, uric acid, creatinine, sodium, potassium, chloride, calcium, phosphates etc. It must be collected in a clean, dry container and examined as soon as possible. For testing glucose, urine collected 2 to 3 hours after food is suitable.



## Sugar Analysis

Sugars are generally known as reducing substances because they can reduce a heavy metal, such as copper, from a higher to a lower oxidation state for example, the reduction of blue cupric sulphate to red cuprous oxide. Glucose, lactose, fructose, galactose, pentoses, sucrose etc., are the reducing substances found in urine. Even though there are many reducing substances in the urine, estimation of glucose is important, as it indicates the hyperglycemic condition.

## Significance of Glucose

Glucose is present in trace amounts in normal urine. In the kidneys, glucose is filtered by the glomeruli and reabsorbed by the tubules. Above a certain limit the tubules cannot reabsorb all the glucose. The surplus glucose appears in urine and this condition is known as **glycosuria**. When **glycosuria** is detected and hyperglycemia (excess glucose) is established, the chronic disorder, **diabetes mellitus** is indicated. In this condition as much as 280 milli moles/ L of glucose can be found in urine. It indicates disturbances in carbohydrate, lipid and protein metabolism.

Urine glucose is tested both qualitatively and quantitatively. Benedict's test is the qualitative test to indicate the presence or absence of sugars. Different types of quantitative tests, each of them based on some principle are also employed to quantify the urine sugar content. Some of them are Benedict's reagent method, glucose oxidase method, o-toluidine method etc. Thin layer chromatography is considered a superior method for identification of urine sugars. Recently, digital glucometer is in usage for instantaneous determination of blood glucose levels.

## 5. ECG-Electrocardiogram

The electrocardiogram (ECG) is a record of the electric potential changes that occur in the heart during the cardiac cycle. It is recorded from the surface of the body. The instrument used to record the **ECG** is called Electrocardiogram. The waves of the ECG are due to depolarization and not due to contraction of the heart. This wave of depolarization occurs first before the contraction of the cardiac muscle begins.

The electrical activity of the heart was first recorded by Waller in 1887 with a capillary electrometer. But the work of Einthoven who recorded the ECG with a strong galvanometer only led to the development of modern electrocardiography. Einthoven was awarded Nobel Prize in 1924.

A normal ECG is composed of five waves designated from left to right with the letters P, Q, R, S and T. P, R and T are normally upward or positive waves while Q and S are downward or negative waves.

### ECG-'PQRST' wave

When the cardiac impulse (originating in sinus node which is the primary pace maker) passes through the heart, electrical currents spread in the tissues surrounding the heart. A small amount of this current spreads to the surface of the body. If electrodes are placed on the skin on opposite sides of the heart, electric potentials generated by these currents can be recorded. This recording is known as electrocardiogram (ECG or EKG).

**P.Wave: It occurs in the auricles.** It is an atrial wave. It is due to the spread of depolarisation in the atria (auricles). Its duration is 0.1 second and it occurs just before the atrial systole. Its amplitude is about 0.1 to 0.3 mv. The cardiac impulse reaches the sinu-auricular node at about the summit of the P wave. The P wave is a guide to the activity of atria.

### Q,R, and S Waves

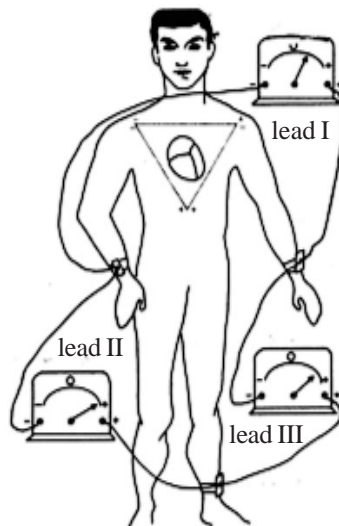

Fig. 6.4.7. Man with ECG leads attached

After the completion of P wave, the isoelectric interval occurs. Following this, QR and S waves begin. Q wave is a small negative downward deflection. It is mostly indistinct. It represents atrial septal depolarization. R wave is a prominent positive wave and S wave is a small negative wave. R and S are due to depolarization of the ventricular muscle. The duration of the QRS complex is about 0.08 second and usually does not exceed 0.1second. The average amplitude to R wave is about 1 mv. Lot of diagnostic information can be gained from alteration in the QRS complex.

### T wave

Following S wave there is an isoelectric interval. T wave begins after that. It is due to ventricular repolarization. It is a broad wave. Its average duration is about 0.27 second and amplitude 0.15 to 0.5 mv.

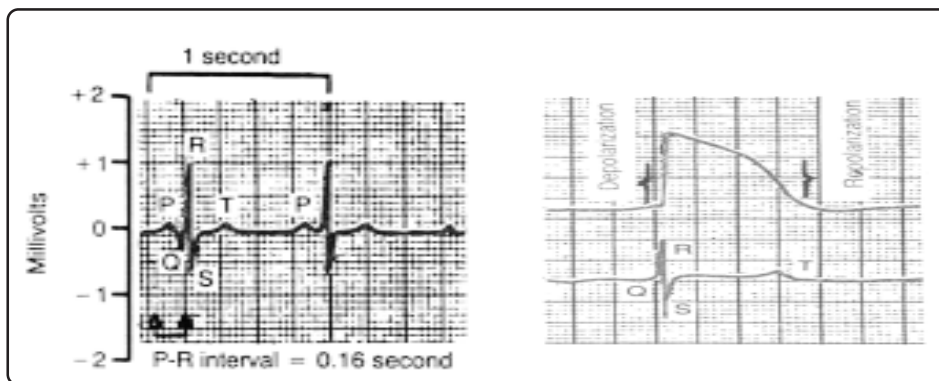
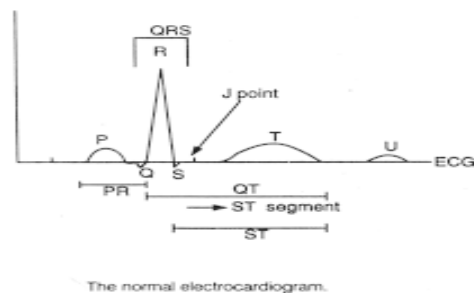

Fig. 6.4.8. Graph of ECG



The normal electrocardiogram.

Fig. 6.4.9. Normal ECG

## **6. Computed Tomography (CT)(OR) Computerized axial tomography (CAT).**

The imaging technology or machine vision has revolutionized the medical world. It enables the doctors to watch vital organs, identify blockages and growths and diagnose signs of diseases without doing surgery.

### **Computed tomography scan or (CT) scan :**

Computed Tomography (CT) or “CAT scanning” combines the use of a digital computer together with a rotating X-ray device to create detailed cross sectional images or “slices’ of the different organs.

### **Advantages of CT over other imaging techniques**

Among the various imaging techniques CT has the unique ability to image a combination of soft tissue, bone, and blood vessels. For example, conventional x-ray image of the head can only show the dense bone structures of the skull. X-ray angiography of the head depicts only the head and neck and not the soft brain-tissue. Magnetic resonance (MR) imaging does an excellent job of showing soft tissue and blood vessels, but MR does not give as much details of bony structures such as the skull. CT images of the head allow physicians to see soft-tissues, anatomic structures like the brain’s ventricles, of grey and white matter. **CT can provide detailed cross sectional images and diagnostic information for nearly every part of the body.**

### **Uses of CT.**

1. CT is an invaluable tool in the cancer diagnosis process and is often the preferred method for diagnosing lung, liver and pancreas cancer.
2. CT imaging and CT angiography are finding a greater role in the detection, diagnosis and treatment of heart disease, acute stroke and vascular diseases, which can lead to stroke, gangrene or kidney failure.
3. CT can be used to measure bone mineral density for the detection of osteoporosis.

4. CT has excellent application in trauma cases and other internal bleeding in patients.

5. CT is used extensively for diagnosing problems of the inner ears and sinuses. The anatomy of the inner ear and sinuses is made up of delicate soft tissue structures and very fine bones. CT is excellent for imaging tumors or polyps in the sinuses and disease that cause degeneration of the small bones in the inner ear.

6. CT has been the basis for interventional work like CT guided biopsy and minimally invasive therapy. CT images are also used as basis for planning radiotherapy cancer treatment. CT is also often used to follow the course of cancer treatment to determine how the tumor is responding to treatment.

## **7. Endoscopy (Laproscopy) techniques**

Endoscopy is a method of examining the interior of a body cavity or hollow organ (e.g., oesophagus, stomach) using an endoscope, a narrow, flexible fiber optic instrument that conducts light. Until recently, surgery was the most traditional of medical practices, employing techniques and instruments developed more than a century ago, but now patients have a new choice.

Endoscopy is a minimally invasive approach to surgery of various parts. It accomplishes traditional surgical goals while delivering less pain, faster recovery, and happier patients. The procedure does not require hospital admission and acute care and observation and may be performed outside the premises of a hospital. Outpatient procedures performed at hospitals or ambulatory centers allow the patient to go home or return to work within a short period while after endoscopic diagnosis.

### **Types of Endoscopy**

**1. Bronchoscopy: (trachea and lung's bronchial trees)**

**2. Colonoscopy: (colon and large intestine)**

**3. Colposcopy: (vagina and cervix)**

**4. Cystoscopy: (bladder, urethra, urinary tract, uterine orifices, and prostate (men))**

**5. Gastroscopy: (Oesophagus, stomach, and intestine)**

**6. Laryngoscopy: (larynx or voice box)**

**7. Proctoscopy: (rectum and sigmoid colon)**

**8. Thoracoscopy: (pleura, pleural spaces, mediastinum, and pericardium).**

**9. Laparoscopy: (stomach, liver and other abdominal organs including the female reproductive organs, for example, the fallopian tubes.)**

**10. Arthroscopy: (joints such as knee)**

#### **8. Artificial Pacemaker**

A pacemaker is a small, battery-operated electronic device, which is inserted under the skin to help the heart to beat regularly and at an appropriate rate. The purpose of an artificial pacemaker is to stimulate the heart when either the heart's natural pacemaker is not fast enough or if there are blocks in the heart's electrical conduction system, preventing the propagation of electrical impulses from the natural pacemaker to the ventricles.

#### **Natural Pacemaker of heart**

The sinus node (sinoatrial node), (1.5 cm long, 3mm wide muscle), situated on the right wall of the right atrium (auricle) where cardiac impulse is initiated. It is known as the natural pacemaker of mammalian heart,

#### **Components of an Artificial Pacemaker**

A pacemaker generally has two parts, the generator and the leads. The generator contains the battery and the information to regulate the heartbeat. The leads are wires that go from the generator through a large vein to the heart, where the wires are anchored. The leads send the electrical impulse to the heart to tell it to beat. **Most pacemakers run on lithium batteries.** The battery can last for 7-8 years. It will be routinely monitored

by health care professional and replaced when necessary. **The generators have become smaller over the years and often weigh less than 30 grams.**

### **9. Autoanalyser**

To assist in the diagnosis of diseases and disorders and to monitor therapy, a wide range of clinical tests has been developed. The demand for investigations is growing with the growing population and diseases. To get fast results on a large number of specimens, it is becoming inevitable to replace manual methods. This could be done by **autoanalysers**. With help of autoanalysers an increased work load can be processed rapidly and with reproducible results. To maintain the quality of results, standards (samples of Known values) will be run along with every batch of test samples.

#### **Advantages of an autoanalyser :**

1. Accuracy is more when compared with manual method.
2. Large number of samples may be processed in minimal time.
3. Two or more assays may be performed simultaneously.
4. Calculations are not required.

#### **Disadvantages of an autoanalyser :**

1. It is impractical for small number of specimens.
2. Instruments may fail occasionally.
3. Additional training of the staff about the working, maintenance and potential problems of the machine is needed.
4. They are expensive.

#### **parameters to be analysed by an autoanalyser**

Autoanalyser can be used to estimate parameters such as glucose, protein, albumin, creatinine, blood urea nitrogen (BUN), sodium, potassium, chlorine, transaminase, lactic dehydrogenase, bilirubin, inorganic phosphate, calcium, cholesterol, uric acid, phosphatases and bicarbonate.

## Apiculture

Honey bees are social and polymorphic colonial insects. Honey bees provide honey, a high energy food supplement and wax which has almost unlimited uses. Cultivation of bees on a commercial scale for the production of honey is called **apiculture** or *bee keeping*. The beekeeping has been in practice for a very long time in India. Knowledge of biology, behaviour, diseases of bees and management practices are essential for beekeeping. Beekeeping is one of the more universal agricultural endeavours. Bees work a dual agricultural role by both producing honey and aiding in the pollination of flowering crops. Their cosmopolitan distribution, multipurpose nature and relative simplicity in management combine to make bees a natural agricultural supplement for many types of farm system in developing countries.

### *Advantages of beekeeping*

The advantages of beekeeping are: (1) It requires relatively low technology requirements (2) beekeeping basics are easy to master (3) low initial costs for set up (4) men, women, elderly and youth can participate (5) provides employment and self-esteem, (6) There is opportunity for quick return on investment (7) minimal land requirements (8) environmentally acceptable farming practice (9) promotion of greater viable food crop yield through bee pollination and (10) most bee products have a long self life and are a valuable food source.

### **Types of Honey Bee**

Honey bee belongs to the class Insecta, order; Hymenoptera and family; Aphidae. There are five well recognised types of bees found in the world.

1. *Apis dorsata* (Rock bee)
2. *Apis florea* (little bee)
3. *Apis indica* (Indian bee)
4. *Apis mellifica* (European bee)
5. *Apis adamsoni* (Africa)

Out of these five types, *Apis dorsata*, *Apis florea* and *Apis indica* are common in India.



### **Apis dorsata :**

It is commonly called rock bee. It is a large Indian variety with an average size of about 20mm. It builds large comb (0.90 x 15metres) on tree branches, under caves, or under roofs of high buildings. *A. dorsata* undertakes migration during summer and winter. During winter they are abundantly found in plains and in summer the colonies migrate to high mountains to avoid extreme heat or in search of flowering plants. This species is a good honey gatherer. A sizable portion of honey produced in India comes from *A.dorsata* species. Maximum 50 to 80kg honey per colony can be obtained.

### **Apis florea**

It is commonly called little bee. It is a miniature form of the rock bee. It lives in plains and it rarely occurs above 1000 feet of sea level. It builds small comb on the branches of trees, or in bushes, or under the walls of the buildings. The yield of honey from this species is very little.

### **Apis indica**

It is popularly known as the Indian bee. It occurs commonly on the plains and forest of India. It builds several parallel combs in protected places like hollow of trees, caves, in rocks and in other such cavities. Their average output of honey is between 3kg to 5kg per colony per year. They are the best of the Indian variety to be hived in artificial conditions.

### **Castes of Honey Bee**

Honey bee is a social insect. The nest of the honey bee is known as bee-hive. A hive in summer consists of 32 to 50 thousands individuals, depending on the locality. The members of honey bees are of three castes namely the **queen bee**, the **worker bee** and the **drone bee**. All the three types depend on each other for their existence. There is normally one queen, 10,000 to 30,000 workers and few hundred drones in a colony.

### ***Queen Bee:***

There is only one **queen** in a honey bee colony. Queens are fertile females formed from a fertilized egg. It is slightly larger than a worker bee, with a longer abdomen. It does not have pollen baskets on her legs. Eggs

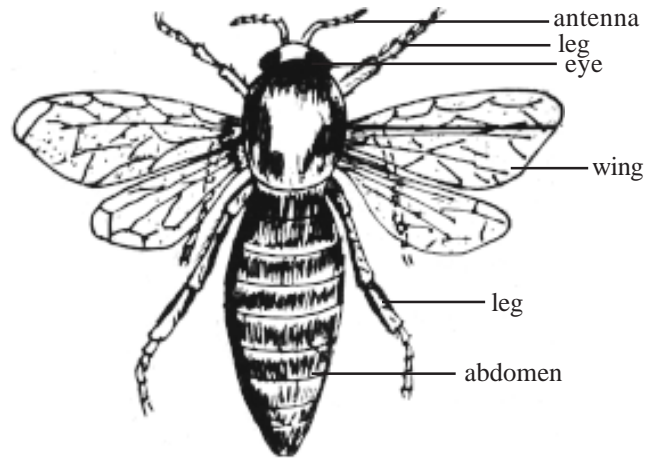

**Queen**

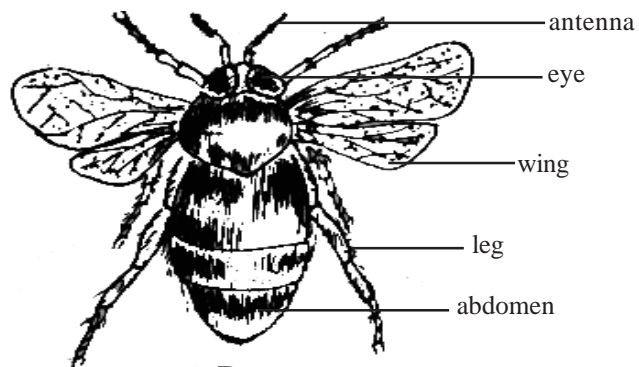

**Drone**

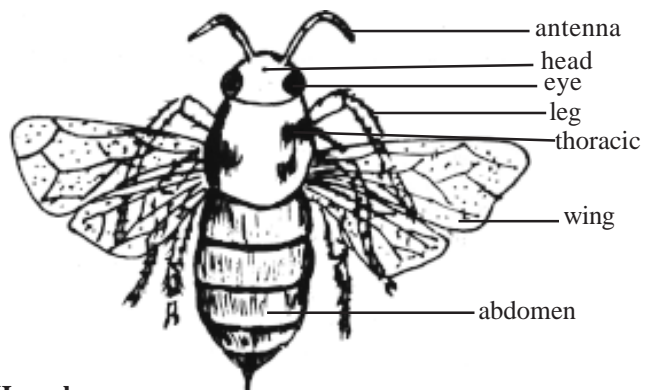

**Worker**

**Fig.6.30. Honeybees**

destined to become queens are laid in a larger cell, and the larvae are fed only royal jelly. The **royal jelly** (bee milk ) is a salivary secretion of the worker bees. The adult queen's sole duty is to lay eggs, up to 2,000 a day. It is fed by the workers and never leaves the hive except to mate. Queen bees also have stings and use them in battles with each other for dominance of the colony. The life span of queen bee is 3-4 years. When the colony is crowded with adult bees, the queen leaves with a set of workers to establish new colonies and to promote propagation. This natural phenomenon is called **swarming**.

#### ***Drones Bee :***

Drones are haploid fertile male because they develop parthenogenetically from unfertilized eggs. They are larger than workers and smaller than queen. They are quite noisy and unable to gather food. They are stingless and their sole biological function is to mate with queen. The number of drones in a colony varies from 200-300 but during unfavourable season they are driven out.

#### ***Worker Bee :***

The vast majority of adult honey bees in any colony are female **worker** bees. The worker bees are sterile females. They have no individual existence throughout her life. They labours for the betterment of the colony. The functions of the worker bees are: tending and feeding young bees (larvae), making honey, making royal jelly and beebread to feed larvae, producing wax, cooling the hive by fanning wings, gathering and storing pollen, nectar and water, guarding the hive, building, cleaning and repairing the comb, and feeding and taking care of the queen and drones.

#### ***Life cycle :***

The virgin queen bee mates once in her life. During breeding season of winter, a unique flight takes place by one queen followed by several drones. This flight is called "**nuptial flight**". The queen bee also produces a hormonal chemical substance called a pheromone. The drones in that area are attracted to the pheromone and then mating takes place. After mating she returns to the hive and lays eggs. Honey bees pass through four distinct

life stages namely the *egg, larva, pupa* and *adult* through metamorphosis. On the first day, the queen bee lays a single egg in each cell of the comb. The egg generally hatches into a larva on the fourth day. The larva is a legless grub that resembles a tiny white sausage. The larva is fed with a mixture of pollen and nectar called **bee bread**. However, the queen forming larvae are fed on royal jelly for full larval life and they are taken for further development into a special chamber called queen's chamber. On the ninth day the cell is capped with wax by worker bees. Inside the cell larva spins a delicate silken cocoon around itself and the larva transforms into a pupa. The pupa is a physical transition stage between the amorphous larva and the hairy, winged adult. The pupa doesn't eat. Ultimately the adult comes out of cocoon. The queen, worker and drone bees take 16, 21 and 24 days respectively for their complete development.

***Structure of a bee comb***

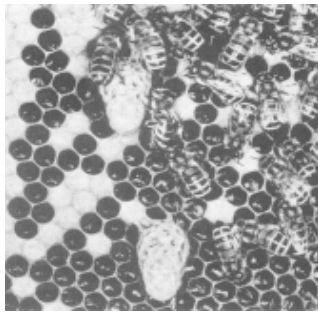

**Honey Comb with worker bees**

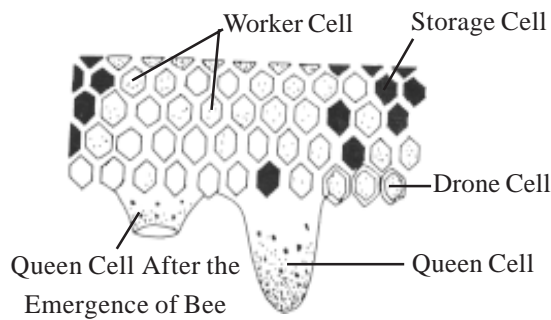

**A portion of the honey comb**

**Fig.6.31. Honey comb**

The comb of the bees are formed mainly by the secretion from the wax glands present in the abdomen of the worker bees. A comb is a vertical sheet of wax, with a double layer of hexagonal cells. The wax is masticated and mixed with the secretions of the cephalic glands to convert into a plastic resinous substance. The resinous chemical substance present in the wax is called **propolis** which is derived from pollen grains.

The cells of the comb are of various types. The '**storage cells**' contains honey and pollen. They are built in the margin and at the top of the comb. The **brood cells** contains the young stages of the honeybees and they are built in the centre and the lower part of the comb. Young ones of honey bees are collectively called brood. Brood chamber is divided into three types they are

Worker-chamber : to rear the worker larvae developing into workers

Drone chamber : to rear the drone larvae developing in to drones.

Queen -chamber : to rear the queen larva developing into queen.

There is no special chamber for adults except queen. They move on the surface of the comb.

#### **Modern bee-hive structure**

Scientific method of bee - keeping has been developed after the extensive studies of bee behaviour, their way of functioning and their mode of reproduction.

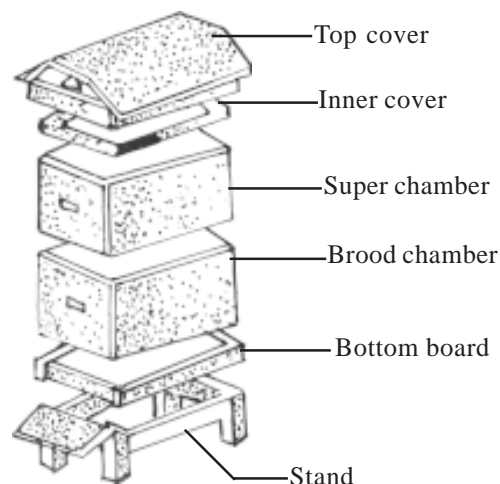

**Fig.6.32. Outer view of a two-storey langstroth frame hive**

Shelter made artificially for the bees to set up colonies is called **bee-hive**. The hive space must be large enough for passage of bees and smaller enough to discourage comb building.

The modern beehive is movable-frame hive. It is a wooden frame box made of single or double walls. The single walled wooden frame box is used in warm place and the double walled wooden frame box is used in cool climate. A modern hive consists of a **bottom board, brood chamber, supper chamber, inner cover and top cover**. They are placed one above the other and fixed on a stand. All these parts can be dismantled. The **bottom board** acts as the entrance for the bees. The **brood chamber** is a wooden box inside which numerous frames called “**comb foundations**” are fixed. Comb foundations consist of sheets of pure bee wax. This wax sheets are embossed with the pattern of hexagons of a size equal to the base of natural brood cells. The worker bees secrete wax to extend the walls of these cells. The comb foundation helps in controlling the rise of the cells and reduces the number of drone cells. These frame of comb are movable and can be lifted, hence the name for the hive as “movable frame hive”.

The chamber above the brood chamber is the **super chamber** inside which honey is secreted and stored. Queen is prevented from entering this chamber by using queen excluder. This equipment has narrow spaces of 4mm which allows only the workers to enter the super chamber. The wooden board to cover the brood chamber or the super chamber is called **inner cover**. The **top cover** can be lifted to inspect the state of the colony or honey formation. The wooden hive is coloured yellow or white on the outside for keeping the chambers cool and to aid easy recognition by the bees.

In India, apart from the modern hive, another three types of beehive namely *Langstroth*, *Newton* and *Jeolikote* are in practice.

#### ***Other hive equipment :***

Besides the above primary equipments, other accessory equipments used in beekeeping and their utility are as follows.

1. Queen Excluder - it is utilized to prevent the entry of queen bee from the brood chamber into the super chamber.

2. Comb foundation - it is a sheet of bee wax and on both sides of which exact shape of different cells of the comb is made in advance.
3. Bee gloves - it is used by bee keepers for protecting their hands while inspecting the hives.
4. Bee veil - it is a device made of fine nettings to protect the bee-keeper from bee sting.
5. Smoker - it is used to scare the bees during hive maintenance and honey collection by releasing smoke.
6. Hive Tool - it is a flat, narrow and long piece of iron which helps in scraping excess propolis or wax from hive parts.
7. Uncapping knife - it is a long knife which helps in removing the cap from the combs as a first step in honey extraction.
8. Bee brush - it is a large brush often employed to brush off bees from honey combs particularly at the time of extraction.
9. Queen introducing cage - it is a pipe made of wire nets used for keeping the queen for about 24 hours for acquaintance with the hive and worker bees.
10. Feeder - it is a basin with sugar syrup covered by grass to feed the bees during drought season. The grass prevent the bees from sinking in to the syrup.
11. Honey Extractor - it is a stainless steel device which spins the combs rapidly to extract honey.

12.Hive Entrance Guard - it is a device similar to queen excluder in front of the hive entrance which prevents the escape of queen during warming season.

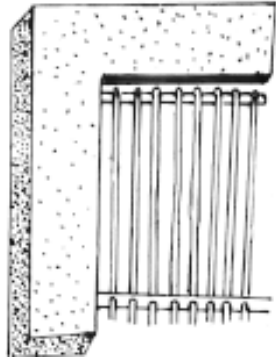

Fig.6.33. Queen excluder (Waldron)

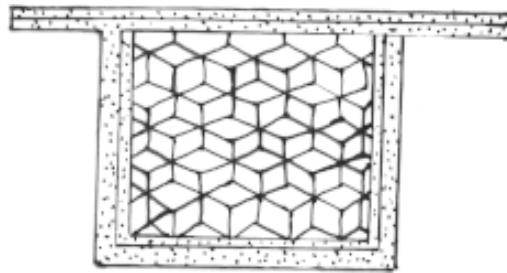
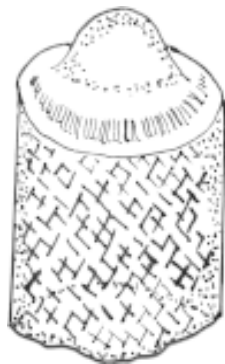

Fig.6.34. Comb - foundation fixed in a frame



Bee veil



Bingham smoker



Hive tool



Uncapping knife

Fig.6.35. Hive equipments



### **Bee hive products :**

Some of the hive products are used for Apitherapy. The Apitherapy is the use of products from the bee to promote health and healing.

**Honey** : Honey has been treasured as one of the nature's most perfect food. Other than honey, the products such as **bee wax, bee venom, propolis, royal jelly** and **pollen** are obtained as bee hive products. It is a sweet, viscous edible food obtained by honey bees. The colour, flavour and odour of honey usually depend on flowers from which nectar is gathered. It is an energy rich nourishing food.

### **Chemical composition of honey**

The honey is composed of water, sugar, mineral like calcium, iron, phosphate, manganese and vitamins. Honey also contains acids, amino acids, enzymes, pigments and aroma substances. Besides, honey is an antiseptic and contains formic acid as the preservative. Honey is also used in all Ayurvedic and Unani Medicines. Honey is a good laxative and a blood purifier. It prevents cough and cold and also relieves sore throat. Honey is a remedy for tongue ulcer and intestinal ulcer. Honey is made into alcoholic drinks by fermentation. These drinks are popularly known as **mead** or honey **wines**. Large amounts are used in skin and beauty lotions.

**Bee wax** : Wax derived from bee hive are utilised as follows:

1. Bee wax is used in candle industry and bee industry for preparing comb foundation sheets.
2. Wax is an important constituent of cosmetics like cold creams, lipsticks and rouges because it adheres better to skin.
3. Pharmaceutical and perfume industries are also major users of wax.
4. It is also used in ointments, capsules, pill coatings and deodorants.
5. Wax is used for preparing shoe polish, furniture, etc. because it acts as water proofing.
6. Its minor use is made in adhesive, chewing gums ink etc.

## **Bee Venom**

Sting of worker bee is attached to a poison sac where venom is stored. It is composed of many substances such as histamine, apamine, acithinase, hydrochloric acid, formic acid, orthophosphoric acid, sulphur, calcium, copper and magnesium sulphate.

1. Apitherapy : Bees can be made to sting the patient who has skin disease and the venom collected can be used as medicines for subcutaneous infections.
2. Ointment made by mixing apitoxin, vaseline and salicylic acid can be used to make the skin soft and increases penetration.
3. Bee venom is useful for curing many diseases and disorders especially Rheumatism.
4. It has stimulating effect on heart muscles. It decreases cholesterol level and also lowers blood pressure.
5. It is used in the treatment of neurosis, arteriosclerosis and arthritis.

## **Propolis (Bee glue)**

Propolis is gathered by bees from resinous exudes of trees. Propolis is mainly composed of resins and balsams, ethanol, scented oils and pollen.

1. Propolis is used by bees for sticking frames, sealing cracks and crevices.
2. As it is a natural effective antibiotics, it is useful in preparing ointments for healing cuts, wounds and abscesses in cattle.
3. It is used in cosmetics
4. Propolis is sold as supplement in health shops too in the form of capsules, tablets and in liquids.

## **Royal jelly (Bee milk)**

Royal jelly is secreted by glands of nurse bees of the age of 6-12 days. It is very nutritious food and is fed to the young larvae and adult queen. Royal jelly is milky white in colour. It is composed of protein, lipids, carbohydrates, water and ash. Royal jelly is a nutritious food for human beings as it increases vigour and vitality.

**Pollen:**

The worker bees (field bees) collect pollen, which is the basic form of renewing species of plants as well as feeding the hive larva as well. The nurse bees of the hive will refine the pollen in to beebread or royal jelly for feeding to larva and young bees. Pollen is also used for human consumption since it's packed with 25 protein and 18 amino acids.

**Diseases of bees and their enemies**

Honey bees are affected by large number of viral, fungal, bacterial and protozoan organisms, ecto-endo - parasitic mites, insects and non-insect enemies.

**Viral diseases**

**Sac brood :** It is caused by a virus and found in 30% of this colony. This prevents larvae from pupating.

**Kashmir bee viruses :** This disease will affect in all stages of development. Infected bees die in the affected colony.

**Fungal diseases**

**Chalk brood :** Caused by a fungus. Strands of fungus invade the larvae tissue and the larvae dies. The dead larvae become chalky white in colour.

**Bacterial diseases**

**American foul brood (AFB):** Caused by spore forming bacterium. This bacterium penetrates the gut wall and body tissue of the larvae. Infected larvae change colour from a healthy pearly white to dark brown and die after they are capped.

**Protozoan diseases**

**Nosema :** Caused by spore forming protozoa. It impairs the digestion and cause dysentery.

### **Acarine disease**

“Isle of wight” - an acarine disease caused by a small parasitic mite due to the blocking of the trachea of bee. Infestation of this mite causes chronic bee paralysis.

### **Enemies**

There are a large number of animals who act as enemies to the bee. Some of the enemies are wax moth, wax beetle, tods, snails, ants, dragon flies, praying mantis, termites etc.

### **Present position of apiculture industry in India**

The number of bee colonies in India at present is about 5.75 lakhs irrespective of our goal of establishing 15 crores bee colonies. In Maharashtra, regular bee farms have been established at several places. Among the honey producing States, Tamil Nadu stands first followed by Kerala and Karnataka respectively.

Bee research centers have been established at several places in India. The Indian Council of Agricultural Research is engaged in research and developmental efforts in various disciplines of agriculture including api-culture.

### **Sericulture**

The silk is used for various purposes since ancient times. Pure silk is one of the finest natural fibre and is said to be the “**queen of fibres**”. Due to its great value and usefulness, various methods were adopted to rear silk worms on a large scale with great care. Rearing of silkworm and adoption of different rearing techniques for the production of silk threads of fine quality is known as **Sericulture**.

### **Types of Silk.**

The silk is produced by certain moths. The **moths** belonging to the families **Saturnidae** and **Bombycidae** of order **Lepidoptera** and class **Insecta**. Mainly four types of silks have been recognized which are secreted by different species of **silkworm**.

(1) **Mulberry Silk** : This silk is superior in quality due to its shining and creamy white colour. It is secreted by the caterpillar of **Bombyx mori**, which feeds on **mulberry leaves**.

(2) **Tasar Silk** : It is secreted by the caterpillars of **Antheraea mylitta**, **A.paphia**, **A.royeli** etc. This silk is of coppery colour. The caterpillars feed on leaves of **Arjun, Asan, Sal, Oak** .

(3) **Eri Silk** : It is produced by the caterpillars of **Attacus ricini** which feed on **castor leaves**. Its colour is creamy white like mulberry silk and is less shining than the latter.

(4) **Munga Silk** : It is obtained from caterpillars of **Antheraea assama**, which feeds on leaves of **Som, Champa and Moyankuri**. It is shining like tasar silk.

Type of silk	Type of silk insect	Food plants
1. Mulberry	Bombyx mori	Moras alba (Mulberry)
2. Tasar	Antheraea mylitta	Arjun
	Antheraea paphia	Asan
	Antheraea rayeli	Sal
	Antheraea pernyi	Plum
3. Eri	Attacus ricini	Castor
4. Munga	Antheraea assama	Champa, Som, Moyankuri

### ***Biology of silk moth***

The domestic Silk Moth, *Bombyx mori*, is a member of a small family of about 300 moth species in the Order Lepidoptera. Adults of this family have heavy, rounded, furry bodies and cannot feed because of undeveloped mouth parts. It is a flightless insect. Wings and body are usually white, but may vary to shades of light brown.

Wingspan is 4-6 cm. Wings are membranous and weak. The adult moths have a very short life, and live only for 2 or 3 days after emergence.

The larva of *Bombyx mori* is an elongated caterpillar commonly called a silkworm. Larvae are monophagous and feed only on mulberry plants. The larva will moult five times before spinning a silk cocoon of one continuous fiber for pupation. Silk cocoons from this species are the commercial source of silk.

### **Formation of silk:**

Silk is the result of secretion of silk glands (modified salivary gland). There are two long tubular, coiled glands lying one on each side of the alimentary canal of the caterpillar. These glands are connected to a narrow tube like structure known as *spinneret*. The spinneret is a part of the hypopharynx (tongue). **Fibroin**, a sort of liquid fibrous protein is secreted by the silk gland. It is insoluble in water and is made up of glycine, alanine and tyrosin. As the liquid secretions of the two glands pass through the Spinneret, it transforms them into a single thread. **Sericin**, another secretion produced by a pair of accessory glands, cause the two fibers of fibroin to unite. Two streams of fibroin along with sericin are expelled through the spinneret due to contraction and expansion of the body of the caterpillar. This sticky secretion when comes into contact with the air is converted into a fine, long and solid thread of silk.

### ***Life cycle :***

The life cycle of *Bombyx mori* has four distinct stages . They are *egg, larva, pupa* and *imago*.

#### **Stage 1 - EGG: Incubation 7-10 days**

The egg of *Bombyx mori* is a very small and hard structure about the size of a pin head and resembling a poppy seed. The egg shell provides a protective covering for embryonic development. When the eggs are first laid, they are light yellow in colour and later the eggs become darken to a blue-grey within a few days.

#### **Stage 2 - Larva: 45 days (5 instars)**

The larva is the vegetative stage where growth takes place. The larva of *Bombyx mori*, commonly called a *silkworm, ( caterpillars)* . During growth, the larva moults four times. The period between successive moults is called an *instar*. The caterpillars have segmented appearance with strong mandibular jaws. Throughout the five instars the larva keeps on consuming the mulberry leaves . The salivary glands (silk glands)are fully grown and silk concentrate gets secreted out of this gland.

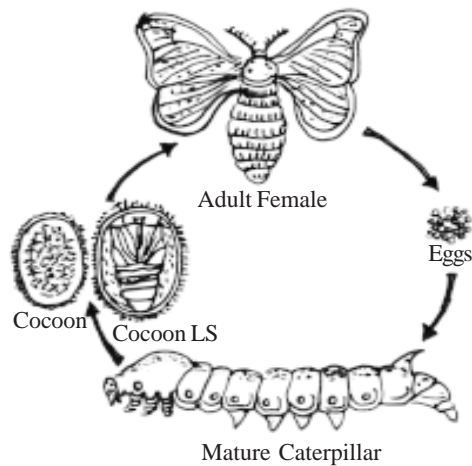

**6.36. Life-cycle of mulberry silk-moth**

### **Stage 3 - Pupa : 15 days**

The secreted silk spins in to a *silk cocoon*. The silk cocoon serves as protection for the pupa. Cocoons are shades of white, cream or yellow in colour. After a final moult inside the cocoon, the larva develops into the brown, chitin covered structure called the *pupa*. Metamorphic changes of the pupa result in an emerging moth.

### **Stage 4 - Imago: 5 - 7 days**

An adult insect produced after metamorphosis is called *imago*. This adult stage completes the life cycle of *Bombyx mori*. It is the reproductive stage where adults mate and females lay eggs. Moths are flightless and lack functional mouth parts, so they are unable to consume nutrition.

### **Sericulture in Mulberry Type:**

Mulberry silk worms are of domesticated type because they can be reared indoors. Large and healthy cocoons are selected and they are kept in well ventilated cages. Young ones emerge after few days and male and females are easily distinguished. Females are larger than males. Once they attain maturity, they are kept as pairs in the coupling jars for about 24 hours. After copulation females are transferred to egg-laying boxes. Each female lays about 300 - 400 eggs of small size. These eggs are commercially called seeds. A great care should be taken in the selection of seeds because the quality of the seeds depends on the silk production. The eggs are kept in incubators at 70°F. Small larvae hatch between 7-10 days, and they are known as **caterpillars**.

The sericulture practice involves three different stages. They are (1) Cultivation of food plants (Plant origin) (2) Rearing of larvae (Animal origin) and (3) Reeling of thread from cocoon (Technical origin).

### **Cultivation of food plant - Stage 1**

The larvae of *Bombyx mori* feed on leaves of mulberry. Regular supply of healthy mulberry leaves is essential. Mulberry leaves have high food value. It is a perennial woody plant. Mulberry trees can be propagated by sapling, cutting and grafting methods.

### **Rearing of larvae tiny caterpillars - Stage 2**

Initially the caterpillars measure 5-7 mm in length. They are transferred to feeding trays containing chopped tender leaves of mulberry. They start feeding on the tender leaves and grow faster. The caterpillar thus formed stop feeding and become inactive within four to five days. The larvae then undergo morphological changes after every moult. They undergo 5 moults. The maturity is achieved in about 45 days. The salivary glands, otherwise called *silk glands* start secreting silk.

At this stage, the matured caterpillars are transferred to spinning trays. They excrete their last excreta and begin to secrete sticky secretion from the silk glands through a very narrow pore situated on the hypopharynx. Within 5 days, the caterpillars are transformed into pupa or cocoon. After 15 days acute metamorphic changes take place during pupation and the young imago tries to come out. The young one secretes an alkaline fluid to soften one end of the cocoon. Later it escapes by forcing its way out of the softened area. Just after the formation of cocoons, healthy cocoons are selected and kept in cages for the next crop.

### **Tools and materials necessary for rearing Silk Worms.**

**House :** A well aerated building or mud walled thatched houses are the best as they are cool in summer and warm in winter. The optimum temperature for maintaining larvae is **70° -75°F**.

**Feeding Trays:** Freshly hatched worms are kept in flat trays made up of bamboos along with small pieces of mulberry leaves.



**Machan :** Machan are made by fixing two pairs of bamboos in the ground and tying across bars of bamboos. They are needed to accommodate large number of trays in a limited space.

**Nets :** Large amount of excreta, dirty products and remains of leaves may fall on the trays from the holes of the upper trays. If worms are not protected from these wastes they may get diseased. To prevent this, trays are covered with the nets.

**Spinning Trays :** Before cocoon formation mature worms are transferred to specific type of trays known as spinning trays or Chandraki.

Initially the start of rearing the machan, feeding trays, spinning trays, nets and everything used in rearing except the leaves are washed with Copper sulphate solution or other antiseptic chemicals. The remaining germs are killed by fumigation.

**Precautions to be taken during rearing of mulberry silkworms.**

- 1) The worms should never be kept, over crowded in a tray.
- 2) Dried or dusty leaves should never be fed to the worms.
- 3) Free ventilation is a must.
- 4) There should be equal distribution of leaves among the worms.
- 5) Worms which are under process of moulting should not be disturbed.
- 6) There should be no dust at the floor of the house. It should be well plastered with cow dung or mud at regular intervals.
- 7) Smoking should be strictly prohibited in the rearing room.
- 8) Worms should not be handled with dirty hands to avoid infection. Hand should be washed before handling.
- 9) Water may be sprinkled periodically over the feeding trays, during the hot season.

**Stage 3 -Reeling of raw silk from cocoon**

For the production of standard variety of raw silk latest technology is employed for the speedy and economical reeling of raw silk. Reeling process is an important aspect of sericulture because cocoon production is directly related to reeling industries.

Before reeling the thread, the cocoons are dipped in a container of hot water for more than 10 minutes. During this period, continuous stirring with a rod is necessary. Due to this, their outer portion is loosened and removed in the form of long tapes. The end of the continuous filament is now found. The filaments of several cocoons are picked up and passed through the 'glass eye' on to the reel. The thread thus reeled forms the "raw silk" of commerce. About 1 kg of raw silk is obtained from nearly 55,000 Cocoons.

### Uses of Silk :

1) Silk fibers are utilized in preparing silk clothes. Silk fibers are now combined with other natural or synthetic fibers to manufacture clothes like **Tere-Silk, Cot-Silk** etc. 2) Silk is used in industries and for military purposes. 3) It is used in the manufacture of fishing fibers; parachutes, cartridge bags, insulation coils for telephone and wireless receivers, tyres of racing cars, filter clothes, in medical dressings and as suture materials.

### Diseases and enemies of silk worm

The profitable silk industry is threatened not only by various diseases caused by the virus, fungal, bacterial and protozoan infections but also by insect predators, birds and other higher animals. Ants, crows, kites, rats, feed upon silk worms thereby causing a great loss to silk industry. Various types of silk worm diseases, the symptoms and methods of control have been given in the following chart.

<b>Name of disease</b>	<b>Infecting agent</b>	<b>Symptoms of disease</b>	<b>Controlling methods</b>
Pebrine	Protozoan	Death of under nourished larvae, Production of lesser silk, death of larvae.	Treatment of eggs transmitted through with water (47°C) or rejection of infected and defective eggs.
Flacherie	Bacterial infection	Softening of skin and physical disability.	Careful rearing in healthy conditions.

Grassarie	Viral infection	Moulting is affected, skin becomes yellow and blood becomes milky, putrifaction of internal organs and death of larvae	General cleanliness, separation of affected worms and immediate disposal of dead worms.
Muscardine	Fungal infection	Worms body becomes hard	Maintenance of stock which are resistant to the disease and by using disinfectants.

### Sericulture in India:

India stands fifth in the production of silk. The other main silk producing countries in the order of production are Japan, China, South Korea, USSR, Brazil, Bulgaria and Italy. India accounts for 5% of the total global output of mulberry raw silk and 10% of Tasar. The production of natural silk has increased to about 40% in the last 15 years and the global output of 1974 was 45 thousand tones. At present the production rate is higher and the value of silk product in India is about Rs. 80 crores per annum.

In India the major silk producing states are Mysore, West Bengal, Jammu and Kashmir, Assam, Bihar, Orissa, Madhyapradesh, Uttra Pradesh, Andhra Pradesh, Tamil nadu, Punjab, Manipr, Tripura and Maharashtra. 76% of total production of raw silk is in Mysore. Mulberry silk is restricted in Purnea district along the border of West Bengal. Bihar has the privilege of producing Tasar in larger quantity. The Eri silk is limited in the state at Gangetic plains (Assam & Bihar). Munga silk is produced only in Assam.

Rearing of silk worms on a large scale is carried on in villages and remote forests by villagers and tribals. They are assisted by **State Government** and **Central Government** agencies. A qualitative and quantitative breakthrough has been made by “**Central Silk Board**” running under the **Union Ministry of Trade and Commerce**. The increased silk production in India is due to research conducted on various aspects of the

industry by the respective research centres running under this board. The important research centres are the following,

- (1) Central Sericulture Research Station - Berhampur, West Bengal (Mulberry).
- (2) Sericulture Research Institute Channapatna - Mysore (Mulberry).
- (3) Central Munga and Eri Research Station - Titabar - Assam.
- (4) Central Tasar Research Station - Ranchi, Bihar.

These research stations have sub-stations and extension centres in different parts of the country for the convenience of the sericulturists in remote areas.

## 7. THEORIES OF EVOLUTION

### Introduction

Several opinions had been made available to explain the origin and existence of various forms of life. The existing living beings show characteristic resemblances in form and functions. There are evidences for succession of several types of living organisms occupying earth. Populations of animals and Plants tend to undergo predictable changes in their population intensities. An explanation to all these interesting natural happenings had been attempted through various modern theories of evolution. An initiation for such evolutionary thought process was well provided by Lamarck. This evolutionary theorizing culminates in the modern synthetic theory of evolution afforded by different fields in biology.

### Lamarckism

Jean Baptiste de Lamarck (1744 - 1829) is well known for his theory of evolution. In 1809 he published his book titled '*Philosophie Zoologique*'. This book contains his views on evolutionary mechanisms. Eventhough the views of Lamarck are not fully accepted, he occupies a very important place in the history of evolutionary thought.

The theory of evolution as proposed by Lamarck is popularly known as the 'theory of inheritance of acquired characters'. According to this theory modifications or changes acquired during the life time of an organism can automatically be transmitted to succeeding generations. While elaborating this theory, Lamarck advanced four laws or propositions.

#### I Law (or) Proposition

*'In evolution, during course of time, organisms or their component parts gradually tend to increase in size.'*

Lamarck cited the evolution of horses as an example to explain this law. The modern horses, namely, *Equus* evolved from very small ancestral forms called *Hyracotherium* or *Eohippus*. Such small forms survived years ago. They gradually evolved into larger modern *Equus*.

Lamarck's opinion was based on fossils of several intermediate ancestors of horses. Whose fossils had already been discovered. However during recent years various other fossils had been obtained. Of these fossils, some of them are much smaller than their immediate ancestors. This finding is against the view already expressed by Lamarck. Thus the first law of Lamarck lost its significance.

## II Law or Proposition

*'If an organism is 'in need' of an organ, sooner or later it will arise.*

This view of Lamarck emphasized the significance of mind and its thinking being related to needs in an environment. Thus, according to Lamarck a continuous thinking for several generations can lead to the origin of an adaptive character. Lamarck elaborated his view citing the lengthening of neck in giraffee over the years.

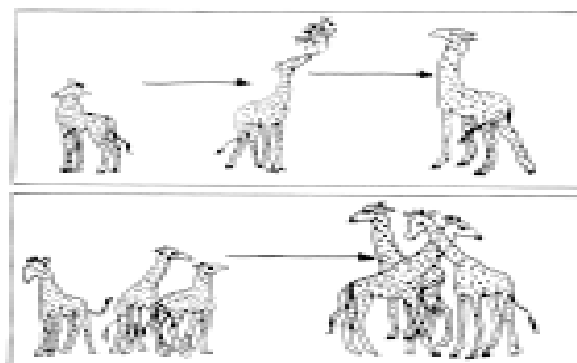

**Fig. 7.1.Lamarck's Theory**

It is known through fossil records that the ancestors of modern giraffe were small and they had short neck and forelimbs. They lived in the grasslands of Africa. These ancestral animals were feeding on grasses and the leaves of small trees nearby. Gradually, as the grasslands were transformed into deserts, the animals became dependent on trees for food. Due to competition for food they had to stretch their neck for more leaves. They strained their neck for several generations with a very strong inner feeling to have longer neck. This strong desire, in course of time, led to gradual increase in the length of neck and forelimbs.

In this explanation Lamarck considered that mere 'want' or '*inner feeling*' to possess a particular character can lead to the origin of such a character. This view of Lamarck is not accepted by modern evolutionists.

### **III Law (or) Proposition - Law of use and disuse**

According to this law, constant use of an organ changes its efficiency and makes that organ to increase in size with better development. Similarly if an organ is not used for a long time, it might lead to reduction in efficiency and size of that organ. The development of hand muscles of a blacksmith and thigh muscles in the legs of an experienced runner were quoted as examples. Eventhough this view of Lamarck is correct and acceptable, it is not relevant to evolution due to lack of inheritance.

### **IV Law (or) Proposition. Inheritance of Acquired Characters**

*'Bodily changes or new characteristics obtained by an organism during its life time will automatically get transferred to the next generation'*.

While proposing this law, Lamarck did not provide any specific example. He simply believed that due to conditions prevalent in an environment, an organism can use an organ extensively and such an usage can lead to more efficient and perfect nature of that organ. Similarly, an organ not used for a longer period would degenerate. These perfect or degenerate characteristics will be inherited by subsequent generations resulting in new types.

The IV Law of Lamarck had been subjected to severe criticisms. Several experiments had been carried out, either to prove or disprove this concept.

In 1890, the German Scientist, **August Weismann** performed some experiments with the rats. He selected a set of healthy male and female rats. He started cutting their tails continually for more than twenty generations. This experiment was performed to verify inheritance of the acquired character, namely the tailless condition. Interestingly such a condition was never observed in any of the young rats born. This finding led to the proposition of the theory, that any change to the body regions (somatoplasm)

will not have influence over the reproductive cells (Germplasm). Thus Weismann, for the first time segregated germplasm from the somatoplasm.

This led to the formulation of the '**Germplasm theory**' which states that '*any change to the somatoplasm will not have an influence over the germplasm*'.

### **Neo-lamarckism**

Lamarck's 'theory of inheritance' was further studied by a group of scientists. Their ideas supporting Lamarck's opinion collectively constitute neo-Lamarckism.

The neo-Lamarckians were of the opinion that 'adaptions' are universal in nature. An adaptation happens through causal relationship of structure, function and environment. Due to changes in the environment, habits and life style of organism gets altered. Thus gradually the organism acquires new structures. The newly obtained character gradually becomes an inheritable trait. This opinion and argument is a modified form of Lamarckism. These ideas stressed direct action of environment on organisms.

#### Support to neo-Lamarckian concept - Experiments

1. McDougall (1938) tried to prove that learning is an acquired character that can be inherited. He did his experiments on rats.

He devised a 'T' shaped tank. The tank had two exits. One exit was well lighted. However at the terminal region of the exit he devised an arrangement for giving electrical shock. The pathway to the other exit was kept dark. At the terminal exit point a small piece of cheese was kept as a reward. McDougall dropped several rats into the tank. Many of the rats preferred lighted pathway to escape and at the exit they received electric shock. Those rats, that preferred dark pathway received the cheese. He repeated the trial several times. Gradually many rats learnt the correct route for escape. Subsequently the rats were allowed to breed and the next generation developed.

The same experiment was repeated in the second generation. According to Mc Dougall, it was claimed that the number of mistakes committed, gradually got reduced. The speed of learning increased from



generation to generation. Thus he concluded that learning is an acquired character.

However later workers found some technical mistakes in the work of Mc Dougall. The same experiment while repeated in other laboratories failed to give similar results.

2. Temperature related changes in the body of mice was noted by F.B.Sumner (1910). He reared one set of white mice in warmer temperature (20 - 30°C) and another set in cold conditions. He found that in warmer conditions the mice developed larger ears and longer tails. He further claimed that these characters were inherited.

Through similar works claim for inheritance of acquired characters were made by Lindsey, Guyer and Smith and Kammerer. In all these works while repeating, critics have found technical mistakes and rejected them outright.

However, the controversy over ‘inheritance’ of acquired characters still continues. This theory of Lamarck while has not been disproved totally, it remains to be proved correct.

### **Darwinism**

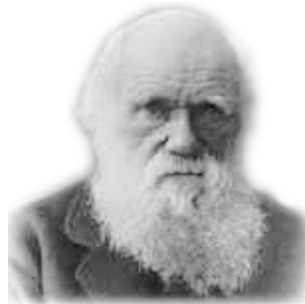

**Fig. 7.2. Charles Robert Darwin**

Darwinism comprises the natural selection concept as advanced by Charles Robert Darwin in 1859. His theory provided the correct idea to explain all processes and intricate mechanisms of evolution. The theory of natural selection is considered on par with Newton’s law of gravitation and Einstein’s theory of relativity. The monumental work of Darwin was titled as “The Origin of species” (the original full title of the book was ‘On the Origin

of species by means of Natural Selection, or the Preservation of favoured Races in the struggle for life’).

The book of Darwin convincingly demonstrates the fact of evolution. Further, it elaborates on the theory of natural selection as a convincing mechanism for providing evolutionary transformations.

Charles Darwin was born in Shrewsbury, England on February 12, 1809. While studying in college at England through his friendship with Professor J.S. Henslow, Darwin became familiar with Botany. Later he accepted the job of a naturalist aboard the ship H.M.S Beagle. The ship was to spend five years, in exploration around South America (1829 - 34).

During the period of five years, Darwin visited pacific islands and many parts of the world. He returned to England in 1836. Later he worked for a further period of 20 years to develop his theory of natural selection. While Darwin prepared his work for publication, a similar idea to explain evolution was proposed by another naturalist, Alfred Russel Wallace (1823-1913) from Malay archipelago. Charles Darwin gracefully accepted for the publication of his theory as a joint paper with Wallace. Thus the theory of natural selection is actually titled as ‘**Darwin-Wallace theory of evolution**’.

### **The Theory of Natural Selection**

During his period of study Darwin has made several observations and collected facts. Through these facts he arrived at certain conclusions. These conclusions constitute Darwinism. Thus **Darwinism or the theory of Natural selection** includes the following elements.

#### **1. Overproduction or Prodigality of nature**

All living beings have an innate desire to reproduce and form their own progeny. In this attempt they have the capacity to multiply in a geometrical manner. Such an enormous reproductive potentiality can be observed in all species of organisms. For example a single female salmon fish can produce 28,000,000 eggs in a season. A common oyster of the Atlantic coast may release as many as 80 million eggs in one season. At the time of breeding the ovaries of a cod fish may contain 10 million eggs. If natural

processes of reproduction are allowed without any check a single pair of English sparrows can produce 275 billion descendents in 10 years. The elephants are the slowest breeders. An elephant begins to breed at 30 years of age. It goes on breeding till it is 90 years old. A female elephant can give birth to 6 young ones during its life time. Under these conditions, a pair of male and female elephants can cause the production of 19 million elephants in 750 years. Thus, the reproductive capacity is an innate nature of living organisms.

## **2. Struggle for existence**

According to Darwin while the population increases in geometric ratio there is no corresponding increase in food production. This causes an intensive struggle for living. The struggle happens for food, space for living and for coping with environmental conditions. The struggle may be intraspecific or interspecific. In an intraspecific struggle there is a competition among the individuals of the same species. Such a struggle is severe because the needs of the competing organisms are identical. Struggle might happen with environment too. Conditions like heat, cold, drought, storms, floods and other natural changes can affect organisms resulting in struggle for existence.

## **3. The universal occurrence of variations**

The occurrence of variations is a characteristic feature of all groups of animals and plants. The variations may be morphological, anatomical, physiological or behavioral. (However during Darwin's time the actual cause and nature of variations were not known).

As a result of variations, no two animals would look alike. Even the progeny of the same parents are not exactly alike in all respects. Eventhough variations are universal all such variations need not be significant from an evolutionary point of view. Certain variations that get established in the population and get inherited continually are termed, **heritable variations**. Such variations form the raw material for evolution.

## **4. Survival of the fittest**

While all living organisms face the struggle for existence, certain organisms possessing adequate modifications are able to escape and

survive. Such modifications are due to inherent variations. Hence favourable variations make an animal or a plant to be successful in life. They survive as fittest organisms in an environment which gets altered frequently.

## **5. Natural Selection**

According to Darwin 'the fittest' forms that are allowed to survive are chosen by 'Natural Selection' (an imaginative concept which includes all real aspects of the natural environment that supports the life of organisms).

The forces of natural selection will encourage only those that have suitable variations as adaptive features, to survive. Darwin designated them as 'fittest' forms. All other organisms having non adaptive or deleterious modifications shall be disqualified. Natural selection will eliminate such organisms from the populations. The selected group of modified individuals will occupy the next level in the evolutionary ladder.

Darwin strongly believed that using the natural selection concept, all evolutionary processes in the living world can be explained. As an example he differed from the explanation provided by Lamarck while explaining the lengthening of neck in giraffe. According to Darwin the population of giraffes had individuals having varying neck lengths. Those that had longer necks had more survival value, since they had more food and remained healthy. Gradually natural selection encouraged them to survive. Thus in course of time the average length of the neck increased.

### **Objections to Darwinism**

While the ideas of Darwin, related to reproductive capability, prevalence of variations, concept of struggle and survival of suitable forms are all commonly accepted, there are certain drawbacks in his original theory.

1. Darwin could not explain, the origin and cause for variations while insisting their importance in progressive evolution.
2. He overemphasized the importance of the 'fittest' organisms. During later periods it has been suggested that 'fit' and fitter forms can also exist along with the fittest.

3. As the principle of inheritance as explained in the later years were not available during Darwin's time. Hence he believed in the theory of 'pangenesis'. According to this concept from every organ in the body very minute such replicate structures will originate. Later they are transferred to the gonads for transmission to future generations.

4. 'Over-specialization' as in Irish deer and its consequent harmful effect on animals had not been accounted for by Darwin.

### **Neo-Darwinism**

A modified form of Darwinism is known as neo-Darwinism. It was developed due to acceptance of Darwinism and provision of several evidences in support of Natural Selection concept. The early neo-Darwinians were T.H. Huxley of England, Asa Gray of United States and E.Haeckel of Germany.

The neo-Darwinians differentiated the germplasm from somatoplasm and proposed the 'germplasm concept'. They also believed that characters are due to certain factors called **the determinants** that control the development. The neo-Darwinism concept was incomplete and erroneous. It lacked in an understanding of genetics as it is known in later periods.

### **Modern concept of Natural Selection (or) Modern synthetic theory of Evolution.**

Modern development in biological fields such as Cell biology, Genetics and Populations genetics helped in the development of modern synthetic theory of evolution. It was caused due to contributions made by eminent scientists such as Th. Dobzhansky, S.Wright, H.J.Muller, J.S. Huxley, R.A.Fisher, Ernst Mayr, G.L.Stebbins and others.

The basic concept of modern synthetic theory was provided by Th. Dobzhansky in his book titled "Genetics and the Origin of species" (1937) G.L.Stebbins in his book "Process of organic evolution" (1971) suggests five basic processes essential for evolution. They are **gene mutations, chromosomal aberrations, genetic recombinations, natural selection and reproductive isolation**. Contributions made by others provided additional factors such as **Hardy-Weinberg equilibrium, Genetic drift and Polymorphism**.

## **1. Gene Mutations**

Since proteins perform several functions, they determine many of the characteristics of organisms. The role played by a protein is largely determined by its primary structure. The primary structure is due to the sequence of amino acids in its molecule. This structure in turn determines the three dimensional protein molecule. The conformation determines the protein function.

The basic sequence of amino acids in proteins is precisely regulated by the genetic code. Any change in the code due to gene mutation will result in the production of abnormal proteins. The abnormal proteins thus formed may be either beneficial or harmful. A gene producing a beneficial protein confers an advantage on its possessor. Gradually its frequency increases in a population. Individuals having harmful mutations may not survive to reproductive age. So, such mutated genes are not passed to the next generation.

The mutations are considered as the 'raw materials' for evolution. They help to create and provide variations in a population along with genetic recombinations. The collection of genes in a population is referred to as the 'gene pool'. Mutations enrich the gene pool with new modified genes. A large scale accumulation of such genes will lead to evolutionary modifications.

## **2. Chromosomal aberrations**

During the process of meiosis one or more chromosomes may break. Such broken fragments of chromosomes may be subjected to several modified organizations :

- a) a small broken fragment may become lost (deletion)
- b) the broken fragment may become attached to the end of another chromosome (translocation)
- c) the fragment may become turned around and rejoin the chromosome (inversion)
- d) they may become inserted into another chromosome (duplication)

All the above mentioned changes may alter the genomes of gametes.

Sometimes a pair of homologous chromosomes may fail to separate in meiosis. It will result in gametes with one chromosome less or one chromosome more, than normal. The progeny formed from such gametes are called **polysomics**. They will have fewer or more chromosomes than normal.

In certain cases, whole set of homologous chromosomes do not separate in meiosis. It results in diploid gametes. Fusion of such gametes with a normal haploid gamete gives rise to progeny with a triploid chromosome number. This condition is called **polyploidy**. It is commonly observed in plants. Polyploids are usually more vigorous. Such forms can give rise to new species.

While recombinations provide regular variations, mutations enrich such variations. Phenomena such as chromosomal aberrations, polysomics and polyploidy while, found advantageous to the organisms, provide new directions for speciation and further evolution.

### **3. Recombination**

During meiosis, due to crossing over of chromosomes, genic arrangements get altered. Such alterations cause reshuffling of gene combinations. Such recombinations are regular events in gametogenesis. Due to such events new allelic formations happen and after fertilization variations result in the progeny.

### **4. Hardy-Weinberg equilibrium (Population genetics)**

A population is defined as an assemblage of living beings showing a closely interacting system. A population comprising of sexually interbreeding organisms is termed as the **genetic population** or **Mendelian population**. A genetic population may be defined as “a community of similar individuals living within a limited circumscribed area at a given time and capable of interbreeding”. The genes of all the individuals of such a Mendelian population will constitute the gene pool. **A gene pool comprises a diverse forms of a gene combining and recombining by the process of sexual reproduction.** The frequency of genes and genotypes in a population had been worked out by mathematical formulations.

The **gene frequency** refers to **the proportion of an allele in the gene pool as compared with other alleles at the same locus**. Hence the **gene frequency** can be calculated by subtracting the number of a particular gene in question from the total number of genes present on that locus in the population.

If the frequency of gene 'A' is represented by 'P' and that of gene a by 'q' and at gene equilibrium condition their total frequency is represented by 1, then at equilibrium

$$\begin{aligned}P+q &= 1 \\ \text{or } p &= 1-q \\ \text{or } q &= 1-p\end{aligned}$$

A mathematical interpretation for the distribution of gene and genotype frequencies in the population was developed by R.A. Fisher (England) and Sewall Wright (United States). A fundamental idea in the form of a law to understand population genetics was provided by G.H. Hardy of England and W. Weinberg of Germany in 1908. The law proposed by them is known as **Hardy-Weinberg's law**. It is the foundation of population genetics and of modern evolutionary theory. According to this law **'the relative frequencies of various kinds of genes in a large and randomly mating sexual population tend to remain constant from generation to generation in the absence of mutation, selection and gene flow or migration.**

This law concerns a theoretical situation for a population not undergoing any evolutionary change. Thus according to the law the normal mendelian genic frequencies are maintained under certain conditions only. If such conditions are not followed, the gene frequency will change leading to deviations and cause variations, such variation will be the sources for future evolution.

### **5. Genetic drift or Sewal Wright effect.**

This theory was developed by Sewall Wright in 1930. It is concerned with the gene frequency of a reproducing small population. In a small population not all the alleles which are representatives of that species may be present. Thus the process of inheritance is in violation of Hardy-Weinberg law. In



such a small population a chance event may increase the frequency of a character that has little adaptive value. Thus the genetic drift may remain a significant factor in the origin of new species on islands and other isolated populations. Due to loss of alleles having low frequency, amount of genetic variation may get reduced in small populations. Further, continual mating within such populations may cause decrease in the proportion of heterozygotes and increase in the number of homozygotes. However the small population as a whole may develop characters different from that found in the main population. Such deviations may even lead to speciation or formation of a new species.

When a small group of individuals due to genetic drift become founders of a new population the phenomenon is termed as 'founder principle'. The new population often has genotype frequencies different from the parent population.

Sometimes genotypic frequencies may get changed in a small population isolated temporarily due to natural calamities. When the population regains its original size the members of the small population may have diverged genetically from the original parental population. Hence interbreeding between members of small and larger populations may not be possible. The small population might have evolved into a new species. This type of genetic drift is referred to as **bottleneck effect**.

## **6. Natural Selection :-**

In the modern or synthetic theory of evolution natural selection is considered as a population related genetic phenomenon. It leads to changes in allele frequencies and favours or promotes adaptation as a product of evolution.

When the population size of animals or plants in specific locality increases certain environmental factors such as availability of food may become limiting factors. Those organisms exhibiting characteristics which give them a competitive advantage may survive. Thus population size and environmental limiting factor operate together to produce a **selective pressure**. The selection pressure may increase or decrease the spreading of an allele in a gene pool depending on its adaptive value. This inturn will lead to evolutionary changes.

There are three types of selection processes in operation. They are **stabilizing**, **directional** and **disruptive selections**.

In **stabilizing selection** competition in nature is not severe. The phenotypic features coincide with normal environmental situations. However this selection may eliminate characters that are abnormal and harmful and it tends to maintain the phenotypic stability within population for successive generations.

The **directional selection** operates in response to gradual changes in the environment. It operates within the phenotypic range available within the population. The selection gradually changes the phenotypic character towards a possible extreme condition found suitable for the changed environmental situation. This selection will increase the frequency of desirable phenotypic character within the population. Thus it results in gradual evolutionary change.

In **disruptive selection** the selection pressure may favour the existence of more than one phenotype in a population. It may even split a population into two sub-populations. If gene flow between such sub-populations is prevented a new species or a sub specie may evolve. When a disruptive selection produces more than one phenotype within a population the phenomenon is known as **polymorphism**.

## **7. Polymorphism**

It is the “the existence in a natural population of two or more alleles in frequencies too large to be explained by recurrent mutation”.

Thus a polymorphic population will have several alleles of a gene as a permanent feature of the species. The varied alleles are favoured and maintained in the population by genetical mechanisms.

A classical example for such a polymorphism could be the existence of a genetic disorder in humans, namely **sickle-cell anaemia**. This disease reduces the oxygen-carrying capacity of the blood and affects blood supply to various organs. This disorder is inherited as a Mendelian recessive. It is more frequent among American blacks than American whites. In spite of its harmful nature the allelic gene responsible for the disorder is maintained in

the black population. According to the work of Allison (1955, 61) it was shown that in Africa the same allelic gene conferred an advantage, that is it protected the inheritors of such gene from malaria. Thus the connection between sickle-cell anaemia and malaria was established. Hence selection has encouraged the existence of such a polymorphic allele in the population.

## **8. Isolating mechanisms**

A species may be defined as “a group of organisms that are reproductively isolated from other such groups”. Thus the maintenance of a species as a distinct group is due to several isolating mechanisms. They are

### **1. Geographical isolation**

It is a common type of isolation. The isolation between populations is caused due to geographical barriers such as mountains, rivers, oceans, forests or deserts. These natural barriers prevent interbreeding between them. Thus mutations formed in one population will lead to the formation of new species. The existence of closely related species of frogs in Southern India and Srilanka is a classical example. These fresh water animals are prevented from interbreeding due to a narrow sea namely Gulf of Mannar. Because of isolation for a fairly long time they have evolved into distinct species.

### **2. Premating isolations** – such mechanisms prevent interspecific crosses.

a) **Ecological isolation** – Members of the populations occur in different habitats in the same general region.

b) **Seasonal or Temporal isolation** – Mating or flowering periods occur at different seasons.

c) **Sexual, Psychological or Ethological isolation** – It is a behavioural isolation where males and females of the same species get attracted to each other.

d) **Mechanical isolation** – Physical non-correspondence of the genitalia or floral parts.

e) **Gametic isolation** – Spermatozoa, or pollen tubes of one species are not attracted to the eggs or ovules of another species.

**3. Postmating or postzygotic isolations** – These isolating mechanisms while allowing fertilization may prevent the hybrid zygote from further development.

**a) Hybrid inviability** – The hybrid zygotes are inviable.

**b) Hybrid sterility** – The hybrids develop but they remain sterile. They are incapable of producing a normal complement of functional sex cells.

**c) Hybrid breakdown** – F1 hybrids are normal and fertile, but F2 contains many weak or sterile individuals.

### **Speciation :-**

A species is a natural, biological unit. Among the various taxa, a species is not man made. It is a natural reality. The process of evolution operates at the species level only. It is because of these reasons, in evolution much importance is given to the 'Origin of Species'. There are several types of species.

**Allopatric species** – Species occupying different geographical areas. Ex : species of frogs in India and Srilanka. The two land areas are separated by the Gulf of Mannar. **Sympatric species** – closely related species living together in one common locality, yet maintain their species identity Ex: *Rana hexadactyla*, *R.tigrina* and *R.cyanophlictis* living together in a pond.

## 8. AQUACULTURE

Resources from fresh water and marine systems are being exploited by human beings mainly for food. The rate of exploitation is so high that the natural cycle is getting disturbed. The quantity of fish caught is much higher than the egg laying capacity of the fish. Further, by man made interferences like pollution, enhanced rate of infection, depletion of water bodies, etc., the fish population is adversely affected. With the present rate of exploitation, the once infinite fish food resource, is now becoming finite. Aquaculture is a methodology which is an alternate remedy for the above situation

**Aquaculture is a branch of science that deals with the farming of economically important aquatic organisms and plants, under controlled and in a confined environment.**

**Brief history :** Aquaculture is an ancient culture technique. It was first practiced in Asia. Chinese, in 3500 BC raised carps in ponds. They also developed breeding techniques for increased production. Today China dominates in Aquaculture industry. Currently Aquaculture practices all over the world are growing as fast as any other type of agriculture. Aquaculture in India is one hundred years old. Till the end of 19<sup>th</sup> century the method of pond management was mainly confined to West Bengal, Bihar and Orissa. Later, it gradually spread to other states including Tamilnadu.

### ***Prospects of Aquaculture :***

1. There is an increasing global demand for food. It is predicted that in another fifteen years animal proteins alone will provide 40% of the world's need.
2. As the growing population needs more food, increased aquaculture production would reduce the pressure on natural population.
3. Aquaculture helps to promote economic development in rural and under developed areas.
4. Culture of selected varieties of fish will help in good yield of commercial forms

5. The desirable fish being cultured in pond makes the process of harvesting easy and economical.

6. Fishes are healthy sources for animal proteins and are easy to digest and such an animal protein can be harvested on demand.

**Major kinds of aquaculture:**

The Aquaculture can be broadly classified into **freshwater culture, mariculture, brackish water culture** and **metahaline culture**. This classification has been made according to the variations in salinity of the respective culturing system.

**Fresh water Aquaculture :** Water is considered to be ‘**fresh water**’ when the salinity is  $< 0.5\text{‰}$  (parts per thousand or ppt). Culturing of organisms in this water is known as fresh water aquaculture. Fresh water aquaculture includes **earthen pond culture, temple tanks culture, irrigation tanks culture, race way culture; sewage- fed fish culture, re-circulatory system culture, ornamental fish culture, larvivorous fish culture, food organisms culture sport-fish culture and integrated fish culture.**

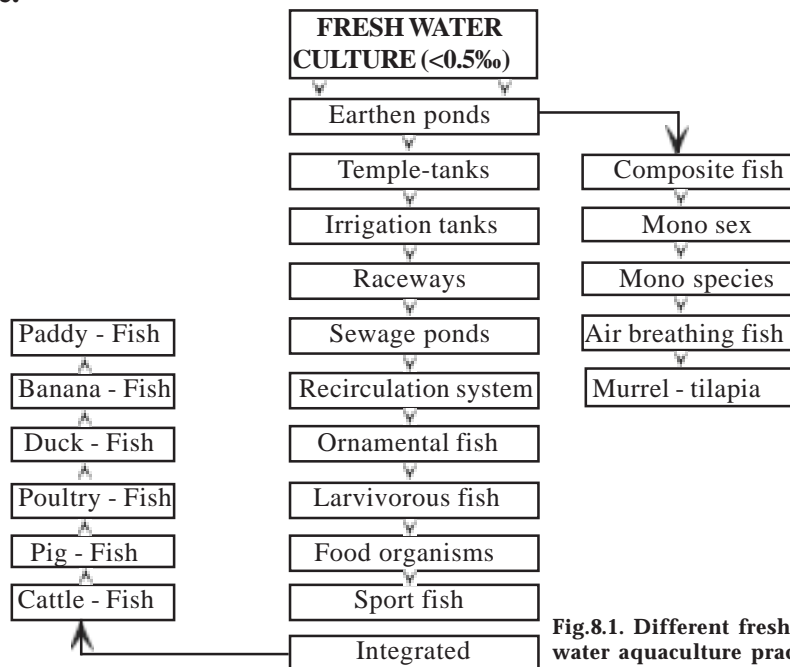

**Fig.8.1. Different fresh water aquaculture practices**

**Earthen pond culture :** An excavated terrain enclosing a small shallow body of water is termed **pond**. Culture of fish in this pond is known as earthen pond culture. Earthen pond fish culture comprises *monosex culture*, *monospecies culture*, *composite fish culture*, *air-breathing fish culture*, *predator-prey culture*.

**Monosex culture:** In this practice male and female fishes of individual species are cultured separately to enhance growth and yield.

**Mono species culture:** It is a culture of only one species of fish in a pond.

**Air breathing fish culture:** Air breathing fish species such as *Channa marulius*, *Channa striatus* are cultured in this practice. These fishes can utilize the poor oxygen content of the shallow water due to the presence of accessory respiratory organ in addition to gills.

**Predator-prey culture** (Murrel – Tilapia culture)

The carnivorous fishes like murrels are cultured along with their prey fishes like Tilapia. This can be undertaken even in shallow and swampy areas.

**Composite fish culture :** Culture of different species of fishes together is called composite fish culture. It is also known as **polyculture**. The objective of this type of fish culture is to select and grow fishes of different feeding habits in order to exploit all types of food available in different regions of pond. In this type of fish culture, fast growing fishes namely Indian major carp, **rohu**, **mrigal**, **silver carp**, **common carp** and **grass carp** are usually cultured.

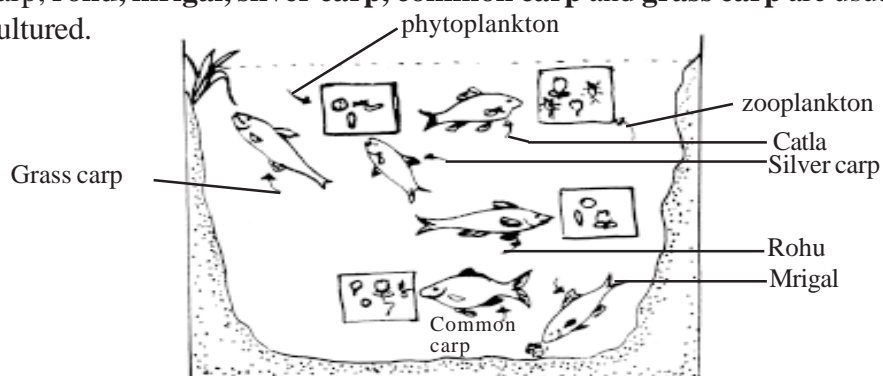
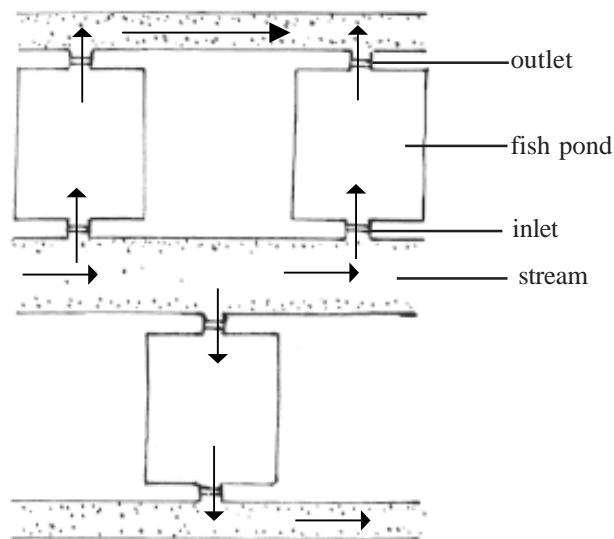

**Fig.8.2. Composite fish culture**

**Fish culture in temple tanks:** Fishes like tilapia, common carp, murrel and catfish are being cultured in temple tanks.

**Fish culture in irrigation tanks:** The fishes such as Indian major carps exotic carps (brought from other countries) are profitably grown under this system. These tanks are provided with inlet and outlet facilities for the entry and exit of water.

**Race way culture:** In running water systems like streams, a series of rectangular or circular earthen or cement tanks are constructed for fish culture. It is used for carp fish culture.



**Fig.8.3. Raceway**

**Sewage-fed fish culture:** Sewage is the liquid waste discharged from domestic and industrial sources within an area. It is reutilized for culture of fishes like rohu, mrigal and catla.

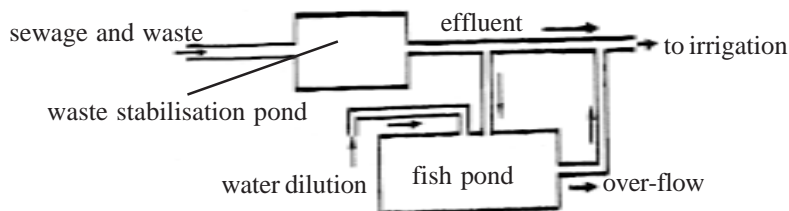

**Fig.8.4. Fish pond utilising sewage.**



City sewage is extensively used for fish culture in Calcutta. Before sewage is let in to a pond, it is diluted with the fresh water so as to maintain the dissolved oxygen content and reduce other toxic substances

***Culture in water re-circulation system:***

This method can be adopted, where water scarcity prevails. Fishes are cultured in tanks where water is circulated continuously through tap.

***Ornamental fish culture :*** As a flourishing business and for hobby, aquarium fishes such as guppy, molly, gourami, sword tail etc. are cultured in aquarium tanks.

***Larvivorous fish culture :*** It is the culture of the mosquito larvae- controlling fishes such as tilapia, gambusia etc. As these fishes are controlling the vectors, human population can be saved from many diseases.

***Culture of fish- food organisms :*** As the mass culture of protein rich live fish-food organisms namely *cladocerans*, *rotifers* and *tubifex* worms have been found to be essential for growing larvae of fish, they are cultured in this system.

***Sport fish culture:*** Cold water fish such as *salmon* and *trout* which are mainly of sport value are cultured in places of high altitude like Kashmir, Himachal Pradesh, Ootacamund and Kodaikanal. The water bodies of the hills are characterized by the low temperature.

***Integrated fish culture:*** Culture of fish along with agricultural crops such as paddy, banana and coconut and livestock such as poultry, duck, cattle and pigs is known as integrated fish farming.

***Fish farming with agricultural crops:*** Fish culture in paddy field is carried out in two ways namely **simultaneous culture** and **rotation culture**. In the former, rice and fish are cultivated together and in the latter, fish and rice are cultivated alternatively. The species of *Catla catla* and *Anabas testudineus* are cultured in this practice.

When banana or coconut is cultivated in rows of wetlands, the ditches made between such rows are used for fish culture practice. This culture system is made successful due to continuous supply of water. Larvivorous

air-breathing fish species such as *Channa marulius*, *Channa striatus* and *Tilapia mosambica* species are cultured in this system.

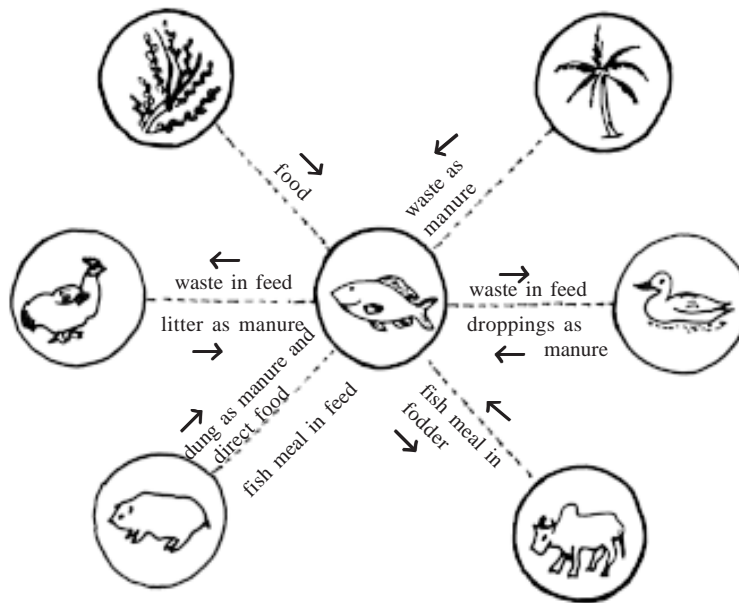

**Fig.8.5. Flow chart showing various aspects of integrated farming**

**Fish farming with Livestock :** In this practice, excreta of ducks, chicks, pigs and cattle are either recycled for use by fish or serve as direct food for fish.

**Duck-fish culture :** Ducks are known as living manuring machines. The duck dropping consists of inorganic substances and therefore it acts as a source of fertilizer in fish pond. Besides, the ducks feed on unwanted insects, snails and their larvae which may be vectors of fish pathogenic organisms. Fish of more than 10cm size alone should be cultured along with duck, otherwise the duck may feed on the fingerlings. Silver carp, catla, and common carp are ideal for duck-fish culture.

**Chicken-fish culture :** The droppings of chickens, rich with nitrogen and phosphorous, would enhance the fertility of the pond. Poultry housing

constructed above the water level using bamboo poles would manure the pond directly. The giant fresh water prawn **Macrobrachium rosenbergii**, silver carp, tilapia, common carp, murels are cultured in this practice.

**Cattle- fish culture :** For this culture cow *sheds* and bio-gas plants are constructed near the fish pond. The slurry from the bio-gas plant may be discharged into the fish pond to enhance the nutrients of culture system.

**Pond culture :** Knowledge of the construction of different types of fish ponds is essential for a profitable fish culture. The pond may be a artificially constructed one or a natural mass of water turned in to a pond. The essential feature of the pond is that it must be manageable for controlled farming.

**Structure of a typical pond :** A typical earthen pond comprises the following structures such as bunds, harvesting pit, inlet and outlet.

## **Bunds**

Bunds are the protective structure of the pond. Bunds are of three types, namely (i) main or peripheral bunds, (ii) bunds holding water on one side, (iii) bunds dividing two adjacent ponds. The longevity of any bund depends on quality of soil, slope and crown or crest.

A bund has a crown or crest and a slope. Bunds in clay soil are steeper than sandy soil. The crown must be a minimum of 1 meter width. If the production pond is more than 0.5 hectare, a platform like space between bund and water area should be made available. This area is known as **berm or bench line**.

For construction of bund, sandy or gravelly soil is not suitable because it may produce fracture (cleaves) in the bund and cause seepage. Hence a mixture of silt, sand and clay in the ratio of 1:3:2 is more suitable for the construction of bund.

**Harvesting pit :** The pond which is used to capture the cultured fish after attaining maturity is called harvesting pit. The bottom of the harvesting pit before being filled up with water, should be levelled and cleaned of debris, stones etc. A slight slope from one end to the other end in the case of undrainable fish pond may be provided at the bottom.

***Inlet and outlet :*** Fish ponds are provided with inlets and outlets to facilitate smooth filling and dewatering. The inlet and outlet should be devised in such a way that it prevents the entry of wild fish inside and escaping of culture fishes. The pipe size of the inlet and outlet will vary according to the size of the pond. The outlets are usually set at the lowest area of the pond.

***Types of ponds :*** Ponds can be classified on the basis of their utilization, as ***hatching pit nursery ponds, rearing ponds*** and ***stocking ponds***.

***Hatching pit :*** These are small tanks usually measuring (2.5 x 1.5 x 0.5m). They are used for hatching fertilized eggs. They are located near the riverine collection grounds. The hatching pit must have facility for continuous and slow flow of water. It also must be provided with an enclosure of fine mesh net called **Hapa**. The hapa is rectangular in shape. It is held on four bamboo poles, one at each corner. The size of hapa and mesh of its net differ according to use. This hapa prevents the escape of the laid eggs and protect the eggs from the predators.

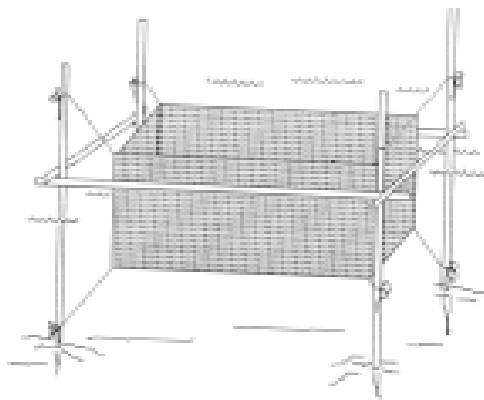

**Fig.8.6. Hapa**

***Nursery ponds :*** It is a seasonal pond having the dimension of 12 x 6 x 1 m. It is mainly used to nurse the hatchlings for a period of three weeks until they become fry. The fry is a recently hatched tiny fish less than 2.5 cm in total length. The maximum permissible density of hatchlings is about 10 millions/ha.

**Rearing ponds :** These ponds may be seasonal or perennial and used for rearing advanced fry for 2-3 months. It is fairly larger than the nursery pond and has the size of 25x12x1 m. Here the fry is grown for about 2 months until they reach fingerling stage. Young ones of a fish having more than 2.5 cm to 10cm in total length is known as **fingerlings**.

**Stocking ponds :** These are larger than nursery and rearing ponds. The size of the stocking pond should be 0.1 to 2.0 ha. The fingerlings are stocked and grown in this pond until they attain marketable size.

### **Location of a fish pond**

There are three important factors to be taken into consideration to choose a good site for a fish pond. They are (i) Topography (ii) Soil type (iii) Water source.

**Topography :** The term topography means the surface features of the area. The ideal topography of a fish farm site is a gently slopping terrain of a wild valley. The fish farm site may also be bowl shaped area with highlands on three sides, and a narrow outlet on the fourth side.

**Soil type :** Second important part of site selection is the soil of the area. The soil of the pond must be able to hold water. A pond containing lot of clay will be ideal for retentivity of water in it.

**Water source :** The dependable sources of water for pond are from, (i) lake and reservoirs (ii) springs (iii) rivers (iv) streams (v) canals (vi) surface runoff and (vii) wells. While supplying water to the ponds, water should be filtered carefully.

### **Physico-chemical and biological factors for pond fish culture**

The important physico-chemical factors affecting fish culture are water depth, temperature, turbidity and incident light, oxygen, p<sup>H</sup>, carbon-di-oxide and hardness of water.

#### **Physical factors**

**Depth :** In a shallow pond, sunlight penetrates up to the bottom and increases the productivity by photosynthesis. If the pond is too shallow,

water gets heated up during summer and affects the survival of fish. Hence, two meters deep ponds are ideal for maximum productivity.

**Temperature :** The suitable temperature for different fishes varies from 10°C to 37°C. For example Tilapias can not survive at 8°C, Indian major carp cannot survive below 16°C and tropical fish cannot survive around 10°C -12°C or less.

**Turbidity :** Water becomes turbid due to suspended matter like silt and clay. Turbidity affects respiration of the fish, since the gills get choked due to deposition of suspended matter. Therefore water should be free from turbidity.

**Light :** In shallow ponds light reaches up to bottom and influences heavy growth of vegetation. Incidence of light is also responsible for the production of plankton. The light controls photosynthetic activity of plants, thus indirectly affecting flora and oxygen content of the pond.

**Chemical factors :** Productivity of a pond depends on the presence of the following chemical factors.

**Oxygen:** The oxygen requirement for cultivable fish varies from species to species. If there is low concentration of oxygen, fish migrate to surface or crowd near inlet. In extreme depletion of dissolved oxygen level, fish may die of asphyxia.

**p<sup>H</sup> :** Ideal p<sup>H</sup> range for pond water is 6.5 to 9.0. Sudden fluctuations in p<sup>H</sup> are always harmful. In general neutral or slightly alkaline water is more productive than acid water.

**Carbon-di-oxide :** Though presence of carbon-di-oxide is essential for photosynthesis, excess of dissolved carbon-di-oxide is harmful to fish

**Hardness of water :** Hardness depends on the amount of calcium and magnesium salts dissolved in water. The suitable hardness for the growth of fish in pond water is 15ppm or above. Less than 5ppm cause slow growth and eventual death of fish .

**Biological conditions of pond water :** The productivity of a pond depends upon a large number of animals and plants living in various zones of the pond. The important aquatic plants are *vallisneria*, *hydrilla*, *chlorella*, and the floating plants are *eichornia*, *pistia*, *salvinia*, *lemna* etc. For a good fish culture practice, along with aquatic plants the growth of right type of plankton is also essential.

### **Maintenance of pond**

The productivity of the pond is enhanced by a) controlling the vegetation, b) cleaning the bottom, c) liming and d) manuring .

All undesirable plants and weeds must be removed regularly. The pond should be emptied, dried and cleaned at regular intervals to avoid the silting of pond. The application of quick lime raises the P<sup>H</sup> of water and kills the bacteria and other fish parasites .Quick lime is generally spread on the pond bottom before 10-15 days of stocking the pond with fish. Liming is done every year regularly. Introduction of inorganic nitrogenous and organic fertilizers increase the growth of phytoplankton, zooplankton and filamentous algae which are the natural food substances of growing fishes.

**Cultivable fresh water fishes :** (i) *Catla catla* (ii) *Labeo rohita*(Rohu) (iii) *Labeo calbasu* (iv) *Labeo bata*. (v) *Cirrhina mrigala* (vi) *Cyprinus carpio* (vii) *Clarius batrachus* (viii) *Tilapia mossambica* (ix) *Osphronemus gouramy* (x) *Anabas testudineus* and (xi) *Channa striatus* are some of the fresh water cultivable fishes.

*Macrobrachium rosenbergii* (giant river prawn) *M.Malcolmsonii* (monsoon river prawn) *M.idae* (river prawn) are some of the fresh water cultivable prawns.

### **Bionomics of cultivable fishes**

***Catla catla* ( Indian major carp) :** It is characterized by a deep body with conspicuous head; mouth is large and upturned; there are no barbels; lips are non-fringed, spawning takes place after sudden heavy rain fall. It feeds on zooplankton and grows to a maximum size of 1.8 meters weighing 45kg. It is widely distributed in Pakistan, Bangladesh and India.

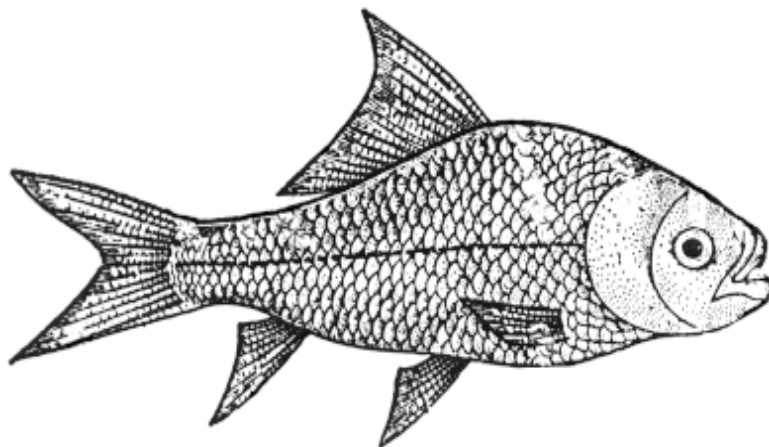

**Fig.8.7. Catta catta**

***Labeo rohita (Rohu)*** : It is popularly known as ‘rohu’ . It is considered as a palatable fish; it has a small and pointed head ; mouth is terminal with fringed lower lip; body colour is brownish grey or bluish on the back; fins have pink colour; it feeds on plankton, detritus and mud; body attains a total length of 1 meter weighing 900gms. Breeding and distributions are similar to that of Catla.

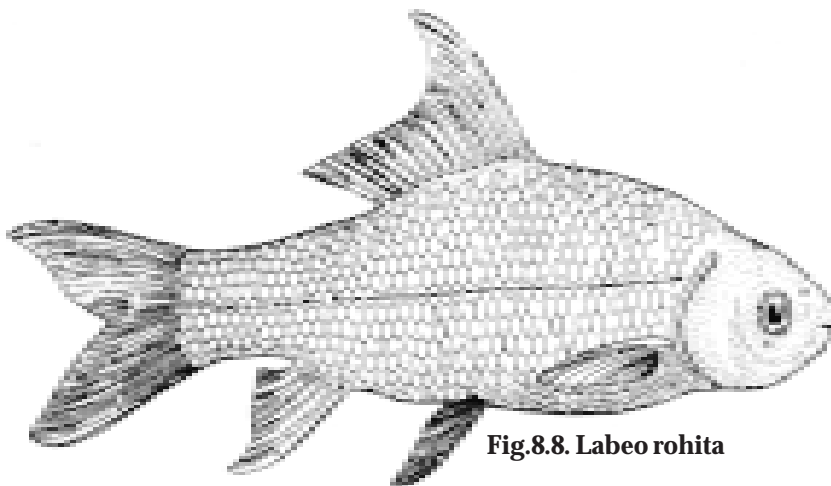
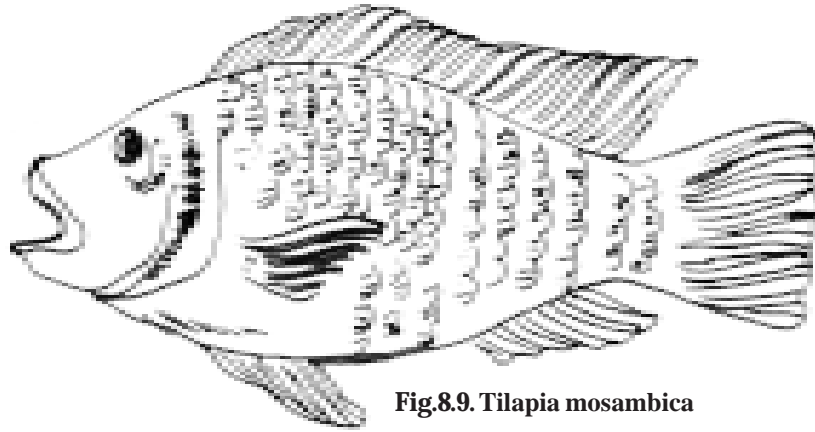

**Fig.8.8. Labeo rohita**

### **Tilapia mosambica**

It is an exotic fish brought from Africa. The colour of the body is brownish or blackish; mouth is large as wide as head; it is a fast growing hardy fish.; it does not survive below 10°C; it can also be cultured in rice fields and in



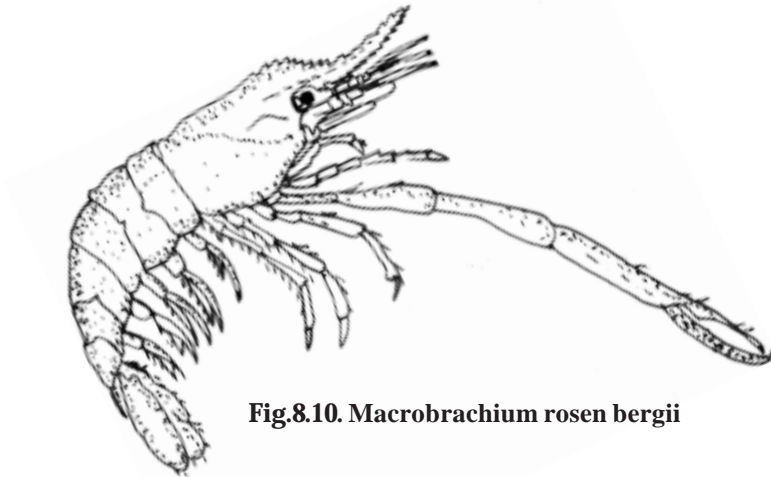

**Fig.8.9. Tilapia mosambica**

sewage water ponds; it breeds throughout the year; the adult is chiefly omnivorous; it grows to a length of about 35 cm. and female tilapia exhibits buccal incubation.

### **Bionomics of freshwater prawn**

***Macrobrachium rosenbergii***: Besides the culture of fish, freshwater prawns are also being cultured throughout the world.



**Fig.8.10. Macrobrachium rosen bergii**

Though about 150 species of fresh water prawn are found distributed all over the world, only 40 species of genus macrobrachium are found distributed in the rivers, reservoirs and estuaries of India. Among the

common species of macrobrachium the giant fresh water prawn, macrobrachium rosenbergii grows faster and it tolerates wide range of temperature and salinity changes. Moreover, it has less cannibalistic tendency. Because of these reasons, it is found to be most suitable for culture. It is cultured in large scale by countries like Hawaii, Mauritius, Taiwan, Thailand, Philippines, Malaysia and Indonesia.

***Salient feature and distribution:*** It grows to a maximum size of 320 mm weighing 200 gms. Matured males are not only larger than females but also possess enlarged second pair of walking legs. The juveniles can be identified by 1-8 horizontal line on the carapace. This species is distributed from lower to upper surface of the river. It prefers shallow and muddy environment.

***Breeding of Macrobrachium rosenbergii :*** Breeding takes place throughout the year. The peak of the breeding season is found to be during March to May on the east coast. Similarly on the west coast, the peak breeding activity occurs during October to November; the fecundity of a female may be 10,000 to 50,000 eggs. Fecundity can be defined as the number of ova that are likely to be laid by a fish during the breeding season.

The larvae feed mainly on zooplankton. Adult prawns feed on aquatic insects, algae, molluscs, crustaceans, etc. In the absence of the natural food, these animals become cannibals.

### **Induced breeding in fish culture**

The practice involved in prompting the fish to breed in confined water is known as **induced breeding**. Induced breeding technique enhances seed productions. It is performed by a technique called **hypophystation**. The hypophystation is a process of stimulating the breeding activity of fish through the injection of pituitary extract resulting timely release of eggs and sperms from the ripe gonads. The extract should come from the healthy pituitary gland of healthy fish of the same species or closely related one.

### **Induced breeding technique**

This technique involves (i) preparation of pituitary extract (ii) selection of breeder (iii) injection to breeder (iv) spawning in breeding hapa.

**(i) Preparation of pituitary extract :** For the preparation of extract, the pituitary gland is removed by dissecting the head from gravid donor fish. The removed pituitary glands are kept in absolute alcohol for dehydration. Then the glands are preserved in fresh alcohol contained in dark coloured pvals and stored in a refrigerator. The preserved pituitary glands are then softened in an instrument called homogenizer with distilled water. The extract prepared by centrifugation method is stored in vials

**(ii) Selection of Breeder :** The breeder to be selected must be healthy, fully ripe and of medium size. The preferable age group may be ranging from two to four years and weight may be ranging from 1 to 5 kg.

**(iii) Injection to breeder :** Intramuscular injection of pituitary extract is administered with a hypodermic syringe. In usual practice, female alone is administered with a stimulating dose of 2 to 3mg/kg weight. After 6 hours a second dose of extract with 5 to 8 mg/kg is also injected. Similarly males are also injected with the first dose of 2-3 mg/kg of body weight of the recipient fish.

**(iv) Spawning in breeding hapa :** The injected male and female breeders are kept together in a rectangular enclosure called '**Hapa**'. The hapa is made of mosquito net cloth to prevent breeders from escaping. The release of matured eggs and sperms called spawning, takes place after 3-6 hours.

**Nutrition for culture fish :** Knowledge about nutrition would help the fish culture practice to remain more lucrative. The nutritional requirements such as protein, amino acids, fats, carbohydrates, vitamins A,D,E & K. must be the constituents of their food material for enhancing faster growth.

**Fish diseases :** Like all other animals, fishes are also liable to be attacked by viruses, bacteria, fungi and different parasites and get diseased.

#### ***Viral hemorrhagic septicaemia(VHS)***

The symptoms of this disease are general anemia, discolouration of gills, swellings of eyes, Oedema of muscles. It is caused by virus.

#### **Sapro legniasis**

This disease is caused by a fungus. It is a very common water mould

disease. Ulceration or exfoliation of skin, blindness and hemorrhage are certain symptoms of this disease.

### **Gill rot**

It is another fungus disease. Appearance of small red spots on gill filament is the symptom of this disease. This leads to suffocation and ultimate death.

***Dropsy:*** It is caused by a bacterium. The symptoms of this disease are accumulation of water fluid in the body cavity, inflation of intestine and protrusion of scales and eyes.

***Costiasis :*** It is caused by a protozoan parasite. Bluish mucous coating on the skin, fin and gills are the symptoms of this disease.

### **Control of the fish parasites**

Various fish diseases caused by external parasites are removed and killed by the use of certain chemicals such as copper sulphate , potassium permanganate, acetic acid , formalin and common salt etc. The simplest treatment for the affected fresh-water fish would be their transference to sea water and vice versa. The affected fish are dipped or bathed in a tub containing solution of the chemical for a required length of time and then the fish is replaced in freshwater.

### **Ornamental fish culture**

Ornamental fishes have attractive colouration, peaceful nature, tiny sizes. They are suitable for keeping in captivity. They have adaptability for living in confined spaces. Therefore these fishes are cultured for hobbies and commercial purposes in glass tanks. Establishment of glass tanks in which living colourful ornamental fish and plants are kept for exhibition, is known as **aquarium**. The aquarium had its origin in Japan and China. About 600 species of ornamental fishes are grown for hobby and export.

***Setting up of an Aquarium tank :*** Aquarium tanks are made with glass sides and bottom. The glass plates are fixed by red lac or aquarium cement. The tanks are mostly rectangular in shape. Shallow and wide tanks are preferable for aquarium. The surface water of tank should have oxygenation

through atmospheric contact. The ideal size of aquarium tank may be 60 x 30 x 30cm or 90 x 30 x 40cm. It is also essential to have a cover with provision for installing lights and feeding. The tanks are cleaned with tap water. The aquarium tank may be placed on a table near a window so that it receives sufficient light. If the natural light is not adequate, artificial light by means of bulbs or fluorescent tube may be provided.

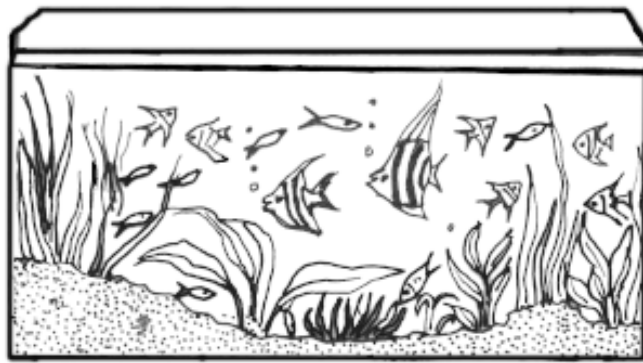

**Fig.8.11. Aquarium tank**

Small stones and fine gravels are selected for spreading at the bottom of the tank along with coarse river sand. The bed must be porous. Aeration may be done by providing a small piston or diaphragm type aerator. The air bubbles of aerator will drive away the carbon-di-oxide accumulated at the bottom water.

***Water quality of Aquarium tank :*** Pure rain water or tap water without chlorine content may be ideal for aquarium tank. Water should be devoid of hardness. For reducing hardness of water, water is mixed up with soft water such as rain water.

***Planting :*** Plants such as **vallisneria** and **myriophyllum** are planted in the tank. They not only give shelter and shade, but also utilize the carbon-di-oxide released by the fish and liberate oxygen for fish through photosynthesis.

### **Fresh water ornamental fishes**

***Guppy :-*** These are small coloured fishes (3cm). It is an exotic variety originating from central America. The colours may differ greatly. Males are

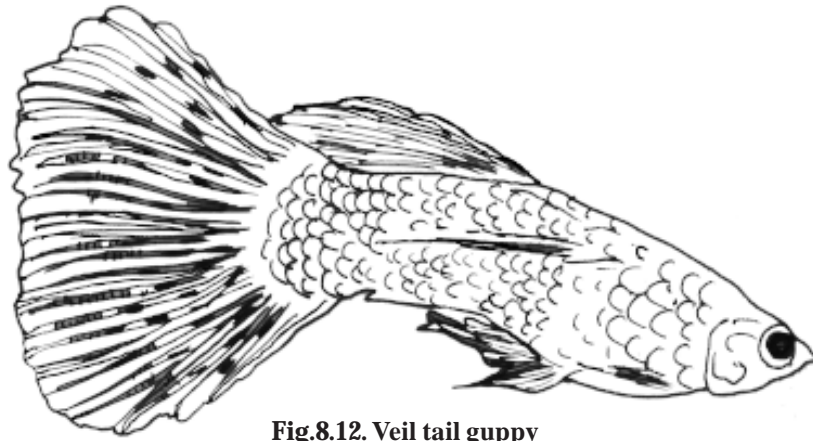

**Fig.8.12. Veil tail guppy**

irregularly marked in red, orange, green or black. Females are larger than males. Males have enlarged, coloured caudal fins. The female stores sperms inside the body and give birth to young ones (Live bearers). These are omnivorous fishes occupying all levels in an aquarium tank. These are peaceful fishes. There are several varieties of guppies. They are gold cobra, uncoloured red tailed half black, blond and red varitail.

**Sword tail :** These fishes have a coloured stripe along the side, and a yellow sword like caudal fin extension. The edges of 'sword' are black. There are several colour variance. The females are normally without a swordtail. The male fishes may quarrel among themselves. These are omnivorous fishes. They occupy all tank levels. The varieties are gold sword tail, pine apple sword tail, red wag, lyre, black calico sword tail.



**Fig.8.13. Sword tail**

**Platy** : The most common platy is the wag tail. It is a very popular variety with a black mouth and black fins and red or yellow body colours. These are omnivorous fishes living in all tank level.

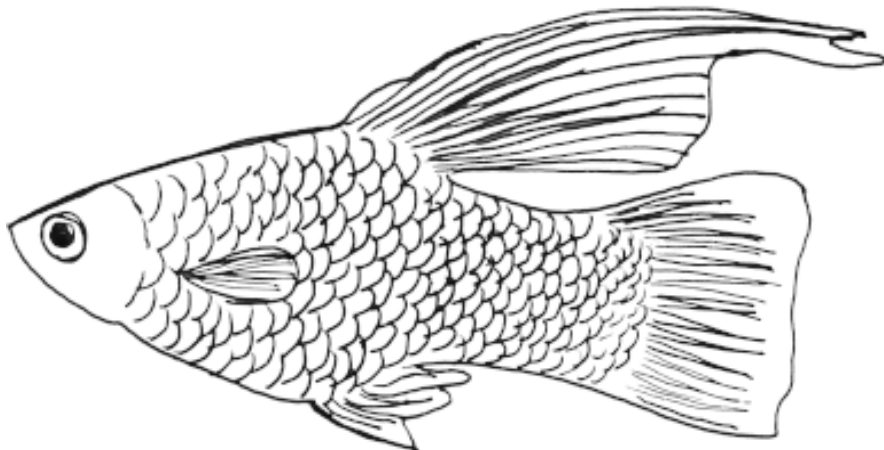

**Fig.8.14. Platy**

**Gourami** : These are oval shaped fishes. They have conspicuous dark vertical bars on lateral sides. They have an upturned mouth. The pelvic fins are filamentous. These are peaceful, herbivorous fishes. They can be reared with other larger fishes. The varieties of gourami are giant gourami, thick lipped gourami , dwarf gourami, kissing gourami, pearl gourami etc.

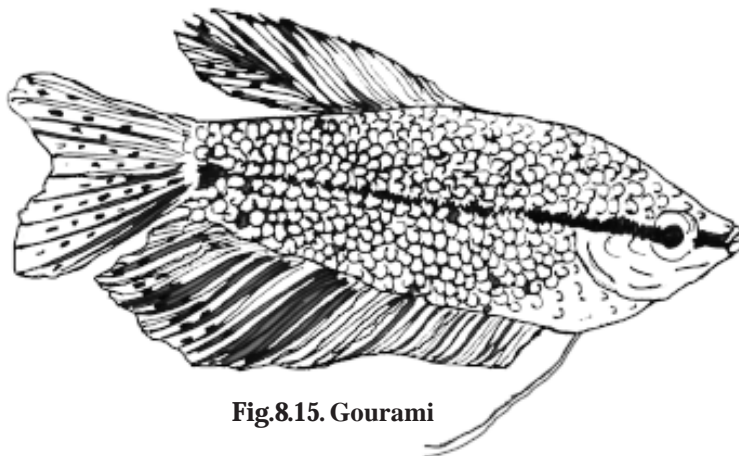

**Fig.8.15. Gourami**



**Siamese fighting fish:** These fishes are adapted to live in oxygen depleted water. These are native to Thailand. The males have long flowing fins. Colour and fin development differ greatly. Males are aggressive. Hence, it is advisable to keep only one per tank.

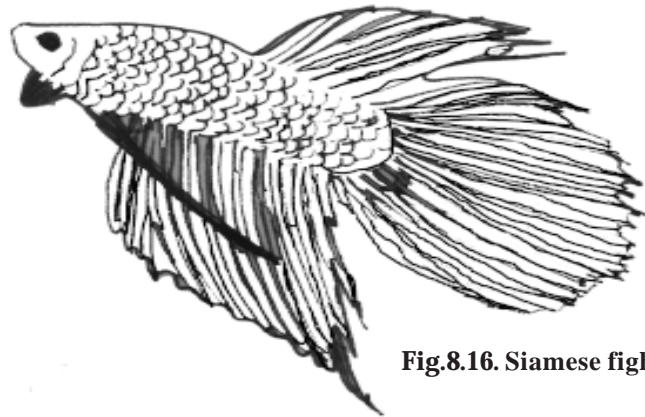

**Fig.8.16. Siamese fighting fish**

**Angel fish:** These fishes have laterally compressed disc like body. They have long trailing fins. They are popular because of the elegant outlines and graceful swimming movements. They exhibit parental care.



**Fig.8.17. Angel fish**

**Discus fish:** The body is round and laterally compressed. It resembles a disc. Dorsal and anal fins are long based. These fishes need high quality water and separate aquarium tank. These are carnivorous fishes occupying middle and lower level of the tank.



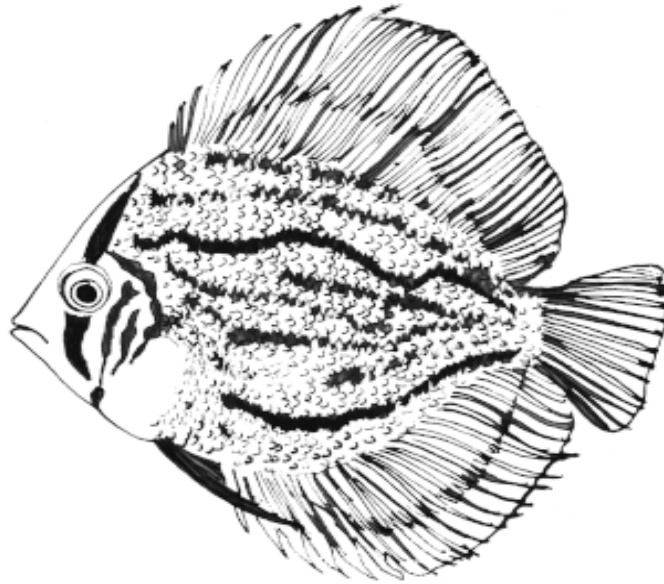

**Fig.8.18. Discus fish**

***Pencil fish:*** These are pencil shaped fishes. The dorsal surface is golden brown and underside is silver in colour. A golden band runs on the lateral sides. These are omnivorous fishes commonly living in the middle level in tank. The varieties are golden pencil fish, red pencil fish, and three lined pencil fish or one lined pencil fish.



**Fig.8.19. Pencil fish**

***Gold fish:*** These were the earliest domesticated ornamental fishes. Commonly the body colour is metallic red-orange. Dorsal and anal fins are relatively long based and the caudal fin is forked. These are omnivorous fishes occupying middle and lower level in the tank.

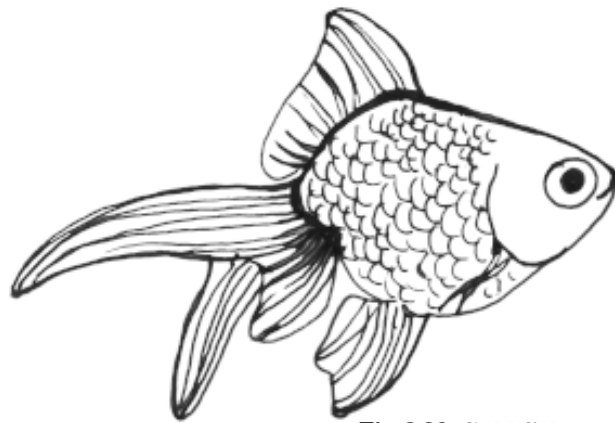

**Fig.8.20. Gold fish**

These fishes were developed in 11<sup>th</sup> century in China. Through selective feeding Chinese have developed several varieties of gold fishes such as comet, nymph, shubunkin bubble-eye, fan tail, lion head moor, pom-pom, vailtail etc.

***Koi fish*** : These are suited for outdoor aquaria. It is customary to view these fishes from above. Accordingly colour patterns have been developed. The adults are torpedo-shaped. The varieties include shiro-bekko, kohaku, taisho sanke etc.

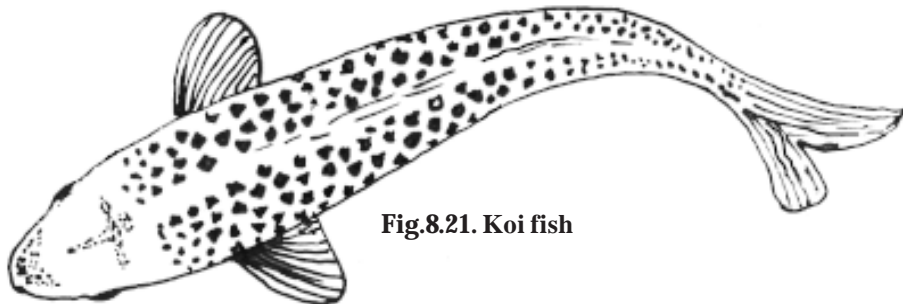

**Fig.8.21. Koi fish**

Other common ornamental fishes include barbs, danio, rasbora, shark, tetra, hatchet fish etc.

### **Feeding**

Sword tails, Kissing gourami and mollies feed on algae which grow around the stones and in water sources. Live protein-rich foods such as

Cyclops, tubifex worms, mosquito larvae etc. are considered as excellent food sources. Fresh foods such as chopped earthworm, fish paste, scraped boiled fish are also deemed to be good items. Artificial pelleted fish feeds can also be given to the aquarium fishes. It is always better to feed the aquarium fish with different kinds of foods. As far as the feedings is concerned, 'feed little but often' is the best method. Fish may be fed once or twice a day. Excess food and detritus may be removed 30 minutes after feeding by siphoning out with rubber tubing.

## Mariculture

The term mariculture refers to culture of marine organism in pollution free marine water. Generally, the mariculture practice is done at the edge of oceans inshore area. The optimum salinity range of mariculture is 30 - 35‰. The mariculture includes (i) floating culture (ii) raft culture (iii) racks culture (iv) pole culture (v) long line culture (vi) on-bottom culture (vii) coir rope net culture or nylon rope net culture

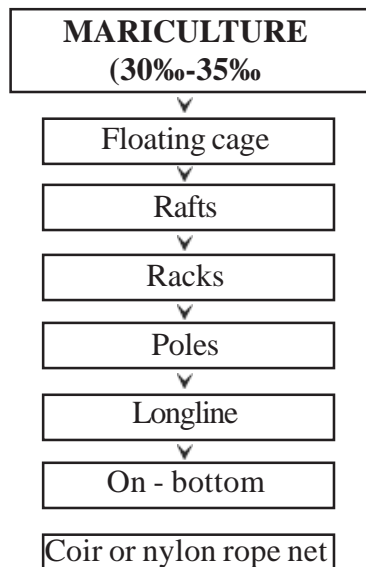

**Floating cage :** Cages are made of steel wire frame with nylon meshes. The split bamboo mats are also used as frames. The cages are left floating by means of strong floats. The fishes such as carps, cat fishes, anabas, tilapia are cultured in this method.



**Fig.8.22. Floating cage**

**Raft culture :** Rafts are usually constructed with casuarina or eucalyptus poles of chosen length. A raft of the size 6m x 5m is found to be suitable one. By this method oysters are cultured. The seeds of the oysters called ‘**spat**’ stick on to the rafts and grows up to its maturity.

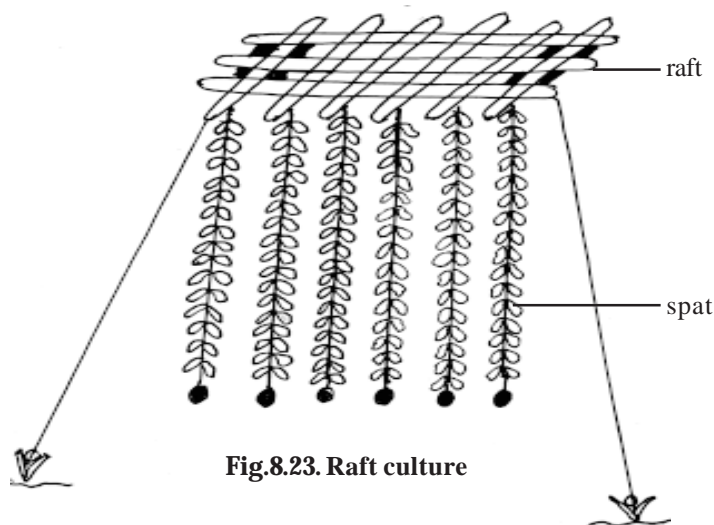

**Fig.8.23. Raft culture**

**Rack culture :** This culture method is possible only in shallow and calm sea of 2-4 meter depth. It is a fixed structure made of stake or eucalyptus poles. Cross and horizontal poles are arranged on the top of the poles and lashed with coir rope. The racks thus constructed remain always above the water. The overall size of the rack is 10mx10m. Oysters are cultured by using racks.

**Pole culture** : Wooden poles are placed upright in the inter tidal zone. In this method, ropes with spat attached are wound around large vertical poles called **bouchots**. Mussels and oysters are cultured by this practice.

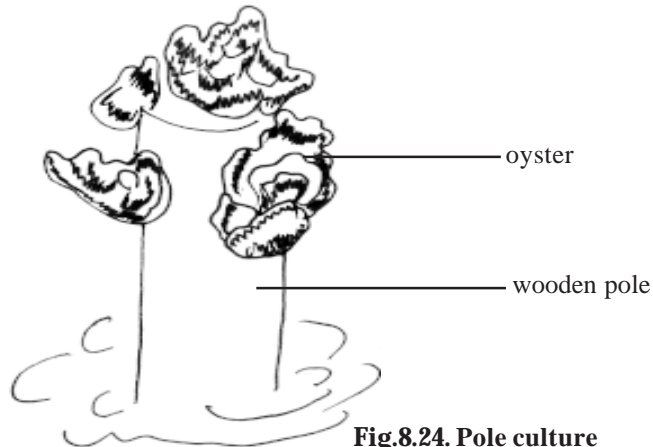

**Fig.8.24. Pole culture**

**Long line culture** : In this method about 60m rope is stretched horizontally near the water surface. This rope is anchored at both the ends with concrete blocks. Series of floats are fixed at 3m intervals on the rope. Vertical lines of 6m length seeded with mussel spats are hung between two floats in the main line. Mussels are being cultured by this method.

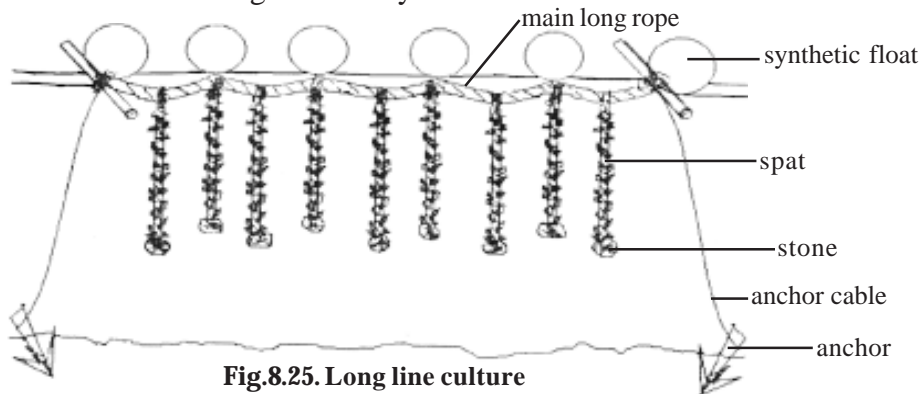

**Fig.8.25. Long line culture**

**On-bottom cultivation** : In on-bottom cultivation mussels are collected from the area of its abundance and then they are spread out at the area where lower density of the mussels occur.

**Coir or nylon rope net culture** : Coir or nylon ropes are fabricated in the form of nets and these nets are tied on fixed poles. Seaweeds are cultured by this technique.

***Some of the cultivable species in marine aquaculture:***

Sea weed : (i) *Porphyra texara*, (ii) *Gracilaria edulis*.

Edible oyster : (i) *Ostrea edulis*, (ii) *Crossostrea madrasensis*.

Pearl oyster : (i) *Pinctada fucata*, (ii) *P.margaritifera*.

Mussels : (i) *Mytilus edulis*, (ii) *Perna viridis*

Prawn : (i) *Penaeus indicus*, (ii) *P.monodon*.

Crab : (i) *Scylla serrata*.

Fishes : (i) *Chanos chanos*, (ii) *Mugil cephalus*.

Lobster : (i) *Panulirus polyphagus*, (ii) *P.homarus*

**Edible oyster**

*Crossostrea madrasensis* is the common edible oyster of India. It releases about 10-15 million eggs. It is cultured by rack and tray method. The water should have salinity range of 10-32‰. Water must be free from industrial and sewage pollution. The spat of edible oysters are allowed to grow to a larger size and kept in trays. These trays are placed immersed on the racks. Oysters of marketable size of about 90 mm length are obtained.

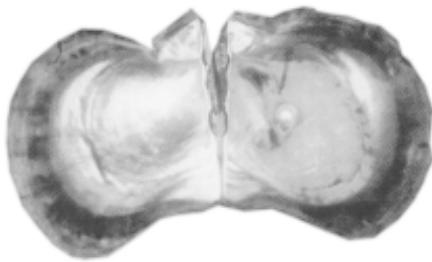

**Fig.8.26. Edible oyster**

Oyster meat is nutritious and it consists of 52% protein, 14% glycogen and 11% fat. Oyster powder contains wide range of minerals, vitamins and amino acids. It has been found to be good for skin care, numerous heart ailments, blood pressure, liver problem, arthritis and rheumatism.

## Pearl oyster

The most important among the pearl producing species are *Pinctada fucata* and *P.margaritifera*. In India cultured pearls were produced for the first time in 1973 at Tuticorin. They are sedentary animals. Pearl oysters are found along the coast of Capecomorin and in the Gulf of Kutch.



**Fig.8.27. Pearl oyster**

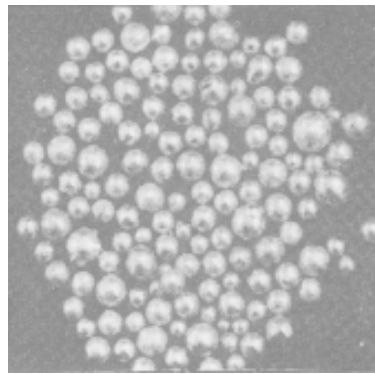

**Fig.8.28. Pearls**

Pearl oysters are farmed by racks, raft, and long line methods. The rack method of culture can be done where there is a depth up to 2.5 m. The remaining two methods are employed where there is 8 m and 15m depth respectively. Optimum salinity range for pearl oyster culture is 30‰. Since pearls are utilized for ornamental purposes, its culture is also a commercially important one.

## Seaweed culture

Seaweeds are marine algae. They are non-flowering plants without true roots, stem and leaves. Seaweeds occur on rocks, dead corals, stones, pebbles, solid substrata and on other plants. They grow abundantly in south coast of Tamilnadu, Gujarat coast, Lakshadweep and Andaman-Nicobar islands. There are also rich seaweed beds around Mumbai, Ratnagiri, Goa, Chinna Muttam, Idinthakarai, Uvari, Mandapam, Kovalam and Pulicat in Tamilnadu.

Being rich with minerals, vitamins, trace elements and bioactive substances seaweeds are called medicinal food of 21<sup>st</sup> century. As they are widely employed in many industries like food, confectionary, pharmaceutical, dairy, textiles, paper and paint, currently most of the countries have involved in

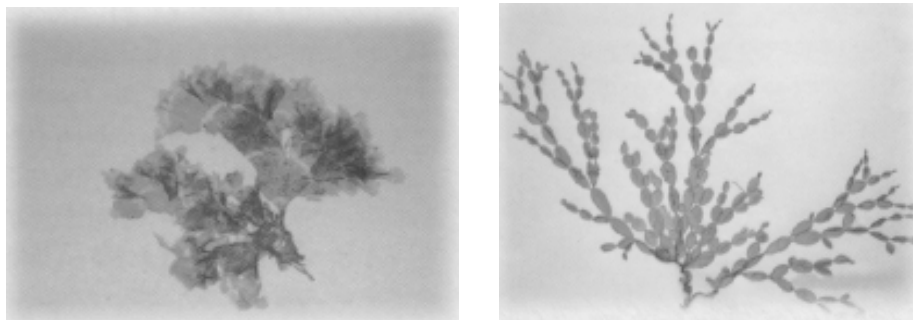

**Fig.8.29. Seaweeds**

seaweed culture practice. Large -scale seaweed culture is carried out only in Asia. China holds first rank in seaweed production. Seaweed has been a staple food in Japan and China for a very long time.

Some of the commercially important seaweeds cultured in Indian waters are, Gracillaria (red algae), Porphyra (red algae), Laminaria (brown algae) and Enteromorpha (Green algae).

Seaweeds are cultured by rope net made of coir or nylon and by long line rope methods. The fragments of the seed (plant) material are directly inserted in to the twists of the coir ropes. The seed- twisted coir or nylon ropes are fabricated in the form of nets and later they are tied to wooden poles fixed in the coastal waters. The seaweeds are then harvested after a period of 25- 60 days.

### **Marine ornamental fishes**

The marine ornamental fishes are inhabitants of coral and rocky areas of marine environment. They are abundant in Gulf of Mannar , Palk Bay and Gulf of Kutch in the mainland coast and in the Lakshwadeep and Andaman islands. In Lakshadweep Islands more than 300 species of attractive colours and shapes are available . Damsel fish, cardinal fish, groupers, unicorn fishes, butterfly fish, goat fish, gobies, squirrel fish, trigger fish, scorpion fish are available in Lakshadweep Islands . In Andaman group of Islands about 150 species of ornamental fishes are known to be available. Sat fish, bok fish, trigger fish, coral fish and spine foot are some species of this region. Gulf of Mannar and Palk Bay have several islands with extensive





Angel fish

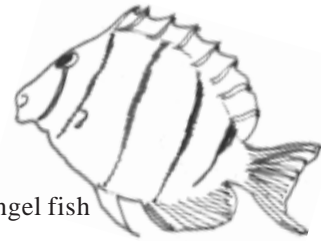

Regal angel fish

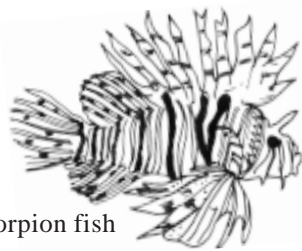

Scorpion fish



Butterfly fish

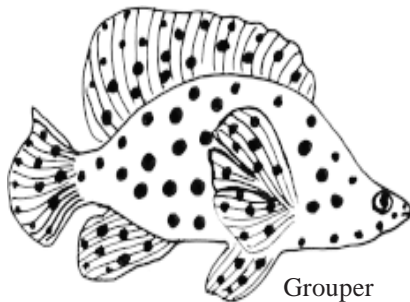

Grouper

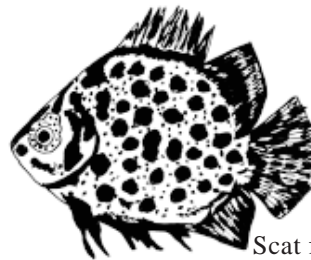

Scat fish

**Fig.8.30. Ornamental fishes**

coral reefs around them. About 100 species of ornamental fishes are found in this region.

### **Brackish water culture**

Brackish water is water that is saltier than fresh water, but not as salty as sea water. The culture of aquatic organisms in saline water having salinity range  $>0.5 - 30\text{‰}$  is known as brackish water culture. In brackish water areas, milk fish, sea bass, mullet, mugil species and prawns are cultured by installing bamboo or nylon enclosures. These enclosures are called **pens**. In brackish water, mussels and oysters are also cultured by pole, rack, raft and rope culture methods.

**Sea bass: (*Lates calcarifer*)**

The very prominent fish culture in brackish water is sea bass, which is also known as giant perch or cock-up. The popular name for seabass is “**koduva**” in Tamilnadu. It is a fast growing carnivorous fish. It attains average size of 1.0–1.2 kg in a year. Though sexes are separate, seabass is a protandrous hermaphrodite. Males are generally small and convert into females as they reach size above 5.0 kg. Matured seabass can be induced to spawn by hormonal technique.

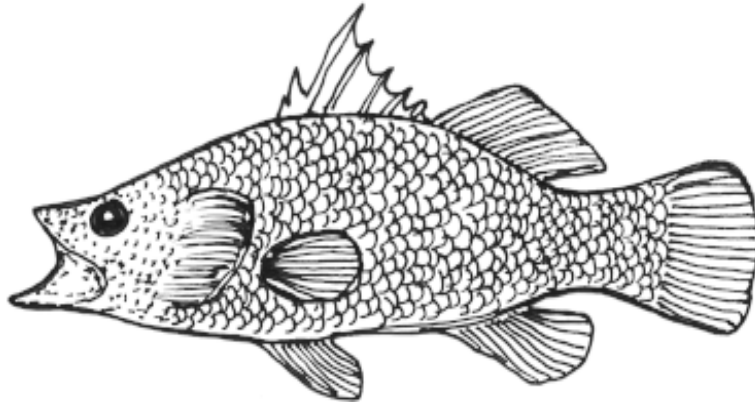

**Fig.8.31. Lates calcarifer**

The **Central Institute of Brackish water Aquaculture (CIBA)** has developed the hatchery technology for the first time in India. Sea bass can be cultured in saline and fresh water. They are cultured extensively in cages. Sea bass is also cultured in pond along with Tilapia in polyculture method.

**Metahaline culture**

Metahaline culture is practiced in areas where the water having the salinity range of 36-40 ‰. *Artemia salina*, small crustaceans, popularly known as *brine shrimp* are cultured in this culture system.



**Fig.8.32. Artemia salina**

They are the most popular live larval food currently used in the aquaculture industry. *Artemia salina* thrive well in salt lake and in salt pan.

### ***Aqua industry in India :***

In India aquaculture has been in progress for the past 5 decades. India's aquaculture industry is highly dependent on exports. World demand exceeds production and percapita consumption is also steadily increasing. Therefore India has great scope in expanding its aquaculture industry. There has been a remarkable improvement in the productivity level of aqua culture ponds from 600-800kg/ha/yr in 1960 to more than 2000 kg/ha/yr in the year 2002. This proves the existing prospect of aquaculture.

### ***Government and Non-Government organisations :***

Government organisations such as Tamilnadu state fisheries(TNSF), TamilNadu Agricultural Universities(TNAU), Central Marine Fisheries Research Institute(CMFRI), Central Institute of Brackishwater Aquaculture(CIBA), Aquaculture Foundations in India(AFI), Central Institute of Freshwater Aquaculture (CIFA) have involved in extensive research activities. Marine Product Export Development Authority(MPEDA), an autonomous body is responsible for the development of the marine products industry with special reference to exports.

Some of the non-governmental organisations and their role in aquaculture are as follows.

Aquaculture Certification Council A.C.C : To certify standards of aquaculture facilities at the international level.

International Coalition of Fisheries Association ICFA : In 2001, ICFA made the ecoliability resolution supporting the idea of labeling in fisheries and aquaculture.

### **Main environmental and public health concern:**

(i) The disease and parasites from farmed fish may spread to human population.

- (ii) The chemicals used to treat farm fish diseases affect food chain.
- (iii) The organic fish waste and excess of nutrients can deteriorate the water quality.
- (iv) When mangroves are converted into aquaculture field, it causes erosion and flooding and thereby alter the natural drainage pattern. It also increases the salt intrusion.

However the Food and Agricultural Organization (FAO) has made some progress in reducing the environment impact. It has made certain controls so that pollution is kept within acceptable limit. The aquaculture since it yields good food supply it should be maintained without impairing environment by better recycling of nutrients and less wastage generation.

## Self Evaluation (Sample Questions only)

### Unit - 1. Human physiology

#### Part - I

*Choose the correct answer :*

**1. Intake of less amount of protein leads to the deficiency disease called**

- a) Beri Beri                      b) Rickets                      c) Anaemia                      d) Kwashiorkor

**2. Each gram of lipid is capable of yielding.**

- a) 9.3 calories                      b) 8.2 calories                      c) 7.1 calories                      d) 6 calories

**3. Deficiency of vitamin D causes**

- a) Nyctalopia    b) Xerophthalmia                      c) Osteomalacia                      d) Pellagra

**4. The calorie requirement for IRM at heavy work during occupational activities is**

- a) 1100 calories    b) 750 calories                      c) 2200 calories                      d) 460 calories

**5. The normal BMI (Body mass index) range for adults is**

- a) 10 - 15                      b) 12 - 24                      c) 15 - 20                      d) 19 - 25

**6. The normal blood glucose level during fasting is**

- a) 70 to 110 mg/dl    b) 80 to 200 mg/dl                      c) 100 to 150 mg/dl                      d) 200 to 250 mg/dl

**7. During emulsification, the bile salts convert bigger fat particles into smaller globules called**

- a) granules                      b) oil                      c) chylomicrons                      d) millimicrons

**8. During root canal treatment, the cavity of the tooth is filled with a sealing paste made of**

- a) chitin                      b) calcium carbonate                      c) iodised salt                      d) gutta-percha resin

**9. The gall stones are formed of**

- a) calcium    b) growing infected tissue    c) cholesterol    d) sodium crystals

**10. A fracture can be caused by**

- a) shock                      b) loss of blood supply    c) impact of force                      d) malnutrition

**11. The granulation of tissues around the site of fracture is called**

- a) nodule                      b) papilla                      c) rudiment                      d) callus

**12. An inflammation of synovial membrane is called as**

- a) infective arthritis
- b) osteoarthritis
- c) rheumatic arthritis
- d) mechanical arthritis

**13. During the contraction of muscle the ATP molecules bind with the active site of**

- a) myosin filament
- b) myofibrils
- c) nerve endings
- d) actin filaments

**14. Ca ions necessary for the contraction of muscles are released from**

- a) blood
- b) protoplasm
- c) synovial membrane
- d) sarcoplasmic reticulum

**15. What is the substance that destroys the muscle protein during rigor mortis**

- a) proteolytic enzymes
- b) mitochondrial enzymes
- c) lysosome enzymes
- d) esterases

**16. The surface area of skin in our body is**

- a) 1.1-2.2m<sup>2</sup>
- b) 2.2-3.3m<sup>2</sup>
- c) 1-2m<sup>2</sup>
- d) 0.5-1.5m<sup>2</sup>

**17. An oily substance called sebum is secreted by**

- a) sweat gland
- b) sebaceous gland
- c) thyroid gland
- d) tear gland

**18. Albinism is an extreme degree of generalized**

- a) hyperpigmentation
- b) hypopigmentation
- c) failure of pigmentation
- d) perioral pigmentation

**19. Partial albinism causes**

- a) leucoderma
- b) vitiligo
- c) melanoma
- d) dermatitis.

**20. Excessive exposure to U V-rays can cause**

- a) vomiting
- b) redness of eyes
- c) colour change
- d) skin cancer

**21. Rag weed plant causes allergic responses and results in**

- a) photo dermatitis
- b) herpetiformis dermatitis
- c) dermatitis artefacta
- d) all the above

**22. The amount of urea present in blood**

- a) 0.02gms/100ml
- b) 0.06gms/100ml
- c) 0.08gms/100ml
- d) 0.01gms/100ml

**23. Urea biosynthesis takes place in**

- a) blood
- b) liver
- c) cerebro-spinal fluid
- d) kidney

**24. Number of ATP molecules spent to convert ammonia to urea is**

- a) four
- b) two
- c) three
- d) one

**25. During glomerular filtration the malpighian body acts like a**

- a) structural unit
- b) biological filter
- c) biological buffer
- d) acid-base balancer

**26. The amount of blood supplied to the kidneys is about**

- a) 20-25% of cardiac output
- b) 25-30% of cardiac output
- c) 30-35% of cardiac output
- d) 35-40% of cardiac out put

**27. Net filtration force which is responsible for the filtration in glomerulus is**

- a) 25mm Hg
- b) 50mm Hg
- c) 75mmHg
- d) 80 mm Hg

**28. The amount of urea reabsorbed in the urinary tubules is**

- a) 5gm
- b) 17gm
- c) 21gm
- d) 20gm

**29. Area responsible for reabsorption of water, glucose, sodium phosphate and bicarbonates is**

- a) glomerulus
- b) proximal convoluted tubules
- c) collecting duct
- d) descending limb of Henle's loop

**30. The volume of water found in the glomerular filtrate is**

- a) 170 lit
- b) 168.5 lit
- c) 165 lit
- d) 162.8 lit

**31. In recent days insulin resistant diabetes is commonly noticed in the age group of**

- a) 10-15years
- b) 40-50years
- c) 35 - 40 years
- d) 20-25years

**32. The type of diabetes that develops due to heavy viral infection belongs to the category called**

- a) Insulin dependent diabetes
- b) non-insulin dependent diabetes
- c) inflammator diabetes
- d) harmful diabetes

**33. Which of the following is called artificial kidney?**

- a) donar kidney
- b) dializer
- c) tissue-matched kidney
- d) preserved kidney

### **Part - II**

1. Define carbohydrates and mention their compositions.
2. Classify different types of monosaccharides ?
3. What are polysaccharides ? Give examples.
4. List out the essential aminoacids.
5. What is kwashiorkar? Mention its symptoms.

6. State the functions of lipids?
7. What is PUFA? Mention its significance
8. Name different types of vitamins.
9. Write down the expansions of IRM and IRW? and their characteristic features.
10. What is obesity?
11. Define BMI
12. Write down the symptoms for hypoglycemia
13. What are chylomicrons ?
14. Name the substances used in treating the tooth decay
15. What are the benefits of root-canal treatment
16. What is peptic ulcer ?
17. What is gall stone made up of ?
18. State the main symptoms for appendicitis
19. What is meant by hepatitis?
20. Mention the reasons / causes for liver cirrhosis.
21. What is meant by stress fracture ?
22. Define the term physiotherapy.
23. What does the term orthopedics refer to ?
24. Name the fluids in the chambers of the eye.
25. Name the parts involved in altering the curvature of the lens.
26. What is short sightedness?
27. How do you name the problems related to retina?
28. Identify two reasons for cataract.
28. What is CLR?
30. What is nyctalopia?
31. What is a pink eye?
32. What is Reissner's membrane?
33. Which region of brain perceives sound?
34. Give two reasons for loss of hearing.
35. What is a bone conduction hearing aid.



36. Name the causes for noise pollution.
37. Define permissive noise level.
38. What happens during ventilation in the lungs?
39. Name the muscles involved in respiration.
40. Write down the composition of inhaled and exhaled air.
41. What is Herring - Breuer reflex?
42. Name the microbes that cause pneumonia.
43. What is pleurisy?
44. What is pulse rate?
45. Mention the reason for doing an angiogram.
46. What is coronary angioplasty?
47. What is done during Echo cardiography?
48. What is arthrosclerosis?
49. How can pulse rate be calculated ?
50. Write down the importance of cardio pulmonary resuscitation.
51. Classify the lymphocytes of blood and mention their key function.
52. What are called coagulation factors?
53. Differentiate embolus from thrombus.
54. What is menstrual cycle?
55. What is corpus albicans?
56. With whom does the technique of invitro fertilization adopted?

### **Part - III**

1. List out different types of carbohydrates and their significance?
2. What are proteins ? Briefly explain.
3. Why is water necessary for man ?
4. Briefly explain the importance of minerals.
5. Tabulate the calorie requirement of IRM and IRW being sedentary workers, moderate workers and heavy workers.
6. What are the factors responsible for obesity?

7. Briefly explain the mode of digestion in duodenum.
8. Write short notes on villi and their significance
9. Write short notes on different types of Hernia
10. Give an account of root-canal therapy.
11. Explain different types of bone fractures.
12. Write short notes on the three phases in healing of bones in fracture.
13. Explain the various factors attributed for bone joint dislocations.
14. Describe the different types of arthritis
15. Describe the structure of sarcomere
16. What are the benefits of aerobic exercise?
17. Write down the various types of memory.
18. "Sleep is a state of unconsciousness" - substantiate your statement.
19. Write short notes on 'Stroke'
20. Explain briefly the right and left brain concept.
21. Describe the mechanism of reflex action
22. Write a brief account on cerebro spinal fluid and its importance
23. Define the terms transduction, transducer stimulus and response.
24. What is accommodation of eye?
25. Describe the photochemistry of retina.
26. Differentiate myopia and hypermetropia.
27. What is retinopathy? Comment on its types.
28. Give an account of diagnosis and treatment of cataract.
29. What is lens replacement?
30. Write short notes on conjunctivitis.
31. Suggest methods for eye care.
32. Define sound and sound perception.
33. Describe the role of middle ear in hearing.
34. What are hearing aids?
35. Write notes on the gustatory receptors.
36. Explain the different processes involved in pulmonary respiration.

37. Write short notes on exchange of gases in alveoli.
38. Comment on the sequences of events during the regulation of respiration.
39. Explain briefly different types of bronchitis.
40. Write short notes on cardiac cycle.
41. Comment on the importance of ICCU.
42. Describe briefly endocrine function of testes.
43. Describe the process of ovulation and the fate of empty graffian follicle.
44. Write short notes on in vitro fertilization

#### **Part - IV**

1. Explain the digestive processes taking place in small intestine.
2. Describe the mode of digestion of protein.
3. Enumerate the steps involved in root canal treatment.
4. Write an essay on any two disorders connected with the digestive system.
5. Give an account on fracture and the healing method.
6. Describe various types of arthiritis and their causes.
7. Write an essay on muscle contraction.
8. Write an essay on focussing mechanism in the human eye.
9. Discuss the role of rods and cones in visual perception.
10. Enumerate the various eye defects. Comment on corrective measures.
11. Describe the functional morphology of the organ of corti.
12. Write an essay on hearing loss and the correcting measures adopted.
13. Make a critical study of noise as an atmospheric pollutant.
14. Describe the mechanism of breathing with proper illustration.
15. Enumerate the events involved in the function of the human heart.
16. Write an essay on composition of blood.
17. Describe the various functions of the human male reproductive system.
18. Write an essay on menstrual cycle.
19. comment on various schemes suggested by the National Family Welfare Programmes and their importance.

## Unit 2. Micro Biology

### Part I

*Choose the correct answer.*

**1. Who first developed vaccine for rabies in man ?**

- a) Robert Koch
- b) Joseph Lister
- c) Louis Pasteur
- d) Stanley

**2. Which one of the following fields paved the way for modern microbiology ?**

- a) development of vaccines
- b) technique of new viral strains
- c) discovery of new viral strains
- d) development of pure culture technique

**3. Which one of the following statements is incorrect regarding the structure of viruses ?**

- a) Nucleic materials are covered by a protein coat, called capsid.
- b) The capsid is made up of capsomeres
- c) Some animal viruses have an additional envelope
- d) The additional envelope is made up of glycoprotein

**4. Virions contain only a single copy of nucleic acid, hence they are called**

- a) incomplete viruses
- b) haploid viruses
- c) ploidy viruses
- d) complete viruses

**5. Tumour inducing viruses are called**

- a) Pathogenic viruses
- b) oncogenic viruses
- c) Para viruses
- d) variola viruses

**6. Which one of the following is a protozoan disease ?**

- a) African sleeping sickness
- b) Measles
- c) Cholera
- d) Taeniasis

**7. Sexual reproduction of plasmodium takes place in**

- a) liver cells of man
- b) RBCs of man
- c) Plasma of man
- d) body of mosquito

**8. The pathogenic form of Entamoeba histolytica is**

- a) encysted spores
- b) vegetative trophozoite
- c) merozoite
- d) schizont

**9. Which one of the following is a trematode worm ?**

- a) Schistosomes
- b) Wuchereria
- c) Taenia
- d) Ascaris

**10. The more promising chemotherapeutic agent for treating viral diseases is**

- |                 |                |
|-----------------|----------------|
| a) Tetracycline | b) Ampicillin  |
| c) Interferon   | d) Anthramycin |

**Part II**

1. Define microbiology.
2. Mention the use of pure culture technique ?
3. What is meant by diploid cell strain ?
4. Classify different types of malaria.
5. What is amoebiasis ?
6. What does the term 'Zooanthroponoses' refer to ?
7. List out notable antibiotics.
8. Enumerate the methods of diagnosis of AIDS.
9. Write the characteristics of species resistance.
10. Define zoonoses.

**Part III**

1. Briefly describe the structure of virus.
2. Write short notes on viral diseases in man.
3. Give a brief account of life cycle of *Schistosoma haematobium*.
4. Write an account on history of discovery and structure of HIV.
5. Enumerate the adaptations of pathogenic microbes.
6. Write the symptoms of AIDS, defined by WHO.
7. Write a note on control and preventive measures of AIDS.

**Part IV**

1. Give an account on cultivation of animal viruses
2. "Malaria-a major public health problem" - discuss.
3. Write an essay on Pathogenicity of micro organisms and infections.

## Unit 3. Immunology

### Part I

*Choose the correct answer*

**1. Which of the following can induce immunity**

- a) bacteria
- b) viruses
- c) parasites
- d) all the above

**2. Skin is a/an**

- a) anatomical barrier
- b) physiological barrier
- c) phagocytic barrier
- d) inflammatory barrier

**3. Which among the following is anti-bacterial ?**

- a) interferon
- b) lysozyme
- c) hormone
- d) protein

**4. Which of the following is anti-viral**

- a) lysozyme
- b) interferon
- c) protein
- d) hormone

**5. Identity the phagocytic cells from the following combinations**

- a) Macrophage and neutrophil
- b) Lymphocyte and eosinophil
- c) Macrophage and eosinophil
- d) Eosinophil and neutrophil

**6. Histamine is secreted by**

- a) Epithelial cell
- b) Mast cells
- c) Red blood cells
- d) white blood cells

**7. Humoral immunity consists of**

- a) normal cells
- b) pathological cells
- c) cytotoxic cells
- d) immunoglobulin molecules

**8. Which type of graft is used in plastic surgery ?**

- a) xenograft
- b) allograft
- c) autograft
- d) isograft

**9. MHC genes in mouse is located in**

- a) Chromosome 1
- b) Chromosome 2
- c) Chromosome 4
- d) Chromosome 6

**10. Which of the following is an auto immune disease ?**

- a) AIDS
- b) Multiple sclerosis
- c) Cancer
- d) Asthma

**11. Which antibody characterizes the allergic reaction**

- a) IGG
- b) IGA
- c) IGM
- d) IGE

**12. SCID is due to**

- a) Adenosine deaminase deficiency
- b) Glucose oxidase deficiency
- c) Phosphatase deficiency
- d) Lactate dehydrogenase deficiency

**13. Which of the following causes AIDS ?**

- a) Bacteria
- b) Fungus
- c) Retro virus
- d) TMV

**14. Thymus growth occurs up to**

- a) 17 years
- b) 12 years
- c) 5 years
- d) 30 years

**15. Which of the following secretes immunoglobulin**

- a) T-lymphocyte
- b) B-lymphocyte
- c) Macrophage
- d) Mast cells

**16. The H-chain of immunoglobulin has a molecular weight**

- a) equivalent to that of light chain
- b) Twice that of light chain
- c) Triple the amount of light chain
- d) Twice as that of dark chain

**17. Immunoglobulins are chemically**

- a) glycogens
- b) glyco-proteins
- c) glycolipids
- d) Lipo-proteins

**18. Hyper variability regions are present in**

- a) heavy chain only
- b) light chain only
- c) heavy and light
- d) dark chain

**19. Organ transplantation from pig to human is an example for**

- a) Autograft
- b) Allo-graft
- c) ISO-graft
- d) Xeno-graft

**20. Graft between identical twins is called**

- a) Xeno-graft
- b) Allograft
- c) Auto graft
- d) Iso graft

**Part - II.**

1. What is Immunology ?
2. What are the four types of infectious agents ?
3. Define innate immunity
4. What is lysozyme ?
5. What is phagocytosis ?
6. What is acquired immunity ?
7. Differentiate cell mediated and humoral immunity.

8. Differentiate active and passive adapted immunity.
9. What are the immunoglobins ?
10. What are the three main functions of antibodies ?
11. State the functions of spleen.
12. What is an immunogen ?
13. Define the term 'antigen' ?
14. What are haptens ?
15. Distinguish paratope and epitope.
16. Name the five classes of immunoglobins.
17. Distinguish the variable and constant region in the IG molecule.
18. Distinguish autograft and allograft.
19. How does Xenograft differ from Isograft ?
20. What are immuno suppressant drugs ?

#### **Part - III**

1. What are the specific features of adaptive immunity and specific immunity ?
2. Draw a labelled sketch of the structure of immunoglobulin.
3. Give an account of the structure and functions of immunoglobulin.
4. Briefly describe the genetic basis of tissue transplantation.
5. What are the symptoms of graft rejection ?
6. Give an account of immuno deficiency diseases.
7. Describe Bursa of Fabricius ?
8. What are the anatomical and physiological barriers in first line defence ?

#### **Part - IV**

1. Write an essay on lymphoidal organs and their functions.
2. Critically evaluate the transplantation immunology.
3. Write an essay on natural innate immunity
4. Give an account of the mechanisms of acquired immunity.

### **Unit 4. Modern Genetics**

#### **Part I**

*Choose the correct answer.*

**1. In which prokaryote has voluminous genetical works been made**

- |                     |                      |
|---------------------|----------------------|
| a) TMV virus        | b) Phage             |
| c) Escherichia coli | d) coliform bacteria |



**2. Who discovered the double helix DNA model ?**

- a) G.H. Khorana
- b) Mendel
- c) T.H.Morgan
- d) Watson and Crick

**3. About how many hereditary diseases in human beings had been identified ?**

- a) more than 300
- b) less than 300
- c) about 400
- d) about 100

**4. To obtain information about genetic characters in man which of the following helps?**

- a) Biochemical test
- b) Hybridization
- c) Pedigree analysis
- d) Inbreeding

**5. Sickle cell anaemia is due to**

- a) autosomal gene
- b) sex chromosomal gene
- c) vitamin deficiency
- d) hormone imbalance

**6. Albinism is due to**

- a) absence of melanin
- b) absence of vitamins
- c) presence of melanin
- d) absence of hormone

**7. Name the human disease due autosomal dominant gene**

- a) sickle cell anaemia
- b) thalasemia
- c) SCID
- d) huntington's chorea

**8. Idiogram means**

- a) Diagrammatic representation of genes
- b) Diagrammatic representation of chromosome
- c) Graph showing heart defect
- d) electro cardiogram

**9. In human chromosome karyotyping the chromosomes 4 and 5 belong to group**

- a) A
- b) B
- c) C
- d) D

**10. What is the name for mobile genetic elements**

- a) plasmids
- b) pili
- c) barr body
- d) transposons

**Part II**

1. What is pedigree analysis ?
2. What are the clinical manifestations of thalassemia ?
3. Mention any two uses of karyotyping
4. What is foreign DNA in genetic engineering ?

5. What are cloning vectors ?
6. Name the bacterial species employed in genetic engineering.
7. What is called DNA segmenting ?
8. What is called differentiation ?
9. What is gene therapy? Name the two types of gene therapy.
10. What is a data base in bioinformatics ?

#### **Part III**

1. Give an account of albinism and SCID.
2. What are the seven groups in human chromosome karyotyping? Mention their respective schromosomes ?
3. What are the uses of recombinant DNA technology.
4. Mentions the ethical problems of cloning.

#### **Part IV**

1. Write an essay on DNA recombinant technology
2. Illustrate with example the cloning mechanism.
3. Give an account of human genome project.
4. Write an essay on bioinformatics.
5. Write an essay on protein structure and protein model and its uses.

### **Unit 5. Environmental Science**

#### **Part I**

**Choose the correct answer**

**1. What is the rate of growth of human population ?**

- |                        |                        |
|------------------------|------------------------|
| a) 10 billion per year | b) 90 billion per year |
| c) 1 billion per year  | d) 80 billion per year |

**2. The present sudden acceleration of population is called as**

- |                         |                    |
|-------------------------|--------------------|
| a) population explosion | b) population bomb |
| c) population trap      | d) all the above   |

**3. Global warming is caused due to**

- |                                    |                                      |
|------------------------------------|--------------------------------------|
| a) lack of rainfall                | b) presence of a hole in ozone layer |
| c) human activities against nature | d) extinction of animals and plants  |

**4. The most abundant green house gas is**

- |                    |                    |
|--------------------|--------------------|
| a) NO <sub>2</sub> | b) CO <sub>2</sub> |
| c) O <sub>3</sub>  | d) SO <sub>2</sub> |

**5. Which of the following gas destroys ozone layer faster ?**

- a) chlorofluorocarbons
- b) hydrochlorofluoro carbons
- c) both (a) and (b)
- d) sulphur dioxide

**6. Which is a better method to dispose large amounts of water carrying relatively small amounts of chemical wastes?**

- a) land filling method
- b) Deep-well injection
- c) Surface impoundments
- d) incineration

**7. Which one of the following organisms plays vital role in pollination of trees in tropical forest?**

- a) mimic moths
- b) orchid bees
- c) Rhinoceros beetles
- d) Humming birds

**8. Which is commonly considered as a biologists paradise?**

- a) Gulf of Mannar Biosphere Reserve
- b) Nilgiri Biosphere Reserve
- c) Nanda Devi
- d) Great Nicobar

**9. The amount of energy the earth receives from the sun, per year is**

- a) 1000 K calories
- b)  $10 \times 10^{30}$  K calories
- c)  $5 \times 10^{20}$  K calories
- d)  $15 \times 10^{25}$  K calories

**10. Which is considered as a future source of power, that can meet our unlimited demand ?**

- a) Hydel power
- b) Hydrogen
- c) Thermal power
- d) Solar power

**11. Of the total amount of water, how much is available as fresh water?**

- a) 10 %
- b) 3%
- c) 15%
- d) 50%

**12. Which of the following countries depend on desalination process for getting fresh water?**

- a) Dubai
- b) Oman
- c) Bahrain
- d) all the above

## Part II

1. Define ecology.
2. How does population growth differ from food production?
3. What is known as global warming?
4. What are the effects of ozone depletion?
5. How is the sewage water treated by primary treatment method?
6. What is bio-diversity?
7. Write the characteristics of a bioserve.
8. List out the names of bioserves of India.

9. What is known as geothermal energy?
10. What are the advantages of solar energy?
11. What is known as relative poverty?
12. What is meant by seeding of clouds?

### **Part III**

1. Write short notes on growing population and its impact on environment.
2. List out the effects of global warming.
3. "Ozone is a natural sun block" - Discuss.
4. Write about the various types of wastes.
5. Write short notes on waste water treatment and management.
6. Briefly describe the reasons for decline of biodiversity.
7. Write an account of fresh water resources.

### **Part IV**

1. Write an essay on green house gases and their impact on the environment.
2. How will you manage hazardous wastes? Discuss it with current knowledge.
3. What is known as energy crisis? what are the steps to be taken to solve energy crisis?
4. Give an account on poverty?
5. "Conservation of freshwater" - Discuss.

## **Unit 6. Applied Biology**

### **Part I**

*Choose the correct answer*

**1. The breeds of cattle now available in India are**

- |       |       |
|-------|-------|
| a) 29 | b) 30 |
| c) 26 | d) 20 |

**2. Which one of the following is not a draught breed?**

- |             |             |
|-------------|-------------|
| a) Kangayam | b) Khillar  |
| c) Kankrej  | d) Hallikar |

**3. The other name for the cattle sindhi is**

- |                |            |
|----------------|------------|
| a) Kongu       | b) Nellore |
| c) Red karachi | d) Decan   |

**4. Kangayam originated from**

- |              |               |
|--------------|---------------|
| a) Punjab    | b) Coimbatore |
| c) Karnataka | d) Kathiawar  |

**5. Which of the following is not an exotic breed?**

- a) Jersey
- b) Gir
- c) Brown swiss
- d) Ayreshire

**6. Which one of the following is a contagious disease of the cattle?**

- a) constipation
- b) milk fever
- c) cow pox
- d) diabetes

**7. Feeding jaggery along with lime water is one of the first aid measure for**

- a) Diarrhoea
- b) constipation
- c) milk-fever
- d) anthrax

**8. Mating of closely related animals is called**

- a) outbreeding
- b) artificial insemination
- c) cross breeding
- d) Inbreeding

**9. The milk which the following cow is characterised by high carotene content?**

- a) Sindhi
- b) Haryana
- c) Gir
- d) Jersey

**10. For anthrax one of the following symptom can be seen**

- a) swelling of udder
- b) blood discharge from natural openings
- c) loss of appetite
- d) lack of chewing

**11. Apis indica is**

- a) India bee
- b) African bee
- c) European bee
- d) Rock bee

**12. Bee milk is produced by**

- a) Drones
- b) Queen
- c) Worker
- d) An adult bee

**13. Sterile females are**

- a) Queen
- b) Worker
- c) Drone
- d) Both Queen and Worker

**14. Stingless bees are**

- a) Queen
- b) Drone
- c) Worker
- d) Both Drone and Worker

**15. Modern bee hive consists of**

- a) 5 Compartments
- b) 4 Compartments
- c) 6 Compartments
- d) 7 Compartments

**16. Equipment used for spinning the comb is**

- a) Beeveil
- b) Bee brush
- c) Honey extractor
- d) Bee gloves

**17. The resin is the component of**

- a) Bee venom
- b) Bee bread
- c) Bee glue
- d) Bee milk

**18. The disease Nosema apis is caused by**

- a) Bacteria
- b) Protozoa
- c) Fungus
- d) Virus

**19. Bee bread is a mixture of**

- a) Nectar and water                      b) Nectar and pollen  
c) Pollen and royal jelly                d) Propolis and royal jelly.

**20. One of the bee hive product used for apitherapy**

- a) Propolis            b) Royal jelly            c) Bee venom            d) Pollen

**Part II**

1. What is meant by dairy operations?
2. How are cattles classified ?
3. Compare the udder of Sindhi with kangayam.
4. How are dual purpose breeds helpful for mankind.
5. Write down the origin and distribution of the cattle kangayam.
6. How will you identify a healthy cattle?
7. Mention the bacterial disease of cattle and its symptoms.
8. What are the control measures of cow pox?
9. What is the first aid given to cattle for constipation?
10. List out the different types of diseases of cattle.
11. Define draught breeds.
12. What are the advantages of artificial insemination?
13. What is artificial insemination?
14. Define outbreeding.
15. Define cross breeding.
16. Compare the bullocks of Sindhi, Ongole and Kangayam.
17. Define breed.
18. Define Sericulture.
19. Name the types of silk.
20. What is fibroin?

21. What is sericin
22. What are the three stages of sericulture ?
23. What is the function of salivary gland of silk worm?
24. What is cocoon?
25. What is instar?
26. What is imago ?
27. What is spinneret?

### **Part III**

1. Describe a dual purpose breed.
2. What is meant by exotic breeds? compare the lactational capacity of this breed with milch breed?
3. How does contagious disease differ from non contagious disease. Describe any one of the non contagious diseases of cattle in detail?
4. What is the importance of dairy technology?
5. Write short notes on artificial insemination.

### **Part IV**

1. Give an account on dairy breeds.
2. Write an essay on common diseases of cattle.
3. Discuss the various techniques adopted in cattle breeding.

## **Unit 7. Theories of Evolution**

### **Part I**

*Choose the correct answer*

**1. The book 'Philosophie Zoologique' was published by**

- |                   |                             |
|-------------------|-----------------------------|
| a) Charles Darwin | b) August Weismann          |
| c) Mc Dougall     | d) Jean Baptiste de Lamarck |

**2. The German scientist who segregated germplasm from somatoplasm for the first time was**

- |             |                  |
|-------------|------------------|
| a) Lamarck  | b) Malthus       |
| c) Weismann | d) Hugo de vries |

**3. Mc Dougall supported neo-lamarckism and proved the concept of**

- a) Direct action of environment on organism
- b) Learning is an acquired character
- c) Speed of learning increased from generation to generation
- d) All the above

**4. Darwin supported the following concepts for evolution**

- a) arrival of the fittest
- b) survival of the fittest
- c) The differentiation of somatoplasm germplasm
- d) genetic recombinations

**5. The book “Process of organic evolution” to support modern synthetic theory of evolution was provided by**

- a) Dobzhansky
- b) Stebbins
- c) Hardy-weinberg
- d) Hugo de vries

**6. The factor that enriches the genepool with new modified genes**

- a) mutation
- b) somatic variation
- c) decrease in chromosomes
- d) increase in cytoplasm

**Part II**

1. State the theory of Lamarck.
2. Define the law of use and disuse.
3. Quote the facts of neo-lamarckism.
4. Define the germ plasm theory.
5. State the view of McDougall.
- 6.. What is meant by “survival of the fittest”?
7. Mention any two objections to Darwinism.
8. Mention the significance of neo- Darwinism.
9. State the modern synthetic theory.
10. What is meant by “gene pool”?
11. Name two books that explain the basic concepts of evolution.
12. What is meant by chromosomal aberration?
13. State the law of genetic drift.
14. What is a species?
15. Define founder principle.



### Part III

1. Write short notes on neo-Lamarckism.
2. Describe the modern concept of Natural selection.
3. Write down the mechanism that prevents inter specific crosses.
4. Briefly describe Sewal Wright effect.
5. Give an account of different types of species.

### Part IV

1. Enumerate the principle of Lamarckism in support of evolution.
2. What are the conditions under which Hardy-Weinberg law operates?
3. Write an essay on theory of Natural selection.

## Unit - 8 Aquaculture

### PART - I

#### 1. The fish cultured in fresh water is

- a. rohu                      b. mugil                      c. lobster                      d. milk fish

#### 2. In fresh water aquaculture the salinity of the fresh water should be

- a.  $>0.50^0/_{00}$                       b.  $>0.55^0/_{00}$                       c.  $<0.50^0/_{00}$                       d.  $<0.55^0/_{00}$

#### 3. In metahaline aquaculture the salinity range will be

- a.  $30-40^0/_{00}$                       b.  $36-42^0/_{00}$                       c.  $30-40^0/_{00}$                       d.  $35-40^0/_{00}$

#### 4. Which one of the following is an exotic fish.

- a. catla                      b. rohu                      c. tilapia                      d. mugil

#### 5. Which one of the following culture practice takes place in cold water.

- a. ornamental fish culture                      b. race way culture  
c. sport fish culture                      d. larvivorous fish culture

#### 6. The size of fry is

- a.  $< 2.0\text{cm}$                       b.  $< 2.2\text{cm}$                       c.  $< 2.5\text{cm}$                       d.  $< 2.7\text{cm}$

#### 7. The possible temperature range for survival of different fishes is

- a.  $14-15^0\text{C}$                       b.  $10-37^0\text{C}$                       c.  $5-9^0\text{C}$                       d.  $10-15^0\text{C}$

#### 8. The usual size of fish cultured in nursery pond is

- a. less than 2.5 cm.                      b. more than 1.5 cm.  
c. less than 1cm                      d. more than 4 cm

#### 9. The maximum permissible density of hatchlings is

- a. 10.5 million /ha                      b. 10 million/ha                      c. 10 billion / ha                      d. 1million / ha

#### 10. The Indian major carp can survive in a temperature range of

- a.  $14-15^0\text{c}$                       b.  $5-9^0\text{c}$                       c.  $13-14^0\text{c}$                       d.  $16-25^0$

**11. Ideal pH range for pond water is**

- a. 6.5-9            b. 3.5-4.5            c. 4.5-5.5            d. 5.5-6.5

**12. The suitable hardness for pond water is**

- a. 17 ppm            b. 14ppm            c. 13 ppm            d. 12ppm

**13. *Macrobrachium rosenbergii* can be identified by the presence of**

- a. 1-7 horizontal lines on the carapaca            b. 1-6 horizontal lines on the carapaca  
c. 1-8 horizontal lines on the carapaca            d. 1-9 horizontal lines on the carapaca

**14. In the absence of natural food, which of the following organism become cannibals.**

- a. *Penaeus indicus*            b. *Scylla serrata*  
c. *Catla-catla*            d. *Macrobrachium rosenbergii*

**15. The preparation of pituitary extract is done by**

- a. Homogeniser    b. Distillation    c. Hypophysation    d. Dehydration

**16. The preferable age group for the selection of breeder in hypophystation technique is**

- a. 4-5 years            b. 5-6 years            c. 2-4 years            d. 1-2 years.

**17. The quantity of second dose of pituitary extract lies in the range of**

- a. 5-8 mg/kg            b. 3-4 mg/kg            c. 2-3 mg/kg            d. 2-5 mg/kg

**18. Blindness and haemorrhage are the symptoms for**

- a. Costiasis            b. Dropsy            c. Gillrot            d. Saprolegniasis

**19. The aerator in the aquariam keeps the water**

- a. Warm            b. Oxgenated            c. free from turbidity            d. free form ammonia

**20. The salinity range 3‰ to 29‰ may prevail in the culture of**

- a. mugil            b. mussels            c. artemia salina            d. milk fish

## **Part II**

1. What is Aquaculture?
2. What are the major types of Aquaculture methods?
3. Define mariculture?
4. Distinguish between fresh water & marine water?
5. Define integrated fish culture?
6. Name the culturable organisms of freshwater aquaculture?
7. What are bunds?
8. What are the components of a typical pond?
9. What is the structure of a nursery pond and its nature of utilisation?
10. What are the physical & chemical factors of culturable pond?

11. Name 4 species of freshwater culturable organisms.
12. What is hypophystation?
13. What is called Hapa?
14. What is spawning?
15. What is dropsy?
16. What is costiasis?
17. What is gill-rot?
18. What is called spat?
19. What are called bouchots?
20. Name the cultivable species of edible oyster & pearl oyster.
21. Name cultivable species of marine Aquaculture?
22. Name cultivable species of freshwater Aquaculture?
23. What are called pens?
24. Define mata-haline culture
25. Expand the following acronym.  
(a) CMFRI (b) MPEDA (c) CIBA (d) ICFA

### **Part III**

1. What is freshwater Aquaculture? and classify its types
2. Give an account of integrated fish culture?
3. Explain composite fish culture.
4. Give an account of bunds.
5. What are the characteristic features of location of a pond?
6. Explain the physio-chemical factors of a pond.
7. Give an account of bionomics of Catla-catla
8. Give an account of bionomics of Rohu.
9. Give an account of bionomics of the Tilapia mosambica.
10. What are the bionomics of freshwater prawn?
11. What are the salient features of Macrobrachium rosenbergii.
12. Give an account of fish diseases.
13. How do we setup an aquarium tank?